

**ADVANTEST**<sup>®</sup>

Spectrum Analyzers

# U3741/3751

Compact Design with High Performance

Pioneering 3 GHz/8 GHz Spectrum Analyzers are Now Available!



ADVANTEST

The U3741/3751 portable spectrum analyzer supports a great range of applications, from use on production lines to system installation and maintenance. Its digital IF enables dramatic improvements in power measurement accuracy for digitally modulated signals. Moreover, the U3741/3751 provides twice the throughput of its predecessor. A light and compact 3 GHz/8 GHz spectrum analyzer, the U3741/3751 provides basic performance reliably and at a low cost.

- Better measuring speed due to high-speed processing (twice as fast as its predecessor)
- Dramatically improved power measurement accuracy for digitally modulated signals
- Built-in 3 GHz/8 GHz pre-amp standard
- Average display noise level:
  - 155 dBm/Hz@1 GHz, pre-amp ON
- Tracking generator covering a frequency range of 100 kHz to 3 GHz/6 GHz
- Lightweight and compact design, with a maximum weight of only 5.6 kg
- Continuous operation of up to 2.5 hours with the battery pack



# *Compact, Quality, and*

## ***U3741/3751 Web Demonstration***

Please access to the <http://www.advantest.com> and click on the following links.

**PRODUCTS**

**Electronic Measuring Instruments**

**Spectrum Analyzer > U3751**

**WEB DEMO**

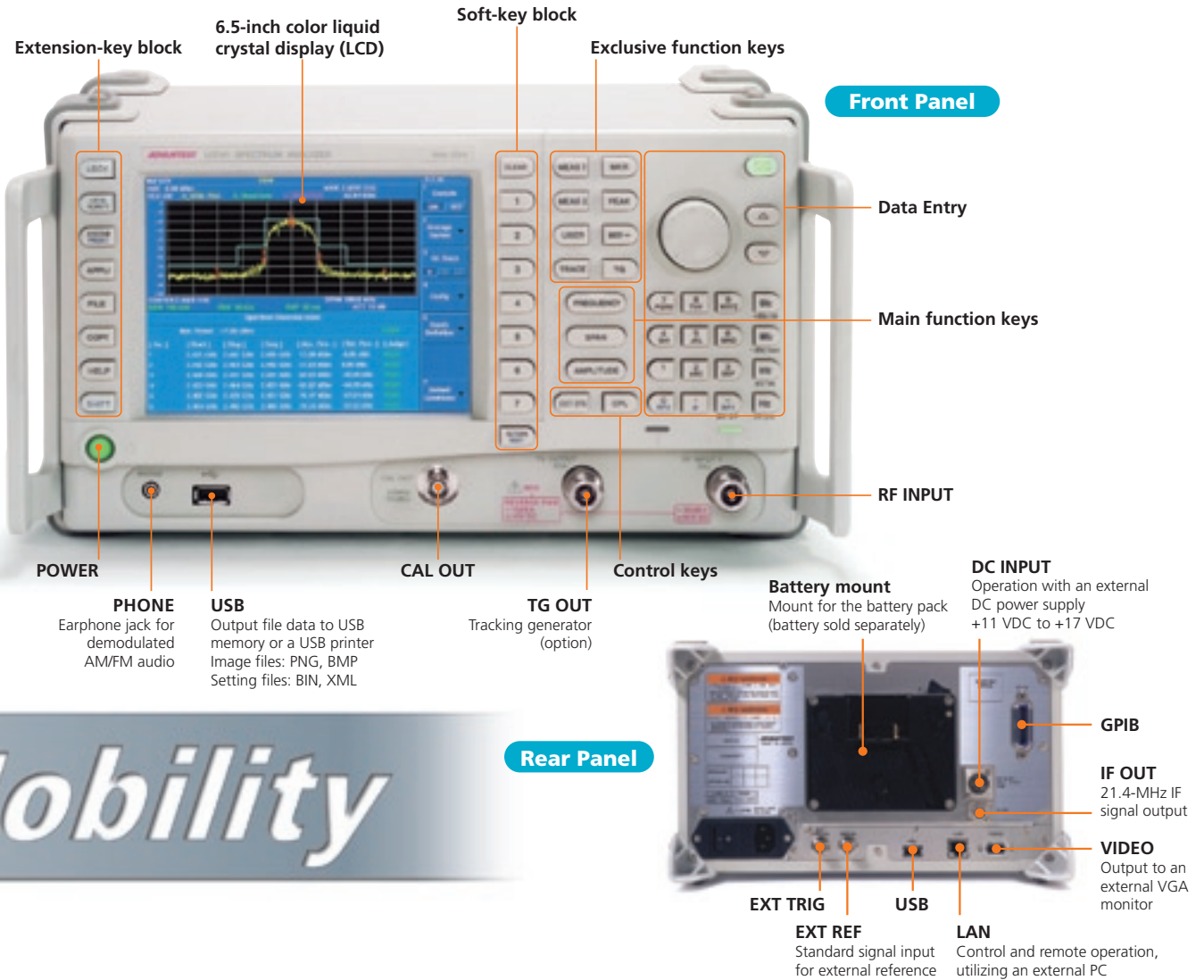

**Option Guide**

Product name	Model number	Overview	Main unit support			
			U3741		U3751	
			1ch	2ch	1ch	2ch
50 Ω series 1)	<b>2 Channel input (50 Ω)</b>	<b>OPT.10</b>	Addition of RF INPUT2 (9 kHz to 3 GHz) Individual RF measurement with RF INPUT 1 and RF INPUT 2			
	<b>EMC filter</b>	<b>OPT.28</b>	Addition of CISPR bandwidth for EMI measurement, and QP detector RBW (6 dB Down): 200 Hz, 9 kHz, 120 kHz, 1 MHz			
	<b>Tracking generator (3 GHz)</b>	<b>OPT.76</b>	Frequency range: 100 kHz to 3 GHz Output level range: 0 to -60 dBm			
	<b>Tracking generator (6 GHz)</b>	<b>OPT.77</b>	Frequency range: 100 kHz to 6 GHz Output level range: 0 to -30 dBm			
75 Ω series 1)	<b>2 Channel input (75 Ω)</b>	<b>OPT.11</b>	RF INPUT 2 (9 kHz to 2.2 GHz) in addition to OPT.15 Individual RF measurement with RF INPUT 1 and RF INPUT 2			
	<b>1 Channel input (75 Ω)</b>	<b>OPT.15</b>	RF INPUT: 75 Ω (100 kHz to 2.2 GHz) For CATV and TV picture signal measurement. Channel table data installed.			
	<b>Tracking generator (2.2 GHz)</b>	<b>OPT.75</b>	Frequency range: 100 kHz to 2.2 GHz. Output level range: 107 to 47 dBμV			
Commons	<b>High-stability frequency reference source</b>	<b>OPT.20</b>	Reference oscillator with an aging rate of ±2 x 10 <sup>-8</sup> /day, ±1 x 10 <sup>-7</sup> /year			
	<b>Time-domain analysis (1 ch/2 ch)</b>	<b>OPT.53/54</b>	Analyze the basic parameter of RF signal on a time domain (CBW: 3MHz) (amplitude/phase/frequency/FFT/IQ/IQ output)			
	<b>Wide-band time-domain analysis (1 ch/2 ch)</b>	<b>OPT.55/56</b>	Analyze the basic parameter of RF signal on a time domain (CBW: 40MHz) (amplitude/phase/frequency/FFT/IQ/IQ output)			

1) The options of 50 Ω series and 75 Ω series cannot be installed simultaneously. 2): One must be selected from OPT.76/77.

● Available  
 ✕ Not available

# Compact Design with High Performance

## 5-minute warm-up time

With the U3741/3751, warm-up time has been reduced to a scant 5 minutes (at an ambient temperature of 20 to 30°C). This shortened period virtually eliminates pre-warming time as a consideration, and permits quick and accurate measurement.

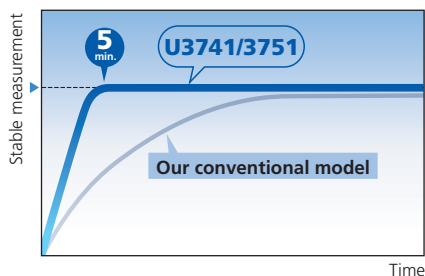

## High throughput

This spectrum analyzer delivers data transfer speed superior to that of its predecessor. While the previous model delivered 875 ms, the U3741/3751 boasts a speed of 350 ms: double the system throughput<sup>2</sup> (using the GPIB interface)<sup>3</sup>. This faster speed contributes to a significant reduction in cost of test on production lines and in similar applications.

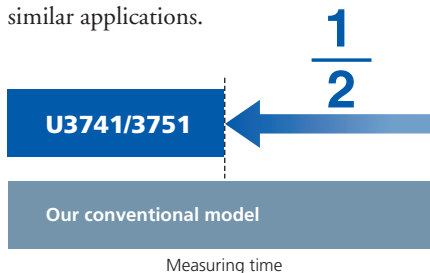

## Improvements in overall accuracy

Digitized IF sections and innovative circuit technology dramatically improve absolute power measurement accuracy.

±0.8 dB (10 MHz to 3 GHz: U3741/3751)

±1.0 dB (3 to 8 GHz: U3751)

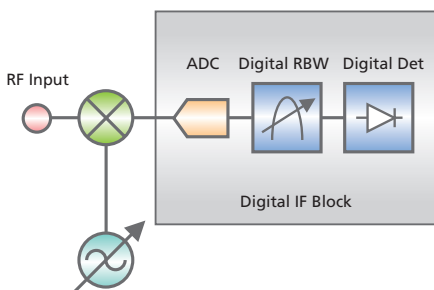

## Standard USB (1.1) interface

Screenshots in BMP or PNG format can easily be sent via USB external memory. Users can easily store data, and easily paste measurement data into reports.



## Up to 2.5 hours<sup>\*1</sup> of nonstop battery-driven operation

The spectrum analyzer uses one of three power systems: AC (100 V/200 V), DC (+11 V to +17 V), or the battery pack. This flexibility enables measurement in a variety of applications, whether in the factory or in the field.



## Compact design

At about half the size of its predecessor, this spectrum analyzer offers a compact design while maintaining the same level of functionality. Its form factor gives it portability, enabling it to be used anywhere.



\*1: Typical value at room temperature, without options

\*2: Twice that of its predecessor

\*3: Sample case where the frequency and span are specified, and the channel power measurement result is transferred

## Extensive array of measurement functions

Measurement functions include Channel Power, Total Power, Avg Power, OBW, ACP, Spurious measurement, Harmonics measurement, IM measurement, Noise/Hz calculation functions, multi-marker (10 markers), delta marker, peak marker functions, a channel setting function, and a 3-trace simultaneous sampling function.

# Measurement Functions

## RMS Average, essential for power measurement

Power tends to be spread over a wide frequency range, and the peak factor tends to be higher in digital modulation, with its expanded communication capacity. The U3741/3751 allows precise power measurements by determining the effective values (RMS values) from instantaneous power values obtained in high-speed sampling and translating them into a power spectrum. This method also enables measurement reproducibility of 0.01 dB in power measurement of digitally modulated signals.

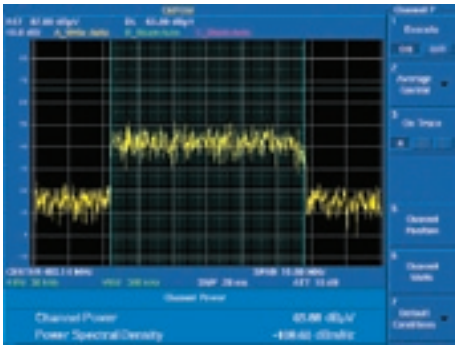

Example of ISDB-T Channel Power measurement

## Pre-Amp covering the 3 GHz/8 GHz bandwidth

The U3741/3751 contains as standard a pre-amp that covers all frequency bands. In the analysis of faint signals, its input sensitivity can be equivalent to that of high-end models. Also, it effectively compensates for the loss from the antenna when measuring radio signals in an outdoor environment.

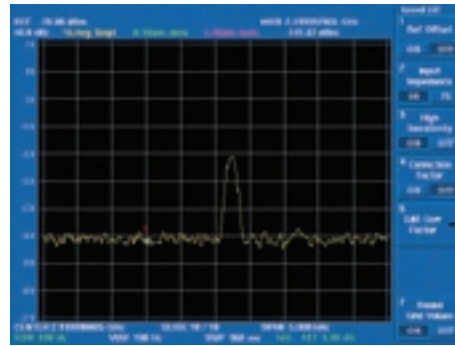

Example of high-sensitivity measurement in high-sensitivity mode

## Built-in frequency counter with 1-Hz resolution

Frequency can be accurately measured by simply positioning the cursor on the target spectrum selected from multiple spectral lines. The U3741/3751 is indispensable for measuring the carrier wave frequency in a general multi-carrier system.

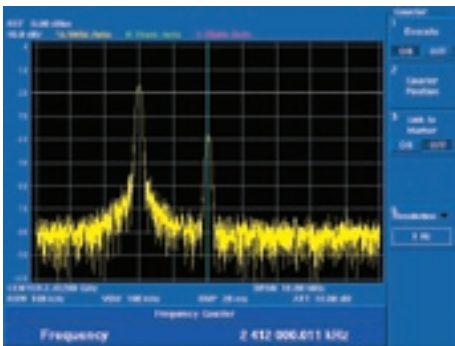

Example of multi-carrier signal frequency measurement

## USER keys

An arbitrary key can be selected from the hierarchical function keys and assigned to a USER function. Users can thus configure their own, original setup for operations by assigning frequently used functions to specific software keys.

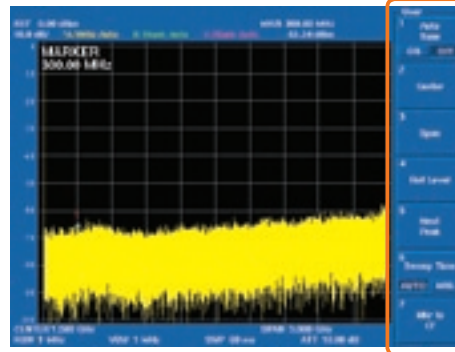

Example of user function assignment

## Zoom function

The measuring window and F-F mode can facilitate analysis of a specific signal in broadband measurement. Also, RBW can be changed independently, enabling high-speed measurement of the target signal in both broadband and narrowband. A variety of other signal analysis functions are also available, including those in F-T mode or T-T mode.

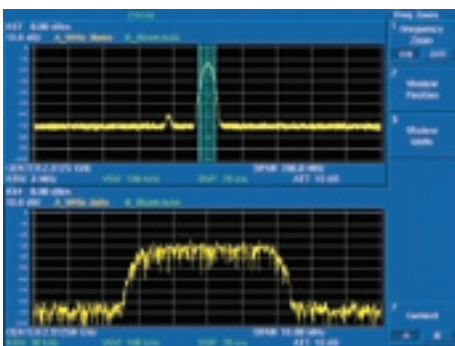

Example of two-screen sample from measurement in broadband and narrowband

## Spectrum emission mask function

Using tools such as a spectrum mask and limit line to judge PASS/FAIL is effective at improving production line throughput for digital appliances. Using the spectrum emission mask (SEM) function can facilitate measurement for standards such as wireless LAN.



Example of S.E.M. measurement for wireless LAN

# User-friendly and Convenient Functions

## Gated Sweep function

A radar or TDMA communication system controls its output transmission by turning the power on/off intermittently. To monitor the power spectrum during transmission, the Gated Sweep function is effective at analyzing the spectrum only when the signal is present and over only the area chosen. This function also includes an IF trigger that does not require synchronized signals.

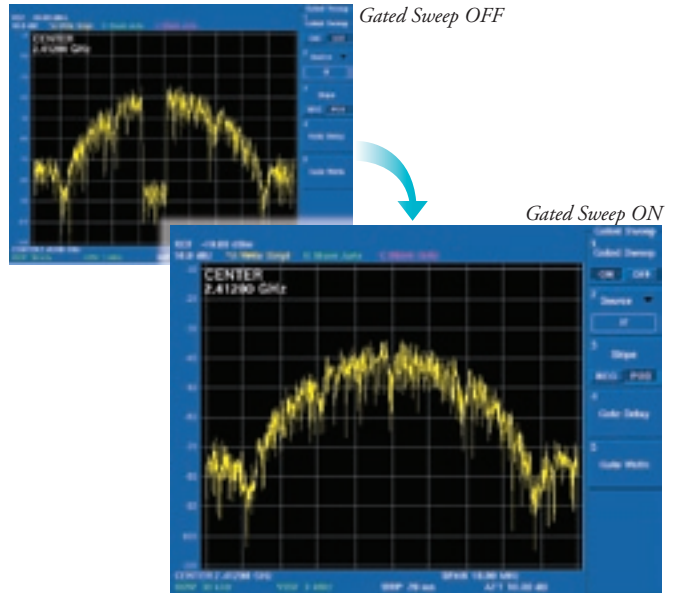
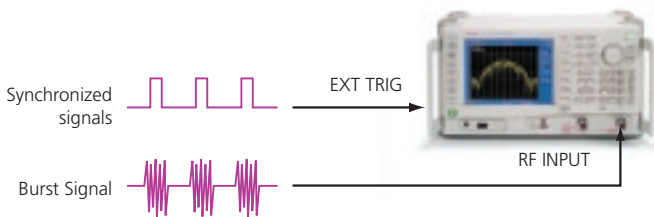

## Ideal for remote operation/monitoring via a LAN

This spectrum analyzer is equipped with a 10/100BASE-T LAN port as standard, so it can be operated remotely from an external PC. It can be installed in an unattended radio transmission station, and remotely operated and monitored from another station.

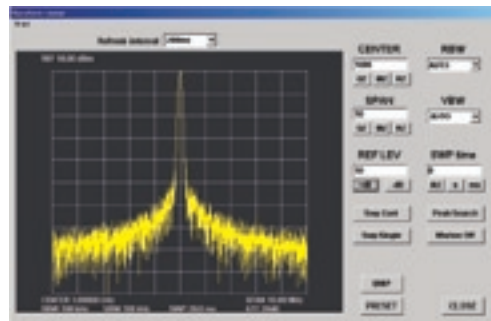
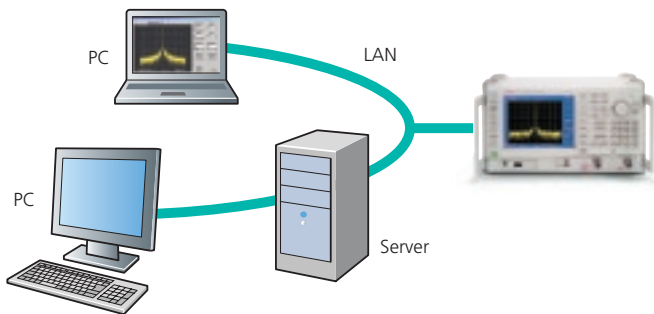

Screen of remote operation/monitoring from an external PC via LAN

## Searching for the location of a fault in a coaxial cable

When used with its tracking generator option and the sample software for an external PC, the U3741/3751 can measure the distance to the failure point (open/short) in a coaxial cable. This application permits this distance to be measured from one end of the coaxial cable.

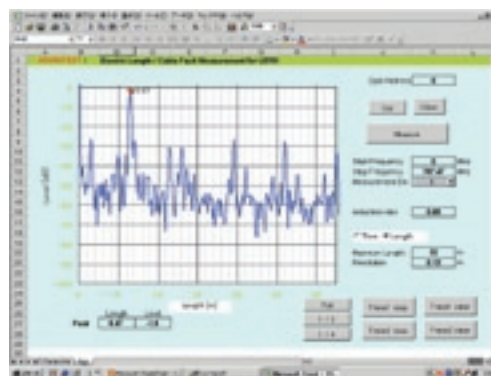
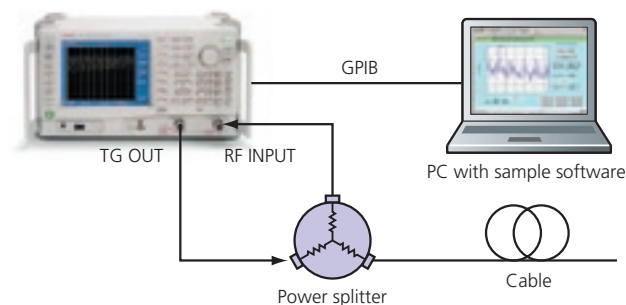

Screen for measuring the distance to a cable failure point

# Extensive Array of Options

## 2 Channel Input OPT.10 (50 Ω)/11 (75 Ω)

Two-channel input option (OPT.10/OPT.11) offers two independent lines of RF input. Various measurement conditions including measuring frequency and spans can be set independently for each RF input.

### High-speed process by the parallel processing

- Simultaneous measurement of standard items (Channel power and OBW, etc.)
- Reduction in time by two-piece simultaneous measurement
- Simultaneous measurement of the different system, etc.
- Simultaneous measurement of different frequency (1 GHz or less and micro-wave) etc. at EMC measurement

### Applications only possible for a two-channel spectrum analyzer

- Timing measurement between two channels by the synchronized sweep and synchronized trigger
- Simultaneous spectrum observation of the different frequency by the synchronized sweep when sweeping time is the same
- Simultaneous observation of the whole/part by the synchronized trigger
- Simultaneous monitoring of input/output devices

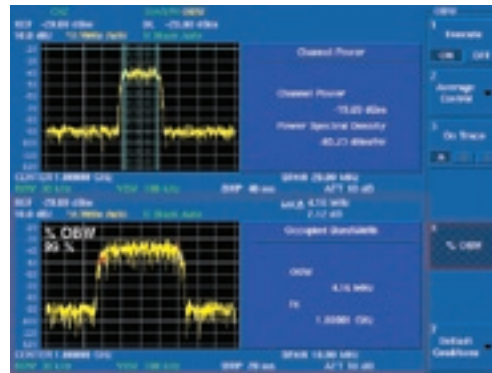

Simultaneous measurement of Channel Power and OBW

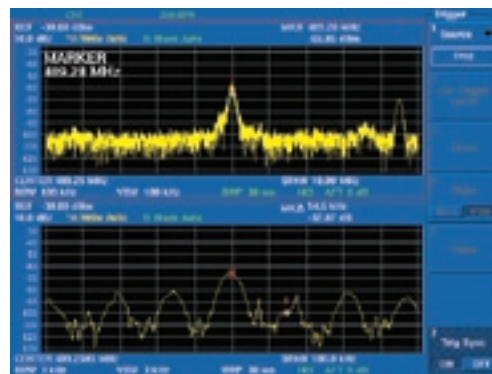

Simultaneous measurement of the broadband/narrowband by the synchronized sweep

### Allocating Connectors on Front Panel (for U3741)

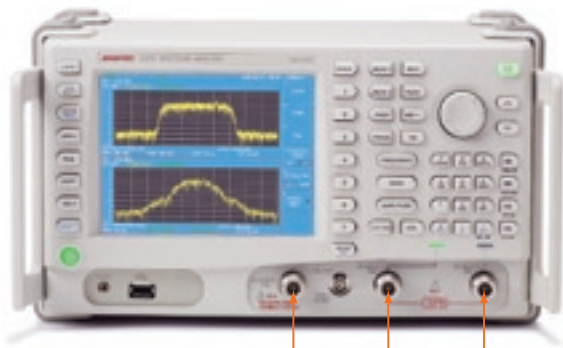

TG OUTPUT (OPT.76)  
RF INPUT 1 (standard equipment)  
RF INPUT 2 (OPT.10)

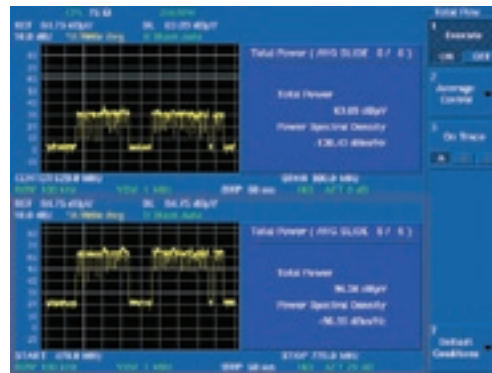

Simultaneous measurement of input/output for feed-forward amp

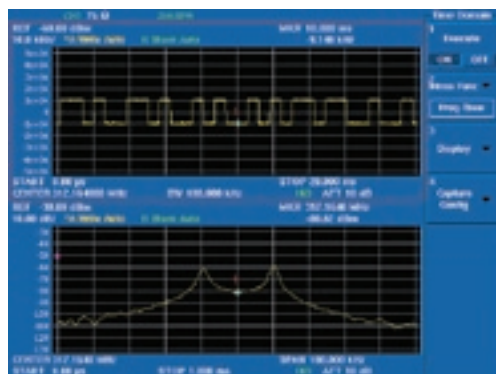

FSK signal measurement (required with OPT.54)

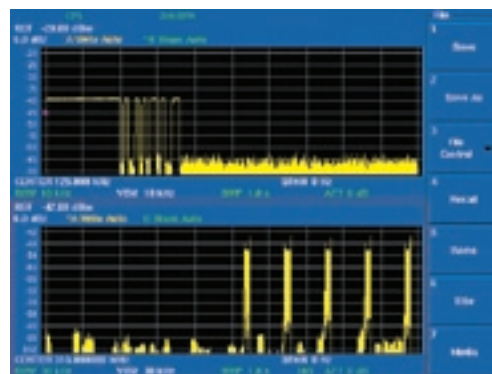

Timing measurement of TPMS by the synchronized trigger

# Extensive Array of Options

## Time-Domain Analysis OPT.53 (1 ch)/54 (2 ch)

### Wide-Band Time-Domain Analysis OPT.55 (1 ch)/56 (2 ch)

By installing this option in addition to the function of the conventional sweeping-type spectrum analyzer, a the time-domain analysis basic functions is added at low-cost.

#### Signal observation based on a domain different from sweeping-type spectrum analyzer

- Change in frequency over time by Freq. vs. Time analysis (ex. analysis of FSK signals, such as keyless entry and TPMS)
- Change in phase over time by Phase vs. Time analysis
- Change in power over time by Power vs. Time analysis
- High resolution (equivalent of 1 Hz RBW) high sensitivity measurement by FFT

#### Time-domain analysis for two signals (OPT.54/56)

The time-domain basic analysis function in the range of 9 kHz to 8 GHz (on main body) can be installed simultaneously for 2 channels. Unique analysis functions, such as Freq. vs Time during input and output are realized.

#### Wide-band time-domain analysis (OPT.55/56)

In the frequency ranges of 9 kHz to 8 GHz (on main body), time-domain analysis for up to the maximum measurement bandwidth 40 MHz is possible.

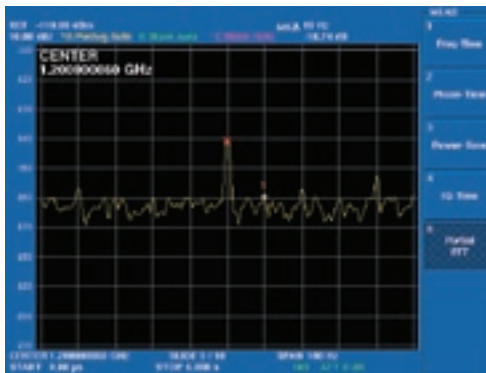

High sensitivity measurement by FFT (RBW 1Hz, -160dBm/Hz (typ))



FREQ. vs. Time measurement of the 4 value FSK

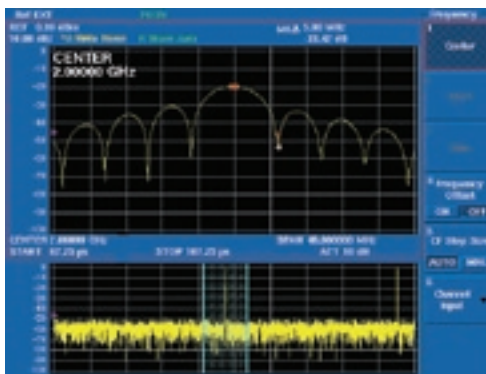

Radar wave measurement (OPT.55 for Wide-band time-domain analysis)

#### Measurement using the time-domain basic analysis function

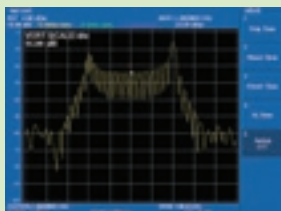

FFT Spectrum



Freq. vs. Time



Power vs. Time

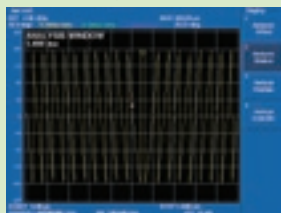

Phase vs. Time

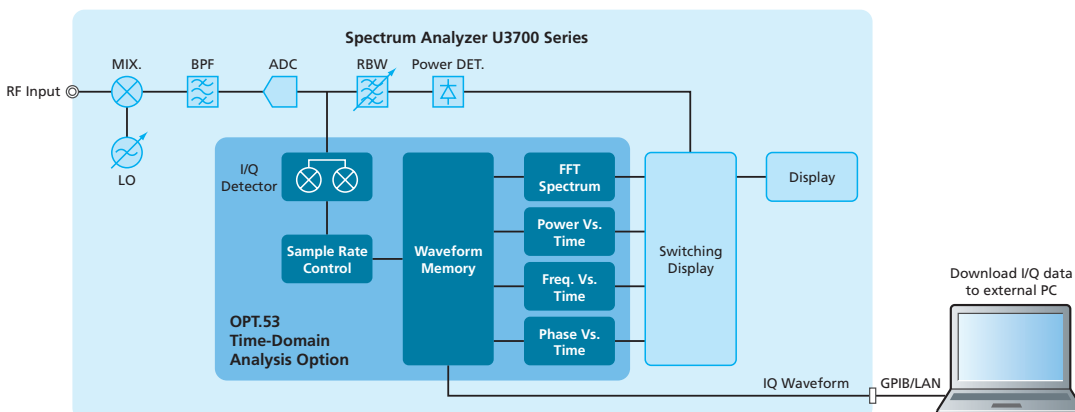



# Extensive Array of Options

## Tracking Generator OPT.75/76/77

Generates synchronized signals for frequency sweeps by the spectrum analyzer.

- OPT.75** Output impedance: 75  $\Omega$   
Output frequency range: 100 kHz to 2.2 GHz

- OPT.76** Output impedance: 50  $\Omega$   
Output frequency range: 100 kHz to 3 GHz
- OPT.77** Output impedance: 50  $\Omega$   
Output frequency range: 100 kHz to 6 GHz

### Functions for evaluating frequency characteristics

The normalize function enables direct measurement of cable loss and filter characteristics. The frequency offset function of the tracking generator enables measurement of frequency characteristics and conversion loss characteristics of mixers and other frequency conversion devices.

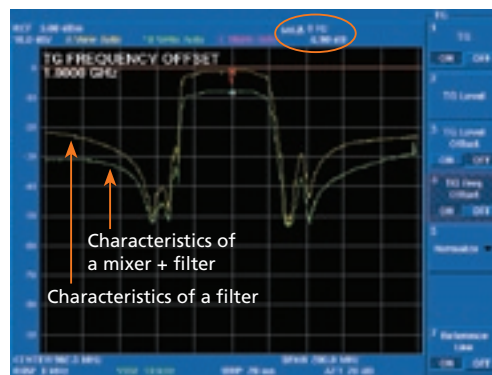
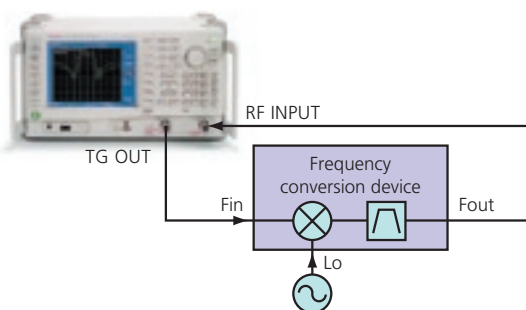

Measurement of mixer frequency conversion loss characteristics

### Function for return loss measurement

The SWR bridge can be used to measure reflection characteristics of an antenna or filter. It can determine the return loss and evaluate the VSWR.

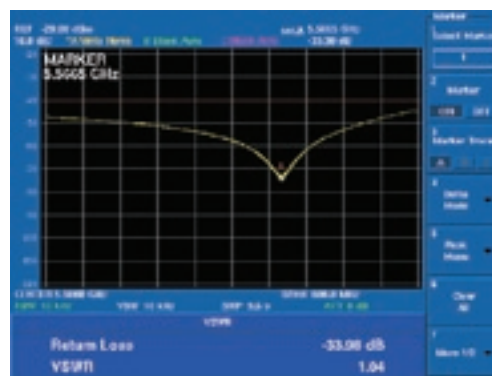
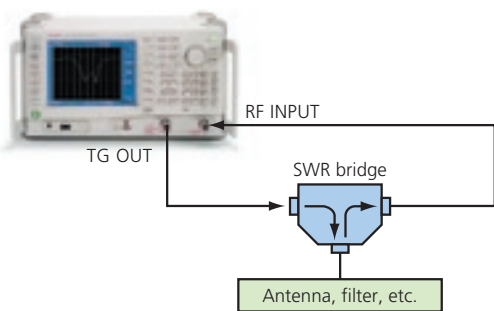

Filter return loss measurement

# Extensive Array of Options and Accessories

## High-Stability Frequency Reference Source OPT.20

Frequency of the high frequency signal was conventionally counted with a frequency counter. However, multi-carrier method is often employed for the recent communication system which uses high frequency signals which contains multiple frequency components, a frequency counter cannot count the frequency correctly. Therefore, the frequency counter of the spectrum analyzer attracts attention as an essential function.

In a spectrum analyzer, just by pointing the marker at the spectrum separated as a sine wave of CW, not only the frequency counting but also faint signal level counting is possible. OPT.20 improves the aging stability of the standard oscillator which determines the frequency counter accuracy of a spectrum analyzer.

	Aging rate
Standard	$\pm 2 \times 10^{-6}$ /year
OPT.20	$\pm 2 \times 10^{-8}$ /day, $\pm 1 \times 10^{-7}$ /year

## EMC Filter OPT.28

Option 28 adds 6 dB RBW CISPR bandwidths for EMI measurement of 200 Hz, 9 kHz, 120 kHz, and 1 MHz. A broadband sweep by the spectrum analyzer is very effective at measuring noise emitted from electrical devices. Installing OPT.28 allows measurement in CISPR-specified bandwidths. It enables simple, fast measurement using the Positive peak detector and Max Hold, which makes it effective at compensating for emitted noise. It guarantees an impulse bandwidth accuracy of 1 MHz. This capability conforms to the standard for noise measurement of 1 GHz or above.

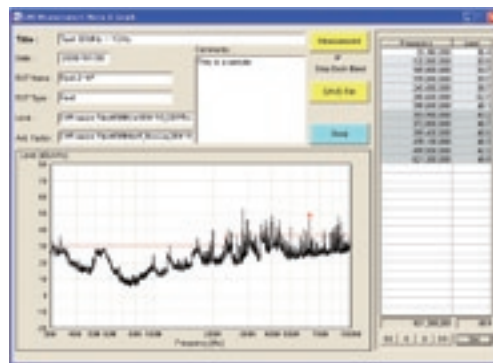

Measurement using EMI sample software

## Accessories

Many accessories are available, including an easy-to-carry transit case and a battery pack, useful for field work.



## Specifications

### Frequency

Frequency range	
U3741:	9 kHz to 3 GHz, 9 kHz to 2.2 GHz (with the OPT.15 installed)
Pre-Amp:	10 MHz to 3 GHz, 10 MHz to 2.2 GHz (with the OPT.15 installed)
Synchronizable frequency range:	9 kHz to 3 GHz
U3751:	9 kHz to 8 GHz
Frequency band:	9 kHz to 3.1 GHz (band 0), 3 GHz to 8 GHz (band 1)
Pre-Amp:	10 MHz to 8 GHz
Frequency reading accuracy:	± (marker read value x frequency reference accuracy + span x span accuracy + residual FM)
Frequency reference stability	
Aging rate:	±2 x 10 <sup>-6</sup> /year
Temperature stability:	±2.5 x 10 <sup>-6</sup> (0 to 50°C)
Frequency counter:	Resolution bandwidth ≤100 kHz, span ≤100 MHz, signal level: S/N >50 dB
Resolution:	1 Hz to 1 kHz
Accuracy:	± (counter read value x frequency reference accuracy + residual FM + 1 LSB)
Frequency stability	
Residual FM (zero/span):	< 60 Hzp-p/100 ms (internal frequency reference)
Frequency span	
Range:	5 kHz to Full, zero span 1 kHz to Full, zero span (with the OPT.70 installed)
Accuracy:	< ±1%
Spectrum purity:	-85 dBc/Hz (offset 10 kHz, span < 200 kHz)
Resolution bandwidth	
Range:	
U3741:	100 Hz to 1 MHz (1 to 3 steps)
U3751:	100 Hz to 3 MHz (1 to 3 steps)
Accuracy:	< ±12%
Video bandwidth range:	10 Hz to 3 MHz (1 to 3 steps)
Sweep	
Sweep time	
Setting range:	20 ms to 1000 s (spectrum mode) 50 μs to 1000 s (zero span)
Accuracy:	< ±2% (zero span)
Sweep mode:	Continuous, single, gated
Trigger function	
Trigger source:	Free run, video, external, IF

### Amplitude range

Measurement range:	Displayed average noise level to +30 dBm Displayed average noise level to 134 dBμV (with the OPT.15 installed)
Maximum safe input level:	Attenuator ≥ 10 dB
Pre-Amp OFF:	+30 dBm, 134 dBμV (with the OPT.15 installed)
Pre-Amp ON:	+13 dBm, 120 dBμV (with the OPT.15 installed)
U3741:	±50 VDC max.
U3751:	±15 VDC max.
Input attenuator range:	0 to 50 dB (10 dB steps)
Display range:	100/50/20/10/5 dB, linear
Scale unit:	dBm, dBmV, dBμV, dBμVemf, dBpW, W, V
Reference level setting range:	-140 to +40 dBm -31.2 to 148.8 dBμV (with the OPT.15 installed)
Detection mode:	Normal, Positive peak, Negative peak, Sample, RMS, and Average

### Amplitude accuracy

Calibration signal	
Frequency:	20 MHz
Level:	-20 dBm (75 Ω, with the OPT.15 installed)
Accuracy:	±0.3 dB, ±0.4 dB (with the OPT.15 installed)
Scale display accuracy	
Log:	±0.5 dB/10 dB, ±0.5 dB/80 dB, ±0.2 dB/1 dB
Overall amplitude accuracy:	After calibration, with the pre-amp OFF, and at a temperature ranging from 20 to 30°C Input attenuator 10 dB Reference level 0 dBm, input signal level -10 to -50 dBm ±1.0 dB (9 kHz to 3 GHz) ±0.8 dB (10 MHz to 3 GHz)
U3741:	With the OPT.15 installed: Reference level 108.8 dBμV Input signal level 98.8 to 58.8 dBμV ±2.1 dB (9 kHz to 2.2 GHz) ±0.9 dB (10 MHz to 2.2 GHz)
U3751:	Reference level 0 dBm, input signal level -10 to -50 dBm Image suppression OFF ±1.5 dB (9 kHz to 10 MHz) ±0.8 dB (10 MHz to 3.1 GHz) ±1.0 dB (3.1 GHz to 8 GHz)

## Dynamic range

Displayed average noise level:	Reference level < -45 dBm (63.8 dB $\mu$ V, with the OPT.15 installed) Resolution bandwidth 100 Hz
U3741:	Frequency 10 MHz to 3 GHz
Pre-Amp OFF:	-123 dBm + 2f (GHz) dB (f < 2.5 GHz) -123 dBm + 2.5f (GHz) dB (f $\geq$ 2.5 GHz) -12 dB $\mu$ V + 2f (GHz) dB (f $\leq$ 2.2 GHz, with the OPT.15 installed)
Pre-Amp ON:	-138 dBm + 3f (GHz) dB -27 dB $\mu$ V + 3f (GHz) dB (with the OPT.15 installed)
U3751:	Frequency 10 MHz to 8 GHz
Pre-Amp OFF:	-123 dBm + 2f (GHz) dB (f $\leq$ 3.1 GHz, band 0) -122 dBm + 1f (GHz) dB (f $\geq$ 3 GHz, band 1)
Pre-Amp ON:	-138 dBm + 3f (GHz) dB (f $\leq$ 3.1 GHz, band 0) -139 dBm + 1.3f (GHz) dB (f $\geq$ 3 GHz, band 1)
<b>1 dB gain compression</b>	
U3741:	Frequency > 20 MHz
Pre-Amp OFF:	> -5 dBm > 102 dB $\mu$ V (with the OPT.15 installed)
Pre-Amp ON:	> -25 dBm > 82 dB $\mu$ V (with the OPT.15 installed)
U3751:	Frequency > 20 MHz
Pre-Amp OFF:	> -8 dBm
Pre-Amp ON:	> -25 dBm
<b>Second harmonic distortion</b>	
U3741:	< -70 dBc (Pre-Amp OFF, Frequency > 20 MHz, Mixer input level -30 dBm (77 dB $\mu$ V, with the OPT.15 installed))
U3751:	< -70 dBc (Pre-Amp OFF, Frequency > 200 MHz, Mixer input level -40 dBm) < -75 dBc (typ., Pre-Amp OFF, Frequency > 300 MHz, Mixer input level -30 dBm)
<b>Third order intermodulation distortion</b>	
U3741:	< -60dBc (Pre-Amp OFF, Mixer input level -20 dBm (88.8 dB $\mu$ V, with the OPT.15 installed), Frequency > 10 MHz, 2 signal separation > 200 kHz)
U3751:	< -50 dBc (Pre-Amp OFF, Mixer input level -20 dBm, Frequency 10 MHz to 8 GHz, 2 signal separation > 200 kHz)
<b>Image/multiple/out of band response</b>	
U3741:	< -60 dBc (Mixer input level -20 dBm (88.8 dB $\mu$ V, with the OPT.15 installed))
U3751:	< -60 dBc (Mixer input level -30 dBm, Image suppression ON)
<b>Residual response</b>	
U3741:	< -90 dBm (Frequency > 1 MHz, Pre-Amp OFF) < 21 dB $\mu$ V (with the OPT.15 installed)
U3751:	< -80 dBm (Frequency 10 MHz to 8 GHz, Pre-Amp OFF)

## Inputs/outputs

<b>RF input</b>	
Connector:	N-type female
Impedance:	50 $\Omega$ (nominal) 75 $\Omega$ (nominal, with the OPT.15 installed)
VSWR:	Input attenuator $\geq$ 10 dB
U3741:	< 1.5 : 1 < 1.6 : 1 (with the OPT.15 installed)
U3751:	< 1.7 : 1 (10 MHz $\leq$ Frequency $\leq$ 3.0 GHz) < 2.0 : 1 (Frequency > 3.0 GHz)
<b>Calibration signal output</b>	
Connector:	BNC female
Impedance:	50 $\Omega$ (nominal) 75 $\Omega$ (nominal, with the OPT.15 installed)
Frequency:	20 MHz
Level:	-20 dBm
<b>Frequency reference input</b>	
Connector:	BNC female
Impedance:	50 $\Omega$ (nominal)
Frequency (MHz):	1, 1.544, 2.048, 5, 10, 12.8, 13, 13.824, 14.4, 15.36, 15.4, 16.8, 19.2, 19.44, 19.6608, 19.68, 19.8, 20, 26
Level:	0 to +16 dBm
<b>External trigger input</b>	
Connector:	BNC female
Impedance:	10 k $\Omega$ (nominal), DC coupling
Level:	0 to +5 V
<b>21.4-MHz IF output</b>	
Connector:	BNC female
Impedance:	50 $\Omega$ (nominal)
Level:	Approx. mixer input level + 10 dB (at a frequency of 20 MHz)
<b>Battery mount</b>	
Connector:	AntonBauer QR mount
<b>External DC power input</b>	
Connector:	XLR-4
Voltage range:	+11 to +17 V
GPIO:	IEEE-488 bus connector
USB:	USB 1.1
Video output connector:	D-sub15 pin female
LAN connector:	RJ45 type, 10/100 base-T
Audio output:	Small monophonic jack
<b>General specifications</b>	
Operating environment range:	Ambient temperature: 0 to + 50°C Humidity: RH 85% or less (no condensation)
Storage environment range:	-20 to +60°C, RH 85% or less
AC power input:	Automatic switching to 100 VAC or 200 VAC 100 V: 100 to 120 V, 50/60 Hz 200 V: 220 to 240 V, 50/60 Hz
DC power input:	DC + 11 V to +17 V
Power consumption:	100 VA or less (AC operation) 70 W or less (DC operation)
<b>Mass</b>	
U3741:	5 kg or less (without option)
U3751:	5.6 kg or less (without option)
<b>External dimensions (W x H x D):</b>	
	Approx. 308 x 175 x 209 mm (not including protruding parts) Approx. 337 x 190 x 307 mm (including the handle and feet)

### OPT.10 2 Channel input (50 Ω, 3 GHz)

Cross talk between input channels (between RF input 1 and RF input 2):

<-90 dBc (Input level -10 dBm, Input attenuator 0 dB, Preamplifier off)

RF input 2

Connector: N type female  
Impedance: 50 Ω (nominal)  
VSWR: <1.5 : 1 (Input attenuator > 10 dB)  
External trigger input: An external trigger input can be selected as a trigger input of RF input 2 when installing the OPT.10. The input connector is only 1 system.

21.4 MHz IF output: Only IF output which supports RF input 1, when installing the OPT.10.

*Except for all items mentioned above, the frequency, sweep, amplitude range, amplitude accuracy, dynamic range, input/output, and performance of specifications follow the standard specifications of the RF input 1 option of the U3741 spectrum analyzer.*

### OPT.11 2 Channel input (75 Ω, 2.2 GHz)

Cross talk between input channels (between RF input 1 and RF input 2):

<-90 dBc (Input level 98.8 dBμV, Input attenuator 0 dB, Preamplifier off)

RF input 2

Connector: N type female  
Impedance: 75 Ω (nominal)  
VSWR: <1.5 : 1 (Input attenuator > 10 dB)  
External trigger input: An external trigger input can be selected as a trigger input of RF input 2 when installing the OPT.11. The input connector is only 1 system.

21.4 MHz IF output: Only IF output which supports RF input 1, when installing the OPT.11.

*Except for all items mentioned above, the frequency, sweep, amplitude range, amplitude accuracy, dynamic range, input/output, and performance of specifications follow the standard specifications of the RF input 1 option of the U3741 + OPT.15 spectrum analyzer.*

### OPT.20 High-stability frequency reference source

Frequency reference stability

Aging rate:  $\pm 2 \times 10^{-8}$ /day  
 $\pm 1 \times 10^{-7}$ /year  
Warm-up drift:  $\pm 5 \times 10^{-8}$  (+25°C, 10 minutes after power-on)  
Temperature stability:  $\pm 5 \times 10^{-8}$  (0 to +40°C, with reference to 25°C)

### OPT.28 EMC filter

6 dB bandwidth: 200 Hz, 9 kHz, 120 kHz, 1 MHz  
Bandwidth accuracy: < ±10%

### OPT.53/54 Time-domain analysis (1 ch/2 ch)

RF range: Follows the U3741/3751.  
RF amplitude range: Noise level to +30 dBm<sup>\*1)</sup>  
Wave recording method: I/Q vector time waveform  
Measuring bandwidth (CBW): 100 Hz to 3 MHz (1 to 3 steps)  
IQ sampling rate: 713 Hz (BW 100 Hz) to 21.4 MHz (BW 3 MHz)  
IQ waveform recording time: 49 msec (BW 3 MHz) to 1000 sec (BW 100 Hz)  
Number of IQ waveform recording samples: 1 M samples (I/Q)

\*1) The noise level follows the dynamic range of the U3741/3751.

### OPT.55/56 Wide-band time-domain analysis (1 ch/2 ch)

RF range: Follows the U3741/3751.  
RF amplitude range: Noise level to +30 dBm<sup>\*1)</sup>  
Wave recording method: I/Q vector time waveform  
Measuring bandwidth (CBW): 100 Hz to 30 MHz (1 to 3 steps), 40 MHz  
IQ sampling rate: 500 Hz (BW 100 Hz) to 65 MHz (BW 40 MHz)  
IQ waveform recording time: 120 msec (BW 40 MHz) to 1000 sec (BW 100 Hz)  
Number of IQ waveform recording samples: 8 M samples (I/Q)

\*1) The noise level follows the dynamic range of the U3741/3751.

**OPT.75 Tracking generator (75 Ω, 2.2 GHz)**

Frequency range:	100 kHz to 2.2 GHz
Frequency offset	
Range:	0 Hz to 1 GHz
Accuracy:	±300 Hz
Resolution:	1 kHz
Output level range:	107 to 47 dBμV (0.5 dB steps)
Output level accuracy:	±0.5 dB (20 MHz, 97 dBμV, +20 to +30°C)
Output level flatness:	Using 20 MHz and 97 dBμV as a reference ±1.0 dB (1 MHz to 1 GHz) ±1.5 dB (100 kHz to 2.2 GHz)
Output level switch error:	Using 20 MHz and 97 dBμV as a reference ±1.0 dB (1 MHz to 1 GHz, 107 to 47 dBμV) ±2.0 dB (1 MHz to 2.2 GHz, 107 to 47 dBμV) ±3.0 dB (100 kHz to 2.2 GHz, 107 to 77 dBμV) ±4.0 dB (100 kHz to 2.2 GHz, 76.5 to 47 dBμV) ±5.0 dB (100 kHz to 2.2 GHz)
Frequency offset OFF:	±3.0 dB (100 kHz to 2.2 GHz, 107 to 77 dBμV) ±4.0 dB (100 kHz to 2.2 GHz, 76.5 to 47 dBμV) ±5.0 dB (100 kHz to 2.2 GHz)
Frequency offset ON:	
Output spurious:	Output level 97 dBμV
Harmonic:	< -15 dBc (100 kHz to 1 MHz) < -20 dBc (1 MHz to 2.2 GHz)
Non-harmonic:	< -20 dBc (Frequency offset OFF)
TG leakage:	< 31 dBμV (Input attenuator 0 dB)
Output impedance:	75 Ω (nominal)
VSWR:	≤ 2.0 : 1 (Output level ≤ 97 dBμV)
Maximum allowable level:	117 dBμV, ±10 VDC

**OPT.76 Tracking generator (50 Ω, 3 GHz)**

Frequency range:	100 kHz to 3 GHz
Frequency offset	
Range:	0 Hz to 1 GHz
Accuracy:	±300 Hz
Resolution:	1 kHz
Output level range:	0 to -60 dBm (0.5 dB steps)
Output level accuracy:	±0.5 dB (20 MHz, -10 dBm, +20 to +30°C)
Output level flatness:	Using 20 MHz and -10 dBm as a reference ±1.0 dB (1 MHz to 1 GHz) ±1.5 dB (100 kHz to 3 GHz)
Output level switch error:	Using 20 MHz and -10 dBm as a reference ±1.0 dB (1 MHz to 1 GHz, 0 to -60 dBm) ±2.0 dB (1 MHz to 2.6 GHz, 0 to -60 dBm) ±3.0 dB (100 kHz to 3 GHz, 0 to -30 dBm) ±4.0 dB (100 kHz to 3 GHz, -30.5 to -60 dBm) ±5.0 dB (100 kHz to 3 GHz)
Frequency offset OFF:	±3.0 dB (100 kHz to 3 GHz, 0 to -30 dBm) ±4.0 dB (100 kHz to 3 GHz, -30.5 to -60 dBm) ±5.0 dB (100 kHz to 3 GHz)
Frequency offset ON:	
Output spurious:	Output level -10 dBm
Harmonic:	< -15 dBc (100 kHz to 1 MHz) < -20 dBc (1 MHz to 3 GHz)
Non-harmonic:	< -20 dBc (Frequency offset OFF)
TG leakage:	< -80 dBm (Input attenuator 0 dB)
Output impedance:	50 Ω (nominal)
VSWR:	≤ 2.0 : 1 (Output level ≤ -10 dBm)
Maximum allowable level:	+10 dBm, ±10 VDC

**OPT.77 Tracking generator (50 Ω, 6 GHz) \*2)**

Frequency range:	100 kHz to 6 GHz
Output level range:	0 to -30 dBm (0.5 dB step)
Output level accuracy:	≤ ±0.5 dB (20 MHz, -10 dBm, +20 to +30°C)
Output level flatness:	20 MHz on -10 dBm criterion, at +20 to +30°C ≤ ±1 dB (1 MHz to 1 GHz) ≤ ±1.5 dB (100 kHz to 3.1 GHz) ≤ ±2.0 dB (100 kHz to 6 GHz)
TG leakage:	≤ -80 dBm (input attenuator: 0 dB)
Output impedance:	50 Ω (nominal)
VSWR:	≤ 2.0 : 1 (Output level ≤ -10 dBm)
Maximum allowable level:	+10 dBm, ±10 VDC

\*2) The OPT.77 is not allowed to be installed on the U3741.

**Ordering information**

<b>Main unit</b>	
Spectrum analyzer:	U3741 U3751
<b>Accessories</b>	
Operating manual (CD):	BU37005
Power cable:	A01412
Input cable:	A01037-0300
With the OPT.15 installed:	A01045
N-BNC adapter:	JUG-201A/U
With the OPT.15 installed:	BA-A165
NC-F adapter (with the OPT.15 installed):	NCP-NFJ
Ferrite core:	ESD-SR-120, E04SR150718

<b>Options</b>	
2 Channel input (50 Ω, 3 GHz):	OPT.10
2 Channel input (75 Ω, 2.2 GHz):	OPT.11
1 Channel input (75 Ω):	OPT.15
High-stability frequency reference source:	OPT.20
EMC filter:	OPT.28
Time-domain analysis (1 ch):	OPT.53
Time-domain analysis (2 ch):	OPT.54
Wide-band time-domain analysis (1 ch):	OPT.55
Wide-band time-domain analysis (2 ch):	OPT.56
Tracking generator (75 Ω, 2.2 GHz):	OPT.75
Tracking generator (50 Ω, 3 GHz):	OPT.76
Tracking generator (50 Ω, 6 GHz):	OPT.77

<b>Accessories</b>	
Japanese operating manual (printed manual):	JU37005
English operating manual (printed manual):	EU37005
75 Ω input impedance converter:	ZT-130NC
DC power cable:	A114020
Transit case:	A129002
Rack mount kit (JIS):	A122003
Rack mount kit (EIA):	A124004

Note on accessories:

The operating manual on the CD is supplied as standard.

The printed version of the operating manual is offered as an accessory.

## Sample software

to be downloaded free from homepage

ADVANTEST provides various kinds of sample software shown below :

- Useful sample software for EMI measurement and Radio waves monitor, etc.
- Module software with source code to control a Spectrum analyzer for developers.

<http://www.advantest.com>

PRODUCTS

Electronic Measuring Instruments

U3741 or U3751

Sample Software

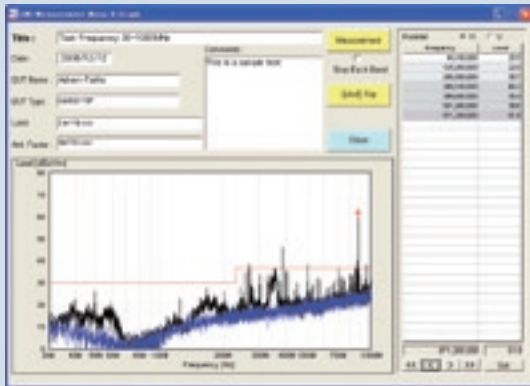

EMI measurement software (2 ch)

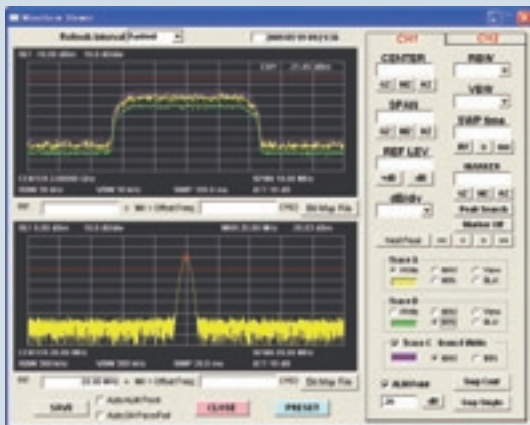

Radio waves monitor (1 ch/2ch)

Please refer to product manual for complete system specifications.  
Specifications may change without notification.

**ADVANTEST**<sup>®</sup>

<http://www.advantest.com>

---

ADVANTEST CORPORATION  
Shin-Marunouchi Center Building, 1-6-2 Marunouchi, Chiyoda-ku, Tokyo 100-0005, Japan Phone: +81-3-3214-7500