

---

**ADVANTEST®**  
ADVANTEST CORPORATION

---

***D3186***

***Pulse Pattern Generator***

***Operation Manual***

MANUAL NUMBER FOE-8324231H00

---



---

## Safety Summary

To ensure thorough understanding of all functions and to ensure efficient use of this instrument, please read the manual carefully before using. Note that Advantest bears absolutely no responsibility for the result of operations caused due to incorrect or inappropriate use of this instrument.

If the equipment is used in a manner not specified by Advantest, the protection provided by the equipment may be impaired.

- **Warning Labels**

Warning labels are applied to Advantest products in locations where specific dangers exist. Pay careful attention to these labels during handling. Do not remove or tear these labels. If you have any questions regarding warning labels, please ask your nearest Advantest dealer. Our address and phone number are listed at the end of this manual.

Symbols of those warning labels are shown below together with their meaning.

**DANGER:** Indicates an imminently hazardous situation which will result in death or serious personal injury.

**WARNING:** Indicates a potentially hazardous situation which will result in death or serious personal injury.

**CAUTION:** Indicates a potentially hazardous situation which will result in personal injury or a damage to property including the product.

- **Basic Precautions**

Please observe the following precautions to prevent fire, burn, electric shock, and personal injury.

- Use a power cable rated for the voltage in question. Be sure however to use a power cable conforming to safety standards of your nation when using a product overseas.
- When inserting the plug into the electrical outlet, first turn the power switch OFF and then insert the plug as far as it will go.
- When removing the plug from the electrical outlet, first turn the power switch OFF and then pull it out by gripping the plug. Do not pull on the power cable itself. Make sure your hands are dry at this time.
- Before turning on the power, be sure to check that the supply voltage matches the voltage requirements of the instrument.
- Connect the power cable to a power outlet that is connected to a protected ground terminal. Grounding will be defeated if you use an extension cord which does not include a protected ground terminal.
- Be sure to use fuses rated for the voltage in question.
- Do not use this instrument with the case open.
- Do not place anything on the product and do not apply excessive pressure to the product. Also, do not place flower pots or other containers containing liquid such as chemicals near this

---

## Safety Summary

product.

- When the product has ventilation outlets, do not stick or drop metal or easily flammable objects into the ventilation outlets.
- When using the product on a cart, fix it with belts to avoid its drop.
- When connecting the product to peripheral equipment, turn the power off.

- **Caution Symbols Used Within this Manual**

Symbols indicating items requiring caution which are used in this manual are shown below together with their meaning.

**DANGER:** Indicates an item where there is a danger of serious personal injury (death or serious injury).

**WARNING:** Indicates an item relating to personal safety or health.

**CAUTION:** Indicates an item relating to possible damage to the product or instrument or relating to a restriction on operation.

- **Safety Marks on the Product**

The following safety marks can be found on Advantest products.



: ATTENTION - Refer to manual.



: Protective ground (earth) terminal.



: DANGER - High voltage.



: CAUTION - Risk of electric shock.

- **Replacing Parts with Limited Life**

The following parts used in the instrument are main parts with limited life.

Replace the parts listed below before their expected lifespan has expired to maintain the performance and function of the instrument.

Note that the estimated lifespan for the parts listed below may be shortened by factors such as the environment where the instrument is stored or used, and how often the instrument is used.

The parts inside are not user-replaceable. For a part replacement, please contact the Advantest sales office for servicing.

Each product may use parts with limited life.

For more information, refer to the section in this document where the parts with limited life are described.

## Main Parts with Limited Life

Part name	Life
Unit power supply	5 years
Fan motor	5 years
Electrolytic capacitor	5 years
LCD display	6 years
LCD backlight	2.5 years
Floppy disk drive	5 years
Memory backup battery	5 years

- **Hard Disk Mounted Products**

The operational warnings are listed below.

- Do not move, shock and vibrate the product while the power is turned on.  
Reading or writing data in the hard disk unit is performed with the memory disk turning at a high speed. It is a very delicate process.
- Store and operate the products under the following environmental conditions.  
An area with no sudden temperature changes.  
An area away from shock or vibrations.  
An area free from moisture, dirt, or dust.  
An area away from magnets or an instrument which generates a magnetic field.
- Make back-ups of important data.  
The data stored in the disk may become damaged if the product is mishandled. The hard disc has a limited life span which depends on the operational conditions. Note that there is no guarantee for any loss of data.

- **Precautions when Disposing of this Instrument**

When disposing of harmful substances, be sure dispose of them properly with abiding by the state-provided law.

Harmful substances: (1) PCB (polycarbon biphenyl)  
(2) Mercury  
(3) Ni-Cd (nickel cadmium)  
(4) Other  
Items possessing cyan, organic phosphorous and hexadic chromium and items which may leak cadmium or arsenic (excluding lead in solder).

Example: fluorescent tubes, batteries

# Environmental Conditions

This instrument should be only be used in an area which satisfies the following conditions:

- An area free from corrosive gas
- An area away from direct sunlight
- A dust-free area
- An area free from vibrations
- Altitude of up to 2000 m

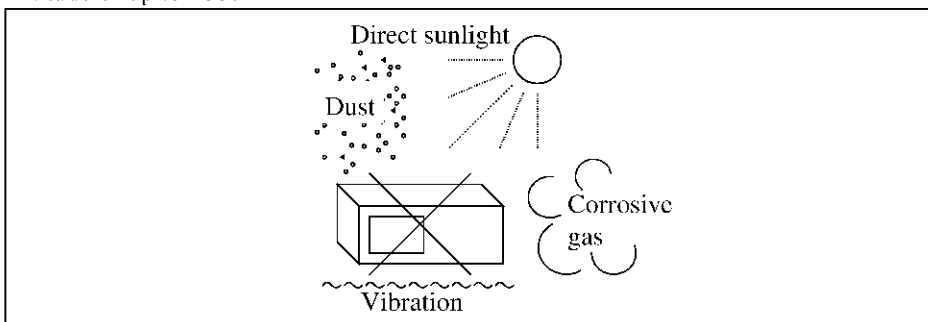

**Figure-1 Environmental Conditions**

- Operating position

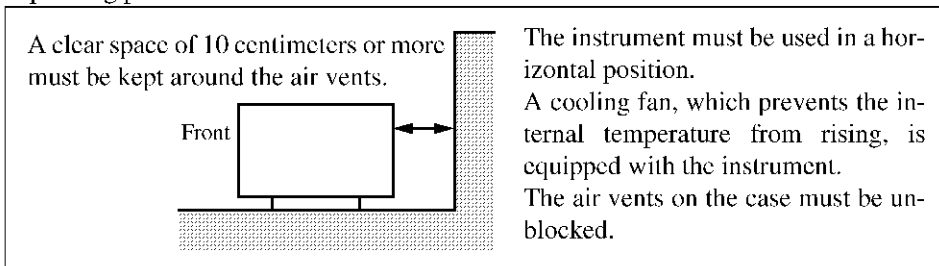

**Figure-2 Operating Position**

- Storage position

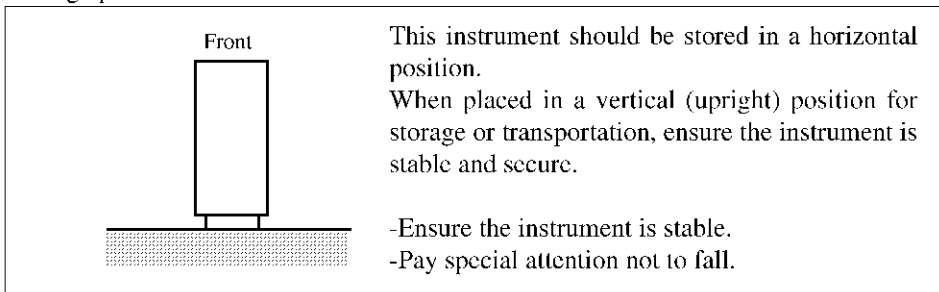

**Figure-3 Storage Position**



- The classification of the transient over-voltage, which exists typically in the main power supply, and the pollution degree is defined by IEC61010-1 and described below.

Impulse withstand voltage (over-voltage) category II defined by IEC60364-4-443

Pollution Degree 2

## Types of Power Cable

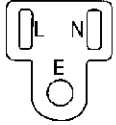
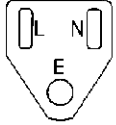
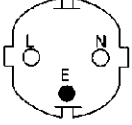
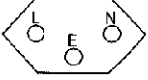
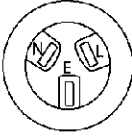
Replace any references to the power cable type, according to the following table, with the appropriate power cable type for your country.

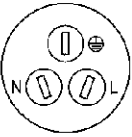
Plug configuration	Standards	Rating, color and length	Model number (Option number)
	PSE: Japan  Electrical Appliance and Material Safety Law	125 V at 7 A Black 2 m (6 ft)	Straight: A01402  Angled: A01412
	UL: United States of America  CSA: Canada	125 V at 7 A Black 2 m (6 ft)	Straight: A01403 (Option 95)  Angled: A01413
	CEE: Europe DEMKO: Denmark NEMKO: Norway VDE: Germany KEMA: The Netherlands CEBEC: Belgium OVE: Austria FIMKO: Finland SEMKO: Sweden	250 V at 6 A Gray 2 m (6 ft)	Straight: A01404 (Option 96)  Angled: A01414
	SEV: Switzerland	250 V at 6 A Gray 2 m (6 ft)	Straight: A01405 (Option 97)  Angled: A01415
	SAA: Australia, New Zealand	250 V at 6 A Gray 2 m (6 ft)	Straight: A01406 (Option 98)  Angled: -----
	BS: United Kingdom	250 V at 6 A Black 2 m (6 ft)	Straight: A01407 (Option 99)  Angled: A01417
	CCC: China	250 V at 10 A Black 2 m (6 ft)	Straight: A114009 (Option 94)  Angled: A114109





## CAUTIONS ON USING THE D3186

### Caution When Connecting Input and Output Signals

**CAUTION:** *When using the D3186, be sure to always follow the notes of caution described below, as the instrument is susceptible to static and other influences and can easily be damaged.*

1. Make sure to discharge the electrostatic energy from all devices before connecting them to the input and output terminals. In particular, keep in mind that a DC blocking capacitor, devices that include a DC blocking capacitor, and cables might be storing an electric charge. An electrical discharge resulting from connecting these devices to the instrument might damage it. Therefore, make sure you follow the examples described below to discharge the static electricity before connecting any of these items.
  - Caution when connecting cables

There is dielectric material between the central conductor and the external conductor which might store an electric charge. Therefore, create a short between the internal and external electrodes before connecting.
  - Caution when using a DC blocking capacitor or Bias Tee

Create a short between the central electrodes before connecting because the DC blocking capacitor or Bias Tee might be storing an electric charge.
2. When filtering DC current output from this instrument, it is recommended that a Bias Tee be used as shown in the Figure 1.

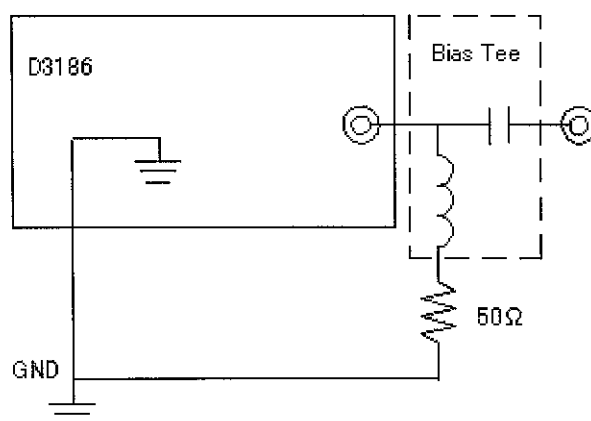

Figure 1 Removing Direct Current Using a Bias Tee

**D3186**  
**PULSE PATTERN GENERATOR**  
**OPERATION MANUAL**

**CAUTIONS ON USING THE D3186**

---

In particular, when DC voltage is applied after filtering the direct current, it is recommended that two Bias Tees be used as described in the Figure 2.

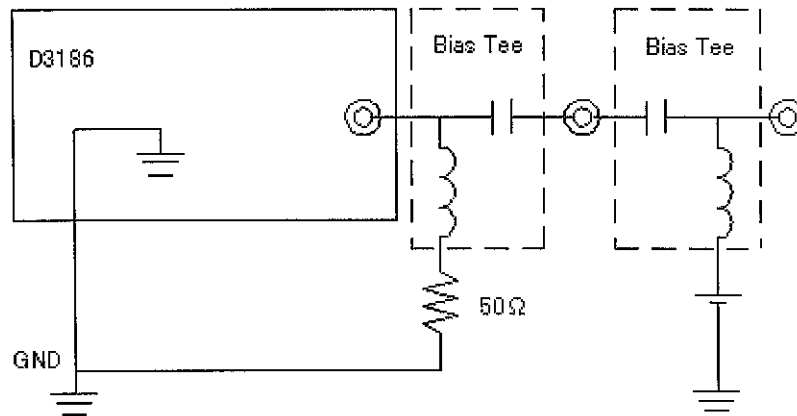

Figure 2 Applying Direct Voltage

If a sudden voltage change from the device under measurement comes to this instrument through circuits such as the DC blocking capacitor and Bias Tee, the instrument may be damaged. When the output voltage of the device under measurement is not stable enough, wait until it becomes stable, and then connect it to the instrument using circuits such as DC blocking capacitor and Bias Tee.

# Certificate of Conformity



This is to certify, that

**Pulse Pattern Generator**

---

**D3186**

---

instrument, type, designation

complies with the provisions of the EMC Directive 89/336/EEC in accordance with EN50081-1 and EN50082-1 and Low Voltage Directive 73/23/EEC in accordance with EN61010.

**ADVANTEST Corp.**

Tokyo, Japan

**ROHDE&SCHWARZ**

Engineering and Sales GmbH

Munich, Germany

3186.00



## Table of Power Cable Options

There are six power cable options (refer to following table).

Order power cable options by Model number.

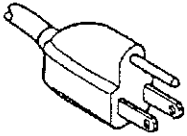
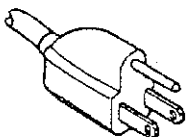
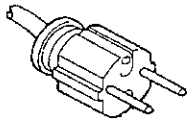
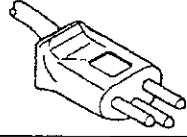
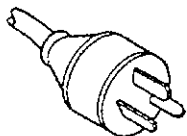
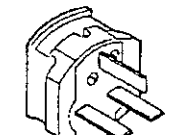
	Plug configuration	Standards	Rating, color and length	Model number (Option number)
1		JIS: Japan Law on Electrical Appliances	125 V at 7 A Black 2 m (6 ft)	Straight: A01402 Angled: A01412
2		UL: United States of America CSA: Canada	125 V at 7 A Black 2 m (6 ft)	Straight: A01403 (Option 95) Angled: A01413
3		CEE: Europe DEMKO: Denmark NEMKO: Norway VDE: Germany KEMA: The Netherlands CEBEC: Belgium OVE: Austria FIMKO: Finland SEMKO: Sweden	250 V at 6 A Gray 2 m (6 ft)	Straight: A01404 (Option 96) Angled: A01414
4		SEV: Switzerland	250 V at 6 A Gray 2 m (6 ft)	Straight: A01405 (Option 97) Angled: A01415
5		SAA: Australia, New Zealand	250 V at 6 A Gray 2 m (6 ft)	Straight: A01406 (Option 98) Angled: -----
6		BS: United Kingdom	250 V at 6 A Black 2 m (6 ft)	Straight: A01407 (Option 99) Angled: A01417



D3186  
PULSE PATTERN GENERATOR  
OPERATION MANUAL

Preface

---

## PREFACE

- The following type of instrument is related to this manual.

D3286 Error Detector

TR4515 Synthesized Sweeper





## TABLE OF CONTENTS

1. OUTLINE .....	1-1
1.1 Outline of Product .....	1-1
1.2 Before Using .....	1-2
1.2.1 Checking the Appearance and Accessories .....	1-2
1.2.2 Working Environment .....	1-3
1.2.3 Setup .....	1-4
1.2.4 Precautions for Connecting the I/O Signal Lines .....	1-5
1.2.5 Storage, Transportation and Cleaning .....	1-6
1.3 Replacing Parts with Limited Life .....	1-7
2. WHEN YOU USE THE DEVICE FOR THE FIRST TIME .....	2-1
2.1 Front Panel .....	2-1
2.1.1 Frequency Setting Section .....	2-2
2.1.2 Pattern Setting Section .....	2-4
2.1.3 Output Setting/Connector Section .....	2-8
2.1.4 File/GPIB Control Section .....	2-12
2.2 Rear Panel .....	2-16
3. OPERATION .....	3-1
3.1 Power On .....	3-1
3.2 Operation on the Panel .....	3-2
3.2.1 Operation on the Front Panel .....	3-2
(1) Frequency Setting Section .....	3-2
(2) Pattern Setting Section .....	3-4
(3) Output setting/Connector section .....	3-24
(4) File/GPIB operation section .....	3-33
(5) Setting the initial state .....	3-44
3.2.2 Rear Panel Operation Method .....	3-45
4. SYSTEM OPERATION METHOD .....	4-1
4.1 Setting the D3186 .....	4-1
4.1.1 Connecting Clock Input .....	4-1
4.1.2 Setting Data Output .....	4-2
4.1.3 Setting Clock Output .....	4-4
4.1.4 Setting the Pattern .....	4-7

D3186  
PULSE PATTERN GENERATOR  
OPERATION MANUAL

*Table of Contents*

---

4.2	Setting the D3286	4-8
4.2.1	Setting Data Input	4-8
4.2.2	Setting Clock Input	4-8
4.2.3	Setting the Pattern	4-9
4.2.4	Setting Data Input Polarity	4-9
4.2.5	Adjusting Clock Delay	4-9
4.3	Connecting Signal Lines	4-10
5.	GPIB	5-1
5.1	Outline of GPIB	5-1
5.2	Functional Specification	5-3
5.2.1	GPIB Specification	5-3
5.2.2	Interface Functions	5-4
5.3	Notes on GPIB Usage	5-6
5.4	Setting Device Address	5-7
5.5	Canceling Master/Slave Control Function	5-8
5.6	Program Message (Listener Format)	5-9
5.6.1	Basic Format	5-9
5.6.2	Initialization Program Message	5-12
5.6.3	Service Request ("SRQ") Program Message	5-12
5.6.4	Command Program Message (Remote Code)	5-13
(1)	Clock frequency setting	5-13
(2)	Pattern setting	5-14
(3)	Output setting	5-21
(4)	Filing	5-26
(5)	Calender/Clock operation	5-27
(6)	GPIB and system setting	5-28
(7)	External SG control code setting	5-29
5.6.5	Word Pattern and Frame Pattern Settings	5-31
(1)	Setting word pattern	5-31
(a)	Hex mode setting format	5-31
(b)	Binary mode setting format:	5-32
(2)	Setting frame pattern	5-34
(a)	Hex mode setting format	5-34
(b)	Binary mode setting format	5-35
5.7	Query Program Message and Response Message	5-37
5.7.1	What is Query Program Message?	5-37
5.7.2	Query Program Message and Response Message Formats	5-38
(1)	Clock frequency setting	5-38

D3186  
PULSE PATTERN GENERATOR  
OPERATION MANUAL

*Table of Contents*

---

(2) Pattern setting .....	5-38
(3) Output setting .....	5-45
(4) Calender/clock operation .....	5-50
(5) GPIB and system setting .....	5-51
(6) External SG control code setting .....	5-52
5.8 Status Byte .....	5-53
5.9 Device Clear (SDC and DCL Commands) .....	5-54
5.10 Initial State .....	5-55
5.10.1 Initial State of Operation .....	5-55
5.10.2 Setup Parameter Initialization .....	5-55
5.11 Program Example .....	5-61
5.11.1 Operation Condition Setup .....	5-61
5.11.2 Operation Condition Read .....	5-64
5.11.3 Word Pattern Setup (Hex mode) .....	5-66
5.11.4 Word Pattern Setup (Binary mode) .....	5-70
6. FILE FUNCTION .....	6-1
6.1 Outline .....	6-1
6.2 File Format .....	6-2
6.3 File Size .....	6-2
7. MESSAGE DISPLAY .....	7-1
7.1 MPU Error Display .....	7-1
7.2 Low Battery Display .....	7-2
7.3 File Error Display .....	7-3
7.4 Displays Relating to Delay Lines .....	7-5
8. HOW TO VERIFY THE PERFORMANCE AND FUNCTIONS .....	8-1
8.1 Performance Verification .....	8-1
8.1.1 Confirming CLOCK output .....	8-1
8.1.2 Confirming CLOCK2 output .....	8-2
8.1.3 Confirming 1/2 CLOCK output .....	8-3
8.1.4 Confirming 1/32 CLK TRIGGER signal .....	8-4
8.1.5 Confirming PATTERN TRIGGER signal .....	8-5
8.1.6 Confirming 1/4 RATE output .....	8-8
8.1.7 Confirming $\overline{\text{CLOCK1}}$ , $\overline{\text{CLOCK1}}$ outputs .....	8-11
8.1.8 Confirming DATA, $\overline{\text{DATA}}$ outputs .....	8-16

D3186  
PULSE PATTERN GENERATOR  
OPERATION MANUAL

*Table of Contents*

---

8.2 Confirming Function .....	8-21
8.2.1 Connections and Basic Setup of D3186 and D3286 .....	8-21
8.2.2 Confirming the frequency .....	8-22
8.2.3 Confirming the PRBS Pattern .....	8-22
8.2.4 Confirming the Word Pattern .....	8-23
9. SPECIFICATIONS .....	9-1
9.1 Operation Clock .....	9-1
9.2 Pattern .....	9-2
9.3 Main Input .....	9-6
9.4 Auxiliary Output Signals .....	9-9
9.5 Control Input Signals .....	9-10
9.6 System Functions .....	9-11
9.7 General Specifications .....	9-12
LIST OF ABBREVIATIONS .....	A-1
DIMENSIONAL OUTLINE DRAWING .....	EXT-1
ALPHABETICAL INDEX .....	I-1

D3186  
PULSE PATTERN GENERATOR  
OPERATION MANUAL

*List of Illustrations*

## LIST OF ILLUSTRATIONS

No.	Title	Page
1-1	Ventilation by the Cooling Fan .....	1-3
1-2	Grounding of Measuring Instrument and Device to be Tested .....	1-5
1-3	Grounding of Floating Device .....	1-5
2-1	Front Panel .....	2-1
2-2	Frequency Setting Section .....	2-2
2-3	Pattern Setting Section .....	2-5
		2-7
2-4	Output Setting/Connector Section .....	2-9
		2-11
2-5	File/GPIB Control Section .....	2-13
		2-15
2-6	Rear Panel .....	2-17
3-1	Frame Pattern when Payload Type is WORD or PRBS .....	3-7
3-2	Frame Pattern when Payload Type is CID .....	3-8
3-3	Operation of EXT GATE INPUT .....	3-48
3-4	Operation of EXT ALT INPUT .....	3-48
3-5	Phase Relation of 1/4 RATE OUTPUT .....	3-49
4-1	DATA and $\overline{\text{DATA}}$ Output, DC Connection, and 0 V Termination .....	4-3
4-2	DATA and $\overline{\text{DATA}}$ Output, DC Connection, - 2 V Termination, and ECL Level .....	4-3
4-3	DATA and $\overline{\text{DATA}}$ Output and AC Connection .....	4-3
4-4	CLOCK1 and $\overline{\text{CLOCK1}}$ Output, DC Connection, 0 V Termination .....	4-5
4-5	CLOCK1 and $\overline{\text{CLOCK1}}$ Output, DC Connection, - 2 V Termination, ECL Level ...	4-5
4-6	CLOCK1 and $\overline{\text{CLOCK1}}$ Output, AC Connection .....	4-5
4-7	CLOCK2 Output, AC Connection Terminator .....	4-6
4-8	CLOCK2 Output, DC Connection Terminator .....	4-6
4-9	Signal Line Connections .....	4-11
5-1	Outline of GPIB .....	5-2
5-2	Signal Line Termination .....	5-3
5-3	Pin Assignment of GPIB Connector .....	5-5

D3186  
PULSE PATTERN GENERATOR  
OPERATION MANUAL

*List of Illustrations*

No.	Title	Page
5-4	Basic Syntax of Program Message (1 of 3) .....	5-9
	Basic Syntax of Program Message (2 of 3) .....	5-10
	Basic Syntax of Program Message (3 of 3) .....	5-11
8-1	CLOCK Output Waveform (f = 200 MHz) .....	8-2
8-2	CLOCK2 Output Waveform (f = 200 MHz) .....	8-3
8-3	1/2 CLOCK Output Waveform (f = 200 MHz) .....	8-4
8-4	1/32 CLK TRIGGER Output Waveform (f = 12000 MHz) .....	8-5
8-5	PATTERN TRIGGER Output Waveform (f = 12000 MHz, 5 ns/div) .....	8-6
8-6	PATTERN TRIGGER Output Waveform (PRBS, N = 23, f = 12000 MHz, 5 ms/div) .....	8-6
8-7	PATTERN TRIGGER Output Waveform (WORD, PL = 3, f = 12000 MHz, 20 ns/div) .....	8-8
8-8	1/4 Rate Output Waveform (f = 12000 MHz) .....	8-9
8-9	CLOCK1, <u>CLOCK1</u> Output Waveform (TO 0V, f = 12000 MHz) .....	8-12
8-10	ECL Termination Jig Connection .....	8-13
8-11	CLOCK1, <u>CLOCK1</u> , Output Waveform (TO -2V, f = 12000 MHz) .....	8-14
8-12	Connections of DC Blocking Capacitor .....	8-15
8-13	CLOCK1, <u>CLOCK1</u> Output Waveform (AC, f = 12000 MHz) .....	8-16
8-14	DATA, <u>DATA</u> Output Waveform (TO 0V, f = 12000 MHz) .....	8-17
8-15	DATA, <u>DATA</u> Output Waveform (TO -2V, f = 12000 MHz) .....	8-19
8-16	DATA, <u>DATA</u> Output Waveform (AC, f = 12000 MHz) .....	8-20

D3186  
PULSE PATTERN GENERATOR  
OPERATION MANUAL

*List of Tables*

## LIST OF TABLES

No.	Title	Page
1-1	List of Standard Accessories .....	1-2
3-1	Combination of Patterns which can be Set .....	3-4
3-2	PRBS Pattern Generating Function and Applicable Standard .....	3-5
3-3	Available Groups in Each Pattern Mode .....	3-12
3-4	Pattern Display/Set Items .....	3-13
3-5	Setting Range and Step of Pattern Length of a Whole WORD Pattern .....	3-16
3-6	Address Setting Range and Maximum Value .....	3-17
3-7	Maximum Available Number of Frames (NO. OF FRAME) (FS = ROW LENGTH (bytes) × NO. OF ROW) .....	3-18
3-8	Maximum Number of STM-N Frames which can be Set (NO. OF FRAME) (FS = ROW LENGTH (bytes) × NO. OF ROW) .....	3-18
3-9	Setting Range and Step of Row Length .....	3-19
3-10	Setting Range and Step of Overhead Length .....	3-20
3-11	Offset Setting Range .....	3-29
3-12	DIP Switch SW1 Settings .....	3-46
5-1	Interface Functions .....	5-4
5-2	Command Program Message .....	5-13
5-3	Query Program Message and Response Message .....	5-38
7-1	Floppy Disk Related Error Message .....	7-3





## 1. OUTLINE

### 1.1 Outline of Product

D3186 is a high-performance pulse pattern generator to generate 7 types of pseudo-random (PRBS) patterns from  $2^7-1$  to  $2^{31}-1$ , programmable (WORD) patterns up to 8M ( $2^{23}$ ) bits, or frame patterns of SDH or SONET structure at very high speed from 150 Mb/s to 12 Gb/s.

Moreover, a system, which is used to evaluate the bit error rate of super-high speed optical communication devices and compound semiconductors, can be structured by combining D3186 with the D3286 error detector.

The advantages of the D3186 include:

[Features]

- ① A high-precision synthesized clock generator is built in.
- ② 16 types of frequency memories are provided for speedy frequency setting.
- ③ For PRBS patterns, mark ratio can be changed between 8 values.
- ④ For FRAME pattern, the type of payload can be selected from WORD, PRBS and CID.
- ⑤ ALTERNATE mode is available which changes over 2 patterns (WORD and FRAME) to execute measurement.
- ⑥ Various types of application are available by using differential data output (DATA,  $\overline{\text{DATA}}$ ), differential clock output (CLOCK1,  $\overline{\text{CLOCK1}}$ ) and fixed amplitude clock output (CLOCK2).
- ⑦ Amplitude, offset and terminator conditions can be individually set for the differential data output and the differential clock output each. The terminator conditions can be selected from among TO 0 V, TO -2 V or AC coupling.
- ⑧ From the motor drive type delay line, the phase of clock output can be changed in steps of 1 ps resolution up to  $\pm 400$  ps.
- ⑨ Error can be added in repetition of  $1 \times 10^{-4}$  to  $1 \times 10^{-9}$ , single or external control.
- ⑩ When error measurement is performed by using D3186 combined with D3286 Error Detector, the master slave function interlocks their patterns.
- ⑪ The GPIB (IEEE 488) feature enables full remote control, making it easy to construct a measurement and test system.
- ⑫ The built-in floppy disk drive enables storing/calling the set conditions and the content of pattern setting. (MS-DOS<sup>®</sup> format)
  - ◆ MS-DOS is the registered trademarks of Microsoft Corp.

D3186  
PULSE PATTERN GENERATOR  
OPERATION MANUAL

1.2 Before Using

## 1.2 Before Using

### 1.2.1 Checking the Appearance and Accessories

When you received D3186, first check for damage during transportation. Then check the number and type of standard accessories according to Table 1-1.

If the device is damaged or a standard accessory is missing, contact a nearby Advantest office or agency.

For where to contact, see the list attached at the end of this document.

Note : Order the addition of the accessory etc. with the model name.

Table 1-1 List of Standard Accessories

No.	Name	Model name	Q'ty	Remarks
1	Power cable	*	1	
2	SMA-SMA cable	SF104-11SMA-1000	7	
3	GPIB cable	408JE-101	1	
4	3-pole/2-pole conversion adapter for power plug	---	---	
5	2.92mm adapter	02K121-K00S3	5	
6	50Ω Termination	HRM-601A	5	
7	Operation manual	ED3186	1	
8	Ferrite core for the power cable	ESD-SR-25	1	

\* Advantest provides the power cables for each country.  
Refer to yellow page of "Table of Power Cable Options" at this manual.

**D3186**  
**PULSE PATTERN GENERATOR**  
**OPERATION MANUAL**

**1.2 Before Using**

### 1.2.2 Working Environment

- (1) Avoid using the device in a dusty place or a place where the device is exposed to direct sunlight or where corrosive gas is generated.
- (2) Always use the device in a place where ambient temperature is 0°C to 40°C, and relative humidity is 40% to 85%.
- (3) Avoid applying too strong mechanical impact on the D3186.
- (4) Because the D3186 has a cooling fan of discharge type, be sure to keep 10 cm or larger space between the rear panel and the wall. Also avoid blocking the air intake holes on both sides of the device.

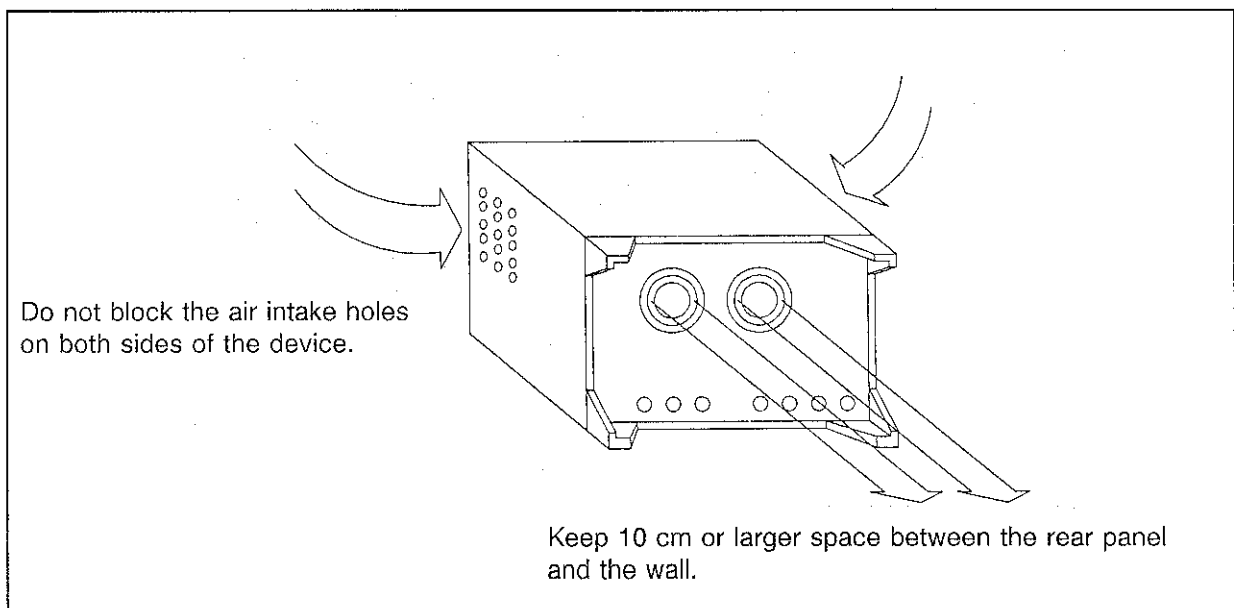

Figure 1-1 Ventilation by the Cooling Fan

- (5) Warm up this instrument for at least 30 minutes to attain all functions within the specifications, although it functions when the power is turned on.

### 1.2.3 Setup

(1) Supply voltage

Supply voltage shall be within 90 to 132 VAC or 198 to 250 VAC, 48 to 63 Hz.

The 100 V and 200 V power circuits are automatically changed over.

Because the device consumes maximum 550 VA power, use a power supply with sufficient capacity.

(2) Power cable and grounding

Advantest provides the power cables for each country.

Refer to yellow page of "Table of Power Cable Options" at this manual.

— WARNING —

1. If the unit seems abnormal, unplug the power cable immediately.
2. Power cable
  - To avoid electrical and fire hazards, use the supplied power cable.
  - When using the unit overseas, use a power cable which complies with the safety standard of the country where it is used.
  - When plugging or unplugging the cable, always hold the plug.
3. Protective ground
  - Plug the power cable into an AC outlet with a protective ground terminal.
  - Using an extension cord without a protective ground terminal will disable the protective ground.

### 1.2.4 Precautions for Connecting the I/O Signal Lines

- (1) The output terminals shall be loaded a 50  $\Omega$  pure resistance.  
It is not confined, however, when a DC blocking capacitor is mounted so that a voltage cannot be applied to an output from the pattern generator. (A voltage can be applied to a 50  $\Omega$  resistance.)
- (2) Be sure not to apply a voltage/a current other than the ECL level mode at a -2V terminator.
- (3) The device internal circuit connected from the I/O terminal of the D3186 includes high frequency electronic components, which are likely to be affected and damaged by static electricity.

Before connecting the I/O terminals with other device, etc., ground them (all devices to be connected). (See Figure 1-2.)

Before a floating device such as digital multimeter, etc. is connected with D3186, ground the device through a 10 k $\Omega$  to 100 k $\Omega$  resistance. (See Figure 1-3.)

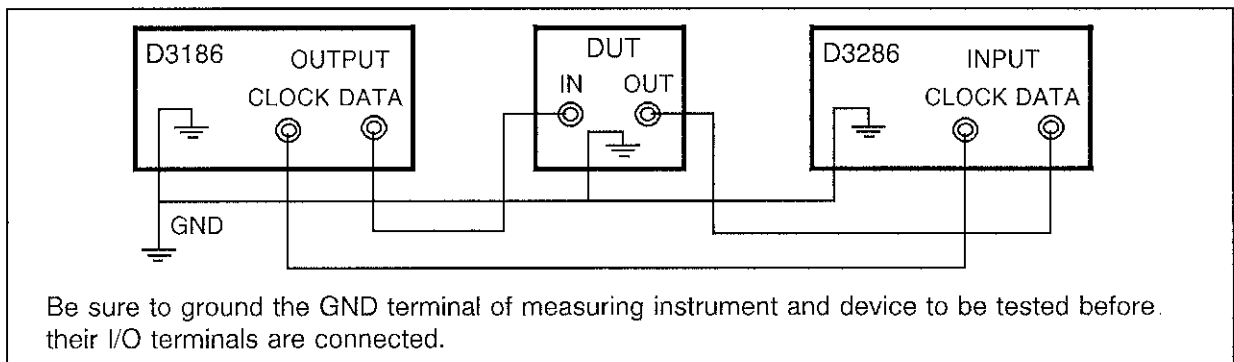

Figure 1-2 Grounding of Measuring Instrument and Device to be Tested

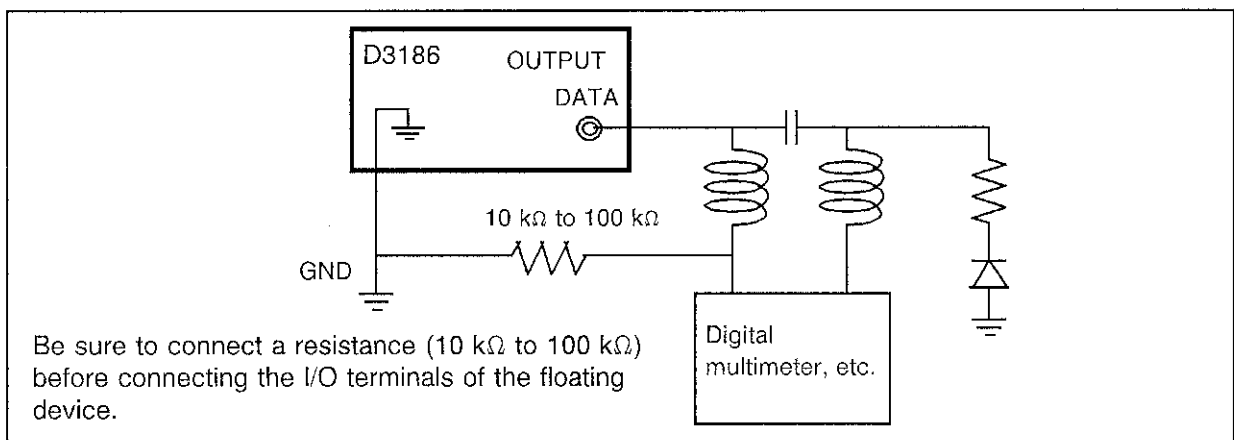

Figure 1-3 Grounding of Floating Device

### 1.2.5 Storage, Transportation and Cleaning

#### (1) Storage

To store the D3186 for a long time, put it in a corrugated paper box and store the box in a place where humidity is low and direct sunlight does not come in.

Storage temperature and humidity are -20 °C to +60 °C, and 30% to 85%, respectively.

#### (2) Transportation

To transport the D3186, use the packing material with which the device was packed when delivered to you. When you have no longer the packing material, pack the device in the following manner:

- ① Wrap the D3186 in a vinyl sheet (with desiccant put in it to prevent influence of moisture).
- ② Prepare a corrugated paper box with 5 mm or more thickness. Put cushioning material in the box to approximately 40 mm thickness so that the D3186 is surrounded by the cushioning material.
- ③ After wrapping the D3186 by cushioning material, put accessories in the box, and put cushioning material again in the box. Then close the box, and bind it by packing string.

#### (3) Cleaning

To clean the D3186, observe the following precaution.

CAUTION

To maintain or clean the device, do not use any solvent which may degrade plastics (organic solvent such as benzene, toluene and acetone).

D3186  
PULSE PATTERN GENERATOR  
OPERATION MANUAL

1.3 Replacing Parts with Limited Life

### 1.3 Replacing Parts with Limited Life

The D3186 uses the following parts with limited life that are not listed in Safety Summary. Replace the parts listed below after their expected lifespan has expired.

Part name	Life
Battery	5 years
Delay line	10,000 times
Relay	200,000 times
Key switch	5,000,000 times
Rotary encoder	2,000,000 cycle





D3186  
PULSE PATTERN GENERATOR  
OPERATION MANUAL

## 2. WHEN YOU USE THE DEVICE FOR THE FIRST TIME

This chapter explains the name and functions of each section on the front and rear panels. For how to operate them, see Chapter 3.

### 2.1 Front Panel

Figure 2-1 shows the sketch drawing of the front panel, while Figures 2-2, 2-3, 2-4 and 2-5 show the frequency setting section, pattern setting section, output setting/connector section and file/GPIB control section of the front panel, respectively.

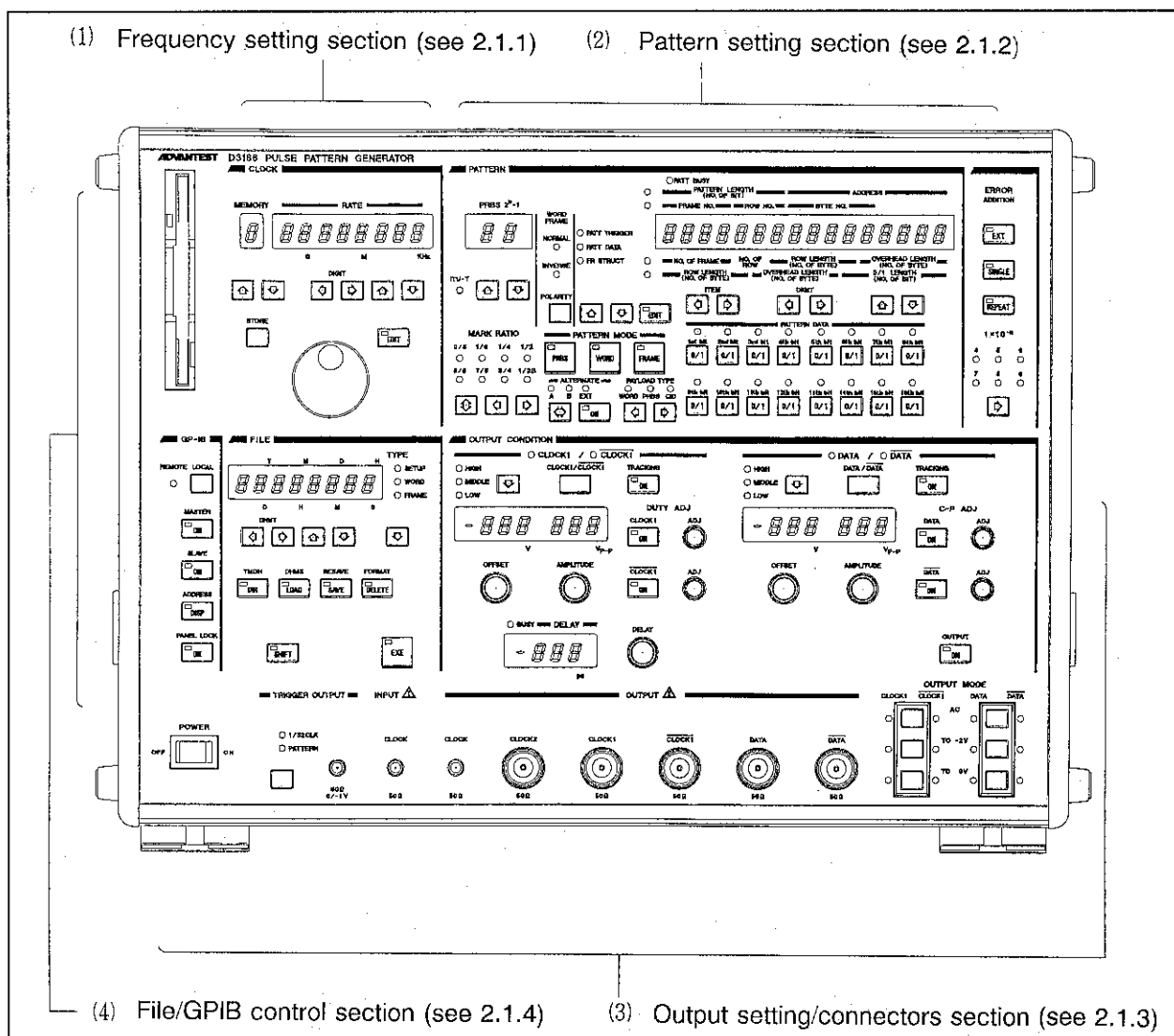

Figure 2-1 Front Panel

### 2.1.1 Frequency Setting Section

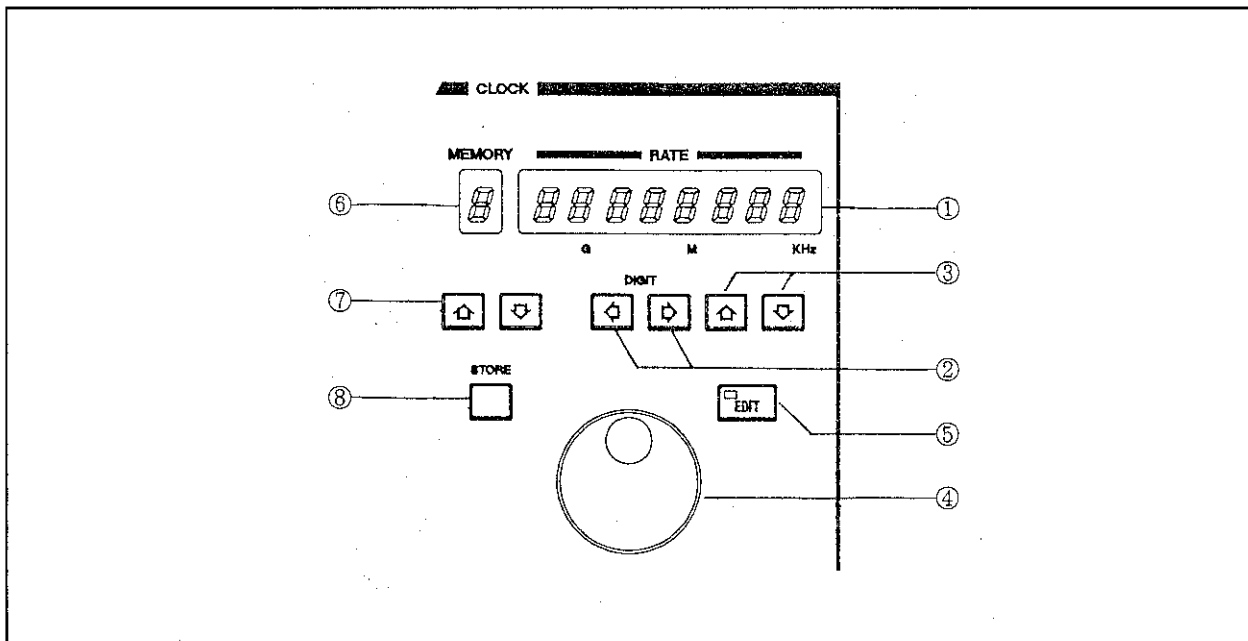

Figure 2-2 Frequency Setting Section

This frequency setting section is used to set the frequency for operation clock.

- ① Frequency (RATE) indicator  
The current set frequency of the clock is indicated.
- ② DIGIT key ( , )  
Shifts left- or rightwards the digit (at which the pointer is lighting) for setting frequency.
- ③ Frequency set key ( , )  
Increments/decrements the value of the digits which is higher in order than that at which the pointer is lighting in the frequency indicator.
- ④ Frequency set knob  
Increments/decrements the value of the digits which is higher in order than that at which the pointer is lighting in the frequency indicator.
- ⑤ EDIT key ( )  
Set this key to ON when a frequency is set or saved into the memory, or to OFF when a frequency is recalled from the memory.



D3186  
PULSE PATTERN GENERATOR  
OPERATION MANUAL

2.1 Front Panel

---

⑥ Memory number indicator

Up to 16 kinds of frequency can be saved into the memory. In this indicator, the memory number of the saved frequency can be indicated.

⑦ Memory number set key ( ,  )

Increments/decrements the memory number of the frequency to be saved or recalled.







⑧ STORE key (  )

Press this key when the current set frequency is saved into the memory whose number is being indicated on the memory number indicator.





## 2.1.2 Pattern Setting Section

This pattern setting section sets the contents of the data output pattern.  
The panel layout is the same as that of D3286, except for a small modification.

### (1) Pseudo-random pattern setting section

- ① PATTERN MODE - PRBS key (  )  
Changes over the pattern setting for data output to pseudo-random mode.
- ② PRBS column count (N) select key ( ,  ) and indicator  
Select one from 7 types of PRBS pattern: 7, 9, 10, 11, 15, 23 and 31 columns.
- ③ MARK RATIO select key ( , ,  ) and "0/8", "1/8", "1/4", "1/2", "8/8", "7/8", "3/4" and "1/2B" lamps  
Select one from 8 mark ratios (0/8 to 8/8).
- ④ ITU-T lamp  
Lights up when the set PRBS column count and mark ratio conform to the international recommendation.

### (2) Word pattern and frame pattern setting section

- ⑤ PATTERN MODE - WORD key (  )  
Changes over the pattern for data output to WORD mode.
- ⑥ PATTERN MODE - FRAME key (  )  
Changes over the pattern for data output to FRAME mode.
- ⑦ ALTERNATE key (  )  
Turn this switch ON to use the ALTERNATE mode which outputs data by changing over between two (A and B) patterns.
- ⑧ A/B select key (  ) and A and B lamps  
In ALTERNATE mode, changes over the pattern for output or editing to A or B.
- ⑨ EXIT lamp  
In ALTERNATE mode, lights up when pattern is changed over according to external signal. Internal/external change-over is made by bit 1 of SW1 on the rear panel (see Figure 2-6, ⑥).

D3186  
PULSE PATTERN GENERATOR  
OPERATION MANUAL

2.1 Front Panel

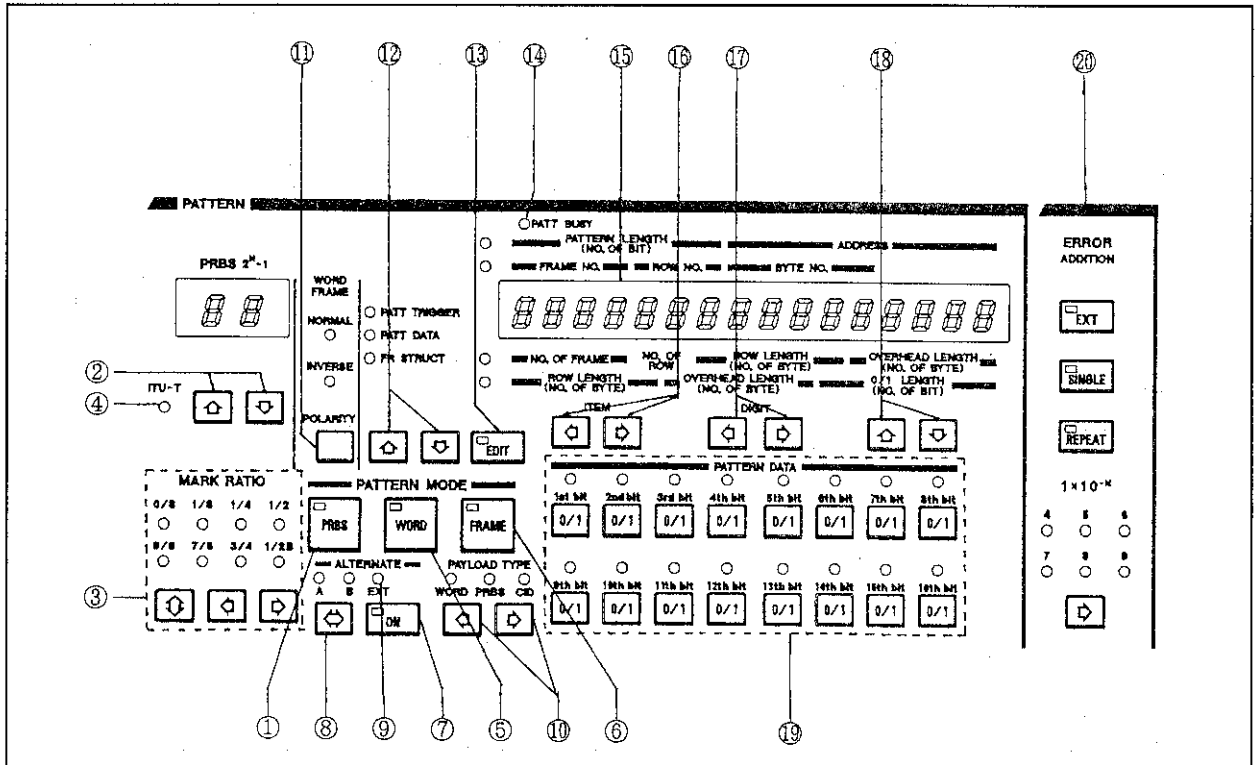

Figure 2-3 Pattern Setting Section

- ⑩ PAYLOAD TYPE select key (  ,  ) and WORD, PRBS, CID lamps  
This key selects the type of payload in FRAME mode.
- ⑪ POLARITY select key (  ) and NORMAL and INVERSE lamps  
Selects the logic of data output patterns in WORD or FRAME mode.
- ⑫ Group select key (  ,  ) and lamps  
Selects the group of items to display on the pattern length/address indicator ⑮.
- ⑬ EDIT key (  )  
Turns ON while WORD or FRAME mode patterns are being edited.
- ⑭ PATT BUSY lamp  
Lights up while the content of pattern setting is being transferred to the pattern generating circuit.



D3186  
PULSE PATTERN GENERATOR  
OPERATION MANUAL

2.1 Front Panel



⑤ Pattern length/address indicator

Displays the length, address and byte number of pattern.



This indication changes with set pattern modes and set items. What item to indicate is shown by the lamp on the left.

⑥ ITEM key (  ,  )



Selects what item to set from those displayed on the pattern length/address indicator ⑤.

⑦ DIGIT key (  ,  )

Shifts left- or rightwards the digit (at which the pointer is lighting) for setting pattern length or address.

⑧ Pattern length/address set key (  ,  )

Increments/decrements the value of the digits which is higher in order than that at which the pointer is lighting in the pattern length/address indicator.

⑨ PATTERN DAT lamp and 1st to 16th keys (  , ...,  )

Displays/sets the content of the patterns for 16 bits of the address shown by the pattern length/address indicator.

⑩ ERROR ADDITION setting section

Bit error can be added to the output pattern in repetition, single or external control with an error rate of  $1 \times 10^{-4}$  to  $1 \times 10^{-9}$ .

D3186  
**PULSE PATTERN GENERATOR**  
**OPERATION MANUAL**

2.1 Front Panel

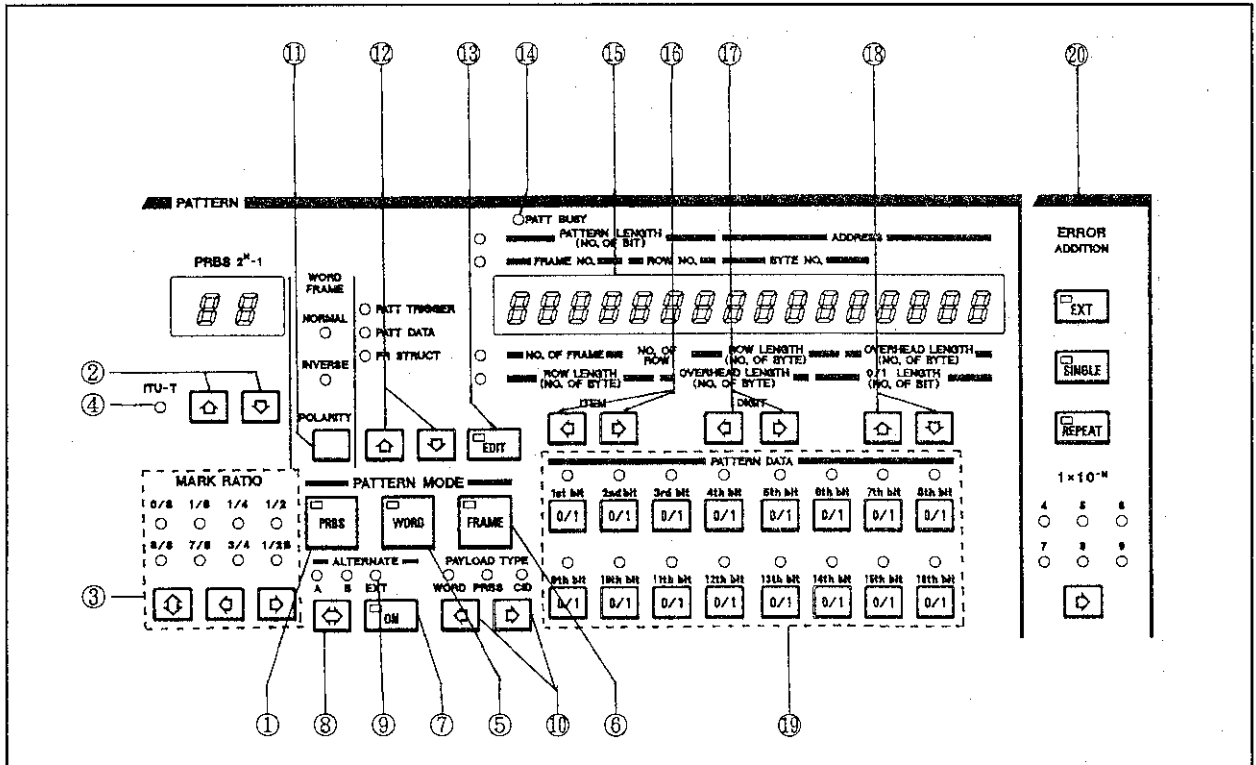

Figure 2-3 Pattern Setting Section

### 2.1.3 Output Setting/Connector Section

This section is used to set the output waveform, etc. and to connect input/output.

① POWER switch

Turns ON/OFF the power of the D3186. Pressing the right side of the button turns ON the power.

② TRIGGER OUTPUT select key (  ) and 1/32 CLK and PATTERN lamps

This key changes over the type of signal which is output to TRIGGER OUTPUT connector explained in the following item -3: 1/32 divided clock signal or pattern synchronization signal.

③ TRIGGER OUTPUT connector

Outputs trigger signal for observing waveform by oscilloscope.

④ CLOCK INPUT connector

Inputs oscillation clock for operation. Input the internal clock or the external clock which is being output to the CLOCK OUTPUT connector ⑤.

⑤ CLOCK OUTPUT connector

Output connector for the internal clock

⑥ CLOCK2 OUTPUT connector

Output connector for clock whose amplitude, offset and delay are fixed.

⑦ CLOCK1,  $\overline{\text{CLOCK1}}$  OUTPUT connector

Output connector for clock whose amplitude, offset, delay and termination conditions are variable.

⑧ DATA,  $\overline{\text{DATA}}$  OUTPUT connector

Outputs the set pattern in NRZ. Amplitude, offset and termination conditions are variable.

⑨ CLOCK1,  $\overline{\text{CLOCK1}}$  OUTPUT setting section

Selects the output mode (termination conditions) for CLOCK 1 and  $\overline{\text{CLOCK 1}}$  OUTPUT.

⑩ DATA,  $\overline{\text{DATA}}$  OUTPUT MODE setting section

Selects the output mode (termination conditions) for DATA and  $\overline{\text{DATA}}$  OUTPUT.

⑪ CLOCK1,  $\overline{\text{CLOCK1}}$  OFFSET MODE select key (  ) and HIGH, MIDDLE, LOW lamp

Selects the offset level to be set in -14 according to the top/middle/bottom of the waveform.



**D3186**  
**PULSE PATTERN GENERATOR**  
**OPERATION MANUAL**

**2.1 Front Panel**

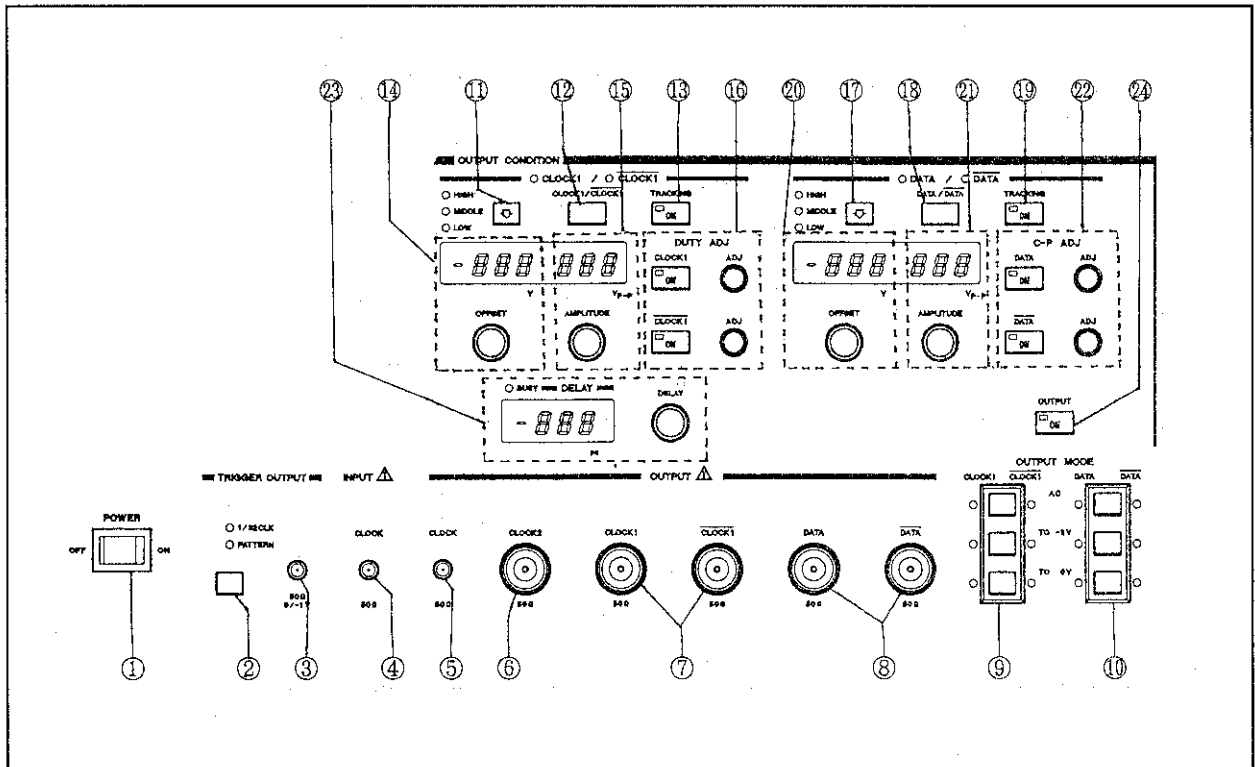





Figure 2-4 Output Setting/Connector Section

- ⑫  $\overline{\text{CLOCK1}}/\overline{\text{CLOCK1}}$  ACTIVE CHANNEL key (  ) and  $\overline{\text{CLOCK1}}$ ,  $\overline{\text{CLOCK1}}$  lamp  
 Selects the clock output whose amplitude, offset and termination conditions are to be set.
- ⑬  $\overline{\text{CLOCK1}}$ ,  $\overline{\text{CLOCK1}}$  TRACKING key (  )  
 Selects whether amplitude, offset and termination conditions of  $\overline{\text{CLOCK1}}$  OUTPUT and  $\overline{\text{CLOCK1}}$  OUTPUT are set in link or individual.
- ⑭  $\overline{\text{CLOCK1}}$ ,  $\overline{\text{CLOCK1}}$  OFFSET setting section  
 The knob and indicator to set the offset of  $\overline{\text{CLOCK1}}$  and  $\overline{\text{CLOCK1}}$  OUTPUT.
- ⑮  $\overline{\text{CLOCK1}}$ ,  $\overline{\text{CLOCK1}}$  AMPLITUDE setting section  
 The knob and indicator to set the amplitude of  $\overline{\text{CLOCK1}}$  and  $\overline{\text{CLOCK1}}$  OUTPUT.
- ⑯ DUTY ADJ section  
 Adjusts the duty ratio of  $\overline{\text{CLOCK1}}$  and  $\overline{\text{CLOCK1}}$  OUTPUT.

D3186  
PULSE PATTERN GENERATOR  
OPERATION MANUAL

2.1 Front Panel

---

- ⑰ DATA,  $\overline{\text{DATA}}$  OFFSET MODE select key (  ) and HIGH, MIDDLE, LOW lamp  
Selects the offset level to be set in -20 according to the top/middle/bottom of the waveform.
- ⑱ DATA/ $\overline{\text{DATA}}$  ACTIVE CHANNEL key (  ) and DATA,  $\overline{\text{DATA}}$  lamp  
Selects the data output whose amplitude, offset and termination conditions are to be set.
- ⑲ DATA,  $\overline{\text{DATA}}$  TRACKING key (  )  
Selects whether amplitude, offset and termination conditions of DATA OUTPUT and  $\overline{\text{DATA}}$  OUTPUT are set in link or individual.
- ⑳ DATA,  $\overline{\text{DATA}}$  OFFSET setting section  
The knob and indicator to set the offset of DATA and  $\overline{\text{DATA}}$  OUTPUT.
- ㉑ DATA,  $\overline{\text{DATA}}$  AMPLITUDE setting section  
The knob and indicator to set the amplitude of DATA and  $\overline{\text{DATA}}$  OUTPUT.
- ㉒ C-P ADJ section  
Adjusts the cross point position of DATA and  $\overline{\text{DATA}}$  OUTPUT.
- ㉓ DELAY setting section  
The knob and indicator to set the phase difference between data (DATA and  $\overline{\text{DATA}}$ ) output and clock (CLOCK 1 and  $\overline{\text{CLOCK 1}}$ ) output.
- ㉔ OUTPUT key (  )  
Turns ON/OFF the data (DATA and  $\overline{\text{DATA}}$ ) output.

D3186  
**PULSE PATTERN GENERATOR**  
**OPERATION MANUAL**

**2.1 Front Panel**

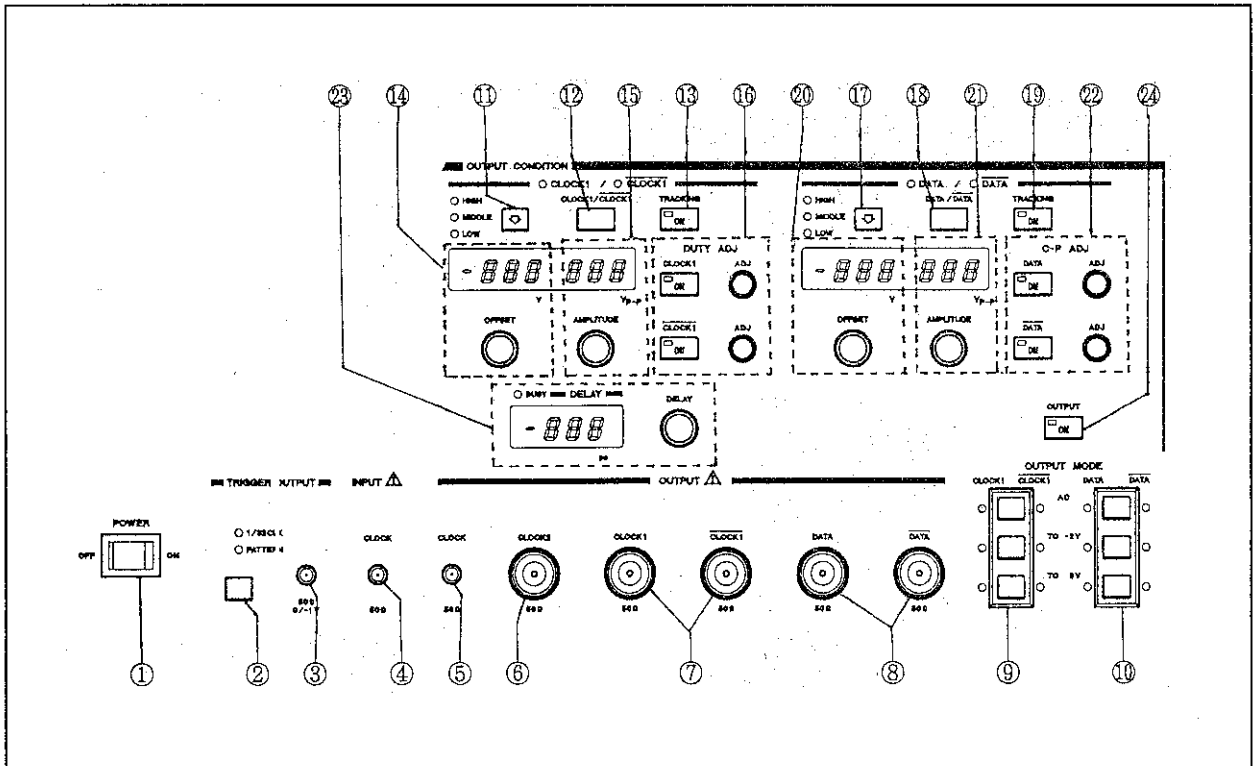











Figure 2-4 Output Setting/Connector Section

## 2.1.4 File/GPIB Control Section

### (1) File control section

- ① File number/date and time indicator  
Displays the file number according to the key setting in ④ to ⑨.  
Displays the GPIB device address when the address display key is set to ON in ⑩.
- ② DIGIT key (  ,  )  
Shifts left- or rightwards the digit to set a file number.
- ③ File number/date and time set keys (  ,  )  
Increments/decrements the value of the digits which are higher in order than that selected with the DIGIT key in above ②.
- ④ File type set key (  ) and SETUP, WORD and FRAME MEAS lamps  
The key and indicating lamps to set the type of the file which is subject to DIR, LOAD, SAVE or RESAVE processing.
- ⑤ DIR/YMDH key (  )  
Displays a directory or year, month, day and time on the file number/date and time indicator. When the SHIFT key ⑨ is set to OFF, the file number is indicated. Or, when the SHIFT key is ON, the date and time is indicated.
- ⑥ LOAD key (  )  
Specifies file loading or day, hour, minute and second indication. When SHIFT key ⑨ is set to OFF, file loading is specified. Or, when the SHIFT key is ON, the day, hour, minute and second indication is specified.
- ⑦ SAVE/RESAVE key (  )  
Saves/re-saves data in a file. Saves when the SHIFT key is set to OFF in ⑨, while re-saves when set to ON.
- ⑧ DELETE/FORMAT key (  )  
Deletes a file or initializes a disk. Deletes when the SHIFT key is set to OFF in ⑨, while initializes when set to ON.

D3186  
PULSE PATTERN GENERATOR  
OPERATION MANUAL

2.1 Front Panel

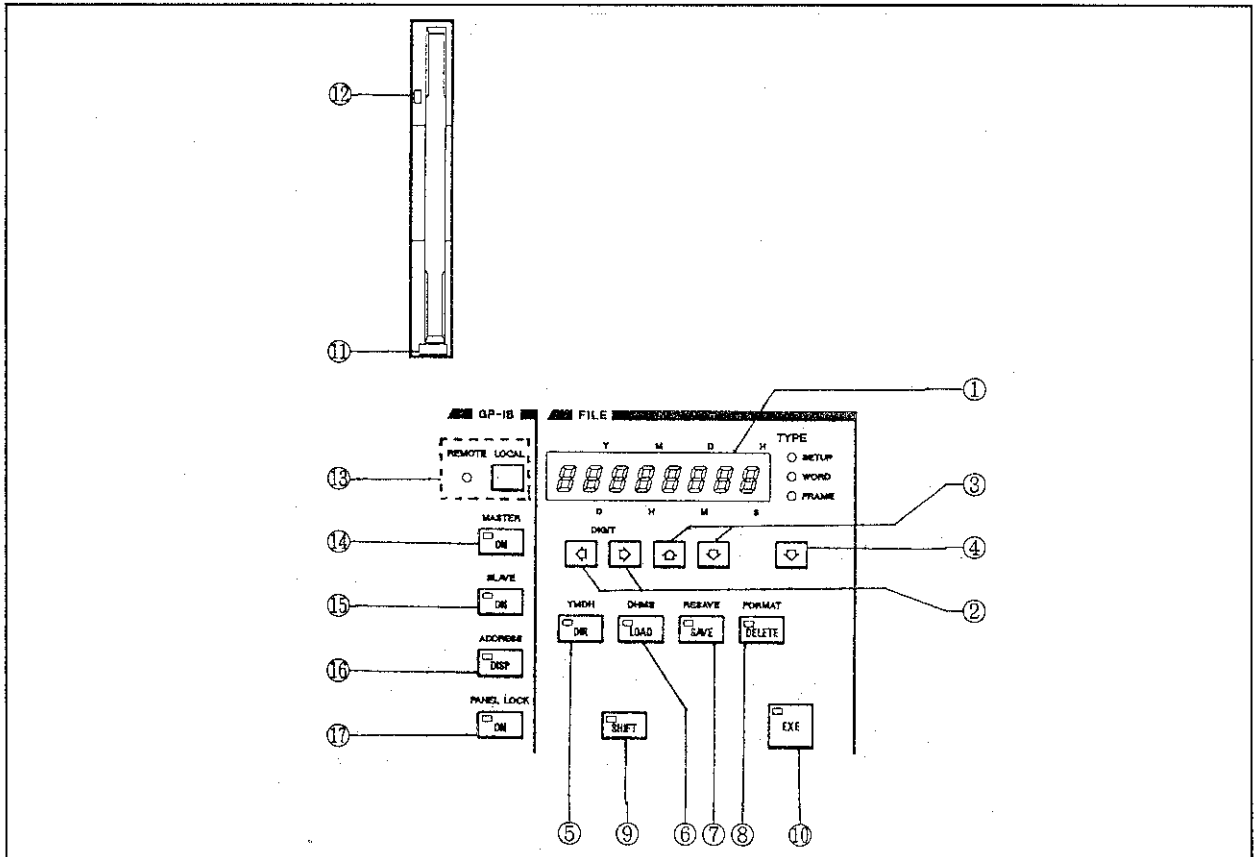



Figure 2-5 File/GPIB Control Section

- ⑨ SHIFT key key (  )  
Changes over functions of the above ⑤ and ⑧ keys.
- ⑩ EXE key (  )  
Executes the file operations or the date and time specified by above ⑤ to ⑨ keys.
- ⑪ Eject button  
The push-button to take out the floppy disk.
- ⑫ Access lamp  
Lights up when the floppy disk is being accessed.  
While this lamp is lighting, all keys in the file control section are disabled. Do not press the EJECT button while this lamp is lighting.

D3186  
PULSE PATTERN GENERATOR  
OPERATION MANUAL

2.1 Front Panel

---

(2) GPIB control section

⑬ REMOTE lamp and LOCAL key (  )

In remote mode, the REMOTE lamp lights up. Pressing the LOCAL key returns to local mode.

⑭ MASTER key (  )

Turn this key ON to use the master control function which interlocks the D3186 with the pattern setting section of the D3286 error detector.

⑮ SLAVE key (  )

Turn this key ON to use the slave control function which interlocks the pattern setting section of the D3186 with the D3286 error detector.

⑯ ADDRESS DISP key (  )

Turn this key ON to display the GPIB device address on the file number/date and time indicator ① to confirm or change the address.

⑰ PANEL LOCK key (  )

Turning this key ON disables all other keys and control volumes except the LOCAL key ⑬.

D3186  
**PULSE PATTERN GENERATOR**  
**OPERATION MANUAL**

2.1 Front Panel

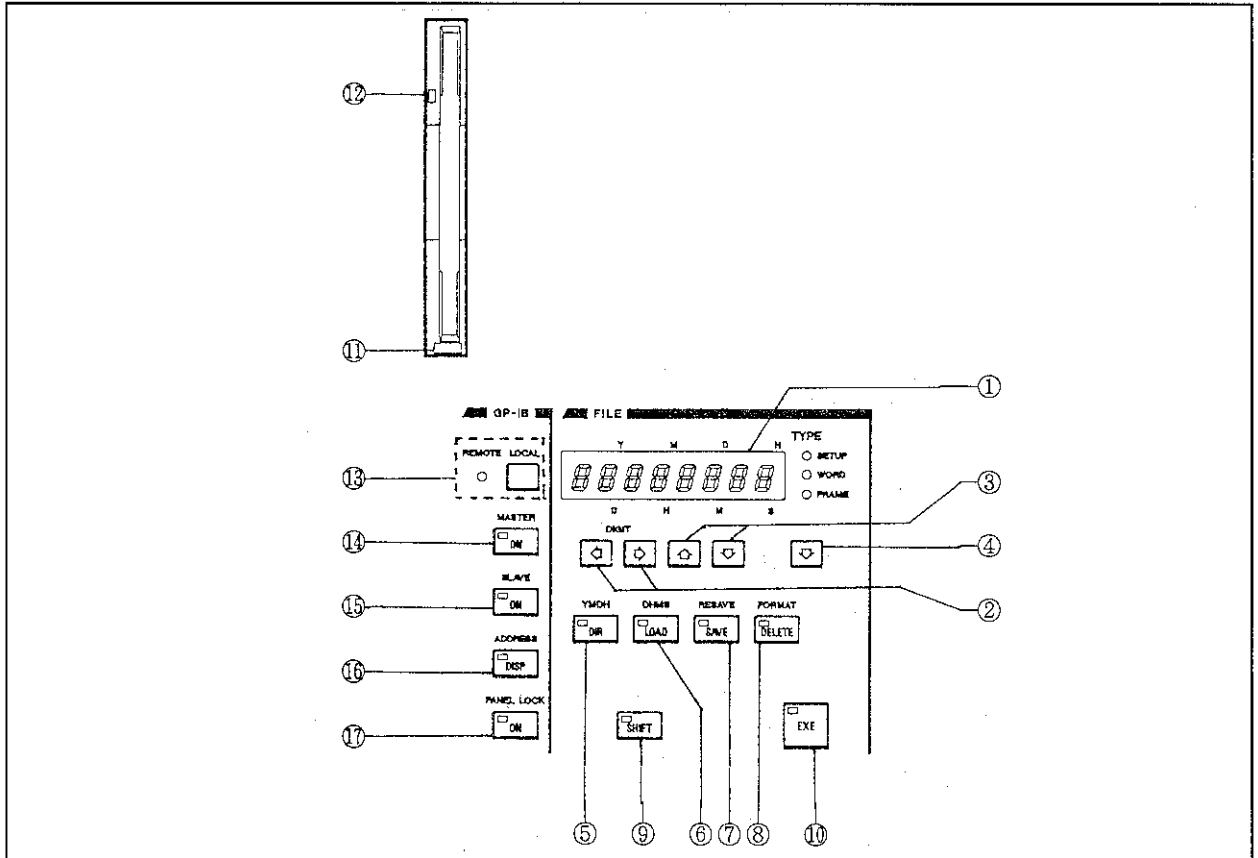

Figure 2-5 File/GPIB Control Section

## 2.2 Rear Panel

① ~ LINE inlet

The inlet for AC power line. Connect this to an AC receptacle by the attached power cable.

② BREAKER

Turns OFF if an excess current flows through the AC line.

③ Ground terminal

The terminal to ground the housing of this device.

④ GPIB (ONLY FOR SG) connector

Used to control the external clock signal generator from the D3186 through GPIB.

⑤ GPIB connector

Used to control the D3186 from a personal computer through GPIB or to use the master/slave function linking with D3286 error detector.

⑥ DIP switch SW1

Set to select additional functions of the device (see Table 3-11).

When the setting of this switch has been changed, turn the power once OFF, and turn the power ON again after 5 or more seconds.

⑦ EXT GATE INPUT connector

Used to externally input a gate signal to forbid DATA output.

⑧ EXT ALT INPUT connector

Used to externally changing over between pattern A and B in ALTERNATE pattern mode. To use this input terminal, set bit 1 of SW1 to ON (1) in above ⑥.

⑨ EXT ERR ADD INPUT connector

Used to externally input a signal to add a bit error to the output pattern.

To use this input terminal, set the ERROR ADDITION - EXT key -20 on the pattern setting section of the front panel to ON.

⑩ 1/2 CLOCK OUTPUT connector

Used to output a clock of half the frequency of CLOCK 1 output.



**D3186**  
**PULSE PATTERN GENERATOR**  
**OPERATION MANUAL**

**2.2 Rear Panel**

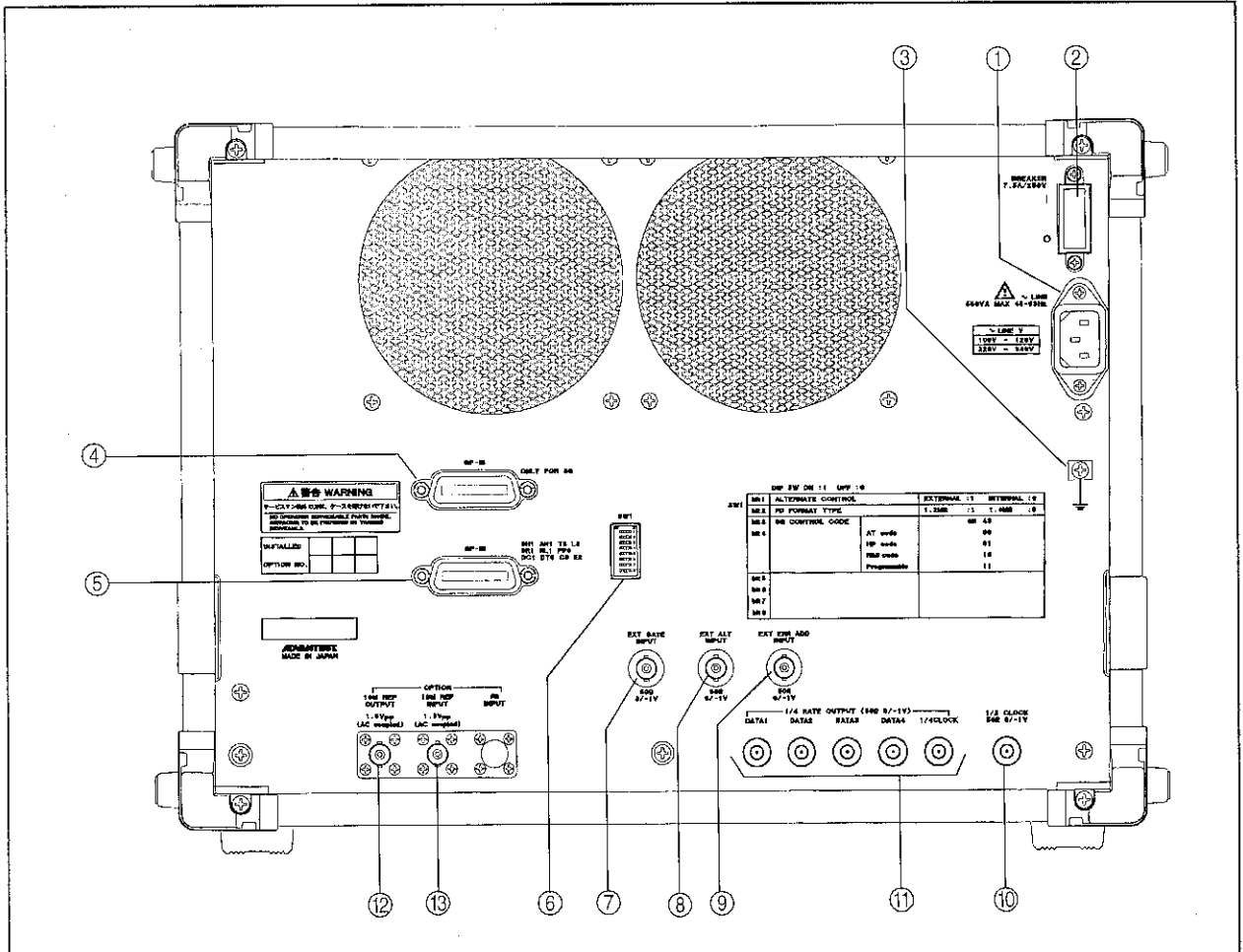

Figure 2-6 Rear Panel

- ⑪ 1/4 RATE OUTPUT connector  
Used to output 1/4 rate of DATA and CLOCK 1 output.
- ⑫ 10M REF OUTPUT connector (option)  
Used to output 10 MHz reference signal from the internal clock signal generator.
- ⑬ 10M REF INPUT connector (option)  
Used to input 10 MHz reference signal from the internal clock signal source.



### 3. OPERATION

#### 3.1 Power On

With the POWER switch (① in Figure 2-4) on the front panel turned OFF (by pressing the left side of the switch) and the breaker on the rear panel (② in Figure 2-6) turned ON (by pressing the "." mark side), connect the ~LINE inlet (① in Figure 2-6) on the rear panel to a receptacle using the attached power cable.

Turning the POWER switch ON turns on the power.

Avoid frequently turning ON/OFF the breaker, instead of the POWER switch, to turn on/off the power.

CAUTION

1. Supply voltage shall be within 90 to 132 VAC or 198 to 250 VAC, 48 to 63 Hz.  
The 100 V and 200 V power circuits are automatically changed over.
2. Because the device consumes maximum 550 VA power, use a power source with sufficient capacity.
3. Do not turn on the power with a disk including a file of the name shown below inserted in the floppy disk drive.  
If a disk with one of these files is inserted in the floppy disk drive at powering up, the device does not work correctly.  
File names: AUTOEXEC.BAT  
CONFIG.SYS  
RAMDISK.SYS  
SLOT.SYS

## 3.2 Operation on the Panel

### 3.2.1 Operation on the Front Panel

Followings are the explanation of how to operate each section on the front panel. Read the explanation referring to Figures 2-1 to 2-5.

#### (1) Frequency Setting Section

This section is used to set the frequency of the clock for operation.

Not only internal clock signal generator of the D3186 but also external clock signal generator, which is connected to the GPIB (ONLY FOR SG) connector on the rear panel (④ in Figure 2-2), can be controlled from this section.



The following item numbers correspond to those in Figure 2-2.

① Frequency (RATE) indicator

Indicates the current set clock frequency.



The frequency is indicated in 8 digits. The unit of the least significant digit is 1 kHz.



The frequency of 150,000 kHz (150 MHz) to 12,000,000 kHz (12 GHz) can be set.

② DIGIT key (  ,  )

Shifts the digit where the frequency of the internal clock is set.

What digit to set is shown by lighting the lamp on the upper left.



Press the  key to shift leftward the target digit, or press the  key to shift rightward.

Pressing  key shifts the target digit to rightmost when the lamp of the leftmost digits lights. Or, pressing  key shifts the target digit to leftmost when the lamp of the rightmost digits lights.

These keys are validated only when the EDIT key ⑤ is ON and the pointer is lighting.

③ Frequency setting key (  ,  )

Increments/decrements the value of the digits which is higher in order than that at which the pointer is lighting in the frequency indicator.

Press the  key or the  key to increment or decrement frequency.

Keeping the key pressing increments/decrements frequency sequentially.

These keys are validated only when the EDIT key ⑤ is ON and the pointer is lighting.

④ Frequency setting knob

Increments/decrements the value of the digits which is higher in order than that at which the pointer is lighting in the frequency indicator.

Turn the knob clockwise or counterclockwise to increment or decrement frequency.

These keys are validated only when the EDIT key ⑤ is ON and the pointer is lighting.

The speed of value change with this knob has limitation. To change the value speedy, move the pointer to the high-order digit.

⑤ EDIT key (  )

Turn ON this key to set frequency or to save the set frequency into a memory. Turn OFF this key to recall frequency from the memory.

Pressing this key turns ON or OFF alternately. When this key is ON, the lamp on the key lights up.

⑥ Memory number indicator



Up to 16 kinds of frequency value can be saved into the memory.



In this indicator, the memory number to be saved can be indicated in numerals of 0 to 9 and alphabets of A to F.

⑦ Memory number setting key (  ,  )

Sets the memory number.

The memory number can be set in 16 kinds of alphanumeric of 0 to 9 and A to F.

Press the  key or the  key to increment or decrement the memory number.

Pressing the  key sets 0 when the memory number is F. Or, pressing the  key sets F when it is 0.

Keeping the key pressing increments/decrements the memory number sequentially.

To recall the registered frequency, turn off the EDIT key ⑤ and set a memory number with this key.

To save the set frequency, turn on the EDIT key ⑤, set a memory number with key and press the STORE key ⑧.

⑧ STORE key (  )

Saves the set frequency into the memory.

Pressing this key, when the EDIT key ⑤ is ON, the frequency indicating on the frequency indicator ① is saved into the memory whose number is indicated on the memory number indicator.

## (2) Pattern Setting Section

The pattern setting section is used to set the pattern for output data.  
The D3186 has 3 types of pattern modes: PRBS, WORD and FRAME.  
Table 3-1 shows the combination of patterns which can be set.

Table 3-1 Combination of Patterns which can be Set



PATTERN MODE	PAYLOAD TYPE	PRBS column count (N) Pattern length: $2^N - 1$	PRBS MARK RATIO	2 PATTERNS ALTERNATE
PRBS	—	N = 7 to 31; 7 types	0/8 to 8/8; 8 types	OFF
WORD	—	—	—	ON/OFF
FRAME	WORD	—	—	ON/OFF
	PRBS	N = 15 to 31; 3 types	0/8 to 8/8; 8 types	ON/OFF
	CID	N = 7; 1 type	1/2; 1 type	OFF



Followings are the explanation of this section, in the order of the numbers in Figure 2-3.

- ① PATTERN MODE - PRBS key (  )

This key is used to change over pattern mode to pseudo random (PRBS).  
In pseudo random mode, the lamp on the key lights up.

- ② PRBS column count (N) select keys (  ,  ) and indicator

The number of PRBS columns is displayed by 2 digit 7-segment LED. 7 types are available: 7, 9, 10, 11, 15, 23 and 31 columns. Table 3-2 shows the generating function.  
Pressing  key increases the number of columns, while pressing  key decreases it.



Pressing  key when the number of columns is 31 returns to "7", while pressing  key while the number of columns is 7 returns to "31".

Keeping either of these keys pressed continuously increases/decreases the number of PRBS columns.

When pattern mode is set to WORD or FRAME, the column count indicator is blanked, disabling the modification of the setting. However, when pattern mode is FRAME and payload type is PRBS, only 3 types of columns (15, 23 and 31 columns) can be selected.



D3186  
PULSE PATTERN GENERATOR  
OPERATION MANUAL



3.2 Operation on the Panel

- ③ MARK RATIO select keys (  ,  ,  ) and 0/8, 1/8, 1/4, 1/2, 8/8, 7/8, 3/4 and 1/2B lamps

8 values of mark ratio (0/8, 1/8, 1/4, 1/2, 8/8, 7/8, 3/4 and 1/2B) can be selected, and the set value is displayed by the lamps arranged in 4 (horizontally) × 2 (upper and lower lines). The lamps of the upper line correspond to 0/8, 1/8, 1/4 and 1/2 from the leftmost one in order. The lamps of the lower line correspond to 8/8, 7/8, 3/4 and 1/2B which are the logical inversion of the patterns of the upper line.

 key selects a mark ratio of the upper line and that of the lower line alternately.

 key shifts the selected mark ratio leftwards, while  key rightwards.

Pressing  key when mark ratio is set to 0/8 or 8/8 changes to 1/2 or 1/2B. On the other hand, pressing  key when mark ratio is set to 1/2 or 1/2B changes to 0/8 or 8/8. When pattern mode is set to WORD or FRAME, all lamps are turned off, disabling the modification of the setting. However, when pattern mode is FRAME and payload type is PRBS, above mentioned 8 types can be selected.

- ④ ITU-T lamp

This lamp lights up when PRBS column count and mark ratio selected in above ② and ③ conform to the recommendation of ITU-T.

Table 3-2 shows the relation among PRBS pattern columns, generating function, mark ratio and applicable standard.

Table 3-2 PRBS Pattern Generating Function and Applicable Standard

Columns	Generating function	Mark ratio	Standard	ITU-T lamp
7	$X^7 + X^6 + 1$	1/2	ITU-T V.29	ON
		Other than 1/2		OFF
9	$X^9 + X^5 + 1$	1/2	ITU-T V.52	ON
		Other than 1/2		OFF
10	$X^{10} + X^7 + 1$	All		OFF
11	$X^{11} + X^9 + 1$	1/2	ITU-T 0.152	ON
		Other than 1/2		OFF
15	$X^{15} + X^{14} + 1$	1/2B	ITU-T 0.151	ON
		Other than 1/2B		OFF
23	$X^{23} + X^{18} + 1$	1/2B	ITU-T 0.151	ON
		Other than 1/2B		OFF
31	$X^{31} + X^{28} + 1$	All		OFF

D3186  
PULSE PATTERN GENERATOR  
OPERATION MANUAL

3.2 Operation on the Panel

⑤ PATTERN MODE - WORD key (  )

This key is used to change over pattern mode to WORD.

In WORD mode, the lamp on the key lights up.

In WORD mode, pattern length is set by the bits, and each bit can freely be set to 1 or 0.

The content of edited patterns is stored in the internal WORD pattern memory.

⑥ PATTERN MODE - FRAME key (  )

This key is used to change over pattern mode to FRAME.

In FRAME mode, the lamp on the key lights up.

In FRAME mode, 3 payload types (WORD, PRBS and CID) are available and selected with the PAYLOAD TYPE select key ⑩.

When payload type is WORD, all bits of pattern can freely be set. Frame structure is set by the number of frames, the number of rows per frame and the number of bytes per row as well as the number of bytes in the overhead part of a row.

The content of edited patterns is stored in the internal FRAME pattern memory.

The overhead part and frame structure of the FRAME pattern memory are the same as those when payload type is PRBS. Therefore, changing the content of pattern in the overhead part of either payload type equally changes that of another payload type.



When payload type is PRBS, the content of pattern only in the overhead part can freely be set or edited, and PRBS is set in the parts other than overhead (payload part). Like in WORD payload type, frame structure can be set by the number of frames, the number of rows per frame and the number of bytes per row as well as the number of bytes in the overhead part of a row. The number of PRBS columns is selected with the PRBS column count select key ② from 15, 23 and 31. Mark ratio can be changed.

The content of edited patterns in overhead part is stored in the internal FRAME pattern memory. The FRAME pattern memory and the frame structure are the same as those when payload type is WORD. Therefore, changing the content of pattern in the overhead part of either payload type equally changes that of another payload type.

Figure 3-1 shows the frame pattern structure when payload type is WORD or PRBS.

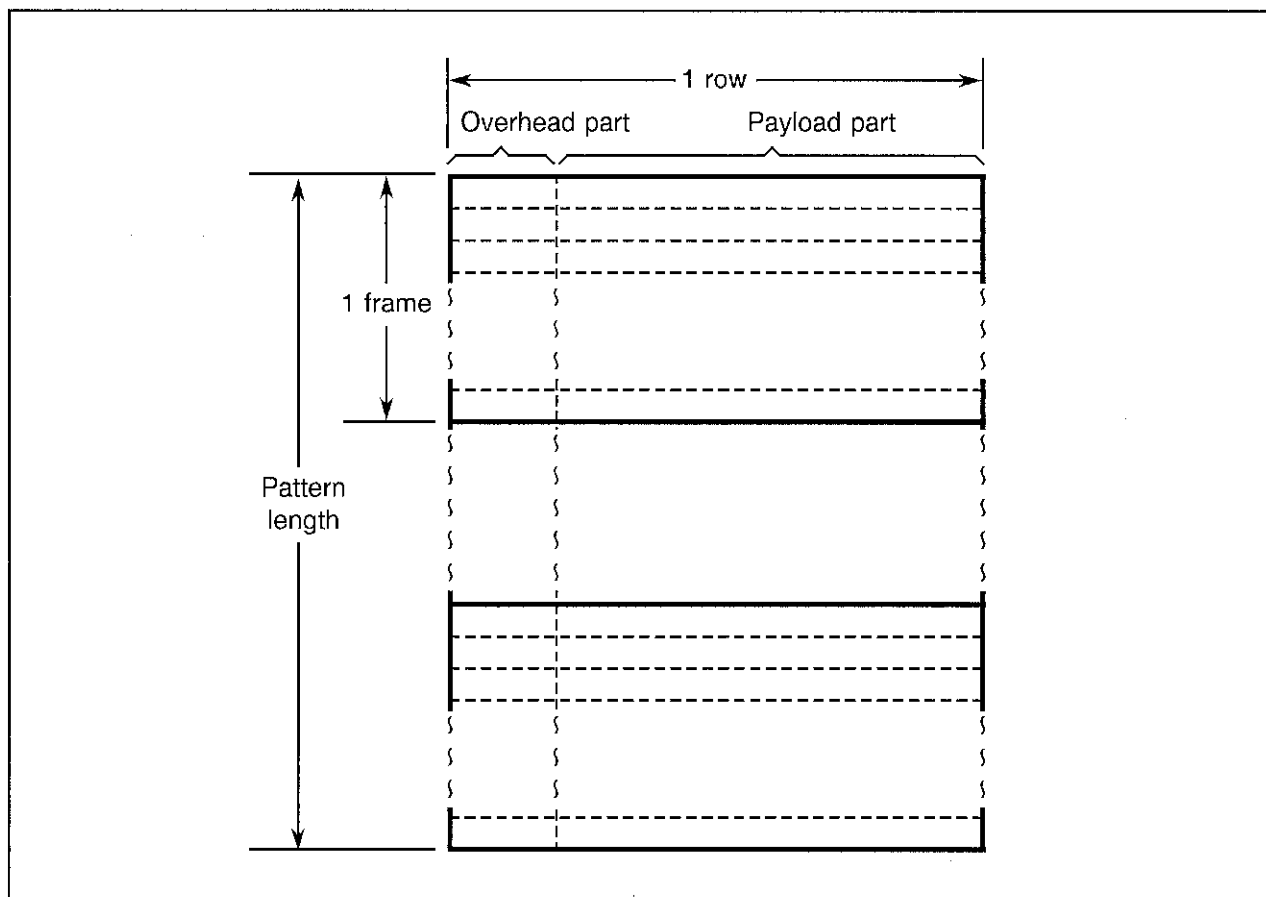

Figure 3-1 Frame Pattern when Payload Type is WORD or PRBS

When payload type is CID, pattern becomes that for same sign continuous resistance test. For frame structure, the number of frames is fixed to 2, and the number of rows per frame is fixed to 1. Therefore, setting is made only for the number of bytes per row, the number of bytes in the overhead part of a row, and the number of bits for continuous 0/1 patterns. In the overhead part, SOH pattern of the first row of SDH frame, namely frame synchronization bytes (A1 and A2), STM multiplex number (C1 byte) and national use bytes (X18 and X19), is set. And the pattern of the overhead part of all frames become the same.

In the payload part, continuous 0 or 1 pattern of specified length is set. 1 and 0 of the continuous pattern change alternately frame by frame.

For the remaining portion of the payload part, PRBS pattern of 7 columns and 1/2 mark ratio is set. When one row is longer than 1036 bytes, PRBS may be discontinuous at a frame boundary.

The content of pattern in each part is automatically set according to the frame structure, which cannot be edited.

Figure 3-2 shows the frame pattern when payload is CID.

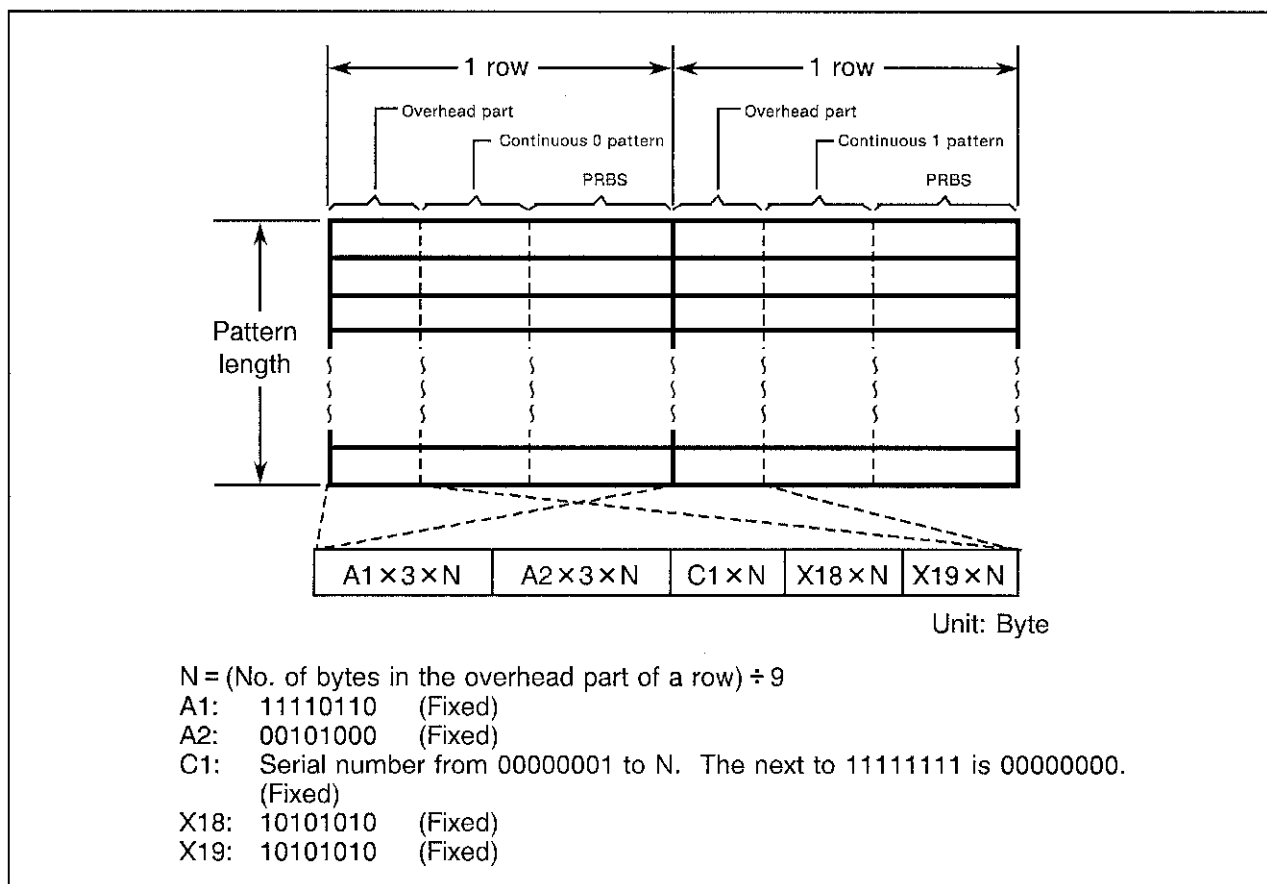

Figure 3-2 Frame Pattern when Payload Type is CID

⑦ ALTERNATE key (  )

Turn this key ON to use the ALTERNATE mode where measurement is made by changing over two (A and B) patterns.

Repeatedly pressing this key changes over ON/OFF state in order. When the key is turned ON, the lamp on the key lights up.

ALTERNATE mode can be turned ON only when pattern mode is WORD or when pattern mode is FRAME and payload type is WORD or PRBS.

Besides, the available pattern length of the entire WORD pattern or the available number of frames of the entire FRAME pattern differs with ON/OFF of ALTERNATE mode (see Tables 3-5 and 3-7).

If the set pattern length or frame count is invalid when ALTERNATE mode is turned ON, changing the state of ALTERNATE mode from OFF to ON sounds the alarm buzzer, displaying the following message on the pattern length/address indicator -15. And ALTERNATE mode will be kept OFF. In such a case, turn on ALTERNATE mode after modifying pattern length or frame count to a value which is valid when ALTERNATE mode is ON.

AL t d I 5 A b L E

⑧ A/B select key (  ) and A and B lamps

The key and lamps for changing over the pattern for output, conditions setting or editing between A and B in ALTERNATE mode. The control method for changing over between A and B patterns in ALTERNATE mode is set to INTERNAL or EXTERNAL by bit 1 (ALTERNATE CONTROL) of DIP switch SW1 (⑥ in Figure 2-6) on the rear panel (see Table 3-12). When the setting of this switch was modified, turn the power off once, and turn it on again after 5 or more seconds.

When ALTERNATE CONTROL is set to INTERNAL, pressing this key changes over A and B patterns alternately, and the corresponding lamp lights up.

When ALTERNATE CONTROL is set to EXTERNAL, in general, pattern A or B is selected according to the level of external input signal EXT ALT INPUT (⑪ in Figure 2-6). However, this key is enabled when the group select key ⑫ is set to PATT DAT and the EDIT key ⑬ is set to ON, changing over the pattern to output or edit between A and B, independent of the level of EXT ALT INPUT. And the corresponding lamp lights up.

Output pattern is changed over after pressing this key and outputting to the end of the previous pattern.

When ALTERNATE mode is turned OFF, this key is disabled, and A and B lamps are turned off.



⑨ EXT lamp



This lamp lights up when pattern is changed over according to the level of external input signal EXT ALT INPUT (⑧ in Figure 2-6) in ALTERNATE mode. External/internal change-over is made by bit 1 of DIP switch SW1 (⑥ in Figure 2-6) on the rear panel (see Table 3-12). When the setting of this switch was modified, turn the off power once, and turn it on again after 5 or more seconds.

⑩ PAYLOAD TYPE select keys (  ,  ) and WORD, PRBS and CID lamps

This key is used to select payload type when pattern mode is FRAME.

3 payload types are available: WORD, PRBS and CID. The lamp corresponding to the selected payload type lights up.

Pressing  key shifts the selected payload type leftwards, while pressing  key shifts rightwards.

Pressing  key when payload type is WORD changes to CID, while pressing  key when payload type is CID changes to WORD.

These keys are enabled when pattern mode is FRAME. In other modes, the 3 lamps are all turned off.

When payload type is WORD, all bits for the content of pattern can freely be set. For frame structure, the number of frames, the number of rows per frame and the number of bytes per row as well as the number of bytes in the overhead part of a row are set.

The content of edited patterns is stored in the FRAME pattern memory.

The overhead part and frame structure of the FRAME pattern memory are the same as those when payload type is PRBS. Therefore, changing the content of pattern in the overhead part of either payload type equally changes that of another payload type.

When payload type is PRBS, the content of pattern only in the overhead part can freely be set or edited, and PRBS is set in the parts other than overhead (payload part). Like in WORD payload type, frame structure can be set by the number of frames, the number of rows per frame and the number of bytes per row as well as the number of bytes in the overhead part of a row. The number of PRBS columns is selected with the PRBS column count select key ② from 15, 23 and 31. Mark ratio can be changed.

The content of edited patterns in overhead part is stored in the internal FRAME pattern memory. The FRAME pattern memory and the frame structure are the same as those when payload type is WORD. Therefore, changing the content of pattern in the overhead part of either payload type equally changes that of another payload type.

When payload type is CID, pattern becomes that for same sign continuous resistance test. For frame structure, the number of frames is fixed to 2, and the number of rows per frame is fixed to 1. Therefore, setting is made only for the number of bytes per row, the number of bytes in the overhead part of a row, and the number of bits for continuous 0/1 patterns. In the overhead part, SOH pattern of the first row of SDH frame, namely frame synchronization bytes (A1 and A2), STM multiplex number (C1 byte) and national use bytes (X18 and X19), is set. And the pattern of the overhead part of all frames become the same.

In the payload part, continuous 0 or 1 pattern of specified length is set. 1 and 0 of the continuous pattern changes alternately frame by frame.

For the remaining portion of the payload part, PRBS pattern of 7 columns and 1/2 mark ratio is set. When one row is longer than 1036 bytes, PRBS may be discontinuous at a frame boundary.

The content of pattern in each part is automatically set according to the frame structure, which cannot be edited.

Figures 3-1 and 3-2 show the frame pattern structure of each payload type.

- ⑪ POLARITY select key (  ) and NORMAL and INVERSE lamps

This key is used to select the polarity of the data pattern, which is output from the DATA OUTPUT connector (see Figure 2-4), when pattern mode is WORD or FRAME.

Polarity is either NORMAL or INVERSE, which are logically inverted each other.

Pressing the POLARITY key changes over the polarity.

In NORMAL mode, set patterns are output as they are, while in INVERSE mode output is made with inverted patterns. The pattern display lamp ⑩ shows a output pattern according to the polarity setting.

- ⑫ Group select keys (  ,  ) and lamp

This key selects a group of items to be displayed on the pattern length/address indicator ⑤.

3 groups are available: PATT TRIGGER, PATT DATA and FR STRUCT. The lamp corresponding to currently selected group lights up.

These group names are marked by abbreviation on the front panel. Their full names are:

PATT TRIGGER: PATTERN TRIGGER (pattern trigger output position)



PATT DATA: PATTERN DATA (pattern data edit position)

FR STRUCT: FRAME STRUCTURE

Which groups can be selected changes with the setting of pattern mode, as shown in Table 3-3.

Table 3-3 Available Groups in Each Pattern Mode

Pattern Mode	Available groups
PRBS	PATT TRIGGER only
WORD	PATT TRIGGER, PATT DATA
FRAME	PATT TRIGGER, PATT DATA, FR STRUCT

Pressing  key shifts the selected group upwards along the indication lamps, while pressing  key shifts downward.

Pressing  key when the uppermost group (PATT TRIGGER) is selected changes to the lowermost group (PATT DATA when pattern mode is WORD).

Pressing  key when the lowermost group is selected changes to the uppermost group.

PATT TRIGGER is used to set the position to output trigger signal to the TRIG OUTPUT connector (③ in Figure 2-4) with respect to the data pattern which is output from the DATA OUTPUT connector (⑧ in Figure 2-4) when the TRIG OUTPUT select key (② in Figure 2-4) of the output setting/connectors section is set to PATTERN.

PATT DATA is used to monitor or edit the content of data pattern.

FR STRUCT is used to set frame structure. Frame structure is the same when payload type is WORD or PRBS. Therefore, changing the frame structure of either payload type equally changes that of another payload type.

SYNC WORD is used to set the hunting pattern for pattern synchronization for the measuring section.

⑬ EDIT key (  )

Turn this key ON to change pattern length or frame configuration or to edit the content of pattern when pattern mode is WORD or FRAME.

Turning this key OFF disables the modification of pattern length or frame configuration or the editing of the content of pattern.

The conditions allowing turning on this key differ with pattern modes or the setting of the group select key ⑫ (see Table 3-4).

Under the conditions allowing turning on this key, ON/OFF state changes alternately each time the key is pressed. While the key is turned ON, the lamp on the key lights up, and the pointer for the display item lights up on the left of the number displayed on the pattern length/address indicator ⑮.

D3186  
PULSE PATTERN GENERATOR  
OPERATION MANUAL

3.2 Operation on the Panel

⑭ PATT BUSY lamp

While the content of pattern setting is being transferred to the data comparison pattern generating circuit, this lamp lights up.

The time required for the transfer is almost proportional to the length of pattern. The maximum is approximately 8 seconds.

While this lamp is lighting, data comparison pattern is undefined.

⑮ Pattern length/address indicator

This indicator displays pattern length, pattern address or byte number.

The display format differs with set pattern modes, payload types or which group of display items to select. Which item is displayed now is indicated by the lamp on the left.

Table 3-4 shows the items which can be displayed on this indicator and the pattern content display lamp ⑬, as well as the items which can be set.

When multiple items which can be set are displayed on this indicator, select one with the ITEM key ⑯.

The meaning of each display item in Table 3-4 is as follows:

PATTERN LENGTH (NO. OF BIT) . . . . .	Length of pattern (in bits)
ADDRESS . . . . .	1 address = 16 bits
NO. OF FRAME . . . . .	Number of frames of a whole pattern
NO. OF ROW . . . . .	Number of rows per frame
ROW LENGTH (NO. OF BYTE) . . . . .	Number of bytes per row
OVERHEAD LENGTH (NO. OF BYTE) . . . . .	Number of bytes of overhead part
0/1 LENGTH (NO. OF BIT) . . . . .	Number of bits for continuous 0/1 pattern
FRAME NO. . . . .	Frame number from the head of pattern
ROW NO. . . . .	Row number in a frame
BYTE NO. . . . .	Byte number in a row

Table 3-4 Pattern Display/Set Items (1 of 2)

PATTERN MODE	PAYLOAD TYPE	GROUP SELECT	EDIT	DISPLAY ITEMS (The item of boldface letter shows practicable set)
PRBS	—	PATT TRIGGER	OFF	PATTERN LENGTH, <b>ADDRESS</b> , CONTENT OF PATTERN
WORD	—	PATT TRIGGER	OFF	PATTERN LENGTH, <b>ADDRESS</b> , CONTENT OF PATTERN
		PATT DATA	OFF	PATTERN LENGTH, <b>ADDRESS</b> , CONTENT OF PATTERN
			ON	<b>PATTERN LENGTH, ADDRESS,</b> <b>CONTENT OF PATTERN</b>

D3186  
PULSE PATTERN GENERATOR  
OPERATION MANUAL

3.2 Operation on the Panel

Table 3-4 Pattern Display/Set Items (2 of 2)

PATTERN MODE	PAYLOAD TYPE	GROUP SELECT	EDIT	DISPLAY ITEMS (The item of boldface letter shows practicable set)
FRAME	WORD	PATT TRIGGER	OFF	<b>FRAME NO. , ROW NO. , BYTE NO. ,</b> CONTENT OF PATTERN
		PATT DATA	OFF	<b>FRAME NO. , ROW NO. , BYTE NO. ,</b> CONTENT OF PATTERN
			ON	<b>FRAME NO. , ROW NO. , BYTE NO. ,</b> <b>CONTENT OF PATTERN</b>
		FR STRUCT	OFF	NO. OF FRAME, NO. OF ROW, ROW LENGTH, OVERHEAD LENGTH
			ON	<b>NO. OF FRAME, NO. OF ROW,</b> <b>ROW LENGTH, OVERHEAD LENGTH</b>
		PRBS	PATT TRIGGER	OFF
	PATT DATA		OFF	<b>FRAME NO. , ROW NO. , BYTE NO. *3),</b> CONTENT OF PATTERN
			ON	<b>FRAME NO. , ROW NO. , BYTE NO. *3),</b> <b>CONTENT OF PATTERN</b>
	FR - STRUCT		OFF	NO. OF FRAME, NO. OF ROW, ROW LENGTH, OVERHEAD LENGTH
			ON	<b>NO. OF FRAME, NO. OF ROW,</b> <b>ROW LENGTH, OVERHEAD LENGTH</b>
	CID		PATT TRIGGER	OFF
		PATT DATA	OFF	<b>FRAME NO. , ROW NO. , BYTE NO. *4) ,</b> CONTENT OF PATTERN *2)
		FR - STRUCT	OFF	ROW LENGTH, OVERHEAD LENGTH, 0/1 LENGTH
			ON	<b>ROW LENGTH, OVERHEAD LENGTH,</b> <b>0/1 LENGTH</b>



- Note: \*1) When pattern mode is FRAME, payload type is PRBS, group selection is PATT TRIGGER, and byte number is within payload range, the content of pattern is not displayed.
- \*2) When pattern mode is FRAME, payload type is CID, group selection is PATT TRIGGER, and byte number is within the PRBS range of payload, the content of pattern is not displayed.
- \*3) When pattern mode is FRAME, payload type is PRBS, and group selection is PATT DATA, byte number cannot be set in payload range.
- \*4) When pattern mode is FRAME, payload type is CID, and group selection is PATT DATA, byte number cannot be set in the PRBS range of payload.



⑩ ITEM keys (  ,  )

This key is used to select the item to set from those displayed on the pattern length/address indicator ⑨.

Which items can be set differs with pattern modes or the setting of the group select key ⑫ (see Table 3-4).



When there is only one item which can be set, this key is disabled.

Which item to set is indicated by the pointer on the left of the number displayed.

Pressing  key shifts the set item leftwards, while pressing  key shifts rightwards.

Pressing  key when the leftmost item is selected shifts to the rightmost item.



Pressing  key when the rightmost item is selected shifts to the leftmost item.

⑪ DIGIT keys (  ,  )

These keys are used to shift the digit to set pattern length or address left- or rightwards.

Which items can be set differs with pattern modes or the setting of the group select key ⑫.

The digit to set is indicated by the pointer on the left of the number displayed.



Pressing  key shifts the digit to set leftwards, while pressing  key shifts rightwards.

Pressing  key when the leftmost digit is selected shifts to the right most digit.

Pressing  key when the rightmost digit is selected shifts to the left most digit.

D3186  
PULSE PATTERN GENERATOR  
OPERATION MANUAL

3.2 Operation on the Panel

⑮ Pattern length/address set keys (  ,  )

These keys are used to increment/decrement the digits which are higher in order than the digit at which the pointer is lighting on the pattern length/address indicator.

Pressing  key increment the number, while pressing  key decrement the number.

Keeping either key pressed continuously increment/decrement the number.

The setting range and step differ with which item to set, as follows:

(a) PATTERN LENGTH (NO. OF BIT)

This item is used to set the pattern length of a whole WORD pattern by the bits.

Pattern length of a whole WORD pattern can be set when pattern mode is WORD, the group select key ⑫ is set to PATT DATA, and the EDIT key ⑬ is turned ON. The setting range differs with ON/OFF state of the ALTERNATE key ⑦ (see Table 3-5).

Table 3-5 Setting Range and Step of Pattern Length of a Whole WORD Pattern

ALTERNATE	Range of pattern length (bits)	Step (bits)
OFF	1 to 32,768	1
	32,770 to 65,536	2
	65,540 to 131,072	4
	131,080 to 262,144	8
	262,160 to 524,288	16
	524,320 to 1,048,576	32
	1,048,640 to 2,097,152	64
	2,097,280 to 4,194,304	128
ON	4,194,560 to 8,388,608	256
	1 to 16,384	1
	16,386 to 32,768	2
	32,772 to 65,536	4
	65,544 to 131,072	8
	131,088 to 262,144	16
	262,176 to 524,288	32
	524,352 to 1,048,576	64
1,048,704 to 2,097,152	128	
2,097,408 to 4,194,304	256	

D3186  
PULSE PATTERN GENERATOR  
OPERATION MANUAL

3.2 Operation on the Panel

(b) ADDRESS

This item is used to set the address of a WORD or PRBS pattern.

1 address is made up of 16 bits.

Address is set when pattern mode is WORD and the group select key ⑫ is set to PATT TRIGGER or PATT DATA, or when pattern mode is FRAME and the group select key ⑫ is set to PATT TRIGGER.

The address setting range is as shown in Table 3-6. The setting step is 1 (address).

Table 3-6 Address Setting Range and Maximum Value

Pattern mode	Address setting range	Maximum value
WORD	0 to (Pattern length of a whole pattern) ÷ 16 - 1 (Raise the decimals to a unit.)	524287
PRBS	0 to $(2^N - 1) \div 16 - 1$ (N: Number of PRBS columns. Raise the decimals to a unit.)	134217727

For PATT TRIGGER, the address is the timing to output trigger signal to the TRIG OUTPUT connector (⑬ in Figure 2-4) when pattern mode is PRBS or WORD and the TRIG OUTPUT select key (⑭ in Figure 2-4) is set to PATTERN.

For PATT DATA, the address is that of the data pattern to monitor or edit when pattern mode is WORD.

**D3186**  
**PULSE PATTERN GENERATOR**  
**OPERATION MANUAL**

**3.2 Operation on the Panel**

(c) **NO. OF FRAME**

This item is used to set the number of frames of a whole FRAME pattern.

The number of frames is set when pattern mode is FRAME, the PAYLOAD TYPE key ⑩ is set to WORD or PRBS, and the group select key ⑫ is set to FR STRUCT. When PAYLOAD TYPE is CID, the number of frames is fixed to 2.

The setting range differs with ON/OFF state of the ALTERNATE key ⑦ or the setting of NO. OF ROW (the number of rows per frame) and ROW LENGTH (the number of bytes per row).

To set the number of frames at a value greater than the maximum value in Table 3-7, the number of rows per frame and the number of bytes per row must be set in advance.

Changing the setting of the number of rows per frame or the number of bytes per row initializes the number of frames to 1.

The setting step is 1 (frame).

Table 3-7 Maximum Available Number of Frames (NO. OF FRAME)  
(FS = ROW LENGTH (bytes) × NO. OF ROW)

ALTERNATE	FS	Maximum number of frames (fractions to be rounded down)
OFF	Integral multiple of 32	1,048,576 ÷ FS (8,192 or less)
	Integral multiple of 16	524,288 ÷ FS (4,096 or less)
	Integral multiple of 8	262,144 ÷ FS (2,048 or less)
	Other than integral multiple of 8	131,072 ÷ FS (1,024 or less)
ON	Integral multiple of 32	524,288 ÷ FS (4,096 or less)
	Integral multiple of 16	262,144 ÷ FS (2,048 or less)
	Integral multiple of 8	131,072 ÷ FS (1,024 or less)
	Other than integral multiple of 8	65,536 ÷ FS (512 or less)

Table 3-8 shows the maximum number of frames which can be set for representative STM-N frame (number of low lines is 9 per frame).

Table 3-8 Maximum Number of STM-N Frames which can be Set (NO. OF FRAME)  
(FS = ROW LENGTH (bytes) × NO. OF ROW)

STM multiplex number N	ROW LENGTH (bytes)	FS (bytes)	Maximum number of frames	
			ALTERNATE OFF	ALTERNATE ON
4	1,080	9,720	26	13
8	2,160	19,440	26	13
16	4,320	38,880	26	13
32	8,640	77,760	13	6
64	17,280	155,520	6	3

D3186  
PULSE PATTERN GENERATOR  
OPERATION MANUAL

3.2 Operation on the Panel

(d) NO. OF ROW

This item is used to set the length of one frame (the number of rows per frame) when pattern mode is FRAME.

The number of rows is set when pattern mode is FRAME, the PAYLOAD TYPE key ⑩ is set to WORD or PRBS, and the group select key ⑫ is set to FR STRUCT. When PAYLOAD TYPE is CID, the number of rows is fixed to 2.

The setting range and step is from 1 to 16 (rows) and 1 (row), respectively. Changing the setting of the number of rows per frame initializes the number of frames of the whole pattern to 1.

(e) ROW LENGTH (NO. OF BYTE)

This item is used to set the length of row (the number of bytes per row) when pattern mode is FRAME.

The length of row is set when pattern mode is FRAME and the group select key ⑫ is set to FR STRUCT.

The setting range differs with the setting of the PAYLOAD TYPE key ⑩ and ON/OFF state of the ALTERNATE key ⑦, as shown in Table 3-9.

Changing the setting of the length of row initializes the number of frames of the whole pattern to 1.

Table 3-9 Setting Range and Step of Row Length

PAYLOAD TYPE	ALTERNATE	Range of row length (bytes)	STEP (bytes)
WORD, PRBS	OFF	44 to 8,192	4
		8,200 to 16,384	8
		16,400 to 32,768	16
	ON	44 to 4,096	4
		4,104 to 8,192	8
		8,208 to 16,384	16
		16,416 to 32,768	32
CID	OFF	40 to 32,768	4

(f) OVERHEAD LENGTH (NO. OF BYTE)

This item is used to set the overhead length of a row (the number of bytes per row) when pattern mode is FRAME.

Overhead length is set when pattern mode is FRAME and the group select key ⑫ is set to FR STRUCT.

The setting range differs with the setting of the PAYLOAD TYPE key ⑩, as shown in Table 3-10.

Table 3-10 Setting Range and Step of Overhead Length

PAYLOAD TYPE	Range of overhead length (bytes)	STEP (bytes)
WORD, PRBS	4 to (Length of a row)-40 (maximum 32,728)	4
CID	36 to (Length of a row)-4 (maximum 32,760)	36

(g) 0/1 LENGTH (NO. OF BIT)

This item is used to set the length of continuous 0/1 pattern (the number of bits per row) when pattern mode is FRAME and the PAYLOAD TYPE key ⑩ is set to CID.

The length of continuous 0/1 pattern is set when pattern mode is FRAME, PAYLOAD TYPE is CID, and the group select key ⑫ is set to FR STRUCT.

The setting range is from 0 to {Length of a row (bytes) - Overhead length (bytes)} x 8 (bits) - 1 (bit), and the maximum length is (32,768 - 36) x 8 - 1 = 261,855 bits.

The setting step is 1 (bit).

(h) FRAME NO.

This item is used to set the frame number from the top of the FRAME pattern.

Frame number is set when pattern mode is FRAME, the group select key ⑫ is set to PATT TRIGGER or PATT DATA.

The setting range for frame number is from 1 to the number of frames of the whole set pattern (NO. OF FRAME), and the setting step is 1 (frame).

The frame number for PATT TRIGGER is the timing to output trigger signal to the TRIG OUTPUT connector (③ in Figure 2-4) when the TRIG OUTPUT select key (② in Figure 2-4) on the front panel is set to PATTERN.

For PATT DATA, the frame number is that for the data pattern to monitor or edit.

(i) ROW NO.

This item is used to set the row number from the top of a frame when pattern mode is FRAME.

Row number is set when pattern mode is FRAME, the PAYLOAD TYPE key ⑩ is set to WORD or PRBS, the group select key ⑫ is set to PATT TRIGGER or PATT DATA.

When PAYLOAD TYPE is CID, row number is fixed to 1 and cannot be changed.

The setting range for row number is from 1 to the number of rows per set frame (NO. OF ROW), and the setting step is 1 (row).

The row number for PATT TRIGGER is the timing to output trigger signal to the TRIG OUTPUT connector (③ in Figure 2-4) when the TRIG OUTPUT select key (② in Figure 2-4) on the front panel is set to PATTERN.

For PATT DATA, the row number is that for the data pattern to monitor or edit.

(j) BYTE NO.

This item is used to set the byte number from the top of a row when pattern mode is FRAME.

Byte number is set when pattern mode is FRAME, the group select key ⑫ is set to PATT TRIGGER or PATT DATA.

The byte number for PATT TRIGGER is the timing to output trigger signal to the TRIG OUTPUT connector (③ in Figure 2-4) when the TRIG OUTPUT select key (② in Figure 2-4) on the front panel is set to PATTERN.

The setting range for byte number is from 1 to the number of bytes per set row (ROW LENGTH) -1, and only odd number are available.

For PATT DATA, the byte number is that for the data pattern to monitor or edit. The setting range is from 1 to the number of bytes per set row (ROW LENGTH)-1, and only odd numbers are available.

However, when payload type is PRBS, byte number cannot be set in the payload range. Besides, when payload type is CID, byte number cannot be set in the PRBS range of payload.

⑱ PATTERN DATA lamp and 1st to 16th keys (  , ...,  )

This lamp shows the pattern for 16 bits of the address which is displayed on the pattern length/address indicator ⑮ when pattern mode is PRBS or WORD.

When pattern mode is FRAME, it shows the pattern for the 16 bits following the frame number (FRAME NO.), row number (ROW NO.) or byte number (BYTE NO.) displayed on the pattern length/address indicator ⑮.

This lamp is turned off when the group select key ⑫ is set to FR STRUCT, when the PAYLOAD TYPE key ⑩ is set to PRBS and the byte number is within the payload range, or when the payload type is CID and the byte number is within the PRBS range of payload. Lighting of the pattern display lamp means "logical 1" (the data output is HIGH). The 1st to 16th pattern set keys are enabled only when the group select key ⑫ is set to PATT DATA and the EDIT key ⑬ is turned ON. The status (logical 1 or 0) of the corresponding bit changes alternately, each time one of these keys is pressed.

When pattern mode is FRAME and the PAYLOAD TYPE key ⑩ is set to CID, the 1st to 16th pattern set key are disabled, and editing cannot be executed.

⑳ ERROR ADDITION setting section

The key is used to add a bit error to the output pattern, and the lamp shows the setting condition.

Three mode types are available for error addition: repeat mode, single mode and external mode.

Pressing the REPEAT key turns the repeat mode to ON or OFF and turns the other mode to OFF.

While the repeat mode is ON, the lamp on the REPEAT key lights up and errors are added at regular interval with  $1 \times 10^{-N}$  (N = 4 to 9) rate.

The error addition rate in the repeat mode can be set with the  key. The current set value.

Any lamp of 4 to 9, that is N in  $1 \times 10^{-N}$ , lights up to show what value is being set.

When the repeat mode is ON, pressing the  key increments N (the error addition rate decreases). When N is set to 9, pressing the  key changes N to 4.



**D3186**  
**PULSE PATTERN GENERATOR**  
**OPERATION MANUAL**

---

**3.2 Operation on the Panel**

Pressing once the SINGLE key adds a 1-bit error and turns the other modes than single mode to OFF. When the SINGLE key is pressed, the lamp on the key lights up for a moment.

Pressing the EXT key turns the external mode to ON or OFF and turns the other mode to OFF.

While the external mode is ON, the lamp on the key lights up and a 1-bit error is added for every reading edge of the pulse which is input to the EXT ERR ADD INPUT connector on the rear panel (⑨ in Figure 2-6). The input pulse should have level of 0/-1 V, repeated frequency of 1/64 or less of operation clock, both HIGH and LOW pulse widths of 20 ns or more, and rise/fall time of 10 ns or less.

Error is also added to the 1/4 RATE OUTPUT on the rear panel (⑩ in Figure 2-6) at any mode. In this case, however, error is added only to the DATA2 output but not added to DATA1, DATA3 and DATA4. In the repeat mode, errors of four-fold of the error addition rate are added to the DATA2 output.

### (3) Output setting/Connector section

The following item numbers correspond to those in Figure 2-4.

① POWER switch

This switch is used to turn ON/OFF the power of the D3186.

Pressing the right side of the switch turns ON the power. When the power is turned on, the device comes in ready state after all indicators and lamps on the panel light up for a certain period of time.

If pressing this switch does not turn on the power, check whether or not the breaker on the rear panel (② in Figure 2-6) is set to OFF.

② TRIGGER OUTPUT select key (  ) and 1/32 CLK and PATTERN lamps

The key and lamps for selecting which of 1/32 divided clock (1/32 CLK) signal and pattern synchronization (PATTERN) signal to output to the TRIGGER OUTPUT connector ③.

Each time this key pressed, output signal is changes over and the corresponding lamp lights up.

③ TRIGGER OUTPUT connector

This connector is used to output the trigger signal for observing waveform by oscilloscope. Which signal to output can be selected in above ②: 1/32 divided clock signal or pattern synchronization signal.

In observing data monitor output, triggering by 1/32 divided clock signal overlays waveforms to display an eye pattern, while triggering by pattern synchronization signal enables observing a given part of a period of the pattern by still image.

However, in observing the payload part of a pattern whose payload type is PRBS and whose pattern mode is FRAME, eye pattern is observed even when triggered by pattern synchronization signal.

To change the pattern synchronization signal generating position, select PATT TRIGGER with the group select key (  ) ⑫ in the pattern setting section (see Figure 2-3) and set an address number with the DIGIT key (  ,  ) ⑬ and the pattern length/address set keys (  ,  ) ⑭ when pattern mode is PRBS or WORD.

When pattern mode is FRAME, select a set item from FRAME NO., ROW NO. and BYTE NO. with the ITEM key (  ,  ) ⑮, and set a frame number, row number or byte row number or byte number with the DIGIT key (  ,  ) ⑬ and the pattern length/address set keys (  ,  ) ⑭. Only odd number is available for byte number.

Incrementing/decrement address number by 1 or byte number by 2 corresponds to the change in pattern synchronization generating position by  $\pm 16$  bits.

D3186  
PULSE PATTERN GENERATOR  
OPERATION MANUAL

3.2 Operation on the Panel

---

When the pattern is long, such as PRBS 23 columns or more, the period of pattern synchronization signal becomes long, resulting in less number of triggering operations on the oscilloscope. Thus the observed waveform becomes weaker in intensity. In such a case, make the oscilloscope display time (or persist time) longer.

The level of this trigger signal is approximately 0 V/-1 V. The load shall be terminated at 0 V by 50  $\Omega$  resistance.

④ CLOCK INPUT connector

Inputs oscillation clock for operation. Input the internal clock or the external clock which is being output to the CLOCK OUTPUT connector ⑤.

The clock frequency input to this connector is the same as the clock frequency output to CLOCK1, CLOCK1 OUTPUT ⑦ and CLOCK2 OUTPUT ⑥ connectors and as the data rate output to DATA, DATA OUTPUT ⑧ connector.

The clock input shall be terminated at 0 V by 50  $\Omega$  resistance. Input a sine wave with amplitude of 0.7 Vp-p to 1.5 Vp-p.

⑤ CLOCK OUTPUT connector

Outputs the internal clock. To use the internal clock as an oscillation clock for operation, connect this connector with the CLOCK INPUT connector ④ by using the attached SMA-SMA coaxial cable.

This clock output has the impedance that is AC-coupled by 50  $\Omega$  resistance. This clock output is a rectangular wave with amplitude of about 1 Vp-p.

⑥ CLOCK2 OUTPUT connector

Outputs a clock whose amplitude, offset and delay are fixed.

This clock output has the impedance that is AC-coupled by 50  $\Omega$  resistance. This clock output is a rectangular wave with amplitude of about 1 Vp-p.

⑦ CLOCK1, CLOCK1, OUTPUT connector

Outputs the DC-coupled clocks. CLOCK1 is the reversed output of CLOCK1.

Amplitude, offset, output mode, duty rate and delay can be changed by using the key/knob of ⑮, ⑭, ⑨, ⑯ and ⑲ respectively.

The output impedance is about 50  $\Omega$ .

⑧ DATA,  $\overline{\text{DATA}}$  OUTPUT connector

Outputs the set patterns in NRZ.  $\overline{\text{DATA}}$  is the reversed output of DATA.

Amplitude, offset, output mode and cross point position can be changed by using the key/knob of ⑫, ⑬, ⑭ and ⑮ respectively.

The changed point of data is the same as the trailing point of CLOCK1 ⑦ when the delay of ⑯ is set to 0.

The output impedance is about 50  $\Omega$ .

⑨ CLOCK1,  $\overline{\text{CLOCK1}}$ , OUTPUT setting section

Keys and lamps that are used to change the termination conditions of CLOCK1 and  $\overline{\text{CLOCK1}}$  OUTPUT.

Pressing AC, TO -2V or TO 0V key sets the termination condition of either CLOCK1 or  $\overline{\text{CLOCK1}}$  OUTPUT whose active channel lamp ⑫ is lit.

If the tracking of ⑬ is ON, the termination conditions of  $\overline{\text{CLOCK1}}$  is set as same as that of CLOCK1.

AC: This key is used when the load is AC-coupled and the signal line is not terminated in DC with GND (0 V) at 50  $\Omega$  resistance.

When this mode is selected, the offset of ⑭ is indicated as AC and the tolerance of the amplitude is set to 0.5 Vp-p to 2 Vp-p.

TO -2V: This key is used when the load is terminated at -2 V by 50  $\Omega$  resistance.

When this mode is selected, the tolerance of the offset (high level) becomes -1 V to -6V and that of the amplitude becomes 0.6 Vp-p to 1 Vp-p.

TO 0V: This key is used when the load is terminated at GND (0 V) by 50  $\Omega$  resistance.

When this mode is selected, the tolerance of the offset (high level) becomes +2 V to -2V and that of the amplitude becomes 0.5 Vp-p to 2 Vp-p.

The set value of the amplitude is common between AC mode and TO 0V mode. However, the other set values of offset and amplitude are individually saved for each termination condition.

⑩ DATA,  $\overline{\text{DATA}}$  OUTPUT MODE setting section

Keys and lamps that are used to change the termination conditions of DATA and  $\overline{\text{DATA}}$  OUTPUT.

Pressing AC, TO -2V or TO 0V key sets the termination condition of either DATA or  $\overline{\text{DATA}}$  OUTPUT whose active channel selector lamp ⑩ is lit.

If the tracking of ⑩ is ON, the same termination conditions are set to DATA and  $\overline{\text{DATA}}$ .

AC: This key is used when the load is AC-coupled and the signal line is not terminated in DC at GND (0 V) by 50  $\Omega$  resistance.

When this mode is selected, the offset of ⑪ is indicated as AC and the tolerance of the amplitude is set to 0.5 Vp-p to 2 Vp-p.

TO -2V: This key is used when the load is terminated at -2 V by 50  $\Omega$  resistance.

When this mode is selected, the tolerance of the offset (high level) becomes -1 V to -6V and that of the amplitude becomes 0.6 Vp-p to 1 Vp-p.

TO 0V: This key is used when the load is terminated at GND (0 V) by 50  $\Omega$  resistance.

When this mode is selected, the tolerance of the offset (high level) becomes +2 V to -2V and that of the amplitude becomes 0.5 Vp-p to 2 Vp-p.

The set value of the amplitude is common between AC mode and TO 0V mode. However, the other set values of offset and amplitude are individually saved for each termination condition.

D3186  
PULSE PATTERN GENERATOR  
OPERATION MANUAL

3.2 Operation on the Panel

- ⑪ CLOCK1,  $\overline{\text{CLOCK1}}$  OFFSET MODE select key (  ) and HIGH, MIDDLE, LOW lamp

Used to select the offset level of CLOCK1 and  $\overline{\text{CLOCK1}}$  OUTPUT from among top (HIGH), middle (MIDDLE) and bottom (LOW) of the waveform.

Pressing this key changes the offset mode of either CLOCK1 or  $\overline{\text{CLOCK1}}$  whose active channel lamp ⑫ is lit.

If the tracking of ⑬ is ON, the same offset mode is set to CLOCK1 and  $\overline{\text{CLOCK1}}$ .

When the offset mode is changed, the offset setting is calculated according to the amplitude which has been set.

$$\begin{aligned} \text{OFFSET (HIGH)} &= \text{OFFSET (MIDDLE)} + \text{amplitude} \div 2 \\ &= \text{OFFSET (LOW)} + \text{amplitude} \\ \text{OFFSET (MIDDLE)} &= \text{OFFSET (HIGH)} - \text{amplitude} \div 2 \\ &= \text{OFFSET (LOW)} + \text{amplitude} \div 2 \\ \text{OFFSET (LOW)} &= \text{OFFSET (HIGH)} - \text{amplitude} \\ &= \text{OFFSET (MIDDLE)} - \text{amplitude} \div 2 \end{aligned}$$

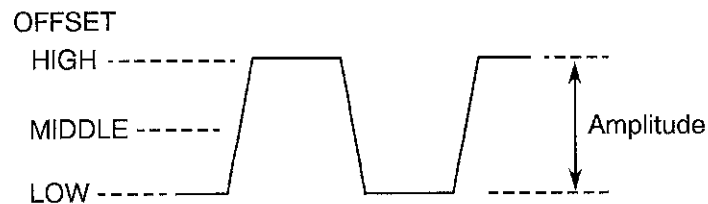

- ⑫ CLOCK1/ $\overline{\text{CLOCK1}}$  ACTIVE CHANNEL key (  ) and CLOCK,  $\overline{\text{CLOCK1}}$  lamp

Keys and lamps used to set amplitude, offset, offset mode, and termination condition of either CLOCK1 or  $\overline{\text{CLOCK1}}$  OUTPUT.

Pressing this key changes the active channel to CLOCK1 or  $\overline{\text{CLOCK1}}$  by turns. The lamp of the current activated channel is lit.

When the tracking of ⑬ is ON, this key is invalidated and both lamps of CLOCK1 and  $\overline{\text{CLOCK1}}$  are lit.

- ⑬ CLOCK1,  $\overline{\text{CLOCK1}}$  TRACKING key (  )

Used to change the tracking ON or OFF which sets amplitude, offset, offset mode and termination condition of CLOCK1 and  $\overline{\text{CLOCK1}}$  OUTPUT to the same or individual.

Pressing this key changes the tracking ON or OFF by turns. When the tracking is ON, the keylamp goes on.

When the tracking is changed from OFF to ON, the same setting value as CLOCK1 or  $\overline{\text{CLOCK1}}$  which has been activated just before the change is set to the other one.

Just after the tracking is changed from OFF to ON, both channel settings are the same.

⑭ CLOCK1, CLOCK1 OFFSET setting section

Knob and indicator used to set offset of CLOCK1 and CLOCK1 OUTPUT.

The offset of either CLOCK1 or CLOCK1 whose active channel lamp ⑫ is lit is indicated on this indicator. Turning the knob changes the offset value.

When the tracking ⑬ is ON, CLOCK1 and CLOCK1 are set in the same offset.

Turning left the knob decreases the offset and turning right the knob increases that.

The setting range differs according to the settings of the termination condition and the offset mode (see Table 3-11). The resolution is 10 mV in any case.

When the termination condition is set to AC, **A C** is indicated on the offset indicator.

The offset settings are individually saved for each termination condition.

Table 3-11 Offset Setting Range

Termination condition	OFFSET mode	Offset setting range
AC	—	Cannot be set (automatic)
TO -2V	HIGH	-1.00 V to -0.60 V
	MIDDLE	-1.00 V - amplitude ÷ 2 to -0.60 V - amplitude ÷ 2
	LOW	-1.00 V - amplitude to -0.60 V - amplitude
TO 0V	HIGH	-2.00 V to +2.00 V
	MIDDLE	-2.00 V - amplitude ÷ 2 to +2.00 V - amplitude ÷ 2
	LOW	-2.00 V - amplitude to +2.00 V - amplitude

⑮ CLOCK1, CLOCK1 AMPLITUDE setting section

Knob and indicator used to set amplitude of CLOCK1 and CLOCK1 OUTPUT.

The amplitude of either CLOCK1 or CLOCK1 whose active channel lamp ⑫ is lit is indicated on this indicator. Turning the knob changes the amplitude value.

When the tracking ⑬ is ON, CLOCK1 and CLOCK1 are set in the same amplitude.

Turning left the knob decreases the offset and turning right the knob increases that.

Turning left the knob decreases the amplitude and turning right the knob increases that.

The allowable range is 0.50 Vp-p to 2.00 Vp-p at the termination condition of TO 0 V and AC or is 0.60 Vp-p to 1.00 Vp-p at TO -2 V. The resolution is 10 mV in any case. The amplitude value in AC mode and TO 0 V mode is the same, but that in the other condition is individually saved for each termination condition.

⑯ DUTY ADJ section

Used to adjust the duty rate of CLOCK1 and  $\overline{\text{CLOCK1}}$  OUTPUT.

ON/OFF key and adjustment knob are provided for CLOCK1 and  $\overline{\text{CLOCK1}}$  each .

Pressing this key turns ON or OFF the duty rate adjustment by turns. When the key is ON, the keylamp goes on.

When the key is ON, the adjustment knob is validated. While OFF, the duty rate is set to the standard state (about 50%).

⑰ DATA,  $\overline{\text{DATA}}$  OFFSET MODE select key(  ) and HIGH, MIDDLE, LOW lamp

Used to select the offset level of DATA and  $\overline{\text{DATA}}$  OUTPUT ⑳ from among top (HIGH), middle (MIDDLE) and bottom (LOW) of the waveform.

Pressing this key changes the offset mode of either DATA or  $\overline{\text{DATA}}$  whose active channel lamp ⑱ is lit.

If the tracking of ⑱ is ON, the same offset mode is set to DATA and  $\overline{\text{DATA}}$ .

When the offset mode is changed, the offset setting is calculated according to the amplitude which has been set.

$$\begin{aligned} \text{OFFSET (HIGH)} &= \text{OFFSET (MIDDLE)} + \text{amplitude} \div 2 \\ &= \text{OFFSET (LOW)} + \text{amplitude} \\ \text{OFFSET (MIDDLE)} &= \text{OFFSET (HIGH)} - \text{amplitude} \div 2 \\ &= \text{OFFSET (LOW)} + \text{amplitude} \div 2 \\ \text{OFFSET (LOW)} &= \text{OFFSET (HIGH)} - \text{amplitude} \\ &= \text{OFFSET (MIDDLE)} - \text{amplitude} \div 2 \end{aligned}$$

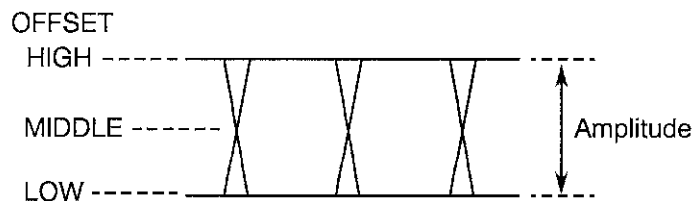

⑱ DATA/ $\overline{\text{DATA}}$  ACTIVE CHANNEL key (  ) and DATA,  $\overline{\text{DATA}}$  lamp

Keys and lamps used to set amplitude, offset, offset mode, and termination condition of either DATA or  $\overline{\text{DATA}}$  OUTPUT.

Pressing this key changes the active channel to DATA or  $\overline{\text{DATA}}$  by turns. The lamp of the current activated channel is lit.

When the tracking of ⑱ is ON, this key is invalidated and both lamps of DATA and  $\overline{\text{DATA}}$  are lit.



⑮ DATA,  $\overline{\text{DATA}}$  TRACKING key (  )

Used to change the tracking ON or OFF which sets amplitude, offset, offset mode and termination condition of DATA and  $\overline{\text{DATA}}$  OUTPUT to the same or individual.

Pressing this key changes the tracking ON or OFF by turns. When the tracking is ON, the keylamp goes on.

When the tracking is changed from OFF to ON, the same setting value as DATA or  $\overline{\text{DATA}}$  which has been activated just before the change is set to the other one.

Just after the tracking is changed from OFF to ON, both channel settings are the same.

⑯ DATA,  $\overline{\text{DATA}}$  OFFSET setting section

Knob and indicator used to set offset of DATA and  $\overline{\text{DATA}}$  OUTPUT.

The offset of either DATA or  $\overline{\text{DATA}}$  whose active channel lamp ⑮ is lit is indicated on this indicator. Turning the knob changes the offset value.

When the tracking ⑮ is ON, DATA and  $\overline{\text{DATA}}$  are set in the same offset.

Turning left the knob decreases the offset and turning right the knob increases that. The setting range differs according to the settings of the termination condition and the offset mode (see Table 3-11). The resolution is 10 mV in any case.

When the termination condition is set to AC. **AC** is indicated on the offset indicator.

The offset settings are individually saved for each termination condition.

⑰ DATA,  $\overline{\text{DATA}}$  AMPLITUDE setting section

Knob and indicator used to set amplitude of DATA and  $\overline{\text{DATA}}$  OUTPUT.

The amplitude of either DATA or  $\overline{\text{DATA}}$  whose active channel lamp ⑮ is lit is indicated on this indicator. Turning the knob changes the amplitude value.

When the tracking ⑮ is ON, DATA and  $\overline{\text{DATA}}$  are set in the same amplitude.

Turning left the knob decreases the amplitude and turning right the knob increases that. The allowable range is 0.50 Vp-p to 2.00 Vp-p at the termination condition of TO 0 V and AC or is 0.60 Vp-p to 1.00 Vp-p at TO -2V. The resolution is 10 mV in any case. The amplitude value in AC mode and TO 0 V mode is the same, but that in the other condition are individually saved for each termination condition.

D3186  
PULSE PATTERN GENERATOR  
OPERATION MANUAL

3.2 Operation on the Panel

---

⑳ C - P ADJ section

Used to adjust the cross point position of DATA and  $\overline{\text{DATA}}$  OUTPUT.

ON/OFF key and adjustment knob are provided for DATA and  $\overline{\text{DATA}}$  each .

Pressing this key turns ON or OFF the cross point adjustment by turns. When the key is ON, the keylamp goes on.

When the key is ON, the adjustment knob is validated. While OFF, the cross point is set to the standard position (almost center of the amplitude).

㉑ DELAY setting section

This section includes the volume for controlling the delay time of clock (CLOCK1 and  $\overline{\text{CLOCK1}}$ ) output against data (DATA and  $\overline{\text{DATA}}$ ) output and an indicator.

The delay of  $\overline{\text{CLOCK1}}$  is changed together with that of CLOCK1.

To change the delay, the motor driven trombone type delay line is used.

Setting range is -400 ps to +400 ps, and resolution is 1 ps.

Turning this volume counterclockwise decreases the delay, resulting in faster timing of the internal clock. Turning it clockwise increases the delay, resulting in slower timing.

The motor starts approximately 0.2 second after turning the volume. While the motor is running, the BUSY lamp at upper left lights up.

When delay error exceeds the permissible limit, the system automatically enters the self

calibration routine with " C A L " displayed on the indicator. This routine ends within 12 seconds at longest. While this routine is activated, all keys on the panel are disabled.

㉒ OUTPUT key (  )

This key is used to turn the data (DATA and  $\overline{\text{DATA}}$ ) output to ON or OFF.

Every time pressing this key turns ON and OFF. When ON is set, the keylamp goes on.

When the key is OFF, both DATA output and  $\overline{\text{DATA}}$  output are set to the terminator voltage level.

(4) File/GPIB operation section

The following explanation follows the sequential order in Figure 2-5.

(4-1) File operation section

The D3186 with an integrated 3.5" floppy disk drive can save/read the set operating conditions and pattern settings to/from floppy disk.

The floppy disk is formatted MS-DOS® Rev. 4.0; 720 KB (2DD), 1.2 MB (2HD), or 1.4 MB (2HD). The disk type is automatically identified, except for 2HD-type disk formatting (FORMAT).

This section has calendar/clock function. "Year, month, day and hour" or "day, hour, minute and second" can be displayed.

◆ MS-DOS is a registered trademark of Microsoft Corporation, U.S.A.

① File No./date and time indicator

Displays file No. or date and time according to key settings of ④ to ⑨. Displays GPIB device address when the ADDRESS DISP key ⑩ is ON.

File No. display format:

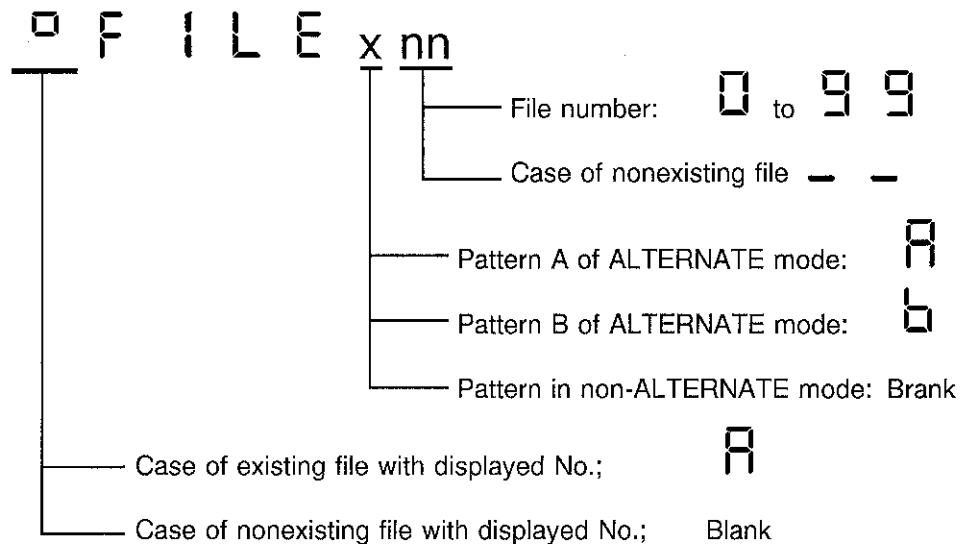

D3186  
PULSE PATTERN GENERATOR  
OPERATION MANUAL

3.2 Operation on the Panel

Date and time (YMDH) display format :

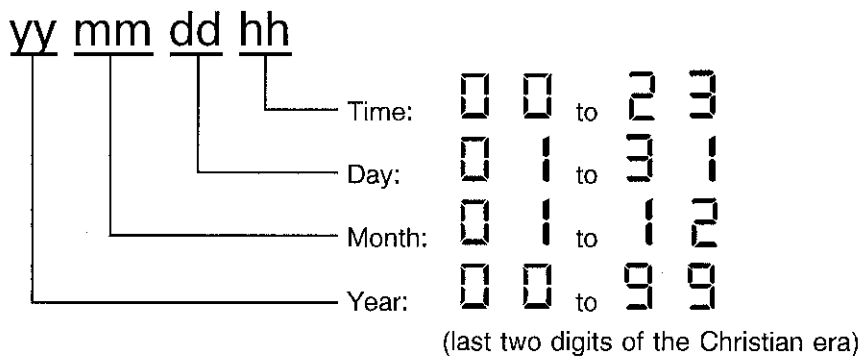

Date and time (DHMS) display format :

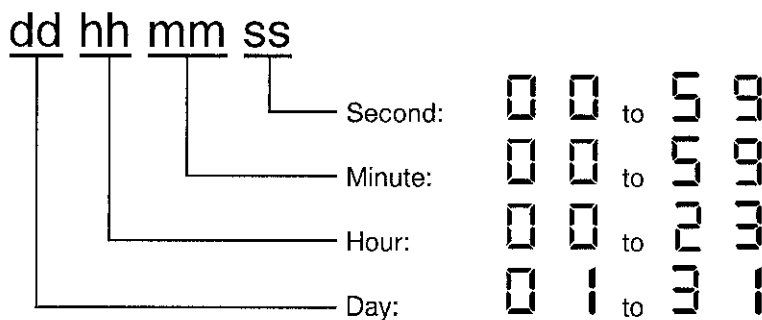

GPIB device address display format:

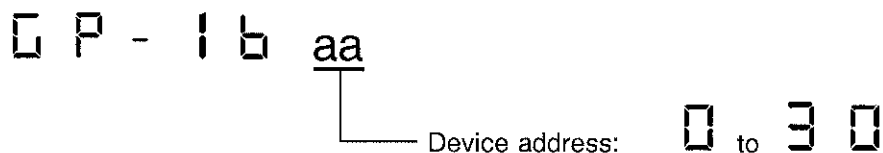



② DIGIT keys ( , )



Moves the digit pointer to set file No., date and time or GPIB address (changes the digit at which the pointer is lit).

Press key to move the pointer to the left and key to the right.

These keys are active only while the pointer is lit.

③ File No. setup keys (  ,  )

Increments/decrements a digit value higher than the one at which the pointer is lit on file No./date and time indicator.

Press  key to increment the value and  key to decrement. Sets GPIB device address while address display key 16) is ON.

These keys are active only while the pointer is lit.

④ File type setup key (  ) and SETUP, WORD, FRAME, MEAS lamp

Changes the type of file for DIR, LOAD, SAVE, RESAVE or DELETE to the general setting (SETUP), word pattern setting (WORD), frame pattern setting (FRAME); the corresponding SETUP, WORD, FRAME lamp is lit.

Pressing the  key sequentially changes the above file type.

⑤ DIR/YMDHkey (  )

Displays the directory or YMDH on file No. /date and time indicator. When the SHIFT key ⑨ is OFF (keylamp is not lit), the date and time is displayed.

- To display the directory, use the following procedure:

1. Insert a floppy disk with data into the drive.
2. Select type of a file to display using file type setup key ④.
3. Check the SHIFT key ⑨ is OFF. If ON, press to set to OFF.
4. Press DIR/YMDH key ⑤, the keylamp goes on.  
(If the SHIFT key is turned on in the middle of the operation. YMDH display is made.)
5. Press EXE key ⑩ to display on the file No./date and time indicator ① the lowest file No. of the specified file type existing on disk.
6. Subsequently, the displayed file No. can be sequentially changed with DIGIT key ② and file No./date and time setup key ③.

Note: Only files in the root directory can be displayed.

D3186  
PULSE PATTERN GENERATOR  
OPERATION MANUAL

3.2 Operation on the Panel

- To display the date and time, use the following procedure:
  1. Press the SHIFT key ⑨ to set the key ON.
  2. Pressing the DIR/YMDH key ⑤ (keylamp is lit) displays the current date and time (YMDH) on the file No./date and time indicator.  
(If the SHIFT key is turned off in the middle of the operation, directory display is made.)
  3. To set or change the displayed date and time, press the EXE key ⑩ to light the pointer of the file No./date and time indicator.
  4. Enter the date and time with the DIGIT key ② and the file No./date and time setting key, and then press the EXE key. The pointer goes off to show the end of setting.

⑥ LOAD/DHMS key (  )

Specifies file reading or displays date and time (DHMS).

When the SHIFT key ⑨ is OFF (keylamp is not lit), file can be loaded. Or, when the SHIFT key is ON (keylamp is lit), date and time can be displayed.

- To read a file, use the following procedure:
  1. Insert a floppy disk with data into the drive.
  2. Select type of a file to read using file type setup key ④.
  3. Check that SHIFT key ⑨ is OFF. If ON, press to set to OFF.
  4. Press DIR/YMDH key ⑤, the keylamp goes on.  
(If the SHIFT key is turned on in the middle of the operation. YMDH display is made.)
  5. Press EXE key ⑩ to display on the file No./date and time indicator ① the lowest file No. of the specified file type existing on disk.
  6. Check that SHIFT key ⑨ is OFF. If ON, press to set to OFF.
  7. Press LOAD/DHMS key ⑥, the keylamp goes on.
  8. Select the file No. to read using DIGIT key ② and file No./date and time setup key ③. Specify whether to read as pattern A or B if the file type is WORD or FRAME and the ALTERNATE mode is ON in the pattern setting section. To select between patterns A and B, use the file No. setup key after moving the pointer to the left of the selected file No. using the DIGIT key.  
(If the SHIFT key is turned on in the middle of the operation, DHMS display is made.)
  9. Press EXE key ⑩ to read the selected file. While reading, the access lamp ⑫ is lit and the keys in the file operation section are inactive.
  10. Upon completion of file read, the access lamp goes off and the indicators and lamps change according to the setup conditions read.

D3186  
PULSE PATTERN GENERATOR  
OPERATION MANUAL

3.2 Operation on the Panel

- To display the date and time (DHMS), use the following procedure:
  1. Press the SHIFT key ⑨ to set the key ON.
  2. Pressing the LOAD/YMDH key (keylamp is lit) displays the current date and time (DHMS) on the file No./date and time indicator ①.  
(If the SHIFT key is turned off in the middle of the operation, file loading is made.)
  3. To set or change the displayed date and time, press the EXE key ⑩ to light the pointer of the file No./date and time indicator.
  4. Enter the date and time with the DIGIT key ② and the file No./date and time setting key, and then press the EXE key. The pointer goes off to show the end of setting.

⑦ SAVE/RESAVE key (  )

Saves/resaves data to a file. Saves when SHIFT key ⑨ is OFF (keylamp is not lit) and resaves when it is ON (keylamp is lit).

Here, 'Save' and 'Resave' refer to creating a new file and overwriting an existing file, respectively.

- To save data to a file, use the following procedure:
  1. Insert a floppy disk with data into the drive.
  2. Select type of a file to save using file type setup key ④.
  3. Check that SHIFT key ⑨ is OFF. If ON, press to set to OFF.
  4. Press DIR/YMDH key ⑤, the keylamp goes on.  
(If the SHIFT key is turned on in the middle of the operation. YMDH display is made.)
  5. Press EXE key ⑩ to display on the file No./date and time indicator ① the lowest file No. of the specified file type existing on disk.
  6. Check that SHIFT key ⑨ is OFF. If ON, press to set to OFF.
  7. Press SAVE/RESAVE key ⑦, the keylamp goes on.
  8. Specify a file No. to save using DIGIT key ② and file No./date and time setup key ③. Each time the file No./date and time setup key is pressed, the file No. is incremented/decremented. If a file with the displayed No. exists, "  " is displayed on the leftmost portion of the file No. indicator. In this case, the file cannot be saved with this No. Specify whether to save as pattern A or B if the file type is WORD or FRAME and the ALTERNATE mode is ON in the pattern setting section. To select between patterns A and B, use the file No. setup key after moving the pointer to the left of the selected file No. using the DIGIT key. (Set the SHIFT key to ON for changeover to file resave.)
  9. Press EXE key ⑩ to save the file with the specified file No. While saving, the access lamp ⑫ is lit and the keys in the file operation section are inactive.
  10. Upon completion of file save, the access lamp goes off.

D3186  
PULSE PATTERN GENERATOR  
OPERATION MANUAL

---

**3.2 Operation on the Panel**

- To resave to a file, use the following procedure:
  1. Insert a floppy disk with data into the disk.
  2. Select type of a file to resave using file type setup key ④.
  3. Check that SHIFT key ⑨ is OFF. If ON, press to set to OFF.
  4. Press DIR key ⑤, the keylamp goes on.  
(If the SHIFT key is turned on in the middle of the operation, DHMS display is made.)
  5. Press EXE key ⑩ to display on the file No./date and time indicator ① the lowest file No. of the specified file type existing on disk.



6. Specify a file No. to resave using DIGIT key ② and file No./date and time setup key ③. Specify whether to save as pattern A or B if the file type is WORD or FRAME and the ALTERNATE mode is ON in the pattern setting section. To select between patterns A and B, use the file No. setup key after moving the pointer to the left of the selected file No. using the DIGIT key.
7. Press SHIFT key ⑨ to set to ON.
8. Press SAVE/RESAVE key ⑦, the keylamp goes on.  
(Set the SHIFT key to OFF for changeover to file save.)
9. Press EXE key ⑩ to resave the file with the specified file No. While resaving, the access lamp ⑫ is lit and the keys in the file operation section are inactive.
10. Upon completion of file resave, the access lamp goes off.

⑧ DELETE/FORMAT key (  )

Deletes a file when SHIFT key ⑨ is OFF (keylamp is not lit) and initializes a floppy disk when SHIFT key is ON (keylamp is lit).

- To delete a file, use the following procedure:

1. Insert a floppy disk with data into the drive.
2. Select type of a file to delete using file type setup key ④.
3. Check that SHIFT key ⑨ is OFF. If ON, press to set to OFF.
4. Press DIR key ⑤, the keylamp goes on.  
(If the SHIFT key is turned on in the middle of the operation, YMDH display is made.)
5. Press EXE key ⑩ to display on the file No./date and time indicator ① the lowest file No. of the specified file type existing on disk.
6. Check that SHIFT key ⑨ is OFF. If ON, press to set to OFF.
7. Press the DELETE/FORMAT key ⑧, the keylamp goes on.
8. Select a file No. to delete using DIGIT key ② and file No./date and time setup key ③. (Set the SHIFT key to ON for disk formatting.)

9. Press EXE key ⑩ to display the following confirmation message:

d E L E T E . y n

Light the pointer on the upper left of y using the DIGIT key to execute file delete; light the pointer on the upper left of n to cancel the file delete.

10. Press again EXE key ⑩ to delete the file with the selected file No. if the pointer is located on the upper left of y. While deleting, the access lamp ⑫ is lit and the keys in the file operation section are inactive. If the pointer is located on the upper left of n, the following cancel message is displayed to terminate the processing:

C A n C E L

If a key in the file operation section other than the EXE key is pressed, the cancel message is displayed to terminate processing.

11. Upon completion of file delete, the access lamp goes off.

- To initialize a floppy disk, use the following procedure:

1. To initialize a 2HD-type disk (1.2 MB or 1.4 MB), set the capacity using Bit 2 of rear panel SW1 (⑥ in Figure 2-7). (See Table 3-15.)

Initialization of a 2DD-type disk (720 KB) has nothing to do with the Bit 2 setting of SW1.

If SW1 setting is modified, turn off the power, wait 5 seconds or more, then turn on the power.

2. Insert a floppy disk into the drive to initialize.
3. Press SHIFT key ⑨ to set to ON.
4. Press DELETE/FORMAT key ⑧, the keylamp goes on.  
(Set the SHIFT key to OFF for changeover to file delete.)
5. Press EXE key ⑩ to display the following confirmation message:

F r A T E . y n

Light the pointer on the upper left of y using the DIGIT key to execute disk initialization; light the pointer on the upper left of n to cancel the disk initialization.

6. Press again EXE key ⑩ to initialize the disk if the pointer is located on the upper left of y. While formatting, the access lamp ⑫ is lit and the keys in the file operation section are inactive. If the pointer is located on the upper left of n, the following cancel message is displayed to terminate the processing:

C A n C E L

If a key in the file operation section other than the EXE key is pressed, the cancel message is displayed to terminate the processing.

7. Upon completion of disk initialization, the access lamp goes off.

Note: When disk initialization is complete, all previous data on the disk is lost.

D3186  
PULSE PATTERN GENERATOR  
OPERATION MANUAL

3.2 Operation on the Panel

---

⑨ SHIFT key (  )

Changes the functions of keys ⑤ to ⑧. When the SHIFT key is OFF, the functions indicated on these key tops are selected; the functions displayed on the panel face are selected when ON. Pressing the SHIFT key alternately changes ON and OFF; the keylamp is lit when ON.

⑩ EXE key (  )

Executes the file operation or date and time setting specified with keys ⑤ to ⑧. For detail operation, see the explanation of keys ⑤ to ⑧.

⑪ Eject button

Pushbutton to remove the floppy disk from the drive. Do not press this button while the access lamp ⑫ is lit.

⑫ Access lamp

Lit while the disk is being accessed. While this lamp is lit, the keys in the file operation section are inactive. Do not press the eject button ⑪ while this lamp is lit.

(4-2) GPIB operation section

⑬ REMOTE lamp and LOCAL key (  )

REMOTE lamp is lit while GPIB is in the remote state. In this state, only the LOCAL key, duty rate control knob in the output setting/connector section (⑯ in Figure 2-4), and knob in the cross point control section (⑳ in Figure 2-4) are active; all other keys and knobs are inactive.

Press the LOCAL key to change the remote state to the local state. It is not possible to change to the local state using the LOCAL key while in the LOCAL LOCKOUT state.

⑭ MASTER key (  )

Set to ON to interlock the settings of the pattern setting section in D3286 Error Detector with the D3186 (master control function).

Pressing this key alternately changes the master control function ON and OFF. When ON, the keylamp is lit. When ON, the keylamp is lit.

When the key is set to ON, SLAVE key ⑮ turns OFF.

When the master control function is ON, the settings of the pattern setting section in the D3286 Error Detector are automatically set to the same conditions as those of the D3186 pattern setting section.

**D3186  
PULSE PATTERN GENERATOR  
OPERATION MANUAL**

**3.2 Operation on the Panel**

- To use D3186 master control function, use the following procedure:
  1. Connect GPIB connector on D3186 rear panel (⑤ in Figure 2-6) to GPIB connector on rear panel of D3286 Error Detector using the GPIB cable. Do not connect any other controller or equipment to the same GPIB.
  2. Set D3186 MASTER key ⑭ and D3286 SLAVE key to ON.
  3. After this, the settings of the D3286 pattern setting section are interlocked with the D3186 until the D3186 master control function is released. In this state, values cannot be set in the pattern setting section using the D3286 panel operation.
  4. To release the master control function, set the D3286 MASTER key and D3186 SLAVE key to OFF.

⑮ SLAVE key (  )

Set to ON, the opposite of the MASTER key ⑭, to interlock the settings of the D3186 pattern setting section with the D3286 Error Detector. Pressing this key alternately changes the slave control function ON and OFF.

When ON, the keylamp is lit. When this key is set to ON, MASTER key ⑭ turns OFF. While in the ON state, values cannot be set in the pattern setting section using the D3186 panel operation.

- To use D3186 slave control function, use the following procedure:
  1. Connect GPIB connector on D3186 rear panel (⑤ in Figure 2-6) to GPIB connector on rear panel of D3286 Error Detector using the GPIB cable. Do not connect any other controller or equipment to the same GPIB.
  2. Set D3186 SLAVE key ⑮ and D3286 MASTER key to ON.
  3. After this, the settings of the D3186 pattern setting section are interlocked with the D3286 until the D3186 slave control function is released. In this state, values cannot be set in the pattern setting section using the D3186 panel operation.
  4. To release the slave control function, set the D3186 SLAVE key and D3286 MASTER key to OFF.

D3186  
PULSE PATTERN GENERATOR  
OPERATION MANUAL

3.2 Operation on the Panel

---

⑩ ADDRESS DISP key (  )

Set to ON to display GPIB device address on file No./date and time indicator ① and to confirm/modify the address setting. Pressing this key alternately changes ON and OFF. When ON, the keylamp is lit.

- To display the device address, use the following procedure:
  1. Press ADDRESS DISP key ⑩ to set to ON.
  2. Use DIGIT key ② and file No./date and time setup key ③ to modify the device address displayed.
  3. Press the ADDRESS DISP key again to set to OFF, and the pointer goes off to terminate address setting.

Note: Device address can be set in the range of 0 to 30.

⑪ PANEL LOCK key (  )

When set to ON, only the LOCAL key ③, duty rate control knob in the output setting/connector section (⑥ in Figure 2-4) and knob on the cross point control section (② in Figure 2-4) are active; all other keys and control knobs are inactive. Pressing this key alternately changes ON and OFF. When ON, the keylamp is lit.

### (5) Setting the initial state

To set the D3186 to the initial state shown in Subsection 5.10.2, turn off the D3186 power, wait 5 seconds or more, and turn on the power while pressing the PATTERN DATA-2nd key in the pattern setting section (⑨ in Figure 2-3). Keep pressing the PATTERN DATA-2nd key until Initial is displayed on the file No. indicator (① in Figure 2-6) in the file operation section. This operation initializes GPIB device address to 1.

### 3.2.2 Rear Panel Operation Method

This section describes the operation method of each component on the rear panel. See Figure 2-6.

The explanation follows the sequential order in Figure 2-6.

① ~ LINE

To input AC power line. Connect to AC outlet through the attached power cable. When connecting the power cable, see Subsection 1.2.3 Setup.

② BREAKER

Automatically turns OFF if an overcurrent is detected in the AC power line. Breaker can be manually turned ON/OFF; press the upper portion (side marked with ·) to turn ON and the lower portion (side without · mark) to turn OFF. If the breaker automatically turns OFF, there was a possible overcurrent in the AC power line. Remove the cause of the overcurrent before setting the breaker to ON. Avoid using the breaker ON/OFF as the power switch.

③ Ground terminal

Terminal to ground the case of this equipment. To prevent electric shock, static electricity damage, and line noise generation/trouble, be sure to ground using the 3-pin power cable plug or this ground terminal.

④ GPIB (ONLY FOR SG) connector

Connect the GPIB cable with this connector when the external clock signal generator is controlled with the D3186 frequency setting section on the front panel through GPIB. The external clock signal generator should be in addressable mode and with device address setting of 20 (decimal notation).

Set the bit 3 and bit 4 of the dip switch SW1 ⑥ according to the control code of the clock signal generator to be used. (See Table 3-12.)

⑤ GPIB connector

To control this equipment from a computer or to use the master/slave control function in combination with the D3286 Error Detector through the GPIB.

⑥ DIP switches SW1

Set to select additional functions of this equipment. The switch consists of eight bits; downward Bit 1 to Bit 8. Each bit is set to the left for OFF (0) and to the right for ON (1). The settings of these switches are read only when the power switch is turned ON. Therefore, if any modifications are made in the settings, turn OFF the power, wait a few seconds, then turn ON the power for the new settings to be effective.

Tables 3-12 shows the function and setting method for each bit switch.

Table 3-12 DIP Switch SW1 Settings

bit	Function	Settings (0: (OFF), 1: (ON))	
1	ALTERNATE CONTROL	INTERNAL	0
		EXTERNAL	1
2	FD FORMAT TYPE	1.4MB	0
		1.2MB	1
3, 4	SG CONTROL CODE		bit 4,3
		AT code	0, 0
		HP code	0, 1
		R&S code	1, 0
		User Programmable	1, 1
5 to 8	Not used	Arbitrary	

SW1 bit 1: Selects changing between patterns A and B in WORD and FRAME pattern ALTERNATE mode by either using the front panel A/B select key (Ⓢ in Figure 2-3) or control from the GPIB, or by using the signal input to the rear panel EXT ALT INPUT connector (Ⓢ in Figure 2-6).

0 (OFF) . . . . . Internal control (A/B select key or GPIB)

1 (ON) . . . . . External control (EXT ALT INPUT)

When external control is specified, the EXT lamp(Ⓢ in Figure 2-3) is lit on the front panel.

SW1 bit 2: Selects 2HD-type floppy disk capacity as 1.2 MB or 1.4 MB for initialization (FORMAT) on the D3286.

0 (OFF) . . . . . 1.4 MB

1 (ON) . . . . . 1.2 MB

The 2DD-type floppy disk is automatically recognized and initialized as 720 KB.



D3186  
PULSE PATTERN GENERATOR  
OPERATION MANUAL

3.2 Operation on the Panel

SW1 bit 3,4: Sets the control code used when the external clock signal generator is controlled from D3186 through GPIB.

bit 4,	bit3		
0 (OFF),	0 (OFF)	...	AT code The control code applied to the TR4515 Synthesized Sweeper produced by ADVANTEST.
0 (OFF),	1 (ON)	....	HP code The control code applied to the HP8360 Series Synthesized Sweeper produced by Hewlett-Packard.
1 (ON),	0 (OFF)	...	R&S code The control code applied to the SMP Series Signal Generator produced by ROHDE&SCHWARZ.
1 (ON),	1 (ON)	....	User Programmable The mode that control command can be changed by the user on the basis of AT code. The control command can be changed by remote programming from GPIB controller to D3186. For the programming, refer to (7) External SG control code setting in Subsection 5.6.4 Command Program Message.

⑦ EXT GATE INPUT connector

Used to input a gate signal from the external source to inhibit data output (Figure 3-3). While the DATA output is inhibited, the DATA output is LOW level and the /DATA output is HIGH level.

The input level is 0 V as HIGH (stop) and -1 V as LOW (measuring). When the operating clock period multiplied by 64 is 20 ns or more, the input pulse width has to be equal to or more than the operating clock period multiplied by 64. If not, 20 ns or more can be used as the input pulse width.

The input is terminated to 0 V with approximately 50 Ω.

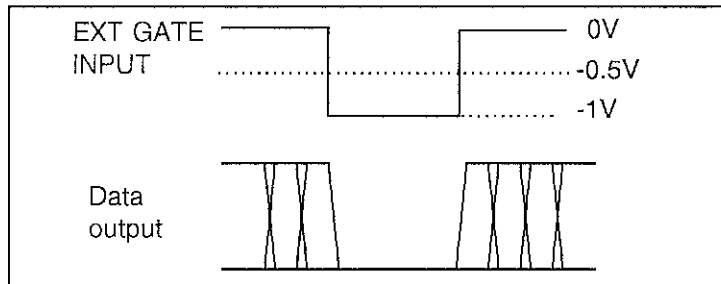

Figure 3-3 Operation of EXT GATE INPUT

⑧ EXT ALT INPUT connector

Used for external input of the signal to change between patterns A and B in the WORD pattern ALTERNATE mode as shown in Figure 3-4. Input level is 0 V as HIGH (pattern A) and -1 V as LOW (pattern B). The width of the HIGH and LOW pulses should be larger than the expression:

Operating clock period × least common multiple between 256 and the pattern length × N + 32

Where N is a minimum value that meets the expression shown below.

$$N \geq 5 \times \text{least common multiple between 256 and the pattern length (bit)} / \text{Pattern length (bit)}$$

The output pattern will toggle between patterns A and B according to this input level when each pattern ends. To use this input, set ⑥ SW1 Bit to ON (1).

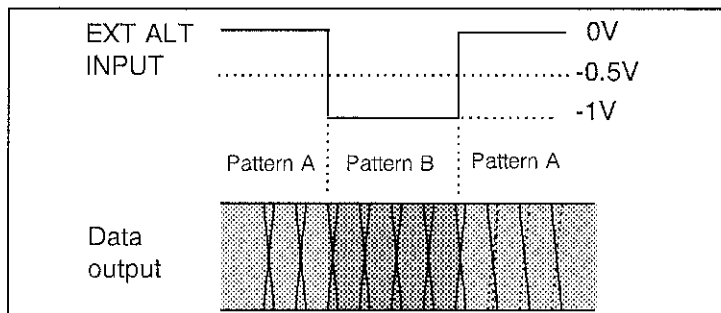

Figure 3-4 Operation of EXT ALT INPUT

⑨ EXT ERR ADD INPUT connector

Used to add a bit error to the data output pattern according to the external signal. To use this input, set the ERROR ADDITION EXT key (⑩ in Figure 2-3) on the front panel to ON. When the key is ON, a 1-bit error is added at every leading edge of pulse to be input to the connector.

Input level is 0 V as HIGH and -1 V as LOW. The input is terminated to 0 V with approximately 50  $\Omega$ .

When the operating clock period multiplied by 256 is 20 ns or more, the HIGH pulse width has to be equal to or more than the operating clock period multiplied by 256. If not, 20 ns or more can be used as the HIGH pulse width.

The pulse width for LOW has to be 20 ns or more. The raise and fall times have to be 10 ns or less.

⑩ 1/2 CLOCK OUTPUT connector

Used to output a clock of half the frequency of CLOCK1 output.

Output level is 0 V as HIGH and -1 V as LOW. The load is terminated to 0 V with approximately 50  $\Omega$ .

⑪ 1/4 RATE OUTPUT connector

Used to output 1/4 rate or DATA and CLOCK 1 output (Figure 3-5).

Output level is 0 V as HIGH and -1 V as LOW. The load is terminated to 0 V with approximately 50  $\Omega$ .

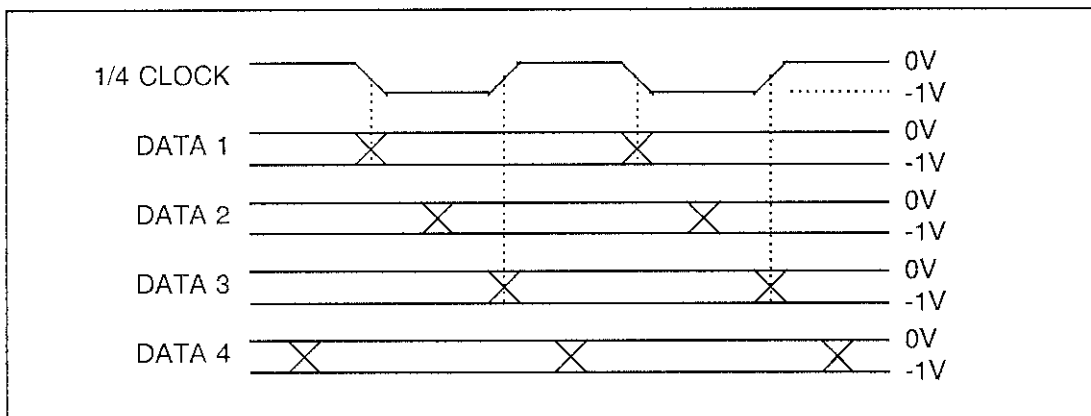

Figure 3-5 Phase Relation of 1/4 RATE OUTPUT

D3186  
PULSE PATTERN GENERATOR  
OPERATION MANUAL

3.2 Operation on the Panel

---

⑫ 10M REF OUTPUT connector (Option)

Reference signal output of 10 MHz, approximately 1.5 Vp-p and AC coupling from the internal clock signal source.

⑬ 10M REF INPUT connector (Option)

Reference signal input of 10 MHz and AC coupling from internal clock signal source. If a signal of more than 1.5 Vp-p is input, this signal input is automatically validated.

⑭  $\phi$ m INPUT connector (Option)

Signal input to make phase modulation to the internal clock signal source.

## 4. SYSTEM OPERATION METHOD

This chapter describes the error test operation performed by connecting the D3286 Error Detector, the unit under (UUT), or the device under test (DUT) to the D3186.

### 4.1 Setting the D3186

#### 4.1.1 Connecting Clock Input

D3186 has an built-in clock signal generator. And external generator can also be used.

- (1) To use the built-in clock signal generator

The built-in clock signal generator outputs to the CLOCK OUTPUT connector on the front panel. Connect this CLOCK OUTPUT to the CLOCK INPUT connector on the front panel using the attached SMA-SMA coaxial cable.

- (2) To use an external clock signal generator

Input the sinusoidal external clock signal with amplitude of 0.7 Vp-p to 1.5 Vp-p to the CLOCK INPUT connector on the front panel. This CLOCK INPUT is terminated to 0 V with approximately 50  $\Omega$ .

The external clock signal generator can also be controlled from the frequency setting section on the D3186 front panel using the GPIB. Use of this function requires setting the control code system (see Table 3-5) by DIP switch SW1 Bits 3 and 4 on D3186 rear panel and connecting GPIB (ONLY FOR SG) connector on the rear panel to the GPIB connector of the external clock signal generator. Set the external clock signal generator to addressable mode and device address to "20" (decimal). This function can also be used to remotely control the D3186 from a computer through the GPIB.

### 4.1.2 Setting Data Output

Set data output (DATA,  $\overline{\text{DATA}}$ ) level according to UUT/DUT input conditions.

- (1) When the UUT/DUT data input connection is DC and the terminator voltage is 0 V (see Figure 4-1.):

Set output level by pressing the OUTPUT MODE key so that the TO 0V lamps of DATA and  $\overline{\text{DATA}}$  are lit on the front panel. Since the data output offset and amplitude are variable, use the OFFSET and AMPLITUDE controls of DATA and  $\overline{\text{DATA}}$  to set each value.

- (2) When the UUT/DUT data input connection is DC and the terminator voltage is -2 V. ECL level (see Figure 4-2.)

Set output level by pressing the OUTPUT MODE key so that the TO -2V lamps of DATA and  $\overline{\text{DATA}}$  are lit on the front panel.

Data output offset (HIGH level) and amplitude will be set to approximately -0.8 V and approximately 0.8 Vp-p, respectively, ( $\pm 0.2$  V variable for each).

- (3) When the UUT/DUT data input connection is AC (see Figure 4-3.):

Set output level by pressing the OUTPUT MODE key so that the AC lamps of DATA and  $\overline{\text{DATA}}$  are lit on the front panel.

Setting of data output offset is insignificant and only the amplitude becomes variable.

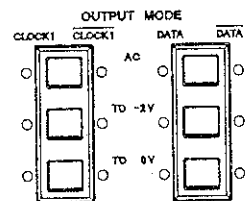

**D3186**  
**PULSE PATTERN GENERATOR**  
**OPERATION MANUAL**

**4.1 Setting the D3186**

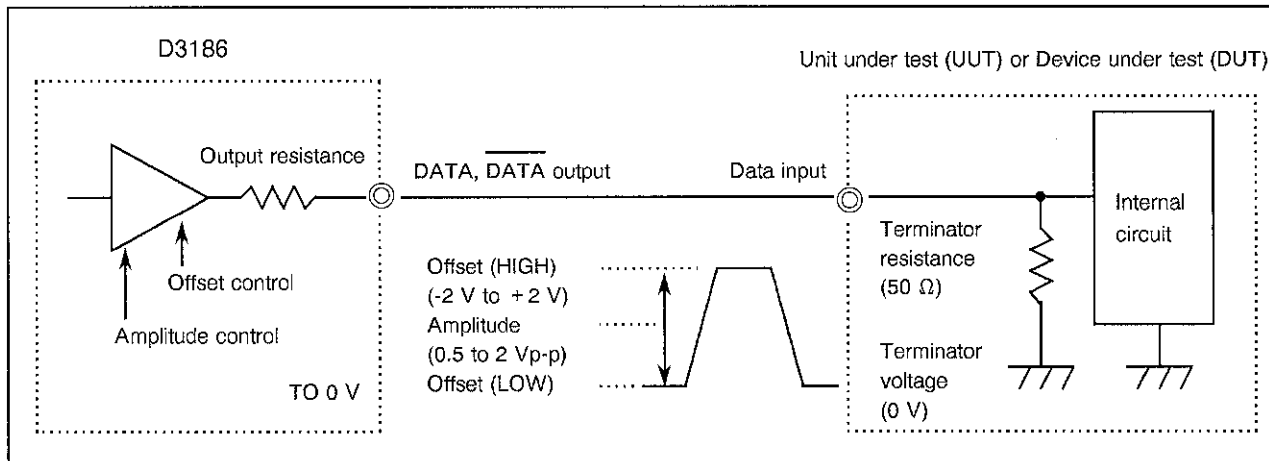

Figure 4-1 DATA and  $\overline{\text{DATA}}$  Output, DC Connection, and 0 V Termination

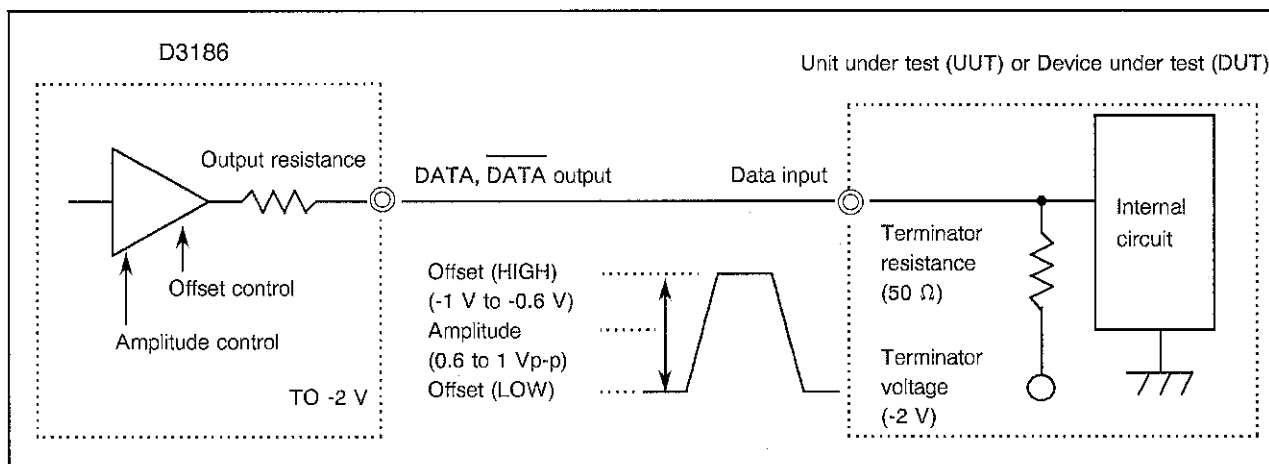

Figure 4-2 DATA and  $\overline{\text{DATA}}$  Output, DC Connection, -2 V Termination, and ECL Level

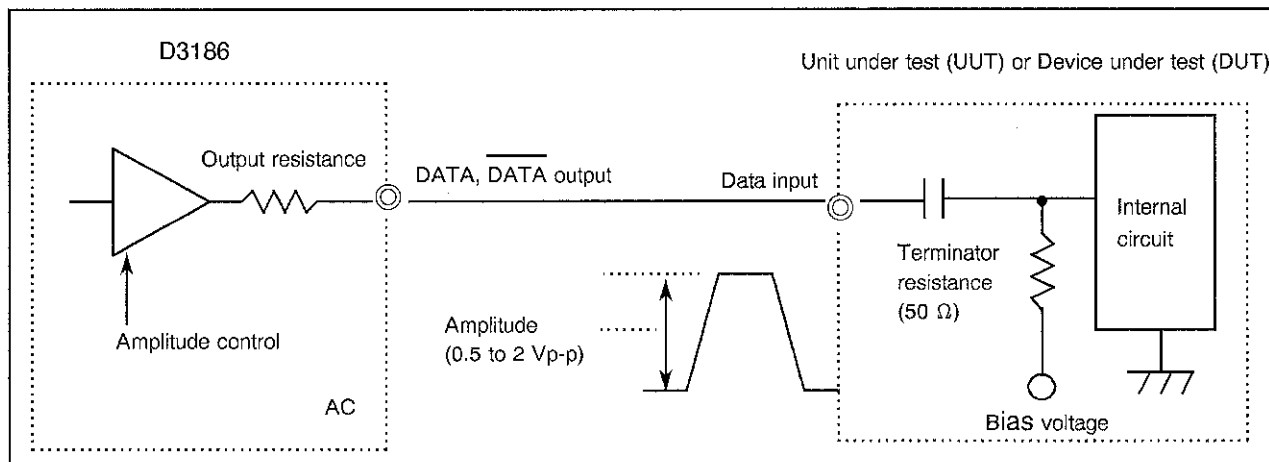

Figure 4-3 DATA and  $\overline{\text{DATA}}$  Output and AC Connection

### 4.1.3 Setting Clock Output

When the UUT/DUT requires a clock, select the clock output from CLOCK1,  $\overline{\text{CLOCK1}}$ , and CLOCK2 according to the UUT/DUT input conditions. If CLOCK1 and/or  $\overline{\text{CLOCK1}}$  is used, set the respective output level.

- (1) When the UUT/DUT clock input connection is DC and offset value should be set:  
Use CLOCK1 or  $\overline{\text{CLOCK1}}$ .

- (a) When the terminator voltage of the UUT/DUT clock input is 0 V (see Figure 4-4.):

Set output level by pressing the OUTPUT MODE key so that the TO 0V lamp of CLOCK1 or  $\overline{\text{CLOCK1}}$  is lit on the front panel. Offset and amplitude of the clock output are variable; use the OFFSET and AMPLITUDE controls of CLOCK1 or  $\overline{\text{CLOCK1}}$  to set each value.

- (b) When the terminator voltage of the UUT/DUT clock input is -2 V (see Figure 4-5.):

Set output level by pressing the OUTPUT MODE key so that the TO -2V lamp of CLOCK1 or  $\overline{\text{CLOCK1}}$  is lit on the front panel. Offset (HIGH level) and amplitude of the clock output will be set to approximately -0.8 V and approximately 0.8 Vp-p respectively, ( $\pm 0.2$  V variable for each).

- (2) When the UUT/DUT clock input connection is AC:

- (a) To use variable UUT/DUT clock input amplitude (see Figure 4-6.):

Use CLOCK1 or  $\overline{\text{CLOCK1}}$ . Set output level by pressing the OUTPUT MODE key so that the CLOCK1 or  $\overline{\text{CLOCK1}}$  AC lamp is lit on the front panel. The setting of clock output offset becomes insignificant and only the amplitude becomes variable.

- (b) To use fixed UUT/DUT clock input amplitude (see Figure 4-7.):

Use CLOCK2. The CLOCK2 output connection is AC and the amplitude is approximately 1 Vp-p fixed. If a smaller amplitude is required, use an external attenuator, too.

- (3) When the UUT/DUT clock input connection is DC and the central voltage of the amplitude should be equal to the terminator voltage (see Figure 4-8.):

Use CLOCK2. Since the CLOCK2 output connection is AC, the central voltage of the amplitude will be nearly equal to the terminator voltage. The amplitude is fixed at approximately 1 Vp-p.

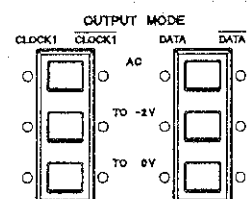



**D3186**  
**PULSE PATTERN GENERATOR**  
**OPERATION MANUAL**

**4.1 Setting the D3186**

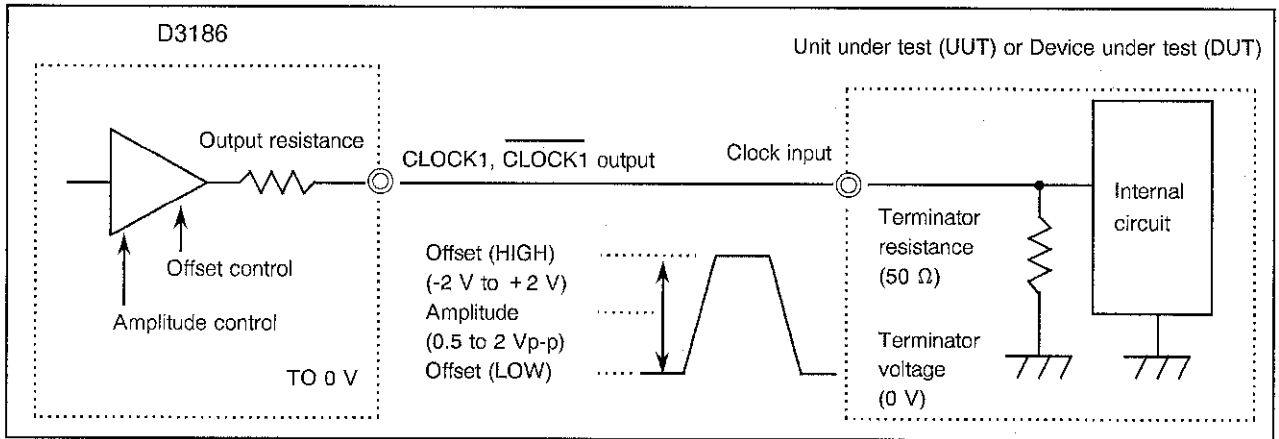

Figure 4-4 CLOCK1 and CLOCK1 Output, DC Connection, 0 V Termination

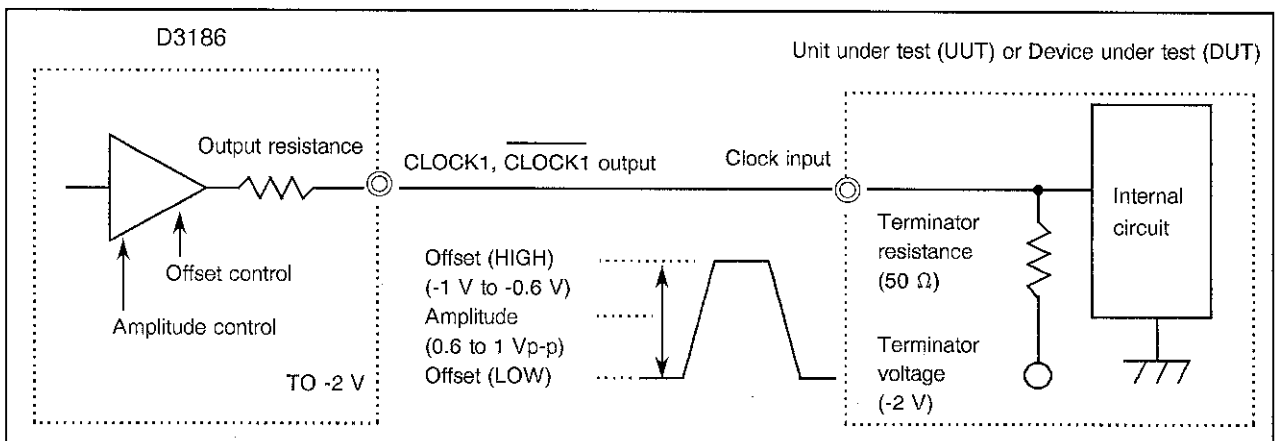

Figure 4-5 CLOCK1 and CLOCK1 Output, DC Connection, -2 V Termination, ECL Level

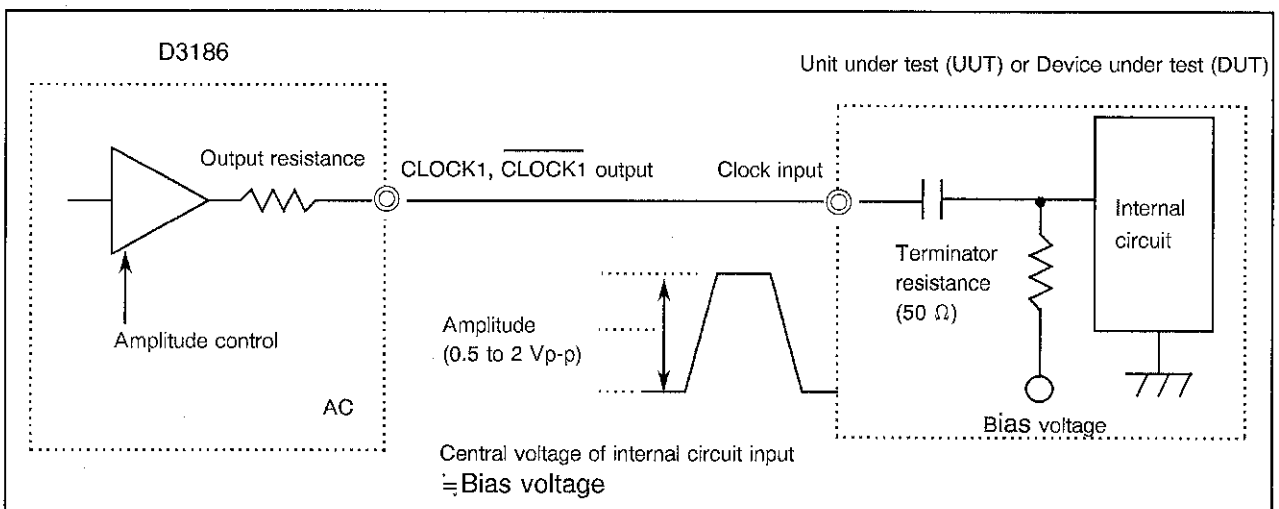

Figure 4-6 CLOCK1 and CLOCK1 Output, AC Connection

**D3186**  
**PULSE PATTERN GENERATOR**  
**OPERATION MANUAL**

**4.1 Setting the D3186**

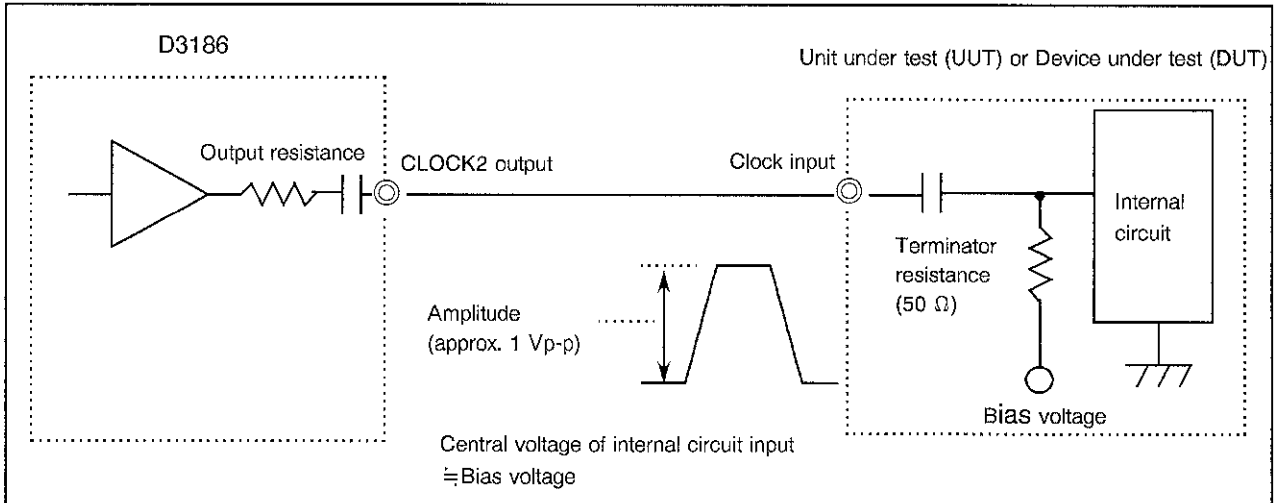

Figure 4-7 CLOCK2 Output, AC Connection Terminator

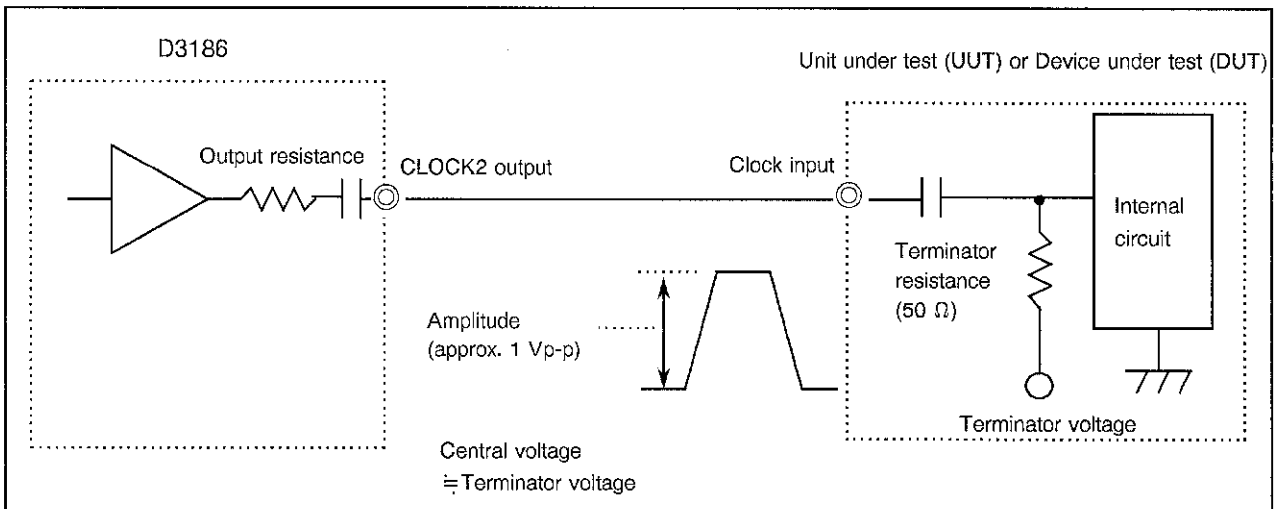

Figure 4-8 CLOCK2 Output, DC Connection Terminator

#### 4.1.4 Setting the Pattern

Set the pattern mode to WORD or PRBS. For WORD, set the bit length and the logic (0, 1) for each bit. For PRBS, set the pattern length  $2^N-1$  and the mark ratio.

For manual setting by front panel key operation, it is convenient to use the master/slave control function so that the patterns of the D3186 and the D3286 Error Detector will be both set simultaneously.

This function has two different methods. In the first method, the D3186 and D3286 are used as the master and slave, respectively, so that the D3286 pattern setting section will be interlocked with the D3186 pattern setting section. In the second method, the D3286 and D3186 are used as the master and slave, respectively, so that the D3186 pattern setting section will be interlocked with the D3286 pattern setting section.

Use of this function requires connecting the D3186 and D3286 by GPIB cable. The first method requires turning ON the D3186 front panel MASTER key and the D3286 front panel SLAVE key; turn ON the D3286 front panel MASTER key and the D3186 front panel SLAVE key for the second method. Key operations of the pattern setting section on the slave machine side become ineffective.

CAUTION

1. Do not connect any other controller or equipment to the D3186 and D3286 GPIB connectors when using the master/slave function.
2. Be sure to turn OFF the MASTER key and SLAVE key when executing remote control with the GPIB controller.

## 4.2 Setting the D3286

### 4.2.1 Setting Data Input

- (1) Set the data input terminator voltage according to the UUT/DUT output conditions. When the TO 0V lamp on the DATA side of TERMINATOR on the front panel is lit, the terminator voltage is 0 V; when the TO -2V lamp is lit, the terminator voltage is -2 V. The voltage setting is alternately changed each time the DATA key is pressed.
- (2) Set the data input threshold level according to the UUT/DUT output voltage. Set the THRESHOLD LEVEL display voltage on the front panel to the central value of the UUT/DUT output voltage amplitude by rotating the control. The setting range varies depending on the data input terminator voltage.

### 4.2.2 Setting Clock Input

There are three types of source clock input supply as shown below. Set the terminator voltage of the clock input according to the output conditions of each supply source.

- (1) To use UUT/DUT clock output:

Set the clock input terminator voltage according to the UUT/DUT output conditions. When the TO 0V lamp on the CLOCK side of TERMINATOR on the front panel is lit, the terminator voltage is 0 V; when the TO -2V lamp is lit, the terminator voltage is -2V.

The voltage setting is alternately changed each time the CLOCK key is pressed. If the UUT/DUT clock output connection is AC, the terminator voltage setting of the D3286 clock input can be 0 V or -2 V.

- (2) To use D3186 CLOCK1 and  $\overline{\text{CLOCK1}}$  output

Both TO 0V and TO -2V can be used in the D3186 clock output mode (CLOCK1,  $\overline{\text{CLOCK1}}$  OUTPUT MODE). AC is not available. If the clock output mode has been set to TO 0V, set the D3286 clock input to TO 0V; set to TO -2V if TO -2V has been set.

When the TO 0V lamp on the CLOCK side of TERMINATOR on the front panel is lit, the terminator voltage is 0 V; when the TO -2V lamp is lit, the terminator voltage is -2 V.

The voltage setting is alternately changed each time the CLOCK key is pressed.

- (3) To use D3186 CLOCK2 output

Since the D3186 CLOCK2 output connection is AC, the terminator voltage setting of the D3286 clock input can be 0 V or -2 V.

### 4.2.3 Setting the Pattern

Set in the same way as the D3186 pattern setting. For manual setting by front panel key operation, it is convenient to use the master/slave control function so that the patterns of the D3186 and the D3286 Error Detector will be both set simultaneously.

This function has two different methods. In the first method, the D3186 and D3286 are used as the master and slave, respectively, so that the D3286 pattern setting section will be interlocked with the D3186 pattern setting section. In the second method, the D3286 and D3186 are used as the master and slave, respectively, so that the D3186 pattern setting section will be interlocked with the D3286 pattern setting section.

Use of this function requires connecting the D3186 and D3286 by GPIB cable. The first method requires turning ON the D3186 front panel MASTER key and the D3286 front panel SLAVE key; turn ON the D3286 front panel MASTER key and the D3186 front panel SLAVE key for the second method. Key operations of the pattern setting section on the slave machine side become ineffective.

CAUTION

1. Do not connect any other controller or equipment to the D3186 and D3286 GPIB connectors when using the master/slave function.
2. Be sure to turn OFF the MASTER key and SLAVE key when executing remote control with the GPIB controller.

### 4.2.4 Setting Data Input Polarity

For the relationship between UUT/DUT input and output, set INPUT POLARITY on the front panel depending on whether the data polarity is inverted or not. Press the INPUT POLARITY key so that the INVERSE lamp will be lit if the polarity is inverted and the NORMAL lamp will be lit if it is not inverted.

### 4.2.5 Adjusting Clock Delay

Rotate the DELAY control on the front panel to adjust the phase relationship between data input and clock input so that the pattern sync will be established to minimize the bit error rate.

When the AUTO SEARCH key is set to ON on the front panel, the data input threshold level mentioned previously and the clock delay are automatically adjusted.

### 4.3 Connecting Signal Lines

Figure 4-9 shows an example of connecting the signal lines, Connect the clock I/O signal lines according to presence of UUT/DUT clock I/O and each voltage level and terminating method.

CAUTION

To prevent damage to equipment and device, execute the following preparation before signal line connection:

- (1) Ground equipment by bundling grounding terminals of each device's case at one location.
- (2) Protect the operator's body by using a ground band, etc.
- (3) Be sure to discharge in advance the static electricity on coaxial cable conductor used for signal line connection.
- (4) Correctly set output voltage level and terminator voltage for each device.

D3186  
PULSE PATTERN GENERATOR  
OPERATION MANUAL

4.3 Connecting Signal Lines

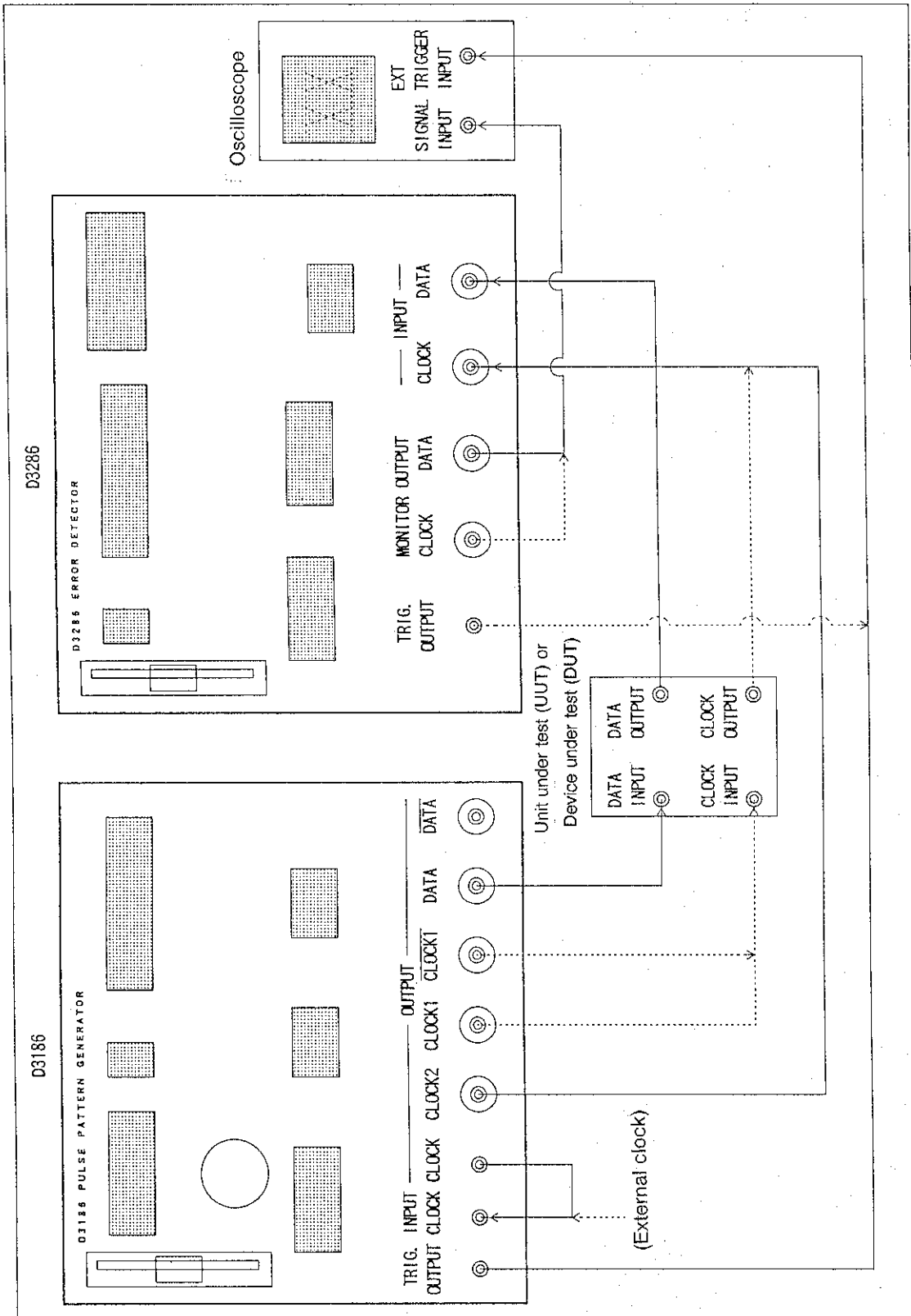

Figure 4-9 Signal Line Connections





## 5. GPIB

### 5.1 Outline of GPIB

The GPIB is an interface system which can connect measurement devices to controllers and peripheral equipment via a simple cable (bus line). It is more extendable and easy to use than other existing interface methods. Due to electrical, mechanical, and functional compatibility with other companies' products, the GPIB can configure from a simple system to an automatic instrumentation system with high-level functions through a single bus cable.

The GPIB system first requires setting each "address" of the respective components connected to the bus line. Components can play one or more roles as controller, talker, and listener. During system operation, only one "talker" can send data to the bus line, and more than one "listener" can receive that data. The controller specifies addresses of "talker" and "listener" to transfer data from "talker" to "listener" or sets as "talker" measurement conditions for "listener".

For data transfer between equipment, eight bit-parallel and byte-serial data lines are used to perform asynchronous bidirectional transmission. Because it is an asynchronous system, components can be interconnected regardless of their transmission speed. Data (messages) sent/received between components include measurement data, measurement conditions (programs), various commands; primarily using ASCII code.

In addition to the eight data lines, the GPIB has three handshake lines to control asynchronous data send/receive between devices and five control lines to control information flow on the bus.

- For handshake line, the following signals are used:

DAV (Data Valid) : Indicates data validity.  
NRFD (Not Ready For Data) : Indicates data receivability.  
NDAC (Not Data Accepted) : Indicates data receive completion.

- For control lines, the following signals are used:

ANT (Attention) : Identifies whether data line signal shows address, command or other information.  
IFC (Interface Clear) : Clears interface.  
EOI (End or Identify) : Used at completion of information transfer.  
SRQ (Service Request) : Used for any equipment to request controller for service.  
REN (Remote Enable) : Used to remotely control remote programmable equipment.

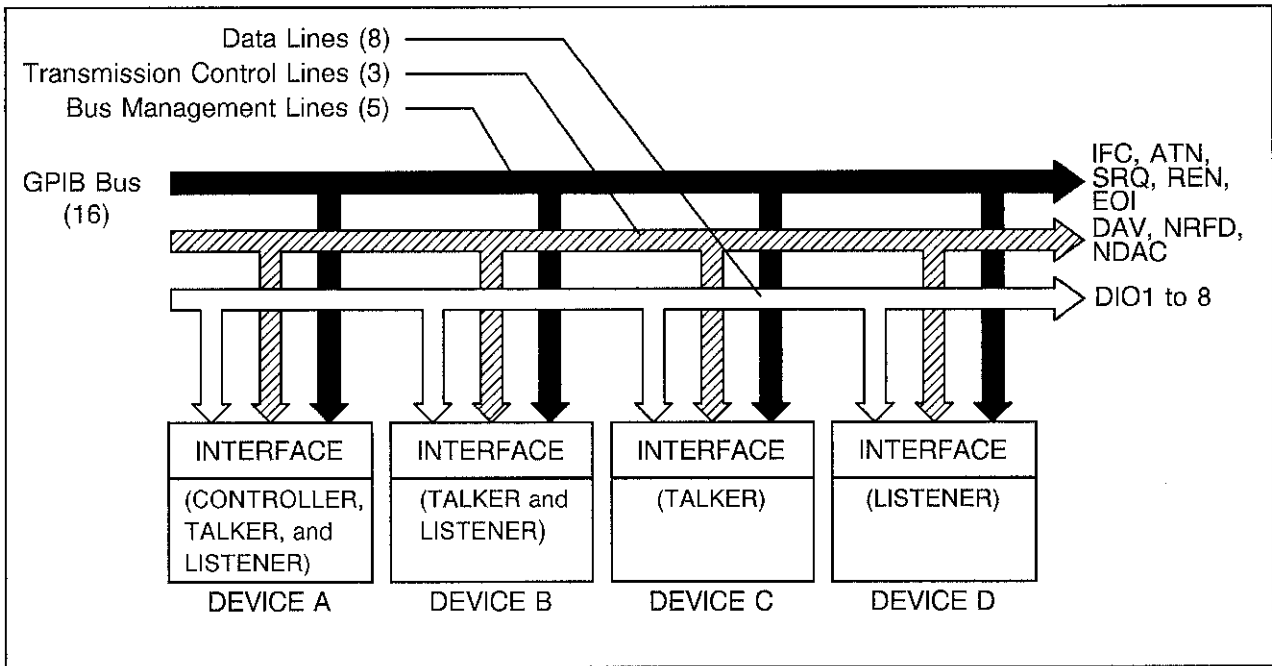

Figure 5-1 Outline of GPIB

## 5.2 Functional Specification

### 5.2.1 GPIB Specification

Governing specification:	IEEE standard 488-1978
Available code:	ASCII code and binary code
Signal level:	"High" state; + 2.4 VDC or more "Low" state; + 0.4 VDC or less
Signal line termination:	16 bus lines are terminated as follows:

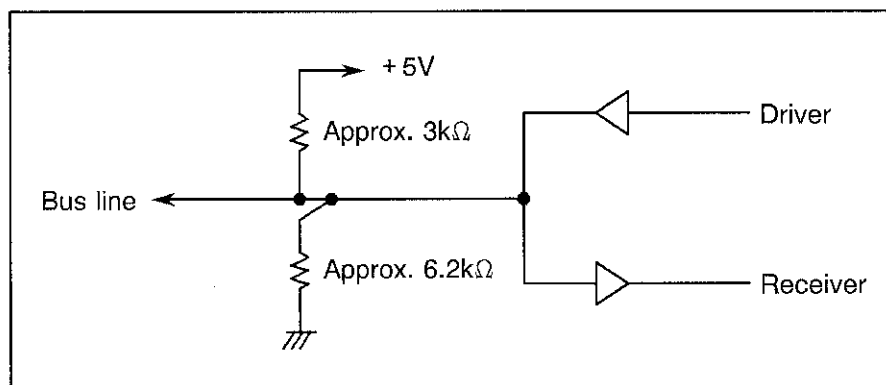

Figure 5-2 Signal Line Termination

Driver specification:	Open collector type "Low" state output voltage; + 0.4 V or less, 48 mA "High" state output voltage; + 2.4 V or more, -5.2 mA
Receiver specification:	"Low" state at + 0.6 V or less "High" state at + 2.0 V or more
Bus cable length:	Total bus cable length must be (No. of components connected to bus) x 2 m or less and must not exceed 20 m.
Addressing:	31 types of talk address/listen address can be arbitrarily set with front panel address select switch.
Connector:	24-pin GPIB connector, 57-20240-D35 (equivalent to products manufactured by Amphenol)

## 5.2.2 Interface Functions

Table 5-1 shows interface functions.

Table 5-1 Interface Functions

Code	Interface Functions
SH1	Source handshake function available
AH1	Acceptor handshake function available
T5	Basic talker function, serial pole function, listener-specified talker release function, talk-only mode function (during MASTER ON)
L3	Basic listener function, talker-specified listener release function, listen-only mode function (during SLAVE ON)
SR1	Service request function available
RL1	Remote function available
PP0	Parallel pole function not available
DC1	Device clear function available ("SDC" and "DCL" commands available)
DT1	Device trigger function not available
C0	Controller function not available
E2	Three-state bus driver used

D3186  
PULSE PATTERN GENERATOR  
OPERATION MANUAL

5.2 Functional Specification

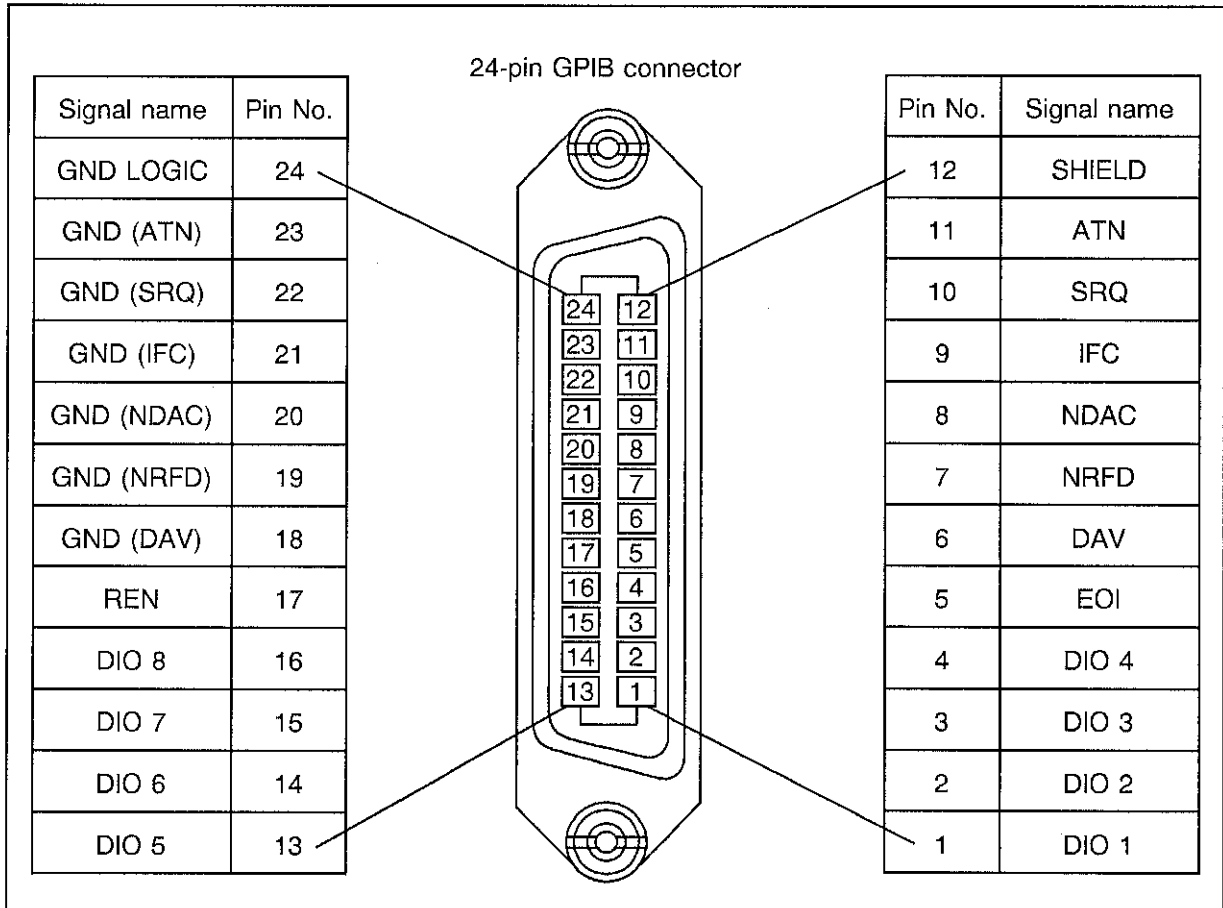

Figure 5-3 Pin Assignment of GPIB Connector

### 5.3 Notes on GPIB Usage

This section describes notes for using GPIB.

(1) Cable connection/disconnection

Before GPIB cable connection/ disconnection, turn off power of all equipment to be connected. Connect/disconnect GPIB cable only when ground cable of each equipment case is connected to the ground (grounded).

(2) Device address setting

Set D3286 device address using front panel keys. Be sure to avoid address duplication between controllers and other equipment connected to the same GPIB.

(3) GPIB connector only for SG

A special GPIB connector (ONLY FOR SG) that is used to control an external SG (clock signal generator) is provided in D3186.

Do not connect this connector with a device other than SG.

The GPIB address of the external SG must be 20.

(4) Master/slave control operation

If equipment other than D3286 Error Detector is connected while MASTER key (Ⓐ in Figure 2-5) or SLAVE key (Ⓑ in Figure 2-5) is ON on D3186 front panel, D3186 Pulse Pattern Generator may occasionally operate abnormally displaying an error message. In this case, set D3186 MASTER and SLAVE key to OFF or disconnect equipment other than D3286.

(5) ATN interrupt during message transmission

When ATN request occurs during inter-device message transmission, priority is given to ATN, so that the message transmission is halted.

(6) Conforming standards version



D3186 GPIB message syntax and status byte configuration conform to IEEE488.1 standards to maintain compatibility with existing products. Does not conform to IEEE488.2 standards.

**D3186**  
**PULSE PATTERN GENERATOR**  
**OPERATION MANUAL**

---

**5.4 Setting Device Address**

## 5.4 Setting Device Address

D3186 device address is displayed on file No./date and time indicator (① in Figure 2-5) when ADDRESS DISP switch (⑫ in Figure 2-5) is ON on D3186 front panel. Use of  and  keys under this indicator enables modifying device address. Setting range is 0 to 30. Set device address to prevent duplication between controllers and other equipment connected to GPIB. When shipped, D3186 GPIB address is set to 1.

**D3186  
PULSE PATTERN GENERATOR  
OPERATION MANUAL**

---

**5.5 Canceling Master/Slave Control Function**

## 5.5 Canceling Master/Slave Control Function

D3186 remote control from a controller requires deactivating D3186 master/slave control function. Master/slave control function can be canceled by interface clear instruction from controller as well as by panel key operation. To cancel the master/slave function from controller, send an instruction to set GPIB connector IFC pin (pin 9) to low level (active) before remote control; e.g., instruction "abort 7" in HP BASIC.



## 5.6 Program Message (Listener Format)

This section describes program messages for D3186 remote control with the GPIB controller. Program messages are two types: (a) command program message for operation condition setup and start/stop instruction execution, and (b) query program message for setup state inquiry. See Section 5.7 for query program message and its response message. Basic syntax is common to both types of program messages.

### 5.6.1 Basic Format

Normally, ASCII code is used for program messages. Binary code can also be used for WORD pattern settings. Figure 5-4 shows basic syntax of a program message in ASCII code.

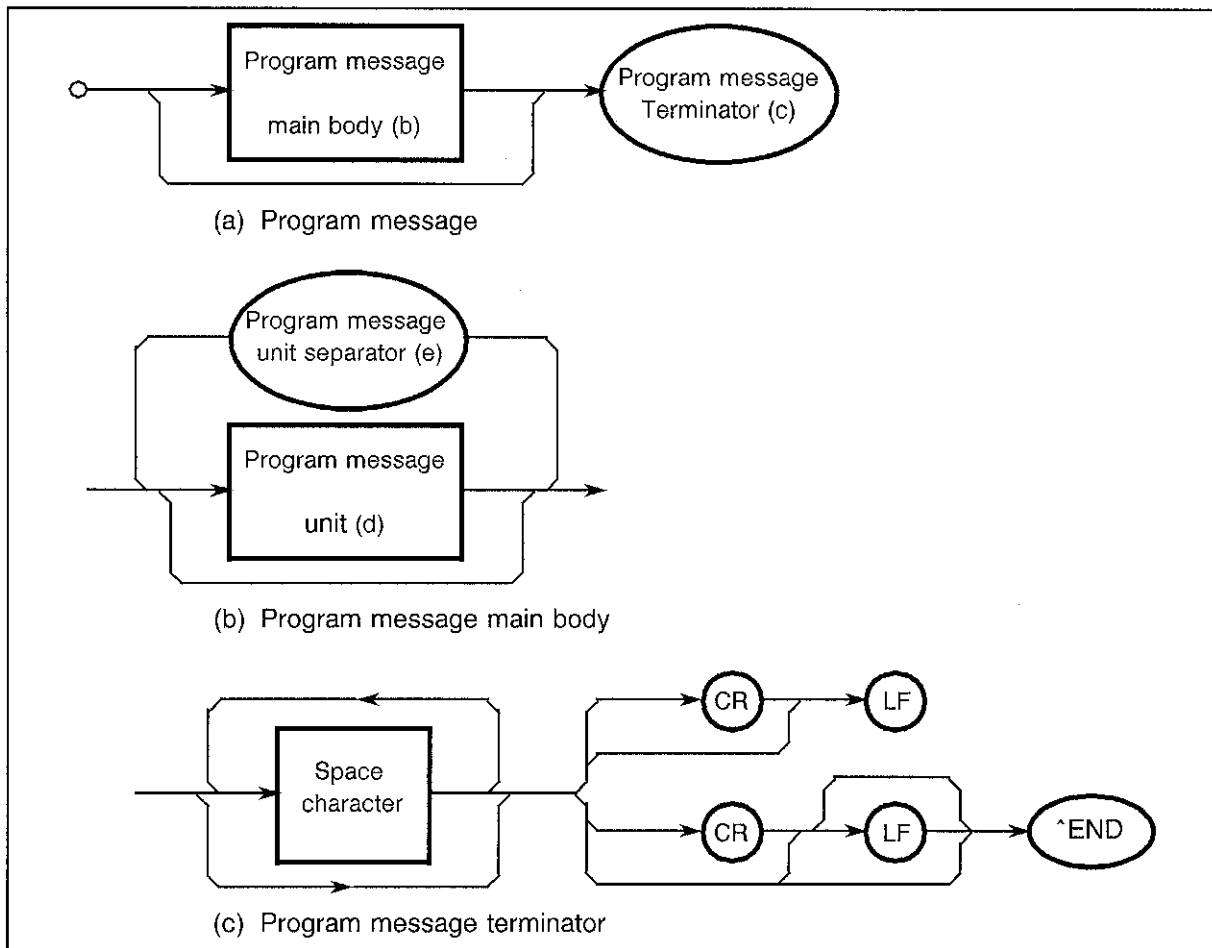

Figure 5-4 Basic Syntax of Program Message (1 of 3)

^END: EOI and ATN must be true and false, respectively, with the immediately preceding byte.

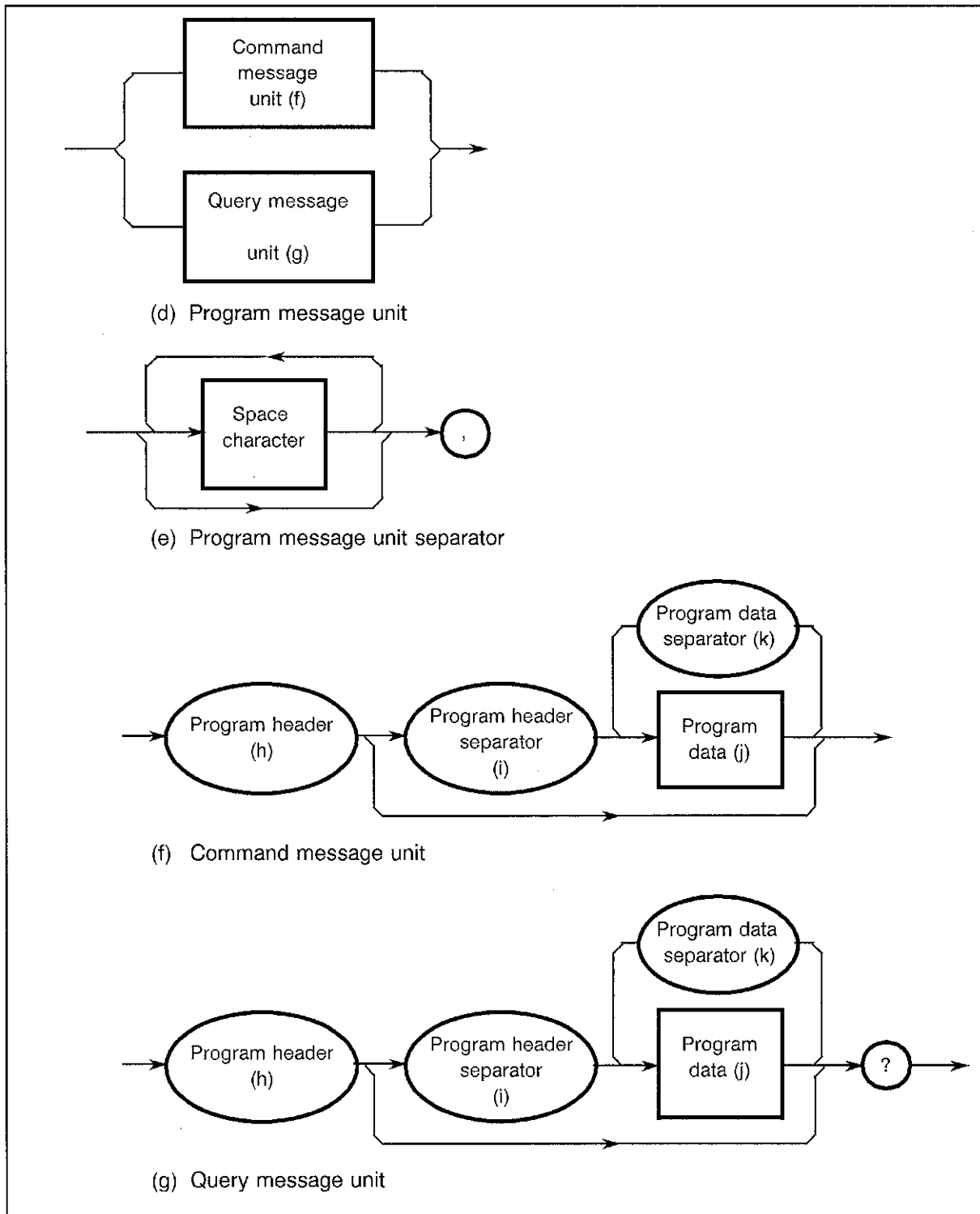

Figure 5-4 Basic Syntax of Program Message (2 of 3)

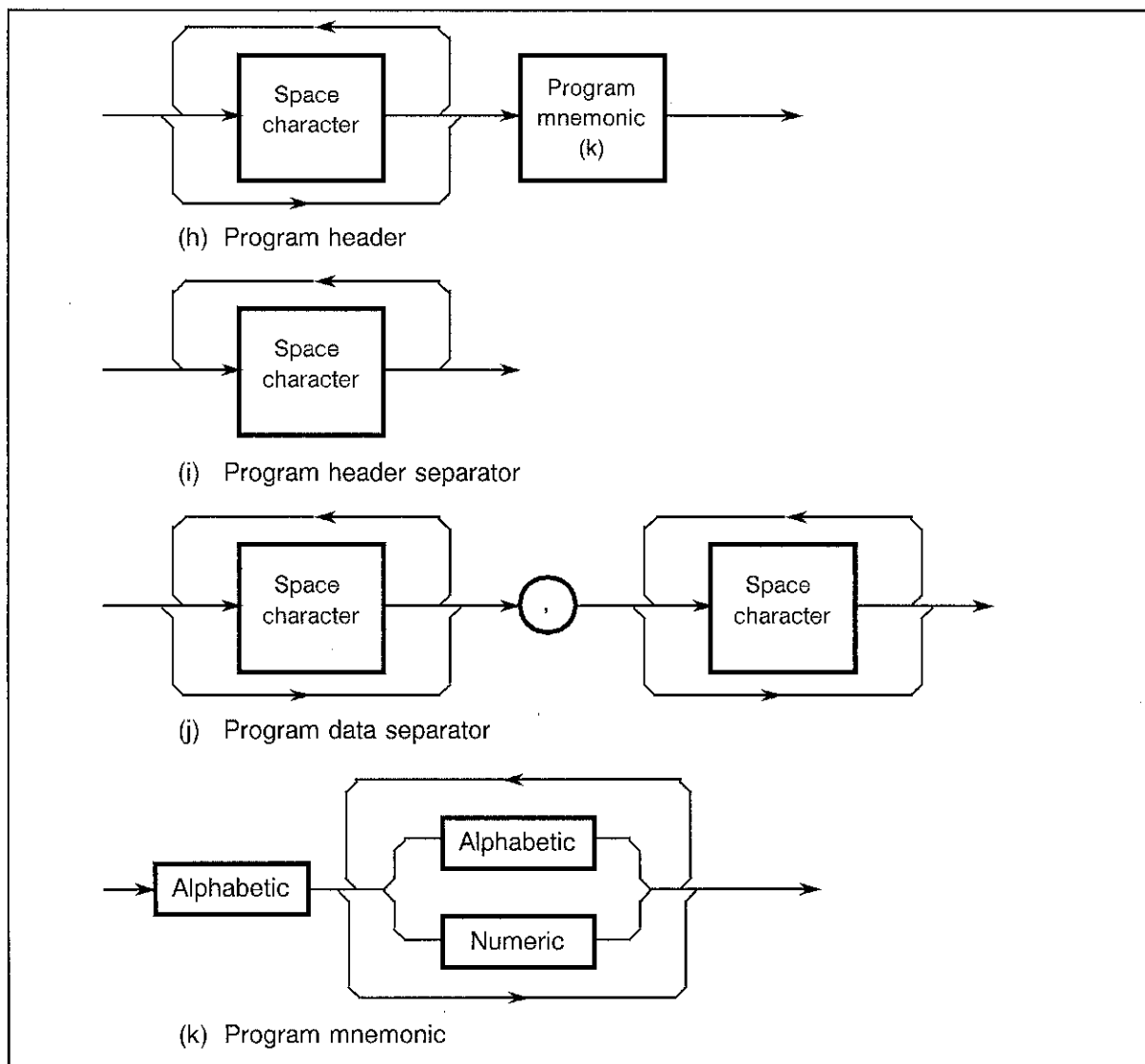

Figure 5-4 Basic Syntax of Program Message (3 of 3)

For program message terminator (record delimiter) in ASCII, the following coding can be used as shown in (c) of Figure 5-4; CR and LF ASCII codes are 13 and 10 (decimal), respectively:

- a. CR, LF^END Adds END message with the CR and LF.
- b. CR, LF CR and LF
- c. LF^END Adds END message with the LF.
- d. LF LF only
- e. CR^END Adds END message with the CR.
- f. ^END Adds END message with the final byte of program message

END message: Single-line signal EOI and ATN must be true and false, respectively.

^END: END message must be added with the immediately preceding byte.

D3186  
PULSE PATTERN GENERATOR  
OPERATION MANUAL

5.6 Program Message (Listener Format)

For program message terminator use with binary code, only END message added with the final byte can be used.

Length of program message received by D3186 is maximum 512 characters, excluding the setting WORD or FRAME pattern, including program message unit separator and program data separator, but excluding program message terminator. If program message length exceeds 512 characters and it contains incorrect code, a syntax error occurs, in which case, all subsequent coded up to program message terminator will be ignored.

### 5.6.2 Initialization Program Message

Code	Description
"Z"	Initializes each parameter (panel status initialization).
"C"	Initializes GPIB.

### 5.6.3 Service Request ("SRQ") Program Message

Code	Description
"S0"	Sends SRQ.
"S1"	Does not send SRQ.

If "S0" mode is specified, a syntax error occurrence will initiate a service request to controller. When an "SPE" command in serial polling execution is received, a status byte is sent.

D3186  
PULSE PATTERN GENERATOR  
OPERATION MANUAL

5.6 Program Message (Listener Format)

5.6.4 Command Program Message (Remote Code)

Table 5-2 shows D3186 command program messages.

Table 5-2 Command Program Message

(1 of 19)

Function name	Command Program Message	Description
(1) Clock frequency setting		
CLOCK RATE	"CR x" or "CR xE + 6" <div style="margin-left: 100px;">}                       x = 150.000 to 12000.000            For Option 13 and Option 72:            x = 150.000 to 12500.000            Unnecessary 0's after decimal point can be omitted.</div>	Sets frequency.  Unit: MHz for "CR x", Hz for "CR xE + 6"
CLOCK RATE MEMORY		Frequency memory
STORE	"RMS x" x = 0 to F	Stores into the specified number of memory.
RECALL	"RMR x" x = 0 to F	Recalls from the specified number of memory.

D3186  
PULSE PATTERN GENERATOR  
OPERATION MANUAL

5.6 Program Message (Listener Format)

(2 of 19)

Function name	Command Program Message	Description
(2) Pattern setting		
PATTERN MODE		Sets pattern mode:
PRBS	"PRBS"	To pseudo random
WORD	"WORD"	To WORD
FRAME	"FRAM"	To FRAME
PRBS 2 <sup>N</sup> -1		Sets step count N of pseudo random pattern:
N = 7	"PB 07,0" or "PB 7,0"	To 7
N = 9	"PB 09,0" or "PB 9,0"	To 9
N = 10	"PB 10,0"	To 10
N = 11	"PB 11,0"	To 11
N = 15	"PB 15,0"	To 15
N = 23	"PB 23,0"	To 23
N = 31	"PB 31,0" ,0 can be omitted.	To 31
MARK RATIO		Sets mark ratio:
0/8	"MR 0/8"	To 0/8
1/8	"MR 1/8"	To 1/8
1/4	"MR 1/4"	To 1/4
1/2	"MR 1/2"	To 1/2
8/8	"MR 8/8"	To 8/8
7/8	"MR 7/8"	To 7/8
3/4	"MR 3/4"	To 3/4
1/2B	"MR 1/2B"	To 1/2B

D3186  
PULSE PATTERN GENERATOR  
OPERATION MANUAL

5.6 Program Message (Listener Format)

(3 of 19)

Function name	Command Program Message	Description
PATTERN TRIGGER ADDRESS	“ADR x” x = 0 to 134217727 (PRBS) x = 0 to 524287 (WORD)	Sets trigger address of currently selected pattern mode.
PRBS PATTERN TRIGGER ADDRESS	“PBTAD x” x = 0 to 134217727	Sets trigger address of pseudo random pattern.
ALTERNATE MODE  ON  OFF	“ALTON”  “ALTOF”	Sets alternate mode:  To ON  To OFF
ALTERNATE PATTERN  OUTPUT A  OUTPUT B	“ALTA”  “ALTB”	Alternate pattern:  A is output.  B is output.
WORD PATTERN LENGTH	“BL x” or “PL x” x = 1 to 8388608	Sets word pattern length (bit count).
WORD PATTERN TRIGGER ADDRESS	“WDTAD x” x = 0 to 524287	Sets word pattern trigger address.
WORD PATTERN transmission,  hexapattern data type	“WP x,y,z” x: Address x = 0 to 524287 y: Size y = 1 to 512 z: Pattern data array according to size z = Array of 0 to 9 and A to F	<ul style="list-style-type: none"> <li>● Pattern data array consists of 4-bit character data. Characters are arranged according to the number specified by size.</li> <li>● Specified address is set as start address.</li> <li>● Single character data has LSB as start bit.</li> </ul>

D3186  
PULSE PATTERN GENERATOR  
OPERATION MANUAL

5.6 Program Message (Listener Format)

(4 of 19)

Function name	Command Program Message	Description
WORD PATTERN transmission,  binary pattern data type	"BIN x,y" x: Address x = 0 to 524287 y: Byte count y = 1 to 1048576	<ul style="list-style-type: none"> <li>• After receipt of program message terminator following the code on the left, binary data transmission mode is active until byte count is sent or END message is received.</li> <li>• Specified address is set as start address.</li> <li>• Binary data has LSB as start bit.</li> </ul>
WORD ALTERNATE PATTERN transmission,  hexapattern data type	"WwP x,y,z" w: Pattern w = A (Pattern A) w = B (Pattern B) x: Address x = 0 to 262143 y: Size y = 1 to 512 z: Pattern data array according to size. z = Array of 0 to 9 and A to F	<ul style="list-style-type: none"> <li>• Pattern data array consists of 4-bit character data. Characters are arranged according to the number specified by size.</li> <li>• Specified address is set as start address.</li> <li>• Single character data has LSB as start bit.</li> </ul>
WORD ALTERNATE PATTERN transmission,  binary pattern data type	"WwBIN x,y" w: Pattern w = A (Pattern A) w = B (Pattern B) x: Address x = 0 to 262143 y: Byte count y = 1 to 524288	<ul style="list-style-type: none"> <li>• After receipt of program message terminator following the code on the left, binary data transmission mode is active until byte count is sent or END message is received.</li> <li>• Specified address is set as start address.</li> <li>• Binary data has LSB as start bit.</li> </ul>
POLARITY (WORD)  NORMAL  INVERSE	"WPN"  "WPI"	Word pattern polarity is:  Noninverted  Inverted



D3186  
PULSE PATTERN GENERATOR  
OPERATION MANUAL

5.6 Program Message (Listener Format)

(5 of 19)

Function name	Command Program Message	Description
PAYLOAD TYPE		Sets payload type:
WORD	"PLW"	To WORD
PRBS	"PLP"	To pseudo random
CID	"CID"	To CID
FRAME STRUCTURE	<p>"FRSTR nf,fl,rl,ol,cl"</p> <p>nf: Frame count nf = 1 to 8192 (WORD, PRBS) nf = 2 (CID)</p> <p>fl: Row count fl = 1 to 16 (WORD, PRBS) fl = 1 (CID)</p> <p>rl: Byte count per row rl = 44 to 32768 (WORD, PRBS) rl = 40 to 32768 (CID)</p> <p>ol: Overhead byte count ol = 4 to rl - 40 (WORD, PRBS) ol = 36 to rl - 4 (CID)</p> <p>cl: Bit count of 0/1 continuous pattern cl = 0 (WORD, PRBS) cl = 0 to (rl-ol) × 8 - 1 (CID)</p> <p>For WORD and PRBS ,cl can be omitted.</p>	Sets frame pattern configuration.
FRAME STRUCTURE No. OF FRAME	<p>"NF x"</p> <p>x = 1 to 8192 (WORD, PRBS) x = 2 (CID)</p>	Sets frame pattern length (frame count).
FRAME STRUCTURE No. OF ROW	<p>"FL x"</p> <p>x = 1 to 16 (WORD, PRBS) x = 1 (CID)</p>	Sets frame length (row count) of frame pattern.

D3186  
PULSE PATTERN GENERATOR  
OPERATION MANUAL

5.6 Program Message (Listener Format)

(6 of 19)

Function name	Command Program Message	Description
FRAME STRUCTURE ROW LENGTH	“RL x” x = 44 to 32768 (WORD, PRBS) x = 40 to 32768 (CID)	Sets row length (byte count) of frame pattern.
FRAME STRUCTURE OVERHEAD LENGTH	“OL x” x = 4 to 32728 (WORD, PRBS) x = 36 to 32728 (CID)	Sets overhead length (byte count) of frame pattern.
FRAME STRUCTURE CID 0/1 LENGTH	“CL x” x = 0 (WORD, PRBS) x = 0 to 261855 (CID)	Sets 0/1 continuous pattern length (bit count) of frame pattern (CID).
FRAME PATTERN TRIGGER	“FRT fn,rn,bn” fn: Frame number fn = 1 to 8192 (WORD, PRBS) fn = 1 to 2 (CID) rn: Row number rn = 1 to 16 (WORD, PRBS) rn = 1 (CID) bn: Byte number bn = 1 to 32767	Sets trigger position of frame pattern.
FRAME PATTERN TRIGGER FRAME No.	“FRTFN x” x = 1 to 8192 (WORD, PRBS) x = 1 to 2 (CID)	Sets trigger frame number of frame pattern.
FRAME PATTERN TRIGGER ROW No.	“FRTRN x” x = 1 to 16 (WORD, PRBS) x = 1 (CID)	Sets row number of frame pattern.
FRAME PATTERN TRIGGER BYTE No.	“FRTBN x” x = 1 to 32767	Sets byte number of frame pattern.

D3186  
PULSE PATTERN GENERATOR  
OPERATION MANUAL

5.6 Program Message (Listener Format)

(7 of 19)

Function name	Command Program Message	Description
FRAME PATTERN transmission,  hexapattern data type	<p>“FP v,w,x,y,z”</p> <p>v: Frame number v = 1 to 8192</p> <p>w: Row number w = 1 to 16</p> <p>x: Byte number x = 1 to 32768</p> <p>y: Size y = 1 to 512</p> <p>z: Pattern data array according to size. z = Array of 0 to 9 and A to F.</p>	<ul style="list-style-type: none"> <li>• Pattern data array consists of 4-bit character data. Characters are arranged according to the number specified by size.</li> <li>• Specified address is set as start address.</li> <li>• Single character data has LSB as start bit.</li> </ul>
FRAME PATTERN transmission,  binary pattern data type	<p>“FBIN v,w,x,y”</p> <p>v: Frame number v = 1 to 8192</p> <p>w: Row number w = 1 to 16</p> <p>x: Byte number x = 1 to 32768</p> <p>y: Byte count y = 1 to 1048576</p>	<ul style="list-style-type: none"> <li>• After receipt of program message terminator following the code on the left, binary data transmission mode is active until byte count is sent or END message is received.</li> <li>• Specified address is set as start address.</li> <li>• Binary data has LSB as start bit.</li> </ul>
FRAME ALTERNATE PATTERN transmission,  hexapattern data type	<p>“FuP v,w,x,y,z”</p> <p>u: Patten u = A (Pattern A) u = B (Pattern B)</p> <p>v: Frame number v = 1 to 4096</p> <p>w: Row number w = 1 to 16</p> <p>x: Byte number x = 1 to 32768</p> <p>y: Size y = 1 to 512</p> <p>z: Pattern data array according to size. z = Array of 0 to 9 and A to F</p>	<ul style="list-style-type: none"> <li>• Pattern data array consists of 4-bit character data. Characters are arranged according to the number specified by size.</li> <li>• Specified address is set as start address.</li> <li>• Single character data has LSB as start bit.</li> </ul>

D3186  
PULSE PATTERN GENERATOR  
OPERATION MANUAL

5.6 Program Message (Listener Format)

(8 of 19)

Function name	Command Program Message	Description
FRAME ALTERNATE PATTERN transmission,  binary pattern data type	"FuBIN v,w,x,y,z" u: Patten u = A (Pattern A) u = B (Pattern B) v: Frame number v = 1 to 4096 w: Row number w = 1 to 16 x: Byte number x = 1 to 32768 y: Byte count y = 1 to 1048576	<ul style="list-style-type: none"> <li>• After receipt of program message terminator following the code on the left, binary data transmission mode is active until byte count is sent or END message is received.</li> <li>• Specified address is set as start address.</li> <li>• Binary data has LSB as start bit.</li> </ul>
POLARITY (FRAME)  NORMAL  INVERSE	"FPN"  "FPI"	Frame pattern polarity is:  Noninverted  Inverted
ERROR ADDITION	"EAD 0" (OFF) "EAD 4" ( $1 \times 10^{-4}$ ) "EAD 5" ( $1 \times 10^{-5}$ ) "EAD 6" ( $1 \times 10^{-6}$ ) "EAD 7" ( $1 \times 10^{-7}$ ) "EAD 8" ( $1 \times 10^{-8}$ ) "EAD 9" ( $1 \times 10^{-9}$ ) "EAD S" (SINGLE) "EAD E" (EXT)	Selects error addition rate.

D3186  
PULSE PATTERN GENERATOR  
OPERATION MANUAL

5.6 Program Message (Listener Format)

(9 of 19)

Function name	Command Program Message	Description
FRAME PRBS $2^N - 1$		Sets step count N of PAYLOAD pseudo random pattern:
N = 15	"FPB 15"	To 15
N = 23	"FPB 23"	To 23
N = 31	"FPB 31"	To 31
FRAME PRBS MARK RATIO		Sets mark ratio of PAYLOAD pseudo random pattern:
0/8	"FMR 0/8"	To 0/8
1/8	"FMR 1/8"	To 1/8
1/4	"FMR 1/4"	To 1/4
1/2	"FMR 1/2"	To 1/2
8/8	"FMR 8/8"	To 8/8
7/8	"FMR 7/8"	To 7/8
3/4	"FMR 3/4"	To 3/4
1/2B	"FMR 1/2B"	To 1/2B
FRAME ALTERNATE MODE		Sets alternate mode of frame pattern:
ON	"FALTON"	To ON
OFF	"FALTOFF"	To OFF
FRAME ALTERNATE PATTERN		Outputs alternate pattern of frame pattern:
OUTPUT A	"FALTA"	A
OUTPUT B	"FALTB"	B

D3186  
PULSE PATTERN GENERATOR  
OPERATION MANUAL

5.6 Program Message (Listener Format)

(10 of 19)

Function name	Command Program Message	Description
(3) Output setting		
DATA/DATA TRACKING ON OFF	"DTRKON" "DTRKOF"	DATA/DATA tracking function is: ON OFF
DATA OUTPUT MODE AC TO -2V TO 0V	"DAC" "DM2V" "DGND"	DATA output mode is: AC TO -2V TO 0V
DATA OFFSET MODE HIGH MIDDLE LOW	"DOFH" "DOFM" "DOFL"	DATA offset mode is: HIGH level MIDDLE level LOW level
DATA OUTPUT AMPLITUDE	"DAMP x" x = 0.50 to 2.00 (at TO 0V or AC) x = 0.60 to 1.00 (at TO -2V) For Option 15: x = 0.5 to 3.00 (at TO 0V) x = 0.5 to 2.00 (at TO AC) x = 0.6 to 1.00 (at TO -2V) Unnecessary 0's after decimal point can be omitted.	Sets amplitude of DATA output.  Unit: Vp-p

D3186  
PULSE PATTERN GENERATOR  
OPERATION MANUAL

5.6 Program Message (Listener Format)

(11 of 19)

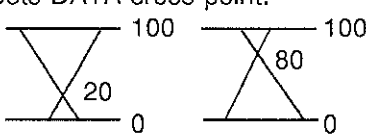
Function name	Command Program Message	Description
DATA OUTPUT OFFSET	<p>“DOFF x”</p> <p>x = -2.00 to +2.00 (at TO 0V)</p> <p>x = -1.00 to -0.60 (at TO -2V)</p> <p>For Option 15: x = -1.00 to +1.00 (at TO 0V)</p> <p>x = -1.00 to -0.60 (at TO -2V)</p> <p>For the range of offset mode MIDDLE and LOW, refer to Table 3-11. " + " can be omitted. Unnecessary 0's after decimal point can be omitted.</p>	<p>Sets offset of DATA output.</p> <p>Unit: V</p>
DATA CROSS-POINT ADJ ON OFF	<p>“DCPON”</p> <p>“DCPOF”</p>	<p>Sets cross point adjust of DATA to:</p> <p>ON OFF</p>
DATA CROSS-POINT (For GPIB only)	<p>“DCRP x”</p> <p>x = 20 to 80, integer</p>	<p>Sets DATA cross point.</p>  <p>Unit: %</p> <p>DATA CROSS-POINT ADJ and DATA CROSS-POINT are different functions. If this command is used, sets absolutely DATA CROSS-POINT ADJ to OFF. The DCRP and DBCRP command settings are independent even if the DATA/DATA TRACKING function is set to ON.</p>
DATA OUTPUT MODE AC TO -2V TO 0V	<p>“DBAC”</p> <p>“DBM2V”</p> <p>“DBGND”</p>	<p>Sets DATA output mode to:</p> <p>AC TO -2V TO 0V</p>

D3186  
PULSE PATTERN GENERATOR  
OPERATION MANUAL

5.6 Program Message (Listener Format)

(12 of 19)

Function name	Command Program Message	Description
$\overline{\text{DATA}}$ OFFSET MODE HIGH MIDDLE LOW	“DBOFH” “DBOFM” “DBOFL”	Sets offset mode of $\overline{\text{DATA}}$ to: HIGH level MIDDLE level LOW level
$\overline{\text{DATA}}$ OUTPUT AMPLITUDE	“DBAMP x” x = 0.50 to 2.00 (at TO 0V or AC) x = 0.60 to 1.00 (at TO -2V) For Option 15: x = 0.5 to 3.00 (at TO 0V) x = 0.5 to 2.00 (at TO AC) x = 0.6 to 1.00 (at TO -2V) Unnecessary 0's after decimal point can be omitted.	Sets amplitude of $\overline{\text{DATA}}$ output.  Unit: Vp-p
$\overline{\text{DATA}}$ OUTPUT OFFSET	“DBOFF x” x = -2.00 to +2.00 (at TO 0V) x = -1.00 to -0.60 (at TO -2V) For Option 15: x = -1.00 to +1.00 (at TO 0V) x = -1.00 to -0.60 (at TO -2V) For the range of offset mode MIDDLE and LOW, refer to Table 3-11. “+” can be omitted. Unnecessary 0's after decimal point can be omitted.	Sets offset of $\overline{\text{DATA}}$ output.  Unit: V
$\overline{\text{DATA}}$ CROSS-POINT ADJ  ON  OFF	“DBCPON”  “DBCPOF”	Sets cross point adjustment of $\overline{\text{DATA}}$ to:  ON  OFF



D3186  
PULSE PATTERN GENERATOR  
OPERATION MANUAL

5.6 Program Message (Listener Format)

(13 of 19)

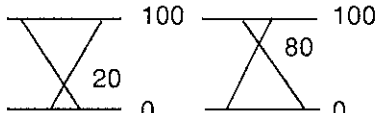
Function name	Command Program Message	Description
<p><math>\overline{\text{DATA}}</math> CROSS-POINT (For GPIB only)</p>	<p>"DBC RP x" x = 20 to 80, integer</p>	<p>Sets <math>\overline{\text{DATA}}</math> cross point.</p>  <p style="text-align: center;">Unit: %</p> <p><math>\overline{\text{DATA}}</math> CROSS-POINT ADJ and <math>\overline{\text{DATA}}</math> CROSS-POINT are different functions. If this command is used, sets absolutely <math>\overline{\text{DATA}}</math> CROSS-POINT ADJ to OFF. The DCRP and DBCRP command settings are independent even if the <math>\overline{\text{DATA}}</math>/<math>\overline{\text{DATA}}</math> TRACKING function is set to ON.</p>
<p>OUTPUT</p> <p>ON</p> <p>OFF</p>	<p>"OUTON"</p> <p>"OUTOF"</p>	<p>Sets <math>\overline{\text{DATA}}</math>/<math>\overline{\text{DATA}}</math> and <math>\overline{\text{CLOCK1}}</math>/<math>\overline{\text{CLOCK1}}</math> output to:</p> <p>ON</p> <p>OFF</p>
<p><math>\overline{\text{CLOCK1}}</math>/<math>\overline{\text{CLOCK1}}</math> TRACKING</p> <p>ON</p> <p>OFF</p>	<p>"CTR KON"</p> <p>"CTR KOF"</p>	<p>Sets <math>\overline{\text{CLOCK1}}</math>/<math>\overline{\text{CLOCK1}}</math> tracking function to:</p> <p>ON</p> <p>OFF</p>
<p><math>\overline{\text{CLOCK1}}</math> OUTPUT MODE</p> <p>AC</p> <p>TO -2V</p> <p>TO 0V</p>	<p>"CAC"</p> <p>"CM2V"</p> <p>"CGND"</p>	<p>Sets <math>\overline{\text{CLOCK1}}</math> output mode to:</p> <p>AC</p> <p>TO -2V</p> <p>TO 0V</p>
<p><math>\overline{\text{CLOCK1}}</math> OFFSET MODE</p> <p>HIGH</p> <p>MIDDLE</p> <p>LOW</p>	<p>"COFH"</p> <p>"COFM"</p> <p>"COFL"</p>	<p>Sets <math>\overline{\text{CLOCK1}}</math> offset mode to:</p> <p>HIGH level</p> <p>MIDDLE level</p> <p>LOW level</p>

D3186  
PULSE PATTERN GENERATOR  
OPERATION MANUAL

5.6 Program Message (Listener Format)

(14 of 19)

Function name	Command Program Message	Description
CLOCK1 OUTPUT AMPLITUDE	<p>"CAMP x"</p> <p>x = 0.50 to 2.00 (at TO 0V or AC)</p> <p>x = 0.60 to 1.00 (at TO -2V)</p> <p>Unnecessary 0's after decimal point can be omitted.</p>	<p>Sets amplitude of CLOCK1 output.</p> <p>Unit: Vp-p</p>
CLOCK1 OUTPUT OFFSET	<p>"COFF x"</p> <p>x = -2.00 to +2.00 (at TO 0V)</p> <p>x = -1.00 to -0.60 (at TO -2V)</p> <p>For the range of offset mode MIDDLE and LOW, refer to Table 3-11. "+" can be omitted.</p> <p>Unnecessary 0's after decimal point can be omitted.</p>	<p>Sets offset of CLOCK output.</p> <p>Unit: V</p>
CLOCK1 DUTY ADJ		Sets duty rate adjustment of CLOCK1 to:
ON	"CDTYON"	ON
OFF	"CDTYOF"	OFF
CLOCK1 OUTPUT MODE		Sets CLOCK1 output mode to:
AC	"CBAC"	AC
TO -2V	"CBM2V"	TO -2V
TO 0V	"CBGND"	TO 0V
CLOCK1 OFFSET MODE		Sets CLOCK1 offset mode to:
HIGH	"CBOFH"	HIGH level
MIDDLE	"CBOFM"	MIDDLE level
LOW	"CBOFL"	LOW level

D3186  
PULSE PATTERN GENERATOR  
OPERATION MANUAL

5.6 Program Message (Listener Format)

(15 of 19)

Function name	Command Program Message	Description
CLOCK1 OUTPUT AMPLITUDE	<p>"CBAMP x"</p> <p>x = 0.50 to 2.00 (at TO 0V or AC)</p> <p>x = 0.60 to 1.00 (at TO -2V)</p> <p>Unnecessary 0's after decimal point can be omitted.</p>	<p>Sets amplitude of <u>CLOCK1</u> output.</p> <p>Unit: Vp-p</p>
CLOCK1 OUTPUT OFFSET	<p>"CBOFF x"</p> <p>x = -2.00 to +2.00 (at TO 0V)</p> <p>x = -1.00 to -0.60 (at TO -2V)</p> <p>For the range of offset mode MIDDLE and LOW, refer to Table 3-11.</p> <p>"+" can be omitted.</p> <p>Unnecessary 0's after decimal point can be omitted.</p>	<p>Sets offset of <u>CLOCK1</u> output.</p> <p>Unit: V</p>
CLOCK1 DUTY ADJ		Sets duty rate adjustment of <u>CLOCK1</u> to:
ON	"CBDTYON"	ON
OFF	"CBDTYOF"	OFF
DELAY	<p>"DLY x"</p> <p>x = -400 to +400</p> <p>"+" can be omitted.</p>	<p>Sets delay.</p> <p>Unit: ps</p>
TRIGGER OUTPUT		Sets trigger output signal to:
1/32 CLOCK	"TGCLK"	1/32 CLOCK
PATTERN	"TGPTN"	PATTERN

D3186  
PULSE PATTERN GENERATOR  
OPERATION MANUAL

5.6 Program Message (Listener Format)

(16 of 19)

Function name	Command Program Message	Description
(4) Filing		
DIR	"DIR x" x: File type x = S — Setup x = W — Word pattern	Directory
LOAD	"LOAD x,y" x: File type x = S — Setup x = W — Word pattern y: File number y = 0 to 99	Word pattern
SAVE, RESAVE	"SAVE x,y" x: File type x = S — Setup x = W — Word pattern y: File number y = 0 to 99	Saving or resaving
DELETE	"DELE x,y" x: File type x = S — Setup x = W — Word pattern y: File number y = 0 to 99	Deleting
FORMAT	"FRMT"	Formatting (Initializing)

D3186  
PULSE PATTERN GENERATOR  
OPERATION MANUAL

5.6 Program Message (Listener Format)

(17 of 19)

Function name	Command Program Message	Description
(5) Calender/Clock operation		
CALENDER/CLOCK SETUP YMDHMS	"YMDHMS yy:mm:dd:hh:nn:ss" or "RTS yy:mm:dd:hh:nn:ss"	Calender/Clock setup Year, Month, Day, Hour, Minute, Second
	yy: Year, yy = 00 to 99 mm: Month, mm = 01 to 12 dd: Day, dd = 01 to 31 hh: Hour, hh = 00 to 23 nn: Minute, nn = 00 to 59 ss: Second, ss = 00 to 59	
CALENDER/CLOCK SETUP YMDH	"YMDH yy:mm:dd:hh" or "RTU yy:mm:dd:hh"	Calender/Clock setup Year, Month, Day, Hour
	yy: Year, yy = 00 to 99 mm: Month, mm = 01 to 12 dd: Day, dd = 01 to 31 hh: Hour, hh = 00 to 23	
CALENDER/CLOCK SETUP DHMS	"DHMS dd:hh:nn:ss" or "RTL dd:hh:nn:ss"	Calender/Clock setup Day, Hour, Minute, Second
	dd: Day, dd = 01 to 31 hh: Hour, hh = 00 to 23 nn: Minute, nn = 00 to 59 ss: Second, ss = 00 to 59	

D3186  
PULSE PATTERN GENERATOR  
OPERATION MANUAL

5.6 Program Message (Listener Format)

(18 of 19)

Function name	Command Program Message	Description
(6) GPIB and system setting		
PANEL LOCK		Sets panel lock to:
ON	“PLKON”	ON
OFF	“PLKOF”	OFF
CLEAR		Initialization:
PARAMETERS	“Z”	Initializes each setting parameter.
GPIB	“C”	Initializes for GPIB.
SERVICE REQUEST		Service request (SRQ) is:
ON	“S0”	Sent
OFF	“S1”	Not sent
RESPONSE MESSAGE TERMINATOR		Sets response message terminator to:
CR, LF^END	“DL0”	CR, LF^END
LF	“DL1”	LF only
^END	“DL2”	^END only

^END:            END message must be added with the immediately preceding byte.  
 END message:   Single-line signal EOI and ATN must be true and false, respectively.

D3186  
PULSE PATTERN GENERATOR  
OPERATION MANUAL

5.6 Program Message (Listener Format)

(19 of 19)

Function name	Command Program Message	Description
(7) External SG control code setting		
FREQUENCY SETTING CODE TRANSFORMATION	<p>“XFFRQ xxxx;yyyy;”</p> <p>x: Header after transformation should be 1 to 16 characters starting with an alphabet of A to Z. The second and after characters should be alphanumerics of A to Z and 0 to 9. The same code as other program header cannot be used.</p> <p>y: Trailer after transformation should be 0 to 64 characters. Use alphanumerics of A to Z and 0 to 9, marks of ASCII code 33 to 47 (decimal), or space.</p>	<p>Transformation of frequency setting code</p> <p>Transforms the original code "CW dddd.dddMZ", which sets frequency of dddd.ddd MHz, to "xxxx dddd.ddyyyy".</p>
INITIALIZATION CODE TRANSFORMATION	<p>“XFINI zzzz”</p> <p>z: Code after transformation should be 1 to 16 characters starting with an alphabet of A to Z. The second and after characters should be alphanumerics of A to Z and 0 to 9. The same code as other program header cannot be used.</p>	<p>Transformation of initialization code</p> <p>Transforms the original initialization-code "IP" to "zzzz".</p>

D3186  
PULSE PATTERN GENERATOR  
OPERATION MANUAL

---

**5.6 Program Message (Listener Format)**

- 1) The external SG control code can be set when the bit 3 and 4 of the SW1 dip switch on the rear panel (Ⓒ in Figure 2-6) is set to 1 (ON) (User Programmable).
- 2) When the setting of the SW1 dip switch is changed, turn off the D3186 power, wait 5 seconds or more, and then turn on the power.
- 3) When the bit 3 and 4 of the SW1 is set to 1 (ON), the code (LE3.9DM (sets 3.9 dBm) in AT code), which sets output level, is not output to the external SG. So, integrate the code into the trailer as required after transformation of frequency setting code.
- 4) When the bit 3 and 4 of the SW1 is set to 1 (ON), the program message terminator which is output to the external SG is set to either CR LF ^END, only LF or only ^END according to the setting of the reply message terminator (DL0, DL1 or DL1).



### 5.6.5 Word Pattern and Frame Pattern Settings

There are two ways of setting word pattern and frame pattern from the GPIB to D3186, (a) hex mode and (b) binary mode.

In hex mode, ASCII code is used to separate a pattern in units of 4 bits which are transmitted after conversion to a 1-byte hex character. In binary mode, a pattern is transmitted as binary values using a 1-byte code of 8 bits.

ASCII data type, hex mode, is readily edited with general computer edit software. Since the pattern is transmitted as is, binary mode is efficient and reduces transmission time to approximately half that in hex mode, depending on computer transmission software.

#### (1) Setting word pattern

##### (a) Hex mode setting format

“WP dddd, ddd,dddd……”  
 ①    ②    ③    ④

① Command program header

ALTERNATE mode OFF:        "WP"  
 ALTERNATE mode pattern A:    "WAP"  
 ALTERNATE mode pattern B:    "WBP"

Insert one or more spaces between above header characters and following ②.

② Start address of set pattern length (decimal)

ALTERNATE mode OFF:        0 to pattern length/16 - 1 (max. 524287)  
 ALTERNATE mode pattern A, B: 0 to pattern length/16 - 1 (max. 262143)

Add a single comma (",") between above numeric and following ③.

③ Pattern string character count (decimal)

1 to 512

Add a single comma (",") between above numeric and following ④.

④ Pattern character string (hex character string)

Hex character string of character count specified in ③. Data is sequentially transmitted starting from start bit (Bit 1) of start address specified in ②. 4-bit pattern is set for each character and least significant bit (LSB) in hex is assigned as bit nearest head of pattern.

D3186  
PULSE PATTERN GENERATOR  
OPERATION MANUAL

5.6 Program Message (Listener Format)

The part of pattern character strings exceeding set pattern length and/or exceeding character count specified in ③ are ignored. If pattern character string is shorter than character count specified in ③, sets the pattern up to end of pattern character string and terminates setting. If program message terminator or following program message unit is placed at end of pattern character string, add program message unit separator.

[Example] Setting code: "WP 12,5,E4BA2"

Results:

Address	Bit	1	2	3	4	5	6	7	8	9	10	11	12	13	14	15	16
12		0	1	1	1	0	0	1	0	1	1	0	1	0	1	0	1
13		0	1	0	0	—	—	—	—	—	—	—	—	—	—	—	—

— indicates unchanged bit.

(b) Binary mode setting format

"BIN dddd, ddd" [LF] dd.....  
 ①    ②    ③    ④    ⑤

① Command program header

ALTERNATE mode OFF: "BIN"  
 ALTERNATE mode pattern A: "WABIN"  
 ALTERNATE mode pattern B: "WBBIN"

Insert one or more spaces between above header characters and following ②.

② Start address of set pattern length (decimal)

ALTERNATE mode OFF: 0 to pattern length/16 - 1 (max. 524287)  
 ALTERNATE mode pattern A, B: 0 to pattern length/16 - 1 (max. 262143)

Add a single comma (",") between above numeric and following ③.

③ Pattern string byte count (decimal)

ALTERNATE mode OFF: 1 to 1048576  
 ALTERNATE mode pattern A, B: 1 to 524288

D3186  
PULSE PATTERN GENERATOR  
OPERATION MANUAL

5.6 Program Message (Listener Format)

- ④ Program message terminator

Completes program message to transmit binary pattern data string in following ⑤.

- ⑤ Binary pattern data string

8-bit binary code string of byte count specified in ③. Data is sequentially transmitted starting from start bit (Bit 1) of start address specified in ②. 8-bit pattern is set for each byte and LSB of 8 bits is assigned as bit nearest head of pattern.

The part of binary pattern data strings exceeding set pattern length and/or exceeding character count specified in ③ are ignored. If binary pattern data string is shorter than byte count specified in ③, sets the pattern up to last byte of binary data string and terminates setting.

Add END message (single-line signal EOI and ATN are true and false, respectively) as program message terminator to last byte of binary pattern data string. When END message is received or byte count specified in ③ is received, D3186 completes pattern transmission and returns to normal ASCII receive mode.

[Example] Setting code: "BIN 12,3"  
Binary code (decimal): 78,171,2

Results:

Address \ Bit	1	2	3	4	5	6	7	8	9	10	11	12	13	14	15	16
12	0	1	1	1	0	0	1	0	1	1	0	1	0	1	0	1
13	0	1	0	0	0	0	0	0	—	—	—	—	—	—	—	—

— indicates unchanged bit.

## (2) Setting frame pattern

All bits can be set for WORD payload type pattern and only bits in overhead section can be set for PRBS pattern. No bits can be set for CID payload type pattern.

### (a) Hex mode setting format

"FP dddd, dd, dddd, ddd, dddd....."  
① ② ③ ④ ⑤ ⑥

① Command program header

ALTERNATE mode OFF: "FP"  
ALTERNATE mode pattern A: "FAP"  
ALTERNATE mode pattern B: "FBP"

Insert one or more spaces between above header characters and following ②.

② Start frame No. of set pattern length (decimal)

ALTERNATE mode OFF: 1 to frame count (max. 8192)  
ALTERNATE mode pattern A, B: 1 to frame count (max. 4096)

Add a single comma (",") between above numeric and following ③.

③ Start row No. of set pattern length (decimal)

1 to row count (max. 16)

Add a single comma (",") between above numeric and following ④.

④ Start byte No. of set pattern length (decimal)

Payload type WORD: 1 to byte count per row (max. 32768)  
Payload type PRBS: 1 to overhead byte count (max. 32728)

Add a single comma (",") between above numeric and following ⑤.

⑤ Pattern string character count (decimal)

1 to 512

Add a single comma (",") between above numeric and following ⑥.

D3186  
PULSE PATTERN GENERATOR  
OPERATION MANUAL

5.6 Program Message (Listener Format)

⑥ Pattern character string (hex)

Hex character string of character count specified in ⑤. Data is sequentially transmitted starting from start bit (Bit 1) of frame number, row number and byte number specified in ②, ③, and ④. 4-bit pattern is set for each character and least significant bit (LSB) in hex is assigned as bit nearest head of pattern.

The part of pattern character strings exceeding set pattern length and/or exceeding character count specified in ⑤, and the payload part in payload type PRBS are ignored. If pattern character string is shorter than character count specified in ⑤, sets the pattern up to end of pattern character string and terminates setting.

If program message terminator or following program message unit is placed at end of pattern character string, add program message unit separator.

(b) Binary mode setting format

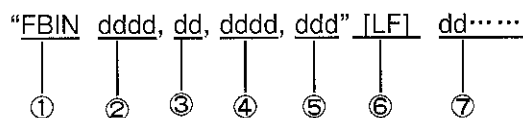

① Command program header

ALTERNATE mode OFF: "FBIN"  
ALTERNATE mode pattern A: "FABIN"  
ALTERNATE mode pattern B: "FBBIN"

Insert one or more spaces between above header characters and following ②.

② Start frame No. of set pattern length (decimal)

ALTERNATE mode OFF: 1 to frame count (max. 8192)  
ALTERNATE mode pattern A, B: 1 to frame count (max. 4096)

Add a single comma (",") between above numeric and following ③.

③ Start row No. of set pattern length (decimal)

1 to row count (max. 16)

Add a single comma (",") between above numeric and following ④.

④ Start byte No. of set pattern length (decimal)

Payload type WORD: 1 to byte count per row (max. 32768)  
Payload type PRBS: 1 to overhead byte count (max. 32728)

Add a single comma (",") between above numeric and following ⑤.

D3186  
PULSE PATTERN GENERATOR  
OPERATION MANUAL

5.6 Program Message (Listener Format)

⑤ Pattern string byte count (decimal)

ALTERNATE mode OFF: 1 to 1048576

ALTERNATE mode pattern A, B: 1 to 524288

⑥ Program message terminator

Completes program message to transmit binary pattern data string in following ⑦.

⑦ Binary pattern data string

8-bit binary code string of byte count specified in ⑤. Data is sequentially transmitted starting from start bit (Bit 1) of frame No., row No. and byte No. specified in ②, ③, and ④. 8-bit pattern is set for each byte and LSB of 8 bits is assigned as bit nearest head of pattern.

The part of binary pattern data strings exceeding set pattern length and/or exceeding character count specified in ⑤, and the payload part in payload type PRBS are ignored. If binary pattern data string is shorter than byte count specified in ⑤, sets the pattern up to last byte of binary data string and terminates setting.

Add END message (single-line signal EOI and ATN are true and false, respectively) as program message terminator to last byte of binary pattern data string. When END message is received or byte count specified in ⑤ is received, D3186 completes pattern transmission and returns to normal ASCII receive mode.

## 5.7 Query Program Message and Response Message

### 5.7.1 What is Query Program Message?

A query program message is an instruction used by controller to acquire parameter, function, or mode status of equipment (D3186) and to request a response from equipment (D3186) to the GPIB.

When programming, "?" is sent following the code - specifying parameter, function or mode inquired. D3186 partially implements the "OP" (Output Interrogated Parameter) command which has a function equivalent to query program message.

Use of "OP" command requires sending code - specifying parameter, function, or mode inquired following "OP" characters. Response to both commands becomes code to set inquired parameter, function, or mode.

[Example] In case of HP200 Series (BASIC)

```
10 DIM A$ [20]
20 OUTPUT 708 ; "CR 1234.56"
30 OUTPUT 708 ; "CR?" (or "OPCR")
40 ENTER 708 ; A$
50 DISP A$
60 END
```

(Program explanation)

Line number	Description
10	Reserves 20 bytes for character string variable A\$.
20	Sets clock frequency to 1234.56 MHz
30	Inquires clock frequency setting state.
40	Specifies D3186 for talker and reads response to A\$.
50	Displays response A\$.
60	Terminates program.

D3186  
PULSE PATTERN GENERATOR  
OPERATION MANUAL

5.7 Query Program Message and Response Message

### 5.7.2 Query Program Message and Response Message Formats

Table 5-3 shows formats of D3186 query program message, "OP" command, and corresponding response message.

Table 5-3 Query Program Message and Response Message

(1 of 17)

Function name	Query program message, OP command	Response message format	Description
(1) Clock frequency setting			
CLOCK RATE	"CR?" or "OPCR"	"CR xE + 6" x = 00150.111 to 12000.000 For Option 13 and Option 72: x = 00150.000 to 12500.000	Frequency setting value Unit: Hz
CLOCK RATE MEMORY	"RM?" or "OPRM"	"RM x" x = 0 to F	Frequency memory number
(2) Pattern setting			
PATTERN MODE  PRBS WORD FRAME	"PM?" or "OPPM"	"PRBS" "WORD" "FRAM"	Pattern mode:  Pseudo random WORD FRAME
PRBS 2 <sup>N</sup> -1  N = 7 N = 9 N = 10 N = 11 N = 15 N = 23 N = 31	"PB?" or "OPPB"	"PB 07,0" "PB 09,0" "PB 10,0" "PB 11,0" "PB 15,0" "PB 23,0" "PB 31,0"	Step count N of pseudo random pattern  7 9 10 11 15 23 31



D3186  
PULSE PATTERN GENERATOR  
OPERATION MANUAL

5.7 Query Program Message and Response Message

(2 of 17)

Function name	Query program message, OP command	Response message format	Description
MARK RATIO  0/8  1/8  1/4  1/2  8/8  7/8  3/4  1/2B	} "MR?" or "OPMR"	"MR 0/8"  "MR 1/8"  "MR 1/4"  "MR 1/2"  "MR 8/8"  "MR 7/8"  "MR 3/4"  "MR 1/2B"	Mark ratio  0/8  1/8  1/4  1/2  8/8  7/8  3/4  1/2B
PATTERN TRIGGER ADDRESS	} "ADR?" or "OPADR"	"ADR x" x = 000000000 to 134217727 (PRBS) x = 000000000 to 000524287 (WORD)	Trigger address of currently selected pattern mode
PRBS PATTERN TRIGGER ADDRESS	} "PBTAD?"	"PBTAD x" x = 000000000 to 134217727	Trigger address of pseudo random pattern
ALTERNATE MODE  ON  OFF	} "ALT?"	"ALTON"  "ALTOF"	Alternate mode  ON  OFF
ALTERNATE PATTERN OUTPUT  A  B	} "ALTMD?"	"ALTA"  "ALTB"	Alternate output pattern  A  B

D3186  
PULSE PATTERN GENERATOR  
OPERATION MANUAL

5.7 Query Program Message and Response Message

(3 of 17)

Function name	Query program message, OP command	Response message format	Description
WORD PATTERN LENGTH	"BL?" or "OPBL"	"BL x" x = 0000001 to 8388608	Word pattern length (bit count)
	"PL?"	"PL x" x = 0000001 to 8388608	
WORD PATTERN TRIGGER ADDRESS	"WDTAD?"	"WDTAD x" x = 000000000 to 000524287	Word pattern trigger address
WORD PATTERN contents,  hex pattern data type	"WP x,y?" or "OPWP x,y" x: Address x = 0 to 524287 y: Size y = 1 to 512	"WP x,y,z" x: Address x = 000000 to 524287 y: Size y = 001 to 512 z: Pattern data array according to size z = Array of 0 to 9 and A to F	<ul style="list-style-type: none"> <li>• Pattern data array consists of 4-bit character data. Characters are arranged according to the number specified by size.</li> <li>• Specified address is set as start address.</li> <li>• Single character data has LSB as start bit.</li> </ul>
WORD ALTERNATE PATTERN contents,  hex pattern data type	"WwP x,y?" w: Pattern w = A (Pattern A) w = B (Pattern B) x: Address x = 0 to 262143 y: Size y = 1 to 512	"Wwp x,y,z" w: Pattern w = A (Pattern A) w = B (Pattern B) x: Address x = 0 to 262143 y: Size y = 001 to 512 z: Pattern data array according to size z = Array of 0 to 9 and A to F	<ul style="list-style-type: none"> <li>• Pattern data array consists of 4-bit character data. Characters are arranged according to the number specified by size.</li> <li>• Specified address is set as start address.</li> <li>• Single character data has LSB as start bit.</li> </ul>

D3186  
PULSE PATTERN GENERATOR  
OPERATION MANUAL

5.7 Query Program Message and Response Message

(4 of 17)

Function name	Query program message, OP command	Response message format	Description
WORD POLARITY NORMAL INVERSE	“WP?” or “OPWP” }	“WPN”  “WPI”	Word pattern polarity:  Noninverted  Inverted
PAYLOAD TYPE WORD PRBS CID	“PLT?” }	“PLW”  “PLP”  “CID”	Payload type:  WORD  Pseudo random  CID
FRAME STRUCTURE	“FRSTR?”	“FRSTR nf,fl,rl,ol,cl” nf: Frame count nf = 0001 to 8182 (WORD, PRBS) nf = 0002 (CID) fl: Row count fl = 01 to 16 (WORD, PRBS) fl = 01 (CID) rl: Byte count per row rl = 00044 to 32768 (WORD, PRBS) rl = 00040 to 32768 (CID) ol: Overhead byte count ol = 4 to rl - 40 (WORD, PRBS) ol = 36 to rl - 4 (CID) cl: Bit count of 0/1 continuous pattern cl = 000000 (WORD, PRBS) cl = 000001 to 261855 (CID)	Frame pattern configuration.  Payload type configuration set at that time is returned as response.

D3186  
PULSE PATTERN GENERATOR  
OPERATION MANUAL

5.7 Query Program Message and Response Message

(5 of 17)

Function name	Query program message, OP command	Response message format	Description
FRAME STRUCTURE No. OF FRAME	"NF?"	"NF x" x = 0001 to 8182 (WORD, PRBS) x = 0002 (CID)	Frame pattern length (frame count)
FRAME STRUCTURE No. OF ROW	"FL?"	"FL x" x = 01 to 16 (WORD, PRBS) x = 01 (CID)	Frame length (row count) of frame pattern
FRAME STRUCTURE ROW LENGTH	"RL?"	"RL x" x = 00044 to 32768 (WORD, PRBS) x = 00040 to 32768 (CID)	Row length (byte count) of frame pattern.
FRAME STRUCTURE OVERHEAD LENGTH	"OL?"	"OL x" x = 00004 to 32768 (WORD, PRBS) x = 00036 to 32760 (CID)	Overhead length (byte count) of frame pattern
FRAME STRUCTURE CID 0/1 LENGTH	"CL?"	"CL x" x = 000000 (WORD, PRBS) x = 000001 to 261855 (CID)	0/1 continuous pattern length (bit count) of frame pattern (CID)
FRAME PATTERN TRIGGER	"FRT?"	"FRT fn,rn,bn" fn: Frame number fn = 0001 to 8192 (WORD, PRBS) fn = 0001 to 0002 (CID) rn: Row number rn = 01 to 16 (WORD, PRBS) rn = 01 (CID) bn: Byte number bn = 00001 to 32767	Trigger position of frame pattern  Trigger position set at that time is returned as response.

D3186  
PULSE PATTERN GENERATOR  
OPERATION MANUAL

5.7 Query Program Message and Response Message

(6 of 17)

Function name	Query program message, OP command	Response message format	Description
FRAME PATTERN TRIGGER FRAME No.	"FRTFN?"	"FRTFN x" x = 0001 to 8182 (WORD, PRBS) x = 0001 to 0002 (CID)	Trigger frame number of frame pattern
FRAME PATTERN TRIGGER ROW No.	"FRTRN?"	"FRTRN x" x = 01 to 16 (WORD, PRBS) x = 01 (CID)	Trigger row number of frame pattern
FRAME PATTERN TRIGGER BYTE No.	"FRTBN?"	"FRTBN x" x = 00001 to 32767	Trigger byte number of frame pattern
FRAME PATTERN contents,  hex pattern data type	"FP v,w,x,y?" v: Frame number v = 0 to 8192 w: Row number w = 1 to 16 x: Byte number x = 0 to 32768 y: Size y = 1 to 512	"FP v,w,x,y,z" v: Frame number v = 0001 to 8192 w: Row number w = 01 to 16 x: Byte number x = 00001 to 32768 y: Size y = 001 to 512 z: Pattern data array according to size z = Array of 0 to 9 and A to F	<ul style="list-style-type: none"> <li>● Pattern data array consists of 4-bit character data. Characters are arranged according to the number specified by size.</li> <li>● Specified address is set as start address.</li> <li>● Single character data has LSB as start bit.</li> </ul>

D3186  
PULSE PATTERN GENERATOR  
OPERATION MANUAL

5.7 Query Program Message and Response Message

(7 of 17)

Function name	Query program message, OP command	Response message format	Description
FRAME ALTERNATE PATTERN contents,  hex pattern data type	<p>“FuP v,w,x,y?”</p> <p>u: Pattern u = A (Pattern A) u = B (Pattern B)</p> <p>v: Frame number v = 1 to 4196</p> <p>w: Row number w = 1 to 16</p> <p>x: Byte number x = 0 to 32768</p> <p>y: Size y = 1 to 512</p>	<p>“FuP v,w,x,y,z”</p> <p>u: Pattern u = A (Pattern A) u = B (Pattern B)</p> <p>v: Frame number v = 0001 to 4196</p> <p>w: Row number w = 01 to 16</p> <p>x: Byte number x = 00001 to 32768</p> <p>y: Size y = 001 to 512</p> <p>z: Pattern data array according to size z = Array of 0 to 9 and A to F</p>	<ul style="list-style-type: none"> <li>Pattern data array consists of 4-bit character data. Characters are arranged according to the number specified by size.</li> <li>Specified address is set as start address.</li> <li>Single character data has LSB as start bit.</li> </ul>
FRAME POLARITY  NORMAL  INVERSE	<p>“FP?”</p> <p>}    }</p>	<p>“FPN”</p> <p>“FPI”</p>	<p>Frame pattern polarity:</p> <p>Noninverted</p> <p>Inverted</p>
ERROR ADDITION	<p>“EAD?” or “OPEAD?”</p>	<p>“EAD 0” (OFF)</p> <p>“EAD 4” (1 × 10<sup>-4</sup>)</p> <p>“EAD 5” (1 × 10<sup>-5</sup>)</p> <p>“EAD 6” (1 × 10<sup>-6</sup>)</p> <p>“EAD 7” (1 × 10<sup>-7</sup>)</p> <p>“EAD 8” (1 × 10<sup>-8</sup>)</p> <p>“EAD 9” (1 × 10<sup>-9</sup>)</p> <p>“EAD E” (EXT)</p>	<p>Error addition rate</p>
FRAME PRBS 2 <sup>N</sup> - 1  N = 15  N = 23  N = 31	<p>“FPB?”</p> <p>}    }</p>	<p>“FPB 15”</p> <p>“FPB 23”</p> <p>“FPB 31”</p>	<p>Sets step count N of PAYLOAD pseudo random pattern:</p> <p>To 15</p> <p>To 23</p> <p>To 31</p>

D3186  
PULSE PATTERN GENERATOR  
OPERATION MANUAL

5.7 Query Program Message and Response Message

(8 of 17)

Function name	Query program message, OP command	Response message format	Description
FRAME PRBS MARK RATIO  0/8  1/8  1/4  1/2  8/8  7/8  3/4  1/2B	"FMR?"  }  }  }  }  }  }  }  }	"FMR 0/8"  "FMR 1/8"  "FMR 1/4"  "FMR 1/2"  "FMR 8/8"  "FMR 7/8"  "FMR 3/4"  "FMR 1/2B"	Sets mark ratio of PAYLOAD pseudo random pattern:  To 0/8  To 1/8  To 1/4  To 1/2  To 8/8  To 7/8  To 3/4  To 1/2B
FRAME ALTERNATE MODE  ON  OFF	"FALT?"  }  }	"FALTON"  "FALTOFF"	Sets alternate mode of frame pattern:  To ON  To OFF
FRAME ALTERNATE PATTERN  OUTPUT A  OUTPUT B	"FALTMD?"  }  }	"FALTA"  "FALTB"	Outputs alternate pattern of frame pattern:  A  B

D3186  
PULSE PATTERN GENERATOR  
OPERATION MANUAL

5.7 Query Program Message and Response Message

(9 of 17)

Function name	Query program message, OP command	Response message format	Description
(3) Output setting			
DATA/DATA TRACKING  ON OFF	“DTRK?” or “OPDTRK” }	“DTRKON” “DTRKOF”	Sets DATA/DATA tracking to:  ON OFF
DATA OUTPUT MODE  AC TO -2V TO 0V	“DOM?” or “OPDOM” }	“DAC” “DM2V” “DGND”	Sets DATA output mode to:  AC TO -2V TO 0V
DATA OFFSET MODE  HIGH MIDDLE LOW	“DOFLV?” }	“DOFH” “DOFM” “DOFL”	Sets DATA offset mode to: HIGH level MIDDLE level LOW level
DATA OUTPUT AMPLITUDE	“DAMP?” or “OPDAMP”	“DAMP x” x = 0.50 to 2.00 (at TO 0V or AC) x = 0.60 to 1.00 (at TO -2V) For Option 15 x = 0.50 to 3.00 (at TO 0V) x = 0.50 to 2.00 (at TO AC) x = 0.60 to 1.00 (at TO -2V)	Sets DATA output amplitude.  Unit: Vp-p



D3186  
PULSE PATTERN GENERATOR  
OPERATION MANUAL

5.7 Query Program Message and Response Message

(10 of 17)

Function name	Query program message, OP command	Response message format	Description
DATA OUTPUT OFFSET	"DOFF?" or "OPDOFF"	"DOFF x" Offset mode HIGHT x = -2.00 to +2.00 (at TO 0V) x = -1.00 to -0.60 (at TO -2V) For Option 15: x = -1.00 to +1.00 (at TO 0V) x = -1.00 to -0.60 (at TO -2V) For the range of offset mode MIDDLE and LOW, refer to Table 3-11.	Sets DATA output offset.  Unit: V
DATA CROSS-POINT ADJ  ON  OFF	"DCP?" or "OPDCP"  }  }	"DCPON"  "DCPOF"	Adjusts DATA cross point to:  ON  OFF
DATA CROSS-POINT	"DCRP?"	"DCRP x" x = 20 to 80, integer	DATA cross point
DATA OUTPUT MODE  AC  TO -2V  TO 0V	"DBOM?" or "OPDBOM"  }  }	"DBAC"  "DBM2V"  "DBGND"	Sets DATA output mode to:  AC  TO -2V  TO 0V

D3186  
PULSE PATTERN GENERATOR  
OPERATION MANUAL

5.7 Query Program Message and Response Message

(11 of 17)

Function name	Query program message, OP command	Response message format	Description
DATA OFFSET MODE  HIGH  MIDDLE  LOW	“DBOFLV?”  }  }	“DBOFH”  “DBOFM”  “DBOFL”	Sets DATA offset mode to:  HIGH level  MIDDLE level  LOW level
DATA OUTPUT AMPLITUDE	“DBAMP?” or “OPDBAMP”	“DBAMP x” x = 0.50 to 2.00 (at TO 0V or AC) x = 0.60 to 1.00 (at TO -2V) For Option 15 x = 0.50 to 3.00 (at TO 0V) x = 0.50 to 2.00 (at TO AC) x = 0.60 to 1.00 (at TO -2V)	Sets DATA output amplitude.  Unit: Vp-p
DATA OUTPUT OFFSET	“DBOFF?” or “OPDBOFF”	“DBOFF x” Offset mode HIGHT x = -2.00 to +2.00 (at TO 0V) x = -1.00 to -0.60 (at TO -2V) For Option 15: x = -1.00 to +1.00 (at TO 0V) x = -1.00 to -0.60 (at TO -2V)  For the range of offset mode MIDDLE and LOW, refer to Table 3-11. " + " can be omitted. Unnecessary 0's after decimal point can be omitted.	Sets DATA output offset.  Unit: V

D3186  
PULSE PATTERN GENERATOR  
OPERATION MANUAL

5.7 Query Program Message and Response Message

(12 of 17)

Function name	Query program message, OP command	Response message format	Description
DATA CROSS-POINT ADJ  ON  OFF	“DBCP?” or “OPDBCP”  }	“DBCPON”  “DBCPOF”	Sets adjustment of DATA cross point to:  ON  OFF
DATA CROSS-POINT	“DBCRP?”	“DBCRP x” x = 20 to 80, integer	DATA cross point
DATA/DATA OUTPUT  ON  OFF	“OUT?”  }	“OUTON”  “OUTOF”	Sets DATA/DATA output to:
CLOCK1/CLOCK1 TRACKING  ON  OFF	“CTRK?” or “OPCTRK”  }	“CTRKON”  “CTRKOF”	Sets CLOCK1/CLOCK1 tracking to: ON  OFF
CLOCK1 OUTPUT MODE  AC  TO -2V  TO 0V	“COM?” or “OPCOM”  }	“CAC”  “CM2V”  “CGND”	Sets CLOCK1 output mode to:  AC  TO -2V  TO 0V
CLOCK1 OFFSET MODE  HIGH  MIDDLE  LOW	“COFLV?”  }	“COFH”  “COFM”  “COFL”	Sets CLOCK1 offset mode to:  High level  Middle level  Low level

D3186  
PULSE PATTERN GENERATOR  
OPERATION MANUAL

5.7 Query Program Message and Response Message

(13 of 17)

Function name	Query program message, OP command	Response message format	Description
CLOCK1 OUTPUT AMPLITUDE	"CAMP?" or "OPCAMP"	"CAMP x" x = 0.50 to 2.00 (at TO 0V or AC) x = 0.60 to 1.00 (at -2V)	Sets CLOCK1 output amplitude.  Unit: Vp-p
CLOCK1 OUTPUT OFFSET	"COFF?" or "OPCOFF"	"COFF" x = -2.00 to +2.00 (at TO 0V) x = -1.00 to -0.60 (at -2V)	Sets CLOCK1 output offset.  Unit: V
CLOCK1 DUTY ADJ  ON  OFF	"CDTY?" or "OPCDTY"	"CDTYON"  "CDTYOF"	Sets adjustment of CLOCK1 duty rate to:  ON  OFF
CLOCK1 OUTPUT MODE  AC  TO -2V  TO 0V	"CBOM?" or "OPCBOM"	"CBAC"  "CBM2V"  "CBGND"	Sets $\overline{\text{CLOCK1}}$ output mode to:  AC  TO -2V  TO 0V
CLOCK1 OFFSET MODE  HIGH  MIDDLE  LOW	"CBOFLV?"	"CBOFH"  "CBOFM"  "CBOFL"	Sets $\overline{\text{CLOCK1}}$ offset mode to:  High level  Middle level  Low level

D3186  
PULSE PATTERN GENERATOR  
OPERATION MANUAL

5.7 Query Program Message and Response Message

(14 of 17)

Function name	Query program message, OP command	Response message format	Description
CLOCK1 OUTPUT AMPLITUDE	"CBAMP?" or "OPCBAMP"	"CBAMP x" x = 0.50 to 2.00 (at TO 0V or AC) x = 0.60 to 1.00 (at -2V)	Sets <u>CLOCK1</u> output amplitude.  Unit: Vp-p
CLOCK1 OUTPUT OFFSET	"CBOFF?" or "OPCBOFF"	"CBOFF" x = -2.00 to +2.00 (at TO 0V) x = -1.00 to -0.60 (at -2V)	Sets <u>CLOCK1</u> output offset.  Unit: V
CLOCK1 DUTY ADJ  ON  OFF	"CBDTY?" or "OPCBDTY"  }	"CBDTYON"  "CBDTYOF"	Sets adjustment of <u>CLOCK1</u> duty rate to:  ON  OFF
DELAY	"DLY?" or "OPDLY"	"DLY x" x = -400 to +400	Sets delay.  Unit: ps
TRIGGER OUTPUT  1/32 CLOCK  PATTERN	"TG?"  }	"TGCLK"  "TGPTN"	Sets trigger output signal to:  1/32 CLOCK  PATTERN

D3186  
PULSE PATTERN GENERATOR  
OPERATION MANUAL

5.7 Query Program Message and Response Message

(15 of 17)

Function name	Query program message, OP command	Response message format	Description
(4) Calender/Clock operation			
CALENDER/CLOCK DATA  YMDHMS	"RTS?" or "YMDHMS"	"RTS yy:mm:dd:hh:nn:ss"  yy: Year, yy = 00 to 99 mm: Month, mm = 01 to 12 dd: Day, dd = 01 to 31 hh: Hour, hh = 00 to 23 nn: Minute, nn = 00 to 59 ss: Second, ss = 00 to 59	Sets the current value of calender/clock.  Year, month, day, hour, minute and second
CALENDER/CLOCK DATA  YMDH	"RTU?" or "YMDH"	"RTU yy:mm:dd:hh"  yy: Year, yy = 00 to 99 mm: Month, mm = 01 to 12 dd: Day, dd = 01 to 31 hh: Hour, hh = 00 to 23	Sets the current value of calender/clock.  Year, month, day and hour
CALENDER/CLOCK DATA  DHMS	"RTL?" or "DHMS"	"RTL dd:hh:nn:ss"  dd: Day, dd = 01 to 31 hh: Hour, hh = 00 to 23 nn: Minute, nn = 00 to 59 ss: Second, ss = 00 to 59	Sets the current value of calender/clock.  Day, hour, minute and second

D3186  
PULSE PATTERN GENERATOR  
OPERATION MANUAL

5.7 Query Program Message and Response Message

(16 of 17)

Function name	Query program message, OP command	Response message format	Description
(5) GPIB and system setting			
PANEL LOCK ON OFF	“PLK?” or “OPPLK”	“PLKON”  “PLKOF”	Panel lock  ON  OFF
SRQ ON OFF	“S?” or “OPS”	“S0”  “S1”	Service request  Sent  Not sent
RESPONCE MESSAGE TERMINATOR  CR, LF^END LF ^END	“DL?” or “OPDL”	“DL0”  “DL1”  “DL2”	Sets response message terminator to:  CR, LF^END  Only LF  Only ^END
IDENTIFY	“IDN?”	“ADVANTEST,D3186,REV addad”  add: Revision code add = A00 to Z99 ad: Special specification code ad = A0 to Z9 (None for standard specification)	Device identification code

\* ^END:            END message must be added with the immediately preceding byte.  
END message: Single-line signal EOI and ATN must be true and false, respectively.

D3186  
PULSE PATTERN GENERATOR  
OPERATION MANUAL

5.7 Query Program Message and Response Message

(17 of 17)

Function name	Query program message, OP command	Response message format	Description
(6) External SG control code setting			
FREQUENCY SETTING CODE TRANSFORMATION	"XFFRQ?"	<p style="text-align: center;">"XFFRQ xxxx;yyyy"</p> <p>xxxx: Header after transformation should be 1 to 16 characters starting with an alphabet of A to Z. The second and after characters should be alphanumerics of A to Z and 0 to 9.</p> <p>yyyy: Trailer after transformation should be 0 to 64 characters. Use alphanumerics of A to Z and 0 to 9, marks of ASCII code 32 to 47 (decimal), or space.</p>	<p>Transformation of frequency setting code</p> <p>Transforms the original code "CW dddd.dddMZ", which sets frequency of dddd.ddd MHz, to "xxxx dddd.dddyyy".</p>
INITIALIZATION CODE TRANSFORMATION	"XFINI?"	<p style="text-align: center;">"XFINI zzzz"</p> <p>zzzz: Code after transformation should be 1 to 16 characters starting with an alphabet of A to Z. The second and after characters should be alphanumerics of A to Z and 0 to 9.</p>	<p>Transformation of initialization code</p> <p>Transforms the original initialization-code "IP" to "zzzz".</p>



## 5.8 Status Byte

The following shows the structure of the status byte that D3186 sends when receiving SPE command result from serial polling execution from controller.

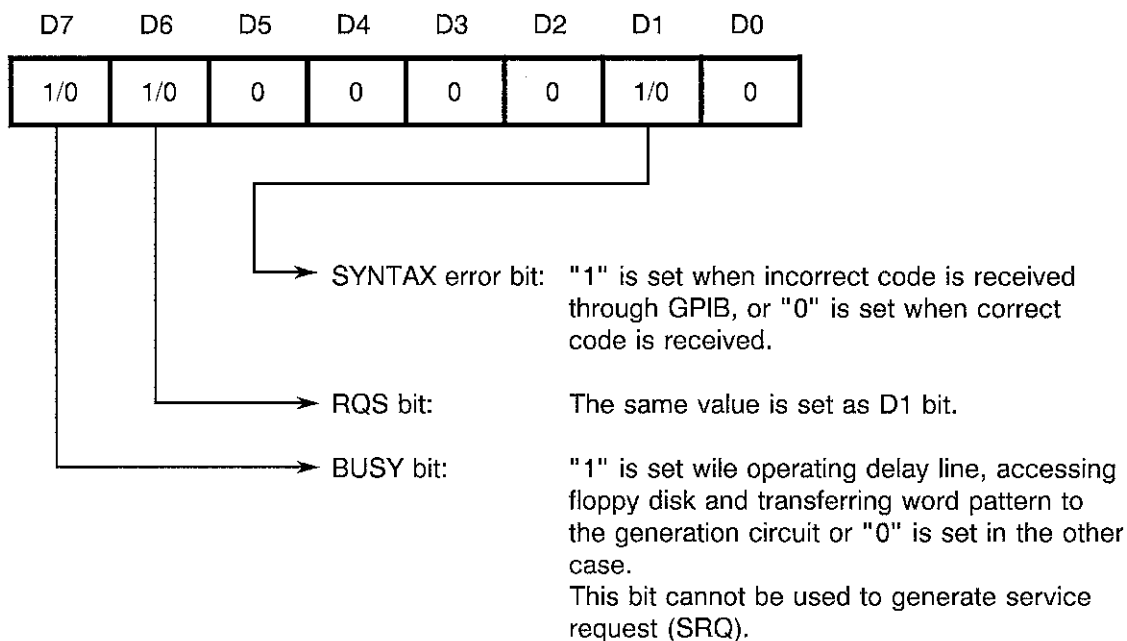

D3186  
PULSE PATTERN GENERATOR  
OPERATION MANUAL

---

*5.9 Device Clear (SDC and DCL Commands)*

## 5.9 Device Clear (SDC and DCL Commands)

D3186 initializes operation when it receives SDC (SELECTED DEVICE CLEAR) or DCL (DEVICE CLEAR) command. SDC and DCL command functions are equivalent to program message "C". For state after initialization, see Section 5.10 Initial State.

## 5.10 Initial State

### 5.10.1 Initial State of Operation

D3186 is initialized as follows when it receives SDC, DCL command, program code "C", or it's power is turned on:

(1) Status byte

All bits are cleared to "0".

(2) Service request

Enters "S1" (not sending SRQ) mode.

(3) Query program message, OP command

Canceled.

(4) Word and frame patterns setting mode

Binary mode is canceled. Not canceled by program code "C".

### 5.10.2 Setup Parameter Initialization

Each setup parameter is initialized by program code "Z" as follows:

(1) Clock frequency setting section

Clock rate: 1000.000 MHz (CR 1000.000E + 6)

Memory number: 0 (RM0)

Edit: OFF

D3186  
PULSE PATTERN GENERATOR  
OPERATION MANUAL

5.10 Initial State

---

(2) Output section

DATA/ $\overline{\text{DATA}}$  tracking: ON (DTRKON)

DATA output

Output mode: TO 0V (DGND)  
Offset mode: HIGH (DOFH)  
Amplitude: 1.00 V (DAMP 1.00)  
Offset: 0.00 V (DOFF 0.00)  
Cross point adjustment: OFF (DCPOF)

$\overline{\text{DATA}}$  output

Output mode: TO 0V (DBGND)  
Offset mode: HIGH (DBOFH)  
Amplitude: 1.00 V (DBAMP 1.00)  
Offset: 0.00 V (DBOFF 0.00)  
Cross point adjustment: OFF (DBCPOF)

DATA/ $\overline{\text{DATA}}$  output: ON (OUTON)

CLOCK1/ $\overline{\text{CLOCK1}}$  tracking: ON (CTRKON)

CLOCK1 output

Output mode: TO 0V (CGND)  
Offset mode: HIGH (COFH)  
Amplitude: 1.00 V (CAMP 1.00)  
Offset: 0.00 V (COFF 0.00)  
Duty rate adjustment: OFF (CDTYOF)

$\overline{\text{CLOCK1}}$  output

Output mode: TO 0V (CBGND)  
Offset mode: HIGH (CBOFH)  
Amplitude: 1.00 V (CBAMP 1.00)  
Offset: 0.00 V (CBOFF 0.00)  
Duty rate adjustment: OFF (CBDTYOF)

CLOCK1/ $\overline{\text{CLOCK1}}$  delay: Not initialized

D3186  
PULSE PATTERN GENERATOR  
OPERATION MANUAL

5.10 Initial State

---

(3) Pattern section

Pattern mode: WORD (WORD)  
Alternate mode: OFF (ALTOF)  
Alternate pattern: A (ALTA)

PRBS

PRBS  $2^N-1$ : N = 15 (PB 15)  
Mark ratio: 1/2 (MR 1/2)  
Trigger address: 0 (PBTAD 0)

WORD

Polarity: NORMAL (WPN)  
Edit: OFF  
Bit length: 16 (BL 16)  
Trigger address: 0 WDTAD 0)  
Pattern contents: 0101 0101 0101 0101 (Binary) (WP 0,4,AAAA)

FRAME

Polarity: NORMAL (FPN)  
Edit: OFF  
Payload type: WORD (PLW)  
Pattern length: 1 (FN 1)  
Frame length: 9 (FL 16)  
Row length: 1080 (RL 1080)  
Overhead length: 36 (OL 36)  
Length of 0/1 continuous pattern: 2000 (CL 2000)  
Trigger frame number: 1 (FMTFN 1)  
Trigger row number: 1 (FMTRN 1)  
Trigger byte number: 1 (FMTBN 1)





D3186  
PULSE PATTERN GENERATOR  
OPERATION MANUAL

5.10 Initial State

---

(4) Control section

Panel lock: OFF (PLKOF)

(5) GPIB section

Response message terminator: CR, LF^END (DL0)

Service request: Not sent (S1)

(6) External SG control code setting

Transformation of  
frequency setting code: CW ddddd.dddMZ (XFFRQ CW;MZ;)

Transformation of  
initializing code: IP (XFINI IP)



## 5.11 Program Example

This section describes a program example as a reference for GPIB program creation. HP9000 Series 300 controller and BASIC are used.

### 5.11.1 Operation Condition Setup

In this program, output mode, amplitude, offset mode and offset of the data (DATA) output which is entered from the keyboard of the GPIB controller.

(1) Program list

(1 of 2)

```
100 DIM OutMode$(2,1),AmpMin(2),AmpMax(2),OffMin(2),OffMax(2),OffMode$(2,1),AmpCoef(2)
110 DATA AC ,DAC ,0.50,2.00, 0 , 0 ,HIGH ,DOFH,0.0
120 DATA TO -2V,DM2V,0.60,1.00,-1.00,-0.60,MIDDLE,DOFM,0.5
130 DATA TO 0V ,DGND,0.50,2.00,-2.00, 2.00,LOW ,DOFL,1.0
140 FOR I=0 TO 2
150 READ OutMode$(I,0),OutMode$(I,1),AmpMin(I),AmpMax(I),OffMin(I),OffMax(I),OffMode$(I,0),OffMode$(I,1),AmpCoef(I)
160 NEXT I
170 Ppg=701
180 PRINT "***** DATA Output Condition Setting *****"
190 INPUT "Output Mode : AC(0), TO -2V(1), TO 0V(2) ?",OutputMode
200 PRINT "Output Mode : ";OutMode$(OutputMode,0)
210 OUTPUT Ppg;OutMode$(OutputMode,1)
220 LOOP
230 INPUT "Amplitude (Vp-p) ?",Amplitude
240 EXIT IF Amplitude>=AmpMin(OutputMode) AND Amplitude<=AmpMax(OutputMode)
250 BEEP
260 DISP USING "K,XZ.DDX";"Enter the Amplitude",AmpMin(OutputMode),"to",AmpMax(OutputMode),"(Vp-p)"
270 PAUSE
280 END LOOP
290 PRINT USING "K,XZ.DD","Amplitude :",Amplitude,"(Vp-p)"
300 OUTPUT Ppg USING "KX,Z.DD";"DAMP",Amplitude"
310 SELECT OutputMode
320 CASE 1,2
330 INPUT "Offset Mode : HIGH(0), MIDDLE(1), LOW(2) ?",OffsetMode
340 PRINT "Offset Mode : ";OffMode$(OffsetMode,0)
350 OUTPUT Ppg;OffMode$(OffsetMode,1)
360 OffsetMin=OffMin(OutputMode)-Amplitude*AmpCoef(OffsetMode)
370 OffsetMax=OffMax(OutputMode)-Amplitude*AmpCoef(OffsetMode)
380 LOOP
390 INPUT "Offset (V) ?",Offset
400 EXIT IF Offset>=OffsetMin AND Offset<=OffsetMax
```

D3186  
PULSE PATTERN GENERATOR  
OPERATION MANUAL

5.11 Program Example

(2 of 2)

```

410      BEEP
420      DISP USING "K,XSZ.DDX";"Enter the Offset",OffsetMin,"to",
         OffsetMax,"(V)"
430      PAUSE
440      END LOOP
450      PRINT USING "K,XSZ.DD","Offset :",Offset,"(V)"
460      OUTPUT Ppg USING "KX,SZ.DD";"DOFF",Offset
470      END SELECT
480      END

```

(2) Example of execution results

```

***** DATA Output Condition Setting *****
Output Mode : TO 0V
Amplitude : 0.86(Vp-p)
Offset Mode : HIGH
Offset : +1.12(V)

```

(3) Program explanation

(1 of 2)

Line Number	Description
100 to 160	Declares character strings of OutMode\$, AmpMin, AmpMax, OffMin, OffMax, OffMode\$ and AmpCoef as the array and reads values. OutMode\$, AmpMin and AmpMax, OffMin and OffMax, and OffMode\$ show output mode, upper and lower limits of the amplitude, upper and lower limits of the offset in the offset mode of HIGH, and offset mode, respectively. AmpCoef is the coefficient of amplitude in an expression to calculate upper and lower limits of offset according to the offset mode.
170	Sets GPIB select code and D3186 address to 7 and 1, respectively.
180	Prints the title.
190	Input an output mode with the keyboard.
200 to 210	Prints the output mode and sets the output mode to D3186.
220 to 280	Input loop of the amplitude
220	Head of the iterative loop
230	Input an amplitude with the keyboard.

**D3186**  
**PULSE PATTERN GENERATOR**  
**OPERATION MANUAL**

**5.11 Program Example**

(2 of 2)

Line Number	Description
240	Exits from the loop if the input amplitude is within tolerance.
250 to 270	Outputs a beeping sound because the input amplitude is out of tolerance. Displays upper and lower limits and stops program execution until the CONTINUE key is pressed.
280	End of the iterative loop (Returns to the head of the loop.)
290 to 300	Prints an amplitude and sets the amplitude to D3186.
310 to 470	Input and set offset mode and offset with the keyboard if the output mode is TO -2V and TO 0V.
330	Input the offset mode with the keyboard.
340 to 350	Prints the offset mode and sets the offset mode to D3186.
360 to 370	Calculates lower and upper limits of offset according to output mode and offset mode.
380 to 440	Input loop of offset
380	Head of the iterative loop
390	Input offset with the keyboard.
400	Exits from the loop if the input offset is within tolerance.
410 to 430	Outputs a beeping sound because the input offset is out of tolerance. Displays upper and lower limits and stops program execution until the CONTINUE key is pressed.
440	End of the iterative loop (Returns to the head of the loop.)
450 to 460	Prints the offset and sets the offset to D3186.
480	End of the program

D3186  
PULSE PATTERN GENERATOR  
OPERATION MANUAL

5.11 Program Example

### 5.11.2 Operation Condition Read

This program reads set value of the operation condition currently set by Query (? code).

(1) Program list

```
100 DATA CR,CAMP
110 DATA COFF,DLY
120 DATA PM,BL
130 DATA "WPO,4"
140 DATA ""
150 Ppg=701
160 LOOP
170 READ A$
180 EXIT IF A$=""
190 OUTPUT Ppg;A$;"?"
200 ENTER Ppg;B$
210 PRINT B$
220 END LOOP
230 END
```

(2) Example of execution results

```
CR 01000.000E+6
CAMP 1.00
COFF +0.50
DLY 000
WORD
BL 0000016
WP 000000,004,AAAA
```

**D3186  
PULSE PATTERN GENERATOR  
OPERATION MANUAL**

**5.11 Program Example**

(3) Program explanation

Line Number	Description
100 to 140	Uses DATA statement to prepare code corresponding to parameter to read. Null character string " " is set for final parameter.
150	Sets GPIB select code and D3186 address to 7 and 1, respectively.
160	Declares start of iterative loop.
170	Reads code corresponding to parameter to read one by one from DATA statement.
180	Exits loop when " " is read.
190	Adds ? to end of code read and sends to D3186.
200	Reads parameter from D3186.
210	Prints parameter read.
220	End of the iterative loop (Returns to the head of the loop.)
230	End of the program

D3186  
PULSE PATTERN GENERATOR  
OPERATION MANUAL

5.11 Program Example

### 5.11.3 Word Pattern Setup (Hex mode)

This program sets a word pattern by converting binary (0 and 1 character string) input from GPIB controller keyboard to hex character string.

(1) Program list

(1 of 2)

```
100 DIM P$[600],Q$[512],H$[128]
110 Ppg=701
120 OUTPUT Ppg;"WORD ALTOF"
130 LOOP
140 INPUT "PATTERN LENGTH = ?",B1
150 EXIT IF B1>0 AND B1<=32768 AND (B1 MOD 1)=0
160 EXIT IF B1>32768 AND B1<=65536 AND (B1 MOD 2)=0
170 EXIT IF B1>65536 AND B1<=131072 AND (B1 MOD 4)=0
180 EXIT IF B1>131072 AND B1<=262144 AND (B1 MOD 8)=0
190 EXIT IF B1>262144 AND B1<=524288 AND (B1 MOD 16)=0
200 EXIT IF B1>524288 AND B1<=1048576 AND (B1 MOD 32)=0
210 EXIT IF B1>1048576 AND B1<=2097152 AND (B1 MOD 64)=0
220 EXIT IF B1>2097152 AND B1<=4194560 AND (B1 MOD 128)=0
230 EXIT IF B1>4194560 AND B1<=8388608 AND (B1 MOD 256)=0
240 BEEP
250 END LOOP
260 PRINT "PATTERN LENGTH ;";B1
270 OUTPUT Ppg;"BL";B1
280 LOOP
290 LOOP
300 INPUT "TOP ADDRESS = ?",Adrs
310 EXIT IF Adrs>=0 AND Adrs<=-INT(-B1/16)-1
320 BEEP
330 END LOOP
340 PRINT "TOP ADDRESS ;";Adrs
350 INPUT "PATTERN = ?",P$
360 L=LEN(P$)
370 EXIT IF L=0
380 !
390 Q$=""
400 FOR I=1 TO L
410 IF P$[I,I]="0" OR P$[I,I]="1" THEN
420 IF LEN(Q$)<128 THEN Q$=Q$&P$[I,I]
430 END IF
440 NEXT I
450 L=LEN(Q$)
460 EXIT IF L=0
470 !
480 IF (L MOD 4)>0 THEN
```

D3186  
PULSE PATTERN GENERATOR  
OPERATION MANUAL

5.11 Program Example

(2 of 2)

```
490     FOR I=1 TO 4-(L MOD 4)
500         Q$=Q$&"0"
510     NEXT
520     L=LEN(Q$)
530     END IF
540     !
550     PRINT "BINARY PATTERN ;"
560     FOR I=1 TO L STEP 4
570         PRINT Q$ I,I+3 ;" ";
580     NEXT I
590     PRINT
600     !
610     H$=""
620     FOR I=1 TO L STEP 4
630         H=0
640         FOR J=0 TO 3
650             H=H+VAL(Q$[I+J,I+J]*2^J)
660         NEXT J
670         IF H<10 THEN
680             H$=H$VAL$(H)
690         ELSE
700             H$=H$&CHR$(NUM("A")-10+H)
710         END IF
720     NEXT I
730     Lh=LEN(H$)
740     !
750     PRINT "HEXADECIMAL PATTERN ;"
760     FOR I=0 TO INT(Lh/4)*4+1 STEP 4
770         PRINT H$[I,I+3];" ";
780     NEXT I
790     PRINT
800     OUTPUT Ppg;"WP";Adrs;" ";LEN(H$);" ";H$
810     END LOOP
820     END
```

(2) Example of execution results

```
PATTERN LENGTH : 15
TOP ADDRESS : 0
BINARY PATTERN :
1001 1011 0111 1110
HEXADECIMAL PATTERN :
9DE7
TOP ADDRESS : 0
```

**D3186  
PULSE PATTERN GENERATOR  
OPERATION MANUAL**

**5.11 Program Example**

(3) Program explanation

(1 of 2)

Line Number	Description
100	Declares character strings P\$ (max. 600 characters), Q\$ (max. 512 characters), and H\$ (max. 128 characters) as array.
110	Sets GPIB select code and D3186 address to 7 and 1, respectively.
120	Sets D3186 pattern mode to WORD and ALTERNATE to OFF, respectively.
130 to 250	Pattern length is input from the keyboard.
260 to 270	Prints pattern length and sets pattern length for D3186.
280 to 810	Pattern setting start address and pattern are input. Converts and sets them in D3186. This loop is repeated until " " (Null character string) is input as a pattern.
290 to 330	Start address to set pattern is input from the keyboard.
340	Prints start address.
350	Pattern is input in binary format (0 and 1 character string) from the keyboard. Character other than 0 or 1 can be inserted in string as delimiter.
360	Sets L for length of character string input.
370	Exits loop if character string length is 0.
390 to 450	Gets 0's and 1's from character string input, creates new character string Q\$, and sets L for Q\$ length. Ignores excess characters if Q\$ length exceeds 128 characters.
460	Exits loop if character string Q\$ length is 0.
480 to 530	Adds 0's to end of Q\$ so that character string Q\$ length will be integer multiple of 4, and sets L for new character string.
550 to 590	Prints character string Q\$. Prints space every 4 characters for clarity.
610 to 730	Groups every 4 characters sequentially from start of character string Q\$ and converts to decimal value. Converts to hex character to create hex character string, and sets Lh for length of hex character string.



**D3186**  
**PULSE PATTERN GENERATOR**  
**OPERATION MANUAL**

**5.11 Program Example**

---

(2 of 2)

Line Number	Description
750 to 790	Prints hex character string. Prints space every 4 characters for clarity.
800	Sets start address and pattern in D3186.
810	End of the loop (Returns to the start of the loop)
820	End of the program

D3186  
PULSE PATTERN GENERATOR  
OPERATION MANUAL

5.11 Program Example

### 5.11.4 Word Pattern Setup (Binary mode)

This program sets word pattern by converting binary (0 and 1 character string) input from GPIB controller keyboard to byte-unit value.

(1) Program list

(1 of 2)

```
100 DIM P$[600],Q$[512],B(64)
110 Ppg=701
120 OUTPUT Ppg;"WORD ALTOF"
130 LOOP
140 INPUT "BIT LENGTH = ?",B1
150 EXIT IF B1>0 AND B1<=32768 AND (B1 MOD 1)=0
160 EXIT IF B1>32768 AND B1<=65536 AND (B1 MOD 2)=0
170 EXIT IF B1>65536 AND B1<=131072 AND (B1 MOD 4)=0
180 EXIT IF B1>131072 AND B1<=262144 AND (B1 MOD 8)=0
190 EXIT IF B1>262144 AND B1<=524288 AND (B1 MOD 16)=0
200 EXIT IF B1>524288 AND B1<=1048576 AND (B1 MOD 32)=0
210 EXIT IF B1>1048576 AND B1<=2097152 AND (B1 MOD 64)=0
220 EXIT IF B1>2097152 AND B1<=4194560 AND (B1 MOD 128)=0
230 EXIT IF B1>4194560 AND B1<=8388608 AND (B1 MOD 256)=0
240 BEEP
250 END LOOP
260 PRINT "PATTERN LENGTH ;";B1
270 OUTPUT Ppg;"BL";B1
280 LOOP
290 LOOP
300 INPUT "TOP ADDRESS = ?",Adrs
310 EXIT IF Adrs>=0 AND Adrs<=-INT(-B1/16)-1
320 BEEP
330 END LOOP
340 PRINT "TOP ADDRESS ;";Adrs
350 INPUT "PATTERN = ?",P$
360 L=LEN(P$)
370 EXIT IF L=0
380 !
390 Q$=""
400 FOR I=1 TO L
410 IF P$[I,I]="0" OR P$[I,I]="1" THEN
420 IF LEN(Q$)<128 THEN Q$=Q$&P$[I,I]
430 END IF
440 NEXT I
450 L=LEN(Q$)
460 EXIT IF L=0
470 !
480 IF (L MOD 8)>0 THEN
```

D3186  
PULSE PATTERN GENERATOR  
OPERATION MANUAL

5.11 Program Example

(2 fo 2)

```
490     FOR I=1 TO 8-(L MOD 8)
500         Q$=Q$&"0"
510     NEXT I
520     L=LEN(Q$)
530     END IF
540     !
550     PRINT "BINARY PATTERN ;"
560     FOR I=1 TO L STEP 4
570         PRINT Q$[I,I+3];" ";
580     NEXT I
590     PRINT
600     !
610     N=0
620     FOR I=1 TO L STEP 8
630         B(N)=0
640         FOR J=0 TO 7
650             B(N)=B(N)+VAL(Q$[I+J,I+J])*2^J
660         NEXT J
670         N=N+1
680     NEXT I
690     !
700     PRINT "BYTE PATTERN ;"
710     FOR I=0 TO N-1
720         PRINT USING "#,4D;B(I)"
730     NEXT I
740     PRINT
750     !
760     OUTPUT Ppg;"BIN";Adrs;",";N
770     FOR I=0 TO N
780         IF I<N THEN
790             OUTPUT Ppg;CHR$(B(I));
800         ELES
810             SEND 7;DATA B(N) END
820         END IF
830     NEXT I
840     END LOOP
850     END
```

(2) Example of execution results

```
PATTERN LENGTH : 15
TOP ADDRESS : 0
BINARY PATTERN :
1001 1011 0111 1110
BYTE PATTERN :
217 126
TOP ADDRESS : 0
```

**D3186  
PULSE PATTERN GENERATOR  
OPERATION MANUAL**

**5.11 Program Example**

(3) Program explanation

(1 of 2)

Line Number	Description
100	Declares character strings P\$ (max. 600 characters), Q\$ (max. 512 characters), and H\$ (max. 128 characters) as array.
110	Sets GPIB select code and D3186 address to 7 and 1, respectively.
120	Sets D3186 pattern mode to WORD and ALTERNATE to OFF, respectively.
130 to 250	Pattern length is input from keyboard.
260 to 270	Prints pattern length and sets pattern length for D3186.
280 to 840	Pattern setting start address and pattern are input. Converts and sets them in D3186. Repeats until null character string " " is input as pattern.
290 to 330	Start address to set pattern is input from keyboard.
340	Prints start address.
350	Pattern is input in binary format (0 and 1 character string) from keyboard. Character other than 0 or 1 can be inserted in string as delimiter.
360	Sets L for length of character string input.
370	Exits loop if character string length is 0.
390 to 450	Gets 0's and 1's from character string input, creates new character string Q\$, and sets L for Q\$ length. Ignores excess characters if Q\$ length exceeds 128 characters.
460	Exits loop if character string Q\$ length is 0.
480 to 530	Adds 0's to end of Q\$ so that character string Q\$ length will be integer multiple of 8, and sets L for new character string.
550 to 590	Prints character string Q\$. Prints space every 4 characters for clarity.
610 to 680	Groups every 8 characters sequentially from start of character string Q\$ and converts to decimal values (0 to 255). Specifies N for the number of these values.
700 to 740	Prints decimal values sequentially.

**D3186  
PULSE PATTERN GENERATOR  
OPERATION MANUAL**

**5.11 Program Example**

---

(2 of 2)

Line Number	Description
760	Sets binary mode, start address and byte count N in D3186.
770 to 830	Sets pattern in D3186 for each byte. Sends EOI with end byte.
840	End of the loop (Returns to start of loop.)
850	End of the program



## 6. FILE FUNCTION

This chapter describes file functions available for built-in floppy disk drive. File function operation method and file operation error messages are explained in Sections 3.2 (4-1) and 7.3, respectively.

### 6.1 Outline

D3186 has a built-in 3.5-inch floppy disk drive which can save/load set operation conditions and pattern setup contents to/from floppy disk.

Disk is formatted with MS-DOS Rev. 4.0; 720 KB (2DD), 1.2 MB (2HD), or 1.4 MB (2HD). Disk type is automatically identified, except for disk initialization (FORMAT).

Six types of file functions can be executed on D3186:

- (1) DIR ..... Directory display
- (2) LOAD ..... File read
- (3) SAVE ..... File save (new file create)
- (4) RESAVE ..... File resave (overwrite)
- (5) DELETE ..... File deletion
- (6) FORMAT ..... Disk initialization

Three file types can be handled on D3186:

- (1) SETUP ..... General operation settings other than pattern contents
- (2) WORD ..... Pattern contents with pattern mode WORD
- (3) FRAME ..... Pattern contents with pattern mode FRAME.

Max. 100 files can be created for each file type; assigned file Nos. 0 to 99. File type, file number and actual MS-DOS® file name are related as follows:

xxxxx-yy. zzz  
①      ②

① File name

xxxxx = D3286: File type SETUP  
xxxxx = BERTS: File type WORD or FRAME  
yy = 00 to 99: File number

② Extension

zzz = SET: File type SETUP  
zzz = WRD: File type WORD  
zzz = MES: File type FRAME

Note : Error occurs if extension does not match file contents.

◆ MS-DOS is a registered trademark of Microsoft Corporation, U.S.A.

## 6.2 File Format

Files of every file type use original binary format, which cannot be handled with other general-purpose application software.

ADVANTEST provides dedicated software which can set D3186 and D3286 operation conditions and pattern contents, and display measurement results.

## 6.3 File Size

Each file type has the following size:

- (1) SETUP: 744 bytes
- (2) WORD: PL + 92 bytes  
    PL = pattern length (bits)/8 (round up)
- (3) FRAME: PL + 92 bytes  
    If payload type is WORD or PRBS;  
    PL = (frame count of entire pattern) x (row count of single frame) x (single row length (bytes)).  
    If payload type is CID;  
    PL = single row length (bytes).



## 7. MESSAGE DISPLAY

This chapter describes the meaning of and operator response to messages displayed on the front panel.

### 7.1 MPU Error Display

This section describes error display when MPU (microprocessor unit) for D3186 internal control operates abnormally. This error is displayed on pattern length/address indicator (Ⓜ in Figure 2-3) of pattern setting section on front panel. If this error is displayed, turn off the D3186 power, wait 5 seconds or more, then turn on the power while pressing PATTERN DATA - 2nd key of pattern setting section (Ⓢ in Figure 2-3).

Keep pressing PATTERN DATA - 2nd key until Initial is displayed on the file number indicator of file operation section on the front panel (Ⓣ in Figure 2-5). This operation sets D3186 to initial state. Initial parameter values are same as those set by GPIB program code "Z" (see Subsection 5.12.1). GPIB device address is initialized to 1.

Error code 0005 indicates that contents of memory storing set parameters are lost. If it is displayed, D3186 is initialized in same way as D3186 power is turned on with PATTERN DATA - 2nd key depressed on pattern setting section.

If an MPU error is frequently displayed, that indicates the MPU has failed. Contact nearest ADVANTEST sales office, or agency. Also inform them of displayed error code (4-digit numeric). See the back of this document for location and telephone No. of ADVANTEST offices and agencies.

Display format: E Γ Γ XXXX  
└── Error code (4-digit numeric)

Error code	Contents
0001 to 1717	Abnormal memory
8000 or more	Abnormal MPU peripheral circuit

## 7.2 Low Battery Display

When D3186 power is turned on if the following is displayed on pattern length/address indicator of front panel pattern setting section (Ⓜ in Figure 2-3), the voltage of memory backup NiCd battery is low and previous set parameters have been lost. This low battery indication is displayed for several seconds, and then normal operation subsequently resumes.

In this case, Initial is displayed on file number indicator of the front panel file operation section (Ⓛ in Figure 2-5) and D3186 is set to initial state. Parameter initial values are same as those set by program code "Z" (see Subsection 5.12.2). GPIB device address is initialized to 1. To charge to full charge condition from low battery state, turn on D3186 power continuously for 12 hours or more.

If low battery indication is still displayed after sufficient charging, the battery has failed and requires replacement. Contact nearest ADVANTEST sales office, or agency. See the back of this document for location and telephone number.

### 7.3 File Error Display

This section describes floppy disk error messages displayed on file number/date and time indicator of file operation section (① in Fig. 2-5).

Table 7-1 Floppy Disk Related Error Message



(1 of 2)

Error message	Meaning	Operator response
Disk Error ----- d i s c E r r	<ul style="list-style-type: none"> <li>• Disk is not loaded.</li> <li>• Disk is not correctly formatted.</li> <li>• Disk cannot be formatted.</li> </ul>	<ul style="list-style-type: none"> <li>• Check that disk is fully inserted.</li> <li>• Check that disk is either 720 KB, 1.2 MB, or 1.4 MB and MS-DOS formatted.</li> <li>• Reformat or replace disk according to situation.</li> </ul>
Protected ----- P r o t e c t	<ul style="list-style-type: none"> <li>• Disk is write-protected.</li> </ul>	<ul style="list-style-type: none"> <li>• Cancel disk write protect (slide notch to close hole).</li> </ul>
File Full ----- F I L E F U L L	<ul style="list-style-type: none"> <li>• Disk is full, no space to write file.</li> </ul>	<ul style="list-style-type: none"> <li>• Delete unnecessary files.</li> <li>• Replace disk.</li> </ul>
File Error ----- F I L E E r r	<ul style="list-style-type: none"> <li>• File is specified as write protect, cannot be resaved or deleted.</li> </ul>	<ul style="list-style-type: none"> <li>• Check file attribute using a PC.</li> <li>• Cancel write protect attribute.</li> </ul>
Type Error ----- t y p e E r r	<ul style="list-style-type: none"> <li>• File type name and contents do not match each other.</li> </ul>	<ul style="list-style-type: none"> <li>• Check whether file extension has been changed. If changed, correct it.</li> </ul>
Data Error ----- d a t a E r r	<ul style="list-style-type: none"> <li>• Data read from file has error.</li> </ul>	<ul style="list-style-type: none"> <li>• Retry data read.</li> <li>• If error still occurs after retry, delete that file which cannot be used.</li> </ul>

D3186  
PULSE PATTERN GENERATOR  
OPERATION MANUAL

7.3 File Error Display

(1 of 2)

Error message	Meaning	Operator response
Not Found ..... n o t F o u n d	<ul style="list-style-type: none"> <li>File with specified file type and No. cannot be found.</li> </ul>	<ul style="list-style-type: none"> <li>Check whether file type and number are correct. If incorrect, specify file type and/or number again.</li> </ul>
Already ..... A l r e A d y	<ul style="list-style-type: none"> <li>Specified file already exists and cannot be saved.</li> </ul>	<ul style="list-style-type: none"> <li>Execute RESAVE if it may be overwritten.</li> <li>Specify other file No. if not overwritten.</li> </ul>
Length Error ..... L E n E r r	<ul style="list-style-type: none"> <li>The pattern length is more than 4 Mbits during ALTERNATE pattern read.</li> </ul>	<ul style="list-style-type: none"> <li>Specify other file with pattern length of 4 Mbits (4104304 bits) or less.</li> <li>Read the file after setting ALTERNATE to OFF.</li> </ul>
Diff. Length ..... d i f f L E n	<ul style="list-style-type: none"> <li>Set pattern length and file pattern length different from each other during ALTERNATE pattern read.</li> <li>Different length message on upper stage is displayed for approx. 1 second and it is subsequently changed to lower stage display Load n y on left side.</li> </ul>	<ul style="list-style-type: none"> <li>To execute pattern read, light pointer in upper left portion of y using DIGIT key (  ,  ) and depress EXE key.</li> <li>To stop pattern read, light pointer in upper left portion of n and depress EXE key.</li> </ul>
Load y n ..... L o A d y n		
Initial ..... I n I T I A L	<ul style="list-style-type: none"> <li>D3186 has been set to initial state (not file error).</li> </ul>	<ul style="list-style-type: none"> <li>See Sections 3.2.1 (5) Initial State Setting, 5.9.2 Set Parameter Initialization, 6.1 MPU Error Display, and 6.2 Low Battery Display.</li> </ul>

## 7.4 Displays Relating to Delay Lines

If variation in the absolute value of the value displayed in the delay setting section (Ⓣ in Figure 2-4) exceeds the tolerance, control is passed to the self-calibration routine automatically and **CAL** is displayed for up to 12 seconds.

At this time, the upper and lower limits are checked by the upper and lower limit detection function. If an error is detected, the following error message is displayed.

**E r r**

If this message is displayed, contact our sales office nearby, or your sales representative. Location and phone number of ATCE and sales offices are printed on the back cover of this manual.

While this message is displayed, the delay value setting knob does not operate. Turn off the power, wait for at least five seconds, and then turn the power back on. If the error is recovered, the above error message disappears and the knob becomes operative; otherwise, the two messages are displayed again.



## **8. HOW TO VERIFY THE PERFORMANCE AND FUNCTIONS**

This chapter describes how to easily verify the performance and functions of the D3186.

### **8.1 Performance Verification**

This section explains the procedure for verifying the D3186 performance by monitoring the D3186 output waveform with an oscilloscope.

Prepare an oscilloscope which has been calibrated to 50  $\Omega$  input impedance and a sufficient bandwidth. (For example, monitoring data output of 12 Gb/s requires a minimum of 20 GHz, and ideally 40 GHz or higher.) Use the attached coaxial cable to connect the D3186 to the oscilloscope and use a connector conversion adapter if necessary.

**NOTE**

The CLOCK OUTPUT and 10M REF OUTPUT connectors described in Section 8.1.1 and later indicate the internal clock output connectors on the D3186 (option 10 or option 11). When using an external clock signal generator, the CLOCK OUTPUT and 10M REF OUTPUT connectors described in Section 8.1.1 and later indicate the connectors of the external clock signal generator.

#### **8.1.1 Confirming Clock Output**

This section explains how to verify the clock output from the output terminal on the front panel (from the internal clock generator). (Option 10 or option 11)

- (1) Set the oscilloscope as follows:
  - Input impedance: 50  $\Omega$
  - Input connection: DC
  - Vertical axis scale: 0.5 V/div
  - Vertical axis offset: 0 V (center voltage)
  - Horizontal axis scale: 5 ns/div
  - Trigger mode: AUTO
  - Trigger source: EXTERNAL
  - Trigger connection: DC
  - Trigger level: 0 V
- (2) Set the frequency to 200 MHz in the front panel frequency setting section (Figure 2-2).
- (3) Connect the CLOCK OUTPUT connector on the front panel (⑤ in Figure 2-4) to the oscilloscope Channel 1 input.
- (4) Connect the 10M REF OUTPUT connector on the rear panel (⑫ in Figure 2-6) to the oscilloscope trigger input.
- (5) If the waveform monitored on the oscilloscope screen is a sine wave as shown in Figure 8-1, the clock output is correct.

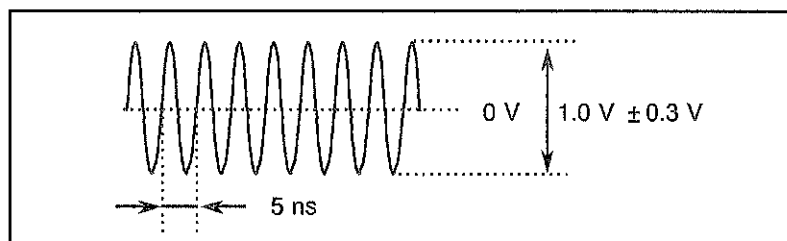

Figure 8-1 CLOCK Output Waveform (f = 200 MHz)

- (6) Confirm that changing the frequency also varies the cycle.

### 8.1.2 Confirming CLOCK2 output

Front panel CLOCK2 OUTPUT (fixed clock output) is confirmed.

- (1) Set the oscilloscope as follows:

Input impedance : 50  $\Omega$   
Input connection: DC  
Vertical axis scale: 0.5 V/div  
Vertical axis offset: 0 V (center voltage)  
Horizontal axis scale: 5 ns/div  
Trigger mode: AUTO  
Trigger source: EXTERNAL  
Trigger connection: DC  
Trigger level: 0 V

- (2) Set the frequency to 200 MHz in the front panel frequency setting section (Figure 2-2).
- (3) Connect the front panel CLOCK INPUT connector (④ in Figure 2-4) and CLOCK OUTPUT connector (⑤ in Figure 2-4).
- (4) Connect the front panel CLOCK2 OUTPUT connector (⑥ in Figure 2-4) to the oscilloscope CH1 input.
- (5) Connect the rear panel 10M REF OUTPUT connector (⑫ in Figure 2-6) to the oscilloscope trigger input.



- (6) Normal when the waveform is a rectangular wave as shown in Figure 8-2.

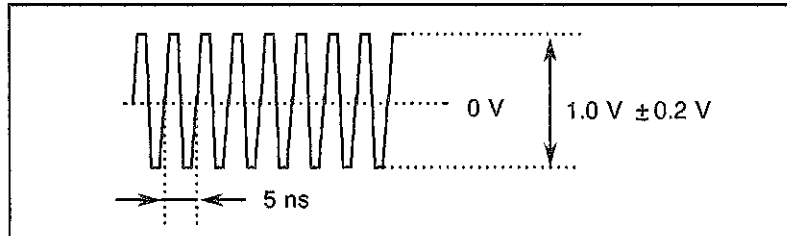

Figure 8-2 CLOCK2 Output Waveform (f = 200 MHz)

### 8.1.3 Confirming 1/2 CLOCK output

Rear panel 1/2 CLOCK (1/2 divided clock output ) is confirmed.

- (1) Set the oscilloscope as follows:

Input impedance :	50 $\Omega$
Input connection:	DC
Vertical axis scale:	0.5 V/div
Vertical axis offset:	-0.5 V (center voltage)
Horizontal axis scale:	5 ns/div
Trigger mode:	AUTO
Trigger source:	EXTERNAL
Trigger connection:	DC
Trigger level:	0V
  
- (2) Set the frequency to 200 MHz in the front panel frequency setting section (Figure 2-2).
  
- (3) Connect the front panel CLOCK INPUT connector (④ in Figure 2-4) and CLOCK OUTPUT connector (⑤ in Figure 2-4).
  
- (4) Connect the rear panel 1/2 CLOCK connector (⑩ in Figure 2-6) to the oscilloscope CH1 input.
  
- (5) Connect the rear panel 10M REF OUTPUT connector (⑫ in Figure 2-6) to the oscilloscope trigger input.

- (6) Normal when the waveform is a rectangular wave as shown in Figure 8-3.

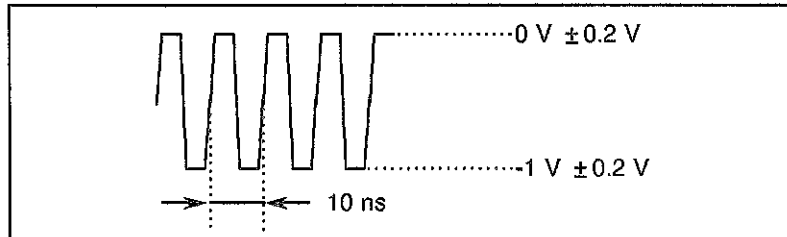

Figure 8-3 1/2 CLOCK Output Waveform (f = 200 MHz)

#### 8.1.4 Confirming 1/32 CLK TRIGGER signal

Front panel 1/32 CLK TRIGGER (1/32 dividing clock) signal is confirmed. 1/32 CLK TRIGGER signal is output to the front panel TRIGGER OUTPUT connector.

- (1) Set the oscilloscope as follows:

Input impedance : 50  $\Omega$   
Input connection: DC  
Vertical axis scale: 0.5 V/div  
Vertical axis offset: -0.5 V (center voltage)  
Horizontal axis scale: 5 ns/div  
Trigger mode: AUTO  
Trigger source: CH 1  
Trigger connection: DC  
Trigger level: -0.5 V

- (2) Set the frequency to 12000 MHz in the front panel frequency setting section (Figure 2-2).
- (3) Select 1/32 CLK using the front panel trigger output select key (② in Figure 2-4).
- (4) Connect the front panel CLOCK INPUT connector (④ in Figure 2-4) and CLOCK OUTPUT connector (⑤ in Figure 2-4).
- (5) Connect the front panel TRIGGER OUTPUT connector (③ in Figure 2-4) to the oscilloscope CH 1 input.

- (6) Normal when the waveform is a rectangular wave as shown in Figure 8-4.

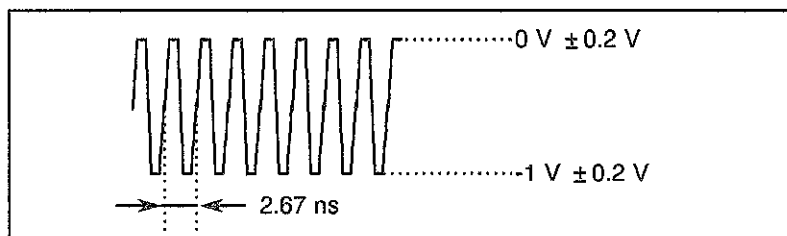

Figure 8-4 1/32 CLK TRIGGER Output Waveform (f = 12000 MHz)

### 8.1.5 Confirming PATTERN TRIGGER signal

PATTERN TRIGGER (pattern synchronization) signal is confirmed. The PATTERN TRIGGER signal is output to the front panel TRIGGER OUTPUT connector. This signal changes its cycle depending on the pattern mode.

- (a) Confirming PATTERN TRIGGER output in pseudo random (PRBS) mode

- (1) Set the oscilloscope as follows:

Input impedance :	50 $\Omega$
Input connection:	DC
Vertical axis scale:	0.5 V/div
Vertical axis offset:	-0.5 V (center voltage)
Horizontal axis scale:	5 ns/div
Trigger mode:	AUTO
Trigger source:	CH 1
Trigger connection:	DC
Trigger level:	-0.5 V
Trigger polarity:	Rise

- (2) Set the frequency to 12000 MHz in the front panel frequency setting section (Figure 2-2).
- (3) Set the front panel pattern setting section (Figure 2-3) as follows:
- |                           |    |
|---------------------------|----|
| PATTERN MODE PRBS (①):    | ON |
| Number of PRBS steps (②): | 23 |
- (4) Select PATTERN using the front panel trigger output select key (② in Figure 2-4).
- (5) Connect the front panel CLOCK INPUT connector (④ in Figure 2-4) and CLOCK OUTPUT connector (⑤ in Figure 2-4).

- (6) Connect the front panel TRIGGER OUTPUT connector (ⓐ in Figure 2-4) to the oscilloscope CH 1 input.
- (7) Confirm that the waveform is a rectangular wave as shown in Figure 8-5. The pulse width is expressed in the following equation:  
 PATTERN TRIGGER pulse width (PRBS) = 32/Clock frequency

If a small number of trigger count causes a dim waveform, set a longer oscilloscope display persistence time (DISPLAY TIME or PERSIST TIME).

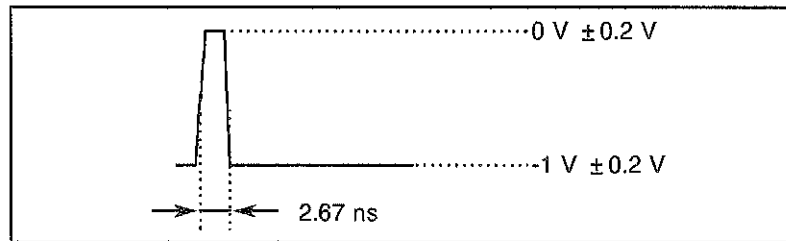

Figure 8-5 PATTERN TRIGGER Output Waveform (f = 12000 MHz, 5 ns/div)

- (8) Set the oscilloscope as follows:  
 Horizontal scale: 5ms/div  
 (no changes in other settings)
- (9) Normal when the waveform has the cycle as shown in Figure 8-6.  
 The cycle is expressed in the following equation:  
 PATTERN TRIGGER cycle (PRBS) =  $(2^N - 1) \times 32 / \text{clock frequency}$   
 (in which, N refers to the PRBS step count. In case of  $N < 15$ , the equation for WORD is used.)

If a small number of trigger count causes a dim waveform, set a longer oscilloscope display persistence time (DISPLAY TIME or PERSIST TIME).

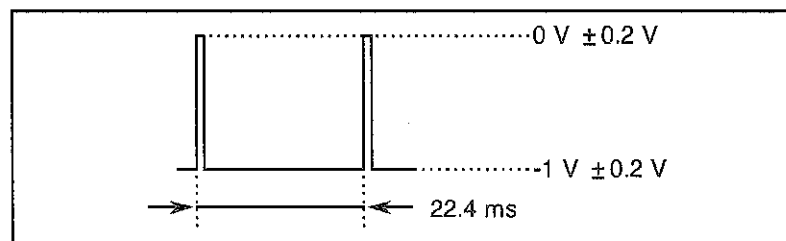

Figure 8-6 PATTERN TRIGGER Output Waveform  
 (PRBS, N = 23, f = 12000 MHz, 5 ms/div)

**D3186**  
**PULSE PATTERN GENERATOR**  
**OPERATION MANUAL**

**8.1 Performance Verification**

---

(b) Confirming PATTERN TRIGGER output in WORD mode.

(1) Set the oscilloscope as follows:

Input impedance :	50 $\Omega$
Input connection:	DC
Vertical axis scale:	0.5 V/div
Vertical axis offset:	-0.5 V (center voltage)
Horizontal axis scale:	5 ns/div
Trigger mode:	AUTO
Trigger source:	CH 1
Trigger connection:	DC
Trigger level:	-0.5 V
Trigger polarity:	Rise

(2) Set the frequency to 12000 MHz in the front panel frequency setting section (Figure 2-2).

(3) Set the front panel pattern setting section (Figure 2-3) as follows:

PATTERN MODE WORD (⑤):	ON
POLARITY (⑩):	NORMAL
ALTERNATE (⑦):	OFF
Group select (⑫):	PATT DATA
EDIT (⑬):	ON
ITEM (⑭):	PATTERN LENGTH
Pattern length (⑰, ⑱):	3
ITEM (⑭):	ADDRESS
Address (⑰, ⑱):	0
PATTERN DATA (⑲):	010

(4) Select PATTERN using the front panel trigger output select key (② in Figure 2-4).

(5) Connect the front panel CLOCK INPUT connector (④ in Figure 2-4) and CLOCK OUTPUT connector (⑤ in Figure 2-4).

(6) Connect the front panel TRIGGER OUTPUT connector (③ in Figure 2-4) to the oscilloscope CH 1 input.

(7) Confirm that the waveform is a rectangular wave as shown in Figure 8-5. The pulse width is expressed in the following equation:

$$\text{PATTERN TRIGGER pulse width (WORD)} = 32/\text{Clock frequency}$$

- (8) Set the oscilloscope as follows:  
Horizontal scale: 10 ns/div  
(no changes in other settings)

- (9) Normal when the waveform has the cycle as shown in Figure 8-7.  
The cycle is expressed in the following equation:  
PATTERN TRIGGER cycle (WORD) = (L.C.M. of pattern length (PL) and 256) × N/clock frequency

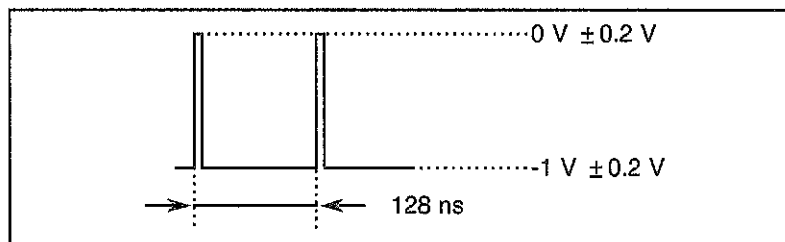

Figure 8-7 PATTERN TRIGGER Output Waveform  
(WORD, PL = 3, f = 12000 MHz, 20 ns/div)

### 8.1.6 Confirming 1/4 RATE output

Rear panel 1/4 RATE OUTPUT (1/4 rate output) is confirmed.

- (a) Confirming 1/4 RATE output in pseudo random mode (PRBS)

- (1) Set the oscilloscope as follows:
- |                          |            |   |                  |
|--------------------------|------------|---|------------------|
| Input impedance :        | 50 Ω       | } | Both CH1 and CH2 |
| Input connection:        | DC         |   |                  |
| Vertical axis scale:     | 0.5 V/div  |   |                  |
| Horizontal axis scale:   | 100 ps/div |   |                  |
| Trigger mode:            | AUTO       |   |                  |
| Trigger source:          | EXTERNAL   |   |                  |
| Trigger input impedance: | 50 Ω       |   |                  |
- (2) Set the frequency to 12000 MHz in the front panel frequency setting section (Figure 2-2).
- (3) Set the front panel pattern setting section (Figure 2-3) as follows:
- |                           |     |
|---------------------------|-----|
| PATTERN MODE WORD (①):    | ON  |
| Number of PRBS steps (②): | 23  |
| Mark ratio (③):           | 1/2 |

- (4) Select 1/32CLK using the front panel trigger output select key (② in Figure 2-4).
- (5) Connect the front panel CLOCK INPUT connector (④ in Figure 2-4) and CLOCK OUTPUT connector (⑤ in Figure 2-4).
- (6) Connect the rear panel 1/4 CLOCK connector (⑩ in Figure 2-6) and DATA 1 connector to the oscilloscope CH1 input and CH2 input, respectively.
- (7) Connect the front panel TRIGGER OUTPUT connector (③ in Figure 2-4) to the oscilloscope trigger input.
- (8) Confirm that the waveform is a rectangular wave as shown in Figure 8-8.

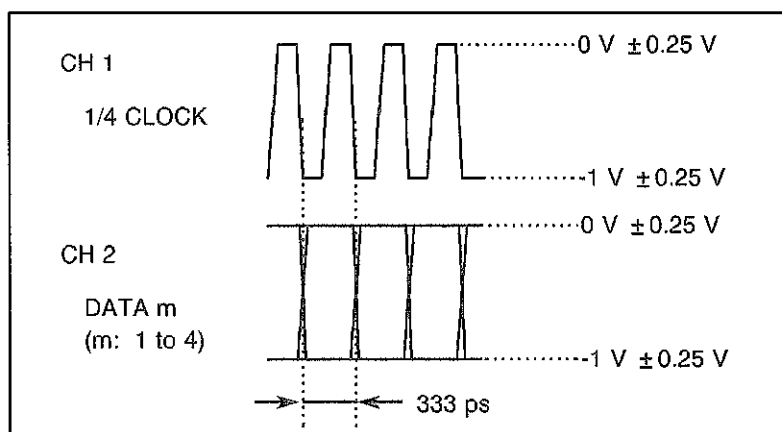

Figure 8-8 1/4 Rate Output Waveform ( $f = 12000 \text{ MHz}$ )

- (9) Sequentially change the output connected to the oscilloscope CH2 input from the rear panel DATA 1 to DATA 2, to DATA 3, and to DATA 4. Normal if the observed waveform with each output shows a rectangular wave as in Figure 8-8.

(b) Confirming 1/4 RATE output in WORD mode

- (1) Set the oscilloscope as follows:

Input impedance :	50 $\Omega$	}	Both CH1 and CH2
Input connection:	DC		
Vertical axis scale:	0.5 V/div		
Horizontal axis scale:	100 ps/div		
Trigger mode:	AUTO		
Trigger source:	EXTERNAL		
Trigger input impedance:	50 $\Omega$		

**D3186**  
**PULSE PATTERN GENERATOR**  
**OPERATION MANUAL**

**8.1 Performance Verification**

---

- (2) Set the frequency to 12000 MHz in the front panel frequency setting section (Figure 2-2).
- (3) Set the front panel pattern setting section (Figure 2-3) as follows:

PATTERN MODE WORD (5):	ON
POLARITY (11):	NORMAL
ALTERNATE (7):	OFF
Group select (12):	PATT DATA
EDIT (13):	ON
ITEM (16):	PATTERN LENGTH
Pattern length (17, 18):	3
ITEM (16):	ADDRESS
Address (17, 18):	0
PATTERN DATA (19):	010
- (4) Select 1/32 CLK using the front panel trigger output select key (2 in Figure 2-4).
- (5) Connect the front panel CLOCK INPUT connector (4 in Figure 2-4) and CLOCK OUTPUT connector (5 in Figure 2-4).
- (6) Connect the rear panel 1/4 CLOCK connector (11 in Figure 2-6) and DATA1 connector to the oscilloscope CH1 input and CH2 input, respectively.
- (7) Connect the front panel TRIGGER OUTPUT connector (3 in Figure 2-4) to the oscilloscope trigger input.
- (8) Confirm that the waveform is a rectangular wave as shown in Figure 8-8. (DATA m waveform is viewed slightly darker at LOW level than HIGH level).
- (9) Sequentially change the output connected to the oscilloscope CH2 input from the rear panel DATA 1 to DATA 2, to DATA 3, and to DATA 4. Normal if the observed waveform with each output shows a rectangular wave as in Figure 8-8.



### 8.1.7 Confirming $\overline{\text{CLOCK1}}$ , $\overline{\text{CLOCK1}}$ outputs

Front panel  $\overline{\text{CLOCK1}}$ ,  $\overline{\text{CLOCK1}}$  OUTPUT (variable clock output) is confirmed. Variable delay line is also confirmed.  $\overline{\text{CLOCK1}}$ ,  $\overline{\text{CLOCK1}}$  OUTPUT has three (3) types of output modes; (a) TO 0V, (b) TO -2V, (c) AC.

(a) Confirming  $\overline{\text{CLOCK1}}$ ,  $\overline{\text{CLOCK1}}$  outputs in TO 0V mode

(1) Set the oscilloscope as follows:

Input impedance :	50 $\Omega$	} Both CH1 and CH2
Input connection:	DC	
Vertical axis scale:	0.5 V/div	
Horizontal axis scale:	20 ps/div	
Trigger mode:	AUTO	
Trigger source:	EXTERNAL	
Trigger input impedance:	50 $\Omega$	

(2) Set the frequency to 12000 MHz in the front panel frequency setting section (Figure 2-2).

(3) Set the front panel output setting/connector section (Figure 2-4) as follows:

Trigger output (②):	1/32 CLK
$\overline{\text{CLOCK1}}$ , $\overline{\text{CLOCK1}}$ tracking (③):	ON
$\overline{\text{CLOCK1}}$ , $\overline{\text{CLOCK1}}$ output mode (④):	TO 0V
$\overline{\text{CLOCK1}}$ , $\overline{\text{CLOCK1}}$ offset mode (⑤):	HIGH
$\overline{\text{CLOCK1}}$ , $\overline{\text{CLOCK1}}$ offset (⑥):	0 V
$\overline{\text{CLOCK1}}$ , $\overline{\text{CLOCK1}}$ amplitude (⑦):	1 Vp-p
$\overline{\text{CLOCK1}}$ duty ratio regulation (⑧):	OFF
$\overline{\text{CLOCK1}}$ duty ratio regulation (⑨):	OFF

(4) Connect the front panel  $\overline{\text{CLOCK1}}$  INPUT connector (④ in Figure 2-4) and  $\overline{\text{CLOCK1}}$  OUTPUT connector (⑤ in Figure 2-4).

(5) Connect the front panel  $\overline{\text{CLOCK1}}$  connector (⑦ in Figure 2-4) and  $\overline{\text{CLOCK1}}$  connector to the oscilloscope CH1 input and CH2 input, respectively.

(6) Connect the front panel TRIGGER OUTPUT connector (③ in Figure 2-4) to the oscilloscope trigger input.

- (7) Confirm that the waveform is a rectangular wave as shown in Figure 8-9.

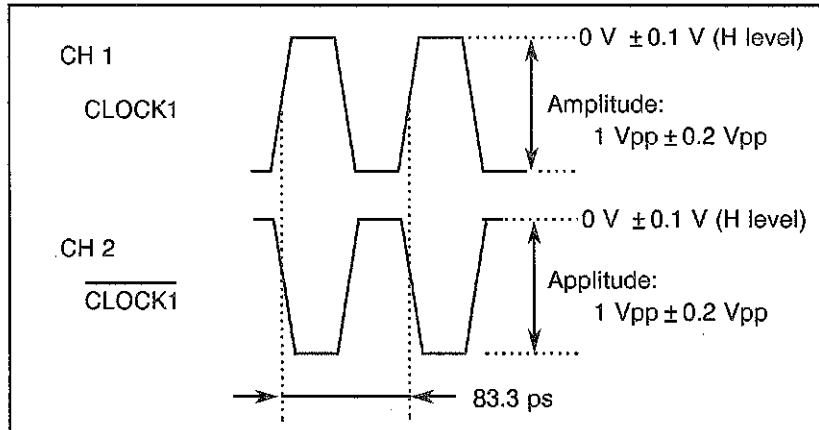

Figure 8-9 CLOCK1,  $\overline{\text{CLOCK1}}$  Output Waveform (TO 0V,  $f = 12000\text{ MHz}$ )

- (8) Confirm that changing the CLOCK1,  $\overline{\text{CLOCK1}}$  offset or amplitude setting varies the waveform.
- (9) Normal if the waveform moves to the right or left on the oscilloscope screen when the delay setting is changed in the front panel delay setting section (Ⓜ in Figure 2-4). The waveform moves to the right when the delay setting is increased in the + direction.

- (b) Confirming CLOCK1,  $\overline{\text{CLOCK1}}$  outputs in TO -2V mode

- (1) Set the oscilloscope as follows:

Input impedance :	50 $\Omega$	} Both CH1 and CH2
Input connection:	DC	
Vertical axis scale:	0.2 V/div	
Horizontal axis scale:	20 ps/div	
Trigger mode:	AUTO	
Trigger source:	EXTERNAL	
Trigger input impedance:	50 $\Omega$	

- (2) Set the frequency to 12000 MHz in the front panel frequency setting section (Figure 2-2).

- (3) Set the front panel output setting/connector section (Figure 2-4) as follows:
- |   |          |
|---|----------|
| Trigger output (②):                                   | 1/32CLK  |
| CLOCK1, $\overline{\text{CLOCK1}}$ tracking (⑬):      | ON       |
| CLOCK1, $\overline{\text{CLOCK1}}$ output mode (⑨):   | TO -2V   |
| CLOCK1, $\overline{\text{CLOCK1}}$ offset mode (⑩):   | HIGH     |
| CLOCK1, $\overline{\text{CLOCK1}}$ offset (⑭):        | -0.8 V   |
| CLOCK1, $\overline{\text{CLOCK1}}$ amplitude (⑤):     | 0.8 Vp-p |
| $\overline{\text{CLOCK1}}$ duty ratio regulation (⑮): | OFF      |
| CLOCK1 duty ratio regulation (⑯):                     | OFF      |
- (4) Connect the front panel CLOCK INPUT connector (④ in Figure 2-4) and CLOCK OUTPUT connector (⑤ in Figure 2-4).
- (5) Connect the front panel CLOCK1 connector (⑦ in Figure 2-4) and  $\overline{\text{CLOCK1}}$  connector to the oscilloscope CH1 input and CH2 input, respectively. At that time, insert an ECL termination jig between the CLOCK1,  $\overline{\text{CLOCK1}}$  connectors and the oscilloscope CH1 and CH2 inputs, respectively, for D3186 output -2V termination.

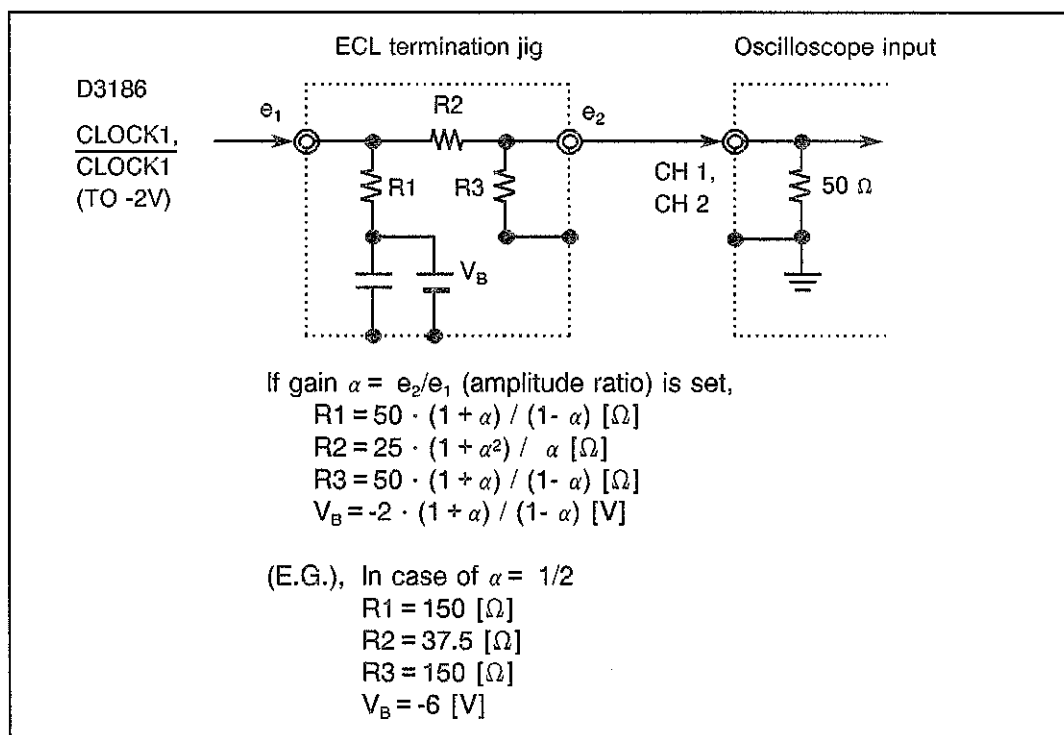

Figure 8-10 ECL Termination Jig Connection

- (6) Connect the front panel TRIGGER OUTPUT connector (③ in Figure 2-4) to the oscilloscope trigger input.
- (7) Confirm that the waveform is a rectangular wave as shown in figure 8-11.

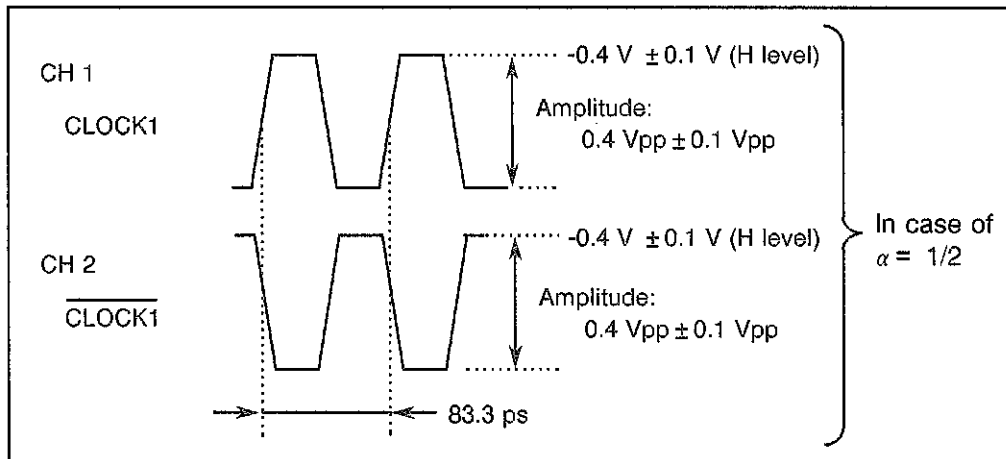

Figure 8-11 CLOCK1,  $\overline{\text{CLOCK1}}$ , Output Waveform (TO -2V,  $f = 12000 \text{ MHz}$ )

(c) Confirming CLOCK1,  $\overline{\text{CLOCK1}}$  outputs in AC mode

- (1) Set the oscilloscope as follows:

Input impedance :	50 $\Omega$	}	Both CH1 and CH2
Input connection:	AC*		
Vertical axis scale:	0.5 V/div		
Horizontal axis scale:	20 ps/div		
Trigger mode:	AUTO		
Trigger source:	EXTERNAL		
Trigger input impedance:	50 $\Omega$		

\*If the input connection cannot be AC, insert a DC blocking capacitor between the CLOCK1,  $\overline{\text{CLOCK1}}$  connectors and the oscilloscope CH1 and CH2 inputs, respectively, as shown in Figure 8-12.

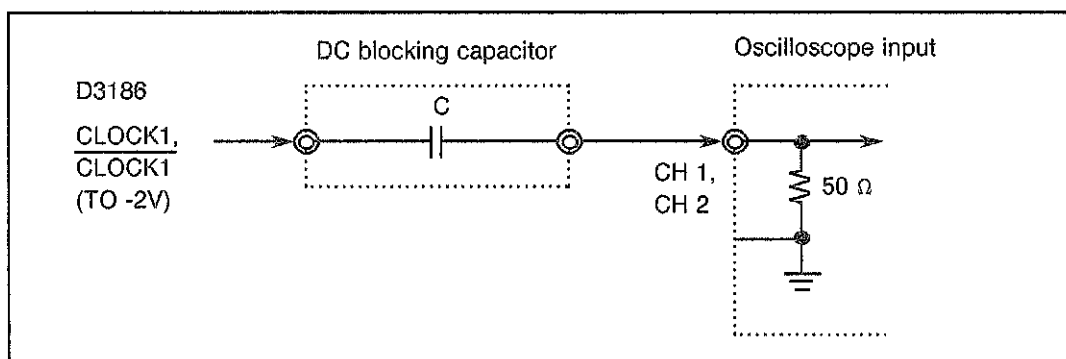

Figure 8-12 Connections of DC Blocking Capacitor

- (2) Set the frequency to 12000 MHz in the front panel frequency setting section (Figure 2-2).
- (3) Set the front panel output setting/connector section (Figure 2-4) as follows:

Trigger output (2):	1/32CLK
CLOCK1, $\overline{\text{CLOCK1}}$ tracking (3):	ON
CLOCK1, $\overline{\text{CLOCK1}}$ output mode (4):	AC
CLOCK1, $\overline{\text{CLOCK1}}$ amplitude (5):	1 Vp-p
CLOCK1 duty ratio regulation (6):	OFF
$\overline{\text{CLOCK1}}$ duty ratio regulation (6):	OFF
- (4) Connect the front panel CLOCK INPUT connector (4 in Figure 2-4) and CLOCK OUTPUT connector (5 in Figure 2-4).
- (5) Connect the front panel CLOCK1 connector (7 in Figure 2-4) and  $\overline{\text{CLOCK1}}$  connector to the oscilloscope CH1 input and CH2 input, respectively.  
At that time, if the input connection of the oscilloscope cannot be AC, insert a DC blocking capacitor between the CLOCK1,  $\overline{\text{CLOCK1}}$  connectors and the oscilloscope CH1 and CH2 inputs, respectively. (See Figure 8-12.)
- (6) Connect the front panel TRIGGER OUTPUT connector (3 in Figure 2-4) to the oscilloscope trigger input.
- (7) Normal when the waveform is a rectangular wave as shown in Figure 8-13.

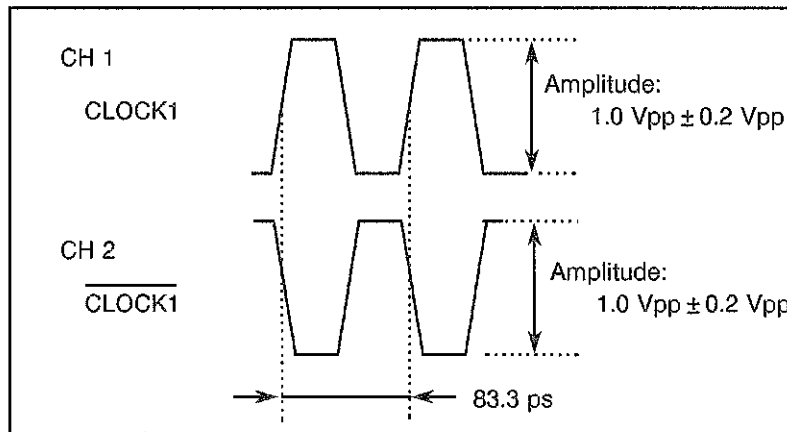

Figure 8-13 CLOCK1,  $\overline{\text{CLOCK1}}$  Output Waveform (AC,  $f = 12000 \text{ MHz}$ )

### 8.1.8 Confirming DATA, $\overline{\text{DATA}}$ Outputs

Front panel DATA,  $\overline{\text{DATA}}$  OUTPUT (data output) is confirmed.

DATA,  $\overline{\text{DATA}}$  OUTPUT has three (3) types of output modes; (a) TO 0V, (b) TO -2V, (c) AC.

(a) Confirming DATA,  $\overline{\text{DATA}}$  output in TO 0V mode

(1) Set the oscilloscope as follows:

Input impedance :	50 $\Omega$	} Both CH1 and CH2
Input connection:	DC	
Vertical axis scale:	0.5 V/div	
Horizontal axis scale:	20 ps/div	
Trigger mode:	AUTO	
Trigger source:	EXTERNAL	
Trigger input impedance:	50 $\Omega$	

(2) Set the frequency to 12000 MHz in the front panel frequency setting section (Figure 2-2).

(3) Set the front panel output setting/connector section (Figure 2-4) as follows:

PATTERN MODE PRBS (①):	ON
Number of PRBS steps (②):	15
Mark ratio (③):	1/2

- (4) Set the front panel output setting/connector section (Figure 2-4) as follows:
- |  |          |
|--|----------|
| Trigger output (②):                                  | 1/32 CLK |
| DATA, $\overline{\text{DATA}}$ tracking (⑨):         | ON       |
| DATA, $\overline{\text{DATA}}$ output mode (⑩):      | TO 0V    |
| DATA, $\overline{\text{DATA}}$ offset mode (⑪):      | HIGH     |
| DATA, $\overline{\text{DATA}}$ offset (⑫):           | 0 V      |
| DATA, $\overline{\text{DATA}}$ amplitude (⑬):        | 1 Vp-p   |
| DATA cross point regulation (⑭):                     | OFF      |
| $\overline{\text{DATA}}$ cross point regulation (⑮): | OFF      |
| OUTPUT ON/OFF(⑯):                                    | ON       |
- (5) Connect the front panel CLOCK INPUT connector (④ in Figure 2-4) and CLOCK OUTPUT connector (⑤ in Figure 2-4).
- (6) Connect the front panel DATA connector (⑧ in Figure 2-4) and  $\overline{\text{DATA}}$  connector to the oscilloscope CH1 input and CH2 input, respectively.
- (7) Connect the front panel TRIGGER OUTPUT connector (③ In Figure 2-4) to the oscilloscope trigger input.
- (8) Confirm that the waveform is eye patterns as shown in Figure 8-14.

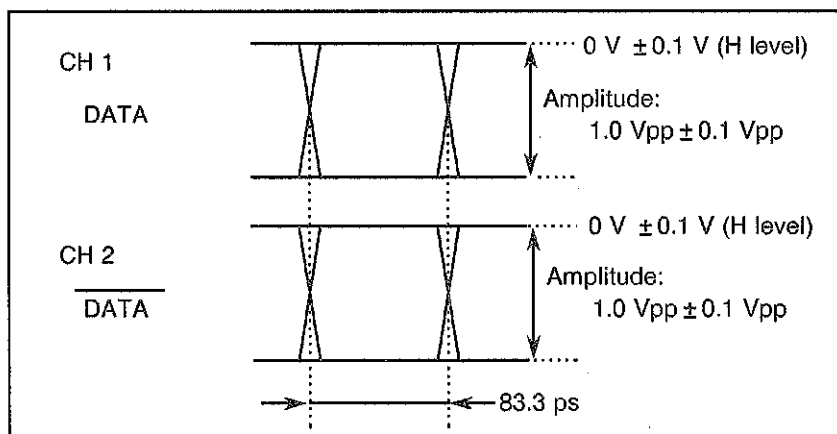

Figure 8-14 DATA,  $\overline{\text{DATA}}$  Output Waveform (TO 0V,  $f = 12000$  MHz)

- (9) Confirm that changing the DATA,  $\overline{\text{DATA}}$  offset or amplitude setting varies the waveform.
- (10) Confirm that changing the mark ratio varies the waveform HIGH/LOW level darkness. Normal when DATA OUTPUT HIGH level becomes darker and LOW level becomes dimmer as the mark ratio is increased; normal display for  $\overline{\text{DATA}}$  OUTPUT in the reverse case.

(b) Confirming DATA,  $\overline{\text{DATA}}$  outputs in TO -2V mode

(1) Set the oscilloscope as follows:

Input impedance :	50 $\Omega$	} Both CH1 and CH2
Input connection:	DC	
Vertical axis scale:	0.2 V/div	
Horizontal axis scale:	20 ps/div	
Trigger mode:	AUTO	
Trigger source:	EXTERNAL	
Trigger input impedance:	50 $\Omega$	

(2) Set the frequency to 12000 MHz in the front panel frequency setting section (Figure 2-2).

(3) Set the front panel pattern setting section (Figure 2-3) as follows:

PATTERN MODE PRBS (①):	ON
Number of PRBS steps (②):	15
Mark ratio (③):	1/2

(4) Set the front panel output setting/connector section (Figure 2-4) as follows:

Trigger output (②):	1/32 CLK
DATA, $\overline{\text{DATA}}$ tracking (⑬):	ON
DATA, $\overline{\text{DATA}}$ output mode (⑩):	TO -2V
DATA, $\overline{\text{DATA}}$ offset mode (⑰):	HIGH
DATA, $\overline{\text{DATA}}$ offset (⑳):	-0.8 V
DATA, $\overline{\text{DATA}}$ amplitude (㉑):	0.8 Vp-p
DATA cross point regulation (㉒):	OFF
$\overline{\text{DATA}}$ cross point regulation (㉓):	OFF
OUTPUT ON/OFF(㉔):	ON

(5) Connect the front panel CLOCK INPUT connector (④ in Figure 2-4) and CLOCK OUTPUT connector (⑤ in Figure 2-4).

(6) Connect the front panel DATA connector (⑧ in Figure 2-4) and  $\overline{\text{DATA}}$  connector to the oscilloscope CH1 input and CH2 input, respectively.

At that time, insert an ECL termination jig between the DATA,  $\overline{\text{DATA}}$  connectors and the oscilloscope CH1 and CH2 inputs, respectively, for D3186 output -2V termination, as shown in Figure 8-10.



- (7) Connect the front panel TRIGGER OUTPUT connector (③ in Figure 2-4) to the oscilloscope trigger input.
- (8) Confirm that the waveform is eye patterns as shown in Figure 8-15.

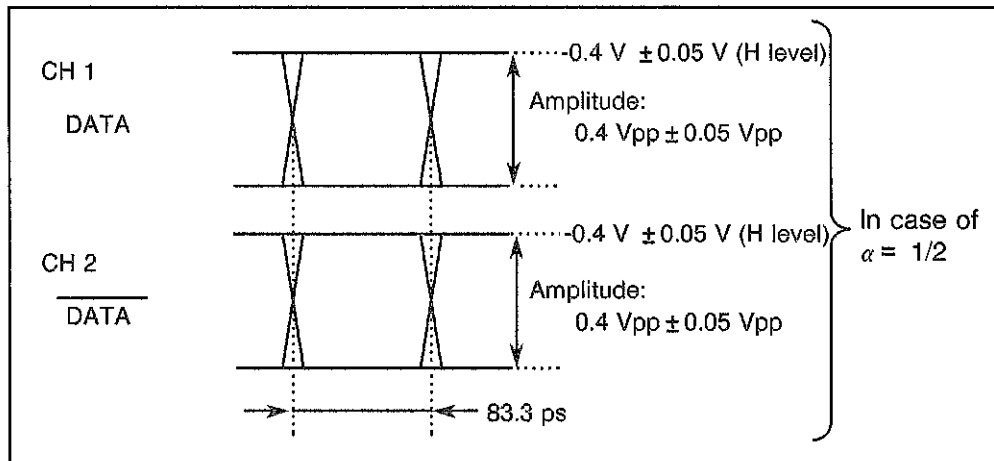

Figure 8-15 DATA,  $\overline{\text{DATA}}$  Output Waveform (TO -2V,  $f = 12000$  MHz)

- (c) Confirming DATA,  $\overline{\text{DATA}}$  outputs in AC mode

- (1) Set the oscilloscope as follows:
 

Input impedance :	50 $\Omega$	} Both CH1 and CH2
Input connection:	AC*	
Vertical axis scale:	0.5 V/div	
Horizontal axis scale:	20 ps/div	
Trigger mode:	AUTO	
Trigger source:	EXTERNAL	
Trigger input impedance:	50 $\Omega$	

\*If the input connection cannot be AC, insert a DC blocking capacitor between the DATA,  $\overline{\text{DATA}}$  connectors and the oscilloscope CH1 and CH2 inputs, respectively, as shown in Figure 8-12.

- (2) Set the frequency to 12000 MHz in the front panel frequency setting section (Figure 2-2).
- (3) Set the front panel pattern setting section (Figure 2-3) as follows:
 

PATTERN MODE PRBS (①):	ON
Number of PRBS steps (②):	15
Mark ratio (③):	1/2

- (4) Set the front panel output setting/connector section (Figure 2-4) as follows:

Trigger output (②):	1/32 CLK
DATA, $\overline{\text{DATA}}$ tracking (⑨):	ON
DATA, $\overline{\text{DATA}}$ output mode (⑩):	AC
DATA, $\overline{\text{DATA}}$ amplitude (⑫):	1 Vp-p
DATA cross point regulation (⑬):	OFF
$\overline{\text{DATA}}$ cross point regulation (⑭):	OFF
OUTPUT ON/OFF(⑮):	ON

- (5) Connect the front panel CLOCK INPUT connector (④ in Figure 2-4) and CLOCK OUTPUT connector (⑤ in Figure 2-4).
- (6) Connect the front panel DATA connector (⑧ in Figure 2-4) and  $\overline{\text{DATA}}$  connector to the oscilloscope CH1 input and CH2 input, respectively.  
At that time, if the input connection of the oscilloscope cannot be AC, inset a DC blocking capacitor between the DATA,  $\overline{\text{DATA}}$  connectors and the oscilloscope CH1 and CH2 inputs, respectively. (See Figure 8-12.)
- (7) Connect the font panel TRIGGER OUTPUT connector (③ in Figure 2-4) to the oscilloscope trigger input.
- (8) Normal when the waveform is eye patterns as shown in Figure 8-16.

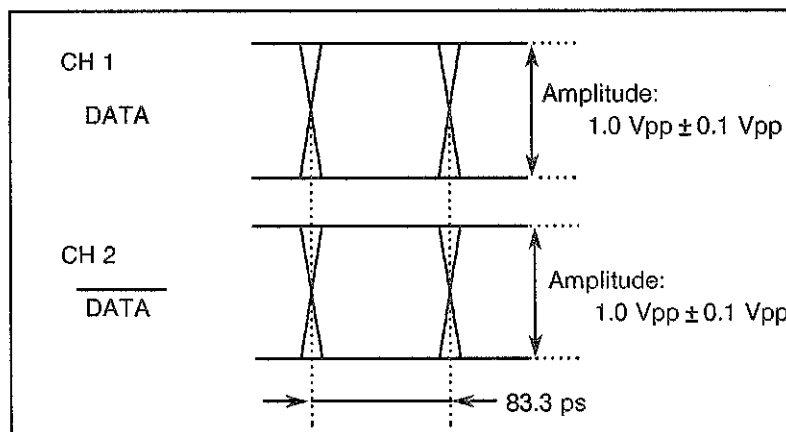

Figure 8-16 DATA,  $\overline{\text{DATA}}$  Output Waveform (AC, f = 12000 MHz)

## 8.2 Confirming Function

This section describes the procedure for confirming a bit error using the D3286 error detector.

### 8.2.1 Connections and Basic Setup of D3186 and D3286

- (1) Connect the following connectors via cable:  
D3186 front panel CLOCK2 OUTPUT . . . . . D3286 front panel CLOCK INPUT  
D3186 front panel DATA OUTPUT . . . . . D3286 front panel DATA INPUT  
D3186 rear panel GPIB . . . . . D3286 rear panel GPIB
  
- (2) Set the D3186 panel as follows:  
CLOCK RATE: Arbitrary frequency  
OUTPUT MODE - DATA: TO 0V  
DATA OFFSET MODE: MIDDLE  
DATA OFFSET: -0.50V  
DATA AMPLITUDE: 1.00Vp-p  
DATA C - P ADJ: OFF  
ERROR ADDITION: OFF  
GP-IB MASTER: ON
  
- (3) Set the D3286 panel as follows:  
TERMINATOR - CLOCK: TO 0V  
TERMINATOR - DATA: TO 0V  
INPUT POLARITY: NORMAL (INVERSE for D3186  $\overline{\text{DATA}}$  output test)  
THRESHOLD LEVEL: -0.500V  
MEASUREMENT: ERROR RATE  
DISPLAY MODE: TOTAL, ALL, ALL  
CURRENT DATA: ON  
IMMEDIATE DATA: ON  
MEASUREMENT TIME: NORMAL  
EXTERNAL GATE: OFF (INTERNAL)  
AUTO SYNC: ON  
FRAME SYNC: OFF  
BUZZER - DATA: ON  
BUZZER - ALARM: ON  
TIMER MODE: UNTIMED  
GP-IB SLAVE: ON

### 8.2.2 Confirming the frequency

- (1) Set the D3286 panel as follows:  
MEASUREMENT:        FRQ (MHz)
- (2) Press the START key on the D3286 panel to start measurement.  
Normal when a value nearly the same as the frequency set with D3186 CLOCK RATE is displayed on the D3286 measurement indicator.

### 8.2.3 Confirming the PRBS Pattern

- (1) Set the D3186 panel as follows:  
PATTERN MODE:        PRBS  
PRBS  $2^N-1$ :         Arbitrary  
MARK RATIO:         1/2  
Confirm that the D3286 pattern setting section has the same setting as the D3186 depending on the master/slave control function.
- (2) Set the D3286 panel as follows:  
MEASUREMENT:        ERROR RATE
- (3) Press the AUTO SEARCH key on the D3286 panel to automatically search for optimum values of data input threshold levels and clock input delays. During the search, and then disappears when they are found:  

S E A R C H
- (4) Press the START key on the D3286 panel to start the measurement. Normal when the error rate measurement is  $0.E-x$  ( $x$  varies depending on the condition).
- (5) Set the D3186 panel as follows:  
ERROR ADDITION:     REPEAT  $1 \times 10^{-4}$
- (6) Confirm that the D3286 DATA ERROR lamp is lit, the buzzer sounds, and the error rate measurement is approx.  $1.0E^{-4}$ .
- (7) Set the D3186 panel as follows:  
ERROR ADDITION:     OFF
- (8) Confirm that the error rate measurement is  $0.E-x$  ( $x$  varies depending on the condition) even with varied settings of the following on the D3186 panel:  
PRBS  $2^N-1$ :         Arbitrary  
MARK RATIO:         1/8 to 7/8  
However, immediately after these setting are change, a sync error occurs to interrupt the measurement. When recovery is made from the sync error, the measurement becomes 0. If the sync error recovery is not successful, press the AUTO SEARCH key on the D3286 panel.

### 8.2.4 Confirming the Word Pattern

- (1) Set the D3186 panel as follows:

PATTERN MODE: WORD  
ALTERNATE: OFF  
POLARITY: Arbitrary  
PATTERN LENGTH: Arbitrary  
PATTERN DATA: Arbitrary

Confirm that the D3286 pattern setting section has the same setting as the D3186 depending on the master/slave control function.

- (2) Set the D3286 panel as follows:

MEASUREMENT: ERROR RATE

- (3) Press the AUTO SEARCH key on the D3286 panel to automatically search for optimum values of data input threshold levels and clock input delays. During the search, the following is displayed on the measurement indicator, and then disappears when they are found:

S E A R C H

If the pattern set in (1) has an extremely one-sided 0/1 ratio, the optimum value cannot be found and the following is indicated on the measurement indicator:

n o t F o u n d

In this case, change the pattern so that the mark ratio (ratio of 1 in all bits) will be in the range from 1/8 to 7/8.

- (4) Press the START key on the D3286 panel to start the measurement. Normal when the error rate measurement is 0.E-x (x varies depending on the condition).
- (5) Confirm that the error rate measurement is 0.E-x (x varies depending on the condition) even with varied settings of the following on the D3186 panel:

POLARITY: Arbitrary  
PATTERN LENGTH: Arbitrary  
Pattern contents: Arbitrary

However, immediately after these settings are changed, a sync error occurs to interrupt the measurement. When recovery is made from the sync error, the measurement becomes 0. If the sync error recovery is not successful, press the AUTO SEARCH key on the D3286 panel.



## 9. SPECIFICATIONS

### 9.1 Operation Clock

Operation clock source:	Internal clock (optional) and external clock
• Internal clock (optional)	
Frequency range:	150 MHz to 12 GHz (Option 10) 2 GHz to 12 GHz (Option 11) 150 MHz to 12.5 GHz (Option 13)
Frequency setting resolution:	1 kHz
Frequency stability:	$\pm 10$ ppm/year
Output waveform:	Sine wave of about 1 Vp-p
Spurious:	-37 dBc (non-harmonics)
SSB phase noise:	-70 dBc/Hz (10 kHz offset and 12 GHz carrier)
Frequency memory:	16 types
Load impedance:	50 $\Omega$
Connector:	SMA (jack)
Reference frequency output:	10 MHz, 1.5 Vp-p, AC coupling, BNC
Phase modulation input:	10 MHz, 1.5 Vp-p, AC coupling, BNC, automatic switching
• External clock	
Frequency range:	150 MHz to 12 GHz 150 MHz to 12.5 GHz (Option 72)
Input level:	0.7 Vp-p to 1.5 Vp-p
Input waveform:	Sine wave
Impedance:	Approximately 50 $\Omega$ (nominal value), to GND
Connector:	SMA (jack)
• Main body operation frequency range:	150 MHz to 12 GHz 150 MHz to 12.5 GHz (Option 72)





D3186  
PULSE PATTERN GENERATOR  
OPERATION MANUAL

• WORD

Pattern length: 1 to 8388608 ( $2^{23}$ ) bits (When alternate mode is off)  
1 to 4194304 ( $2^{22}$ ) bits (When alternate mode is on)

Pattern length variable step:

ALTERNATE	Range of pattern length (bits)	Step (bits)
OFF	1 to 32,768	1
	32,770 to 65,536	2
	65,540 to 131,072	4
	131,080 to 262,144	8
	262,160 to 524,288	16
	524,320 to 1,048,576	32
	1,048,640 to 2,097,152	64
	2,097,280 to 4,194,304	128
	4,194,560 to 8,388,608	256
ON	1 to 16,384	1
	16,386 to 32,768	2
	32,772 to 65,536	4
	65,544 to 131,072	8
	131,088 to 262,144	16
	262,176 to 524,288	32
	524,352 to 1,048,576	64
	1,048,704 to 2,097,152	128
	2,097,408 to 4,194,304	256

Logical inversion: Possible  
 Alternate mode: Can be turned ON or OFF.  
 When ON, switchover between patterns A and B is possible.  
 Switching control: Internal and external switchable  
 Internal switching: By means of front panel keys and GPIB interface  
 External switching: By means of an external alternate input signal

**D3186**  
**PULSE PATTERN GENERATOR**  
**OPERATION MANUAL**

● **FRAME**

Payload format:

Select from the following three types.

- Full programmable (WORD)
- Pseudo-random (PRBS)  
(Only the overhead section is programmable.)
- 0/1 continuous pattern + PRBS (CID)

Frame configuration:

When the payload format is WORD or PRBS:

Frame count ;

1 to 8192 frames (when alternate mode is OFF)

1 to 4096 frames (when alternate mode is ON)

In 1-frame steps

Up to the maximum frame count shown below

Maximum frame count;

Byte count/frame = (Line count/frame) x (Byte count/line)

ALTERNATE	Byte count/frame	Maximum frame count
OFF	Multiple of 32	1,048,576 / (Byte count / frame)
	Multiple of 16	524288 / (Byte count / frame)
	Multiple of 8	262144 / (Byte count / frame)
	Other than multiple of 8	131072 / (Byte count / frame)
ON	Multiple of 32	524288 / (Byte count / frame)
	Multiple of 16	262144 / (Byte count / frame)
	Multiple of 8	131072 / (Byte count / frame)
	Other than multiple of 8	65535 / (Byte count / frame)

Line count / frame;

1 to 16 lines in 1-steps

Byte count / line;

44 to 32768 bytes

Byte count with variable steps;

ALTERNATE	Byte count / line	Steps (bytes)
OFF	44 to 8,192	4
	8,200 to 16,384	8
	16,400 to 32,768	16
ON	44 to 4,096	4
	4,104 to 8,192	8
	8,208 to 16,384	16
	16,416 to 32,768	32

Overhead byte count / line;

4 to (Byte count for one line) - 40 bytes in 4-byte steps

D3186  
PULSE PATTERN GENERATOR  
OPERATION MANUAL

9.2 Pattern

---

- When the payload format is CID:
- |                                       |   |
|---------------------------------------|---|
| Byte count / line;                    | 40 to 32768 in 4-byte steps   |
| Overhead byte count / line;           | 36 to (Byte count for one line) - 4 bytes in 36-byte steps                          |
| Bit count for 0/1 continuous pattern; | 0 to ((Byte count / line) - (Overhead byte count / line)) x 8 bits in one-bit steps |
| Number of stages of PRBS;             | Seven (Non-continuous section may exist.)   |
- Logical inversion: Possible
- Alternate mode: Can be turned on or off. (When the payload format is WORD or PRBS.)  
When on, switchover between patterns A and B is possible.
- Switching control: Internal and external switchable
- |                     |   |
|---------------------|---|
| Internal switching; | By means of front panel keys and GPIB interface |
| External switching; | By means of the external alternate input signal |
- Error addition
- |                      |  |
|----------------------|--|
| Error addition mode: | Repeat, single, external   |
| Repeat:              | Bit error is added in the regular interval at the error ratio of $1 \times 10^{-N}$ (N = 4 to 9) |
| Single:              | Adds a 1-bit error for every error addition command.   |
| External:            | Adds a 1-bit error for every leading edge of external error addition pulse input.                |

### 9.3 Main Input

Output count:	Data Two types (DATA, $\overline{\text{DATA}}$ ) Clock Three types (CLOCK1, $\overline{\text{CLOCK1}}$ , CLOCK2)
• Data output (DATA, $\overline{\text{DATA}}$ )	
Output count:	Two types (DATA, $\overline{\text{DATA}}$ complimentary)
Format:	NRZ
Coupling:	DC
Amplitude range:	0.5 Vp-p to 2 Vp-p, 10 mV step (TO 0V, AC) 0.6 Vp-p to 1 Vp-p, 10 mV step (TO -2V) For Option 15: 0.5 Vp-p to 3 Vp-p, 10 mV step (TO 0V) 0.5 Vp-p to 2 Vp-p, 10 mV step (TO AC) 0.6 Vp-p to 1 Vp-p, 10 mV step (TO -2V)
Offset range:	-2 V to +2 V, 10 mV step (TO -2V) -1 V to -0.6 V, 10 mV step (TO -2V) For Option 15: -1 V to +1 V, 10 mV step (TO 0V) -1 V to +0.6 V, 10 mV step (TO -2V) (Reference of high level)
Rise time and fall time:	30 ps or less (20% to 80% of amplitude)
Timing jitter:	20 ps or less
Load termination condition:	Can be selected from DC coupling TO 0V, TO -2V and AC coupling.
Offset setting level:	Can be selected from HIGH, MIDDLE and LOW.
Cross point variability:	ON or OFF can be selected. GPIO can be changed.
Load impedance:	50 $\Omega$
Connector:	2.92mm (plug)
• Clock output (CLOCK1, $\overline{\text{CLOCK1}}$ )	
Output count:	2 types (CLOCK1, $\overline{\text{CLOCK1}}$ complimentary)
Format:	RZ
Coupling:	DC
Amplitude range:	0.5 Vp-p to 2 Vp-p, 10 mV step (TO 0V, AC) 0.6 Vp-p to 1 Vp-p, 10 mV step (TO -2V)
Offset range:	-2 V to +2 V, 10 mV step (TO -2V) -1 V to -0.6 V, 10 mV step (TO -2V) (Reference of high level)

**D3186**  
**PULSE PATTERN GENERATOR**  
**OPERATION MANUAL**

**9.3 Main Input**

Rise time and fall time : 30 ps or less (20% to 80% of amplitude) 6 GHz to 12 GHz  
 Load termination condition: Can be selected from DC coupling TO 0V, TO -2V and AC coupling.

Offset setting level: Can be selected from HIGH, MIDDLE and LOW.  
 Duty rate variability: ON or OFF can be selected.  
 Variable delay amount:  $\pm 400$  ps in 1-ps steps (Reference of CLOCK2 output)  
 Load impedance:  $50 \Omega$   
 Connector: 2.92mm (plug)

• Clock output (CLOCK2)

Output count: 1 type  
 Format: RZ  
 Coupling: AC (with built-in DC blocking capacitor)  
 Amplitude: Approx. 1 V<sub>p-p</sub> fixed  
 Offset: 0 V  $\pm$  0.1 V fixed (reference of middle level)  
 Waveform: Rectangular wave  
 Load impedance:  $50 \Omega$   
 Connector: 2.92mm (plug)

• Output phase (at variable delay amount of 0)

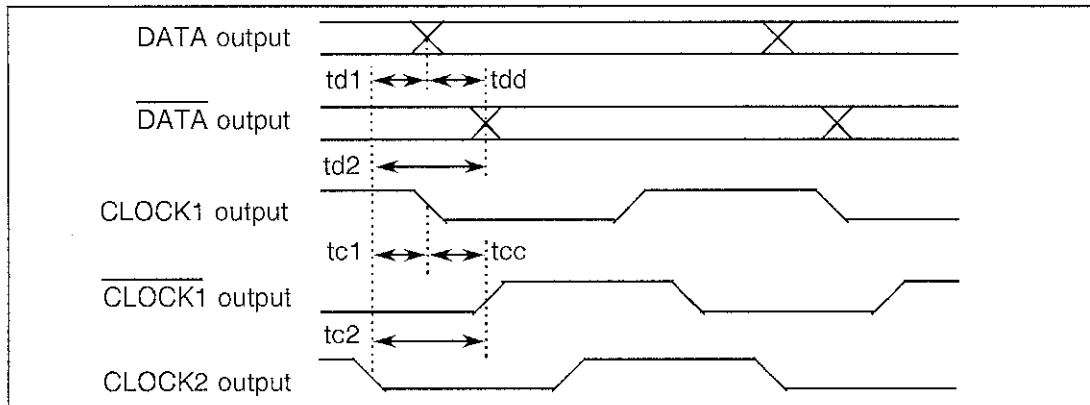

D3186  
PULSE PATTERN GENERATOR  
OPERATION MANUAL

9.3 Main Input

Symbol	Specification output		Reference output	
	Signal name	Specification point	Signal name	Reference point
td1	DATA	Cross point ( $\overline{X}$ )	CLOCK2	Leading ( $\searrow$ )
td2	$\overline{DATA}$	Cross point ( $\overline{X}$ )	CLOCK2	Leading ( $\searrow$ )
tdd	DATA	Cross point ( $\overline{X}$ )	$\overline{DATA}$	Cross point ( $\overline{X}$ )
tc1	CLOCK1	Leading ( $\searrow$ )	CLOCK2	Leading ( $\searrow$ )
tc2	$\overline{CLOCK1}$	Trailing ( $\nearrow$ )	CLOCK2	Leading ( $\searrow$ )
tcc	CLOCK1	Leading ( $\searrow$ )	$\overline{CLOCK1}$	Trailing ( $\nearrow$ )

Symbol	Specification output	Reference output	Frequency range		
			6 GHz or more	2 GHz to 6 GHz	Less than 2 GHz
td1	DATA $\overline{X}$	CLOCK2 $\searrow$	$\pm 40$ ps or less	$\pm 80$ ps or less	$\pm 150$ ps or less
td2	$\overline{DATA}$ $\overline{X}$	CLOCK2 $\searrow$	$\pm 40$ ps or less	$\pm 80$ ps or less	$\pm 150$ ps or less
tdd	DATA $\overline{X}$	$\overline{DATA}$ $\overline{X}$	$\pm 40$ ps or less	$\pm 80$ ps or less	$\pm 150$ ps or less
tc1	CLOCK1 $\searrow$	CLOCK2 $\searrow$	$\pm 40$ ps or less	$\pm 80$ ps or less	$\pm 150$ ps or less
tc2	$\overline{CLOCK1}$ $\nearrow$	CLOCK2 $\searrow$	$\pm 40$ ps or less	$\pm 80$ ps or less	$\pm 150$ ps or less
tcc	CLOCK1 $\searrow$	$\overline{CLOCK1}$ $\nearrow$	$\pm 40$ ps or less	$\pm 80$ ps or less	$\pm 150$ ps or less

## 9.4 Auxiliary Output Signals

- Trigger signal output

Output signal: Clock synchronization or pattern synchronization selectable  
 Clock synchronization (1/32CLK): Outputs frequency which is 1/32 times the clock frequency  
 Pattern synchronization (PATTERN):  
 Output position can be changed in 16-bit units.  
 Output level: High level;  $0\text{ V} \pm 0.2\text{ V}$   
 Low level;  $-1\text{ V} \pm 0.2\text{ V}$   
 Load impedance:  $50\ \Omega$  to  $0\text{ V}$   
 Connector: SMA

- 1/2 clock output

Format: RZ  
 Coupling: DC  
 Output level: High level;  $0\text{ V} \pm 0.2\text{ V}$   
 Low level;  $-1\text{ V} \pm 0.2\text{ V}$   
 Load impedance:  $50\ \Omega$  to  $0\text{ V}$   
 Connector: SMA

- 1/4 rate output

Output bit rate: 1/4 of operation clock frequency  
 Pattern output count: 4 types  
 Clock output count: 1 type  
 Output skew:  $\pm 150\text{ ps}$  or less (corresponding to the following figure)  
 Output level: High level;  $0\text{ V} \pm 0.2\text{ V}$   
 Low level;  $-1\text{ V} \pm 0.2\text{ V}$   
 Load impedance:  $50\ \Omega$  to  $0\text{ V}$   
 Connector: SMA

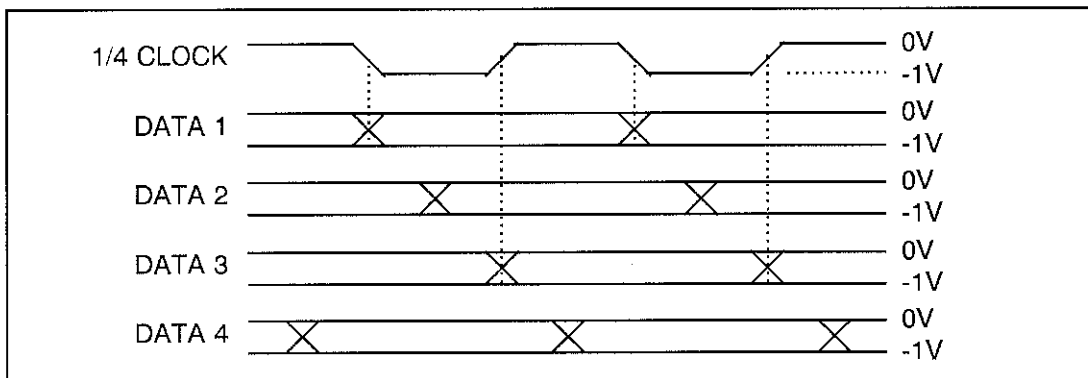

## 9.5 Control Input Signals

- External gate input
  - Function: Inhibits data output in low level.
  - Input level: 0 V/-1 V
  - Input pulse width: 20 ns or more
  - Rising/falling time: 10 ns or less
  - Input impedance: Approx. 50  $\Omega$  with respect to 0 V
  - Connector: BNC
- External alternate input
  - Function: Switches between patterns A and B in alternate mode. High level select pattern A and low level pattern B,
  - Input level : 0 V/-1 V
  - Input pulse width: 20 ns or more
  - Rising/falling time: 10 ns or less
  - Input impedance: Approx. 50  $\Omega$  with respect to 0 V
  - Connector: BNC
- External error addition input
  - Function: Adds a 1-bit error at every leading edge of input pulse when the error addition of pattern is external.
  - Input level : 0 V/-1 V
  - Input pulse width: 20 ns or more
  - Rising/falling time: 10 ns or less
  - Repetitive rate: 1/64 or less of operation clock frequency
  - Input impedance: Approx. 50  $\Omega$  with respect to 0 V
  - Connector: BNC



## 9.6 System Functions

- Master slave function
  - Function: When the D3286 error detector is used together with the D3186 pulse pattern generator, associates D3186 and D3286 pattern settings.
  - Association mode: Associates D3286 pattern settings with D3186 pattern settings and vice versa.
  - Connecting method : Connected with GPIB connectors and a GPIB cable.
  
- External clock generator control function
  - Function: When an external clock generator (SG) is used, its frequency and output level are controlled from D3186.
  - Available clock generator: TR4515 synthesized sweeper by ADVANTEST, HP8360 series synthesized sweeper by Hewlett-Packard, SMP series by ROHDE&SCHWARZ or other signal generator can be controlled by GPIB
  - Connection: Dedicated GPIB connector  
Set the external clock generator to addressable mode and the device address to 20 fixed.
  
- Panel locking: All condition settings, excluding power on/off, panel lock on/off, GPIB LOCAL recovery, settings with rear panel DIP switches, cross point adjustment, duty rate adjustment, can be locked.
  
- Remote control
  - Interface: GPIB (IEEE488-1978)
  - Interface function: SH1, AH1, T5, L3, SR1, RL1, PP01, DC1, DT1, C0, and E2
  - Control: All front panel settings and read out excluding power ON/OFF, duty rate adjustment, cross point adjustment, and GPIB address
  
- Calender/clock function
  - Display: "Year, month, day and hour" or "day, hour, minute and second" selectable  
Year; 00 to 99 (lower 2 digits in Christian era)  
Month; 01 to 12  
Day; 01 to 31  
Hour; 00 to 23  
Minute; 00 to 59  
Second; 00 to 59

D3186  
PULSE PATTERN GENERATOR  
OPERATION MANUAL

---

**9.7 General Specifications**

- File function (with a built-in floppy disk drive)
  - Function: Stores, overwrites, reads, deletes, and initializes files.
  - Storage data: Operating conditions and pattern contents
  - Read data: Operating conditions and pattern contents
  - Disk used: 3.5-inch floppy disks  
720 KB (2DD), 1.2 MB (2HD), 1.4 MB (2HD)
  - Disk format: MS-DOS<sup>®</sup> Rev. 4.0
  - File format: Unique binary format

◆ MS-DOS is a registered trademark of Microsoft Inc. of the U.S.A.

## 9.7 General Specifications

Numeral indicator:	Seven-segment green LED
Condition setting memory:	Retained for more than two weeks after power on for 12 hours (Backed up by a secondary battery.)
Operating temperature:	0 °C to +40 °C +20 °C to +30 °C (Option 72)
Operating humidity:	40% to 85% RH
Storage temperature:	-20 °C to +60 °C
Storage humidity:	30% to 85% RH (Without condensation)
Power supply:	100 VAC - 120 VAC, 220 VAC - 240 VAC (Automatic switching) 50 / 60 Hz, Sine wave
Power dissipation:	550 VA or less
Weight:	48 kg or less
Dimensions:	Approx. 310 (H) x 424 (W) x 550 (D) mm <sup>5</sup> :

## LIST OF ABBREVIATIONS

### [A]

AC: Alternating Current  
ASCII: American Standard Code for Information Interchange  
ATN: Attention

### [C]

CID: Consecutive Identical Digit

### [D]

DAV: Data Valid  
DC: Direct Current  
DCL: Device Clear  
DIR: Directory  
DOS: Disk Operating System  
DUT: Device under Test

### [E]

EOI: End or Identify  
ERD: Error Detector

### [G]

GPIB: General Purpose Interface Bus

### [I]

IEEE: The Institute of Electrical and Electronics Engineers, Ins.  
IFC: Interface Clear  
ITU-T: International Telecommunication Union - Telecommunication Standardization Sector

### [M]

MPU: Micro Processing Unit

### [N]

NDAC: Not Data Accepted  
NRFD: Not Ready for Data

### [P]

PPG: Pulse Pattern Generator  
PRBS: Pseudo - Random Binary Sequence

### [R]

REN: Remote Enable  
RQS: Request Service

D3186  
PULSE PATTERN GENERATOR  
OPERATION MANUAL

---

A.1 List of Abbreviations

**[S]**

SDC: Selected Device Clear  
SDH: Synchronous Digital Hierarchy  
SG: Signal Generator  
SOH: Section Overhead  
SONET: Synchronous Optical Network  
SRQ: Service Request  
STM: Synchronous Transport Module

**[U]**

UUT: Unit under Test

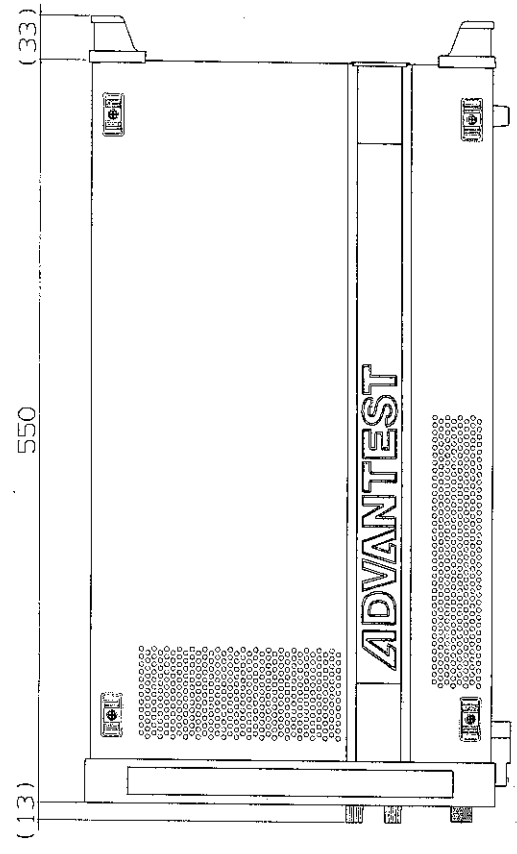
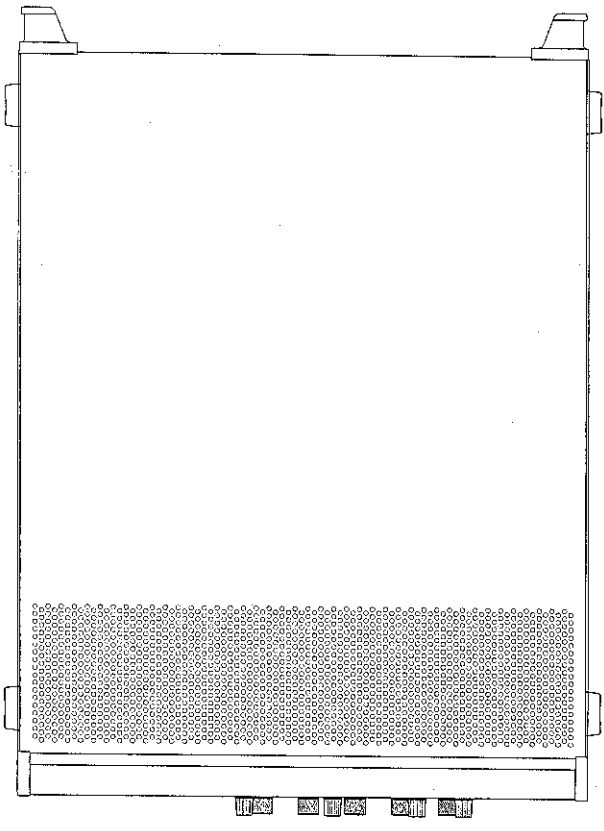
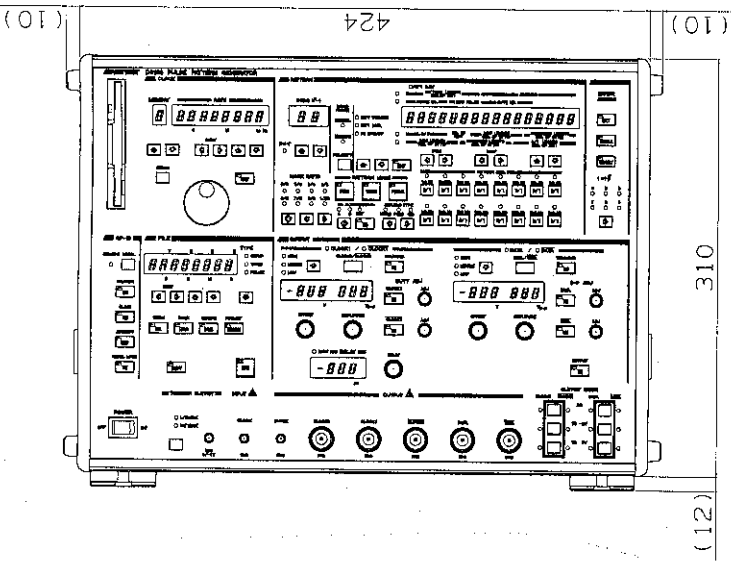

Unit : mm

**CAUTION**

This drawing shows external dimensions of this instrument.  
The difference in products and options used can cause a change in the appearance of the instrument.

**DIMENSIONAL OUTLINE DRAWING**



## ALPHABETICAL INDEX

	<b>[I]</b>		
1/2 CLOCK Output Waveform . . . . .	8-3	CLOCK1, <u>CLOCK1</u> Output Waveform . . . . .	8-16
1/4 Rate Output Waveform . . . . .	8-9	CLOCK1, <u>CLOCK1</u> Output Waveform . . . . .	8-12
	<b>[A]</b>	CLOCK1, <u>CLOCK1</u> , Output Waveform . . . . .	8-14
Address Setting Range and Maximum Value . . . . .	3-17	CLOCK2 Output Waveform . . . . .	8-2
Adjusting Clock Delay . . . . .	4-9	CLOCK2 Output, AC Connection Terminator . . . . .	4-6
Auxiliary Output Signals . . . . .	9-9	CLOCK2 Output, DC Connection Terminator . . . . .	4-6
Available Groups in Each Pattern Mode . . . . .	3-12	Combination of Patterns which Can Be Set . . . . .	3-4
	<b>[B]</b>	Command Program Message . . . . .	5-13
Basic Format . . . . .	5-9	Command Program Message (Remote Code) . . . . .	5-13
Basic Syntax of Program Message . . . . .	5-9	CONFIRMATION OF SPECIFICATION AND FUNCTION . . . . .	8-1
	<b>[C]</b>	Confirming 1/2 CLOCK output . . . . .	8-3
Before Using . . . . .	1-2	Confirming 1/32 CLK TRIGGER signal . . . . .	8-4
Binary mode setting format . . . . .	5-32	Confirming 1/4 RATE output . . . . .	8-8
	<b>[C]</b>	Confirming CLOCK output . . . . .	8-1
Calender/clock operation . . . . .	5-27	Confirming CLOCK1, <u>CLOCK1</u> outputs . . . . .	8-11
	<b>[C]</b>	Confirming CLOCK2 output . . . . .	8-2
Canceling Master/Slave Control Function . . . . .	5-8	Confirming DATA, DATA Outputs . . . . .	8-16
Checking the Appearance and Accessories . . . . .	1-2	Confirming Function . . . . .	8-21
Clock frequency setting . . . . .	5-13	Confirming PATTERN TRIGGER signal . . . . .	8-5
CLOCK Output Waveform . . . . .	8-2	Confirming the frequency . . . . .	8-22
CLOCK1 and <u>CLOCK1</u> Output, AC Connection . . . . .	4-5	Confirming the PRBS Pattern . . . . .	8-22
CLOCK1 and <u>CLOCK1</u> Output, DC Connection, - 2 V Termination, ECL Level . . . . .	4-5	Confirming the Word Pattern . . . . .	8-23
CLOCK1 and <u>CLOCK1</u> Output, DC Connection, 0 V Termination . . . . .	4-5	Connecting Clock Input . . . . .	4-1
		Connecting Signal Lines . . . . .	4-10
		Confirming Specification . . . . .	8-1
		Connections and Basic Setup of D3186 and D3286 . . . . .	8-21
		Connections of DC Blocking Capacitor . . . . .	8-15
		Control Input Signals . . . . .	9-10

D3186  
PULSE PATTERN GENERATOR  
OPERATION MANUAL

*Alphabetical Index*

<b>[D]</b>		<b>[G]</b>	
DATA and <u>DATA</u> Output and AC Connection . . . . .	4-3	General Specifications . . . . .	9-12
DATA and <u>DATA</u> Output, DC Connection, - 2 V Termination, and ECL Level . . . . .	4-3	GPIB . . . . .	5-1
DATA and <u>DATA</u> Output, DC Connection, and 0 V Termination . . . . .	4-3	GPIB and system setting . . . . .	5-28
DATA, <u>DATA</u> Output Waveform . . . . .	8-17 8-19 8-20	GPIB Specification . . . . .	5-51
Device Clear (SDC and DCL Commands) . . . . .	5-54	GPIB Specification . . . . .	5-3
DIP Switch SW1 Settings . . . . .	3-46	Grounding of Floating Device . . . . .	1-5
Displays Relating to Delay Lines . . . . .	7-5	Grounding of Measuring Instrument and Device to be Tested . . . . .	1-5
		<b>[H]</b>	
		Hex mode setting format . . . . .	5-31 5-34
		<b>[I]</b>	
<b>[E]</b>		Initial State . . . . .	5-55
ECL Termination Jig Connection . . . . .	8-13	Initial State of Operation . . . . .	5-55
External SG control code setting . . . . .	5-29 5-52	Initialization Program Message . . . . .	5-12
		Interface Functions . . . . .	5-4
<b>[F]</b>		<b>[L]</b>	
File Error Display . . . . .	7-3	List of Standard Accessories . . . . .	1-2
File Format . . . . .	6-2	Low Battery Display . . . . .	7-2
FILE FUNCTION . . . . .	6-1		
File Size . . . . .	6-2	<b>[M]</b>	
File/GPIB Control Section . . . . .	2-12 2-15	Main Input . . . . .	9-6
File/GPIB Control Section . . . . .	2-13	Maximum Available . . . . .	
File/GPIB operation section . . . . .	3-33	Number of Frames . . . . .	3-18
Filing . . . . .	5-26	Maximum Number of STM-N Frames which Can Be Set . . . . .	3-18
Floppy Disk Related Error Message . . . . .	7-3	MESSAGE DISPLAY . . . . .	7-1
Frame Pattern when Payload Type is CID . . . . .	3-8	MPU Error Display . . . . .	7-1
Frame Pattern when Payload Type is WORD or PRBS . . . . .	3-7	<b>[N]</b>	
Frequency Setting Section . . . . .	2-2 3-2	Notes on GPIB Usage . . . . .	5-6
Front Panel . . . . .	2-1		
Functional Specification . . . . .	5-3	<b>[O]</b>	
		Offset Setting Range . . . . .	3-29



D3186  
PULSE PATTERN GENERATOR  
OPERATION MANUAL

Alphabetical Index

OPERATION .....	3-1	<b>[Q]</b>	
Operation Clock .....	9-1		
Operation Condition Read .....	5-64	Query Program Message and Response	
Operation Condition Setup .....	5-61	Message .....	5-37
Operation of EXT ALT INPUT .....	3-48		5-38
Operation of EXT GATE INPUT .....	3-47	<b>[R]</b>	
Operation on the Front Panel .....	3-2		
Operation on the Panel .....	3-2	Rear Panel .....	2-17
Outline .....	6-1	Rear Panel .....	2-16
OUTLINE .....	1-1	Rear Panel Operation Method .....	3-45
Outline of GPIB .....	5-1		
	5-2	<b>[S]</b>	
Outline of Product .....	1-1		
Output setting .....	5-21	Service Request ("SRQ") Program	
	5-45	Message .....	5-12
Output Setting/Connector Section ...	2-8	Setting Clock Input .....	4-8
	2-9	Setting Clock Output .....	4-4
	2-11	Setting Data Input .....	4-8
	3-24	Setting Data Input Polarity .....	4-9
		Setting Data Output .....	4-2
		Setting Device Address .....	5-7
		Setting frame pattern .....	5-34
		Setting Range and Step of	
		Row Length .....	3-19
		Setting Range and Step of Overhead	
		Length .....	3-20
		Setting Range and Step of Pattern Length	
		of a Whole WORD Pattern .....	3-16
		Setting the D3186 .....	4-1
		Setting the D3286 .....	4-8
		Setting the initial state .....	3-44
		Setting the Pattern .....	4-7
			4-9
		Setting word pattern .....	5-31
		Setup .....	1-4
		Setup Parameter Initialization .....	5-55
		Signal Line Connections .....	4-11
		Signal Line Termination .....	5-3
		SPECIFICATIONS .....	9-1
		Status Byte .....	5-53
		Storage, Transportation and	
		Cleaning .....	1-6
<b>[P]</b>			
Pattern .....	9-2		
Pattern Display/Set Items .....	3-13		
Pattern setting .....	5-14		
	5-38		
Pattern Setting Section .....	2-4		
	2-5		
	2-7		
	3-4		
PATTERN TRIGGER Output			
Waveform .....	8-6		
	8-8		
Phase Relation of 1/4 RATE OUTPUT	3-49		
Pin Assignment of GPIB Connector ...	5-5		
Power Cable .....	1-4		
Power On .....	3-1		
PRBS Pattern Generating Function and			
Applicable Standard .....	3-5		
Precautions for Connecting the I/O Signal			
Lines .....	1-5		
Program Example .....	5-61		
Program Message (Listener Format) ..	5-9		

D3186  
PULSE PATTERN GENERATOR  
OPERATION MANUAL

Alphabetical Index

---

System Functions .....	9-11
SYSTEM OPERATION METHOD .....	4-1

**[V]**

Ventilation by the Cooling Fan .....	1-3
--------------------------------------	-----

**[W]**

What is Query Program Message? ...	5-37
WHEN YOU USE THE DEVICE FOR THE FIRST TIME .....	2-1
Word Pattern and Frame Pattern Settings .....	5-31
Word Pattern Setup (Binary mode) ...	5-70
Word Pattern Setup (Hex mode) .....	5-66
Working Environment .....	1-3

## **IMPORTANT INFORMATION FOR ADVANTEST SOFTWARE**

PLEASE READ CAREFULLY: This is an important notice for the software defined herein. Computer programs including any additions, modifications and updates thereof, operation manuals, and related materials provided by Advantest (hereafter referred to as "SOFTWARE"), included in or used with hardware produced by Advantest (hereafter referred to as "PRODUCTS").

### **SOFTWARE License**

All rights in and to the SOFTWARE (including, but not limited to, copyright) shall be and remain vested in Advantest. Advantest hereby grants you a license to use the SOFTWARE only on or with Advantest PRODUCTS.

### **Restrictions**

- (1) You may not use the SOFTWARE for any purpose other than for the use of the PRODUCTS.
- (2) You may not copy, modify, or change, all or any part of, the SOFTWARE without permission from Advantest.
- (3) You may not reverse engineer, de-compile, or disassemble, all or any part of, the SOFTWARE.

### **Liability**

Advantest shall have no liability (1) for any PRODUCT failures, which may arise out of any misuse (misuse is deemed to be use of the SOFTWARE for purposes other than its intended use) of the SOFTWARE. (2) For any dispute between you and any third party for any reason whatsoever including, but not limited to, infringement of intellectual property rights.

## LIMITED WARRANTY

1. Unless otherwise specifically agreed by Seller and Purchaser in writing, Advantest will warrant to the Purchaser that during the Warranty Period this Product (other than consumables included in the Product) will be free from defects in material and workmanship and shall conform to the specifications set forth in this Operation Manual.
2. The warranty period for the Product (the "Warranty Period") will be a period of one year commencing on the delivery date of the Product.
3. If the Product is found to be defective during the Warranty Period, Advantest will, at its option and in its sole and absolute discretion, either (a) repair the defective Product or part or component thereof or (b) replace the defective Product or part or component thereof, in either case at Advantest's sole cost and expense.
4. This limited warranty will not apply to defects or damage to the Product or any part or component thereof resulting from any of the following:
  - (a) any modifications, maintenance or repairs other than modifications, maintenance or repairs (i) performed by Advantest or (ii) specifically recommended or authorized by Advantest and performed in accordance with Advantest's instructions;
  - (b) any improper or inadequate handling, carriage or storage of the Product by the Purchaser or any third party (other than Advantest or its agents);
  - (c) use of the Product under operating conditions or environments different than those specified in the Operation Manual or recommended by Advantest, including, without limitation, (i) instances where the Product has been subjected to physical stress or electrical voltage exceeding the permissible range and (ii) instances where the corrosion of electrical circuits or other deterioration was accelerated by exposure to corrosive gases or dusty environments;
  - (d) use of the Product in connection with software, interfaces, products or parts other than software, interfaces, products or parts supplied or recommended by Advantest;
  - (e) incorporation in the Product of any parts or components (i) provided by Purchaser or (ii) provided by a third party at the request or direction of Purchaser or due to specifications or designs supplied by Purchaser (including, without limitation, any degradation in performance of such parts or components);
  - (f) Advantest's incorporation or use of any specifications or designs supplied by Purchaser;
  - (g) the occurrence of an event of force majeure, including, without limitation, fire, explosion, geological change, storm, flood, earthquake, tidal wave, lightning or act of war; or
  - (h) any negligent act or omission of the Purchaser or any third party other than Advantest.
5. **EXCEPT TO THE EXTENT EXPRESSLY PROVIDED HEREIN, ADVANTEST HEREBY EXPRESSLY DISCLAIMS, AND THE PURCHASER HEREBY WAIVES, ALL WARRANTIES, WHETHER EXPRESS OR IMPLIED, STATUTORY OR OTHERWISE, INCLUDING, WITHOUT LIMITATION, (A) ANY WARRANTY OF MERCHANTABILITY OR FITNESS FOR A PARTICULAR PURPOSE AND (B) ANY WARRANTY OR REPRESENTATION AS TO THE VALIDITY, SCOPE, EFFECTIVENESS OR USEFULNESS OF ANY TECHNOLOGY OR ANY INVENTION.**
6. **THE REMEDY SET FORTH HEREIN SHALL BE THE SOLE AND EXCLUSIVE REMEDY OF THE PURCHASER FOR BREACH OF WARRANTY WITH RESPECT TO THE PRODUCT.**
7. **ADVANTEST WILL NOT HAVE ANY LIABILITY TO THE PURCHASER FOR ANY INDIRECT, INCIDENTAL, SPECIAL, CONSEQUENTIAL OR PUNITIVE DAMAGES, INCLUDING, WITHOUT LIMITATION, LOSS OF ANTICIPATED PROFITS OR REVENUES, IN ANY AND ALL CIRCUMSTANCES, EVEN IF ADVANTEST HAS BEEN ADVISED OF THE POSSIBILITY OF SUCH DAMAGES AND WHETHER ARISING OUT OF BREACH OF CONTRACT, WARRANTY, TORT (INCLUDING, WITHOUT LIMITATION, NEGLIGENCE), STRICT LIABILITY, INDEMNITY, CONTRIBUTION OR OTHERWISE. TORT (INCLUDING, WITHOUT LIMITATION, NEGLIGENCE), STRICT LIABILITY, INDEMNITY, CONTRIBUTION OR OTHERWISE.**
8. **OTHER THAN THE REMEDY FOR THE BREACH OF WARRANTY SET FORTH HEREIN, ADVANTEST SHALL NOT BE LIABLE FOR, AND HEREBY DISCLAIMS TO THE FULLEST EXTENT PERMITTED BY LAW ANY LIABILITY FOR, DAMAGES FOR PRODUCT FAILURE OR DEFECT, WHETHER ARISING OUT OF BREACH OF CONTRACT, TORT (INCLUDING, WITHOUT LIMITATION, NEGLIGENCE), STRICT LIABILITY, INDEMNITY, CONTRIBUTION OR OTHERWISE.**

## **CUSTOMER SERVICE DESCRIPTION**

In order to maintain safe and trouble-free operation of the Product and to prevent the incurrence of unnecessary costs and expenses, Advantest recommends a regular preventive maintenance program under its maintenance agreement.

Advantest's maintenance agreement provides the Purchaser on-site and off-site maintenance, parts, maintenance machinery, regular inspections, and telephone support and will last a maximum of ten years from the date the delivery of the Product. For specific details of the services provided under the maintenance agreement, please contact the nearest Advantest office listed at the end of this Operation Manual or Advantest's sales representatives.

Some of the components and parts of this Product have a limited operating life (such as, electrical and mechanical parts, fan motors, unit power supply, etc.). Accordingly, these components and parts will have to be replaced on a periodic basis. If the operating life of a component or part has expired and such component or part has not been replaced, there is a possibility that the Product will not perform properly. Additionally, if the operating life of a component or part has expired and continued use of such component or part damages the Product, the Product may not be repairable. Please contact the nearest Advantest office listed at the end of this Operation Manual or Advantest's sales representatives to determine the operating life of a specific component or part, as the operating life may vary depending on various factors such as operating condition and usage environment.

## SALES & SUPPORT OFFICES

Advantest Korea Co., Ltd.

22BF, Kyobo KangNam Tower,  
1303-22, Seocho-Dong, Seocho-Ku, Seoul #137-070, Korea  
Phone: +82-2-532-7071  
Fax: +82-2-532-7132

Advantest (Suzhou) Co., Ltd.

Shanghai Branch Office:  
Bldg. 6D, NO.1188 Gumei Road, Shanghai, China 201102 P.R.C.  
Phone: +86-21-6485-2725  
Fax: +86-21-6485-2726

Shanghai Branch Office:  
406/F, Ying Building, Quantum Plaza, No. 23 Zhi Chun Road,  
Hai Dian District, Beijing,  
China 100083  
Phone: +86-10-8235-3377  
Fax: +86-10-8235-6717

Advantest (Singapore) Pte. Ltd.

438A Alexandra Road, #08-03/06  
Alexandra Technopark Singapore 119967  
Phone: +65-6274-3100  
Fax: +65-6274-4055

Advantest America, Inc.

3201 Scott Boulevard, Suite, Santa Clara, CA 95054, U.S.A  
Phone: +1-408-988-7700  
Fax: +1-408-987-0691

ROHDE & SCHWARZ Europe GmbH

Mühldorfstraße 15 D-81671 München, Germany  
(P.O.B. 80 14 60 D-81614 München, Germany)  
Phone: +49-89-4129-13711  
Fax: +49-89-4129-13723

**ADVANTEST®**

<http://www.advantest.co.jp>