

---

---

**ADVANTEST**<sup>®</sup>  
ADVANTEST CORPORATION

---

---

**Q73321/M**

***Optical Spectral Line Width Test Set***

***Operation Manual***

MANUAL NUMBER FOE-8324227C01

---

***Applicable System***  
**Q7332**



---

## Safety Summary

To ensure thorough understanding of all functions and to ensure efficient use of this instrument, please read the manual carefully before using. Note that Advantest bears absolutely no responsibility for the result of operations caused due to incorrect or inappropriate use of this instrument.

If the equipment is used in a manner not specified by Advantest, the protection provided by the equipment may be impaired.

- **Warning Labels**

Warning labels are applied to Advantest products in locations where specific dangers exist. Pay careful attention to these labels during handling. Do not remove or tear these labels. If you have any questions regarding warning labels, please ask your nearest Advantest dealer. Our address and phone number are listed at the end of this manual.

Symbols of those warning labels are shown below together with their meaning.

**DANGER:** Indicates an imminently hazardous situation which will result in death or serious personal injury.

**WARNING:** Indicates a potentially hazardous situation which will result in death or serious personal injury.

**CAUTION:** Indicates a potentially hazardous situation which will result in personal injury or a damage to property including the product.

- **Basic Precautions**

Please observe the following precautions to prevent fire, burn, electric shock, and personal injury.

- Use a power cable rated for the voltage in question. Be sure however to use a power cable conforming to safety standards of your nation when using a product overseas.
- When inserting the plug into the electrical outlet, first turn the power switch OFF and then insert the plug as far as it will go.
- When removing the plug from the electrical outlet, first turn the power switch OFF and then pull it out by gripping the plug. Do not pull on the power cable itself. Make sure your hands are dry at this time.
- Before turning on the power, be sure to check that the supply voltage matches the voltage requirements of the instrument.
- Connect the power cable to a power outlet that is connected to a protected ground terminal. Grounding will be defeated if you use an extension cord which does not include a protected ground terminal.
- Be sure to use fuses rated for the voltage in question.
- Do not use this instrument with the case open.
- Do not place anything on the product and do not apply excessive pressure to the product. Also, do not place flower pots or other containers containing liquid such as chemicals near this

---

## Safety Summary

product.

- When the product has ventilation outlets, do not stick or drop metal or easily flammable objects into the ventilation outlets.
- When using the product on a cart, fix it with belts to avoid its drop.
- When connecting the product to peripheral equipment, turn the power off.

- **Caution Symbols Used Within this Manual**

Symbols indicating items requiring caution which are used in this manual are shown below together with their meaning.

**DANGER:** Indicates an item where there is a danger of serious personal injury (death or serious injury).

**WARNING:** Indicates an item relating to personal safety or health.

**CAUTION:** Indicates an item relating to possible damage to the product or instrument or relating to a restriction on operation.

- **Safety Marks on the Product**

The following safety marks can be found on Advantest products.



: ATTENTION - Refer to manual.



: Protective ground (earth) terminal.



: DANGER - High voltage.



: CAUTION - Risk of electric shock.

- **Replacing Parts with Limited Life**

The following parts used in the instrument are main parts with limited life.

Replace the parts listed below before their expected lifespan has expired to maintain the performance and function of the instrument.

Note that the estimated lifespan for the parts listed below may be shortened by factors such as the environment where the instrument is stored or used, and how often the instrument is used. The parts inside are not user-replaceable. For a part replacement, please contact the Advantest sales office for servicing.

Each product may use parts with limited life.

For more information, refer to the section in this document where the parts with limited life are described.

## Main Parts with Limited Life

Part name	Life
Unit power supply	5 years
Fan motor	5 years
Electrolytic capacitor	5 years
LCD display	6 years
LCD backlight	2.5 years
Floppy disk drive	5 years
Memory backup battery	5 years

- **Hard Disk Mounted Products**

The operational warnings are listed below.

- Do not move, shock and vibrate the product while the power is turned on.  
Reading or writing data in the hard disk unit is performed with the memory disk turning at a high speed. It is a very delicate process.
- Store and operate the products under the following environmental conditions.  
An area with no sudden temperature changes.  
An area away from shock or vibrations.  
An area free from moisture, dirt, or dust.  
An area away from magnets or an instrument which generates a magnetic field.
- Make back-ups of important data.  
The data stored in the disk may become damaged if the product is mishandled. The hard disc has a limited life span which depends on the operational conditions. Note that there is no guarantee for any loss of data.

- **Precautions when Disposing of this Instrument**

When disposing of harmful substances, be sure dispose of them properly with abiding by the state-provided law.

Harmful substances: (1) PCB (polycarbon biphenyl)  
(2) Mercury  
(3) Ni-Cd (nickel cadmium)  
(4) Other

Items possessing cyan, organic phosphorous and hexadic chromium and items which may leak cadmium or arsenic (excluding lead in solder).

Example: fluorescent tubes, batteries

# Environmental Conditions

This instrument should only be used in an area which satisfies the following conditions:

- An area free from corrosive gas
- An area away from direct sunlight
- A dust-free area
- An area free from vibrations
- Altitude of up to 2000 m

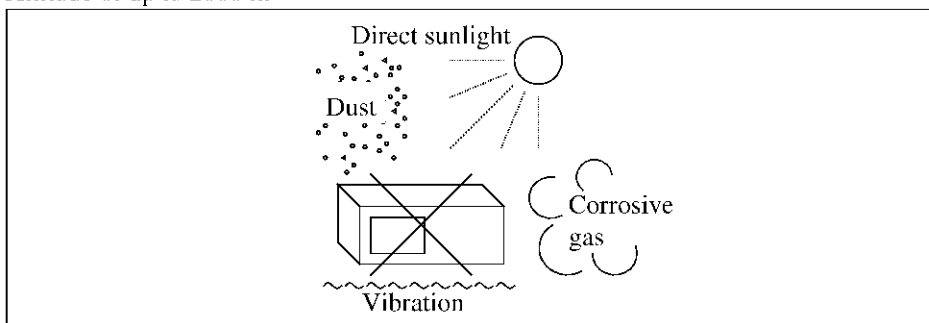

**Figure-1 Environmental Conditions**

- Operating position

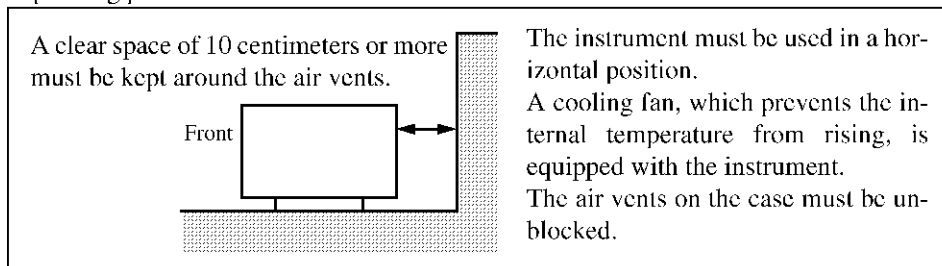

**Figure-2 Operating Position**

- Storage position

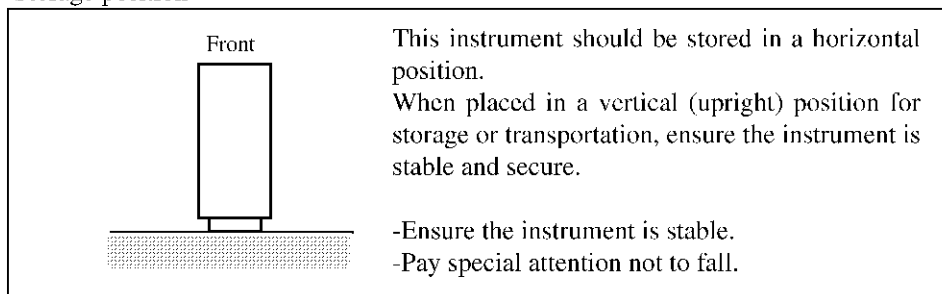

**Figure-3 Storage Position**



- The classification of the transient over-voltage, which exists typically in the main power supply, and the pollution degree is defined by IEC61010-1 and described below.

Impulse withstand voltage (over-voltage) category II defined by IEC60364-4-443

Pollution Degree 2

## Types of Power Cable

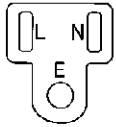
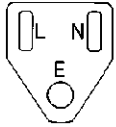
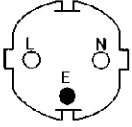
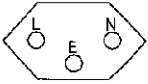
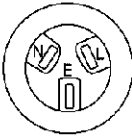
Replace any references to the power cable type, according to the following table, with the appropriate power cable type for your country.

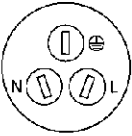
Plug configuration	Standards	Rating, color and length	Model number (Option number)
	PSE: Japan Electrical Appliance and Material Safety Law	125 V at 7 A Black 2 m (6 ft)	Straight: A01402 Angled: A01412
	UL: United States of America CSA: Canada	125 V at 7 A Black 2 m (6 ft)	Straight: A01403 (Option 95) Angled: A01413
	CEE: Europe DEMKO: Denmark NEMKO: Norway VDE: Germany KEMA: The Netherlands CEBEC: Belgium OVE: Austria FIMKO: Finland SEMKO: Sweden	250 V at 6 A Gray 2 m (6 ft)	Straight: A01404 (Option 96) Angled: A01414
	SEV: Switzerland	250 V at 6 A Gray 2 m (6 ft)	Straight: A01405 (Option 97) Angled: A01415
	SAA: Australia, New Zealand	250 V at 6 A Gray 2 m (6 ft)	Straight: A01406 (Option 98) Angled: -----
	BS: United Kingdom	250 V at 6 A Black 2 m (6 ft)	Straight: A01407 (Option 99) Angled: A01417
	CCC: China	250 V at 10 A Black 2 m (6 ft)	Straight: A114009 (Option 94) Angled: A114109





Q73321  
OPTICAL SPECTRAL LINE WIDTH TEST SET  
INSTRUCTION MANUAL

Table of Contents

---

TABLE OF CONTENTS

1. GENERAL .....	1 - 1
1.1 Outline .....	1 - 1
1.2 Features of the Q73321 and Q7332 .....	1 - 3
1.3 Preparation Before Operation and General Requirements .....	1 - 4
1.3.1 Check of appearance and accessories .....	1 - 4
1.3.2 Precautions .....	1 - 4
1.4 Replacement of Fuse .....	1 - 6
1.5 Cleaning the Optical Input (Output) Connector .....	1 - 7
2. HOW TO USE THE TEST SET .....	2 - 1
2.1 Description of the Panels .....	2 - 1
2.2 Basic Operation .....	2 - 5
2.3 How to connect the external delay fiber .....	2 - 8
3. DESCRIPTION OF OPERATIONS .....	3 - 1
3.1 Operations of the Q73321 Optical Measurement Device .....	3 - 1
3.2 Operations of Q7332 .....	3 - 2
3.3 Principle of Optical Measurement with the Q73321 .....	3 - 3
4. PERFORMANCE .....	4 - 1
4.1 Specifications of the Q73321 .....	4 - 1
4.2 Main Specifications of the Q7332 .....	4 - 3



Q73321  
OPTICAL SPECTRAL LINE WIDTH TEST SET  
INSTRUCTION MANUAL

List of Figures

---

LIST OF FIGURES

No.	Title	Page
1 - 1	Q73321 optical spectral line width test set .....	1 - 1
1 - 2	Q7332 optical spectral line width measurement system .....	1 - 2
1 - 3	Power cable .....	1 - 5
1 - 4	Replacement of the power fuse .....	1 - 6
1 - 5	Cleaning the optical connector	1 - 7
2 - 1	Front panel .....	2 - 1
2 - 2	Delayed self heterodyne system	2 - 3
2 - 3	Rear panel .....	2 - 4
3 - 1	Block diagram of measurement by Q73321 optical measurement device .....	3 - 1



Q73321  
OPTICAL SPECTRAL LINE WIDTH TEST SET  
INSTRUCTION MANUAL

List of Tables

LIST OF TABLES

<u>No.</u>	<u>Title</u>	<u>Page</u>
1 - 1	Standard accessories .....	1 - 4



Q73321  
OPTICAL SPECTRAL LINE WIDTH TEST SET  
INSTRUCTION MANUAL

1.1 Outline

1. GENERAL

1.1 Outline

- (1) The Q73321 optical spectral line width test set (see Figure 1 - 1) measures the spectrum distribution of a 1.55  $\mu\text{m}$  range distribution feedback type (DFB) laser. (The Q73321M test set also supports the 1.3  $\mu\text{m}$  range.)

The test set is based on the principle of the delayed self heterodyne method, developed by the electronics department, faculty of technology, of Tokyo University. Spectrum distribution of the source light is converted into an electric signal in the equipment, and is output from the output connector (BNC connector/50  $\Omega$ ). This signal can be observed on the CRT display by connecting the RF spectrum analyzer (specifically, the R4131D analyzer/indicator for the Q7332 measurement system).

A single mode delay optical fiber with a length of approx. 5 km is provided with the equipment. An optical fiber polarization controller is also provided, to adjust the conditions of the polarization planes being observed on the level meter.

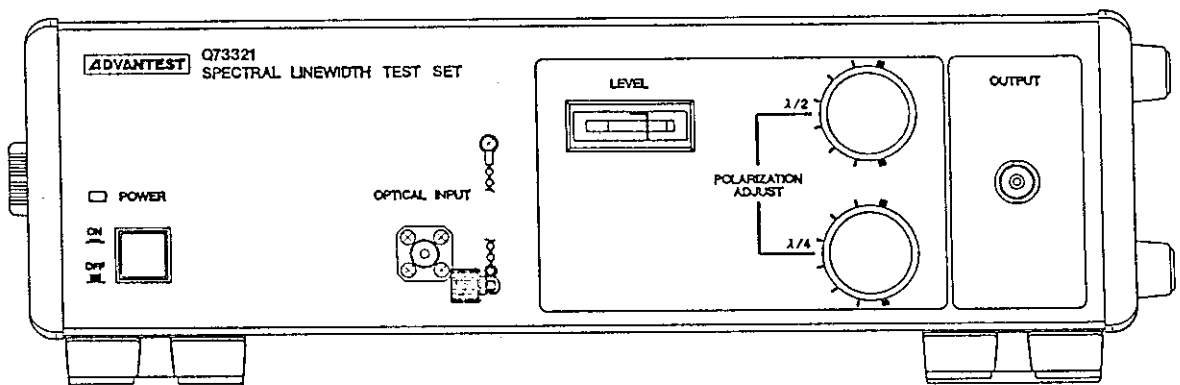

Figure 1 - 1 Q73321 optical spectral line width test set

- \*.. T. Okoshi, K. Kikuchi, and A. Nakayama:  
'Novel method for high resolution measurement of laser output spectrum', Electronic letters, 31st July 1980. Vol.16 No.16 p. 630 to 631

Q73321  
OPTICAL SPECTRAL LINE WIDTH TEST SET  
INSTRUCTION MANUAL

1.1 Outline

- (2) The Q7332/M optical spectral line width measurement system consists of the Q73321/M optical measurement device and the R4131D analyzer/indicator. The measurement system measures spectrum distribution of a DFB laser. (See Figure 1 - 2.)

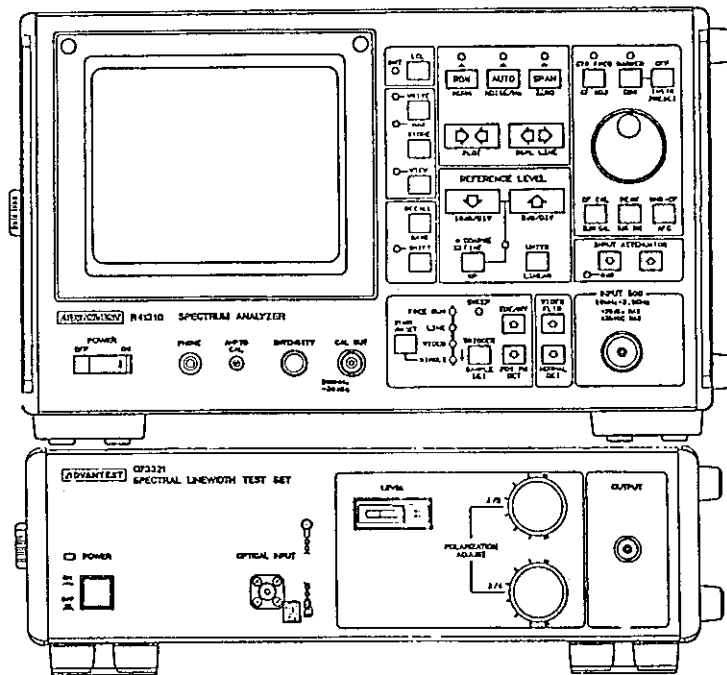

Figure 1 - 2 Q7332 optical spectral line width measurement system



Q73321  
OPTICAL SPECTRAL LINE WIDTH TEST SET  
INSTRUCTION MANUAL

1.2 Features of the Q73321 and Q7332

---

1.2 Features of the Q73321 and Q7332

(1) Features of the Q73321

① Adoption of the delayed self heterodyne method

The use of the delayed self heterodyne method enables high resolution measurement of asymmetric spectrum distribution of source light.

② Minimum measurable spectral line width (resolution) is 20 kHz (FWHM)

The incorporated delay optical fiber (5 km long) enables measurement of source light with a minimum measurement spectral line width of 20 kHz (FWHM)

③ Built-in polarization controller

The polarization controller is provided to control the polarization planes in the equipment for optimum measurement.

④ Wide input range

The Q73321 measurement device supports a wide range of input light intensities of +10 to -35 dBm.

(2) Features of the Q7332 optical spectral line width measurement system

The measurement system consists of the Q73321 measurement device and the R4131D analyzer/indicator, and features the following facilities:

① FWHM read out facility (option)

The full width at half maximum of the measured spectrum can be read directly on the R4131D indicator. (option 14 of R4131D)

② Save/Recall facility

Measurement data can be readily compared with measurement conditions and measured waveforms stored in memory.

Q73321  
OPTICAL SPECTRAL LINE WIDTH TEST SET  
INSTRUCTION MANUAL

1.3 Preparation Before Operation and General Requirements

1.3 Preparation Before Operation and General Requirements

1.3.1 Check of appearance and accessories

On the delivery of the equipment, check if any damage has occurred during transport. Then check the standard accessories and their specifications according to Table 1 - 1.

If any damage or storage of parts is found, contact our CE headquarters (in Yokohama CE Center), or the nearest sales office, or agency. The addresses and phone numbers are given on the last page.

Table 1 - 1 Standard accessories

Product name	Type name	Stock No.	Q'ty	Remarks
Power cable	MP-43B	DCB-DD2428X01-1	1	
Fuses	EAWK0.8A	DFT-AAR8A	2	
Instruction Manual	-	J Q73321	1	Japanese version
	-	E Q73321		English version

Note: Use the type number or stock No. to specify accessories to order additional accessories.

1.3.2 Precautions

(1) Grounding

To prevent electric shock, connect the center pin of the power connector of Q73321 to ground.

The attached power cable has a 3-pin connector with a round grounding pin in the middle. The test set is grounded when the connector is plugged into a triple pole receptacle. If a triple pole receptacle is not available, use a triple-to-double converting adapter (A09034) and be sure to connect the grounding wire led out from the adapter (see Figure 1 - 3a) to ground.

Q73321  
OPTICAL SPECTRAL LINE WIDTH TEST SET  
INSTRUCTION MANUAL

1.3 Preparation Before Operation and General Requirements

The A09034 adapter has two electrodes of different widths (see Figure 1 - 3b). Match the widths of the electrodes and the slots of the receptacle. If the A09034 adapter cannot be used because the available receptacle has slots of the same width, use a separately provided KPR-13 adapter and connect the grounding pin on the rear panel of the test set to ground.

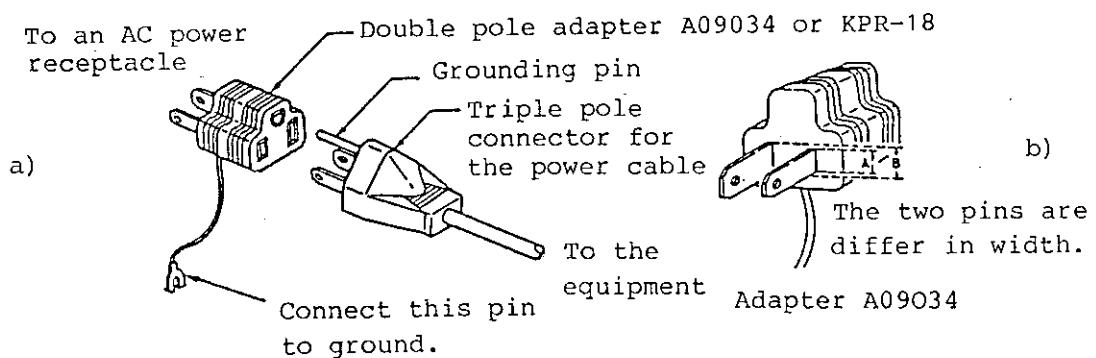

Figure 1 - 3 Power cable

- (2) 90 to 250 V at 48 to 66 Hz AC power supply is required. Do not use power cables other than the special cable provided. The power switch must be turned off before connecting the power cable.
- (3) The operating ambient conditions are 0 to +40°C, and an RH of 85% or less. The equipment must not be exposed to direct sunlight, and should be placed well-ventilated room.
- (4) The equipment must be handled with care and must be prevented from excess mechanical shock.
- (5) Storage

If it is expected that the Q73321 test set will not be used for a long period, wrap it in a vinyl sheet, etc., place in a carton, and store in a dry and shaded location.

The temperature must be kept at 0 to 40°C during storage.

Q73321  
OPTICAL SPECTRAL LINE WIDTH TEST SET  
INSTRUCTION MANUAL

1.4 Replacement of Fuse

1.4 Replacement of Fuse

If the equipment fails to operate with the power switch is turned on, the power fuse has probably blown. If this is the case, replace the fuse.

The specification of the power AC line fuse is 0.8A/250 V at input voltage of 90 to 250 V.

[Replacement Procedures]

To replace the fuse, turn off the power switch and disconnect the power cable from the power connector.

To remove the fuse for replacement, turn the fuse holder cap counter clockwise.

(Rear panel)

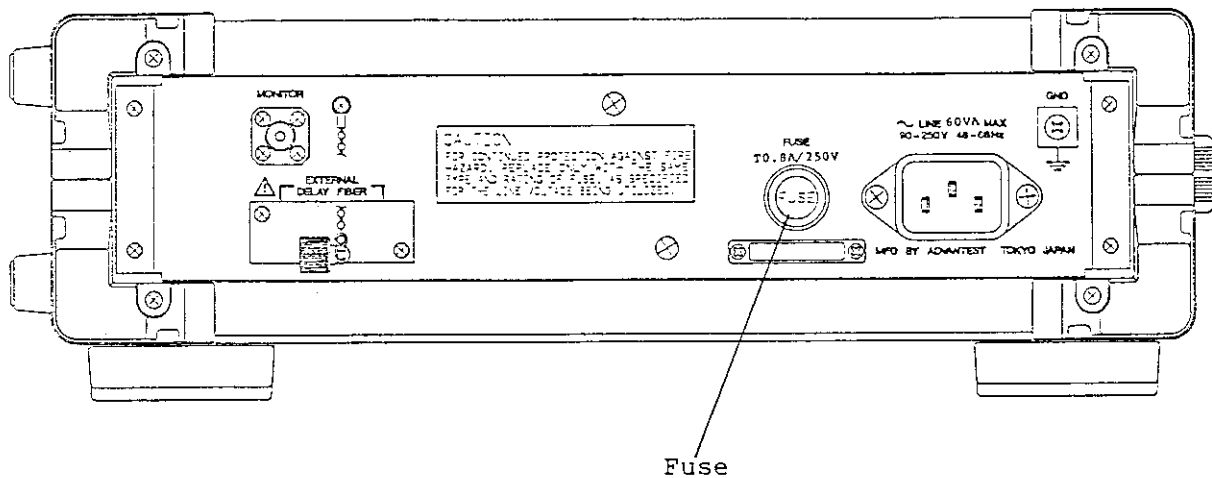

Figure 1 - 4 Replacement of the Power Fuse

Q73321  
OPTICAL SPECTRAL LINE WIDTH TEST SET  
INSTRUCTION MANUAL

1.5 Cleaning the Optical Input (Output) Connector

---

1.5 Cleaning the Optical Input (Output) Connector

Figure 1 - 5 shows how to clean the optical input (output) connector. Remove two of the screws on the four corners of the adaptor. The FC connector can then be drawn out.

Remove the adaptor and gently wipe the tip and side of the connector ferrule with lens cleaning paper or sanitary gauze soaked in alcohol.

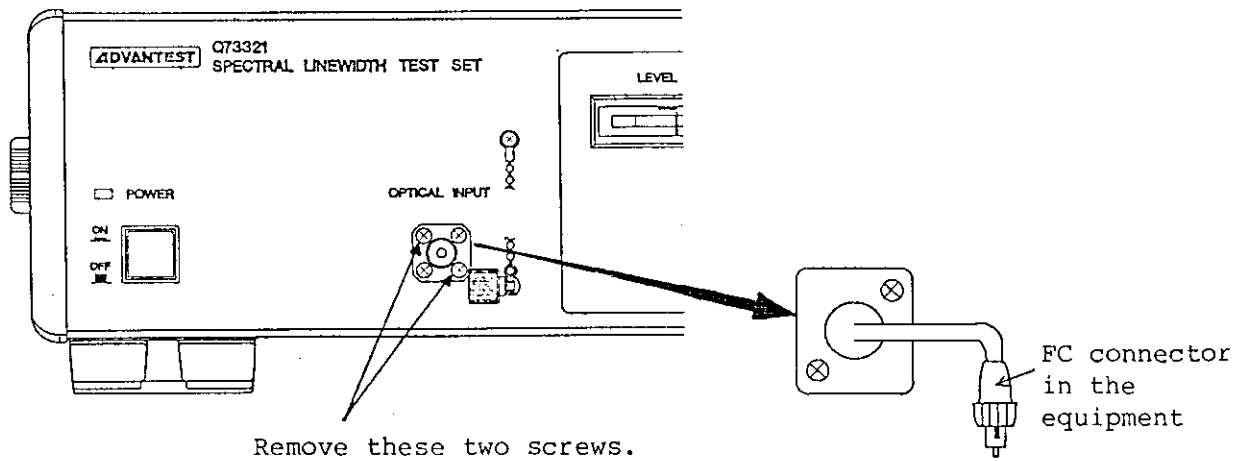

Figure 1 - 5 Cleaning the optical connector



Q73321  
OPTICAL SPECTRAL LINE WIDTH TEST SET  
INSTRUCTION MANUAL

2.1 Description of the Panels

2. HOW TO USE THE TEST SET

2.1 Description of the Panels

Figure 2 - 1 shows the front and rear panels of the Q73321 test set. Functions of each feature is explained in the following pages, in the order of the numbers in the figure.

(1) Front panel

① Power switch

The switch turns the power alternately on or off each time it is pressed.

② Power indicator

The power indicator comes on when the power is on.

③ Optical input connector

The source light is input through this connector. An FC connector is incorporated in the equipment. The end face is PC-finished.

④ Dummy cap

The dummy cap is used to cover the optical input connector when it is not in use, to prevent dust from entering the connector.

⑤ Level meter

The level meter is used to adjust the polarization planes using the polarization controller. Adjustment can be performed more easily by observing the level meter.

⑥ Polarization control knob

The polarization controller is provided with two adjustment knobs. The upper is for  $\lambda/2$  and the lower is for  $\lambda/4$ . Use them to optimize the polarization plane in the equipment.

⑦ RF output connector (BNC connector)

The RF output connector converts the optical signal obtained by the delayed self heterodyne system into an electric signal and outputs it. The output impedance is 50  $\Omega$ .

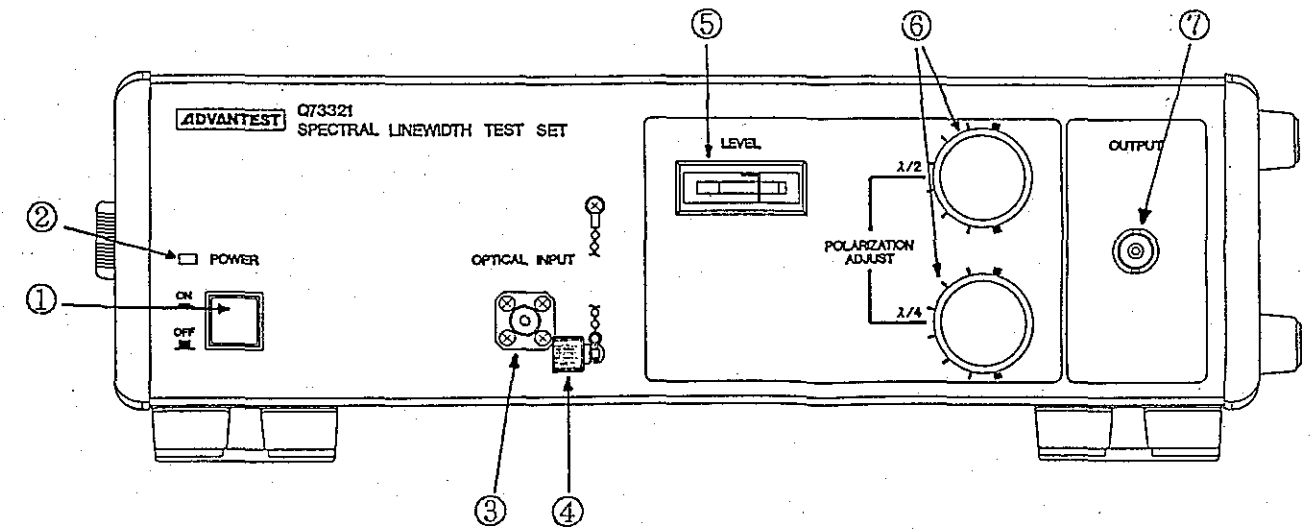

Figure 2 - 1 Front panel





Q73321  
OPTICAL SPECTRAL LINE WIDTH TEST SET  
INSTRUCTION MANUAL

2.1 Description of the Panels

---

(2) Rear panel

⑧ Monitoring light output connector

The optical signal obtained from the delayed self heterodyne system is output to this connector. The connector is the FC type, and the end face is PC-finished.

⑨ Dummy cap

The dummy cap is used to cover the monitoring light output connector when it is not in use, to prevent dust from entering.

⑩ External delay fiber take-up (option)

This take-up is used to modify the length of the delay optical fiber cable in the equipment to change the minimum measurable spectral line width.

The use of the optional external delay fiber take-up enables changes in the delayed self heterodyne system as shown in Figure 2 - 2.

The addition of the external delay optical fiber changes the minimum measurable spectral line width ( $\Delta f$ ) as expressed in the formula:

$$\Delta f = \frac{1.5}{\pi \cdot (25 \mu \text{ sec} + \tau d)}$$

Where,

$\Delta f$  : Full width at half maximum (FWHM)  
 $\tau d$  : Delay time obtained by the external delay optical fiber  
25  $\mu$ sec : The delay time of the internal optical fiber  
1.5 : coefficient

Q73321  
 OPTICAL SPECTRAL LINE WIDTH TEST SET  
 INSTRUCTION MANUAL

2.1 Description of the Panels

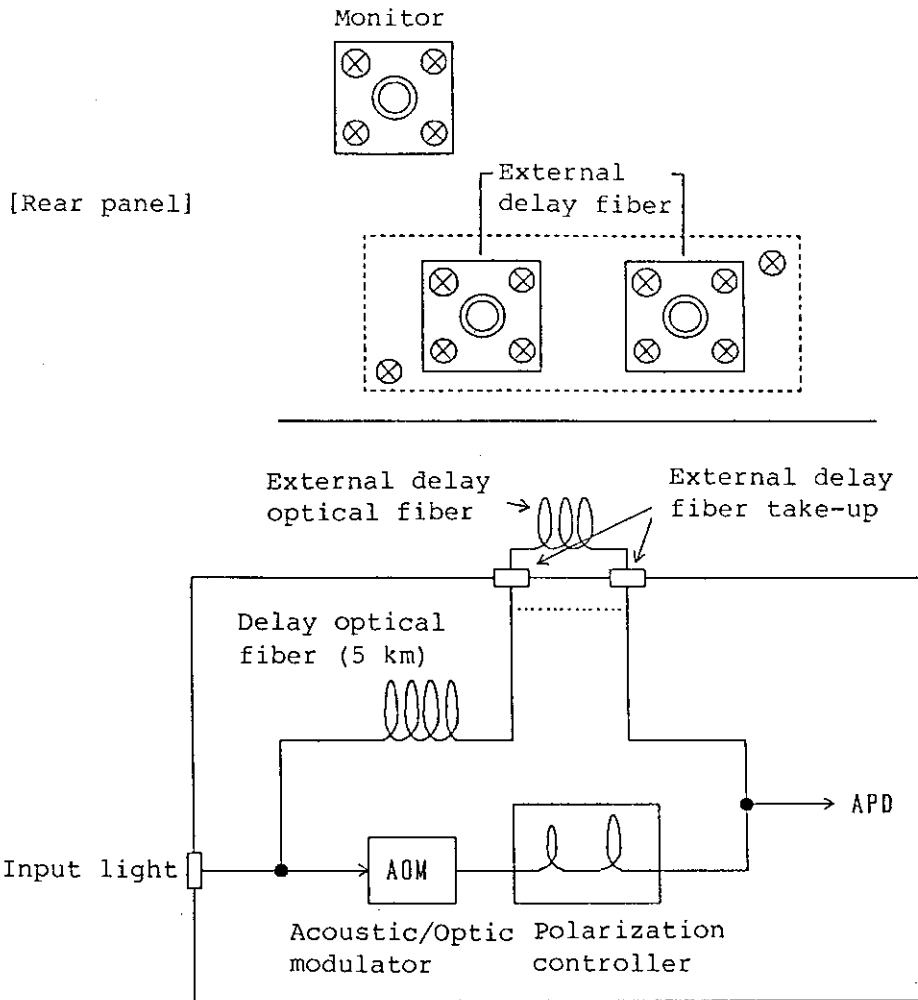

Figure 2 - 2 Delayed self heterodyne system



Q73321  
OPTICAL SPECTRAL LINE WIDTH TEST SET  
INSTRUCTION MANUAL

2.1 Description of the Panels

⑪ Power connector

This is the AC power connector. Connect it to the attached power cable.

⑫ Ground pin

This pin is used to ground the chassis of the Q73321 test set.

This ground pin is used when the power cable is connected to a two-pole receptacle with a triple-to-double converting adaptor. The ground wire led out from the adaptor may be connected to ground instead of the ground pin.

⑬ Serial nameplate

The serial nameplate gives the lot number of the Q73321 test set.

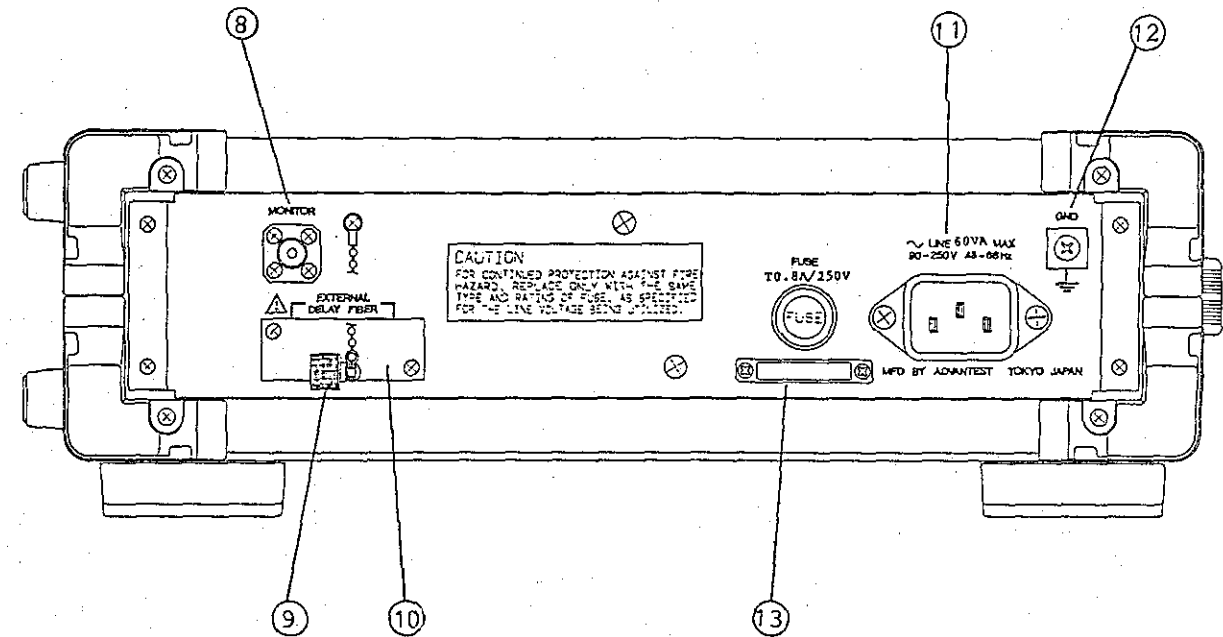

Figure 2 - 3 Rear panel

Q73321  
OPTICAL SPECTRAL LINE WIDTH TEST SET  
INSTRUCTION MANUAL

2.2 Basic Operation

2.2 Basic Operation

[Operation Procedures]

- (1) Be sure the power switch is turned off before connecting the power cable.
- (2) Turn on the power switch.
- (3) Connect the Q73321 test set output connector (⑦ on the front panel) and the RF spectrum analyzer input connector with a cable (of impedance of 50 Ω).
- (4) Set the measurement conditions for the RF spectrum analyzer.

[Example of spectrum analyzer setting]

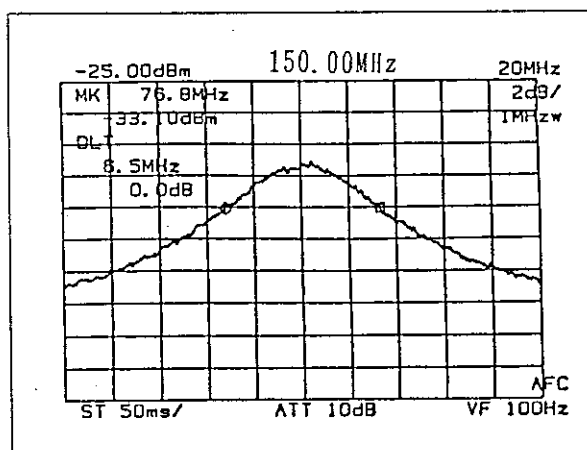

- |                               |                                 |
|-------------------------------|---------------------------------|
| Center frequency              | : 150 MHz (175 MHz for Q73321M) |
| Frequency span (x-axis scale) | : 20 MHz                        |
| Reference level               | : -25 dBm                       |
| Resolution                    | : 1 MHz                         |
| Y-axis scale                  | : 2 dB/div.                     |
| Video filter                  | : 100 Hz                        |

- (5) Connect the source light to the optical input connector (③ on the front panel) with the single mode fiber.

Q73321  
OPTICAL SPECTRAL LINE WIDTH TEST SET  
INSTRUCTION MANUAL

2.2 Basic Operation

- (6) Before measurement of the spectral line width, adjust the polarization plane in the Q7332. Turn the polarization control knobs  $\lambda/2$  and  $\lambda/4$  (⑥ on the front panel), observing the waveform displayed on the spectrum analyzer CRT, or the Q73321 level meter (⑤ on the front panel):
- (a) Adjust the knobs so that the Q73321 level meter (⑤ on the front panel) indicates the maximum.
- (b) Adjust the knobs so that the amplitude of the waveform displayed on the CRT of the spectrum analyzer reaches the maximum.
- (7) An example of measurement of spectral line width is shown below: (RF spectrum analyzer is R4131D option 14)

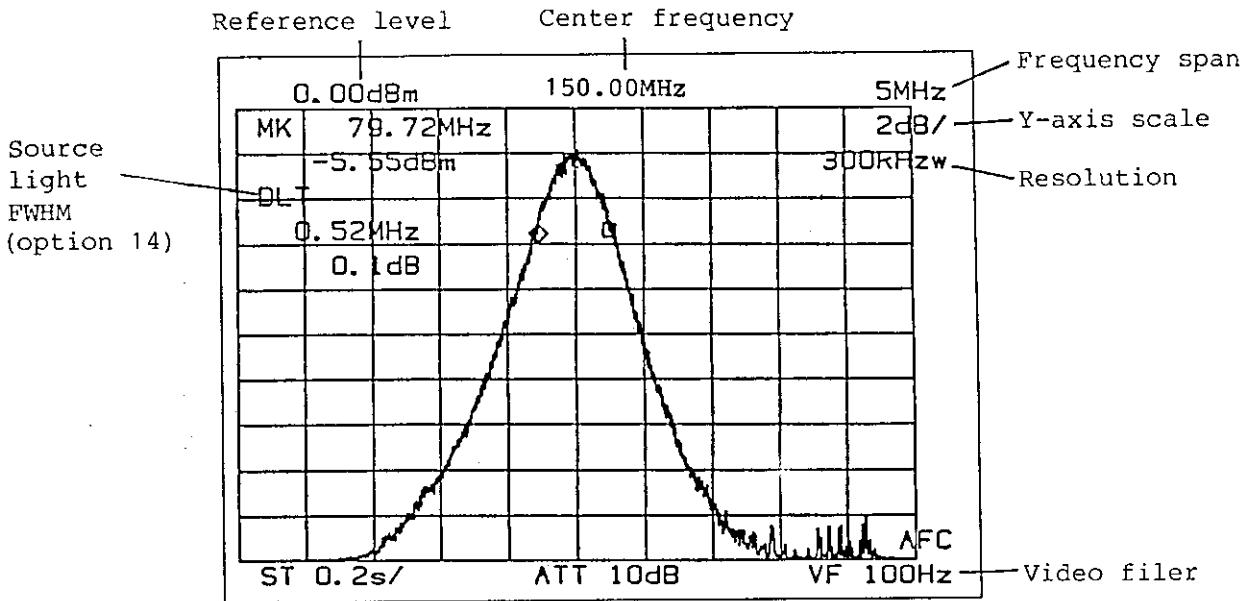

- (8) How to read out the FWHM with the RF spectrum analyzer R4131D
- ① Press the shift and marker keys in this order. The menu screen will be displayed on the R4131D CRT as shown below.

```



#  OBW
   3dB DOWN
   3dB DOWN Loop
   NEXT PEAK

QUIT : OFF
  
```

Q73321  
OPTICAL SPECTRAL LINE WIDTH TEST SET  
INSTRUCTION MANUAL

2.2 Basic Operation

---

- ② To acquire the FWHM, select one of the following two menu items by pressing the reference level keys  or .

3 dB down : FWHM is measured once.

3 dB down loop : FWHM is measured at every sweep of the spectrum analyzer.

- ③ After selecting the menu item, press the marker key again and the requested FWHM value will be indicated on the left end of the CRT display, replacing the above menu display.

DLT XXXMHz 0.0dB
------------------------

- ④ To clear the display of the FWHM value, press the marker off key.
- (9) To terminate the measurement, turn off the power switch.

Q73321  
OPTICAL SPECTRAL LINE WIDTH TEST SET  
INSTRUCTION MANUAL

2.3 How to connect the external delay fiber

2.3 How to connect the external delay fiber

- (1) Detaches two screws (M4) fixing the rear foot B.

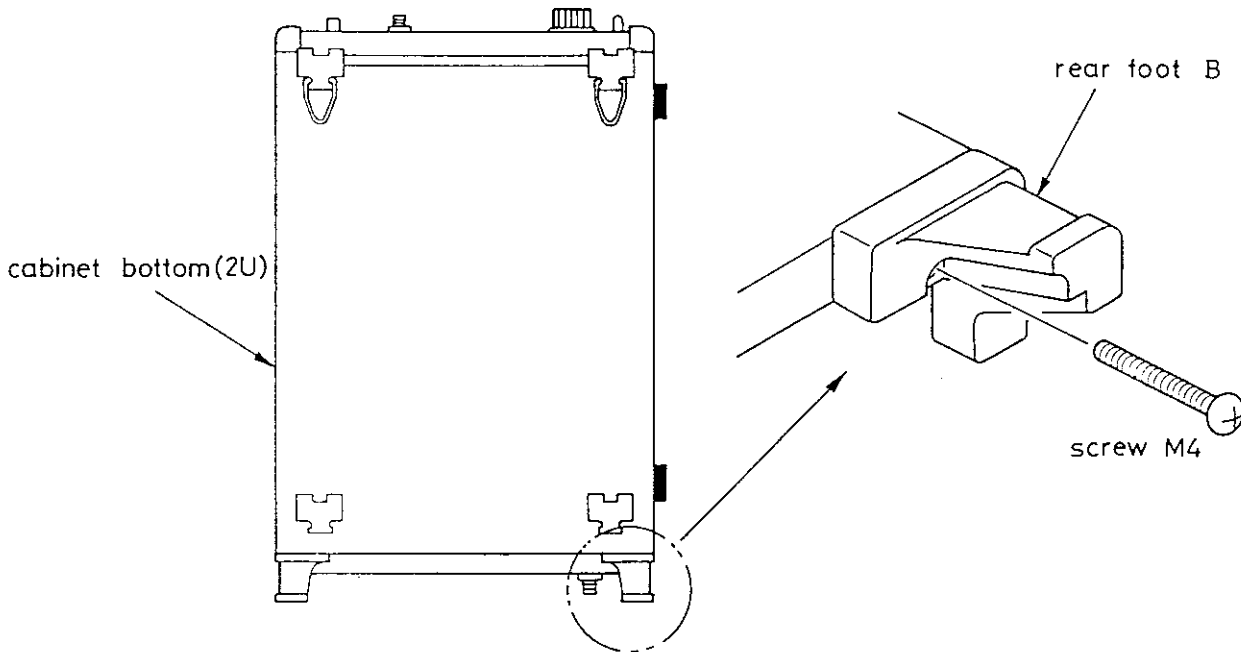

- (2) Detaches the cabinet bottom.

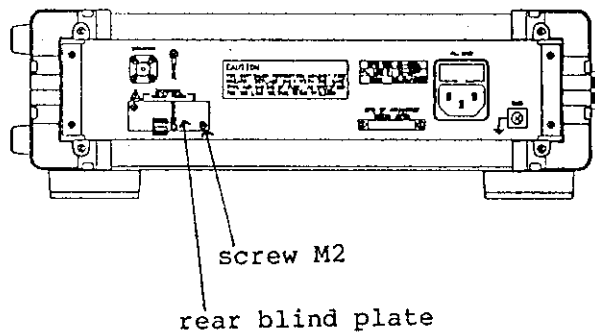

- (3) Detaches two screws (M2) fixing the rear blind plate.

- (4) Provides an adaptor (OD-9384 made by NEC).

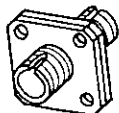



Q73321  
OPTICAL SPECTRAL LINE WIDTH TEST SET  
INSTRUCTION MANUAL

2.3 How to connect the external delay fiber

- (5) Detaches the No.1 cable and 5km fiber cable from the adaptor fixed to the bottom. Sets as the following figure (Fixes fast in the connector part).

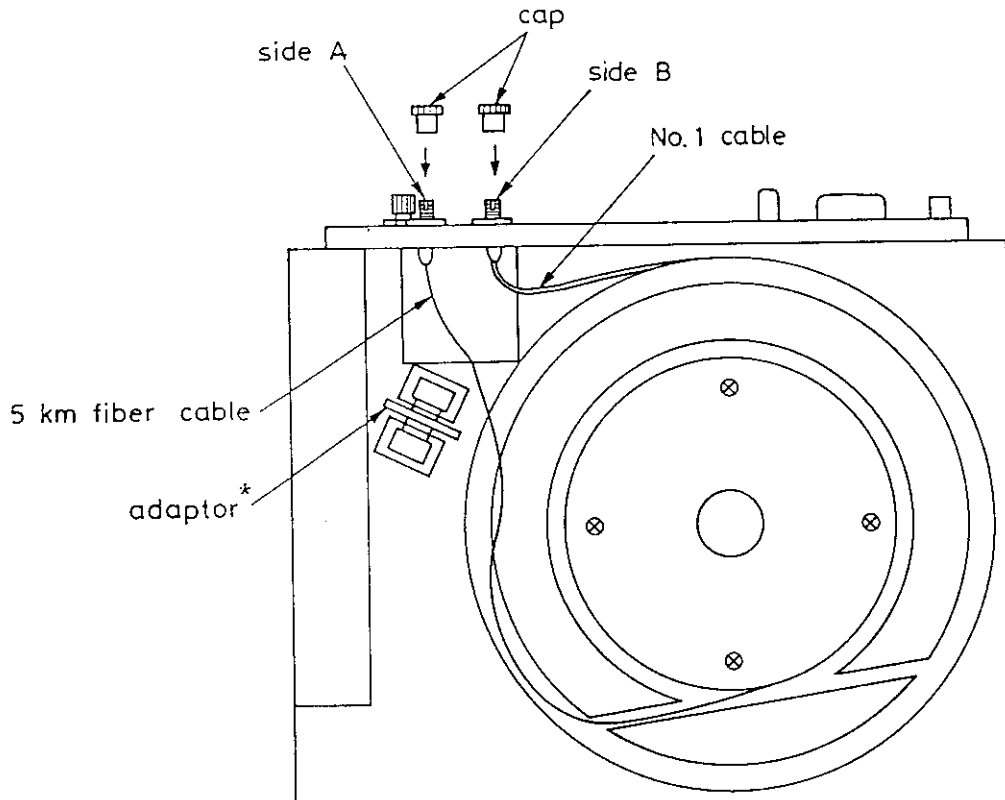

\* Detaches the adaptor and uses in procedure (6).

- (6) Sets two adaptors (OD-9384 made by NEC) on the rear panel. One is the provided in procedure (4) and another is the detached in the previous step.

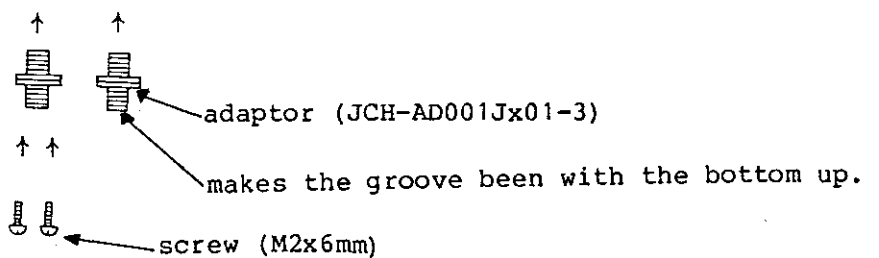
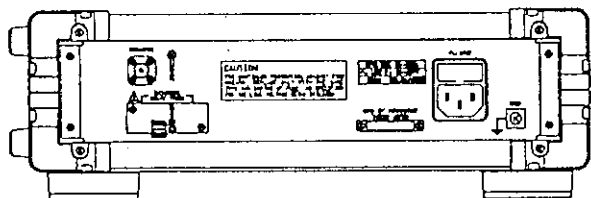

- (7) Sets the bottom cover to complete.



Q73321  
OPTICAL SPECTRAL LINE WIDTH TEST SET  
INSTRUCTION MANUAL

3.1 Operations of the Q73321 Optical Measurement Device

3. DESCRIPTION OF OPERATIONS

3.1 Operations of the Q73321 Optical Measurement Device

The structure of the Q73321 optical measurement device is based on delayed self heterodyne method, as shown in Figure 3 - 1 Measurement device diagram.

The frequency shift by the acoustic/optic modulator reaches 150 MHz/175MHz. The incorporated single mode optical fiber (approx. 5 km long) allows a minimum measurable spectral line width of 20 kHz (FWHM).

The polarization controller is also provided to match the polarization planes obtained via path 1 and path 2, with the aid of the level meter for easier adjustment. The heterodyned output light is photoelectrically transferred and amplified at APD, and is output from the RF output.

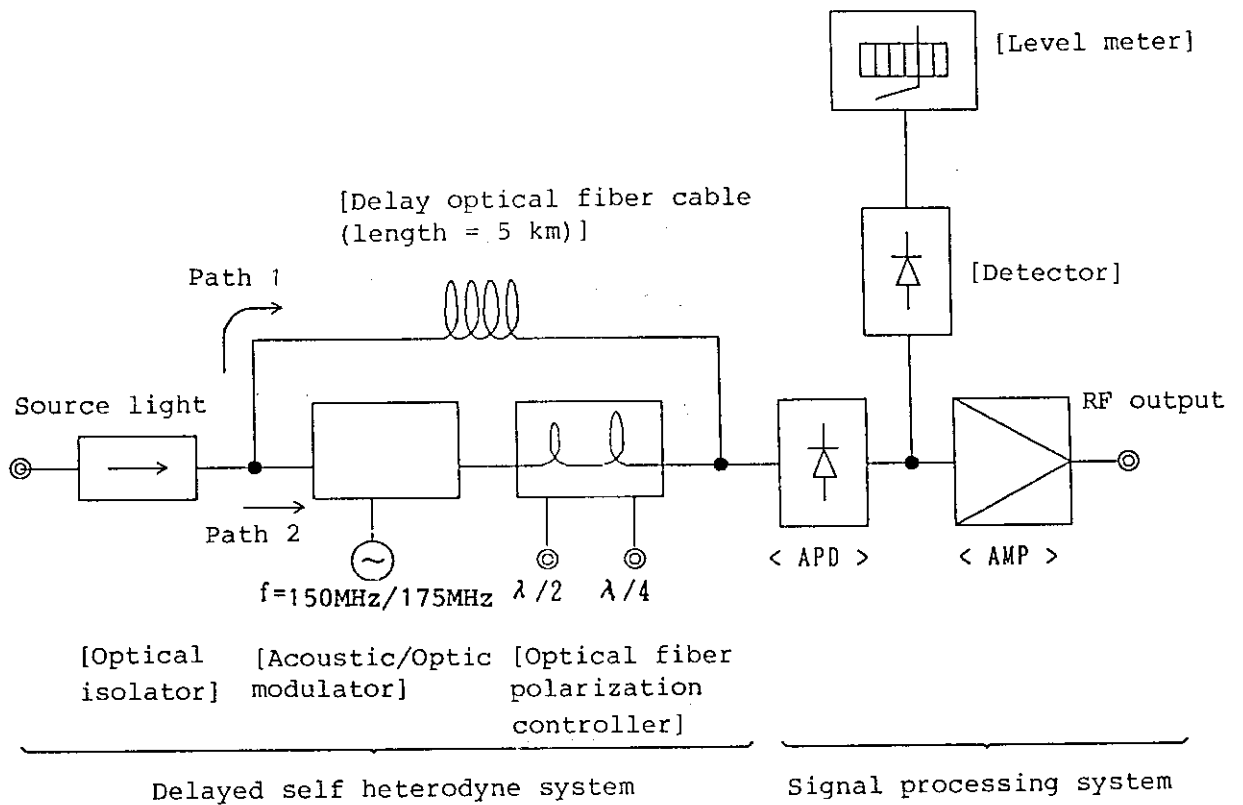

Figure 3 - 1 Block diagram of measurement by Q73321 optical measurement device

Q73321  
OPTICAL SPECTRAL LINE WIDTH TEST SET  
INSTRUCTION MANUAL

3.2 Operations of Q7332

---

3.2 Operations of Q7332

The Q7332 measurement system consists of the Q73321 optical measurement device and the R4131D analyzer/indicator.

The power spectrum distribution of the source light, which has been electrically transferred at the Q73321 test set APD, can be observed by the general purpose RF spectrum analyzer.

The R4131D analyzer/indicator supports the FWHM read out facility and the save/recall facility which performs panel setting and waveform recording.

The measurement data can be directly connected to a plotter via the GPIB interface for recording, or connected to a personal computer for further analysis.

Q73321  
OPTICAL SPECTRAL LINE WIDTH TEST SET  
INSTRUCTION MANUAL

3.3 Principle of Optical Measurement with the Q73321

---

3.3 Principle of Optical Measurement with the Q73321

The source light is input through the light input block (FC/PC connector), passes through the optical isolator, and is separated into two paths (refer to Figure 3 - 1).

Path 1 contains the delay optical fiber cable to give a delay time of  $d$ . The output light is used as the local oscillation.

In Path 2, the acoustic/optic modulator imparts a frequency shift to the light, and the light is input to the polarization controller.

The two frequencies of the light coming through Paths 1 and 2 are mixed at the optical detector (APD), and photoelectric transfer of the beat signal of the shift frequency is carried out.

This heterodyned output (from the RF output, BNC connector) is observed with the spectrum analyzer (R4131D for Q7332), to measure the spectrum distribution of the source light. The spectrum analyzer indicates twice the spectral line width of the source light. The minimum measurable spectral line width  $\Delta f$  is expressed by the formula:

$$\Delta f = \frac{1.5}{\pi \cdot \tau_d}$$

Hence,  $\Delta f = 20$  kHz (FWHM) for the 5-km long delay fiber cable.

A feature of this method is that it needs no frequency stabilization local oscillation laser because part of the source light is appropriated.

Another feature is that the source light spectrum waveform can be measured.

\* References

- T. Okoshi, K. Kikuchi, and A. Nakayama:  
'Novel method for high resolution measurement of laser output spectrum', Electronic letters, 31st July 1980. Vol.16 No.16 p. 630 to 631



Q73321  
OPTICAL SPECTRAL LINE WIDTH TEST SET  
INSTRUCTION MANUAL

4.1 Specifications of the Q73221

4. PERFORMANCE

4.1 Specifications of Q73321

(1) Q73321 measurement range and functions

Item	Standard	Remarks
Measurable wavelength range	1.55 $\mu\text{m}$ range	With Q73321
	1.31 $\mu\text{m}$ range	With custom made Q73321M
Minimum measurable spectrum width	20 kHz	FWHM
Measurement input level range	+10 to -35 dBm	
Acoustic/Optic modulator frequency	Approx. 150 MHz	with Q73321
	Approx. 175 MHz	with custom made Q73321M
Delay optical fiber length	Approx. 5 km	(Delay time 25 $\mu\text{sec}$ )
Polarization compensation	Optical fiber polarization controller incorporated	
Optical input connector	FC type	The connector end face is PC-polished.
Output connector/ Output impedance	BNC/50 $\Omega$	

Q73321  
OPTICAL SPECTRAL LINE WIDTH TEST SET  
INSTRUCTION MANUAL

4.1 Q73321 Specifications

---

(2) Common specifications of Q73321

Item	Specifications
Operating ambient conditions	Ambient temperature : 0°C to 40°C Relative humidity : 85% or less
Storage temperature	0°C to 40°C
Power supply	Power voltage : 90 to 250 VAC Power frequency : 48 to 66 Hz
Power consumption	60VA or less
Dimensions	Approx. 300 (W) x 100 (H) x 500 (D) (mm)
Weight	Approx. 7.5 kg



Q73321  
OPTICAL SPECTRAL LINE WIDTH TEST SET  
INSTRUCTION MANUAL

4.2 Main Specifications of the Q7332

---

4.2 Main Specifications of the Q7332

(1) Optical measurement device

Same as the Q73321.

(2) Analyzer/indicator (R4131D, with option 14)

Measurable frequency range : 10 kHz to 3.5 GHz

Resolution : 1 kHz to 1 MHz, 1, 3 steps

Input impedance : 50  $\Omega$

Functions : FWHM read out facility  
Save/Recall facility  
GPIB/Direct plot facility



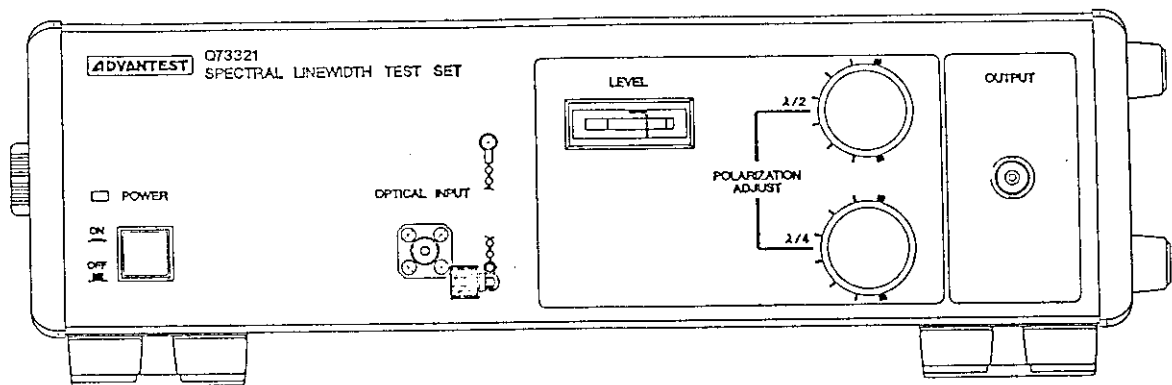

**Q73321 FRONT VIEW**

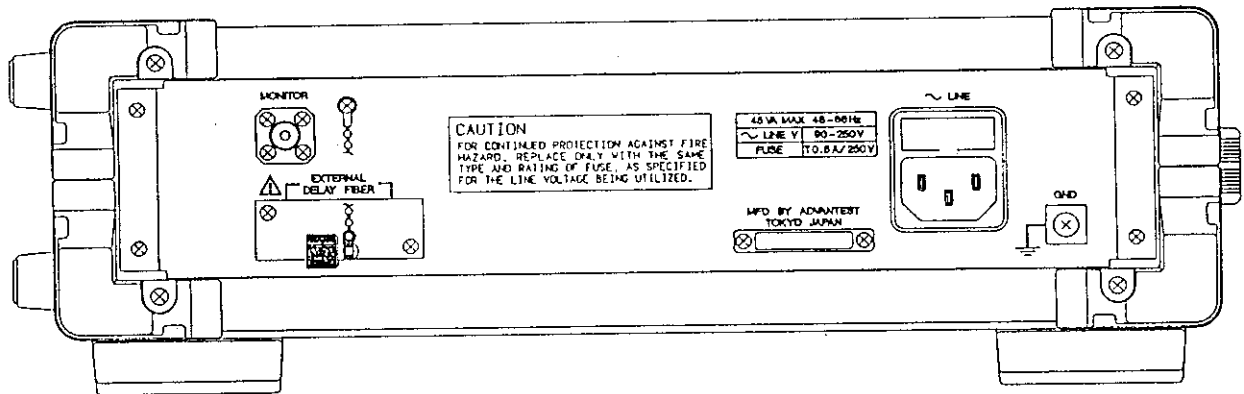

**Q73321 REAR VIEW**

Q73321EXT1-9008-C



## **IMPORTANT INFORMATION FOR ADVANTEST SOFTWARE**

PLEASE READ CAREFULLY: This is an important notice for the software defined herein. Computer programs including any additions, modifications and updates thereof, operation manuals, and related materials provided by Advantest (hereafter referred to as "SOFTWARE"), included in or used with hardware produced by Advantest (hereafter referred to as "PRODUCTS").

### **SOFTWARE License**

All rights in and to the SOFTWARE (including, but not limited to, copyright) shall be and remain vested in Advantest. Advantest hereby grants you a license to use the SOFTWARE only on or with Advantest PRODUCTS.

### **Restrictions**

- (1) You may not use the SOFTWARE for any purpose other than for the use of the PRODUCTS.
- (2) You may not copy, modify, or change, all or any part of, the SOFTWARE without permission from Advantest.
- (3) You may not reverse engineer, de-compile, or disassemble, all or any part of, the SOFTWARE.

### **Liability**

Advantest shall have no liability (1) for any PRODUCT failures, which may arise out of any misuse (misuse is deemed to be use of the SOFTWARE for purposes other than its intended use) of the SOFTWARE. (2) For any dispute between you and any third party for any reason whatsoever including, but not limited to, infringement of intellectual property rights.

## LIMITED WARRANTY

1. Unless otherwise specifically agreed by Seller and Purchaser in writing, Advantest will warrant to the Purchaser that during the Warranty Period this Product (other than consumables included in the Product) will be free from defects in material and workmanship and shall conform to the specifications set forth in this Operation Manual.
2. The warranty period for the Product (the "Warranty Period") will be a period of one year commencing on the delivery date of the Product.
3. If the Product is found to be defective during the Warranty Period, Advantest will, at its option and in its sole and absolute discretion, either (a) repair the defective Product or part or component thereof or (b) replace the defective Product or part or component thereof, in either case at Advantest's sole cost and expense.
4. This limited warranty will not apply to defects or damage to the Product or any part or component thereof resulting from any of the following:
  - (a) any modifications, maintenance or repairs other than modifications, maintenance or repairs (i) performed by Advantest or (ii) specifically recommended or authorized by Advantest and performed in accordance with Advantest's instructions;
  - (b) any improper or inadequate handling, carriage or storage of the Product by the Purchaser or any third party (other than Advantest or its agents);
  - (c) use of the Product under operating conditions or environments different than those specified in the Operation Manual or recommended by Advantest, including, without limitation, (i) instances where the Product has been subjected to physical stress or electrical voltage exceeding the permissible range and (ii) instances where the corrosion of electrical circuits or other deterioration was accelerated by exposure to corrosive gases or dusty environments;
  - (d) use of the Product in connection with software, interfaces, products or parts other than software, interfaces, products or parts supplied or recommended by Advantest;
  - (e) incorporation in the Product of any parts or components (i) provided by Purchaser or (ii) provided by a third party at the request or direction of Purchaser or due to specifications or designs supplied by Purchaser (including, without limitation, any degradation in performance of such parts or components);
  - (f) Advantest's incorporation or use of any specifications or designs supplied by Purchaser;
  - (g) the occurrence of an event of force majeure, including, without limitation, fire, explosion, geological change, storm, flood, earthquake, tidal wave, lightning or act of war; or
  - (h) any negligent act or omission of the Purchaser or any third party other than Advantest.
5. **EXCEPT TO THE EXTENT EXPRESSLY PROVIDED HEREIN, ADVANTEST HEREBY EXPRESSLY DISCLAIMS, AND THE PURCHASER HEREBY WAIVES, ALL WARRANTIES, WHETHER EXPRESS OR IMPLIED, STATUTORY OR OTHERWISE, INCLUDING, WITHOUT LIMITATION, (A) ANY WARRANTY OF MERCHANTABILITY OR FITNESS FOR A PARTICULAR PURPOSE AND (B) ANY WARRANTY OR REPRESENTATION AS TO THE VALIDITY, SCOPE, EFFECTIVENESS OR USEFULNESS OF ANY TECHNOLOGY OR ANY INVENTION.**
6. **THE REMEDY SET FORTH HEREIN SHALL BE THE SOLE AND EXCLUSIVE REMEDY OF THE PURCHASER FOR BREACH OF WARRANTY WITH RESPECT TO THE PRODUCT.**
7. **ADVANTEST WILL NOT HAVE ANY LIABILITY TO THE PURCHASER FOR ANY INDIRECT, INCIDENTAL, SPECIAL, CONSEQUENTIAL OR PUNITIVE DAMAGES, INCLUDING, WITHOUT LIMITATION, LOSS OF ANTICIPATED PROFITS OR REVENUES, IN ANY AND ALL CIRCUMSTANCES, EVEN IF ADVANTEST HAS BEEN ADVISED OF THE POSSIBILITY OF SUCH DAMAGES AND WHETHER ARISING OUT OF BREACH OF CONTRACT, WARRANTY, TORT (INCLUDING, WITHOUT LIMITATION, NEGLIGENCE), STRICT LIABILITY, INDEMNITY, CONTRIBUTION OR OTHERWISE. TORT (INCLUDING, WITHOUT LIMITATION, NEGLIGENCE), STRICT LIABILITY, INDEMNITY, CONTRIBUTION OR OTHERWISE.**
8. **OTHER THAN THE REMEDY FOR THE BREACH OF WARRANTY SET FORTH HEREIN, ADVANTEST SHALL NOT BE LIABLE FOR, AND HEREBY DISCLAIMS TO THE FULLEST EXTENT PERMITTED BY LAW ANY LIABILITY FOR, DAMAGES FOR PRODUCT FAILURE OR DEFECT, WHETHER ARISING OUT OF BREACH OF CONTRACT, TORT (INCLUDING, WITHOUT LIMITATION, NEGLIGENCE), STRICT LIABILITY, INDEMNITY, CONTRIBUTION OR OTHERWISE.**

## **CUSTOMER SERVICE DESCRIPTION**

In order to maintain safe and trouble-free operation of the Product and to prevent the incurrence of unnecessary costs and expenses, Advantest recommends a regular preventive maintenance program under its maintenance agreement.

Advantest's maintenance agreement provides the Purchaser on-site and off-site maintenance, parts, maintenance machinery, regular inspections, and telephone support and will last a maximum of ten years from the date the delivery of the Product. For specific details of the services provided under the maintenance agreement, please contact the nearest Advantest office listed at the end of this Operation Manual or Advantest's sales representatives.

Some of the components and parts of this Product have a limited operating life (such as, electrical and mechanical parts, fan motors, unit power supply, etc.). Accordingly, these components and parts will have to be replaced on a periodic basis. If the operating life of a component or part has expired and such component or part has not been replaced, there is a possibility that the Product will not perform properly. Additionally, if the operating life of a component or part has expired and continued use of such component or part damages the Product, the Product may not be repairable. Please contact the nearest Advantest office listed at the end of this Operation Manual or Advantest's sales representatives to determine the operating life of a specific component or part, as the operating life may vary depending on various factors such as operating condition and usage environment.

## SALES & SUPPORT OFFICES

Advantest Korea Co., Ltd.

22BF, Kyobo KangNam Tower,  
1303-22, Seocho-Dong, Seocho-Ku, Seoul #137-070, Korea  
Phone: +82-2-532-7071  
Fax: +82-2-532-7132

Advantest (Suzhou) Co., Ltd.

Shanghai Branch Office:  
Bldg. 6D, NO.1188 Gumei Road, Shanghai, China 201102 P.R.C.  
Phone: +86-21-6485-2725  
Fax: +86-21-6485-2726

Shanghai Branch Office:  
406/F, Ying Building, Quantum Plaza, No. 23 Zhi Chun Road,  
Hai Dian District, Beijing,  
China 100083  
Phone: +86-10-8235-3377  
Fax: +86-10-8235-6717

Advantest (Singapore) Pte. Ltd.

438A Alexandra Road, #08-03/06  
Alexandra Technopark Singapore 119967  
Phone: +65-6274-3100  
Fax: +65-6274-4055

Advantest America, Inc.

3201 Scott Boulevard, Suite, Santa Clara, CA 95054, U.S.A  
Phone: +1-408-988-7700  
Fax: +1-408-987-0691

ROHDE & SCHWARZ Europe GmbH

Mühldorfstraße 15 D-81671 München, Germany  
(P.O.B. 80 14 60 D-81614 München, Germany)  
Phone: +49-89-4129-13711  
Fax: +49-89-4129-13723

**ADVANTEST**<sup>®</sup>

<http://www.advantest.co.jp>