ADVANTEST[®]
ADVANTEST CORPORATION

Q8326
Optical Wavelength Meter
Operation Manual

MANUAL NUMBER FOE-8370686B02

Safety Summary

To ensure thorough understanding of all functions and to ensure efficient use of this instrument, please read the manual carefully before using. Note that Advantest bears absolutely no responsibility for the result of operations caused due to incorrect or inappropriate use of this instrument.

If the equipment is used in a manner not specified by Advantest, the protection provided by the equipment may be impaired.

- **Warning Labels**

Warning labels are applied to Advantest products in locations where specific dangers exist. Pay careful attention to these labels during handling. Do not remove or tear these labels. If you have any questions regarding warning labels, please ask your nearest Advantest dealer. Our address and phone number are listed at the end of this manual.

Symbols of those warning labels are shown below together with their meaning.

DANGER: Indicates an imminently hazardous situation which will result in death or serious personal injury.

WARNING: Indicates a potentially hazardous situation which will result in death or serious personal injury.

CAUTION: Indicates a potentially hazardous situation which will result in personal injury or a damage to property including the product.

- **Basic Precautions**

Please observe the following precautions to prevent fire, burn, electric shock, and personal injury.

- Use a power cable rated for the voltage in question. Be sure however to use a power cable conforming to safety standards of your nation when using a product overseas.
- When inserting the plug into the electrical outlet, first turn the power switch OFF and then insert the plug as far as it will go.
- When removing the plug from the electrical outlet, first turn the power switch OFF and then pull it out by gripping the plug. Do not pull on the power cable itself. Make sure your hands are dry at this time.
- Before turning on the power, be sure to check that the supply voltage matches the voltage requirements of the instrument.
- Connect the power cable to a power outlet that is connected to a protected ground terminal. Grounding will be defeated if you use an extension cord which does not include a protected ground terminal.
- Be sure to use fuses rated for the voltage in question.
- Do not use this instrument with the case open.
- Do not place anything on the product and do not apply excessive pressure to the product. Also, do not place flower pots or other containers containing liquid such as chemicals near this

Safety Summary

product.

- When the product has ventilation outlets, do not stick or drop metal or easily flammable objects into the ventilation outlets.
- When using the product on a cart, fix it with belts to avoid its drop.
- When connecting the product to peripheral equipment, turn the power off.

- **Caution Symbols Used Within this Manual**

Symbols indicating items requiring caution which are used in this manual are shown below together with their meaning.

DANGER: Indicates an item where there is a danger of serious personal injury (death or serious injury).

WARNING: Indicates an item relating to personal safety or health.

CAUTION: Indicates an item relating to possible damage to the product or instrument or relating to a restriction on operation.

- **Safety Marks on the Product**

The following safety marks can be found on Advantest products.



: ATTENTION - Refer to manual.



: Protective ground (earth) terminal.



: DANGER - High voltage.



: CAUTION - Risk of electric shock.

- **Replacing Parts with Limited Life**

The following parts used in the instrument are main parts with limited life.

Replace the parts listed below before their expected lifespan has expired to maintain the performance and function of the instrument.

Note that the estimated lifespan for the parts listed below may be shortened by factors such as the environment where the instrument is stored or used, and how often the instrument is used.

The parts inside are not user-replaceable. For a part replacement, please contact the Advantest sales office for servicing.

Each product may use parts with limited life.

For more information, refer to the section in this document where the parts with limited life are described.

Main Parts with Limited Life

Part name	Life
Unit power supply	5 years
Fan motor	5 years
Electrolytic capacitor	5 years
LCD display	6 years
LCD backlight	2.5 years
Floppy disk drive	5 years
Memory backup battery	5 years

- **Hard Disk Mounted Products**

The operational warnings are listed below.

- Do not move, shock and vibrate the product while the power is turned on.
Reading or writing data in the hard disk unit is performed with the memory disk turning at a high speed. It is a very delicate process.
- Store and operate the products under the following environmental conditions.
An area with no sudden temperature changes.
An area away from shock or vibrations.
An area free from moisture, dirt, or dust.
An area away from magnets or an instrument which generates a magnetic field.
- Make back-ups of important data.
The data stored in the disk may become damaged if the product is mishandled. The hard disc has a limited life span which depends on the operational conditions. Note that there is no guarantee for any loss of data.

- **Precautions when Disposing of this Instrument**

When disposing of harmful substances, be sure dispose of them properly with abiding by the state-provided law.

Harmful substances: (1) PCB (polycarbon biphenyl)
(2) Mercury
(3) Ni-Cd (nickel cadmium)
(4) Other
Items possessing cyan, organic phosphorous and hexadic chromium and items which may leak cadmium or arsenic (excluding lead in solder).

Example: fluorescent tubes, batteries

Environmental Conditions

This instrument should be only be used in an area which satisfies the following conditions:

- An area free from corrosive gas
- An area away from direct sunlight
- A dust-free area
- An area free from vibrations
- Altitude of up to 2000 m

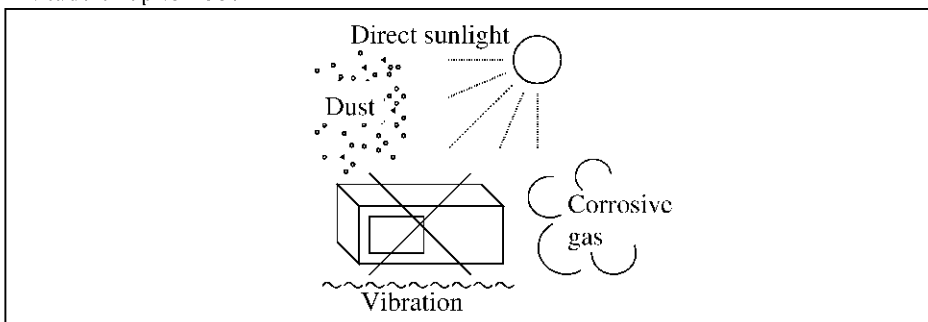

Figure-1 Environmental Conditions

- Operating position

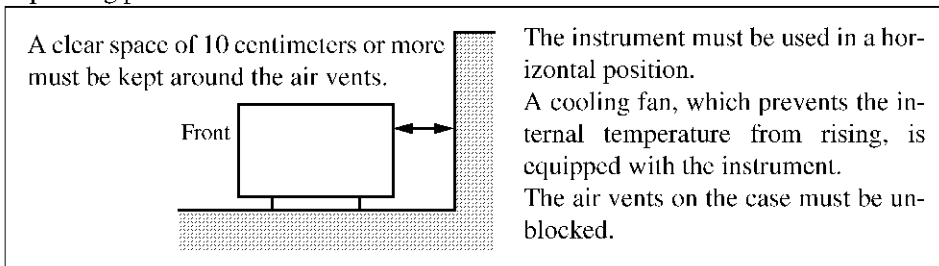

Figure-2 Operating Position

- Storage position

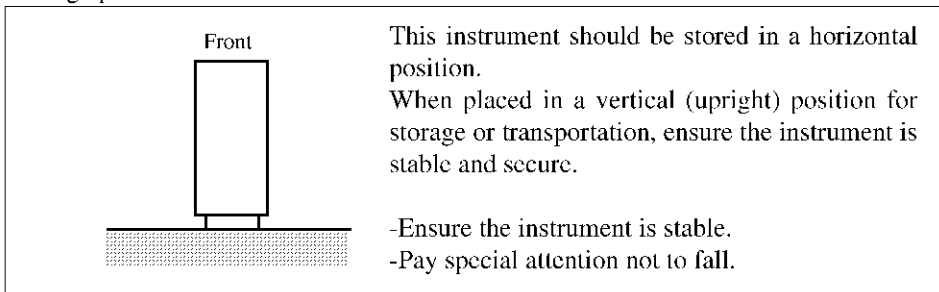

Figure-3 Storage Position

- The classification of the transient over-voltage, which exists typically in the main power supply, and the pollution degree is defined by IEC61010-1 and described below.

Impulse withstand voltage (over-voltage) category II defined by IEC60364-4-443

Pollution Degree 2

Types of Power Cable

Replace any references to the power cable type, according to the following table, with the appropriate power cable type for your country.

Plug configuration	Standards	Rating, color and length	Model number (Option number)
	PSE: Japan Electrical Appliance and Material Safety Law	125 V at 7 A Black 2 m (6 ft)	Straight: A01402 Angled: A01412
	UL: United States of America CSA: Canada	125 V at 7 A Black 2 m (6 ft)	Straight: A01403 (Option 95) Angled: A01413
	CEE: Europe DEMKO: Denmark NEMKO: Norway VDE: Germany KEMA: The Netherlands CEBEC: Belgium OVE: Austria FIMKO: Finland SEMKO: Sweden	250 V at 6 A Gray 2 m (6 ft)	Straight: A01404 (Option 96) Angled: A01414
	SEV: Switzerland	250 V at 6 A Gray 2 m (6 ft)	Straight: A01405 (Option 97) Angled: A01415
	SAA: Australia, New Zealand	250 V at 6 A Gray 2 m (6 ft)	Straight: A01406 (Option 98) Angled: -----
	BS: United Kingdom	250 V at 6 A Black 2 m (6 ft)	Straight: A01407 (Option 99) Angled: A01417
	CCC: China	250 V at 10 A Black 2 m (6 ft)	Straight: A114009 (Option 94) Angled: A114109

CAUTIONS

CLASS 1 LASER PRODUCT LABEL

The Q8326 is a class 1 laser product.

A sheet of warning labels shown below comes with the instrument as a standard accessory.

INTERNATIONAL LASER WARNING LABELS		
JAPANESE	FOR: JAPAN	
ENGLISH	FOR: UK NORWAY SWEDEN DENMARK BELGIUM NETHERLANDS	
FRENCH	FOR: FRANCE BELGIUM SWITZERLAND	
GERMAN	FOR: GERMANY BELGIUM SWITZERLAND AUSTRIA	
SPANISH	FOR: SPAIN	
ITALIAN	FOR: ITALY SWITZERLAND	
FINNISH	FOR: FINLAND	
<p>PLEASE NOTE SWITZERLAND MAY REQUIRE FRENCH, GERMAN, OR ITALIAN LABELING. BELGIUM MAY REQUIRE ENGLISH, FRENCH, OR GERMAN LABELING.</p>		

Q8326 Optical Wavelength Meter Operation Manual

Attach a seal of your language in the figures shown below.

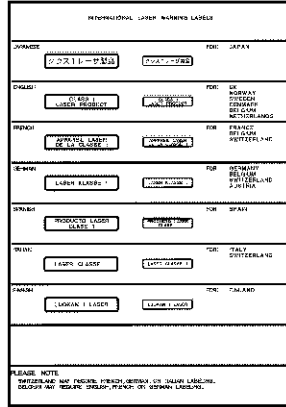

Put it on here.

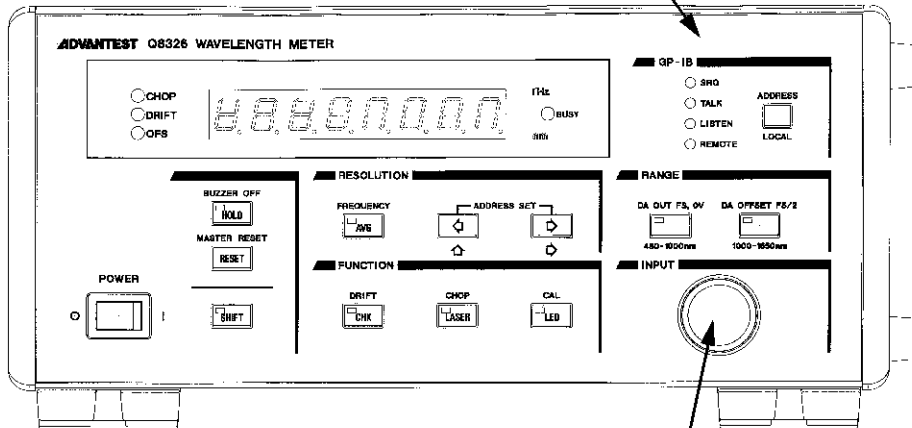

Q8326 Front view

When the fiber is not inserted, cover the terminal with the cap to prevent the dust.

CAUTION: Performance of procedures other than those specified here in may result in hazardous radiation exposure.

Certificate of Conformity



This is to certify, that

Optical Wavelength Meter

Q8326

instrument, type, designation

complies with the provisions of the EMC Directive 89/336/EEC in accordance with EN50081-1 and EN50082-1 and Low Voltage Directive 73/23/EEC in accordance with EN61010.

ADVANTEST Corp.

Tokyo, Japan

ROHDE&SCHWARZ

Engineering and Sales GmbH

Munich, Germany

8326.00

TABLE OF CONTENTS

1	INTRODUCTION	1-1
1.1	Product Description	1-1
1.2	Accessories	1-2
1.2.1	Standard Accessories	1-2
1.2.2	Accessories (sold separately)	1-2
1.3	Operating Environment	1-4
1.3.1	Environmental Conditions	1-4
1.3.2	Power Requirements	1-6
1.3.3	Power Fuse	1-6
1.3.4	Power Cable	1-7
1.4	Precautions in Use	1-8
1.5	System Checkout	1-9
1.6	About Calibration	1-9
1.7	Concerning Limited-life Parts	1-9
1.8	Cleaning, Storing and Transporting the Q8326	1-10
1.8.1	Cleaning and Replacement of Optical Connectors and Adapters	1-10
1.8.2	Cleaning	1-11
1.8.3	Storing	1-11
1.8.4	Transporting	1-11
2	OPERATION	2-1
2.1	Panel Description	2-1
2.1.1	Front Panel	2-1
2.1.2	Rear Panel	2-4
2.2	Setup (Preparations for Use)	2-5
2.2.1	Power On/Master Reset	2-5
2.2.2	Operation Check by the Self-check Function	2-6
2.3	Wavelength Measurement	2-7
2.3.1	Measurement Procedure after Setup	2-7
2.4	Measuring the Frequency	2-9
2.4.1	Changing Wavelength Measurement to Frequency Measurement	2-9
2.5	Measuring the Deviation	2-10
2.6	Measurement of High Frequency Intensity Modulated Light and CHOP Light	2-11
2.6.1	Wavelength of High Frequency Intensity Modulated Light and Measurement Procedure	2-11
2.6.2	Measurement of CHOP Light	2-11
2.7	How to Enter an Altitude Value	2-12
2.8	Useful Function for Measurement	2-13
2.8.1	HOLD	2-13
2.8.2	RESET	2-13

Table of Contents

2.8.3	AVERAGE	2-13
2.8.4	RESOLUTION Key Operation Method	2-13
2.9	D/A Output	2-15
2.9.1	Performance	2-15
2.9.2	Relationship between Display and Output Voltage	2-15
2.9.3	Key Operations Relating to D/A OUT	2-15
2.10	GPIB Address Setting	2-17
2.10.1	LOCAL Key	2-17
2.10.2	Address Setting Mode	2-17
2.11	Auxiliary Key Functions	2-18
2.11.1	Buzzer On/Off	2-18
2.12	Messages	2-19
2.12.1	Displayed Messages	2-19
2.12.2	Error Message	2-20
2.13	Default Settings	2-21
3	REMOTE PROGRAMMING	3-1
3.1	Overview of GPIB	3-1
3.2	Interface Functions	3-2
3.3	Program Code	3-3
3.4	Talker Formats (Data Output Formats)	3-4
3.5	Device Triggering Function	3-6
3.6	Device Clear Function	3-6
3.7	State Changes According to the Commands	3-7
3.8	Status Byte	3-8
3.9	GPIB Code List	3-9
3.10	Example Programs	3-10
4	TECHNICAL NOTES	4-1
5	SPECIFICATIONS	5-1
6	CALIBRATION METHOD	6-1
	DIMENSIONAL OUTLINE DRAWING	EXT-1
	ALPHABETICAL INDEX	I-1

LIST OF ILLUSTRATIONS

No.	Title	Page
1-1	Operating Environment	1-4
1-2	Replacing the Power Fuse	1-7
1-3	Power Cable	1-7
1-4	Replacing/Cleaning Optical Connector-adapters for the Q8326	1-10
2-1	Front Panel	2-1
2-2	Rear Panel	2-4
2-3	Panel Display after Master Reset	2-6
2-4	Relationship between Spectral Width and Measurement Resolution	2-8
4-1	Product description	4-1

LIST OF TABLES

No.	Title	Page
1-1	Standard Accessories List	1-2
1-2	Accessories List (sold separately)	1-2
1-3	Power Cable Options	1-3
1-4	Power Supply Specifications	1-6
2-1	Initialization	2-6
3-1	Interface Functions	3-2
3-2	Initial State After Turning the Power On	3-6
3-3	State Changes According to the Commands	3-7

1 INTRODUCTION

This chapter provides the following information:

- Product description
- A list of standard accessories and power cable options
- Operating environment
- How to verify that the Q8326 is functioning properly
- How to clean, store, and transport the Q8326

1.1 Product Description

The Q8326 optical wavelength meter enables high-precision measurement of laser and light emitting diode wavelengths and frequency.

Its characteristics are described below.

The key features of the Q8326 are listed below:

- Wide measurement ranges for wavelengths and frequencies: 480 nm to 1650 nm, and 181 THz to 625 THz, respectively.
- Highly accurate wavelength measurement: $\pm 2 \text{ ppm} \pm 1 \text{ count}$
- Resolutions: 0.001 nm and 100 MHz
In AVG mode, resolutions up to 0.0001 nm and 10 MHz can be displayed.
- Fluctuation measurements using the deviation measurement function
- A high speed sampling rate of 5 measurements/sec
- GPIB and D/A conversion analog output is standard.

1.2 Accessories

1.2 Accessories

1.2.1 Standard Accessories

Table 1-1 lists the standard accessories shipped with the Q8326. If any of the accessories are damaged or missing, contact a sales representative. Order new accessories by type name.

Table 1-1 Standard Accessories List

Product	Model	Quantity	Remarks
Power cable	A01402	1	*1
Power fuse	DFT-AA1R25A	1	1.25A (Housed in the fuse holder)
Class 1 laser product label	MNS-E1068A	1	
Q8326 Operation manual	EQ8326	1	English

* 1: Depends on the type specified when purchasing the Q8326.
 There are 11 types of power cables available (see Table 1-3).
 You can order power cables by model number or by option number.

1.2.2 Accessories (sold separately)

Table 1-2 Accessories List (sold separately)

Product	Model	Remarks
SC connector	A08162	Optical connector
ST connector	A08163	Optical connector

Table 1-3 Power Cable Options

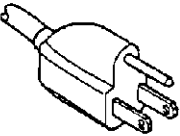
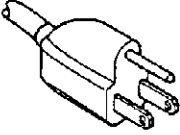
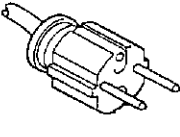
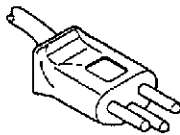
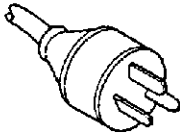
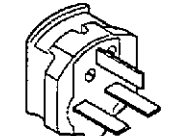
Plug configuration	Standards	Rating, color and length	Model number (Option number)
	JIS: Japan Law on Electrical Appliances	125 V at 7 A Black 2 m (6 ft)	Straight: A01402 Angled: A01412
	UL: United States of America CSA: Canada	125 V at 7 A Black 2 m (6 ft)	Straight: A01403 (Option 95) Angled: A01413
	CEE: Europe DEMKO: Denmark NEMKO: Norway VDE: Germany KEMA: The Netherlands CEBEC: Belgium OVE: Austria FIMKO: Finland SEMKO: Sweden	250 V at 6 A Gray 2 m (6 ft)	Straight: A01404 (Option 96) Angled: A01414
	SEV: Switzerland	250 V at 6 A Gray 2 m (6 ft)	Straight: A01405 (Option 97) Angled: A01415
	SAA: Australia, New Zealand	250 V at 6 A Gray 2 m (6 ft)	Straight: A01406 (Option 98) Angled: -----
	BS: United Kingdom	250 V at 6 A Black 2 m (6 ft)	Straight: A01407 (Option 99) Angled: A01417

1.3 Operating Environment

1.3 Operating Environment

This section describes the environmental conditions and power requirements necessary to use the Q8326.

1.3.1 Environmental Conditions

The Q8326 should be only be used in an area which satisfies the following conditions:

- Ambient temperature: +10°C to +40°C (operating temperature)
- Relative humidity: 85% or less (without condensation)
- An area free from corrosive gas
- An area away from direct sunlight
- A dust-free area
- An area free from vibrations
- A low noise area

Although the Q8326 has been designed to withstand a certain amount of noise riding on the AC power line, it should be used in an area of low noise. Use a noise cut filter when ambient noise is unavoidable.

- Correct operating position

To ensure that the measurement accuracy is within specifications, do not use the Q8326 unless it is placed horizontally with an inclination of less than 10 degrees.

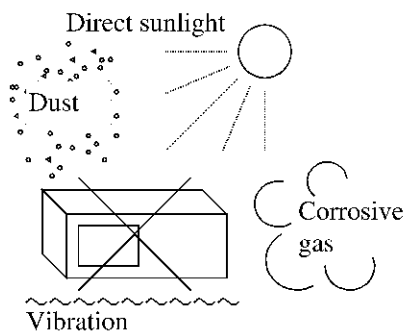

- Avoid operation in the following areas.

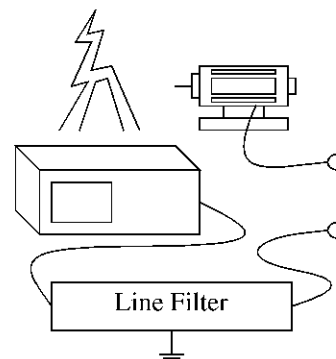

- Use a noise cut filter when there is a large amount of noise riding on the power line.

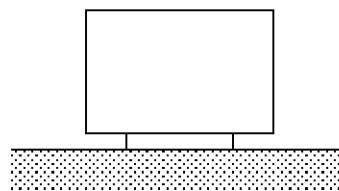

- Use the instrument in a horizontal position.

Figure 1-1 Operating Environment

The Q8326 can be used safely under the following conditions:

- Altitude of up to 2000 m
- Installation Categories II
- Pollution Degree 2

1.3.2 Power Requirements

1.3.2 Power Requirements

The power supply specifications of the Q8326 are listed in Table 1-4.

Table 1-4 Power Supply Specifications

Input voltage range	90 V to 250 V
Frequency range	48 Hz to 66 Hz
Power consumption	60 VA or below

CAUTION *To prevent damage, operate the Q8326 within the specified input voltage and frequency ranges.*

1.3.3 Power Fuse

CAUTION:

1. *When a fuse blows, there may be some problem with the Q8326. Contact a sales representative before replacing the fuse.*
 2. *For fire prevention, use only fuses with the same rating and same type.*
-

The power fuse is placed in the fuse holder which is mounted on the rear panel. A spare fuse is located in the fuse holder.

To check or replace the power fuse, use the following procedure:

1. Press the **POWER** switch (on the front panel) to the OFF position.
2. Disconnect the power cable from the AC power outlet.
3. Remove the fuse holder on the rear panel (See Figure 1-2).
4. Check (and replace if necessary) the power fuse and put it back in the fuse holder.

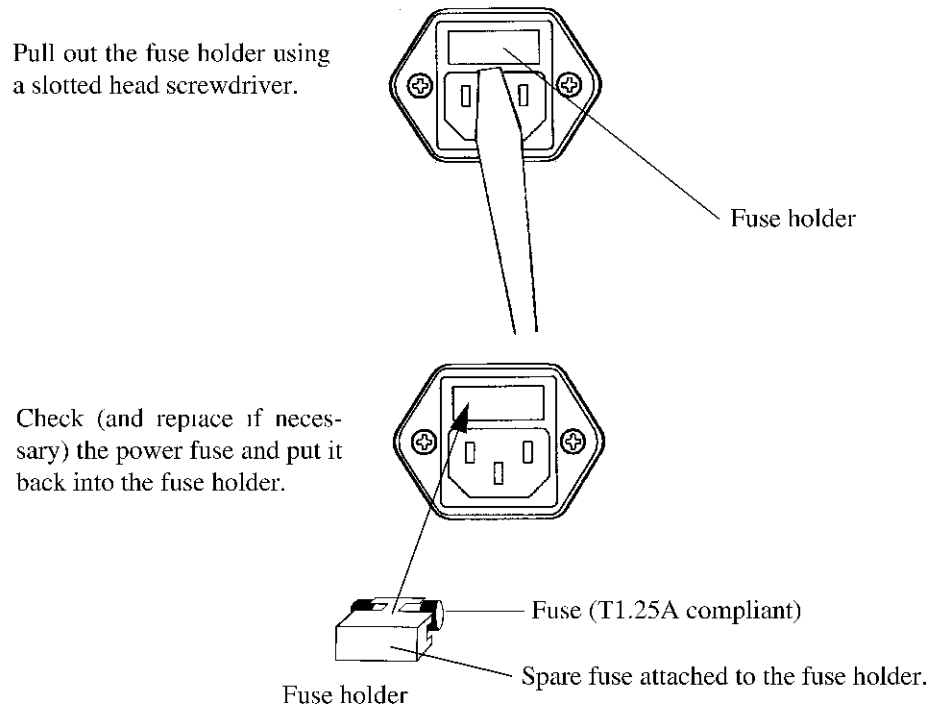

Figure 1-2 Replacing the Power Fuse

1.3.4 Power Cable

CAUTION:

1. Use a power cable rated for the voltage in question. Be sure however to use a power cable conforming to safety standards of your nation when using a product overseas (See Table 1-3).
2. Be sure to plug the power cable into an electrical outlet which has a safety ground terminal. Grounding will be defeated if you use an extension cord which does not include a safety ground terminal.
3. Turn the POWER switch (on the front panel) off prior to connecting the power cable.

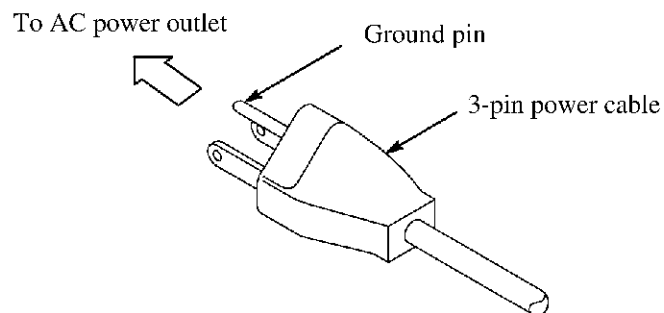

Figure 1-3 Power Cable

1.4 Precautions in Use

1.4 Precautions in Use

(1) Opening the case

Only ADVANTEST authorized service personnel can open the case.
This analyzer contains high-temperature and high-voltage components.

(2) If an abnormality occurs

If the analyzer issues smoke, a bad odor, or an unusual sound, turn off the power switch. Pull out the power cable from the outlet and contact ADVANTEST.

(3) Warming up

After the analyzer is at room temperature, turn the power on and allow it to warm up for approximately 1 hours.

(4) Electromagnetic interference

High-frequency noise is generated when using this analyzer.

Electromagnetic interference may adversely affect the television or the radio due to improper installation and use of this analyzer.

If turning off the power of this analyzer reduces electromagnetic interference, then this analyzer is its cause.

Prevent electromagnetic interference as follows:

- Change the direction of the television or radio antenna to stop the electromagnetic interference.
- Place this analyzer on the other side of the television or the radio.
- Place this analyzer away from the television or radio.
- Use a different outlet for the television or radio.

1.5 System Checkout

This section describes the Selftest which must be performed when operating the Q8326 for the first time. Follow the procedure below:

1. Check to see that the **POWER** switch (on the front panel) is turned off.
2. Connect the power cable provided to the AC power supply connector on the rear panel.

CAUTION: *To prevent damage, operate the Q8326 within specified input voltage and frequency ranges.*

3. Connect the power cable to the outlet.
4. Turn on the **POWER** switch (on the front panel).
The Q8326 performs the initial test for approximately 5 seconds, then displays the test result as shown below if the test finishes with no errors detected.

0000 mm

CAUTION: *There is a possibility that the display is different from the one shown above depending on previously saved conditions.*

1.6 About Calibration

When you want to calibrate the Q8326, please contact a sales representative.

Desirable period	One year
------------------	----------

1.7 Concerning Limited-life Parts

The parts listed below must be replaced after the period of time indicated.

Part name	Approximate life	Description
Laser tube	10000 hours	After powering on, a message of "Err rE" is displayed to indicate self diagnosis failure. In this case, contact a sales representative.

1.8 Cleaning, Storing and Transporting the Q8326

1.8.1 Cleaning and Replacement of Optical Connectors and Adapters

(1) Replacing optical connector-adapter

Although the Q8326 is equipped with FC-type connector-adapter as standard, SC-type and ST-type optical connector-adapters are also available. To replace it with other part, unscrew the adapter cap and take the connector adapter away as shown in Figure 1-4.

(2) Cleaning optical connector tip

Clean the optical connector tip using alcohol in the same manner as for the connector-adapter.

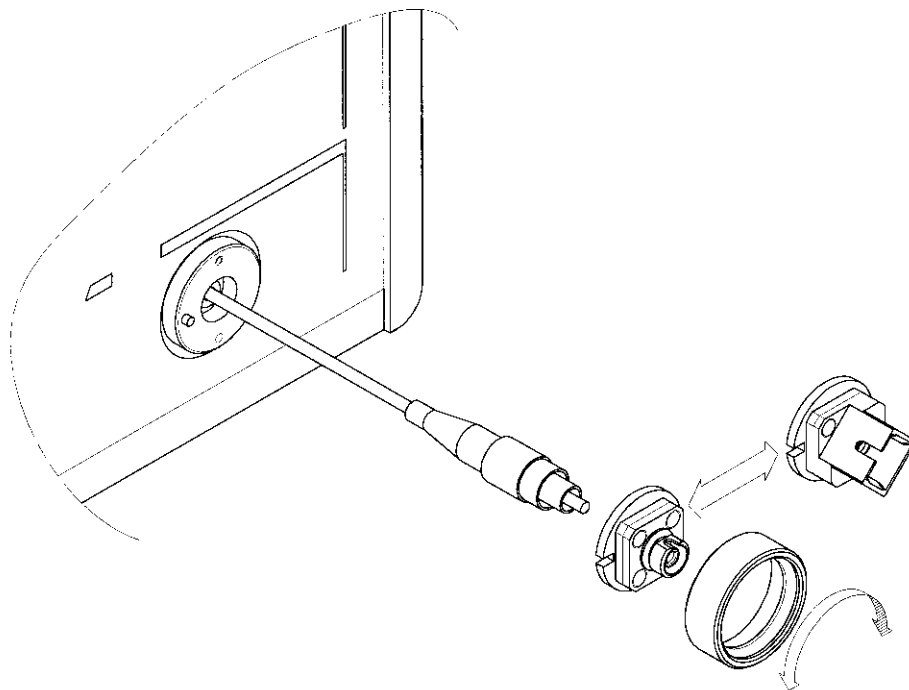

Figure 1-4 Replacing/Cleaning Optical Connector-adapters for the Q8326

CAUTION: *Be sure to tighten the adapter cap after replacing or cleaning the optical connector-adapter.*

1.8.2 Cleaning

Remove dust from the outside of the Q8326 by wiping or brushing the surface with a soft cloth or small brush. Use a brush to remove dust from around the panel keys. Hardened dirt can be removed by using a cloth which has been dampened in water containing a mild detergent.

CAUTION:

1. *Do not allow water to get inside the Q8326.*
 2. *Do not use organic cleaning solvents, such as benzene, toluene, xylene, acetone or similar compounds, since these solvents may damage the plastic parts.*
 3. *Do not use abrasive cleaners.*
-

1.8.3 Storing

Store the Q8326 in an area which has a temperature from -10°C to $+50^{\circ}\text{C}$. If you plan to store the Q8326 for a long period (more than 90 days), put the Q8326 in a vapor-barrier bag with a drying agent and store the Q8326 in a dust-free location out of direct sunlight.

1.8.4 Transporting

When you ship the Q8326, use the original container and packing material. If the original packaging is not available, pack the Q8326 using the following guidelines:

- To allow for cushioning, use a corrugated cardboard container with inner dimensions that are at least 15 centimeters more than those of the Q8326.
- Surround the Q8326 with plastic sheeting to protect the finish.
- Cushion the Q8326 on all sides with packing material or plastic foam.
- Seal the container with shipping tape or a heavy-duty, industrial stapler.

If you are shipping the Q8326 to a service center for service or repair, attach a tag to the Q8326 that shows the following information:

- Owner and address
- Name of a contact person at your location
- Serial number of the Q8326 (located on the rear panel)
- Description of the service requested

2 OPERATION

2.1 Panel Description

2.1.1 Front Panel

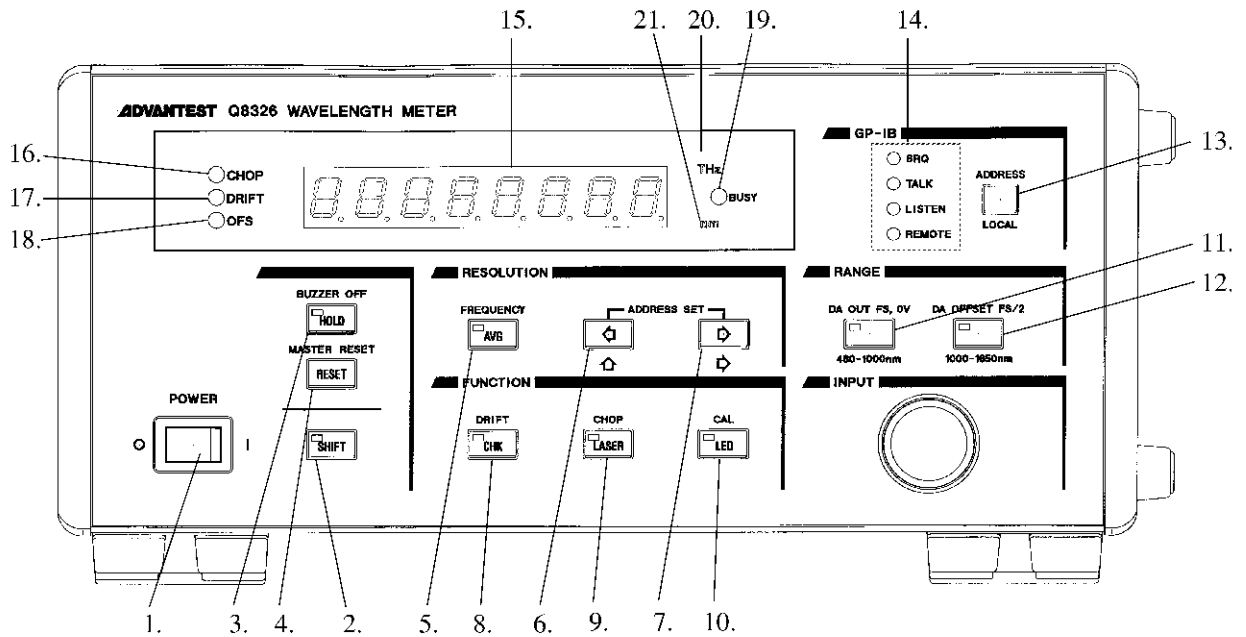

Figure 2-1 Front Panel

• Power Switch Section

1. **POWER** switch
2. **SHIFT** key
 - Press this key, and the mode is changed to the SHIFT mode. The LED in the key lights. The blue functions on keys are enabled.
 - Press the SHIFT key again to release the SHIFT key mode, and the LED in the key goes off.
3. **HOLD (BUZZER OFF)** key
 - This key holds the contents of display.
 - Repress this key to release the held state.
 - This key turns on or off the buzzer in the SHIFT key mode.
4. **RESET (MASTER RESET)** key
 - This key clears the result of measurement.
 - This key enables the single measurement when the display is held.
 - This key updates reference data when the deviation is measured.
 - This key enables master reset in the SHIFT mode and puts the equipment into the initial state.

2.1.1 Front Panel

- **RESOLUTION Section**

5. **AVG (FREQUENCY)** key

- This key displays the average of 10 measurements in the averaging mode.
- Repress this key to release the averaging mode.
- This key changes frequency measurement or waveform measurement in the SHIFT key mode.

6. **⇐ (⇑)** key

- This key reduces the number of digits displaying resolution one by one.
- This key changes the digit blinking in the GPIB ADDRESS SET mode.
- The altitude value can be changed when set to the CAL setting mode.

7. **⇒ (⇓)** key

- This key increases the number of digits displaying resolution one by one.
- This key moves the digit changing in the GPIB ADDRESS SET mode.

- **FUNCTION Section**

8. **CHK (DRIFT)** key

- This key checks whether the CHECK function and this equipment operate normally.
- Set other functions such as LASER and LED to release the CHECK function.
- Deviation measurement is enabled in the SHIFT key mode.
- Repress the **SHIFT - CHK** key to release deviation measurement.

9. **LASER (CHOP)** key

- LASER measurement mode
- Set other functions such as CHK and LED to release the LASER mode.
- When this key is pressed in the SHIFT key mode, the mode is changed to the CHOP optical measurement mode.
- Set other functions such as CHK and LED to release the CHOP optical measurement mode.

10. **LED (CAL)** key

- LED measurement mode
- Set other functions such as CHK and LASER to release the LED measurement mode.
- The altitude value can be changed when set to the shift key mode.
- Press the **SHIFT - LED** keys again to clear the previous altitude value.

- **RANGE Section**

11. **480-1000nm (DA OUT FS, 0V)** key

- This key enables the waveform measurement of 480 nm to 1000 nm (short wavelength).
- This key sets the D/A OUT output to 0 V/FULL SCALL (1 V) in the SHIFT key mode. It is convenient to use this key with the time recorder.
- Repress the **SHIFT - 480-1000nm** key to reset the D/A OUT output.

12. **1000-1650nm (DA OFFSET FS/2)** key
 - This key enables the waveform measurement of 1000 nm to 1650 nm (long wavelength).
 - This key applies the 500 mV offset to the D/A output in the SHIFT key mode.
 - Repress the **SHIFT - 1000-1650nm** key to reset the D/A OUT.
13. **LOCAL (ADDRESS)** key
 - When this key is controlled by GPIB, it release the remote state.
 - When this key is pressed in the SHIFT key mode, the mode is changed to the ADDRESS SET mode.
 - Repress the **SHIFT - LOCAL** key to release the ADDRESS SET mode.
14. GPIB status monitor
 - This monitor indicates the state of the device when it is controlled by GPIB.
 - SRQ indicates the state sending a service request to the controller.
TALK indicates the talker state to send data.
LISTEN indicates the listener state to receive data.
REMOTE indicates the remote state controlled externally.
- **DISPLAY Section**
 15. Display
 - Displays the result of measurement by 8-digit LED.
 16. SHOP indicator
 - Indicates the state of CHOP optical measurement mode.
 17. DRIFT indicator
 - Indicates the state of deviation measurement mode.
 18. OFS indicator
 - Indicates the offset of D/A OUTPUT.
 19. BUSY indicator
 - Indicates that this device performs measurement. If the condition for input is incorrect, this indicator may not light.
 20. Frequency indicator
 - Indicates the frequency measurement mode. The unit is THz.
 21. Wavelength indicator
 - Indicates the wavelength measurement mode. The unit is nm.

2.1.2 Rear Panel

2.1.2 Rear Panel

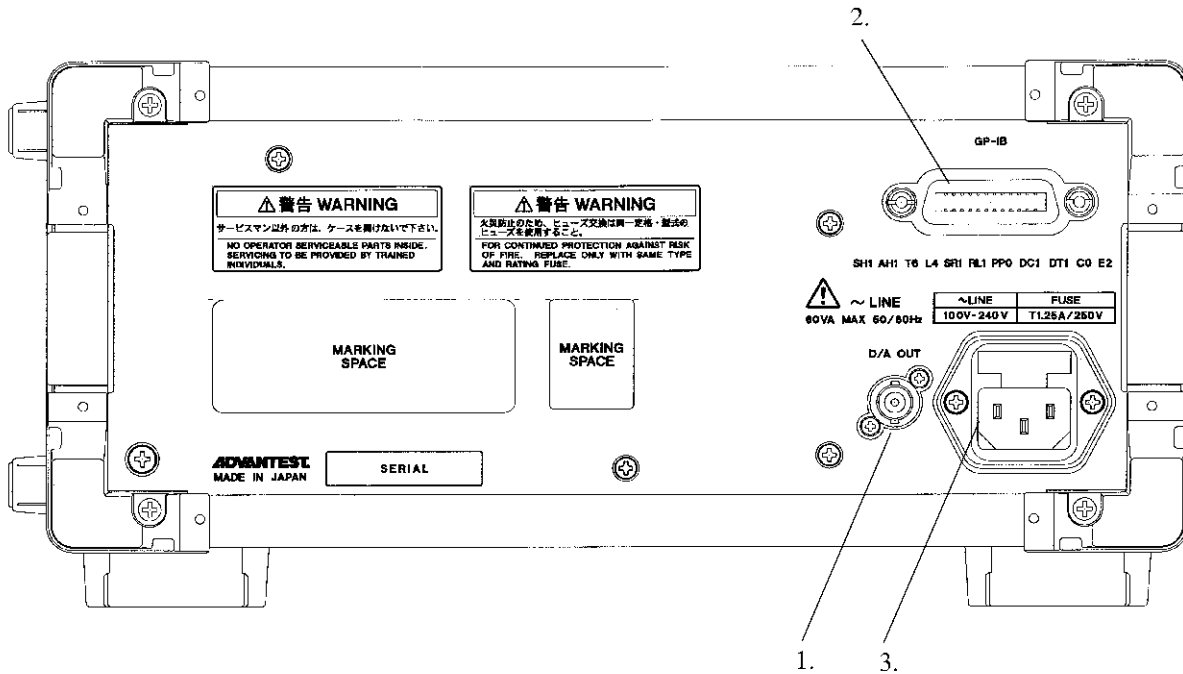

Figure 2-2 Rear Panel

1. D/A OUT terminal
Analog conversion voltage of a displayed value is output from this BNC connector.
2. GPIB connector
The GPIB connector is connected to an external controller or plotter through a GPIB cable.
3. AC LINE connector
The AC LINE connector is for the power cable.
The round prong goes to ground.

2.2 Setup (Preparations for Use)

2.2.1 Power On/Master Reset

- (1) Confirm that the power voltage is within the range of the voltage displayed on the rear panel and that the POWER switch on the front panel is off. Connect one end of the power cable to the AC LINE connector at the rear of the Q8326 and the other end to a power receptacle. If connecting an adapter to a 2-hole receptacle, connect a wire from the adapter.
- (2) When the POWER switch is set to ON, the self-diagnostic function is executed automatically and all segments of all digits and all LED lamps are turned on for one minute. Check the lamps visually.
- (3) After all digits have been turned on, ROM, RAM, and the internal circuits of the Q8326 are checked automatically. If a failure is detected, an error message is displayed. For details on error messages, see Section 2.12.2
- (4) If the Q8326 is operating normally, the panel key settings after power is turned on are restored to what they were just before power was turned off.
The display on the front panel after power is turned on is shown below.

Display		<p>All other lamps are on.</p> <p>ROM version display</p> <p>GPIB address message</p> <p>Contents of GPIB address</p> <p>No input</p> <p>The state immediately before power was turned off is restored.</p>
---------	--	---

- (5) Master reset

To initialize the settings of the keys on the front panel, press the **SHIFT - RESET (MASTER RESET)** keys. The key settings and the internal data memory are cleared for initialization. The address of the Q8326 in the GPIB system is not changed. The initial state set by MASTER RESET and the panel setting are shown below.

2.2.2 Operation Check by the Self-check Function

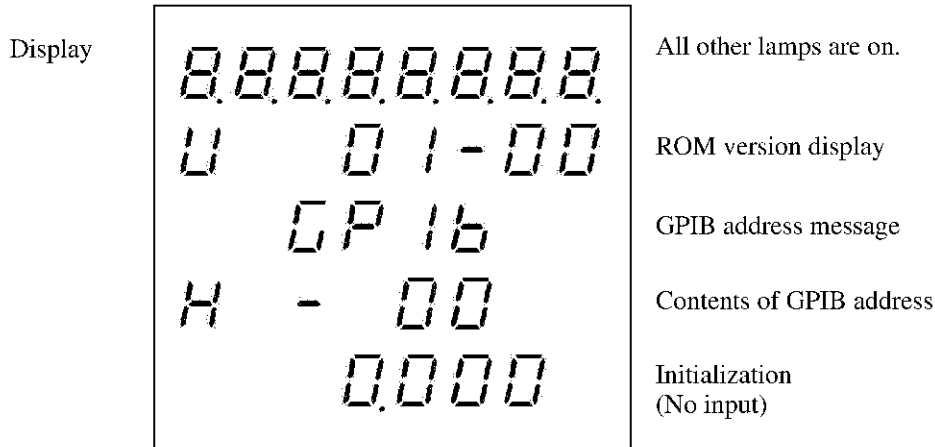

Figure 2-3 Panel Display after Master Reset

Table 2-1 Initialization

Mode	Measure wavelength
DRIFT	OFF
OFS	OFF
Resolution	0.001 nm
FUNCTION	LASER
RANGE	480 nm to 1000 nm
AVG	OFF (Lamp off)
HOLD	OFF (Lamp off)
BUZZER	ON
CAL	0 m

2.2.2 Operation Check by the Self-check Function

Perform the following operations to check whether the Q8326 is operating normally:

- (1) Confirm that the self-diagnostics function is executed after the POWER switch is turned on. (See (2) and (3) in Section 2.2.1.)
- (2) Confirm that the initial state is set after the master reset operation. (See Section 2.2.1.)
- (3) Press the **CHK** key to check whether the Q8326 internal circuits are operating normally. The following is displayed:

10000000 or 10000001

A display other than the above indicates that the Q8326 is malfunctioning. Contact a sales representative.

To enter the measurement mode when resetting the self-check function, press the **LASER (CHOP)** or **LED (CAL)** key.

2.3 Wavelength Measurement

2.3.1 Measurement Procedure after Setup

- (1) When measuring light with a short wavelength (480 nm to 1000 nm), press the **480-1000nm (DA OUT FS, 0V)** key. For a long wavelength (1000 nm to 1650 nm), press **1000-1650nm (DA OFF-SET FS/2)** key. When the **480-1000nm (DA OUT FS, 0V)** key is pressed, the following is displayed:

0.000

- (2) When measuring a laser beam (light with a narrow spectral width), press the **LASER (CHOP)** key. For a LED light (light with a wide spectral width), press the **LED (CAL)** key.
- (3) Input the light to be measured to the front panel optical connector through a fiber cable. The BUSY lamp goes on and off and the measured values are displayed.
- (4) If the measured values are scattered, press the **AVG** key to display the transitional average value of 10 measurements. Stable measured values will then be obtained.
- (5) If measured values are hard to read because of variations in the wavelengths of input light, press the \leftarrow key to blank out the lower digits. An appropriate resolution is displayed.
- (6) During measurement, “■” may be displayed in the digit position in the display area. The following is an example of measuring a laser diode with a spectral width of 500 GHz:

1323.48 _ nm

This is done by the auto resolution function.

When the spectral width of the input light is wider for the resolution set with the \leftarrow (\uparrow) and \rightarrow (\Rightarrow) keys, optimum resolution is automatically displayed. The digits that cannot be measured are displayed as “■”.

Figure 2-4 shows the relationship between spectral width (frequency or wavelength) and measurement resolution.

2.3.1 Measurement Procedure after Setup

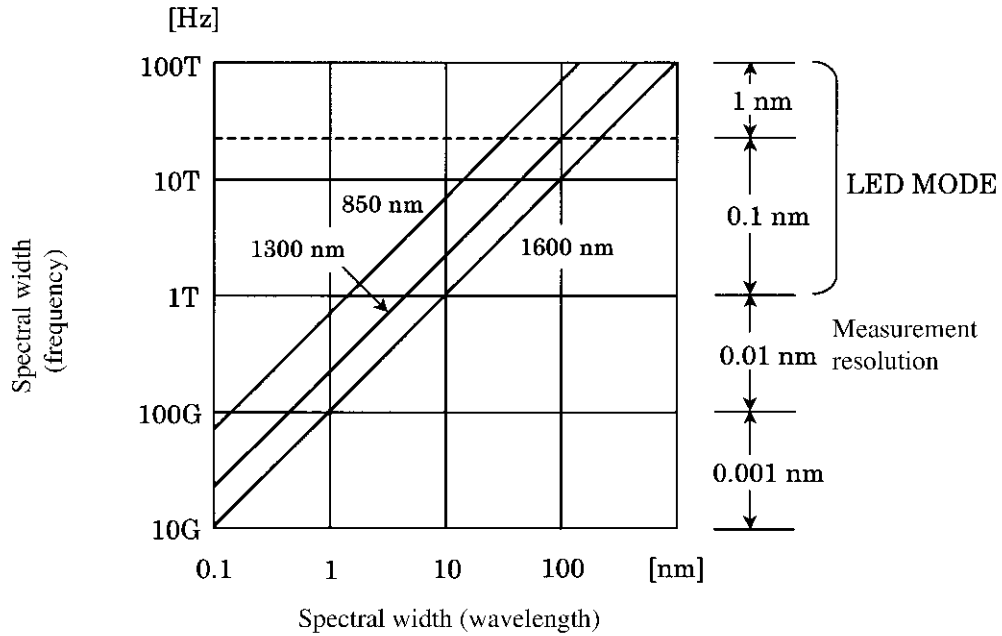

Figure 2-4 Relationship between Spectral Width and Measurement Resolution

With the above operations, the wavelength of the input light can be measured.

NOTE: When set to the laser measurement mode, use a single mode fiber. When a GI fiber is used, wavelength measurements may not be accurate.

2.4 Measuring the Frequency

2.4.1 Changing Wavelength Measurement to Frequency Measurement

In the wavelength measurement mode, the measurements are displayed using the unit in nm.

8888.8888 nm

- (1) Press the **SHIFT - FREQUENCY** keys.
Enters the frequency measurement mode, and the measurements are displayed using the unit in THz.

8888.8888 THz

- (2) Repress the **SHIFT - FREQUENCY** keys to return to wavelength measurement.
The method used to measure frequencies is the same as the one used to measure wavelengths.

2.5 Measuring the Deviation

2.5 Measuring the Deviation

Press **CHK** key and display the difference between the first measured value and the next measured value.

- (1) Press the **SHIFT - DRIFT** keys.
The LED of the DRIFT indicator lights.



This operation allows the deviation to be measured.

- (2) Press the **RESET** key to change the reference value.
- (3) Press the **SHIFT - DRIFT** keys to release the measurement of deviation.
The DRIFT LED indicator is turned off.



2.6 Measurement of High Frequency Intensity Modulated Light and CHOP Light

2.6 Measurement of High Frequency Intensity Modulated Light and CHOP Light

The Q8326 can measure wavelengths of intensity modulated light of 3 MHz or above and CHOP light of 10 Hz to 500 Hz. The measurement procedure is explained below.

2.6.1 Wavelength of High Frequency Intensity Modulated Light and Measurement Procedure

Wavelength of intensity modulated light of 3 MHz or above can be measured the same way as described in Section 2.3. The sensitivity of the average input power is proportional to the duty; that is, the sensitivity for pulse intensity modulated light with a duty ratio 50% is lowered by 3 dB.

NOTE: Even though the input light is a modulated light of 3 MHz or above, if a frequency component of 3 MHz or less is included in the modulated light, the measurement value becomes unstable.

2.6.2 Measurement of CHOP Light

The Q8326 can measure the wavelength of a laser that has been chopped electrically or mechanically.

- (1) Press the **SHIFT - LASER (CHOP)** keys.

The CHOP lamp comes on and the CHOP light measurement mode is activated.

- (2) When the wavelength of the light to be measured is in the short wavelength band, 480 nm to 1000 nm, press the **480-1000nm (DA OUT FS, 0V)** key. When it is in the long wavelength band, 1000 nm to 1650 nm, press the **1000-1650nm (DA OFFSET FS/2)** key.

- (3) If the setting resolution is too high for the pulse width, the measured values are not displayed. Press the **⇐** key to reduce the resolution.

The resolution in the CHOP light measurement mode is 1 THz to 1 GHz for frequency, 1 nm to 0.01 nm for wavelength.

Measurable CHOP light frequency range: 10 to 500 Hz

Peak power: +10 dBm or less

- (4) To reset the CHOP light measurement mode, press the **LASER** key.

2.7 How to Enter an Altitude Value

2.7 How to Enter an Altitude Value

The air refraction factor affects measurements made using this instrument since measurements are taken in an open-air environment.

Air refraction depends on the current density (or atmospheric pressure). Measurement results obtained from this optical wavelength meter are compensated for the air density by entering the current altitude.

- (1) Press the **SHIFT - CAL** keys. The CAL setting mode is turned on. The currently set altitude is displayed.
- (2) Use the \leftarrow (\uparrow) keys to set the altitude value to the one that best suits the altitude where you are. As the altitude changes in 500 m increments, select the value matching your altitude as closely as possible.

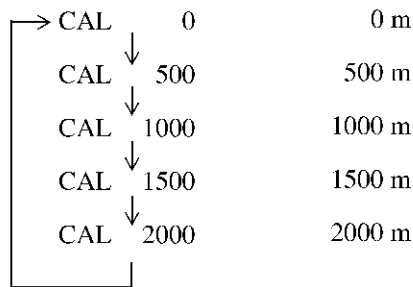

- (3) Press the **SHIFT - CAL** keys again to turn the CAL setting mode off and complete the setting. Measurement results are compensated for the altitude from this point onward.

2.8 Useful Function for Measurement

2.8.1 HOLD

When the **HOLD (BUZZER OFF)** key is pressed, the lamp on the key comes on, measurement stops, and the display is frozen. Then the key is pressed again, the lamp on the key goes off and the hold state is released.

2.8.2 RESET

When the **RESET (MASTER RESET)** key is pressed, the measured data stored in memory is cleared. The panel setting is not changed. When the key is pressed in the hold state, measurement is performed only once and the display frozen. When the key is pressed in both the hold state and the average mode, the average value for 10 measurements is displayed and maintained.

2.8.3 AVERAGE

When the **AVG (FREQUENCY)** key is pressed, the lamp on the key comes on and the average mode is set to display the transitional average value of 10 measurements.

The hold state is maintained from the time the **AVG** key is pressed until 10 measurements have been completed. After the 10th measurement has been completed, the hold state is released and the transitional average value is displayed. When the **AVG** key is pressed in the average mode, the lamp on the key goes off and the average mode is reset.

When the **RESET (MASTER RESET)** key is pressed in the average mode, the previously measured data is cleared and  is displayed.

When the next 10 measurements have been completed, the transitional average value is displayed. During the display, the lamp on the key is on.

2.8.4 RESOLUTION Key Operation Method

◀ (⇐) ▷ (⇒)

These keys set the measurement resolution. Since the up/down method is used, the user can set resolution by viewing the display.

Each time the ◀ (⇐) key is pressed once, the display is decreased by one digit.

Each time the ▷ (⇒) key is pressed once, the display is increased by one digit.

The resolution ranges that you can set are as follows.

LASER mode: For wavelength measurements 1 nm to 0.0001 nm
 For frequency measurements 1 THz to 10 MHz

NOTE: *The resolutions 0.0001 nm and 10 MHz can be displayed only when set to AVG mode.*

LED mode: For wavelength measurements 1 nm to 0.1 nm
 For frequency measurements 1 THz to 10 GHz

When the **CHK** key is set, pressing the **RESOLUTION** keys has no effect.

If the upper limit of the range of resolutions that can be set with the **RESOLUTION** keys is exceeded,

2.8.4 RESOLUTION Key Operation Method

UP *End* is displayed and, in the buzzer-on state the buzzer sounds. If the

lower limit is exceeded, *dn* *End* is displayed and, in the buzzer-on state the buzzer sounds.

The following figure shows **RESOLUTION** key operations and the resulting display.

MASTER RESET	0.0000	No entry nm
↶ (⇧)	0.00	nm
↶ (⇧)	0.0	nm
↶ (⇧)	0.	nm
↶ (⇧)	<i>dn</i> <i>End</i>	
↷ (⇨)	0.0	nm
↷ (⇨)	0.00	nm
↷ (⇨)	0.000	nm
↷ (⇨)	0.0000	nm
↷ (⇨)	<i>UP</i> <i>End</i>	

2.9 D/A Output

Analog data converted from the displayed digital data is output from the BNC connector on the rear panel. The three lower display digits are converted to analog voltage for output.

2.9.1 Performance

Number of converted digits:	Three lower display digits
Output voltage:	0 V to 0.999 V (approx. 1 mV/count)
D/A offset:	Full Scale/2 (+0.5 V)
Response:	Approx. 150 ms
Output impedance:	Approx. 670
Conversion accuracy:	±3 mV (at temperature of 23°C ±5°C and humidity of 85% or less)

2.9.2 Relationship between Display and Output Voltage

Assume that the following is displayed by pressing the **RESOLUTION** key:

632.9 nm

At this time, the D/A output is 0.329 V for the normal output mode. Assume that the following is displayed by the auto resolution function:

632.9 _ _ nm

At this time, the digit marked “ ■ ” is assumed to be 0, and the D/A output is 0.900 V for the normal output mode.

2.9.3 Key Operations Relating to D/A OUT

When the **SHIFT - 480-1000nm (DA OUT FS, 0V)** keys are pressed, **DA - 0**

is displayed, and the D/A output becomes 0 V.

When the **480-1000nm (DA OUT FS, 0V)** keys are pressed, **DA - 0**

is displayed, **DA - FS** is displayed and the D/A output is Full Scale (1 V).

To release D/A OUT FS, 0V, simultaneously press the **SHIFT - 480-1000nm (DA OUT FS, 0V)** keys.

When the **SHIFT - 1000-1650nm (DA OFFSET FS/2)** keys are pressed at the same time, the D/A output voltage offset is set to Full Scale/2 (0.5 V) and the OFS lamp comes on.

2.9.3 Key Operations Relating to D/A OUT

When these keys are pressed again, D/A offset Full Scale/2 is released.

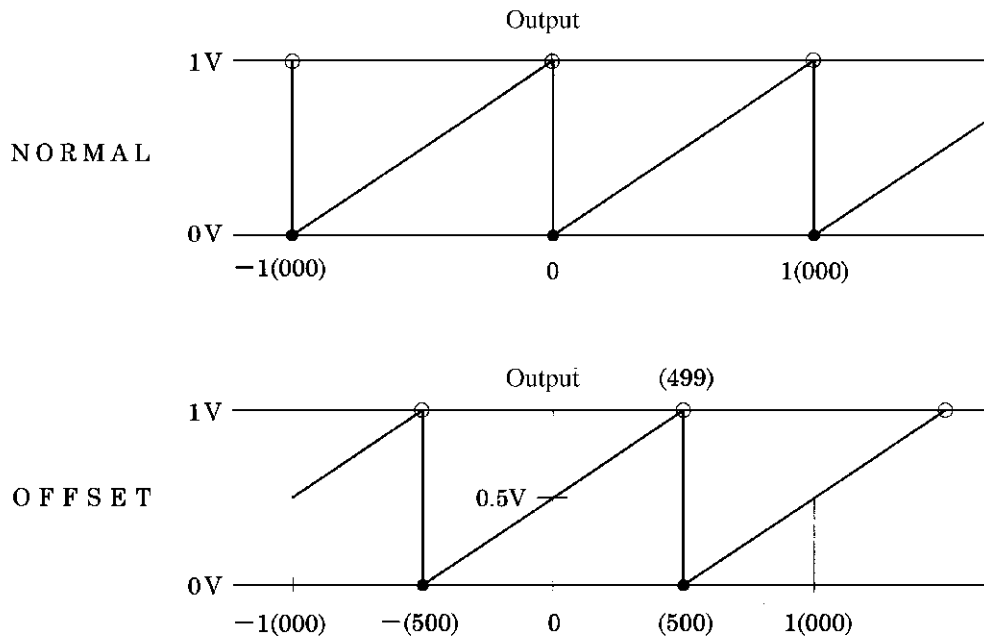

2.10 GPIB Address Setting

This section explains how to use the **LOCAL** key and how to set addresses when GPIB is used. For details on GPIB, See Chapter 3.

2.10.1 LOCAL Key

Use the **LOCAL (ADDRESS)** key when the Q8326 is controlled externally by the GPIB controller.

When the Q8326 is controlled remotely through GPIB, the **REMOTE** lamp next to the **LOCAL** key comes on, and the front panel keys disabled.

When the **LOCAL (ADDRESS)** key is pressed again, the **REMOTE** lamp goes off and the front panel keys are enabled. If the **LOCAL LOCKOUT** command is issued from the controller, the Q8326 will not accept keyboard input regardless of whether the **LOCAL** key is pressed.

2.10.2 Address Setting Mode

When the **SHIFT - LOCAL (ADDRESS)** keys are pressed, **GP 16** is displayed and the address setting mode is set. The following is displayed:

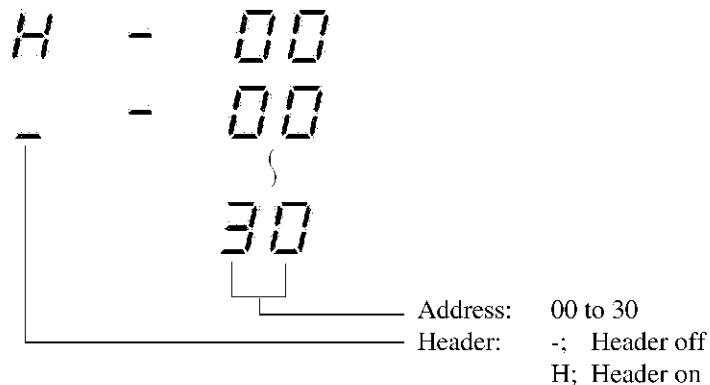

First, since the header is blinking, press the \leftarrow (\uparrow) key to set the header on or off. After the header has been set, press the \rightarrow (\rightarrow) key to set the address.

When the address display blinks, press the \leftarrow (\uparrow) key to set the address. If the \leftarrow (\uparrow) key is pressed

when address **30** is set, address **00** is displayed again.

When address setting has been completed, press the **SHIFT - LOCAL (ADDRESS)** keys to store the set address in memory and to release the address setting mode.

Note that operations other than those with the **SHIFT - LOCAL (ADDRESS)** keys cannot change the set address even though master reset is executed.

2.11 Auxiliary Key Functions

2.11 Auxiliary Key Functions

This section explains key functions, which, when known, make measuring easier the auxiliary.

2.11.1 Buzzer On/Off

Press the **SHIFT** and **HOLD (BUZZER OFF)** keys to turn the buzzer on or off. When the buzzer is on,

pressing these two keys sets the buzzer to off and causes *bu* *off* to be displayed.

When the buzzer is off, pressing these two keys sets the buzzer to on and causes

bu *on* to be displayed. When master reset is executed, the buzzer is set to on.

2.12 Messages

2.12.1 Displayed Messages

(1)

Indicates that internal settings are being performed.

(2)

When the resolution setting is changed, indicates that the maximum resolution has already been set and that the upper limit of the resolution range has been reached.

(3)

When the resolution setting is changed, indicates that the minimum resolution has already been set and that the lower limit of the resolution range has been reached.

(4)

Indicates that the buzzer is enabled.

(5)

Indicates that the buzzer is disabled.

(6)

This display appears after power is turned on or master reset is executed. It means that a GPIB address will be displayed next.

When displayed by pressing the **SHIFT - LOCAL** keys, the address setting mode is set.

(7)

Indicates that a check to determine whether display elements are normal is being performed.

(8)

Indicates that a changeover from the short wavelength measurement range to long wavelength measurement range or vice versa is being performed.

2.12.2 Error Message

(9) *DA - FS*

Indicates that D/A output is Full Scale (1 V).

(10) *DA - 0*

Indicates that D/A output is 0 V.

(11) *A*

This is displayed when the **RESET** key is pressed in both the average mode and hold state. The display is maintained until the data for 10 measurements is obtained.

2.12.2 Error Message

Err 1 GPIB syntax error

If the Q8326 malfunctions, the messages below are displayed. Contact a sales representative. The address and telephone numbers of dealers are listed at the back of this manual.

Err 0 Hardware error

Err PL PLL error

Err rE Reference error

Err oS Optical switch error

2.13 Default Settings

Item	Setting
Measurement mode	Wavelength
Function	LASER
Wavelength range	480 to 1000 nm
Resolution	0.001 nm
Sample Mode	RUN
Average	OFF
Drift	OFF
Cal	0 m
Buzzer	ON
Display	ON

3 REMOTE PROGRAMMING

3.1 Overview of GPIB

The GPIB is an interface connected to the measurement device, controller, and peripheral units, etc., through a simple cable (bus line).

The GPIB is more expandable than conventional interfaces, is easy to use, and has electrical, mechanical, and functional compatibility with other manufacturers' products, making it applicable to system configurations from simple systems to automatic design systems with high-level functions using one bus cable.

To use the GPIB, first setting an "address" for each instrument connected to the bus line is required. Each instrument is assigned one or more roles from the following three roles: controller, talker (TALKER), or listener (LISTENER).

During system operation, only one "talker" can send data to the bus line, but plural "listeners" can receive it.

The controller specifies the addresses of "talker" and "listener" to transfer data from "talker" to "listener", and the controller sets setting conditions from "talker" to "listener".

Data is synchronously transferred synchronously bidirectionally between devices via eight data lines in the bit-parallel, byte-serial form. Because this is a synchronous system, using high-speed and low-speed devices together in the same system is possible.

Data (messages) transferred between devices include measurement data, measurement conditions (programs), and commands; they are in ASCII.

In addition to eight data lines, the GPIB has three handshake lines for controlling the synchronous data transmission between instruments, and five control lines for controlling the bus information flow.

3.2 Interface Functions

3.2 Interface Functions

Table 3-1 shows interface functions.

Table 3-1 Interface Functions

Code	Function
SH1	Source handshake
AH1	Acceptor handshake
T6	Basic talker Serial polling Talker reset based on listener specification
L4	Basic listener Listener reset based on talker specification
SR1	Service request
RL1	Remote
PP0	No parallel function
DC1	Device clear
DT1	Device trigger
C0	No controller function
E2	Three-state-bus-driver used

3.3 Program Code

This section explains the program code through which the outside controller sets the Q8326 conditions.

Each program code consists of one or two English characters which indicate the functions and numerical data for setting functions as follows:

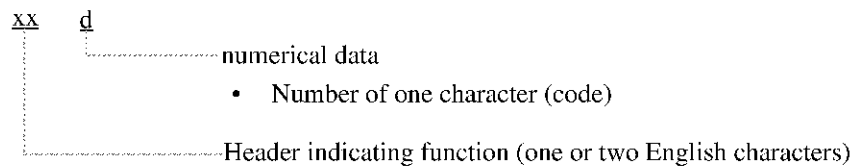

NOTE:

1. *In this analyzer, the program code is processed in one row to the terminator. The maximum allowable characters in one row are 40.*
 2. *For the functional header and unit, either a capital letter or a lower-case letter is used for setting. Any space code (20H) is set in a program code.*
-

3.4 Talker Formats (Data Output Formats)

3.4 Talker Formats (Data Output Formats)

This section describes the talker formats used when this analyzer system transfers data to an external controller.

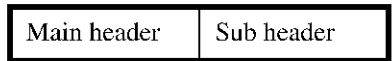
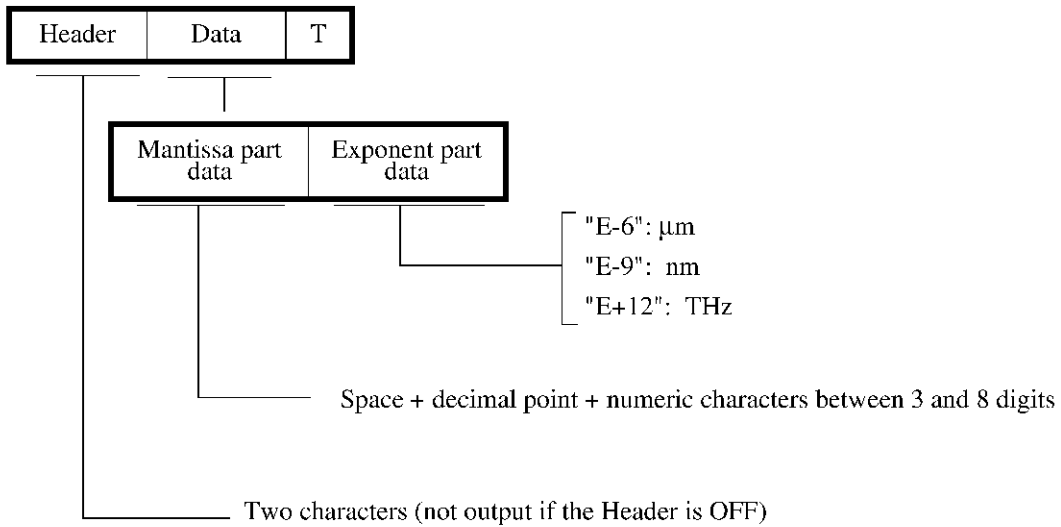

Main header	Data type
W	Wavelength
F	Frequency

Sub header	Content
C	CHECK
A	LASER
L	LED
B	CHOP
D	DRIFT LASER
G	DRIFT LED
E	ERROR

T: Terminator (either <EOI>, NL<EOI> or CR NL<EOI>)
Can be specified by the program code "Dn".

Mantissa part data format

Mode	Function	Format	
		Short wavelength	Long wavelength
Wavelength	CHECK	-ddd.d	-d.d
	LASER	-ddd.d	-d.d
	LED	-ddd.d	-d.d
	CHOP	-ddd.d	-d.d
	DRIFT(LASER)	±ddd.d	±d.d
	DRIFT(LED)	±ddd.d	±d.d
Frequency	CHECK	-ddd.d	-d.d
	LASER	-ddd.d	-d.d
	LED	-ddd.d	-d.d
	CHOP	-ddd.d	-d.d
	DRIFT(LASER)	±ddd.d	±d.d
	DRIFT(LED)	±ddd.d	±d.d

The values in the list are obtained when the display resolution is set to the default setting.

The number of displayed digits varies depending on the display resolution used.

3.5 Device Triggering Function

3.5 Device Triggering Function

This system performs a SINGLE measurement operation similar to the case in which it receives the program code "E" through the address specification command 'GET' (Group Execute Trigger).

3.6 Device Clear Function

This system is set to the initial state when turning the power on, similar to the case in which it receives the program code "C" through the address specification command 'SDC' (Selected Device Clear) and the universal command 'DCL' (Device Clear).

The initial state after turning the power on is shown in Table 3-2.

Table 3-2 Initial State After Turning the Power On

Item	Initial state
1. Measurement conditions (FUNCTION section)	Previous state DRIFT mode is released.
2. Data display	Clear
3. GPIB-related Status byte Transmission of SRQ signal Terminator	0 (Clear) "S1" (Mode in which the SQR signal is not sent) "D0" ⇒ (CR NL<EOI>)

3.7 State Changes According to the Commands

This system will be in the states listed in Table 3-3 after turning the power on and receiving the various commands.

Table 3-3 State Changes According to the Commands

Command code	Talker	Listener	Remote	SRQ	Status byte	Transferred data	Parameters and Operation State
POWER ON	Clear	Clear	Local	Clear	Clear	Clear	Partial initialization
IFC	Clear	Clear	-	-	-	-	-
DCL	-	-	-	Clear	Clear	Clear	Partial initialization
SDC	Clear	Set	-	Clear	Clear	Clear	Partial initialization
C	Clear	Set	Remote	Clear	Clear	Clear	Partial initialization
GET	Clear	Set	-	=	Clear b0	Clear	-
E	Clear	Set	Remote	=	Clear b0	Clear	-
Specifying the talker for this analyzer system.	Set	Clear	-	-	-	-	-
Command for turning the talker off.	Clear	-	-	-	-	-	-
Specifying the listener for this analyzer system.	Clear	Set	-	-	-	-	-
Command for turning the listener off.	-	Clear	-	-	-	-	-
Serial polling	Set	Clear	-	Clear	-	-	-

-: Indicates that the previous state does not change.

=: Indicates indefinite state

DCL: Device Clear

SDC: Selected Device Clear

GET: Group Execute Trigger

3.8 Status Byte

3.8 Status Byte

The functions of each bit in the status byte (used for the Q8326 system) are shown below.

b7	b6	b5	b4	b3	b2	b1	b0
----	----	----	----	----	----	----	----

- b0: measure end
Set to 1 at the end of measurement.
Set to 0 upon starting the next measurement.

- b1: syntax error
Set to 1 if there are any grammatical/setting errors in the received program codes.
Set to 0 upon receiving the next program codes.

- b6: RQS
Is the bit that indicates that it is issuing a service request and set to 1 if any of bits b0 or b1 is 1.
Set to 0 if all bits are 0.

3.9 GPIB Code List

The following table lists the GPIB commands.

Item	Header	Content
MASTER RESET	Z	Clears the settings on the panel.
RESET	C	Clears data
SINGLE measurement	E	Performs the SINGLE measurement.
SRQ signal control	S	0: Sends the SRQ. 1: Does not send the SRQ.
Terminator specification	D	0: CR NL<EOI>, 1: NL, 2: <EOI>
Header data output control	H	0: HEADER OFF, 1: HEADER ON
Measurement mode	K	0: Wavelength measurement 1: Frequency measurement
FUNCTION	F	0: CHECK (for wavelength measurement) 1: LASER 2: LED 3: CHOP
Wavelength range	W	0: 480 nm to 1000 nm 1: 1000 nm to 1650 nm
RESOLUTION	RE	For wavelength measurement 0: 0.0001 nm (when set to AVG) 1: 0.001 nm, 2: 0.01 nm 3: 0.1 nm, 4: 1 nm For frequency measurement 0: 10 MHz (when set to AVG) 1: 100 MHz, 2: 1 GHz 3: 10 GHz, 4: 100 GHz, 5: 1 THz
SAMPLE MODE	M	0: RUN, 1: HOLD
AVERAGE	A	0: AVERAGE OFF, 1: ON
DRIFT	RF	0: DRIFT OFF, 1: ON
CAL	CA	Setting for altitude 0: 0 m, 1: 500 m 2: 1000 m, 3: 1500 m 4: 2000 m
BUZZER	B	0: BUZZER OFF, 1: ON
DISPLAY	DS	0: DISPLAY OFF, 1: ON

3.10 Example Programs

3.10 Example Programs

This section describes remotecontrol examples used with GPIB.

CAUTION: *Visual Basic 4.0 (referred to as VB henceforth) is used in the sample programs shown here. Also, National Instruments-made GPIB board (referred to as NI-made for brevity henceforth) is used for the GPIB control board; NI-made driver is used for the control driver.*

- Program examples using VB

Example VB-1: Measures the light in the long waveband, and saves the wavelength.

```
Dim Rdbuf As String
Dim Wave_Length#

Call ioclr(wln) 'Performs a device clear.

Call iowrt(wln, "S1F1W1RE1M1H0") 'Selects the following: the interrupting signal by SRQ is disabled,
' laser measurement mode long waveband, a resolution of 0.001
' nm, hold and header OFF.

Call iowrt(wln, "E") 'Starts the measurement.

Rdbuf = Space(14) 'Up to 14 bytes are allocated including delimiters.
Call iord(wln, Rdbuf) 'Saves the measured wavelength data.
Wave_Length = Val(Rdbuf) 'Converts ASCII data into numeric values.
```

Example VB-2: Measures the light in the long waveband and saves the frequency. (SRQ is used.)

```
Dim res As Integer
Dim Rdbuf As String
Dim Wave_Length#

Call ioclr(wln) 'Performs a device clear.

Call iowrt(wln, "S0K1F1W1RE1M1H0") 'Selects the following: the interrupting signal by SRQ is enabled.
' frequency display mode long waveband, a resolution of 100
' MHz, hold and header OFF.

Call iowrt(wln, "E") 'Starts the measurement.

Call iowait(w m%, RQS Or ^TMO) 'Waits for an interruption by SRQ signal.
Call ioresp(wln, res) 'Reads the status byte.

If res = 65 Then
    Rdbuf = Space(18) 'Up to 18 bytes are allocated including delimiters.
    Call iord(wln, Rdbuf) 'Saves the measured frequency data.
    Wave_Length = Val(Rdbuf) 'Converts ASCII data into numeric values.
End If
```

4 TECHNICAL NOTES

Q8326 creates interface fringes through a Michelson interferometer and counts them to measure wavelengths of a laser and LED.

Figure 4-1 shows the Optical subsystem function.

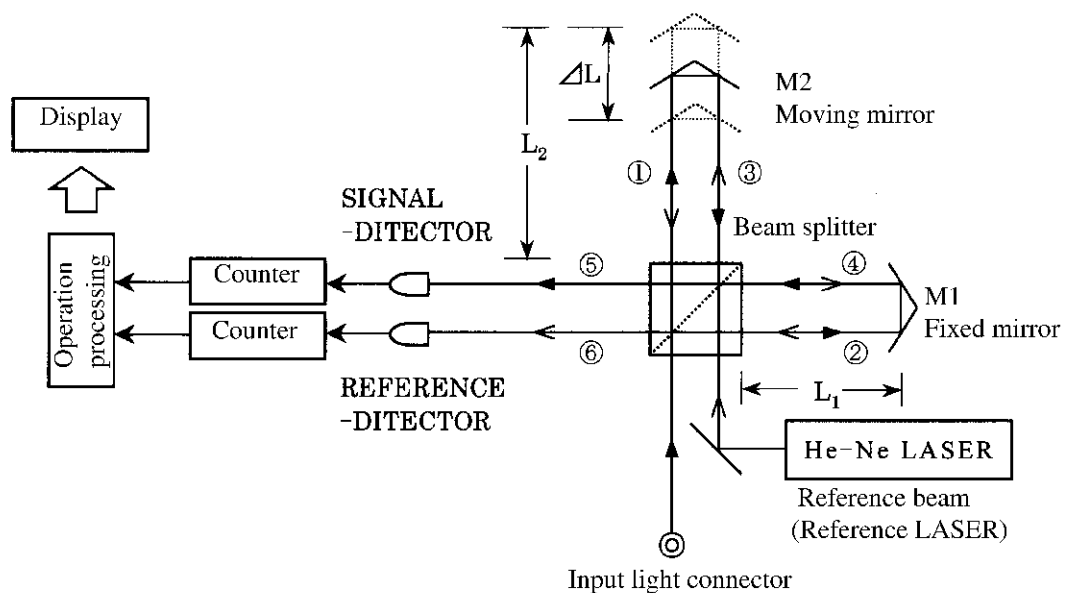

Figure 4-1 Product description

An input light is split by a beam splitter and put into path ① and path ②. The light in path ① is reflected by the moving mirror and put into path ⑤.

The light in path ② is reflected by the fixed mirror and put into path ⑥. These two light components are combined into an interference fringe, which is detected by the signal detector. A reference beam of a He-Ne laser is split by the beam splitter and put into paths ③ and ④. The split light components travel in the same optical path as that for the input light, but in the opposite direction.

The light in path ③ is reflected by the moving mirror and put into path ⑥. The light in path ④ is reflected by the fixed mirror and put into path ⑤. These two light components are combined into an interference fringe, which is detected by the reference detector.

Each time the moving mirror travels $\lambda/2$, an interference fringe is generated and the detector generates a pulse.

Assume that

Wavelength of reference beam in vacuum = λ_{ref}

Refractive index in air for this wavelength = n_{ref}

Wavelength of input light in vacuum = λ_{sig}

Refractive index in air for this wavelength = n_{sig}

Number of pulses generated by reference detector while moving mirror travels ΔL $L = N_{ref}$

Number of pulses generated by signal detector while moving mirror travels ΔL $N = N_{sig}$

4 TECHNICAL NOTES

Then,

$$\Delta L = \frac{\lambda_{\text{ref}}}{2n_{\text{ref}}} \quad N_{\text{ref}} = \frac{\lambda_{\text{sig}}}{2n_{\text{sig}}} N_{\text{sig}}$$

From this,

$$\lambda_{\text{sig}} = \lambda_{\text{ref}} \frac{N_{\text{ref}}}{N_{\text{sig}}} \frac{n_{\text{sig}}}{n_{\text{ref}}}$$

The Q8326 uses 632.9914 nm (wavelength of He-Ne laser in vacuum) as λ_{ref} . It uses wavelength characteristics of the air refractive index as a compensation value $n_{\text{sig}}/n_{\text{ref}}$ and obtains λ_{sig} (wavelength of input light in vacuum) by calculating $N_{\text{ref}}/N_{\text{sig}}$.

The wavelength-dependency of the air refractive index n_s can be calculated by the following expression.

$$(n_s - 1) \times 10^8 = 6432.8 + \frac{2949810}{(146 - \lambda^{-2})} + \frac{25540}{(41 - \lambda^{-2})} \quad (*)$$

(*): Chronological Table of Science (Japan: Maruzen Corp., 1989), p.516.

The environmental conditions of the refractive index n_s is defined as in the standard air (15°C, 1013 hPa, the CO₂ concentration of 0.03% in the dry air).

To convert a measured wavelength in a vacuum into a wavelength in air, divide by the air refractive index for that wavelength.

Frequency is operated by the following expression to be displayed.

$$F = \frac{c}{\lambda}$$

(c: Optical speed in vacuum: 2.99792458×10^8 m/s)

(F: Frequency)

5 SPECIFICATIONS

Item		Specification
Wavelength	Measurable range	480 nm to 1650 nm (181 to 625THz)
	Accuracy	± 2 ppm ± 1 count *1*2
	Display resolution	1 nm to 0.0001 nm *3
Level	Sensitivity	-15 dBm (480 nm to 600 nm) -25 dBm (600 nm to 1650 nm) -30 dBm (1200 nm to 1650 nm)
	Maximum input level	+10 dBm
Measurement time	Time	0.2 sec.
Function	Average	Displays the results of the moving average with an averaging count of 10.
	Deviation measurement	Displays the deviation from the standard measured value.
Input	Appropriate fiber	50/125 μ m GI fiber (Recommended) 9.5/125 μ m SM fiber (Recommended)
	Connector	FC (standard) ST, SC (sold separately Accessories)
Input/Output interface	GP-IB	IEEE488-1978
	Analog output	The output range for the last three digits displayed is from 0 V to +1 V.
General specifications	Operating environment range	Temperature: +10°C to +40°C Relative humidity: 85% or less (without condensation)
	Accuracy warranty temperature range	+25°C \pm 10°C
	Storage environment range	Temperature: -10°C to +50°C Relative humidity: 90% or less (without condensation)
	Power supply	100 VAC to 240 VAC, 50 Hz or 60 Hz, and power consumption of 60 VA or below.
	Dimensions	Approximately 300 (W) \times 132 (H) \times 450 (D) mm
	Mass	10.5 kg or less

*1: When a single-mode laser with 10 GHz or less is used.

5 SPECIFICATIONS

For any lasers other than that mentioned above, $\pm \text{wavelength width} \times 1/10 [\text{nm}] \pm 2 \text{ppm} \pm 1 \text{count}$

*2: ± 5 ppm for a wavelength of 600 nm or less

*3: Displaying 0.0001 nm is possible only when averaging processing is performed.

6 CALIBRATION METHOD

The Q8326 is calibrated using the three laser sources listed below. Their wavelength accuracy is less than or equal to the wavelength resolution.

Laser	Wavelength λ_s [nm]	Calibrated value (Specs)
Argon	488.122	$\lambda_s \pm 5$ ppm
HeNe	632.991 1523.488	$\lambda_s \pm 2$ ppm

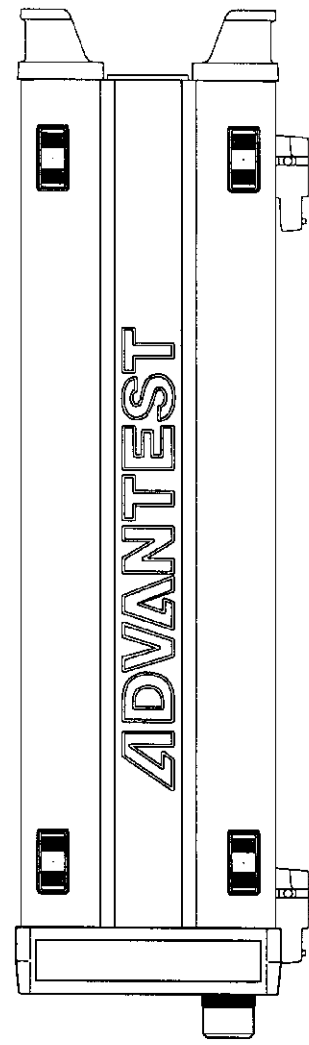
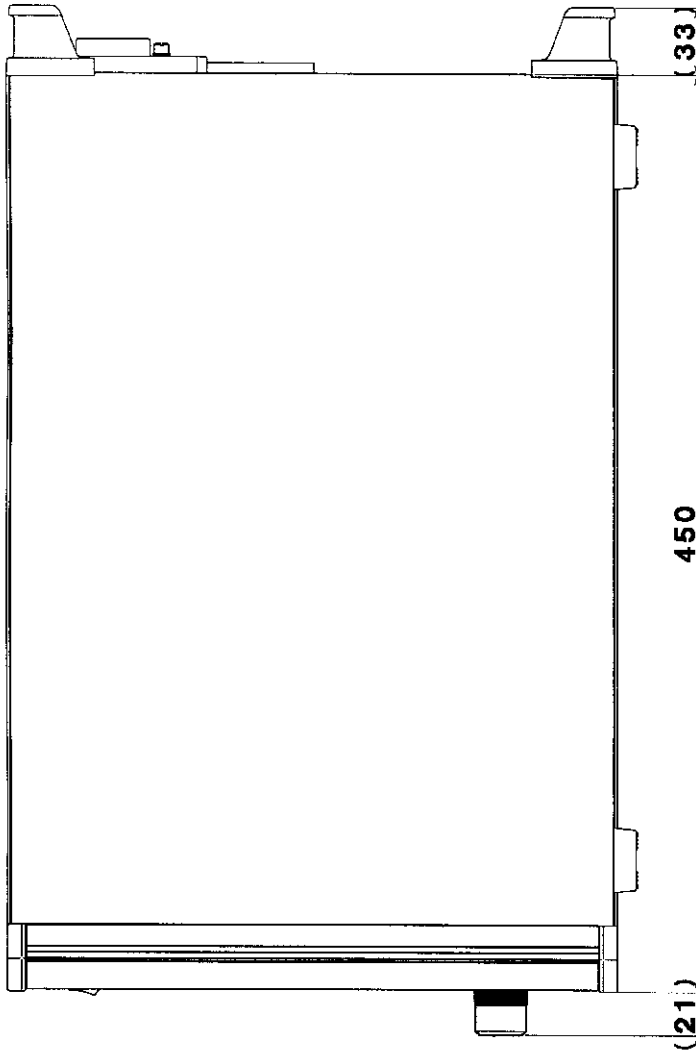
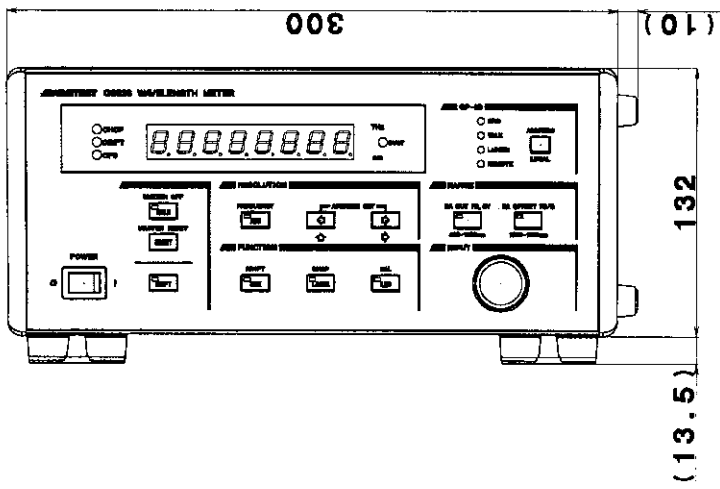

Unit : mm

CAUTION

This drawing shows external dimensions of this instrument.
The difference in products and options used can cause a change in the appearance of the instrument.

DIMENSIONAL OUTLINE DRAWING

ALPHABETICAL INDEX

- [A]**
- Accessories 1-2
 - Address Setting Mode 2-17
 - Auxiliary Key Functions 2-18
 - AVERAGE 2-13
- [B]**
- Buzzer On/Off 2-18
- [C]**
- Calibration 1-9
 - CALIBRATION METHOD 6-1
 - Changing Wavelength Measurement to Frequency Measurement 2-9
 - Cleaning 1-11
- [D]**
- D/A Output 2-15
 - Default Settings 2-21
 - Device Clear Function 3-6
 - Device Triggering Function 3-6
 - DISPLAY Section 2-3
 - Displayed Messages 2-19
- [E]**
- Environmental Conditions 1-4
 - Error Message 2-20
 - Example Programs 3-10
- [F]**
- Front Panel 2-1
 - FUNCTION Section 2-2
 - Fuse 1-6
- [G]**
- GPIB Address Setting 2-17
 - GPIB Code List 3-9
- [H]**
- HOLD 2-13
- [I]**
- Interface Functions 3-2
 - INTRODUCTION 1-1
- [K]**
- Key Operations Relating to D/A OUT 2-15
- [L]**
- Limited-life Parts 1-9
 - LOCAL Key 2-17
- [M]**
- Measurement of CHOP Light 2-11
 - Measurement of High Frequency Intensity Modulated Light and CHOP Light 2-11
 - Measurement Procedure after Setup 2-7
 - Measuring the Deviation 2-10
 - Measuring the Frequency 2-9
 - Messages 2-19
- [O]**
- Operating Environment 1-4
 - OPERATION 2-1
 - Operation Check by the Self-check Function 2-6
 - Overview of GPIB 3-1
- [P]**
- Panel Description 2-1
 - Performance 2-15
 - Power Cable 1-7
 - Power On/Master Reset 2-5
 - Power Requirements 1-6
 - Precautions in Use 1-8
 - Product Description 1-1
 - Program Code 3-3
- [R]**
- RANGE Section 2-2
 - Rear Panel 2-4
 - Relationship between Display and Output Voltage 2-15
 - REMOTE PROGRAMMING 3-1
 - RESET 2-13
 - RESOLUTION key Operation Method 2-13
 - RESOLUTION Section 2-2
- [S]**
- Setup (Preparations for Use) 2-5
 - SPECIFICATIONS 5-1
 - State Changes According to the Commands 3-7

Alphabetical Index

Status Byte 3-8
Storing 1-11
System Checkout 1-9

[T]

Talker Formats 3-4
TECHNICAL NOTES 4-1
Transporting 1-11

[U]

Useful Function for Measurement 2-13

[W]

Wavelength Measurement 2-7
Wavelength of High Frequency
Intensity Modulated Light and
Measurement Procedure 2-11

IMPORTANT INFORMATION FOR ADVANTEST SOFTWARE

PLEASE READ CAREFULLY: This is an important notice for the software defined herein. Computer programs including any additions, modifications and updates thereof, operation manuals, and related materials provided by Advantest (hereafter referred to as "SOFTWARE"), included in or used with hardware produced by Advantest (hereafter referred to as "PRODUCTS").

SOFTWARE License

All rights in and to the SOFTWARE (including, but not limited to, copyright) shall be and remain vested in Advantest. Advantest hereby grants you a license to use the SOFTWARE only on or with Advantest PRODUCTS.

Restrictions

- (1) You may not use the SOFTWARE for any purpose other than for the use of the PRODUCTS.
- (2) You may not copy, modify, or change, all or any part of, the SOFTWARE without permission from Advantest.
- (3) You may not reverse engineer, de-compile, or disassemble, all or any part of, the SOFTWARE.

Liability

Advantest shall have no liability (1) for any PRODUCT failures, which may arise out of any misuse (misuse is deemed to be use of the SOFTWARE for purposes other than its intended use) of the SOFTWARE. (2) For any dispute between you and any third party for any reason whatsoever including, but not limited to, infringement of intellectual property rights.

LIMITED WARRANTY

1. Unless otherwise specifically agreed by Seller and Purchaser in writing, Advantest will warrant to the Purchaser that during the Warranty Period this Product (other than consumables included in the Product) will be free from defects in material and workmanship and shall conform to the specifications set forth in this Operation Manual.
2. The warranty period for the Product (the "Warranty Period") will be a period of one year commencing on the delivery date of the Product.
3. If the Product is found to be defective during the Warranty Period, Advantest will, at its option and in its sole and absolute discretion, either (a) repair the defective Product or part or component thereof or (b) replace the defective Product or part or component thereof, in either case at Advantest's sole cost and expense.
4. This limited warranty will not apply to defects or damage to the Product or any part or component thereof resulting from any of the following:
 - (a) any modifications, maintenance or repairs other than modifications, maintenance or repairs (i) performed by Advantest or (ii) specifically recommended or authorized by Advantest and performed in accordance with Advantest's instructions;
 - (b) any improper or inadequate handling, carriage or storage of the Product by the Purchaser or any third party (other than Advantest or its agents);
 - (c) use of the Product under operating conditions or environments different than those specified in the Operation Manual or recommended by Advantest, including, without limitation, (i) instances where the Product has been subjected to physical stress or electrical voltage exceeding the permissible range and (ii) instances where the corrosion of electrical circuits or other deterioration was accelerated by exposure to corrosive gases or dusty environments;
 - (d) use of the Product in connection with software, interfaces, products or parts other than software, interfaces, products or parts supplied or recommended by Advantest;
 - (e) incorporation in the Product of any parts or components (i) provided by Purchaser or (ii) provided by a third party at the request or direction of Purchaser or due to specifications or designs supplied by Purchaser (including, without limitation, any degradation in performance of such parts or components);
 - (f) Advantest's incorporation or use of any specifications or designs supplied by Purchaser;
 - (g) the occurrence of an event of force majeure, including, without limitation, fire, explosion, geological change, storm, flood, earthquake, tidal wave, lightning or act of war; or
 - (h) any negligent act or omission of the Purchaser or any third party other than Advantest.
5. **EXCEPT TO THE EXTENT EXPRESSLY PROVIDED HEREIN, ADVANTEST HEREBY EXPRESSLY DISCLAIMS, AND THE PURCHASER HEREBY WAIVES, ALL WARRANTIES, WHETHER EXPRESS OR IMPLIED, STATUTORY OR OTHERWISE, INCLUDING, WITHOUT LIMITATION, (A) ANY WARRANTY OF MERCHANTABILITY OR FITNESS FOR A PARTICULAR PURPOSE AND (B) ANY WARRANTY OR REPRESENTATION AS TO THE VALIDITY, SCOPE, EFFECTIVENESS OR USEFULNESS OF ANY TECHNOLOGY OR ANY INVENTION.**
6. **THE REMEDY SET FORTH HEREIN SHALL BE THE SOLE AND EXCLUSIVE REMEDY OF THE PURCHASER FOR BREACH OF WARRANTY WITH RESPECT TO THE PRODUCT.**
7. **ADVANTEST WILL NOT HAVE ANY LIABILITY TO THE PURCHASER FOR ANY INDIRECT, INCIDENTAL, SPECIAL, CONSEQUENTIAL OR PUNITIVE DAMAGES, INCLUDING, WITHOUT LIMITATION, LOSS OF ANTICIPATED PROFITS OR REVENUES, IN ANY AND ALL CIRCUMSTANCES, EVEN IF ADVANTEST HAS BEEN ADVISED OF THE POSSIBILITY OF SUCH DAMAGES AND WHETHER ARISING OUT OF BREACH OF CONTRACT, WARRANTY, TORT (INCLUDING, WITHOUT LIMITATION, NEGLIGENCE), STRICT LIABILITY, INDEMNITY, CONTRIBUTION OR OTHERWISE. TORT (INCLUDING, WITHOUT LIMITATION, NEGLIGENCE), STRICT LIABILITY, INDEMNITY, CONTRIBUTION OR OTHERWISE.**
8. **OTHER THAN THE REMEDY FOR THE BREACH OF WARRANTY SET FORTH HEREIN, ADVANTEST SHALL NOT BE LIABLE FOR, AND HEREBY DISCLAIMS TO THE FULLEST EXTENT PERMITTED BY LAW ANY LIABILITY FOR, DAMAGES FOR PRODUCT FAILURE OR DEFECT, WHETHER ARISING OUT OF BREACH OF CONTRACT, TORT (INCLUDING, WITHOUT LIMITATION, NEGLIGENCE), STRICT LIABILITY, INDEMNITY, CONTRIBUTION OR OTHERWISE.**

CUSTOMER SERVICE DESCRIPTION

In order to maintain safe and trouble-free operation of the Product and to prevent the incurrence of unnecessary costs and expenses, Advantest recommends a regular preventive maintenance program under its maintenance agreement.

Advantest's maintenance agreement provides the Purchaser on-site and off-site maintenance, parts, maintenance machinery, regular inspections, and telephone support and will last a maximum of ten years from the date the delivery of the Product. For specific details of the services provided under the maintenance agreement, please contact the nearest Advantest office listed at the end of this Operation Manual or Advantest's sales representatives.

Some of the components and parts of this Product have a limited operating life (such as, electrical and mechanical parts, fan motors, unit power supply, etc.). Accordingly, these components and parts will have to be replaced on a periodic basis. If the operating life of a component or part has expired and such component or part has not been replaced, there is a possibility that the Product will not perform properly. Additionally, if the operating life of a component or part has expired and continued use of such component or part damages the Product, the Product may not be repairable. Please contact the nearest Advantest office listed at the end of this Operation Manual or Advantest's sales representatives to determine the operating life of a specific component or part, as the operating life may vary depending on various factors such as operating condition and usage environment.

SALES & SUPPORT OFFICES

Advantest Korea Co., Ltd.

22BF, Kyobo KangNam Tower,
1303-22, Seocho-Dong, Seocho-Ku, Seoul #137-070, Korea
Phone: +82-2-532-7071
Fax: +82-2-532-7132

Advantest (Suzhou) Co., Ltd.

Shanghai Branch Office:
Bldg. 6D, NO.1188 Gumei Road, Shanghai, China 201102 P.R.C.
Phone: +86-21-6485-2725
Fax: +86-21-6485-2726

Shanghai Branch Office:
406/F, Ying Building, Quantum Plaza, No. 23 Zhi Chun Road,
Hai Dian District, Beijing,
China 100083
Phone: +86-10-8235-3377
Fax: +86-10-8235-6717

Advantest (Singapore) Pte. Ltd.

438A Alexandra Road, #08-03/06
Alexandra Technopark Singapore 119967
Phone: +65-6274-3100
Fax: +65-6274-4055

Advantest America, Inc.

3201 Scott Boulevard, Suite, Santa Clara, CA 95054, U.S.A
Phone: +1-408-988-7700
Fax: +1-408-987-0691

ROHDE & SCHWARZ Europe GmbH

Mühldorfstraße 15 D-81671 München, Germany
(P.O.B. 80 14 60 D-81614 München, Germany)
Phone: +49-89-4129-13711
Fax: +49-89-4129-13723

ADVANTEST[®]

<http://www.advantest.co.jp>