

---

**ADVANTEST**<sup>®</sup>  
ADVANTEST CORPORATION

---

**Q8460A**  
***Optical Fiber Reflectometer***  
***Operation Manual***

MANUAL NUMBER FOE-8324219D01

---



Q8460A  
OPTICAL FIBER REFLECTOMETER  
INSTRUCTION MANUAL

Table of Contents

TABLE OF CONTENTS

1. GENERAL .....	1 - 1
1.1 Manual Configuration .....	1 - 1
1.2 System Products .....	1 - 3
1.3 Before Use .....	1 - 5
1.3.1 Appearance Check and Inventory Check .....	1 - 5
1.3.2 Power Supply, Grounding and Fuses .....	1 - 5
1.3.3 Ambient Conditions and Notes .....	1 - 9
1.4 Plug-in Units .....	1 - 10
1.4.1 Mounting/Dismounting Plug-in Unit .....	1 - 10
1.5 Method of Handling the Printer .....	1 - 12
2. OPERATION PANEL AND ADVANCE FUNCTIONS .....	2 - 1
2.1 General .....	2 - 1
2.2 Front Panel .....	2 - 2
2.3 Rear Panel .....	2 - 7
2.4 CRT Display .....	2 - 9
2.5 What is ADVANCE FUNCTION? .....	2 - 10
3. OPERATIONS .....	3 - 1
3.1 Operation Outline .....	3 - 1
3.2 Setup .....	3 - 2
3.3 Setting the Measuring Conditions .....	3 - 6
3.3.1 Refractive Index (by ADVANCE FUNCTION) .....	3 - 6
3.3.2 Distance Range .....	3 - 7
3.3.3 Pulse Width .....	3 - 7
3.3.4 Measuring Mode .....	3 - 8
3.3.5 Averaging .....	3 - 9
3.3.6 Vertical Scale and Position .....	3 - 11
3.3.7 Horizontal Span and Position .....	3 - 13
3.4 Mask Functions (Q84601/Q84621/Q84621A) .....	3 - 17
3.4.1 MASK Point Setting .....	3 - 17
3.4.2 MASK Point Cancellation .....	3 - 21
3.5 Marker Functions (In ADVANCE FUNCTION Mode) .....	3 - 25
3.5.1 Marker Types .....	3 - 25
3.5.2 Selecting the Marker Functions .....	3 - 26
3.5.3 Function of Each Marker .....	3 - 27
3.5.4 ORL .....	3 - 40
3.6 Waveform Memory .....	3 - 42
3.7 Floppy Disk Drive Unit (when equipped as option) .....	3 - 47
3.7.1 Floppy Disk Handling Notes .....	3 - 47
3.7.2 Floppy Disk Functions (ADVANCE FUNCTION) .....	3 - 49
3.7.3 Command Executing of the FDD Functions .....	3 - 58
3.7.4 Regeneration of floppy disk data in PC9801 .....	3 - 60

Q8460A  
OPTICAL FIBER REFLECTOMETER  
INSTRUCTION MANUAL

Table of Contents

---

3.8 Label .....	3 - 67
3.9 Display .....	3 - 68
3.10 Clock .....	3 - 69
3.11 I/O .....	3 - 70
3.12 Outputting the Data On-screen .....	3 - 71
3.13 Automatic Measuring Function .....	3 - 73
3.14 Multiple Reflection .....	3 - 77
4. OPERATION PRINCIPLE .....	4 - 1
4.1 Q8460A System .....	4 - 1
4.2 Plug-in Unit .....	4 - 3
5. REMOTE CONTROL VIA GPIB .....	5 - 1
5.1 General .....	5 - 1
5.1.1 Outline of GPIB .....	5 - 1
5.1.2 GPIB Standards and Specifications .....	5 - 2
5.1.3 Connecting System Devices .....	5 - 4
5.1.4 GPIB Keys on Operation Panel .....	5 - 6
5.2 Service Request .....	5 - 7
5.3 GPIB Talker Format .....	5 - 8
5.3.1 GPIB Setting Commands .....	5 - 9
5.3.2 GPIB Read Commands .....	5 - 34
5.4 Programming Examples .....	5 - 52
6. SPECIFICATIONS .....	6 - 1
APPENDIX .....	A - 1
A.1 Optical Terms .....	A - 1

Q8460A  
OPTICAL FIBER REFLECTOMETER  
INSTRUCTION MANUAL

List of Figures

LIST OF FIGURES

No.	Title	Page
1 - 1	Power Cable Plug and Adapter .....	1 - 6
1 - 2	CMV Generation Loop of Power Line .....	1 - 7
1 - 3	Fuse Holder .....	1 - 8
1 - 4	Plug-in Unit .....	1 - 10
1 - 5	Mounting and Dismounting the Plug-in Unit .....	1 - 11
2 - 1	CRT Display .....	2 - 9
2 - 2	ADVANCE FUNCTION Screen-1 .....	2 - 10
2 - 2	ADVANCE FUNCTION Screen-2 .....	2 - 11
2 - 3	ADVANCE FUNCTION Menu-1 .....	2 - 12
2 - 3	ADVANCE FUNCTION Menu-2 .....	2 - 13
3 - 1	Initial Setup Screen .....	3 - 4
3 - 2	Before Averaging .....	3 - 10
3 - 3	After Averaging .....	3 - 10
3 - 4	Before Scale Modification .....	3 - 12
3 - 5	After Scale Modification .....	3 - 12
3 - 6	Display 1 for MASK ON .....	3 - 17
3 - 7	Display 2 for MASK ON .....	3 - 18
3 - 8	Display 3 for MASK ON .....	3 - 19
3 - 9	Display 4 for MASK ON .....	3 - 20
3 - 10	Display 5 for MASK ON .....	3 - 20
3 - 11	Display 6 for MASK ON .....	3 - 21
3 - 12	Display 1 for MASK OFF .....	3 - 22
3 - 13	Display 2 for MASK OFF .....	3 - 23
3 - 14	Display 3 for MASK OFF .....	3 - 24
3 - 15	Marker Menu .....	3 - 26
3 - 16	Measurement Display of Distance .....	3 - 29
3 - 17	Measurement Display of Loss .....	3 - 29
3 - 18	Measurement Display of STANDARD 3 POINTS SPLICE .....	3 - 30
3 - 19	Measurement Display of STANDARD 5 POINTS SPLICE .....	3 - 30
3 - 20	Measurement Display of FIX DLT (LSA) .....	3 - 31
3 - 21	Measurement Display of FIX DLT (2PA) .....	3 - 32
3 - 22	Measurement Display of 3 POINTS LOSS .....	3 - 33
3 - 23	Measurement Display of 5 POINTS SPLICE .....	3 - 35
3 - 24	Measurement Display of SPLICE, SPLICE .....	3 - 37
3 - 25	Measurement Display of LOSS, LOSS (LSA) .....	3 - 38
3 - 26	Measurement Display of LOSS, LOSS (2PA) .....	3 - 39
3 - 27	ORL Function Setup Screen .....	3 - 40
3 - 28	ORL Function Measurement Screen .....	3 - 41
3 - 29	Two Waveforms Simultaneous Comparison by SAVE/VIEW Function .	3 - 42
3 - 30	Memory Initial Screen .....	3 - 43
3 - 31	MEMORY SAVE Mode Screen .....	3 - 44
3 - 32	MEMORY RECALL Mode Screen .....	3 - 45
3 - 33	MEMORY DELETE Mode Screen .....	3 - 46
3 - 34	Write-protection of floppy disk .....	3 - 47

Q8460A  
OPTICAL FIBER REFLECTOMETER  
INSTRUCTION MANUAL

List of Figures

---

No.	Title	Page
3 - 35	How to insert floppy disk .....	3 - 48
3 - 36	FDD Functions Initial Screen .....	3 - 49
3 - 37	DIRECTORY Mode Screen .....	3 - 50
3 - 38	SAVE Mode Screen .....	3 - 51
3 - 39	LOAD Mode Screen .....	3 - 52
3 - 40	DELETE Mode Screen .....	3 - 53
3 - 41	TYPE Mode Screen .....	3 - 54
3 - 42	FORMAT Mode Screen .....	3 - 55
3 - 43	INFORMATION Mode Screen .....	3 - 56
3 - 44	Label Screen .....	3 - 67
3 - 45	Automatic Measurement Setup Screen .....	3 - 73
3 - 46	All Mode Display .....	3 - 74
3 - 47	STEP Mode Display .....	3 - 76
3 - 48	Multiple Reflection Display .....	3 - 77
4 - 1	Q8460A System Block Diagram .....	4 - 2
4 - 2	Block Diagram of Plug-in Unit .....	4 - 4
5 - 1	GPIB Bus Lines .....	5 - 1
5 - 2	GPIB Connector .....	5 - 3

Q8460A  
OPTICAL FIBER REFLECTOMETER  
INSTRUCTION MANUAL

List of Tables

LIST OF TABLES

No.	Title	Page
1 - 1	System Accessories .....	1 - 5
1 - 2	Plug-in Units .....	1 - 10
5 - 1	Interface Functions .....	5 - 4
5 - 2	Standard Bus Cables (Optional) .....	5 - 5
5 - 3	GPIB Setting Command List (1 of 2) .....	5 - 9
	GPIB Setting Command List (2 of 2) .....	5 - 10
5 - 4	GPIB Read Command List (1 of 2) .....	5 - 34
	GPIB Read Command List (2 of 2) .....	5 - 35





Q8460A  
OPTICAL FIBER REFLECTOMETER  
INSTRUCTION MANUAL

1.1 Manual Configuraion

---

1. GENERAL

This chapter explains the basic configuration of this manual, an outline and operation notes of the Q8460A reflectometer, and the Q8460A setup and measurement procedure. The user should read this chapter before starting measurements with the Q8460A.

1.1 Manual Configuration

This manual is intended to be used by the user who is familiar with the optical measuring instruments (or optical system). The manual consists of the following 6 chapters. Each chapter has the complete information so that the user can understand the description of each chapter without referring to the other chapters. When using the Q8460A system first time, the user should read this manual from its beginning. Chapter 5 explains the GPIB (General-Purpose Interface Bus), and the user require to have the basic programming information to understand this chapter. Refer to the programming guide and controller instruction manual if necessary.

1. General	..... Introduction to the Q8460A products General operation notes Preparation before measurement
2. Explanation of Panel and Advance Functions	..... Panel key functions Data displayed on the CRT screen Outline of advance functions
3. Operations	..... Power-on sequence and initial setup Measuring condition setup using panel keys and advance functions
4. Operation Principle	
5. GPIB	..... Remote control via GPIB
6. Specifications	

When using this unit, note that the following warning.

Q8460A  
OPTICAL FIBER REFLECTOMETER  
INSTRUCTION MANUAL

1.1 Manual Configuraion

---

WARNING

The laser beam is emitted from the OPTICAL OUTPUT connector port. Never attempt to see the laser beam with your eyes.

Q8460A  
OPTICAL FIBER REFLECTOMETER  
INSTRUCTION MANUAL

1.2 System Products

1.2 System Products

The Q8460A optical fiber reflectometer can be used for high-precision measurement of the transmission loss, connection loss, and optical return loss (ORL) of an optical fiber cable. It can also be used to locate the problem (disconnect) position of an optical fiber cable during installation and maintenance.

The Q8460A appears as a very compact and light weight model that contains a thermal printer and 32-screen internal waveform memory to realize the optimum field performance.

[Advantages]

● Expandable plug-in system

The system has a plug-in unit structure and it can be used for both the single and multiple mode fiber cables. Refer to table below. This reflectometer can measure the single mode fiber in the wavelengths of both 1.31 $\mu$ m and 1.55 $\mu$ m, using the switching module Q84621/A.

Plug-in unit	Wavelength	Suitable fiber
Q84601	1.31 $\pm$ 0.02 $\mu$ m	10/125 $\mu$ mSMF
Q84606	1.30 $\pm$ 0.02 $\mu$ m	50/125 $\mu$ mMMF
Q84605	0.85 $\pm$ 0.02 $\mu$ m	50/125 $\mu$ mMMF
Q84605P	0.85 $\pm$ 0.02 $\mu$ m	200/125 $\mu$ mMMF
Q84621	1.31 $\pm$ 0.02/ 1.55 $\pm$ 0.03 $\mu$ m	10/125 $\mu$ mSMF
Q84621A	1.31 $\pm$ 0.02/ 1.55 $\pm$ 0.03 $\mu$ m	10/125 $\mu$ mSMF

● Optical mask function (Q84601/Q84621/Q84621A)

The optical mask can be set at 30 points on the CRT screen. This function prevents saturation of photosensor by masking the excessive Fresnel reflection. The dead zone immediately after reflection can be reduced.

● Up to 5cm of distance resolution

● 0.01dB of signal loss readout resolution

● Built-in thermal printer

The measuring conditions and results information on the CRT screen can be printed on a hardcopy without using peripheral devices.

● Standard GPIB

The system can operate in the fully remote control mode from an external controller.

Q8460A  
OPTICAL FIBER REFLECTOMETER  
INSTRUCTION MANUAL

---

1.2 System Products

- Portable system  
The system is light in weight (approximately 16kg) and easy to carry in the field.
- Automatic measurement function  
The system can automatically detect features in the optical cable, and display the distance and loss values to the various features.

Q8460A  
OPTICAL FIBER REFLECTOMETER  
INSTRUCTION MANUAL

1.3 Before Use

1.3 Before Use

1.3.1 Appearance Check and Inventory Check

When receiving the Q8460A system, check it for defects due to transportation.

Then, check the system inventory such as the quantity of standard accessories and their IDs by following Table 1-1.

Contact to your representative for any defect or shortage.

Our authorized service representatives are listed at the end of this manual.

Table 1 - 1 System Accessories

Name	Model	Ordering No.	Quantity	Remarks
Power cable	-	DCB-DD3130X01-1	1	With 2-pin adapter
Power fuse	EAWK3.15A	DFT-AA3R15A	2	
Recording paper	A09075	-	3	
Instruction manual	-	JQ8460A	1	Japanese language version
	-	EQ8460A		English version
Floppy disk (2HD)	-	ESM-000364	1	With optional unit installed

1.3.2 Power Supply, Grounding and Fuses

(1) Source voltage

The Q8460A operator with a source voltage of 90VAC to 250VAC, 47Hz to 440Hz. Make sure that the correct fuse is mounted in the power circuit.

Use the system in a low electrical noise environment although it has been designed to have sufficient EMI performance. Use a noise filter if necessary.

(2) Power cable

The power cable has a 3-pin plug at its one end. The center round rod is the ground pin, and the system is grounded when the power cable is plugged into the standard 3-pole receptacle. If only the 2-pole receptacle is available, use the A09034 (KPR-18) adapter of the accessory kit. (The adapter is shown in (a) of Figure 1-1.) Connect the ground lead of the adapter or the system ground terminal to the ground.

Q8460A  
OPTICAL FIBER REFLECTOMETER  
INSTRUCTION MANUAL

1.3 Before Use

The A09034 (KPR-18) adapter has been designed to meet certain electrical appliances regulations. The adapter has different height of electrodes (as illustrated in (b) of Figure 1-1). Plug the power cable into receptacle in the correct direction. If the A09034 (KPR-18) adapter does not match the user receptacle, use the optional KPR-13 adapter.

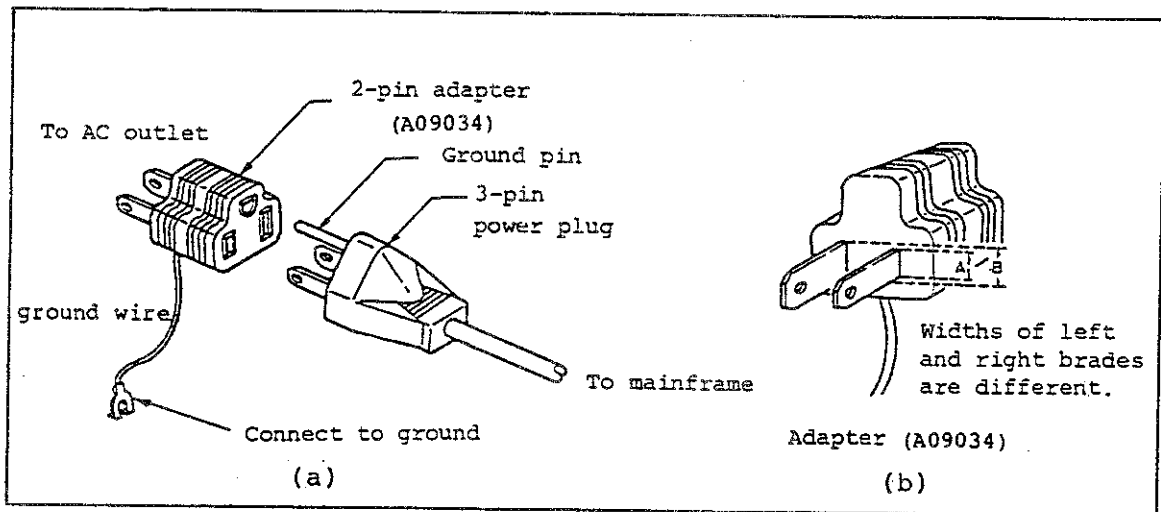
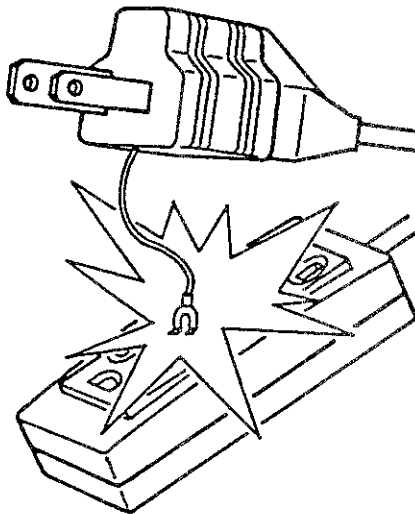

Figure 1 - 1 Power Cable Plug and Adapter

CAUTION

When connecting the ground wire of the adapter plug, never touch it with the hot line (AC line). If touched by mistake, this unit and/or other units may be damaged.



Q8460A  
OPTICAL FIBER REFLECTOMETER  
INSTRUCTION MANUAL

(3) Grounding

When connecting the Q8460A to a desk-top computer or other devices, take special care not to cause a common mode noise voltage (CMV) due to poor grounding. Do not use the power line if it is not grounded. If the power line is not grounded, approximately 50 VAC of CMV may occur between terminals "a1" and "a2" and between "b1" and "b2" due to power loop (see Figure 1-2). If the ground line between terminals "b1" and "b2" is open and if the signal line between terminals "a1" and "a2" is closed, the I/O circuit chips in circuits 1 and 2 may be damaged.

The grounded power line must be used to prevent circuit damage. Turn on or off the system by using the power switch. If the power cable is unplugged when the system is on, a CMV may occur instantaneously. Turn off the power switch and unplug the power cable. If the grounded power line is unavailable, place a jumper between ground terminals GND1 and GND2 (see Figure 1-2), plug the power cable into receptacle, and turn the power switch on.

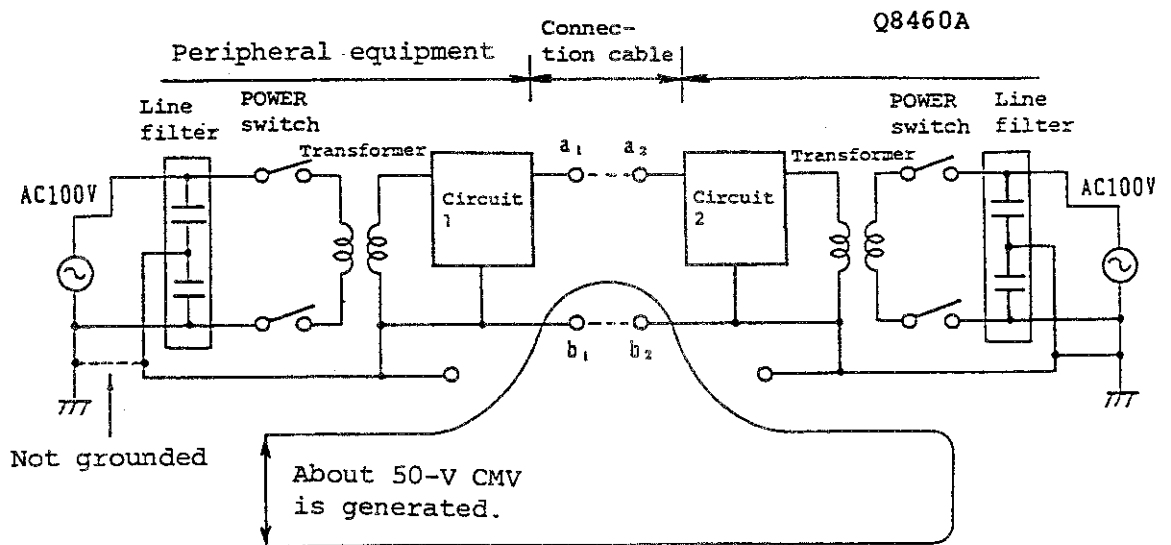

Figure 1 - 2 CMV Generation Loop of Power Line

Q8460A  
OPTICAL FIBER REFLECTOMETER  
INSTRUCTION MANUAL

(4) Fuses

Before replacing the fuse, unplug the power cable from the AC LINE connector. The power fuse is mounted on the fuse holder at the system rear panel.

Use the fuse appropriate to the source voltage as specified below.

Fuse replacement guide:

AC 90 V to 250 V ----- (EAWK3.15A)

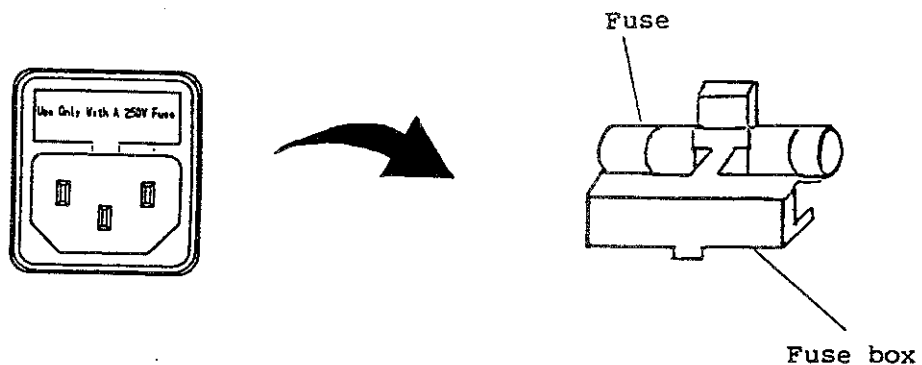

Figure 1 - 3 Fuse Holder



Q8460A  
OPTICAL FIBER REFLECTOMETER  
INSTRUCTION MANUAL

1.3 Before Use

---

1.3.3 Ambient Conditions and Notes

(1) Temperature and humidity

Use the Q8460A in the ambient temperature of 0°C to +40°C and relative humidity of 85% or less to have the reliable system operation.

(2) Installation location

As the Q8460A is a highly sensitive measuring instrument, keep it from excessive dust or vibration, direct sun, and corrosive gases. Place the system on a stable base so that it is not in danger of being dropped.

(3) Eye protection from laser beam

The Q8460A uses the laser diode as the optical light source. The beam is invisible and harmful to your eyes. Never try to see the optical light source and its related connector sections with your eyes.

(4) Cautions for high voltage

The system uses high voltage power for the CRT.  
Never disassemble the Q8460A with Power On.

(5) Cooling and ventilation

The system uses a cooling fan to avoid internal temperature rise. As the fan is of pulling type, use it with cares concerning ambient ventilation.

Never place the Q8460A upright or put other objects behind the Q8460A that will block ventilation.

(6) Storage

The temperature range for storage of the Q8460A is -20°C to +60°C. If the system is out of service for a long period, cover it with vinyl sheets and keep it from dew condensation with a carton box or others.

Place it on a dry position free from direct sun.

(7) Cautions for dew condensation

The Q8460A uses lenses internally, as a result observe caution such that condensation due to sudden temperature change does not occur. If dew condensation is observed on the system, dry it completely before use.

(8) Warming up

Allow for a 30 minute or more warm up period before use in order to obtain satisfactory measuring accuracy.

Q8460A  
OPTICAL FIBER REFLECTOMETER  
INSTRUCTION MANUAL

1.4 Plug-in Units

1.4 Plug-in Units

The system has the following types of plug-in optical source listed in Table 1-2.

Table 1 - 2 Plug-in Units

Plug-in unit	Wavelength	Suitable fiber
Q84601	$1.31 \pm 0.02 \mu\text{m}$	10/125 $\mu\text{m}$ SMF
Q84606	$1.30 \pm 0.02 \mu\text{m}$	50/125 $\mu\text{m}$ MMF
Q84605	$0.85 \pm 0.02 \mu\text{m}$	50/125 $\mu\text{m}$ MMF
Q84605P	$0.85 \pm 0.02 \mu\text{m}$	200/125 $\mu\text{m}$ MMF
Q84621	$1.31 \pm 0.02 / 1.55 \pm 0.03 \mu\text{m}$	10/125 $\mu\text{m}$ SMF
Q84621A	$1.31 \pm 0.02 / 1.55 \pm 0.03 \mu\text{m}$	10/125 $\mu\text{m}$ SMF

1.4.1 Mounting/Dismounting Plug-in Unit

CAUTION

Turn the system power supply off before mounting or dismounting the plug-in unit.

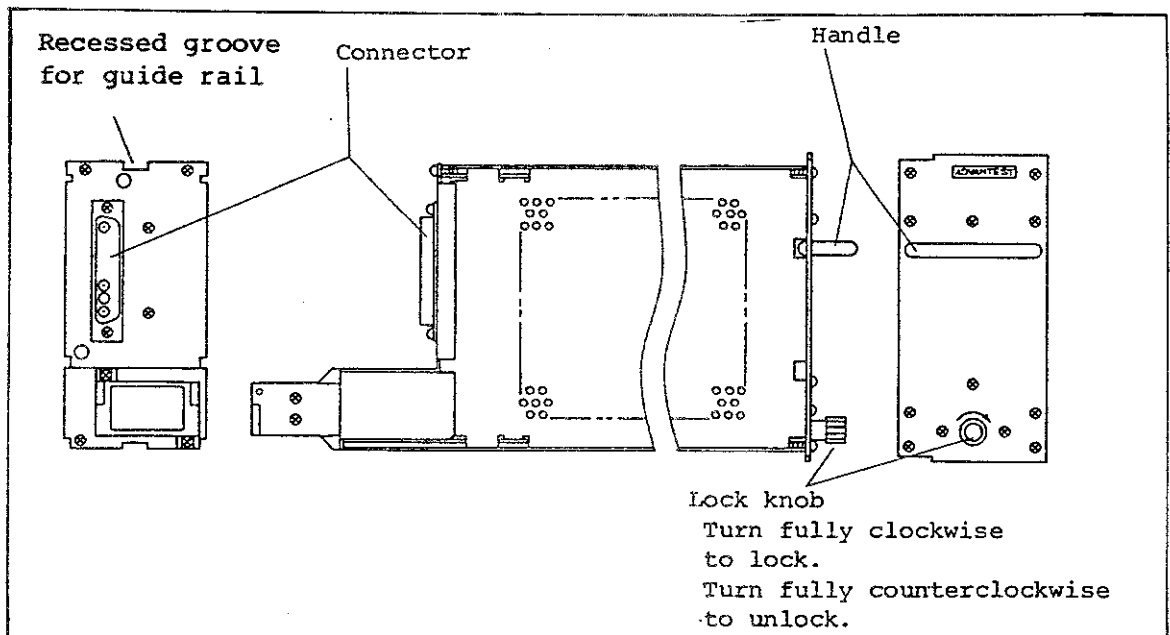

Figure 1 - 4 Plug-in Unit

Q8460A  
OPTICAL FIBER REFLECTOMETER  
INSTRUCTION MANUAL

1.4 Plug-in Units

(1) Mounting the plug-in unit

- ① Engage the plug-in unit on the upper and lower rails of the Q8460A system and carefully slide the unit into the housing.
- ② Make sure that the connector locating on the front panel of the unit engages to the system and that the shutter of the laser output connector can be opened or closed smoothly.
- ③ Insert the plug-in unit until it engages with the lock of the rear panel and clicks.
- ④ Fully rotate the control knob of the plug-in unit clockwise (CW).

(2) Dismounting the plug-in unit

Unlock the control of the plug-in unit by rotating it counterclockwise (CCW), and pull out the unit using the handle provided.

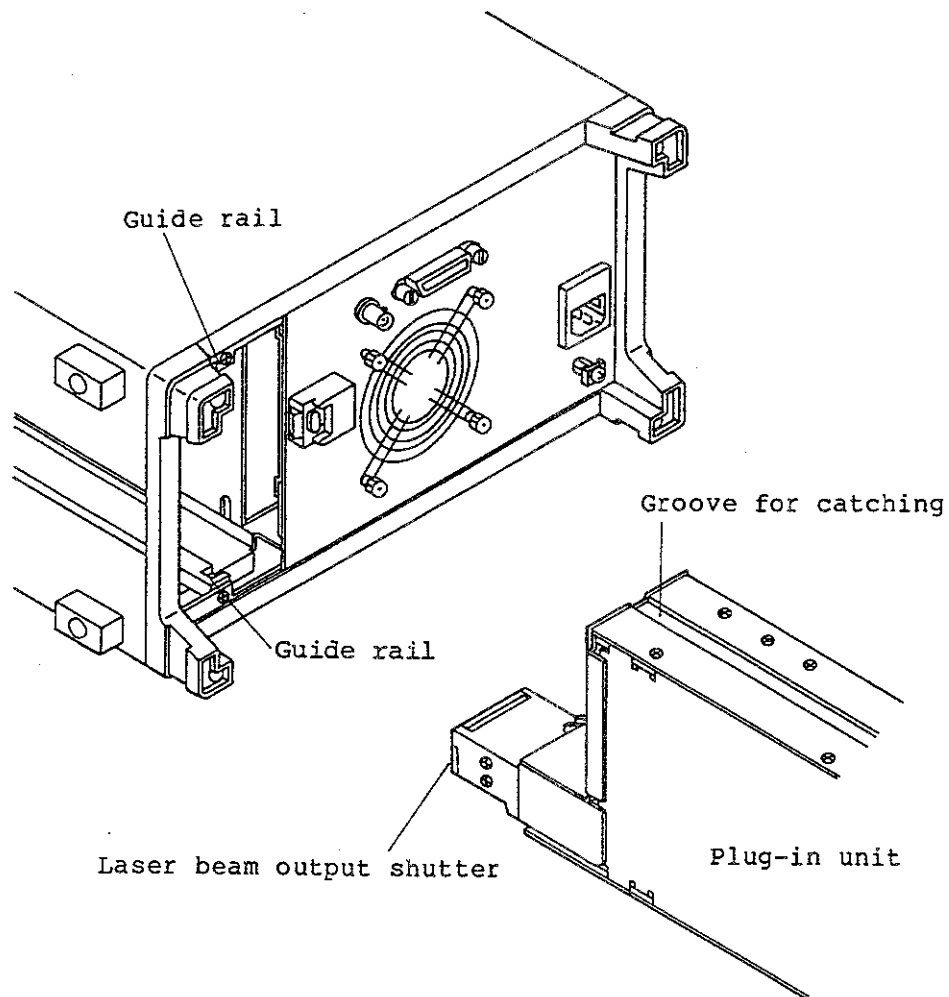

Figure 1 - 5 Mounting and Dismounting the Plug-in Unit

Q8460A  
OPTICAL FIBER REFLECTOMETER  
INSTRUCTION MANUAL

1.5 Method of Handling the Printer

---

1.5 Method of Handling the Printer

- ① Slide the head up lever upward.
- ② Place the paper roll in the holder with its top upside down.
- ③ Set the paper roll so that paper comes out from the front side of the upper printing head.
- ④ Set the head up lever to DOWN (hold).
- ⑤ Perform feeding to check that paper is fed correctly.

Printing paper: A09075 (order number)

Five rolls/box (Printing paper can be ordered in units of one box.)

Thermal face outward rolling:

30m roll

Paper width: 114mm

Note: Avoid using unspecified paper.

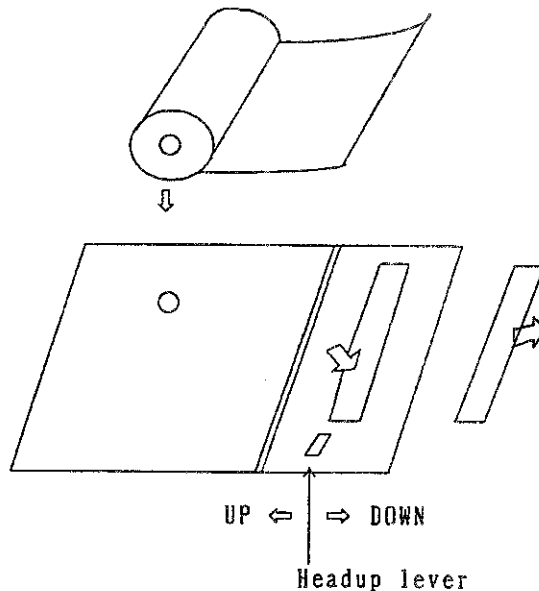

Q8460A  
OPTICAL FIBER REFLECTOMETER  
INSTRUCTION MANUAL

2.1 General

---

2. OPERATION PANEL AND ADVANCE FUNCTIONS

2.1 General

This chapter explains the functions of keys and switches on the operation panel and the advance functions that display messages on the CRT screen. When the LED of a key lights, it indicates that the key function setup mode has been selected. An optional setting value may be changes one after the other whenever the key is pressed, or it may be changed continuously when the data knob is rotated. If the key has no LED indicator, its selected value is displayed on the CRT screen and you can change it using that key.

You can cancel the current setup mode of a key by pressing another setup key.

When you have selected the Buzzer ON mode and you press a valid key, a high-frequency short beep sounds for indicating a valid key input. If you press an invalid key (that is, an unavailable key in the current setup mode), a low-frequency short beep sounds for indicating an invalid key input. (See Paragraph (3) of Section 3.10.)

Q8460A  
OPTICAL FIBER REFLECTOMETER  
INSTRUCTION MANUAL

2.2 Front Panel

2.2 Front Panel

- ① POWER switch : Turns the Q8460A system power supply on or off.
- ② INTENSITY control : Adjusts the intensity of the CRT screen.

CAUTION

Do not keep the INTENSITY control at the rightmost end position for a long time, or the cathode ray tube (CRT) may be burned.

- ③ REMOTE LED : Lights when the system operates in the remote control mode from a peripheral via the GPIB.

PRINTER

- ④ PRINT/PLOT key : Prints the on-screen information as it is, to the built-in printer or external plotter.
- ⑤ FEED key : Feeds the print forms approximately 6 cm.

MODE

- ⑥ MONITOR key : Repeats measurement and display by executing averaging (256 times). You can set the measurement conditions in this mode.
- ⑦ AVERAGE key : Executes averaging of data being set by the MONITOR key, 256 to 65536 times.
- ⑧ PAUSE key : Pause averaging and monitor. When this key is pressed again, the averaging and monitor restarts, and continues to end or next pause.

DISTANCE RANGE

- ⑨ SHORT key : Reduces the distance range.
- ⑩ LONG key : Expands the distance range.

Q8460A  
OPTICAL FIBER REFLECTOMETER  
INSTRUCTION MANUAL

2.2 Front Panel

HORIZONTAL SPAN

- ① ZOOM IN : Sets the distance span. If this key is held down, the distance span decreases to allow measurement with the higher resolution.  
[ZOOM IN]
- ② ZOOM OUT : Increases the distance span. (Opposite function to ZOOM IN)  
[ZOOM OUT]
- ③ Measuring mode setup keys (REFLECTION/BACKSCATTER) : Select the measuring mode as follows:  
REFLECTION : Can measure using the Fresnel reflection.  
BACKSCATTER: Can measure using the back scatter.
- ④ PULSE keys : Sets the LD pulse width as follows:  
[WIDE] : Selects the wide pulse width.  
[NARROW] : Selects the narrow pulse width.
- ⑤ VERTICAL SCALE keys : Sets the scale on the vertical axis.  
[EXPAND] : The vertical scale expands.  
[COMPRESS] : The vertical scale compresses.

TRACE

- ⑥ SAVE key (⇐) : Store the measured waveform to an internal memory. (Move the cursor to the left when ADVANCE FUNCTION menu is displayed. Also, this key moves the cursor to the left when STEP of the automatic measurement mode is being displayed.)
- ⑦ VIEW key (⇒) : Display the waveform being measured and the previously saved waveform on-screen simultaneously. (This is called a "DUAL TRACE" function.)  
\* → Execute the DUAL TRACE  
• → Display the waveform being measured (Move the cursor to the right when the ADVANCE FUNCTION menu has been displayed. Also, this key moves the cursor to the right when STEP of the automatic measurement mode is being displayed.)
- ⑧ AUTO key : Selects the automatic measurement mode.
- ⑨ MENU key (LOCAL) : Displays the ADVANCE FUNCTION menu. (Allows key input from the panel when the system is operating in the remote control mode via the GPIB.)

Q8460A  
OPTICAL FIBER REFLECTOMETER  
INSTRUCTION MANUAL

2.2 Front Panel

---

- ⑳ ENTER key : Used to select or execute a function within the WINDOW during the ADVANCE FUNCTION mode.  
(HELP) (This key starts the HELP function in any other mode.) Also, it is used as the ENTER key in the automatic measurement mode.
- ㉑ RAPID key : Switches the operation speed of the data knob (for marker and waveforms movement).  
When this key is pressed, its LED lights to indicate the RAPID mode.
- ㉒ Data knob : Changes data in various operation modes including marker movement, label input and change of waveform display position.
- ㉓ MARKER key : Selects a marker that can be moved by the data knob.

POSITION

- ㉔ VERT key : Moves the waveform display position in the vertical direction.
- ㉕ HORIZ key : Moves the waveform display position in the horizontal direction.
- ㉖ Marker function select key : Selects the STANDARD marker function. The left LED lights to identify the selected function
- ㉗  $\lambda$  key : Selects the measuring wavelength when the dual-band measuring unit is used. This key is not used when single band plug-in modules are used. In such case, the LED of the wavelength of the connected device lights.
- ㉘ OPTICAL OUTPUT connector : The optical fiber cable connector is mounted inside the cover.



Q8460A  
OPTICAL FIBER REFLECTOMETER  
INSTRUCTION MANUAL

2.2 Front Panel

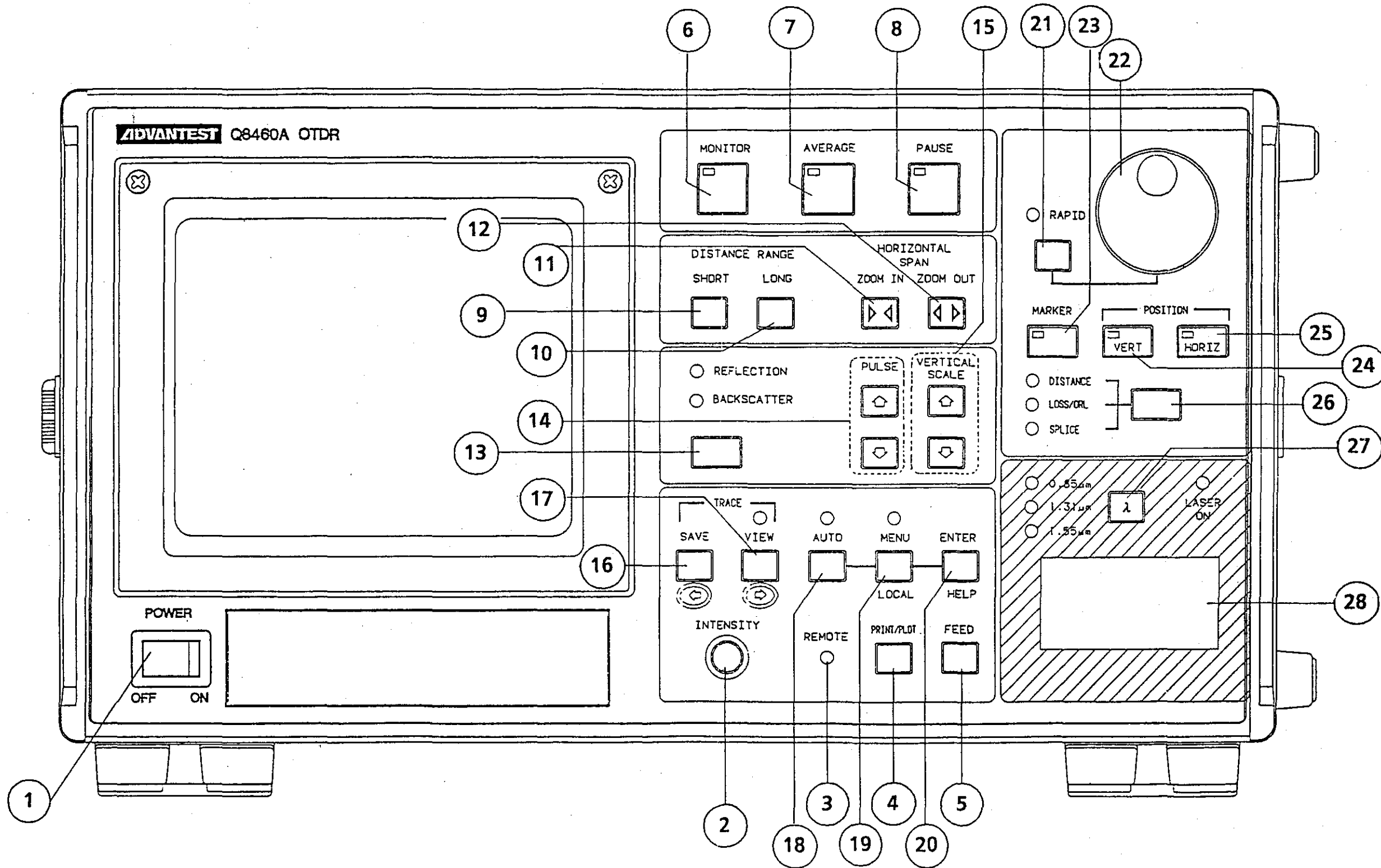

Q8460A  
OPTICAL FIBER REFLECTOMETER  
INSTRUCTION MANUAL

2.3 Rear Panel

---

2.3 Rear Panel

- ① VIDEO OUT connector  
: Outputs composite video signal. Monitor TV or video printer can be connected by using the cable with BNC connector. When making a hard copy of the screen, using a video printer, keep the waveform stable by pressing PAUSE key.
- ② GND terminal
- ③ Power connector
- ④ Fuse holder : When the holder cover is opened, the fuse can be removed. Replace the fuse with an appropriate one. (See the Fuse Replacement Guide table in paragraph (4) of Subsection 1.3.2.)
- ⑤ Fan : The system has the cooling fan to prevent an overheat of internal circuits. Do not prevent air flow of this suction fan.
- ⑥ GPIB connector
- ⑦ Lock for prevention of plug-in movement/damage



Q8460A  
OPTICAL FIBER REFLECTOMETER  
INSTRUCTION MANUAL

2.3 Rear Panel

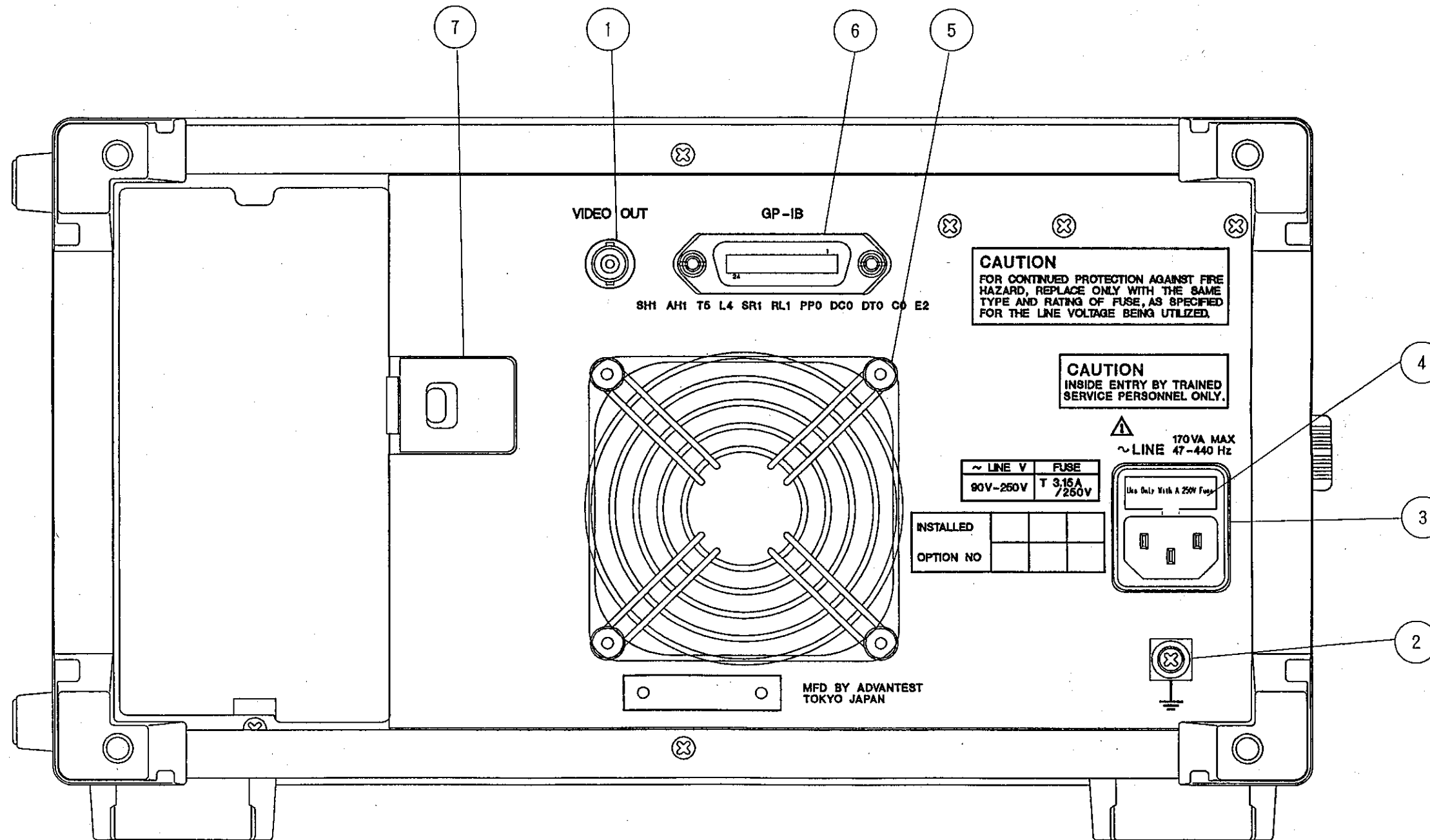

Q8460A  
OPTICAL FIBER REFLECTOMETER  
INSTRUCTION MANUAL

2.4 CRT Display

2.4 CRT Display

The measured data and various setup conditions are displayed on the CRT display screen.

Indicates the display range corresponding to distance range.

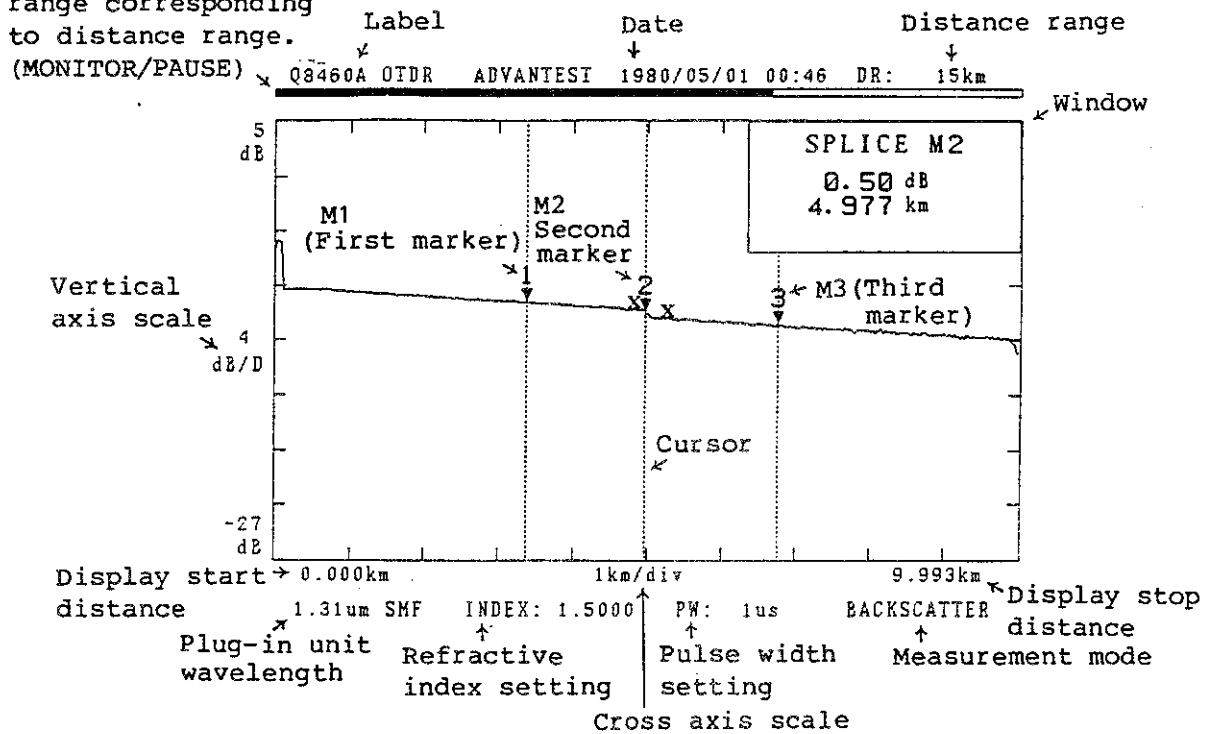

Figure 2 - 1 CRT Display

Q8460A  
OPTICAL FIBER REFLECTOMETER  
INSTRUCTION MANUAL

2.5 What is ADVANCE FUNCTION?

2.5 What is ADVANCE FUNCTION?

The ADVANCE FUNCTION menu has the following parameter items:

- ① DISK
- ② MEMORY
- ③ LABEL
- ④ MASK ON
- ⑤ MASK OFF
- ⑥ AUTO MES (AUTO MEASURE)
- ⑦ BS REFER (BACKSCATTER REFERENCE)
- ⑧ MARKER
- ⑨ I/O
- ⑩ INDEX
- ⑪ AVERAGE
- ⑫ DISPLAY
- ⑬ CLOCK

ADVANCE FUNCTION mode

When the [MENU] key is pressed, the ADVANCE FUNCTION mode is selected and the ADVANCE FUNCTION menu is displayed at the bottom of the display:

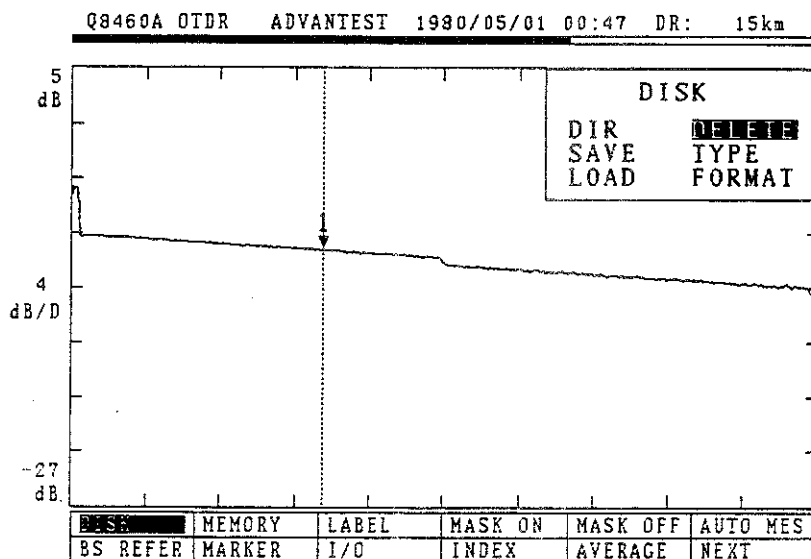

Figure 2 - 2 ADVANCE FUNCTION Screen-1

Q8460A  
OPTICAL FIBER REFLECTOMETER  
INSTRUCTION MANUAL

2.5 What is ADVANCE FUNCTION?

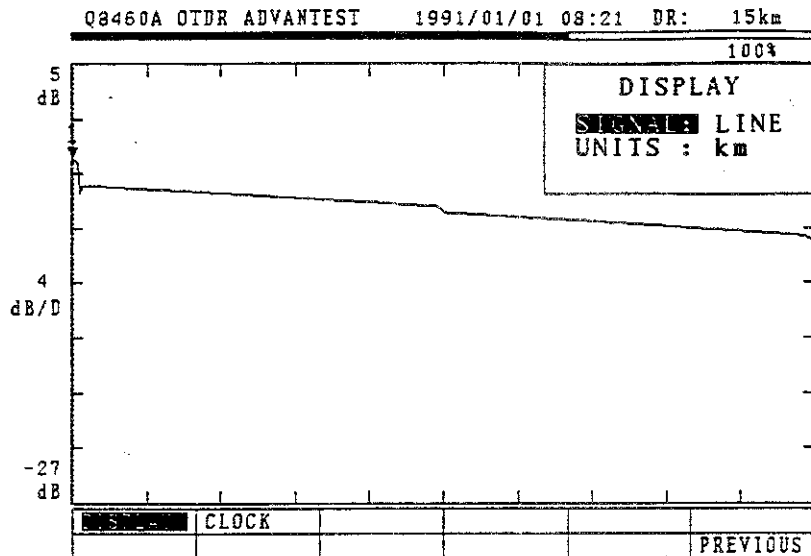

Figure 2 - 2 ADVANCE FUNCTION Screen-2

Function selection

Select the desired functions by pressing the SAVE  
□  
← and VIEW  
□  
→ keys.

The reversed display cursor position shifts when these keys are pressed. The function in the reversed display is selected.

Parameter selection and setup

Locate the reverse display cursor on the desired function and press the [ENTER] key. Change the set value by using the data knob and press the [MENU] key to select it.

Q8460A  
OPTICAL FIBER REFLECTOMETER  
INSTRUCTION MANUAL

2.5 What is ADVANCE FUNCTION?

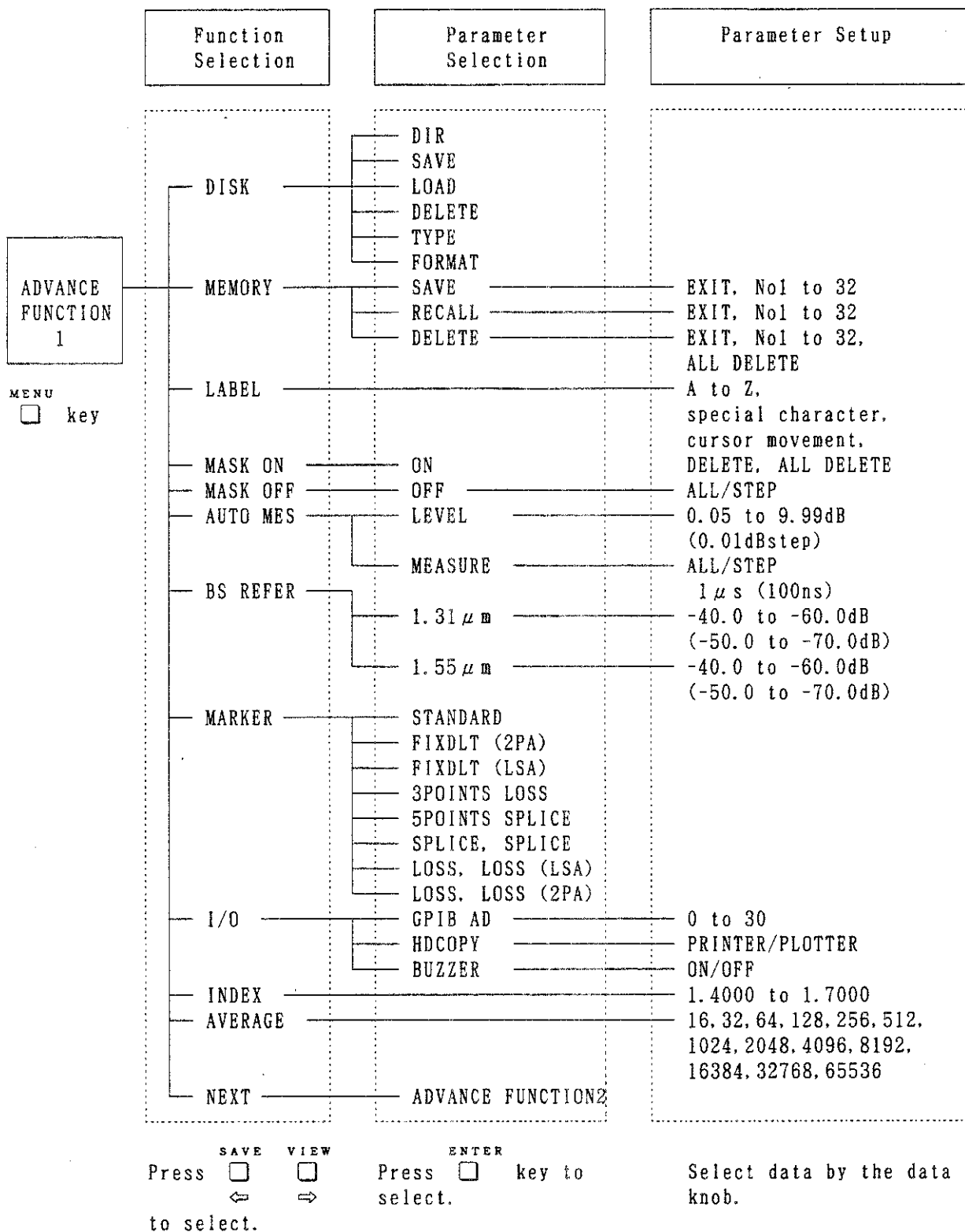

Figure 2 - 3 ADVANCE FUNCTION Menu-1



Q8460A  
OPTICAL FIBER REFLECTOMETER  
INSTRUCTION MANUAL

2.5 What is ADVANCE FUNCTION?

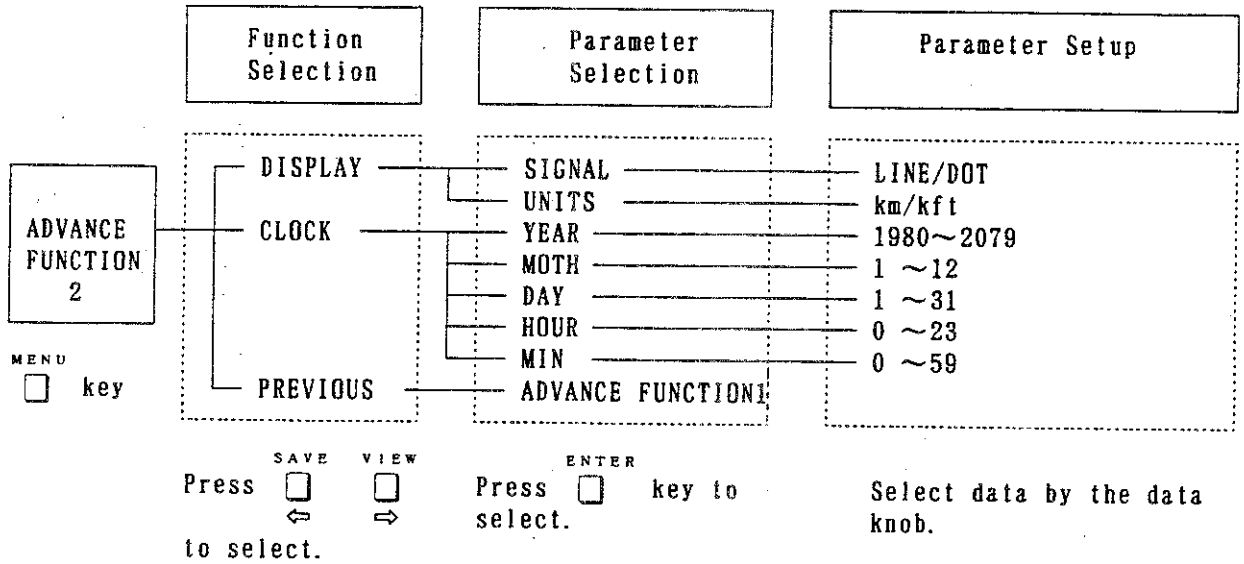

Figure 2 - 3 ADVANCE FUNCTION Menu-2



Q8460A  
OPTICAL FIBER REFLECTOMETER  
INSTRUCTION MANUAL

3.1 Operation Outline

3. OPERATIONS

3.1 Operation Outline

The following illustrates the standard system operation procedure.

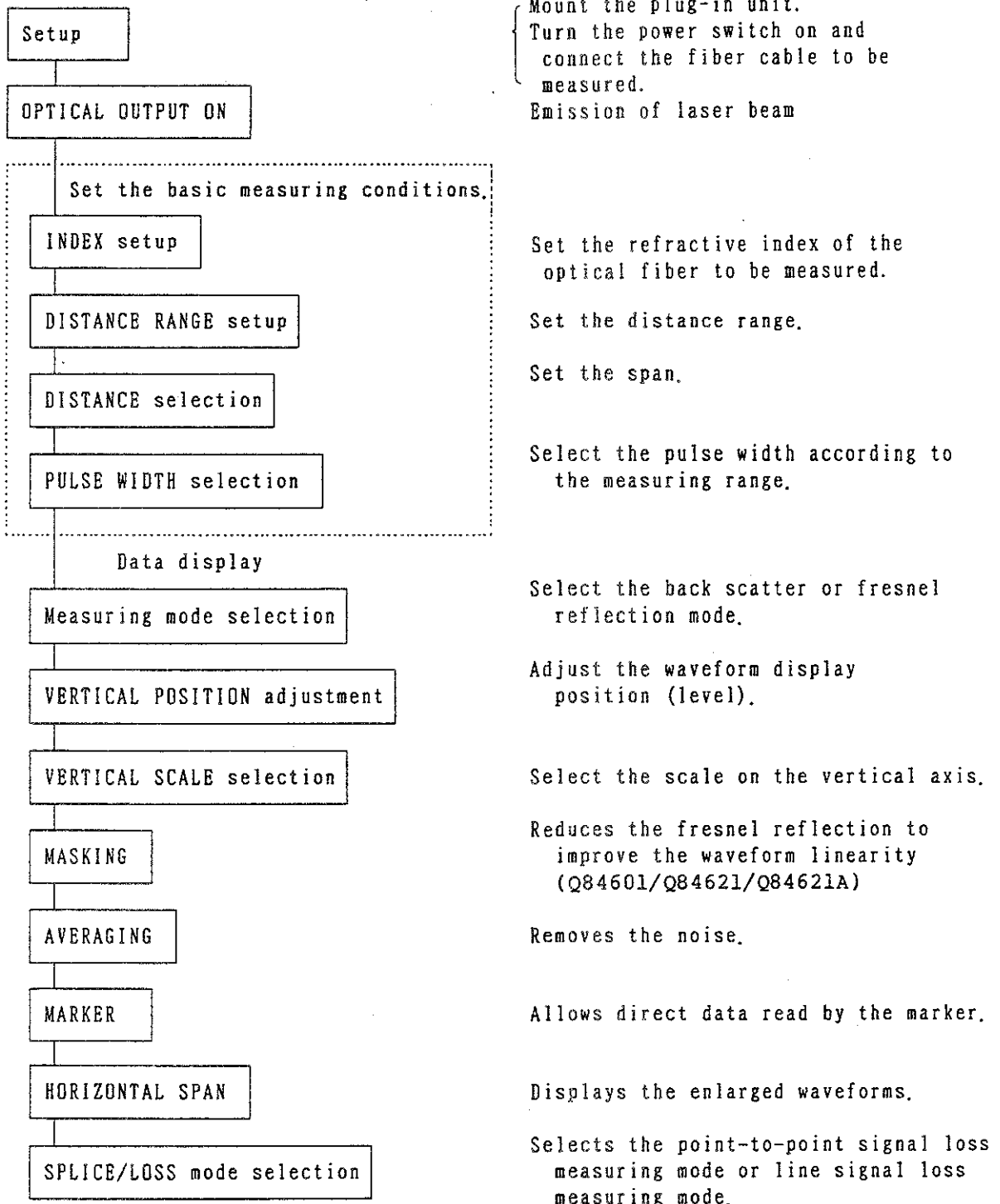

Q8460A  
OPTICAL FIBER REFLECTOMETER  
INSTRUCTION MANUAL

3.2 Setup

(1) Mounting the plug-in unit

Mount the plug-in unit appropriate to the measurement (see Section 1.4).

(2) Power on

The equipment contains a lithium battery that allows the memory to store for about 2 years the user-set conditions existing before the power off sequence.

When you turn the POWER switch on, all LEDs light instantaneously and the last setup conditions (before you have turned it off) are regenerated. However, the following parameter items are initialized:

Item	Initial setting
MONITOR/AVERAGE	MONITOR
PAUSE	ON
VIEW	OFF
MENU	OFF
HELP	OFF
AUTO	OFF

Q8460A  
OPTICAL FIBER REFLECTOMETER  
INSTRUCTION MANUAL

(3) Initial setup

When the system power switch is turned on, all LEDs light on the panel. Press the MENU/LOCAL key and the initial status is set as follows.

To initialize the system from a remote system via the GPIB, send the "z" command to the Q8460A.

Item	Initial setting
DISTANCE RANGE	15km
PULSE WIDTH	100ns
INDEX	1.5000
Measuring mode	BACKSCATTER
LABEL	Q8460A OTDR ADVANTEST
RAPID	OFF
MASK setting	Clear
MEMORY SAVE DATA	Clear
GPIB ADDRESS	11
HDCOPY	PRINTER
DISPLAY SIGNAL	LINE
DISPLAY UNITS	km
AVERAGE repeat count	256
BUZZER	ON
ORL BS REFER LEVEL	-49.0dB (1.31 $\mu$ m) -52.0dB (1.55 $\mu$ m)
AUTO MEASURE LEVEL	STEP 0.50dB
MARKER	STANDARD-DISTANCE
VERTICAL SCALE POSITION	4dB/DIV 0 to -32dB

Q8460A  
OPTICAL FIBER REFLECTOMETER  
INSTRUCTION MANUAL

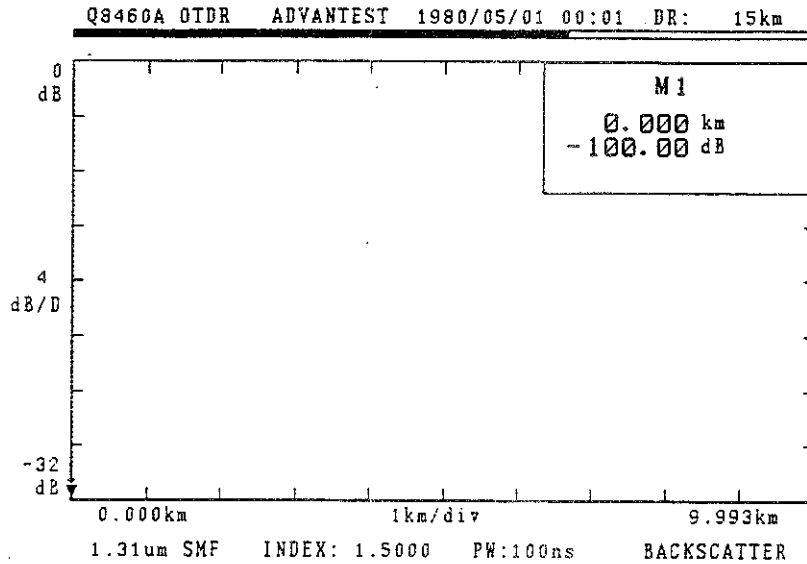
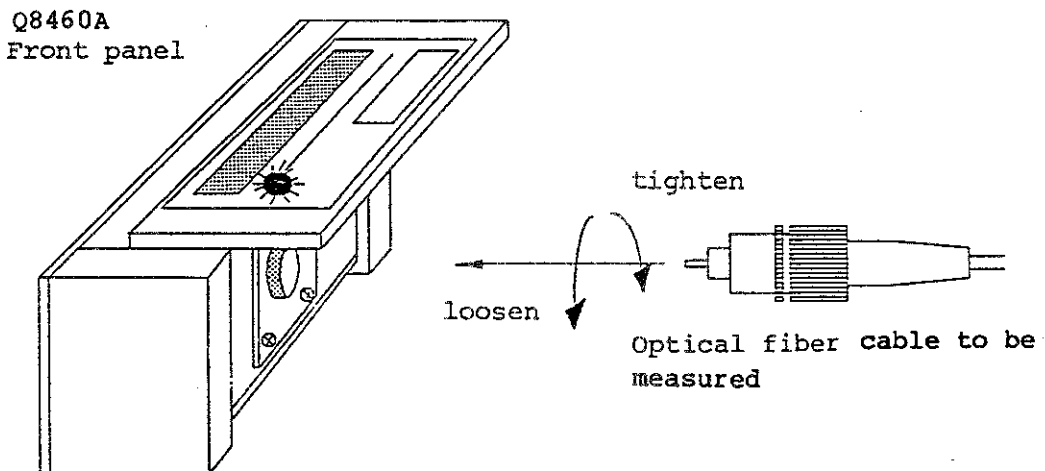

Figure 3 - 1 Initial Setup Screen

(4) Connecting the optical fiber cable to be measured

Securely connect the optical fiber cable to be measured to the OPTICAL OUTPUT connector.



When connecting the optical fiber cable, make sure that the end of the optical fiber cable is clean. If it is dirty, clean it with a solvent.

Q8460A  
OPTICAL FIBER REFLECTOMETER  
INSTRUCTION MANUAL

3.2 Setup

WARNING

The laser beam is emitted from the OPTICAL OUTPUT connector port. Never attempt to see the laser beam with your eyes.

(5) Emission of laser beam



After the optical fiber cable has been plugged into the OPTICAL OUTPUT connector, press the MONITOR or AVERAGE key on the operation panel. And the laser diode beam will be emitted and the measurement will start. The LASER ON LED is kept on to indicate the laser beam emission.

To pause the measurement, press the PAUSE key. When averaging is complete, the measurement terminates and the laser beam emission stops.

Q8460A  
OPTICAL FIBER REFLECTOMETER  
INSTRUCTION MANUAL

3.3 Setting the Measuring Conditions

3.3 Setting the Measuring Conditions

Set the range, index, pulse width and other measuring parameters according to the length of optical fiber cable being measured and the refractive index of the cable core.

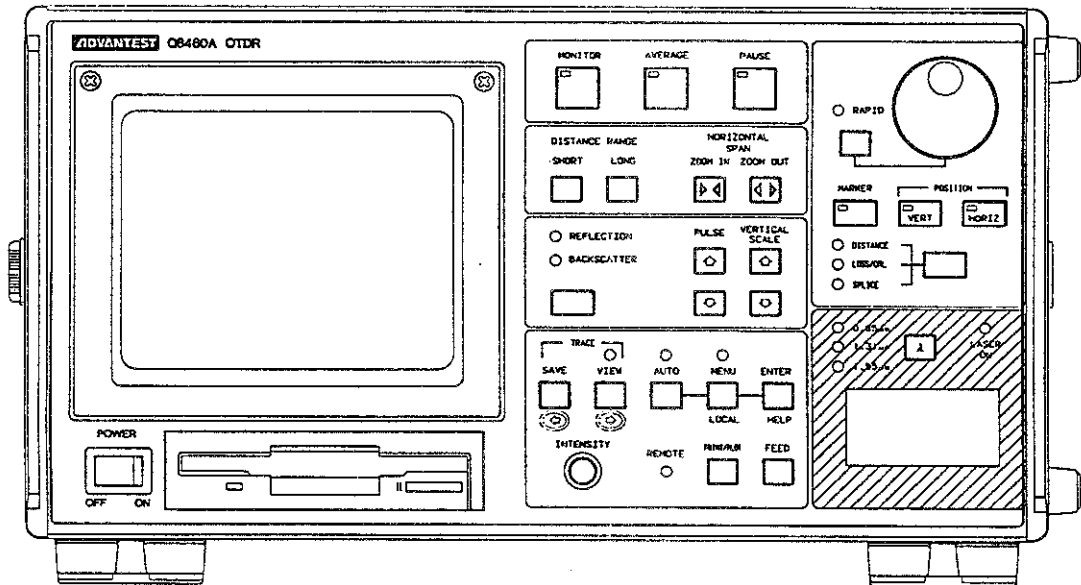

3.3.1 Refractive Index (by ADVANCE FUNCTION)

The Q8460A measures the time (in seconds) of optical pulse transferred via the optical fiber cable and calculates the distance according to the refractive index of the cable core. The user must set the refractive index of the cable core as follows:

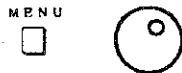

Press the MENU key to select the ADVANCE FUNCTION mode. Select the INDEX by using the SAVE and VIEW keys, and the refractive index will be displayed on the window. Set the desired value by using the data knob and press the MENU key again to enter the refractive index. The refractive index measured from each wavelength is saved in the dual band plug-in unit.



Q8460A  
OPTICAL FIBER REFLECTOMETER  
INSTRUCTION MANUAL

3.3 Setting the Measuring Conditions

3.3.2 Distance Range (It can be set only if the Q8460A is in the monitor mode only, i.e. the monitor LED is on.)

DISTANCE RANGE

SHORT    LONG  
   

Set the distance range by pressing the SHORT and LONG keys. The range changes as follows when these keys are pressed:

1km ↔ 2km ↔ 5km ↔ 15km ↔ 50km ↔ 100km

          SHORT    LONG  
←            →

Select the distance range that is longer than the length of optical fiber cable being measured. The selected range is displayed as the DR (Distance Range) at the right upper end on the screen.

The Q8460A5P plug-in unit does not have the 50km and 100km ranges. The Q8460A5 unit does not have the 100km range.

3.3.3 Pulse Width

PULSE



Set the pulse width according to the measurement being performed. The pulse width changes as follows when the PULSE keys are pressed, and the set value is displayed at the bottom of the screen:

3ns ↔ 20ns ↔ 100ns ↔ 1μs

←            →

The longer the pulse width is, the broader the dynamic range becomes. While this meter can measure the long optical fiber, the spatial resolution drops. Conversely, shortening the pulse width provides higher spatial resolution while the dynamic range is narrowed.

	Pulse width	
	SHORT	LONG
Dynamic range	Low	High
resolution	High	Low

Q8460A  
OPTICAL FIBER REFLECTOMETER  
INSTRUCTION MANUAL

3.3 Setting the Measuring Conditions

---

3.3.4 Measuring Mode (It can be set only if the Q8460A in the monitor mode only i.e. the MONITOR LED is on.)

The system has the BACKSCATTER mode for backscatter measurement and the REFLECTION mode for Fresnel reflection measurement. The REFLECTION mode allows measurement only under a MONITOR status i.e. no averaging is done. Mode selection is impossible during DUAL TRACE execution.

The Q84621A plug-in has the normal BACKSCATTER mode and the four BACKSCATTER modes to be able to measure the optical return loss. All other plug-ins have one backscatter level.

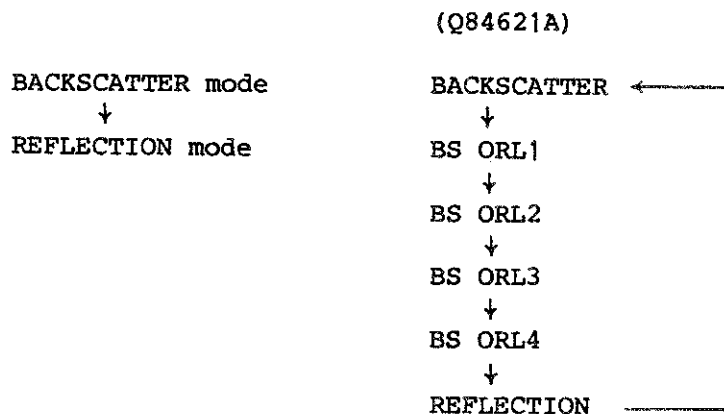

(1) BACKSCATTER mode (for backscatter measurement)

Can measure the signal loss or reflections of optical fiber cable and the signal loss at connectors. The Q84621A is able to measure the optical return loss.

(2) REFLECTION mode (for Fresnel reflection measurement)

Can locate cable discontinuities. As the optical sensitivity is reduced, the input signals are not saturated even when a large amount of Fresnel refraction light is received when compared with the back scatter lights.

However, the back scatter cannot be measured in this mode. No averaging is allowed in this mode.

Q8460A  
OPTICAL FIBER REFLECTOMETER  
INSTRUCTION MANUAL

3.3 Setting the Measuring Conditions

---

3.3.5 Averaging

The measurement in the above subsections has been explained in the MONITOR mode. In the MONITOR mode, data is averaged through  $2^8$  times. If the AVERAGE mode is selected, the measurement noise ratio is improved and longer fiber cables may be measured.

(1) Setting the average number

Press MENU key and select the ADVANCE FUNCTION mode, then select "AVERAGE" on-screen. The operator can select the average number by turning the data knob. The operator can also increase the average number by stopping the average mode even if the mode is in operation. The equipment displays the number which is multiplied with the average number in the monitoring stage.

The time shown at the bottom of the display value is an approximate time to the end of averaging. It may greatly change due to Distance Range and Span setup.

(2) Averaging setup

AVERAGE



: Average data (up to  $2^{24}$  times). Averaging continues until the PAUSE key is pressed or data is averaged  $2^{24}$  times. After averaging, you can increase the number of times and press this key, and the added data will be averaged.

PAUSE



: Pauses averaging. If this key is pressed again, the averaging restarts.

The elapsed time of averaging is displayed on the horizontal frame line of the CRT screen during averaging. When the operator executes the averaging, the horizontal line is gradually filled in with highlight from left to right. And when the highlight reaches the right end, that is, the average number specified in the menu is satisfied, the averaging is completed.

The percent shown at the bottom of the display value is the elapsed time in percent. It ends when the value reaches 100%. The averaging result of the waveforms is displayed every  $2^n$  times ( $n=9, \dots, 16$ ) during averaging.

The display interval increases during averaging.

Q8460A  
OPTICAL FIBER REFLECTOMETER  
INSTRUCTION MANUAL

3.3 Setting the Measuring Conditions

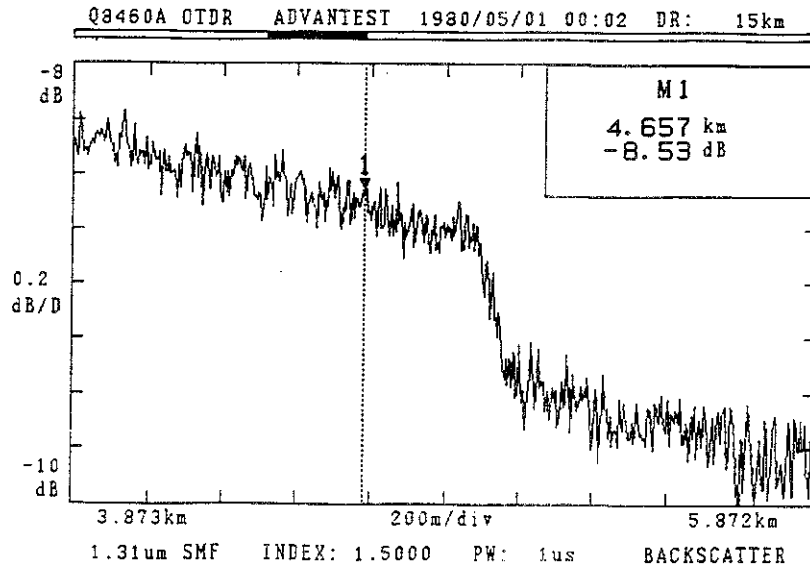

Figure 3 - 2 Before Averaging

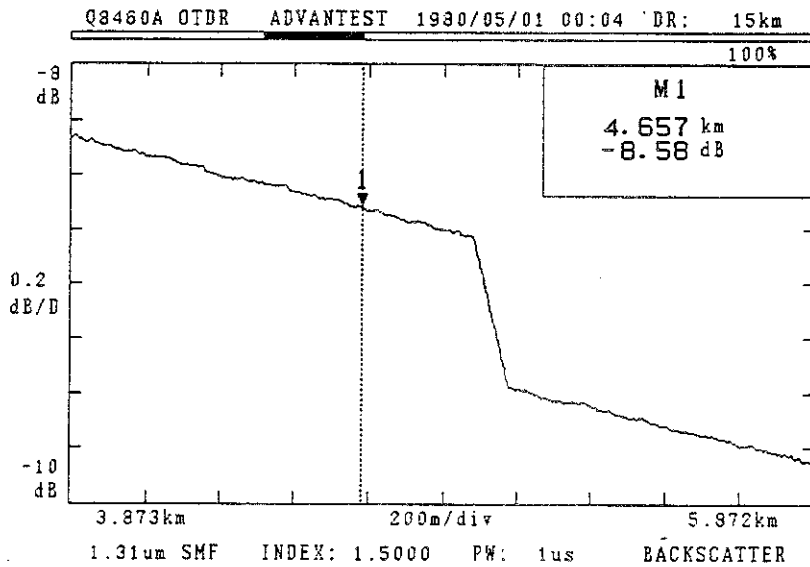
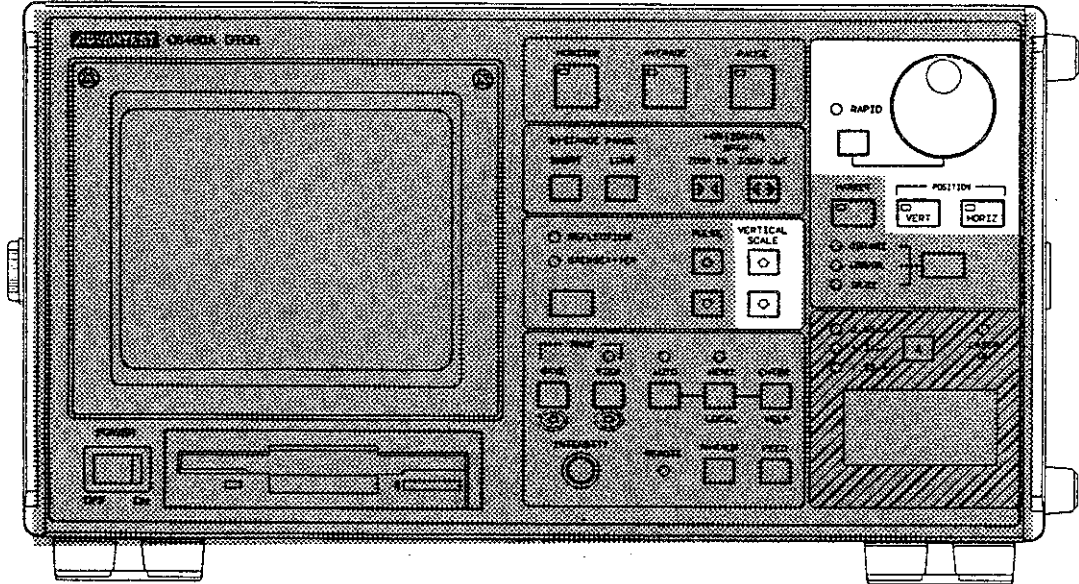

Figure 3 - 3 After Averaging

Q8460A  
OPTICAL FIBER REFLECTOMETER  
INSTRUCTION MANUAL

3.3 Setting the Measuring Conditions

3.3.6 Vertical Scale and Position



(1) Vertical scale setup

When these keys are pressed, the scale of the vertical axis changes as follows:

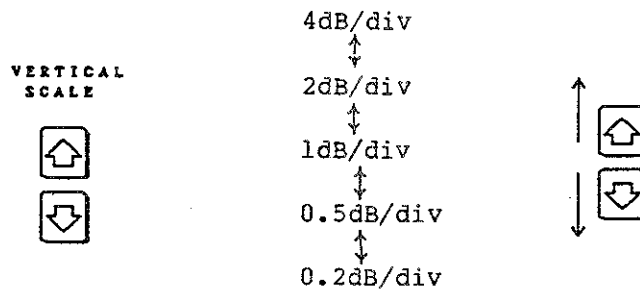

Select an appropriate vertical scale according to the signal loss of optical fiber cable or connection loss.

Q8460A  
OPTICAL FIBER REFLECTOMETER  
INSTRUCTION MANUAL

3.3 Setting the Measuring Conditions

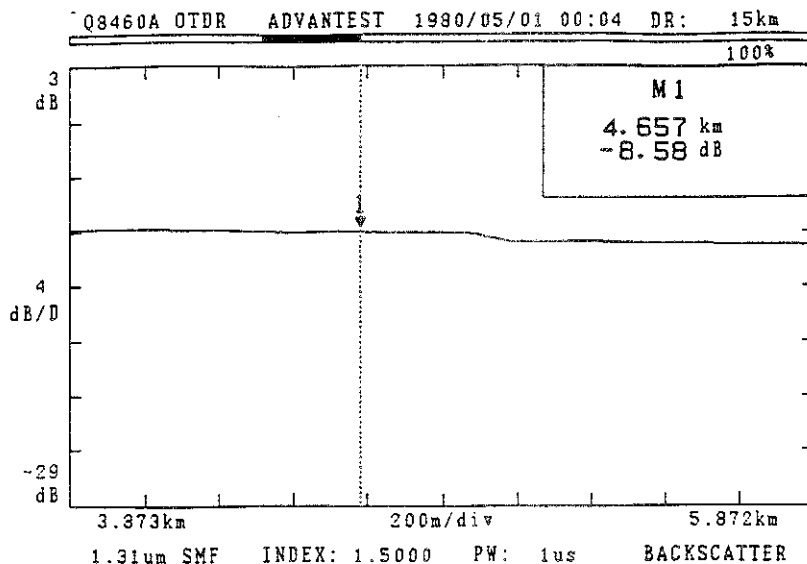

Figure 3 - 4 Before Scale Modification

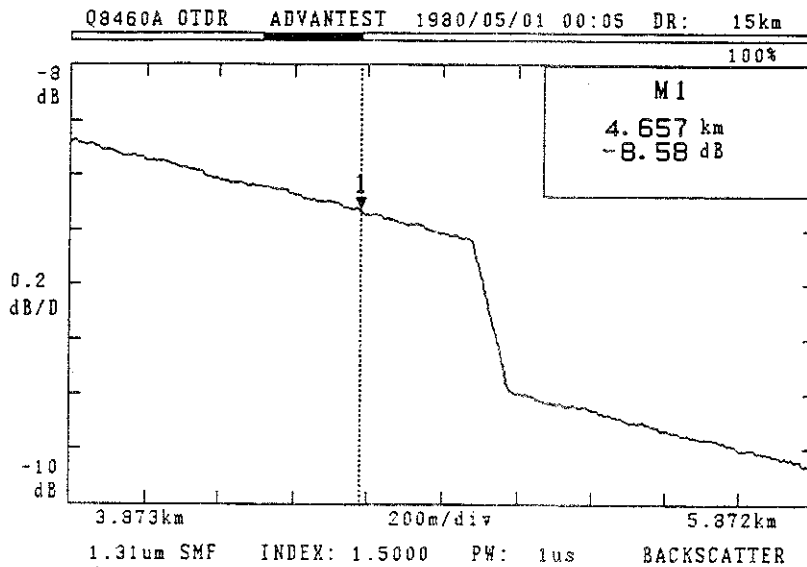
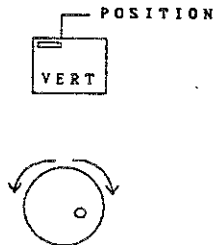

Figure 3 - 5 After Scale Modification

Q8460A  
OPTICAL FIBER REFLECTOMETER  
INSTRUCTION MANUAL

3.3 Setting the Measuring Conditions

(2) Position setup



Press this key and the user can move the waveform in the vertical direction by using the data knob. Rotate the data knob clockwise (CW) to move the waveform upward. Rotate the knob counterclockwise (CCW) to move the waveform downward.

3.3.7 Horizontal Span and Position

(1) Horizontal span setup



Expands or compresses the horizontal span on the screen. The span changes at each step when these keys are pressed in each range. The allowable spans vs. range is displayed in the table below.

Span \ Range	10m	20m	50m	100m	200m	500m	1km	2km	5km	10km	20km	50km	100km
1km	•	•	•	•	•	•	•						
2km	•	•	•	•	•	•	•	•					
5km	•	•	•	•	•	•	•	•	•				
15km	•	•	•	•	•	•	•	•	•	•			
50km	•	•	•	•	•	•	•	•	•	•	•	•	
100km			•	•	•	•	•	•	•	•	•	•	•



The span is expanded or compressed at the center identified by the cursor marker.

(2) Horizontal range setup

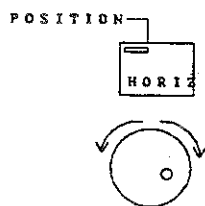

Press the HORIZ key and its LED will light. Now the user can move the horizontal position.

When the dial knob is rotated clockwise (CW), the waveforms are moved away from the output connector. When it is rotated counterclockwise (CCW), the waveforms are moved toward the output connector.

Q8460A  
OPTICAL FIBER REFLECTOMETER  
INSTRUCTION MANUAL

3.3 Setting the Measuring Conditions

(3) Store Expand

When averaging is complete or when the PAUSE key is pressed, the LED of the PAUSE key lights. (It indicates that the waveforms are being stored in memory.) The following range can be expanded during this time.

The waveforms may also be enlarged or compressed during averaging.

Span change area during storage:

When DR is set 1km

		Adjustable span						
		10m	20m	50m	100m	200m	500m	1km
Setting span	10m	← ○	—————→	—————→	—————→	—————→	×	×
	20m	←—————	○	—————→	—————→	—————→	×	×
	50m	×	×	← ○	—————→	—————→	—————→	×
	100m	×	×	×	← ○	—————→	—————→	×
	200m	×	×	×	←—————	○	—————→	×
	500m	×	×	×	×	×	← ○	—————→
	1km	×	×	×	×	×	←—————	○—————→

○ : The span is set under a MONITOR status.

When DR is set 2km

		Adjustable span							
		10m	20m	50m	100m	200m	500m	1km	2km
Setting span	10m	← ○	—————→	—————→	—————→	—————→	×	×	×
	20m	←—————	○	—————→	—————→	—————→	×	×	×
	50m	×	×	← ○	—————→	—————→	—————→	×	×
	100m	×	×	×	← ○	—————→	—————→	—————→	×
	200m	×	×	×	←—————	○	—————→	—————→	×
	500m	×	×	×	×	×	← ○	—————→	—————→
	1km	×	×	×	×	×	←—————	○	—————→
	2km	×	×	×	×	×	←—————	—————→	○—————→



Q8460A  
OPTICAL FIBER REFLECTOMETER  
INSTRUCTION MANUAL

3.3 Setting the Measuring Conditions

When DR is set 5km

		Adjustable span								
		10m	20m	50m	100m	200m	500m	1km	2km	5km
Setting span	10m	← ○					×	×	×	×
	20m	←	○				×	×	×	×
	50m	×	×	← ○			×	×	×	
	100m	×	×	×	← ○			×	×	
	200m	×	×	×	←	○		×	×	
	500m	×	×	×	×	×	← ○			
	1km	×	×	×	×	×	←	○		
	2km	×	×	×	×	×	←		○	
	5km	×	×	×	×	×	×	←		○ →

When DR is set 15km

		Adjustable span									
		10m	20m	50m	100m	200m	500m	1km	2km	5km	10km
Setting span	10m	← ○					×	×	×	×	×
	20m	←	○				×	×	×	×	×
	50m	×	×	← ○			×	×	×	×	
	100m	×	×	×	← ○			×	×	×	
	200m	×	×	×	←	○		×	×	×	
	500m	×	×	×	×	×	← ○				
	1km	×	×	×	×	×	←	○			
	2km	×	×	×	×	×	←		○		
	5km	×	×	×	×	×	×	←		○	
	10km	×	×	×	×	×	×	←			○ →

Q8460A  
OPTICAL FIBER REFLECTOMETER  
INSTRUCTION MANUAL

3.3 Setting the Measuring Conditions

When DR is set 50km.

		Adjustable span											
		10m	20m	50m	100m	200m	500m	1km	2km	5km	10km	20km	50km
Setting span	10m	← ○	→	→	→	→	×	×	×	×	×	×	×
	20m	← ○	→	→	→	→	×	×	×	×	×	×	×
	50m	×	×	← ○	→	→	→	×	×	×	×	×	×
	100m	×	×	×	← ○	→	→	×	×	×	×	×	×
	200m	×	×	×	← ○	→	→	×	×	×	×	×	×
	500m	×	×	×	×	×	← ○	→	→	→	×	×	×
	1km	×	×	×	×	×	← ○	→	→	→	×	×	×
	2km	×	×	×	×	×	← ○	→	→	→	×	×	×
	5km	×	×	×	×	×	×	← ○	→	→	×	×	×
	10km	×	×	×	×	×	×	← ○	→	→	×	×	×
	20km	×	×	×	×	×	×	×	← ●	→ ○	→	→	→
	50km	×	×	×	×	×	×	×	×	← ○	→	→	→ ○

When DR is set 100km.

		Adjustable span										
		50m	100m	200m	500m	1km	2km	5km	10km	20km	50km	100km
Setting span	50m	← ○	→	→	→	×	×	×	×	×	×	×
	100m	×	← ○	→	→	×	×	×	×	×	×	×
	200m	×	← ○	→	→	×	×	×	×	×	×	×
	500m	×	×	×	← ○	→	→	→	×	×	×	×
	1km	×	×	×	← ○	→	→	→	×	×	×	×
	2km	×	×	×	← ○	→	→	→	×	×	×	×
	5km	×	×	×	×	← ○	→	→	×	×	×	×
	10km	×	×	×	×	← ○	→	→	×	×	×	×
	20km	×	×	×	×	×	← ●	→ ○	→	→	×	×
	50km	×	×	×	×	×	×	← ○	→	→	→	→
	100km	×	×	×	×	×	×	← ○	→	→	→	→ ○

● : Adjustable span is 4km.

Q8460A  
OPTICAL FIBER REFLECTOMETER  
INSTRUCTION MANUAL

3.4 Mask Functions (Q84601/Q84621/Q84621A)

3.4 Mask Functions (Q84601/Q84621/Q84621A)

If significant Fresnel reflections occur, the resulting waveform distortion will make accurate measurement impossible. The MASK function can be used to improve the linearity of waveforms by attenuating the Fresnel reflection level being displayed on the CRT. Up to a maximum of 30 MASK points can be set.

3.4.1 MASK Point Setting

(1) Description of the keys to be used and the data knob

Selecting MASK ON from the ADVANCE FUNCTION modes changes the function of the data knob, as well as those of the following keys:

- MARKER  
 key : Changes the assigned function of the data knob to movement of V-markers.
-  Data knob : Moves dedicated V-markers for MASK functions.
- ENTER  
 key : Fixes the MASK point indicated by the V-marker present at the cursor, and then moves the cursor to another V-marker.

(2) MASK-point setting procedure

- ① First, select the BACKSCATTER mode (The BS ORL; to 4 modes are also selected in Q84621A.) under a MONITOR status. This is the minimum requirement for setting MASK points.
- ② Call up MENU on the CRT, and select MASK ON. The MENU will appear as shown below, and the V-marker dedicated to the MASK function appears at the cursor marker position.

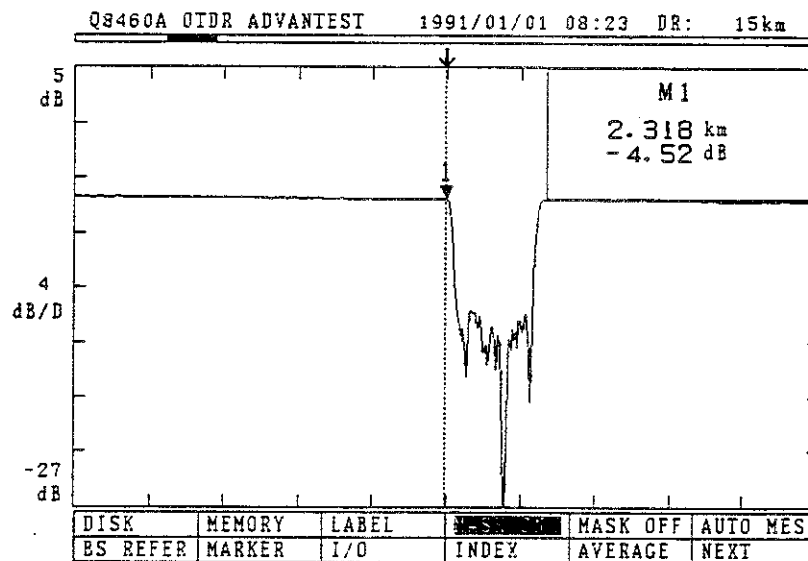

Figure 3 - 6 Display 1 for MASK ON

Q8460A  
OPTICAL FIBER REFLECTOMETER  
INSTRUCTION MANUAL

3.4 Mask Functions (Q84601/Q84621/Q84621A)

- ③ Turn the data knob to move the V-marker. MASK setting will occur along with movement of that V-marker.

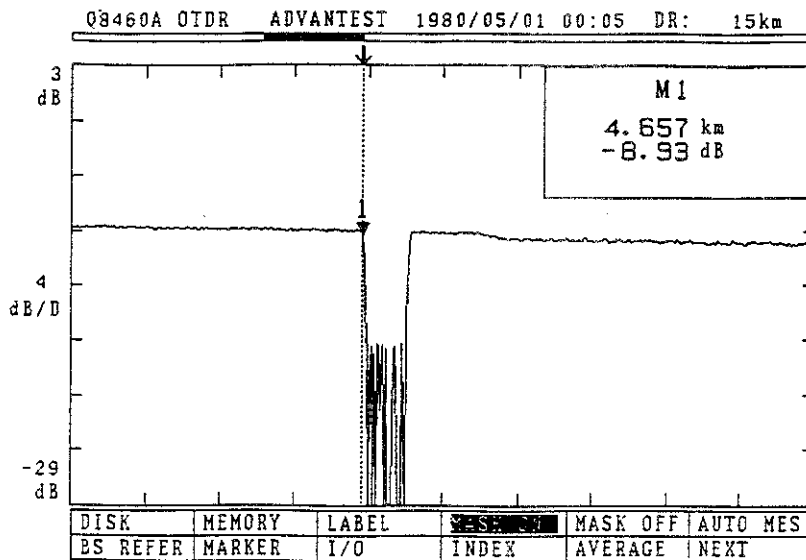

Figure 3 - 7 Display 2 for MASK ON

Q8460A  
OPTICAL FIBER REFLECTOMETER  
INSTRUCTION MANUAL

3.4 Mask Functions (Q84601/Q84621/Q84621A)

- ④ Press the ENTER key to fix the MASK point indicated by the V-marker present at the cursor. Following the fixing operation, the next V-marker will appear at the point what the marker was existent together with the cursor.

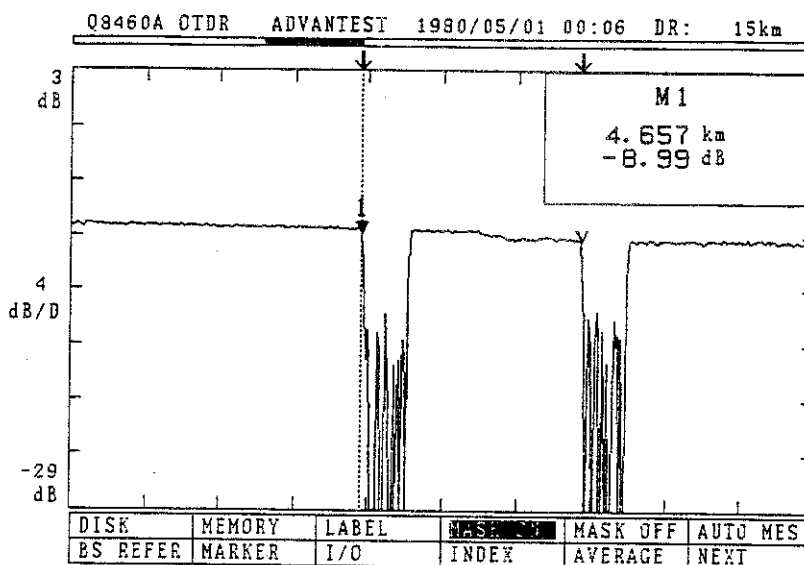

Figure 3 - 8    Display 3 for MASK ON

Q8460A  
OPTICAL FIBER REFLECTOMETER  
INSTRUCTION MANUAL

3.4 Mask Functions (Q84601/Q84621/Q84621A)

- ⑤ Repeating steps ③ and ④ above allows you to set up to a maximum of 30 MASK points.

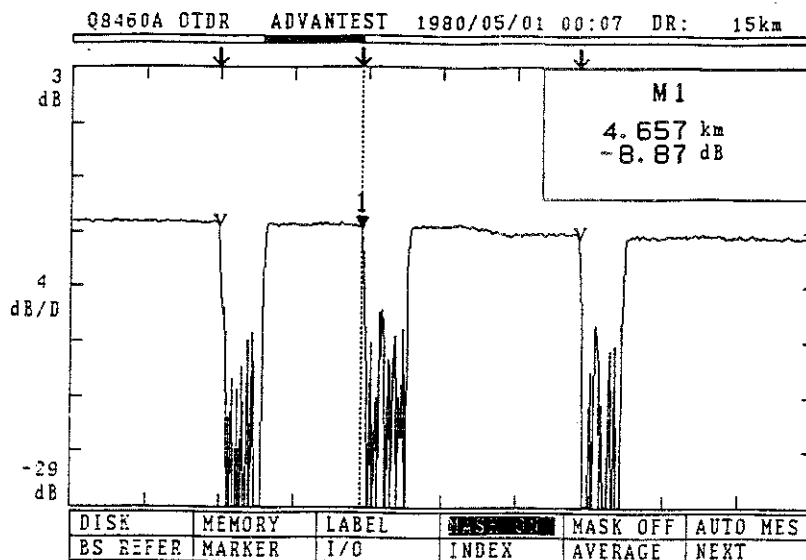

Figure 3 - 9 Display 4 for MASK ON

- ⑥ Pressing the MARKER key in this status allows you to move the cursor to another V-marker. It also allows you to set any MASK point using the data knob.

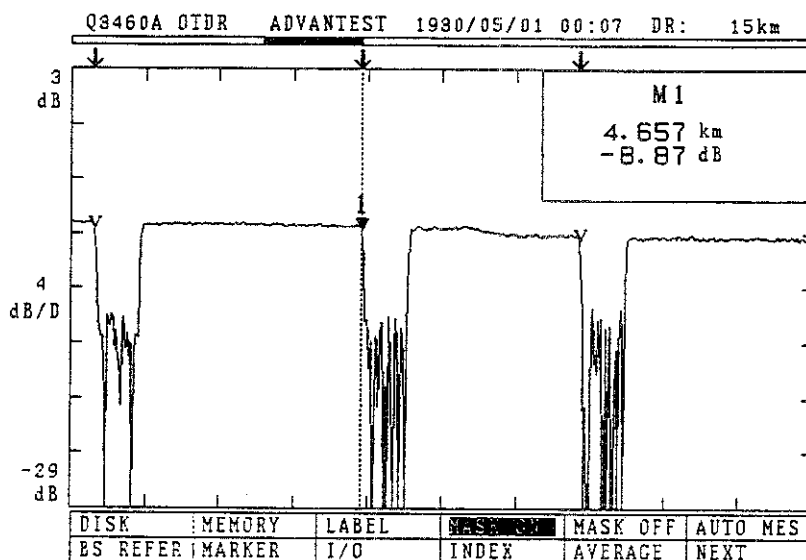

Figure 3 - 10 Display 5 for MASK ON

<NOTE> If the MASK point to be changed is not present on the CRT, call up the intended MASK point on the CRT by changing the HORIZONTAL SPAN or by moving the HORIZONTAL POSITION.

Q8460A  
OPTICAL FIBER REFLECTOMETER  
INSTRUCTION MANUAL

3.4 Mask Functions (Q84601/Q84621/Q84621A)

- ⑦ To return the cursor to the original V-marker position, either clear the display of the MENU or select a mode other than MASK ON and MASK OFF.

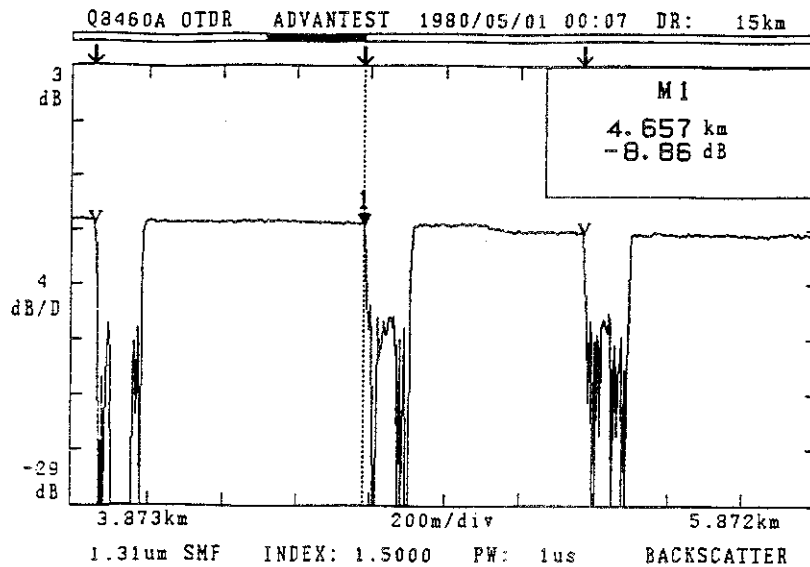

Figure 3 - 11 Display 6 for MASK ON

3.4.2 MASK Point Cancellation

MASK points that have been set are all stored into the memory. To cancel set MASK points, initialize the set data or carry out the MASK OFF operations described below.

(1) Description of the keys to be used

- MARKER**  
 key Used to select the MASK point to be canceled.  
 The cursor moves to the next V-marker each time you press the key.
- ENTER**  
 key Used to cancel the MASK point indicated by the V-marker present at the cursor.

Q8460A  
OPTICAL FIBER REFLECTOMETER  
INSTRUCTION MANUAL

3.4 Mask Functions (Q84601/Q84621/Q84621A)

(2) MASK-point canceling procedure

- ① Call up MENU on the CRT, and select MASK OFF

The MENU will appear as shown below, together with the cursor at the final V-marker that was actuated.

Select STEP or ALL by the knob.

-STEP: Select MASK to have been set for every point and cancel.

-ALL: Cancel the all MASK points to have been set.

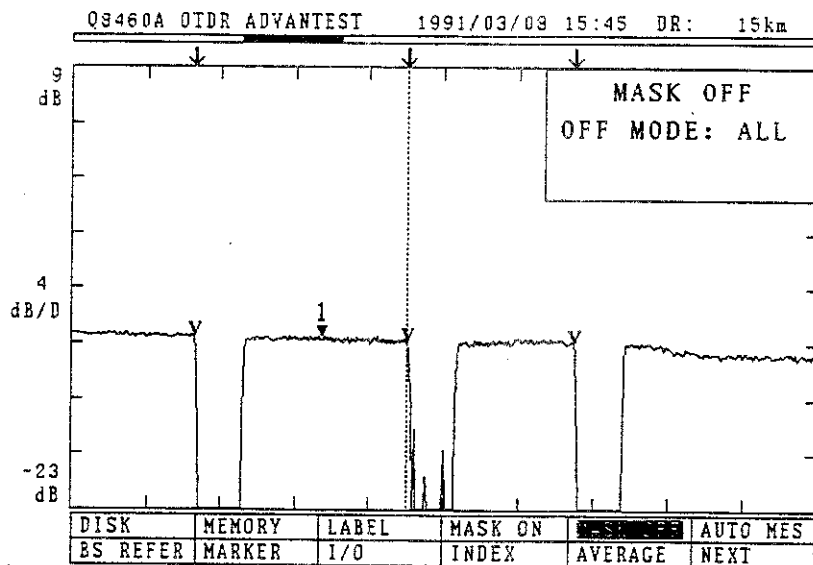

Figure 3 - 12 Display 1 for MASK OFF

- <NOTE 1> If you do not want to cancel MASK points under the MASK OFF status of the MENU, do not press the ENTER key; instead, set the MENU to a mode other than MASK OFF. Set MASK points once again if you have pressed the ENTER key to cancel any.
- <NOTE 2> If the final V-marker that was actuated is not present on the CRT, the cursor will not be displayed. In such a case, either call up the final V-marker on the CRT by carrying out the required operations (see Figure 3-10), or call up the cursor at the V-marker on the CRT by pressing the MARKER key once or twice.
- <NOTE 3> If you cancel, set under a MONITOR status. You cannot cancel under a pose average status.



Q8460A  
OPTICAL FIBER REFLECTOMETER  
INSTRUCTION MANUAL

3.4 Mask Functions (Q84601/Q84621/Q84621A)

② If STEP is canceled

Press the MARKER key and move the cursor to the V-marker indicating the MASK point you want to cancel. Then, select that V-marker and press the ENTER key. The V-marker corresponding to the MASK point at which the cursor was present will then be cleared and that MASK point will be canceled. At the same time, the cursor will move to the next V-marker.

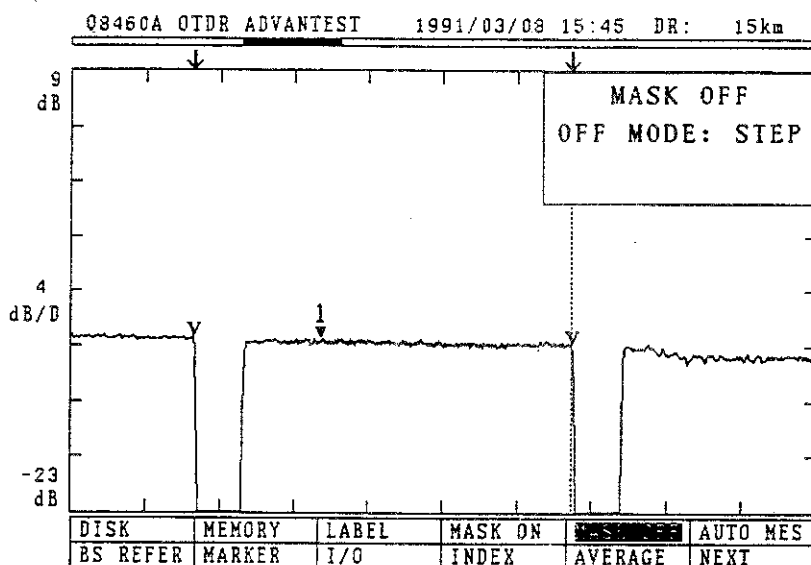

Figure 3 - 13 Display 2 for MASK OFF

<NOTE> Only the MASK points being displayed on the CRT can be canceled. If the MASK point to be canceled is not present on the CRT, escape from ADVANCE MENU once and call up that MASK point on the CRT by changing the HORIZONTAL SPAN or by moving the HORIZONTAL POSITION.

③ If ALL is canceled

Press the ENTER key. The all MASK points to have been set are canceled.

Q8460A  
OPTICAL FIBER REFLECTOMETER  
INSTRUCTION MANUAL

3.4 Mask Functions (Q84601/Q84621/Q84621A)

- ④ If all MASK points are canceled using procedural step ② or ③ previous, the cursor will move to the usual marker position.

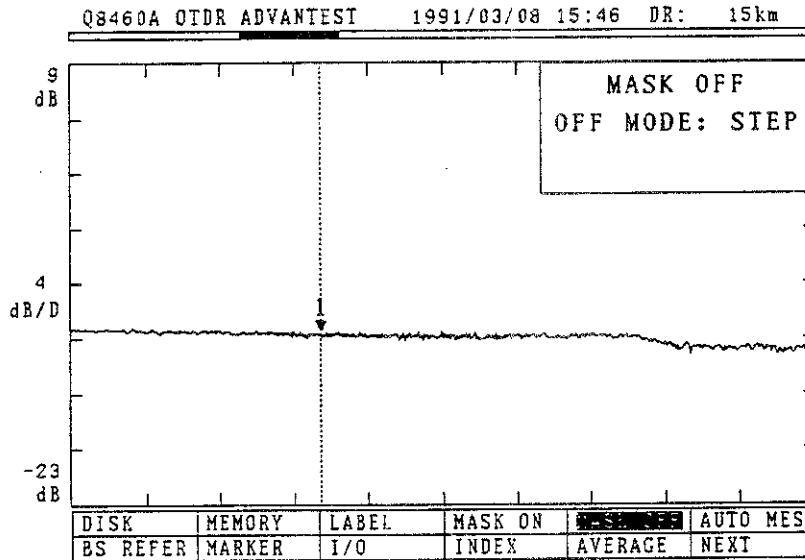

Figure 3 - 14    Display 3 for MASK OFF

Q8460A  
OPTICAL FIBER REFLECTOMETER  
INSTRUCTION MANUAL

3.5 Marker Functions (In ADVANCE FUNCTION Mode)

---

3.5 Marker Functions (In ADVANCE FUNCTION Mode)

3.5.1 Marker Types

The following shows the marker functions that can be selected on the ADVANCE FUNCTION menu.

(1) During the BACKSCATTER mode the following may be selected

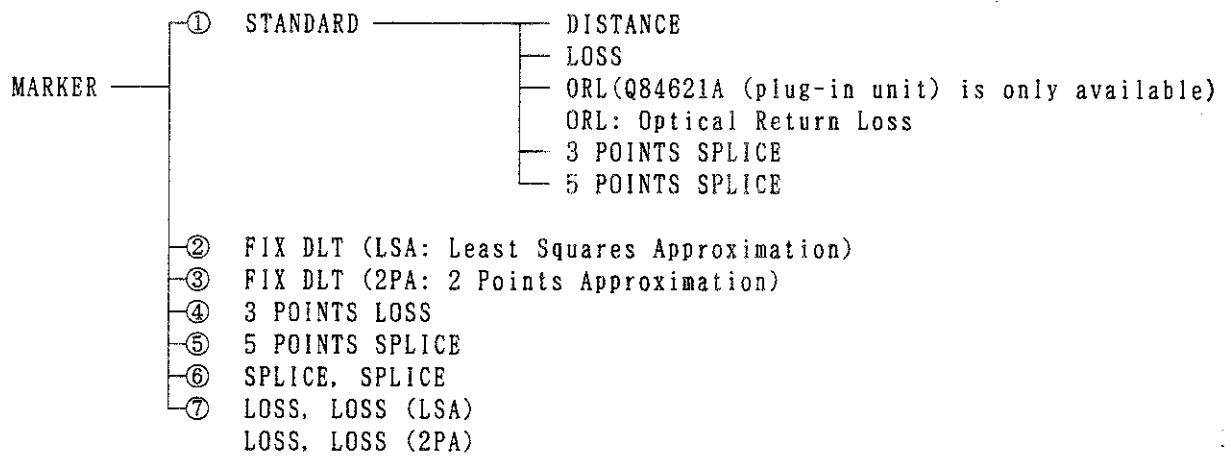

(2) During the REFLECTION mode the following may be selected

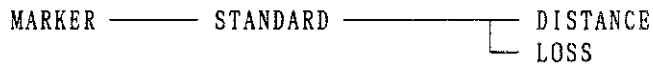

Q8460A  
OPTICAL FIBER REFLECTOMETER  
INSTRUCTION MANUAL

3.5 Marker Functions (In ADVANCE FUNCTION Mode)

3.5.2 Selecting the Marker Functions

- MENU  Press the MENU key to select the ADVANCE FUNCTION mode.
- Locate the reverse display cursor onto the MARKER by using the SAVE, VIEW keys. When the marker menu appears at the right upper end of the screen, locate the reverse display cursor onto the desired marker menu by using the ENTER key. Then, press the MENU key to select the reverse display marker.

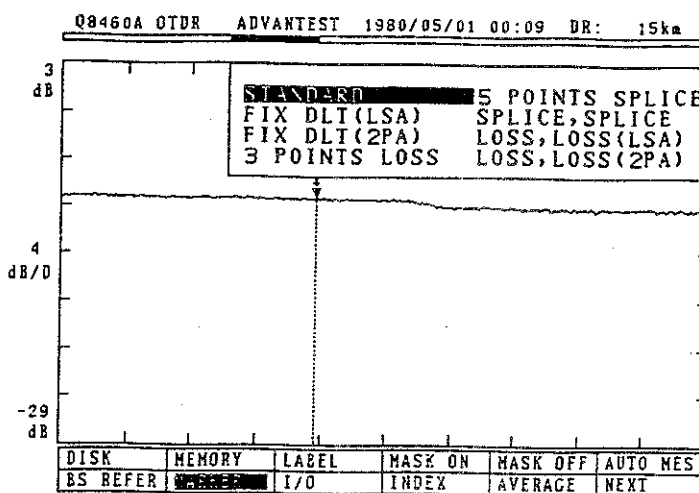

Figure 3 - 15 Marker Menu

Q8460A  
OPTICAL FIBER REFLECTOMETER  
INSTRUCTION MANUAL

3.5 Marker Functions (In ADVANCE FUNCTION Mode)

3.5.3 Function of Each Marker

- ① The STANDARD marker has 3 functions of DISTANCE, LOSS and SPLICE. Select one of them by using key (27) on the front panel (explains in the Section 2.2).  
The selected function is identified by the LED.  
Also, the LOSS option provides the ORL (Optical Return Loss) function that can be used on the Q84621A plug-in unit only.

- DISTANCE (M1) : The M1 marker is displayed on the screen. The distance (km) between the output end and M1 and the level (dB) can be measured.
- LOSS (M1,M2) : The M1 and M2 markers are displayed on the screen. The signal level difference between M1 and M2, the distance (km) between M1 and M2, and the signal loss per kilometer (dB/km) between M1 and M2 can be measured.
- ORL (M1, M2) : The M1 and M2 markers are displayed on the screen. You can measure the ORL value, signal level difference (dB) between M1 and M2, and reference level of back-scattered light. Refer to the ORL function setup and measurement procedure (explains in the Subsection 3.5.4). The principle of ORL is explained in APPENDIX.

3 POINTS SPLICE: The M1, M2 and M3 markers are displayed on the screen. The connection loss due to jumper or connector can be measured by using these 3 markers. The following explains the measurement procedure.

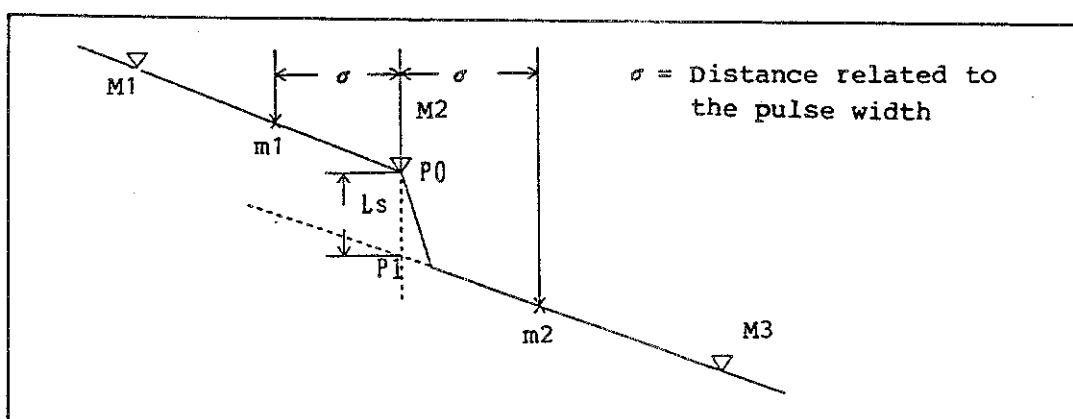

- As shown in the figure, set the M2 marker to the splice change point. Then, set the M1 and M3 markers in any two points of the optical fiber cable so that the M2 marker is located between them.

Q8460A  
OPTICAL FIBER REFLECTOMETER  
INSTRUCTION MANUAL

3.5 Marker Functions (In ADVANCE FUNCTION Mode)

---

- To execute the calculation through least square approximation, the "m1" and "m2" points are set in the same distance of " $\sigma$ " from the M2 marker position.  
On the CRT, both m1 and m2 are displayed as X.
- From the distance data between M1 and m1 and between m2 and M3, the intersection point to the approximate value is set as P1. The level difference between P0 and P1 is set as the splice loss.
- After M3 is set, pressing Marker key displays cursors for each marker of M1, M2 and M3. Markers can be moved with their interval fixed.

NOTE

The points are set in distance " $\sigma$ " from M2 because the Fresnel reflection may occur at the M2 point or the splice loss may be affected by the pulse width or frequency characteristics of optical photosensor amp.  
If the approximate value line is determined near the M2 point, an excessive error may result.  
Similar to the LOSS mode, take care not to cause the Fresnel reflection or splice loss between M1 and m1 and between M3 and m2 during marker setup.

**5 POINTS SPLICE:** Similar to the 3 POINTS SPLICE of STANDARD MARKER, (M1, M2, M3, M4, M5) the splice loss can be measured. In this mode, however, "m1" and "m2" are set manually rather than automatically.  
A reflection due to use of connectors may cause the distortion of back scatter waveform immediately after the connector position. In such case, "m1" and "m2" should be set manually to eliminate a chance of reflection affecting measurement. Reliable measurement can be made using 5 point splice.

Q8460A  
OPTICAL FIBER REFLECTOMETER  
INSTRUCTION MANUAL

3.5 Marker Functions (In ADVANCE FUNCTION Mode)

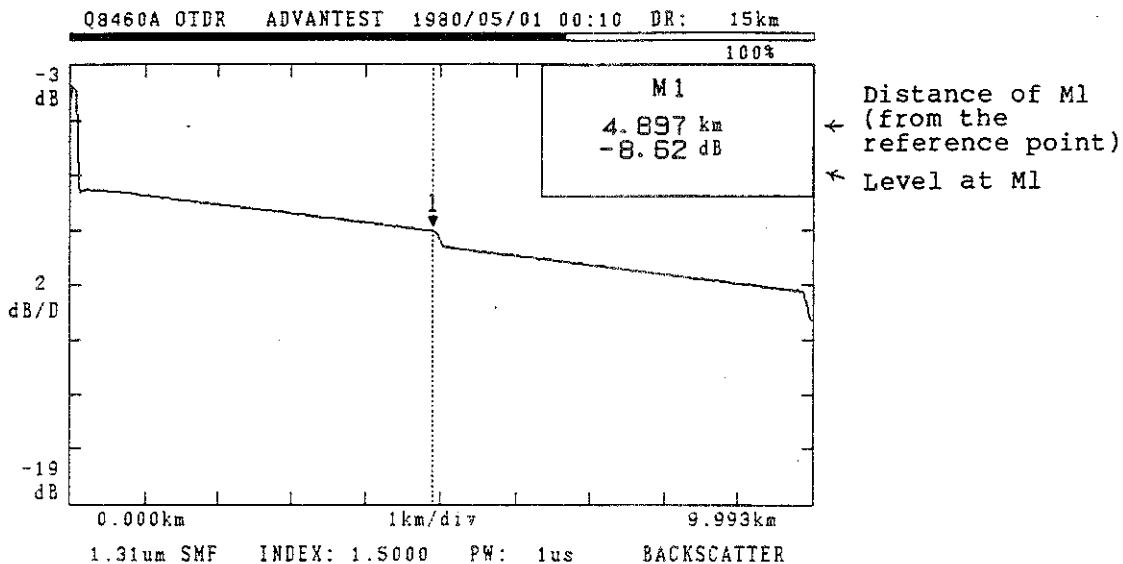

Figure 3 - 16 Measurement Display of Distance

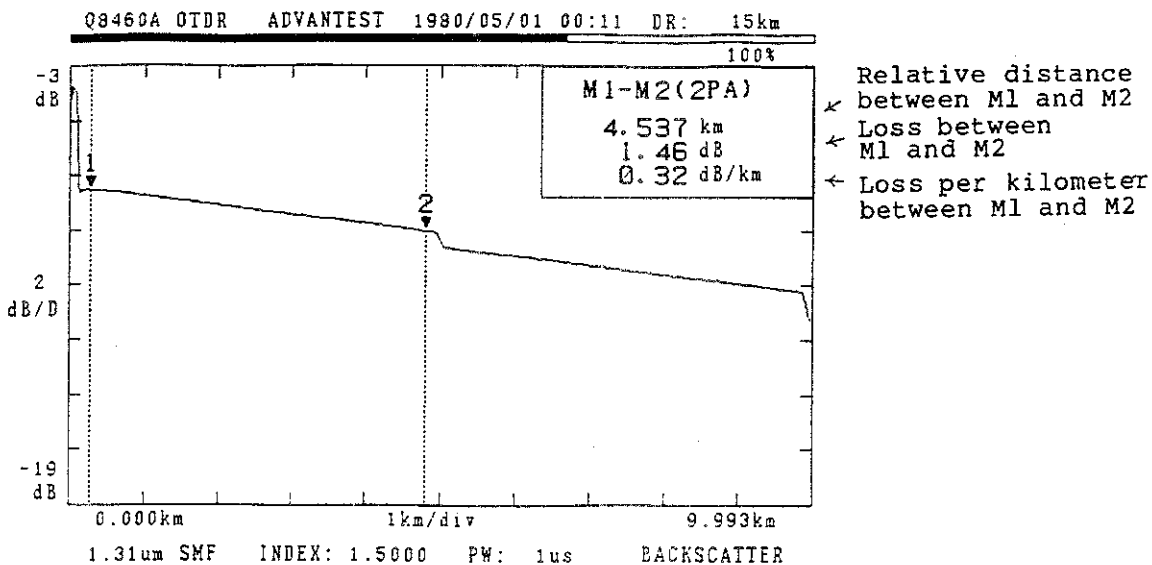

Figure 3 - 17 Measurement Display of Loss

Q8460A  
OPTICAL FIBER REFLECTOMETER  
INSTRUCTION MANUAL

3.5 Marker Functions (In ADVANCE FUNCTION Mode)

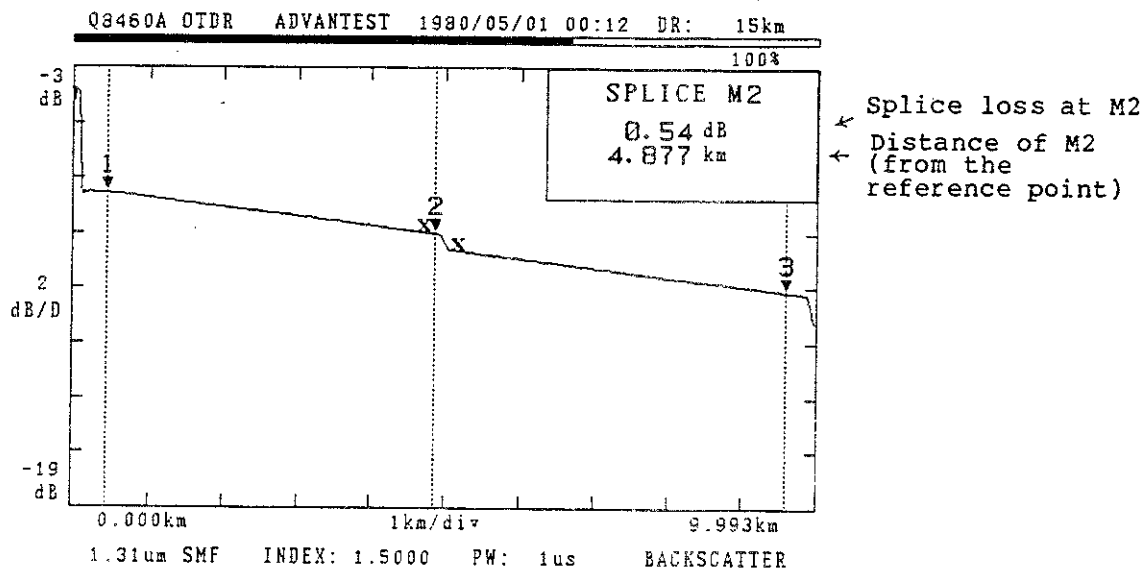

Figure 3 - 18 Measurement Display of STANDARD 3 POINTS SPLICE

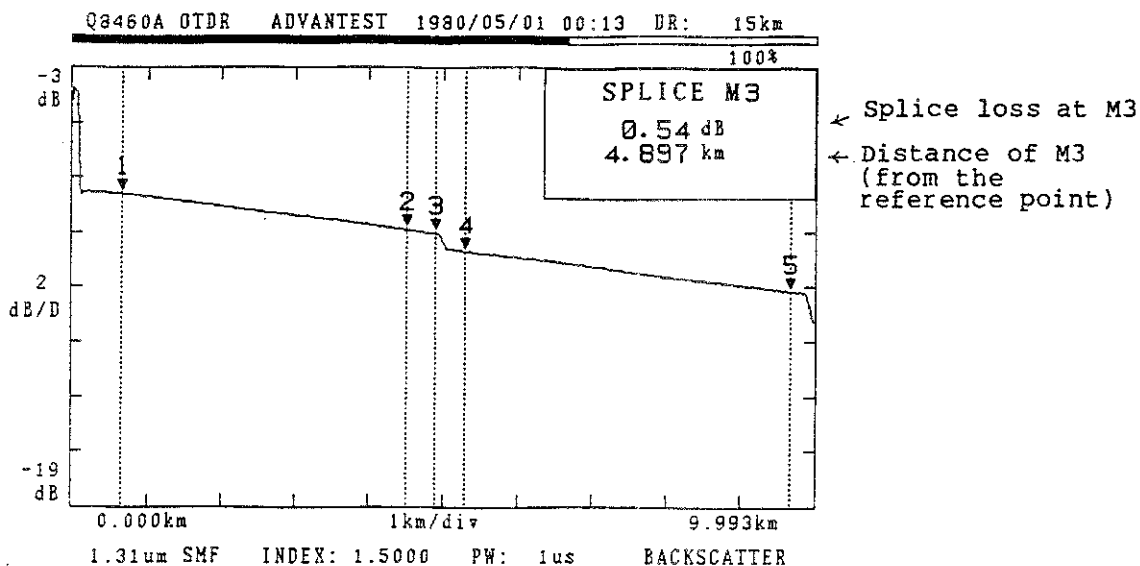

Figure 3 - 19 Measurement Display of STADARD 5 POINTS SPLICE



Q8460A  
OPTICAL FIBER REFLECTOMETER  
INSTRUCTION MANUAL

3.5 Marker Functions (In ADVANCE FUNCTION Mode)

② FIX DLT (LSA)

The fixed distance between M1 and M2 is kept and loss per kilometer between M1 and M2 can be measured by LSA (Least Square Approximation).

Set the M1 and M2 markers are follows:

- (a) Press the MARKER key in the FIX DLT mode, and the M1 marker can be moved.
- (b) Press the MARKER key again to move the M2 marker. Set the desired distance between the M1 and M2 markers.
- (c) Press the MARKER key again to fix the distance between M1 and M2 markers. Rotate the data knob to move the M1 and M2 markers simultaneously by keeping the fixed distance between them.

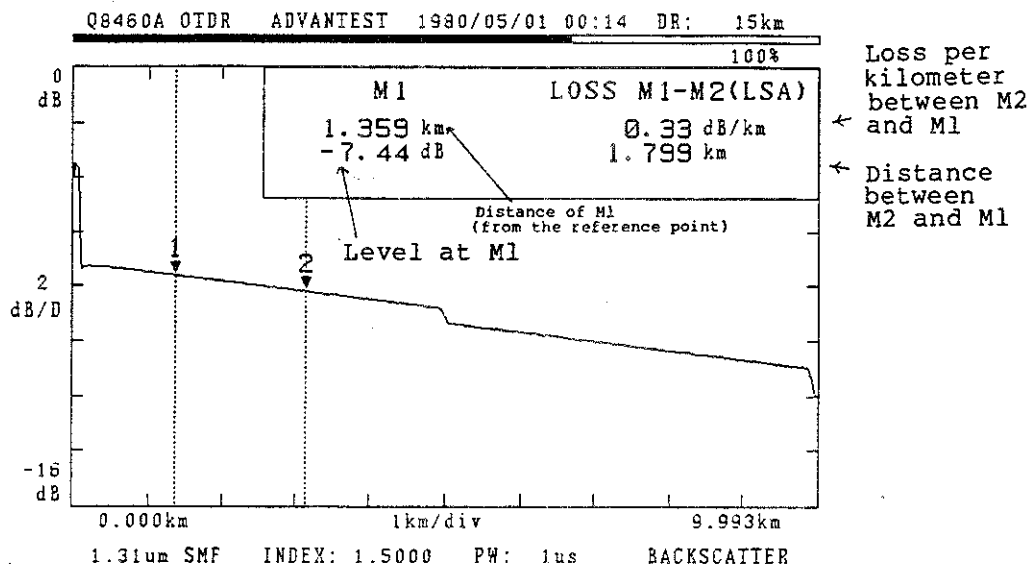

Figure 3 - 20 Measurement Display of FIX DLT (LSA)

Q8460A  
OPTICAL FIBER REFLECTOMETER  
INSTRUCTION MANUAL

3.5 Marker Functions (In ADVANCE FUNCTION Mode)

③ FIX DLT (2PA)

The fixed distance between M1 and M2 is kept and the level difference between M1 and M2 can be measured.

Set the M1 and M2 markers are follows:

- (a) Press the MARKER key in the FIX DLT mode, and the M1 marker can be moved.
- (b) Press the MARKER key again to move the M2 marker. Set the desired distance between the M1 and M2 markers.
- (c) Press the MARKER key again to fix the distance between M1 and M2 markers. Rotate the data knob to move the M1 and M2 markers simultaneously by keeping the fixed distance between them.

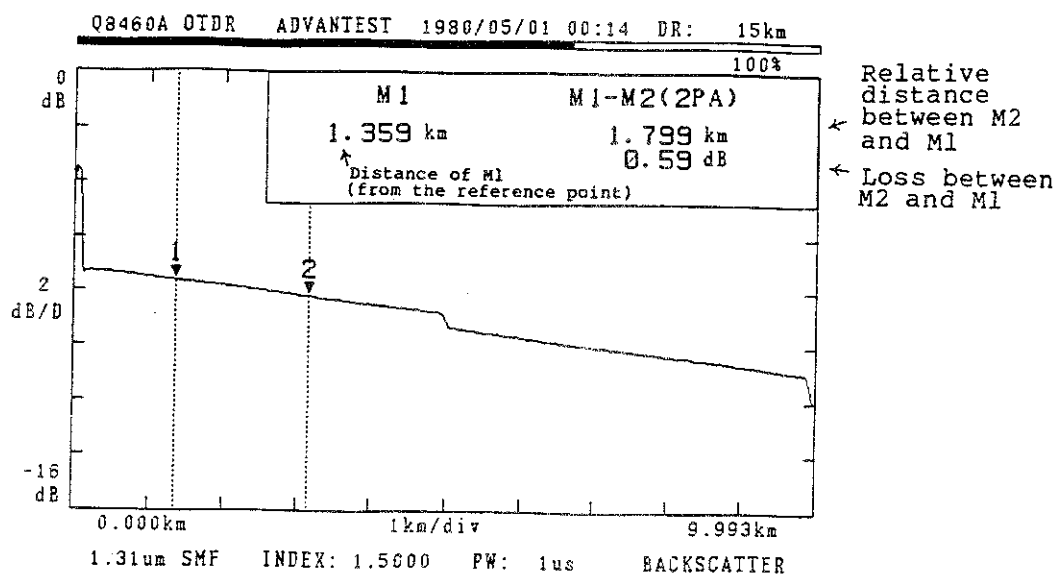

Figure 3 - 21 Measurement Display of FIX DLT (2PA)

Q8460A  
OPTICAL FIBER REFLECTOMETER  
INSTRUCTION MANUAL

3.5 Marker Functions (In ADVANCE FUNCTION Mode)

④ 3 POINTS LOSS

Set the M2 and M3 markers at two points on the optical fiber cable being measured. The data between these two points are used and the approximate linear is determined through LSA.

The loss is displayed on the screen. When the M1 marker is used, the distance of the measured optical fiber from the optical output port can be determined.

The total loss between M1 and M3 can also be measured.

The following values are displayed:

- (a) Distance between M1 and M3
- (b) Loss between M1 and M3
- (c) Loss per kilometer between M2 and M3

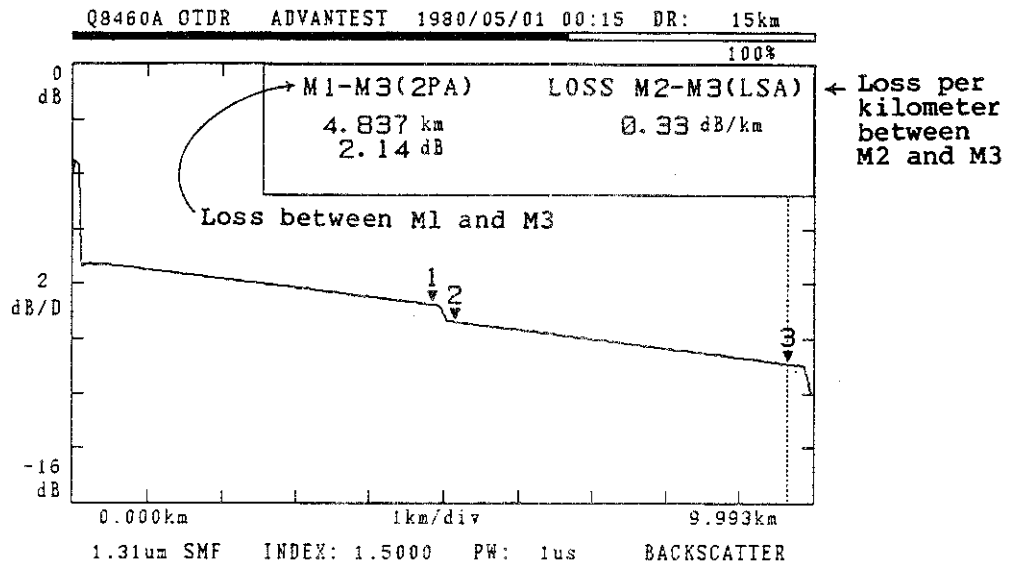

Figure 3 - 22 Measurement Display of 3 POINTS LOSS

NOTE

Take care not to cause a Fresnel reflection between M2 and M3. An error may result in the linear approximation.

Q8460A  
OPTICAL FIBER REFLECTOMETER  
INSTRUCTION MANUAL

3.5 Marker Functions (In ADVANCE FUNCTION Mode)

⑤ 5 POINTS SPLICE

Similar to the 3 POINTS SPLICE of STANDARD MARKER, the splice loss can be measured. In this mode, however, "m1" and "m2" can be set manually rather than automatically.

A reflection due to use of connectors may cause the distortion of back scatter waveforms immediately after the connector position. In such case, "m1" and "m2" should be set manually to eliminate a chance of reflection. The reliable measurement can be made.

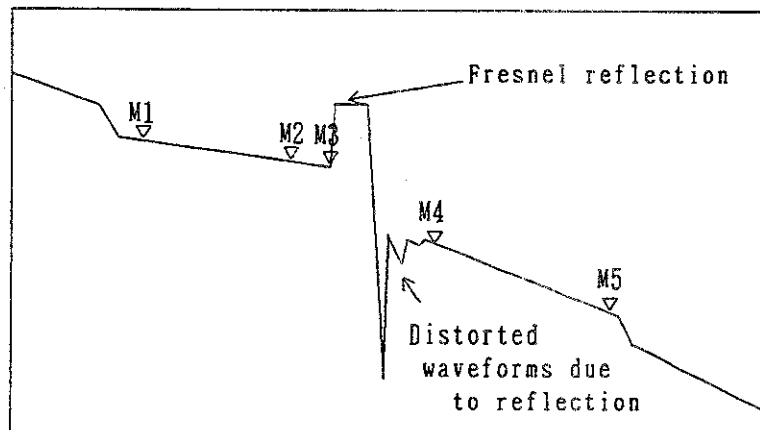

Data between M1 and M2 and between M4 and M5 are used for linear approximation through LSA. Set the M1, M2, M4 and M5 markers to prevent a splice or waveform distortion. M3 is the splice (connector) position.

When these points are set, the data between M1 and M2 is used to determine the approximate loss line of optical fiber cable prior to splice. And data between M4 and M5 is used to determine the approximate loss line of the cable. After the splice the difference between these two lines at point M3 is displayed as the splice loss. The following values are displayed:

- (a) Distance of M3 (km)
- (b) Splice loss at M3 (dB)

After M5 is set, pressing MARKER key displays cursors for each marker of M1 to M5. Markers can be moved together with their interval fixed.

Q8460A  
OPTICAL FIBER REFLECTOMETER  
INSTRUCTION MANUAL

3.5 Marker Functions (In ADVANCE FUNCTION Mode)

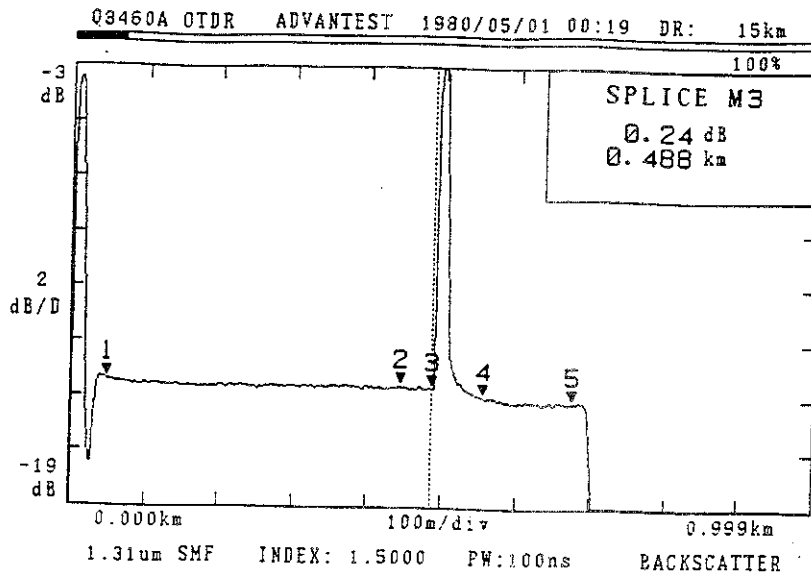

Figure 3 - 23 Measurement Display of 5 POINTS SPLICE

Q8460A  
OPTICAL FIBER REFLECTOMETER  
INSTRUCTION MANUAL

3.5 Marker Functions (In ADVANCE FUNCTION Mode)

- ⑥ SPLICE, SPLICE (2-point splice loss measurement by using M1 to M5 markers)

The splice loss of the adjacent two points can be measured simultaneously. As shown in the figure, set the M1 to M5 markers to certain points and the splice loss at the M2 and M4 marker positions will be measured simultaneously.

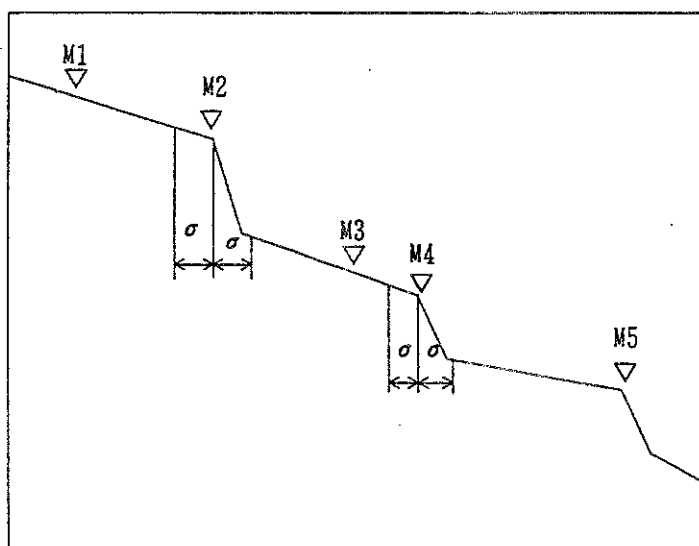

Set the 5 point markers as follows:

- M2: Splice position 1 to be measured
- M4: Splice position 2 to be measured (next splice position)
- M1: Data between M1 and "M2- $\sigma$ " is used for linear approximation.  
Set the M1 marker so that the splice or Fresnel reflection does not occur.
- M3: Set the M3 marker at the rough center position between M2 and M4. Data between "M2+ $\sigma$ " and M3 and between M3 and "M4- $\sigma$ " are used for linear approximation.
- M5: Data between "M4+ $\sigma$ " and M5 is used for linear approximation.

Q8460A  
OPTICAL FIBER REFLECTOMETER  
INSTRUCTION MANUAL

3.5 Marker Functions (In ADVANCE FUNCTION Mode)

When these 5 markers are set, the data of the bold line shown in the figure are used for approximation through LSA. The following values are displayed:

- (a) Distance of M2 (from the reference point)
- (b) Distance of M4 (from the reference point)
- (c) Splice loss of M2
- (d) Splice loss of M4

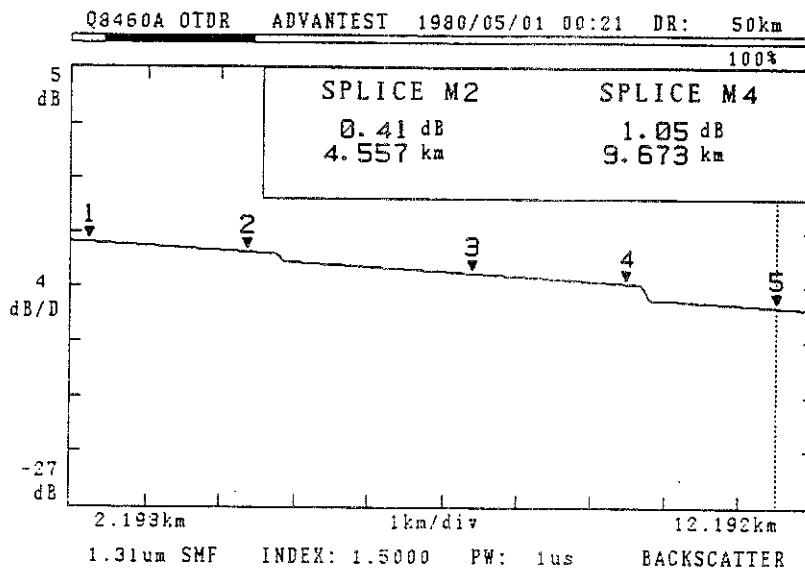

Figure 3 - 24 Measurement Display of SPLICE, SPLICE

Q8460A  
OPTICAL FIBER REFLECTOMETER  
INSTRUCTION MANUAL

3.5 Marker Functions (In ADVANCE FUNCTION Mode)

⑦ LOSS, LOSS (LSA) and LOSS, LOSS (2PA) (by using M1 to M5 markers)

The total loss, partial length, and loss of optical fiber cable can be measured between any two points. Select LOSS, LOSS (LSA) to obtain fiber loss by least squares method, or select LOSS, LOSS (2PA) to obtain it by 2PA. As shown in the figure, set the M1, M3 and M5 markers to be the connection points.

Then, set the M2 and M4 markers to the location so that the waveforms are not affected by the connection points. The following measured values are displayed:

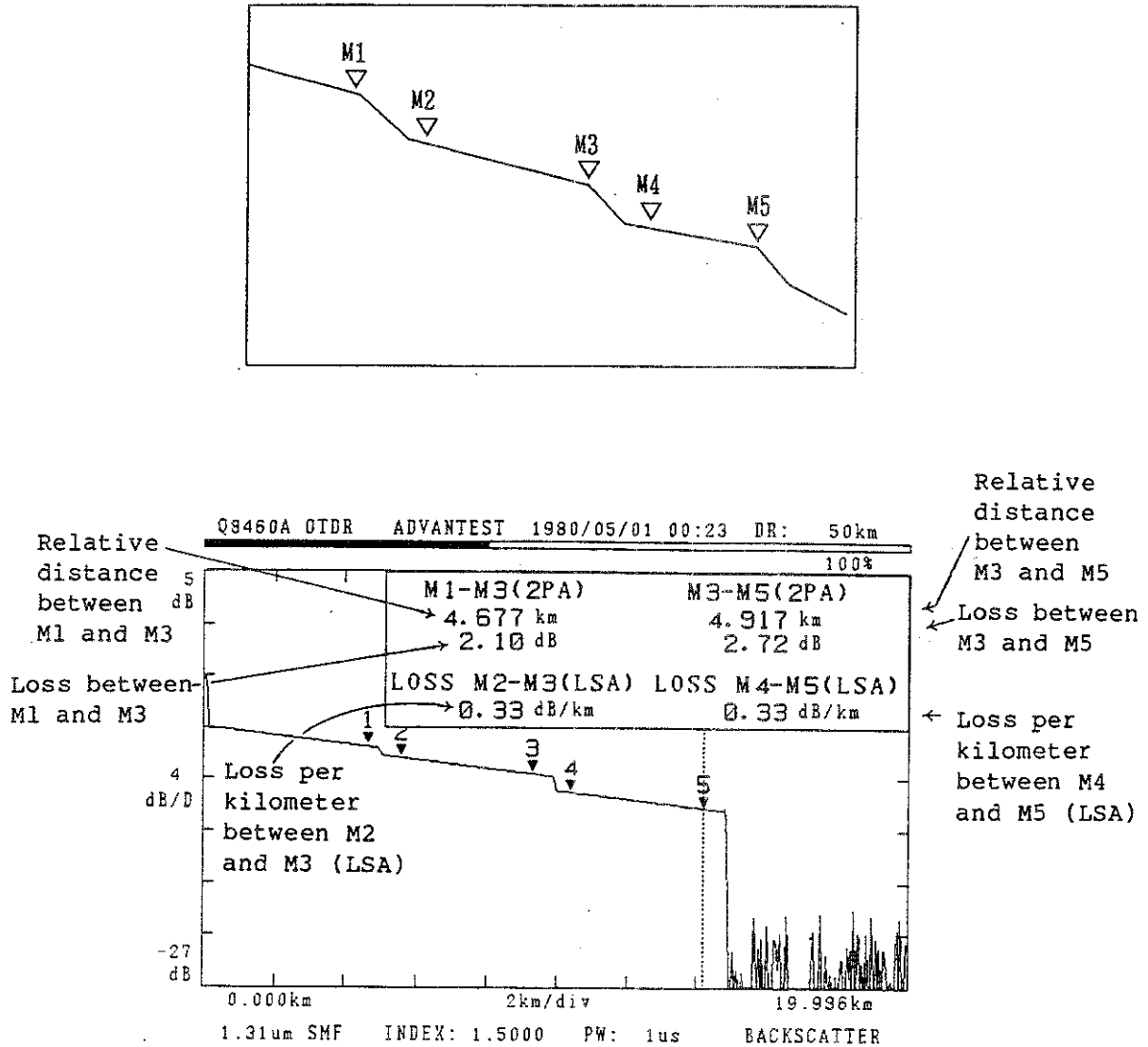

Figure 3 - 25 Measurement Display of LOSS, LOSS (LSA)



Q8460A  
OPTICAL FIBER REFLECTOMETER  
INSTRUCTION MANUAL

3.5 Marker Functions (In ADVANCE FUNCTION Mode)

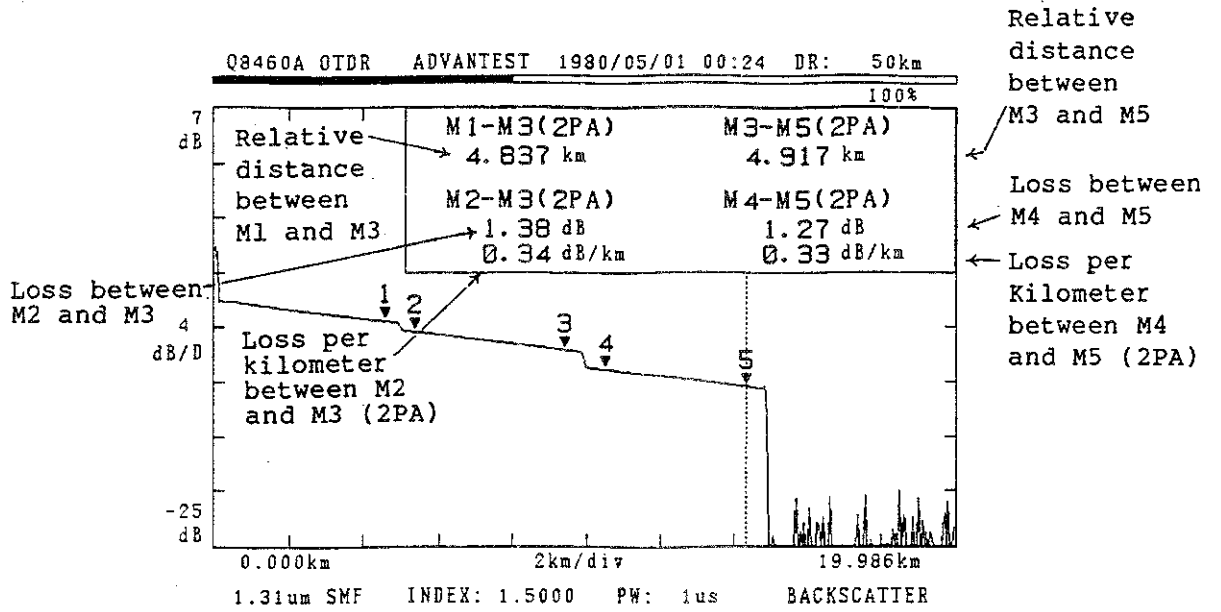

Figure 3 - 26 Measurement Display of LOSS, LOSS (2PA)

Q8460A  
OPTICAL FIBER REFLECTOMETER  
INSTRUCTION MANUAL

3.5 Marker Functions (In ADVANCE FUNCTION Mode)

3.5.4 ORL

① ORL function setting

- Select the BS REFER option in the ADVANCE FUNCTION mode. Set the signal level for each wave length by using the data knob. The wave length is set when you press the [ENTER] key. After setup, press the [MENU] key to release the ADVANCE FUNCTION mode.

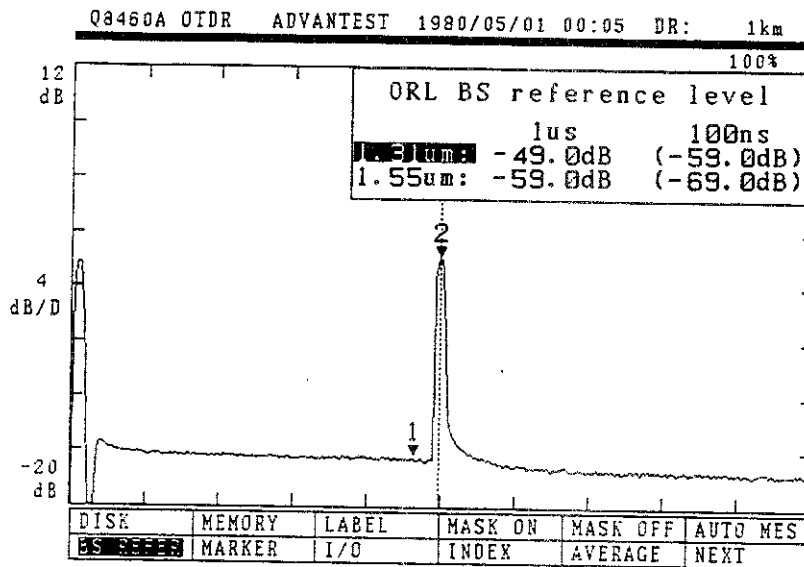

Figure 3 - 27    ORL Function Setup Screen

② Measurement

- Make sure that the STANDARD marker is displayed in the ADVANCED FUNCTION mode.
- Press the [MARKER] key on the panel, and the "2 point loss" and ORL markers will appear. The ORL (Optical Return Loss) value, level difference ( $\Delta$ ), and reference level of back-scattered light (BS) must appear on the screen.
- Select the pulse width of 1  $\mu$ s or 100 ns. If you select 20 ns or 3 ns, the measurement will fail and the MES FAIL message will be displayed.
- Set the marker. You must locate marker 1 onto the back-scattered light toward the Fresnel reflection, and locate marker 2 onto the peak of Fresnel reflection.

Q8460A  
OPTICAL FIBER REFLECTOMETER  
INSTRUCTION MANUAL

3.5 Marker Functions (In ADVANCE FUNCTION Mode)

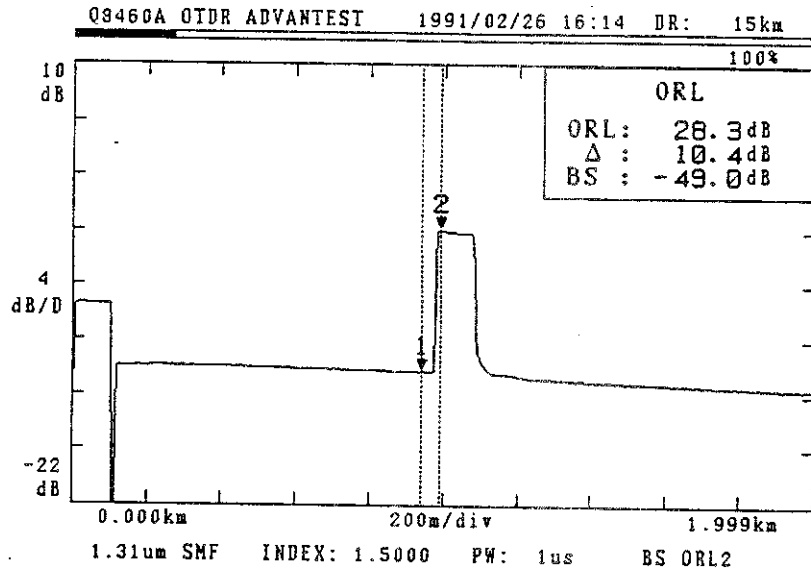

Figure 3 - 28 ORL Function Measurement Screen

When the M2 level reaches the limit (-1 dB), the MES FAIL measurement failure message is displayed. You must change the measuring range. There are five measuring modes\*, and you must select the measuring modes to avoid reaching the limit level. Then, measure the waveforms again.

- \*: BACKSCATTER (ATT 0 dB)
- BS ORL1       (ATT 3 dB)
- BS ORL2       (ATT 8 dB)
- BS ORL3       (ATT 13 dB)
- BS ORL4       (ATT 18 dB)

NOTE

The measuring range is changed without using the ORL mode. When you select the ORL function, the S/N may drop approximately 3 dB. The reflection mode cannot be switched to when the ORL function is used.

[Automatic ORL range switching]

Pressing the ENTER key switches the range to fit the limit level. Specify markers 1 and 2 and press the ENTER key in a MONITOR state.

NOTE

Automatic range switching cannot be used when averaging is executing or has stopped, or in a pause state, or with a pulse width of 20ns and 3ns.

Q8460A  
OPTICAL FIBER REFLECTOMETER  
INSTRUCTION MANUAL

3.6 Waveform Memory

3.6 Waveform Memory

Data of the measured waveforms can be stored in the system memory. The data can be saved by pressing the SAVE key or by using the Memory function option of the ADVANCE FUNCTION.

When the SAVE key is pressed, the battery backup function isn't available. However, the memory function of ADVANCED FUNCTION supports the battery backup function.

(1) Saving by the SAVE key and calling by the VIEW key

If the operator presses the SAVE key, the waveform data being displayed on-screen is stored. Note that the storage is limited to the waveform itself. The measuring conditions and other parameters are not saved.

Pressing the VIEW key allows saved waveform to be displayed on the CRT. (DUAL TRACE function)  
This function is useful for comparison of a saved waveform and the waveform being displayed on the CRT, since these two types of waveforms can be displayed at the same time on the CRT. Specifically, when the dual band plug-in unit is used, the waveforms in different wavelengths can be compared with this function (e.g. 1.31/1.55 $\mu$ m for Q84621).

The LED of the VIEW key indicates the following states:

- ✱ → Execute DUAL TRACE
- VIEW        • → Display the data being measured
- 

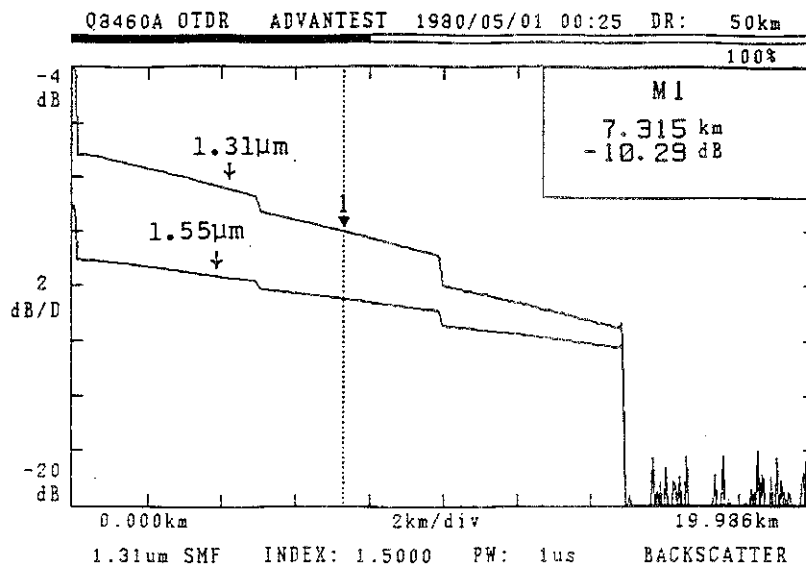

Figure 3 - 29 Two Waveforms Simultaneous Comparison by SAVE/VIEW Function

Q8460A  
OPTICAL FIBER REFLECTOMETER  
INSTRUCTION MANUAL

3.6 Waveform Memory

(2) Memory function (ADVANCED FUNCTION)

The memory function of ADVANCED FUNCTION can save up to 32 waveforms and their measuring conditions in memory. As this function is battery backed, the information is held in memory even when the system power supply is turned off. This function allows you to store not only waveforms and measuring condition information but to observe the change of fiber cables under test over time.

[Selecting the memory function]

Press the MENU key.

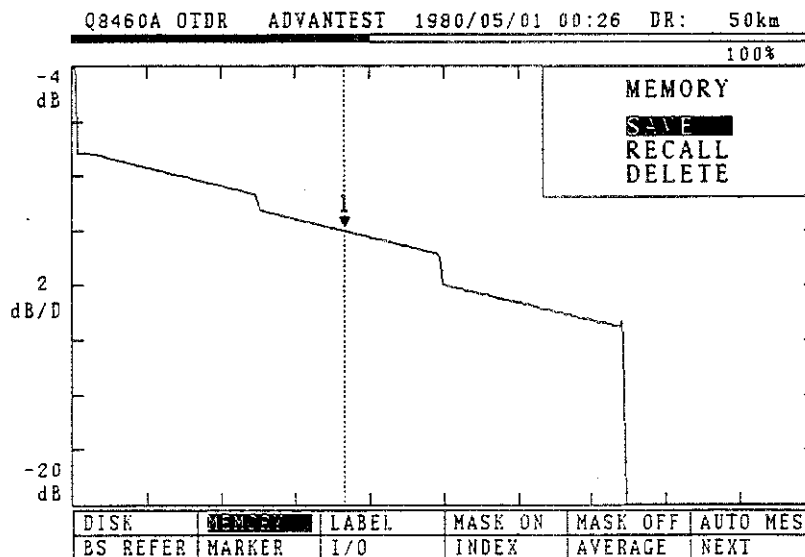

Figure 3 - 30 Memory Initial Screen

Select the SAVE, RECAL, or DELETE\* option by rotating the data knob, and press the ENTER key. The specified mode will be selected.

- \*: **SAVE** : Saves waveforms in memory.
- RECALL**: Reads waveforms from memory.
- DELETE**: Deletes waveforms from memory.

Q8460A  
OPTICAL FIBER REFLECTOMETER  
INSTRUCTION MANUAL

① SAVE mode

The following screen will be displayed:

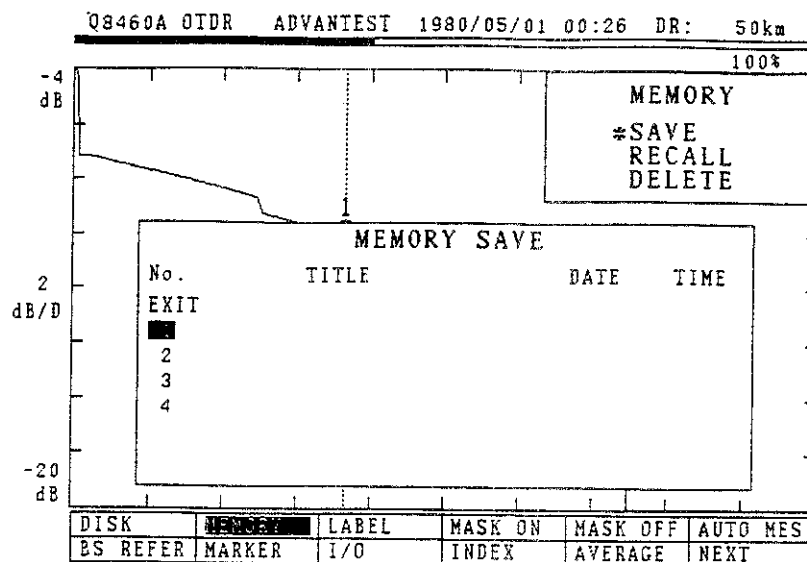

Figure 3 - 31 MEMORY SAVE Mode Screen

Locate the cursor onto the waveform number to be saved and press the ENTER key, and the waveform will be saved in memory. The label characters are set in the TITLE field, the date is set in the DATE field, and the time is set in the TIME field.

If the cursor is located on the option having data and press the ENTER key, the following message is displayed:

\*\*\* If you are going to rewrite,  
please push "ENTER" key. \*\*\*

If the ENTER key is pressed again, the previous data is erased and the current waveforms are displayed.

When data has been saved, the memory initial screen is displayed again. Select the EXIT option and press the ENTER key, and the initial screen will be redisplayed.

Q8460A  
OPTICAL FIBER REFLECTOMETER  
INSTRUCTION MANUAL

② RECALL mode

The following screen appears:

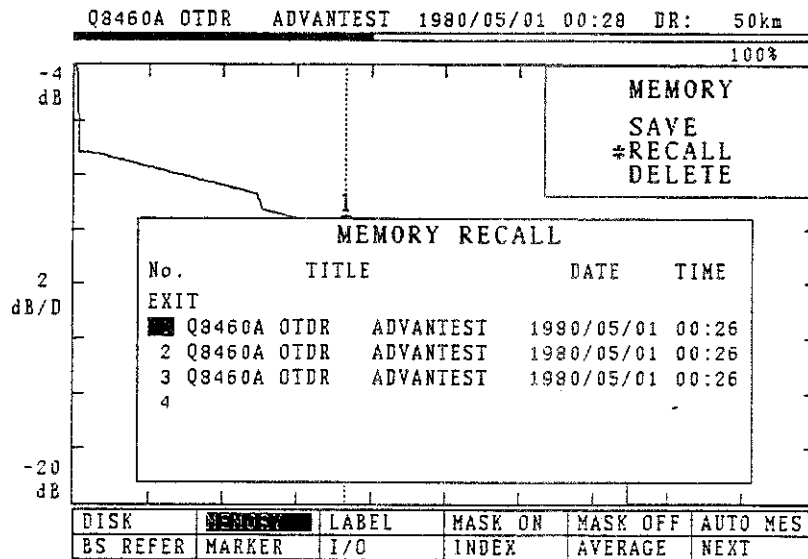

Figure 3 - 32 MEMORY RECALL Mode Screen

Locate the cursor onto the waveform number to be recalled and press the ENTER key, and the waveform will be read from memory and the memory initial screen will be displayed.

The memory initial screen is also displayed by selecting the EXIT option and pressing the ENTER key.

Then, press the MENU key to exit the ADVANCED FUNCTION mode.

Press the MONITOR key to start measurement. Note that the current date and time are set.

Q8460A  
OPTICAL FIBER REFLECTOMETER  
INSTRUCTION MANUAL

3.6 Waveform Memory

③ DELETE mode

The following screen appears:

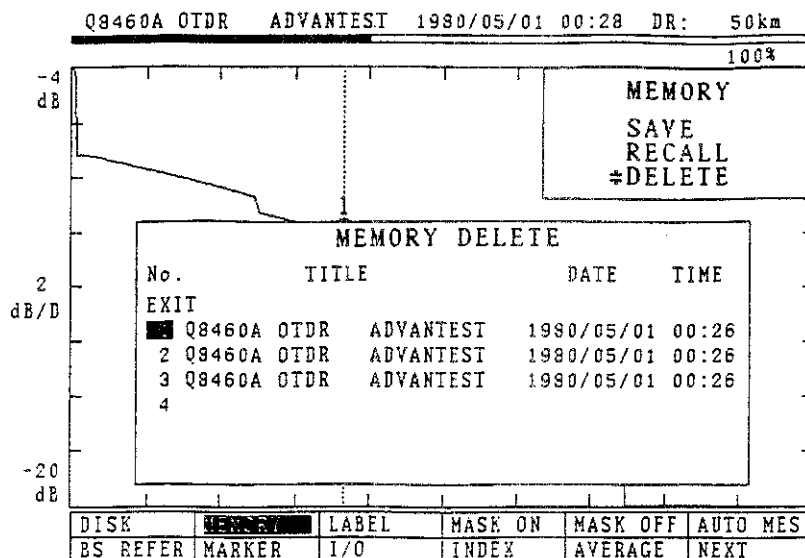

Figure 3 - 33 MEMORY DELETE Mode Screen

Locate the cursor onto the waveform number to be deleted and press the ENTER key, and the following message will be displayed:

\*\*\* If you are going to delete the file,  
please push "ENTER" key. \*\*\*

If you agree, press the ENTER key. The data will be deleted from memory.

Select the EXIT option and press the ENTER key, and the memory initial screen will be redisplayed.

Select the ALL DELETE option and press the ENTER key, and the entire memory contents will be deleted.



Q8460A  
OPTICAL FIBER REFLECTOMETER  
INSTRUCTION MANUAL

3.7 Floppy Disk Drive Unit (when equipped as option)

3.7 Floppy Disk Drive Unit (when equipped as option)

A floppy disk can be used to store and reproduce measurement data and setting conditions. As its format conforms to MS-DOS, data can be handled by personal computers running on MS-DOS.

Specifications of floppy disk drive

Disk drive type: 3.5 inch micro floppy disk drive.

Usable floppy disk: 2DD (Double-sided double-density)

2HD (Double-sided high-density)

Capacity when formatted: 720k bytes (2DD) / 1M bytes (2HD) / 1.44M bytes (2HD)

Recording format: 2DD IBM/NEC common format

2HD NEC format

2HD IBM format

Recording file number:

Data type (waveform data point number)	Record file number			
	CRT data (501 point)		Internal data (15344 point)	
Data format	Binary	ASCII	Binary	ASCII
2DD (720 K byte)	112 file	112 file	11 file	5 file
2HD (1 M byte)	192 file	192 file	20 file	10 file
2HD (1.44 M byte)	224 file	219 file	23 file	11 file

3.7.1 Floppy Disk Handling Notes

(1) Write-protection

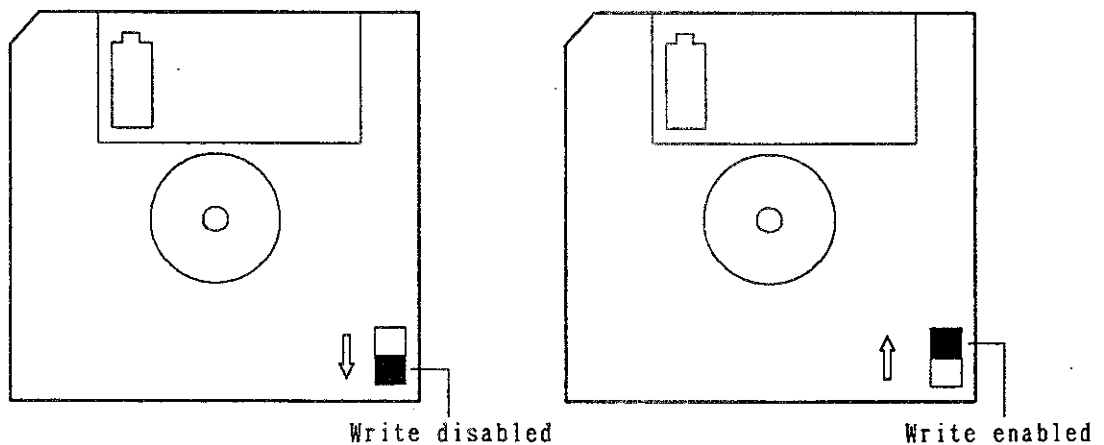

Figure 3 - 34 Write-protection of floppy disk

Q8460A  
OPTICAL FIBER REFLECTOMETER  
INSTRUCTION MANUAL

3.7 Floppy Disk Drive Unit (when equipped as option)

A 3.5-inch micro-floppy disk can be write-protected so as not to erroneously erase the valuable data. The disk is write-protected if the write-protection notch is slid downward as shown in Figure 3-34.

(2) Floppy disk drive handling notes

- Do not place the Q8460A upside down.
- Giving a strong impact on the floppy disk drive may damage the head of the drive or a floppy disk.
- Pulling out a floppy disk before it is completely ejected may cause the head to catch the disk shutter window. The head may be damaged at this event.
- Inserting a floppy disk when not completely ejected may damage the head.

(3) How to insert floppy disk

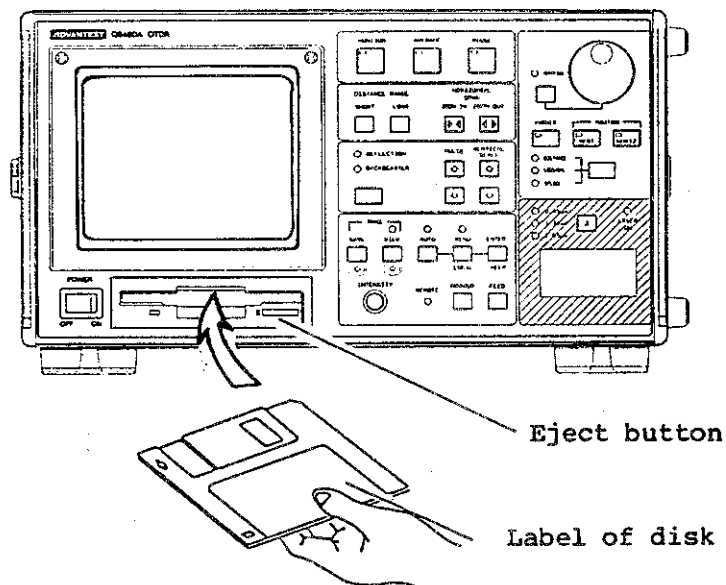

Figure 3 - 35 How to insert floppy disk

Figure 3-35 illustrates how to insert a floppy disk into the disk drive unit. Insert a floppy disk with its labeled side up into the slot. Press the disk forward with a finger until it reaches the end and is fixed on the drive. To remove the disk, press the eject button. The disk will automatically come out.

Q8460A  
OPTICAL FIBER REFLECTOMETER  
INSTRUCTION MANUAL

3.7 Floppy Disk Drive Unit (when equipped as option)

Caution

Do not press the eject button when the red lamp is lit on the drive unit.

3.7.2 Floppy Disk Functions (ADVANCE FUNCTION)

[How to use the floppy disk functions]

Press the MENU key.

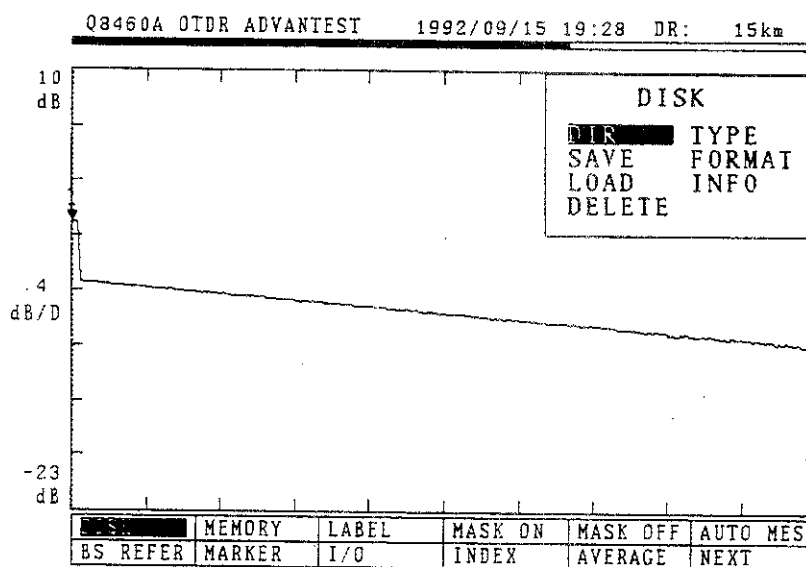

Figure 3 - 36 FDD Functions Initial Screen

Rotate the data knob to select DIR, SAVE, LOAD, DELETE, FORMAT, or INFO. Then press the ENTER key to go into the selected mode.

Q8460A  
OPTICAL FIBER REFLECTOMETER  
INSTRUCTION MANUAL

3.7 Floppy Disk Drive Unit (when equipped as option)

(1) DIRECTORY Mode

This mode is used to display a list of files stored in the disk. The following screen will appear.

Q8460A OTDR ADVANTEST    1991/01/01 08:25    DR:    15km

【 DIRECTORY 】						
No.	FILE NAME	TYPE	SIZE	DATE	TIME	
1	00000002	DSP	2837	1991/01/29	15:38	
2	00000001	DSP	2837	1991/01/29	15:27	
3	MASK-ON-	LIN	4865	1991/01/28	11:07	
4	MASK-ON	LIN	30977	1991/01/28	10:53	
5	00000000	LIN	20833	1991/01/28	10:44	
6	DUAL-131	LIN	20833	1991/01/28	10:33	
7	DUAL-131	DSP	2837	1991/01/28	10:33	
8	DUAL-155	DSP	2837	1991/01/28	10:32	
9	DUAL-155	LIN	20833	1991/01/28	10:31	

S	MEMORY	LABEL	MASK ON	MASK OFF	AUTO MES
BS REFER	MARKER	I/O	INDEX	AVERAGE	NEXT

Figure 3 - 37    DIRECTORY Mode Screen

① Meaning of Items in the List

Each item of the list represents the following meaning:

No.: File number

FILE NAME: File name

TYPE: Type of the stored data (See Figure 3-41)

SIZE: Size of the file in bytes

DATE: Year, month, and date the file is saved

TIME: Time the file is saved

② How to Use the Functions

Scroll the list with the data knob.

Select EXIT and press the ENTER key to return to the FDD initial screen.

Q8460A  
OPTICAL FIBER REFLECTOMETER  
INSTRUCTION MANUAL

3.7 Floppy Disk Drive Unit (when equipped as option)

(2) SAVE Mode

This mode is used to store waveform data and set values in the disk. The following screen will appear.

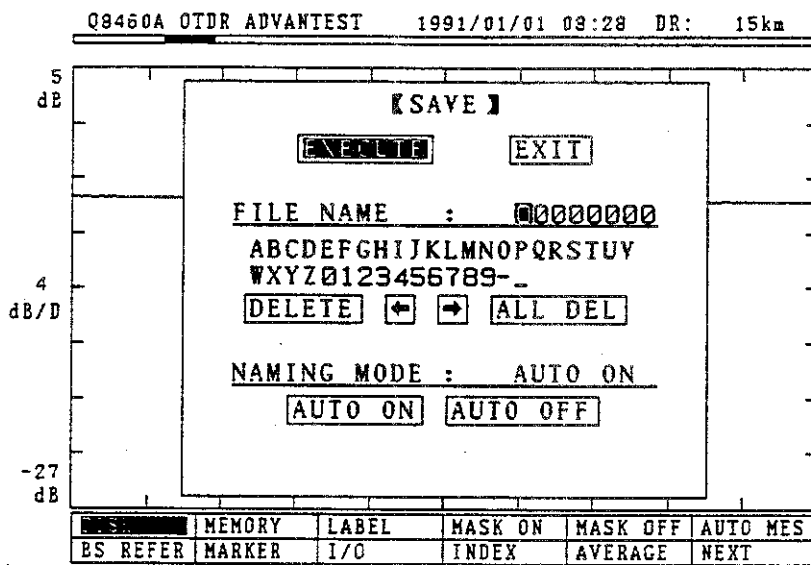

Figure 3 - 38 SAVE Mode Screen

① FILE NAME

Up to eight alphanumeric characters can be entered. Reverse the characters you want to enter with the data knob and press the ENTER key. The DELETE, ←, →, and ALL DEL keys function as follows when followed by the ENTER key.

DELETE: Deletes a character where the cursor is positioned.

←: Moves the cursor to the left.

→: Moves the cursor to the right.

ALL DEL: Deletes all file names.

② NAMING Mode

Reverse the item you want to enter with the data knob and press the ENTER key.

If you select AUTO ON, the seventh and eighth characters are updated automatically so that you need not enter a file name every time you save the file.

When you select AUTO ON, specify eight characters for a file name with numerics for the seventh and eighth characters.

(Example)

FILE NAME: FIBER-00

Q8460A  
OPTICAL FIBER REFLECTOMETER  
INSTRUCTION MANUAL

3.7 Floppy Disk Drive Unit (when equipped as option)

③ Saving

Select EXECUTING with the data knob and press the ENTER key to save data such as waveform data in the disk. After the data is saved, the FDD Functions initial screen reappears. To return to the FDD Functions initial screen without saving data, select EXIT and press the ENTER key.

NOTE

The data after recalling by Memory Functions and after loading by FDD Functions are not stored.

(3) LOAD Mode

This mode is used to load the contents of a file into the system. The following screen will appear.

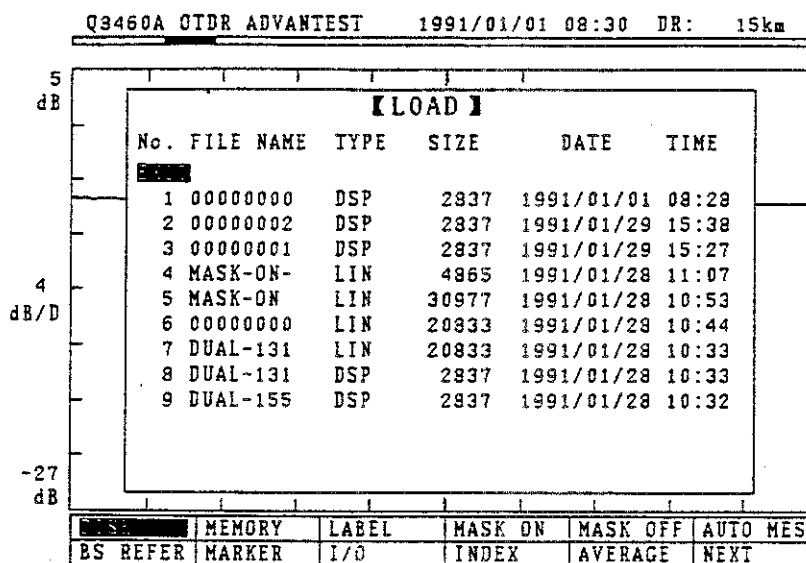

Figure 3 - 39    LOAD Mode Screen

① Operation

Move the cursor on the desired file number using the data knob and press the ENTER key to read waveform data from the disk and return to the FDD Functions initial screen.

To return to the FDD Functions initial screen without loading a file, select EXIT and press the ENTER key.

Q8460A  
OPTICAL FIBER REFLECTOMETER  
INSTRUCTION MANUAL

3.7 Floppy Disk Drive Unit (when equipped as option)

- ② Span change and horizontal position shift concerning loaded waveform data

Operation of span change and horizontal position shift differs depending on the type of the loaded waveform data (see the item (5)-(1)).

DSP (DISPLAY): Inhibits span change and horizontal position shift  
 LOG (ALL-LOG): Inhibits span change and horizontal position shift  
 LIN (ALL-LINEAR): Permits span change and horizontal position shift

Then, press the MENU key to exit the ADVANCE FUNCTION Mode. Press the MONITER key to start measurement. Note that the current date and time are set.

(4) DELETE Mode

This mode is used to delete files.  
 The following screen will appear.

Q8460A OTDR ADVANTEST    1991/01/01 08:30 DR: 15km

【DELETE】						
No.	FILE NAME	TYPE	SIZE	DATE	TIME	
1	00000000	DSP	2837	1991/01/01	08:28	
2	00000002	DSP	2837	1991/01/29	15:38	
3	00000001	DSP	2837	1991/01/29	15:27	
4	MASK-ON-	LIN	4865	1991/01/28	11:07	
5	MASK-ON	LIN	30977	1991/01/28	10:53	
6	00000000	LIN	20833	1991/01/28	10:44	
7	DUAL-131	LIN	20833	1991/01/28	10:33	
8	DUAL-131	DSP	2837	1991/01/28	10:33	
9	DUAL-155	DSP	2837	1991/01/28	10:32	

MEMORY	LABEL	MASK ON	MASK OFF	AUTO MES
BS REFER	MARKER	I/O	INDEX	AVERAGE
				NEXT

Figure 3 - 40 DELETE Mode Screen

Operation

Move the cursor on the file number you want to delete and press the ENTER key. The following messages will appear for confirmation.

DELETE: PUSH "ENTER KEY"

ESCAPE: ROTATE "KNOB"

Press the ENTER key to delete the file. Rotate the data knob to cancel.

To return to the FDD Functions initial screen, select EXIT and press the ENTER key.

Q8460A  
OPTICAL FIBER REFLECTOMETER  
INSTRUCTION MANUAL

3.7 Floppy Disk Drive Unit (when equipped as option)

(5) TYPE Mode

This mode is used to set the data type when saving waveform data in the disk.

The following screen will appear.

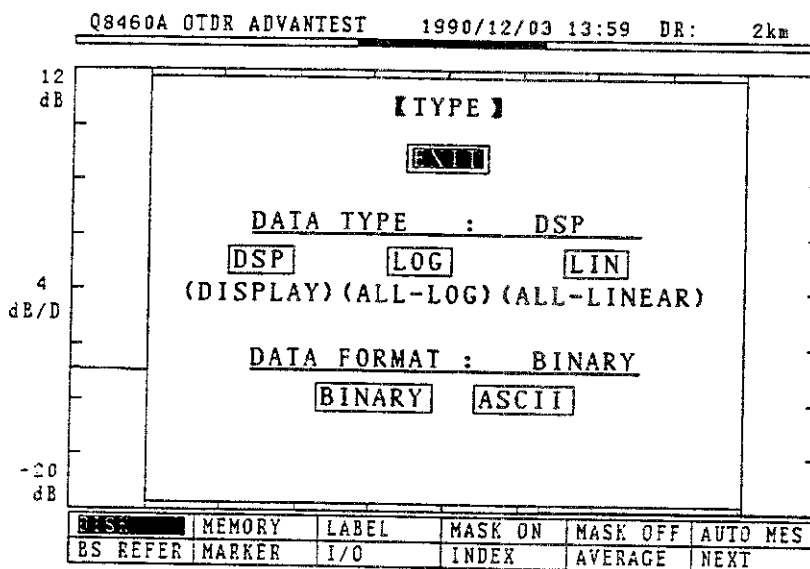

Figure 3 - 41 TYPE Mode Screen

① DATA TYPE

Reverse the item you want to enter with the data knob and press the ENTER key.

DATA TYPE specifies the type of data to be saved. An extension is automatically added to the file when saved.

Each data type represents the following.

DSP (DISPLAY)

BACKSCATTER: LOG-converted waveform data on display

REFLECTION: Waveform data on display

LOG (ALL-LOG)

BACKSCATTER: LOG-converted all internal waveform data

REFLECTION: This type of data cannot be saved.

As compared with "DSP", more points of waveform data can be analyzed by a personal computer. Fewer files, however, can be stored.

LIN (ALL-LINEAR)

BACKSCATTER: All internal raw waveform data

REFLECTION: All internal waveform data



Q8460A  
OPTICAL FIBER REFLECTOMETER  
INSTRUCTION MANUAL

3.7 Floppy Disk Drive Unit (when equipped as option)

After loading, span can be re-set and "HORIZONTAL POSITION" can be re-moved. Number of waveform data points which can be analyzed by a PC and number of storable files are almost same as that for "LOG".

② DATA FORMAT

Reverse the item you want to enter with the data knob and press the ENTER key.

DATA FORMAT specifies the format of data to be saved.  
BINARY: Saves waveform data in binary format.  
ASCII: Saves waveform data in ASCII format.

NOTE

"LIN" and "ASCII" can not be combined.

(6) FORMAT Mode

This mode is used to format disks.  
The following screen will appear.

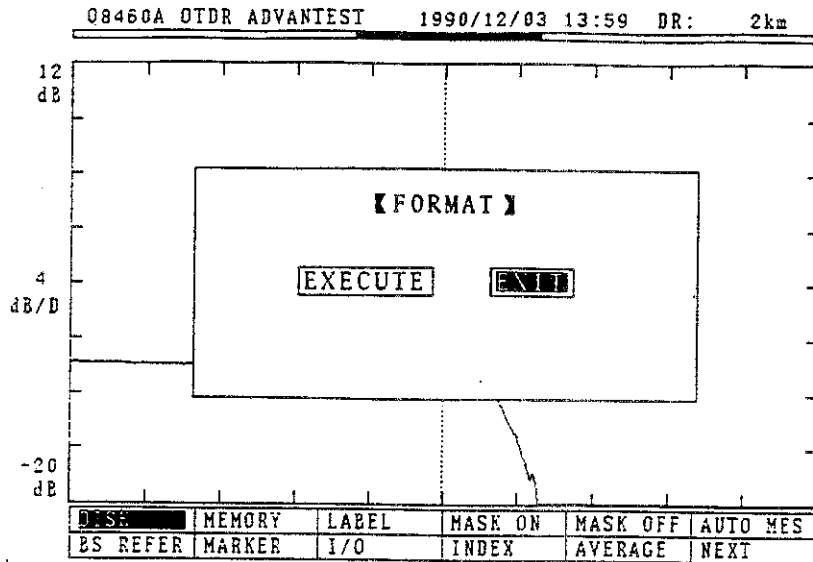

Figure 3 - 42 FORMAT Mode Screen

Operation

Select EXECUTE with the data knob and press the ENTER key to display the following confirmation messages.

Q8460A  
OPTICAL FIBER REFLECTOMETER  
INSTRUCTION MANUAL

3.7 Floppy Disk Drive Unit (when equipped as option)

FORMAT: PUSH "ENTER KEY"

ESCAPE: ROTATE "KNOB"

Pressing the ENTER key again will start formatting. Rotate the data knob to cancel.

To return to the FDD Functions initial screen, select EXIT and press the ENTER key.

(7) INFORMATION Mode

This mode is used to set the contents of INFORMATION to be saved in the disk. This mode is used to load the contents of INFORMATION into the system.

The following screen will appear.

Q8460A OTDR ADVANTEST    1992/09/11 02:52 DR: 15km

---

【 INFORMATION 】					
Operator :		CO# :			
Floor# :		Rack# :			
Fiber# :		Cable# :			
Near :		Far :			
Direction:					
Note :					
ABCDEFGHIJKLMNOPQRSTUVWXYZabcdefghijklmnopqrstuvwxyz mnopqrstuvwxyz0123456789 !"#%&'()*+,- ./:;<=>?'{ }~_					
DELETE		←	→	DEL LINE	
		DEL ALL		EXIT	

BS REFER	MEMORY	LABEL	MASK ON	MASK OFF	AUTO MES
	MARKER	I/O	INDEX	AVERAGE	NEXT

Figure 3 - 43 INFORMATION Mode Screen

Operation

Reverse the item you want to enter with the data knob and press the ENTER key. Reverse the character you want to enter with the data knob and press the ENTER key to enter it.

The only NOTE can be entered up to 64-characters, and other items can be entered up to 8-characters.

Select one of these, "DELETE", "←", "→", "DEL LINE", and "DEL ALL" and press the ENTER key to execute the following operations.

- DELETE : Deletes the character where the cursor is positioned.
- ← : Moves the cursor to the left.
- : Moves the cursor to the right.
- DEL LINE: Deletes the characters of selecting item.
- DEL ALL : Deletes the characters of all items.

Q8460A  
OPTICAL FIBER REFLECTOMETER  
INSTRUCTION MANUAL

3.7 Floppy Disk Drive Unit (when equipped as option)

(8) Procedure for Data Saving Operation

- ① Format the disk in FORMAT mode.
- ② Specify the DATA TYPE and DATA FORMAT in TYPE mode.
- ③ Select the SAVE mode.

Specify the NAMING MODE.

Enter the file name.

Select EXECUTE with the data knob and press the ENTER key.

[Saving the data again]

- When the NAMING MODE is set to AUTO ON  
Select the SAVE Mode.  
Select EXECUTE with the data knob and press the ENTER key.
  
- When the NAMING MODE is set to AUTO OFF  
Select the SAVE mode.  
Enter the FILE NAME.  
Select EXECUTE with the data knob and press the ENTER key.

Q8460A  
OPTICAL FIBER REFLECTOMETER  
INSTRUCTION MANUAL

3.7 Floppy Disk Drive Unit (when equipped as option)

3.7.3 Command Executing of the FDD Functions

(1) Error Message

When commands of the FDD functions are executed, messages including error messages are displayed on the screen.

Messages and their meaning are given below.

Message	Meaning
ERROR: DRIVE NOT READY	A floppy disk is not in the disk drive unit. The disk is not formatted or with an invalid format.
ERROR: WRITE PROTECTED	The floppy disk is write-protected
ERROR: FILE NOT FOUND	The specified file is not in the disk.
ERROR: DISK FULL	The disk is full and has no space for a new file.
ERROR: FILE NAME ERROR	The file name is incorrect.
ERROR: DATA TYPE ERROR	"LOG" type data cannot be saved in REFLECTION mode. Cannot load data in format other than that performed in this unit.
ERROR: CAN NOT SAVE	Cannot save data after recalling by the memory function or after loading by the FDD function.
OVERWRITE: PUSH "ENTER KEY" ESCAPE: ROTATE "KNOB"	The same file name exists. Pressing the ENTER key overwrites the file. Rotating the knob cancels the command.
DELETE: PUSH "ENTER KEY" ESCAPE: ROTATE "KNOB"	These messages are displayed for confirmation before the file is deleted by the command. Pressing the ENTER key executes the command. Rotating the knob cancels the command.
FORMAT: PUSH "ENTER KEY" ESCAPE: ROTATE "KNOB"	These messages are displayed for confirmation before the format command is executed. Pressing the enter key executes the command. Rotating the knob cancels the command.

(2) Floppy disk data format

The data format for saving data in a floppy disk is as follows:

Q8460A  
OPTICAL FIBER REFLECTOMETER  
INSTRUCTION MANUAL

3.7 Floppy Disk Drive Unit (when equipped as option)

Saved item (example)	Number of bytes	Description
ADVANTEST	16	Company name
Q8460A	16	Product name
A00	16	Version
DSP	16	Data type
BINARY	16	Data format
501 3000	16	Number of data points on display, number of internal data points
BACKSCATTER	16	Measurement mode
65536	16	Average number during and after averaging
AVERAGE+PAUSE	14	Mode
Q8460A OTDR ADVANTEST	24	Label
1991/05/01 12:30	17	Data and time
DR: 100km	13	Distance range
10km/div	14	Cross axis scale
START:0.000km ,0.00000km	31	Display start distance, internal start distance
END:102.118km ,102.11823km	29	Display stop distance, internal stop distance
4dB/D	8	Vertical axis scale
dBmax: 12dB	12	Maximum value of vertical axis scale
dBmin:-20dB	12	Minimum value of vertical axis scale
1.31um SMF	11	Wavelength
INDEX: 1.5000,1.3um; 1.5000, 1.5um; 1.5000	44	Refractive index Displayed index, 1.3um; Internal index 1.5um; Internal index

Q8460A  
OPTICAL FIBER REFLECTOMETER  
INSTRUCTION MANUAL

3.7 Floppy Disk Drive Unit (when equipped as option)

Saved item (example)	Number of bytes	Description
PW: 100ns	9	Pulse width
BACKSCATTER	9	Measurement mode
AVERAGE No.:65536,100%	23	Average number
ORL BS reference level 1.31um: -49.0dB (-39.0dB), 1.55um: -49.0dB (-39.0dB)	77	ORL reference level
INFORMATION	136	Information
Empty Area	120	Empty area
Internal information	1582	Internal information used for this unit (Binary format)
Waveform data	Any number of bytes	Waveform data

3.7.4 Regeneration of floppy disk data in PC9801

(1) Log-conversion of waveform data

If the data type is "LIN" and the measurement mode is "BACKSCATTER", use the following expressions for LOG-conversion:

For data saved in monitor mode.

$$Y = 5 \times \log_{10}(X/T)$$

For data saved after averaging

If  $AVG \geq 33024$

$$Y = 5 \times \log_{10}(X/(T \times AVG \times 2))$$

If  $AVG < 33024$

$$Y = 5 \times \log_{10}(X/T(T \times AVG))$$

Where, X : Saved waveform data

Y : LOG-converted waveform data

AVG: Average number during and after averaging

T : Constant 65536

Q8460A  
OPTICAL FIBER REFLECTOMETER  
INSTRUCTION MANUAL

3.7 Floppy Disk Drive Unit (when equipped as option)

---

(2) Obtaining distance information for waveform data

For distance information for in the waveform data, use the following expression.

$$X = ((\text{END} - \text{START}) / (\text{POINT}-1)) \times \text{XP}$$

Where, POINT: Number of internal data points  
START: Internal start distance  
END : Internal stop distance  
XP : Position of waveform data point  
X : Distance

(3) Program example

The following programs are for regenerating the data saved by the floppy disk function in a PC9801.

Program 1: For data saved in measurement mode "BACKSCATTER"  
Program 2: For data saved in measurement mode "REFLECTION"

Program 1

```
1000 '
1010 '
1020 '
1030 '   EXAMPLE PROGRAM
1040 '
1050 '   SAVE DATA BY FDD FUNCTIONS
1060 '
1070 '       MESURMENT MODE : BACKSCATTER
1080 '       DATA TYPE      : DSP, LOG, LIN
1090 '       DATA FORMAT    : ASCII, BINARY
1100 '
1110 '
1120 '
1130 DIM FILNAME$(20)
1140 DIM HEAD1$(16), HEAD2$(16), HEAD3$(16), HEAD4$(16)
1150 DIM HEAD5$(16), HEAD6$(16), GEAD7$(16), HEAD8$(16)
1160 DIM FUNC$(14), LABEL$(24), CLOCK$(17), DR$(13)
1170 DIM HSCALE$(14), SPNSTR$(31), SPNEND$(29), VSCALE$(8)
1180 DIM DBMAX$(12), DBMIN$(12), WLEN$(11), IDX$(44), PW$(9)
1190 DIM MODE$(13), AVEG$(23), ORL$(77), DUMMY$(255)
1200 DIM WDATA(16000), WDAT1$(4), WDAT2$(4), WDAT3$(4), WDAT4$(4)
1210 DIM WDAT$(8)
1220 '
1230 '

```

Q8460A  
OPTICAL FIBER REFLECTOMETER  
INSTRUCTION MANUAL

3.7 Floppy Disk Drive Unit (when equipped as option)

```

1240 ***** MAIN *****
1250 INPUT "FILE NAME:", FILNAME$   Specifies the name of a file in which
1260 FILNAME$ = "B:" + FILNAME$     data to be regenerated is saved.
1270 '
1280 OPEN FILNAME$ FOR INPUT AS #1
1290   GOSUB *DSKSTR   Reads display information and other
1300   GOSUB *DSKINF   Reads internal information
1310   IF HEAD5$="ASCII" THEN
       GOSUB *ASCDAT   Reads waveform data in "ASCII" format.
       ELSE GOSUB *BINDAT   Reads waveform data in "BINARY" format.
1320 CLOSE #1
1330 GOSUB *GRAPH   Displays display information and waveform.
1340 END
1350 *****
1360 '
1370 '
1380 *DSKSTR
1390   HEAD1$ = INPUT$(16, #1)
1400   HEAD2$ = INPUT$(16, #1)
1410   HEAD3$ = INPUT$(16, #1)
1420   HEAD4$ = INPUT$(16, #1)
1430   HEAD5$ = INPUT$(16, #1)
1440   HEAD6$ = INPUT$(8, #1)
1450   HEAD6$ = INPUT$(8, #1)
1460   DATAcnt = VAL(HEAD6$)
1470   DATAcnt = DATAcnt - 1
1480   HEAD7$ = INPUT$(16, #1)
1490   HEAD8$ = INPUT$(16, #1)
1500 '
1510   FUNC$ = INPUT$(14, #1)
1520   LABEL$ = INPUT$(24, #1)
1530   CLOCK$ = INPUT$(17, #1)
1540   DR$ = INPUT$(13, #1)
1550   HSCALE$ = INPUT$(14, #1)
1560   SPNSTR$ = INPUT$(31, #1)
1570   SPNEND$ = INPUT$(29, #1)
1580   VSCALE$ = INPUT$(8, #1)
1590   DBMAX$ = INPUT$(12, #1)
1600   VMAX = VAL(MID$(DBMAX$, 7, 3))
1610   DBMIN$ = INPUT$(12, #1)
1620   VMIN = VAL(MID$(DBMIN$, 7, 3))
1630   WLEN$ = INPUT$(11, #1)
1640   IDX$ = INPUT$(44, #1)
1650   PW$ = INPUT$(9, #1)
1660   MODE$ = INPUT$(13, #1)
1670   AVEG$ = INPUT$(23, #1)
1680   ORL$ = INPUT$(77, #1)
1690 RETURN
1700 '

```



Q8460A  
OPTICAL FIBER REFLECTOMETER  
INSTRUCTION MANUAL

3.7 Floppy Disk Drive Unit (when equipped as option)

```
1710 '
1720 *DSKINF
1730     FOR J=0 TO 6 : DUMMY$ = INPUT$(255, #1):NEXT J
1740     DUMMY$ = INPUT$(53, #1)
1750 RETURN
1760 '
1770 '
1780 *ASCDAT
1790     FOR I=0 TO DATAcnt
1800         WDAT1$ = INPUT$(4, #1)
1810         WDAT2$ = INPUT$(3, #1)
1820         DUMMY$ = INPUT$(1, #1)
1830         WDAT$ = WDAT1$ + WDAT2$
1840         WDATA[I] = VAL(WDAT$)
1850     NEXT I
1860 RETURN
1870 '
1880 '
1890 *BINDAT
1900     FOR I=0 TO DATAcnt
1910         WDAT1$ = INPUT$(1, #1)
1920         WDAT2$ = INPUT$(1, #1)
1930         WDAT3$ = INPUT$(1, #1)
1940         WDAT4$ = INPUT$(1, #1)
1950         WD1 = ASC(WDAT1$)
1960         WD2 = ASC(WDAT2$)
1970         WD3 = ASC(WDAT3$)
1980         WD4 = ASC(WDAT4$)
1990         WD = WD1*2^24 + WD2*2^16 + WD3*2^8 + WD4
2000 '
2010         IF HEAD4$="LIN" THEN
                GOSUB *LIN ——— Processes waveform data of "LIN" type
            ELSE GOSUB *DSPLOG — Processes waveform data of "DSP" or "LOG" type
2020     NEXT I
2030 RETURN
2040 '
2050 '
2060 *LIN
2070     IF WD>2^31 THEN GOTO 2080 ELSE GOTO 2110
2080         WDATA[I] = -100
2090         GOTO 2240
2100 '
2110     IF FUNC$="AVERAGE+PAUSE;" THEN GOTO 2120 ELSE GOTO 2180
2120         AVG = VAL(HEAD8$)
2130         IF AVG>=33024! THEN GOTO 2140 ELSE GOTO 2160
2140         WD = WD / 65536! / (AVG/2) — For data saved after averaging
                (if AVG≥33024)
2150         GOTO 2200
```

Q8460A  
OPTICAL FIBER REFLECTOMETER  
INSTRUCTION MANUAL

3.7 Floppy Disk Drive Unit (when equipped as option)

```
2160      WD = WD / 65536! / AVG ----- For data saved after averaging
                                         (if AVG<33024)
2170      GOTO 220
2180      WD = WD/65536! ----- For data saved in monitor mode
2190      '
2200      IF WD=0 THEN GOTO 2210 ELSE GOTO 2230
2210      WDATA[I] = -100
2220      GOTO 2240
2230      WDATA[I] = 5 * (LOG(WD) / LOG(10)) --- LOG-conversion
2240      RETURN
2250      '
2260      '
2270      *DSPLOG
2280      IF WD>=65536! THEN GOTO 2290 ELSE GOTO 2300
2290      WD = WD - 2^32
2300      WDATA[I] = WD / 65536!
2310      RETURN
2320      '
2330      '
2340      *GRAPH
2350      XMIN=80:XMAX=580
2360      YMIN=20:YMAX=150
2370      CLS 3
2380      SCREEN 0,0
2390      WINDOW(0, -VMAX)-(DATACNT, -VMIN)
2400      VIEW(XMIN, YMIN)-(XMAX, YMAX),,5
2410      '
2420      LOCATE 10, 1 : PRINT MID$(LABEL$, 1, 23)
2430      LOCATE 37, 1 : PRINT MID$(CLOCK$, 1, 16)
2440      LOCATE 58, 1 : PRINT MID$(DR$, 1, 12)
2450      LOCATE 4, 2 : PRINT MID$(DBMAX$, 7, 5)
2460      LOCATE 2,10 : PRINT MID$(VSCALE$, 1, 7)
2470      LOCATE 4,18 : PRINT MID$(DBMIN$, 7, 5)
2480      LOCATE 10,19 : PRINT MID$(SPNSTR$, 19, 12)
2490      LOCATE 65,19 : PRINT MID$(SPEND$, 17, 12)
2500      LOCATE 10,21 : PRINT MID$(WLEN$, 1, 10)
2510      LOCATE 26,21 : PRINT MID$(IDX$, 1, 13)
2520      LOCATE 45,21 : PRINT MID$(PW$, 1, 8)
2530      LOCATE 61,21 : PRINT MID$(MODE$, 1, 12)
2540      '
2550      FOR I=0 TO DATACNT-1
2560          LINE(I, -WDATA[I])-(I+1, -WDATA[I+1]),6
2570      NEXT I
2580      RETURN
```

Q8460A  
OPTICAL FIBER REFLECTOMETER  
INSTRUCTION MANUAL

3.7 Floppy Disk Drive Unit (when equipped as option)

Program 2

```

1000 '
1010 '
1020 '
1030 '   EXAMPLE PROGRAM
1040 '
1050 '   SAVE DATA BY FDD FUNCTIONS
1060 '
1070 '       MESURMENT MODE : REFLECTION
1080 '       DATA TYPE      : DSP, LIN
1090 '       DATA FORMAT    : ASCII, BINARY
1100 '
1110 '
1120 '
1130 DIM FILNAME$(20)
1140 DIM HEAD1$(16), HEAD2$(16), HEAD3$(16), HEAD4$(16)
1150 DIM HEAD5$(16), HEAD6$(16), GEAD7$(16), HEAD8$(16)
1160 DIM FUNC$(14), LABEL$(24), CLOCK$(17), DR$(13)
1170 DIM HSCALE$(14), SPNSTR$(31), SPNEND$(29), VSCALE$(8)
1180 DIM DBMAX$(12), DBMIN$(12), WLEN$(11), IDX$(44), PW$(9)
1190 DIM MODE$(13), AVEG$(23), ORL$(77), DUMMY$(255)
1200 DIM WDATA[16000], WDAT1$(4), WDAT2$(4), WDAT3$(4), WDAT4$(4)
1210 DIM WDAT$(8)
1220 '
1230 '
1240 '***** MAIN *****
1250 INPUT "FILE NAME:", FILNAME$  Specifies the name of a file in which
1260 FILNAME$ = "B:"+FILNAME$  data to be regenerated is saved.
1270 '
1280 OPEN FILNAME$ FOR INPUT AS #1
1290   GOSUB *DSKSTR  Reads display information and other
1300   GOSUB *DSKINF  Reads internal information
1310   IF HEAD5$="ASCII" THEN
1310       GOSUB *ASCDAT  Reads waveform data in "ASCII" format.
1310   ELSE GOSUB *BINDAT  Reads waveform data in "BINARY" format.
1320 CLOSE #1
1330 END
1340 '*****
1350 '
1360 '
1370 *DSKSTR
1380   HEAD1$ = INPUT$(16, #1)
1390   HEAD2$ = INPUT$(16, #1)
1400   HEAD3$ = INPUT$(16, #1)
1410   HEAD4$ = INPUT$(16, #1)
1420   HEAD5$ = INPUT$(16, #1)
1430   HEAD6$ = INPUT$(8, #1)

```

Q8460A  
OPTICAL FIBER REFLECTOMETER  
INSTRUCTION MANUAL

3.7 Floppy Disk Drive Unit (when equipped as option)

```
1440     HEAD6$ = INPUT$(8, #1)
1450     DATAcnt = VAL(HEAD6$)
1460     DATAcnt = DATAcnt - 1
1470     HEAD7$ = INPUT$(16, #1)
1480     HEAD8$ = INPUT$(16, #1)
1490     '
1500     DUMMY$ = INPUT$(255, #1)
1510     DUMMY$ = INPUT$(96, #1)
1520     RETURN
1530     '
1540     '
1550     *DSKINF
1560     DUMMY$ = INPUT$(255, #1)
1570     DUMMY$ = INPUT$(99, #1)
1580     RETURN
1590     '
1600     '
1610     *ASCSTAT
1620     FOR I=0 TO DATAcnt
1630         WDAT1$ = INPUT$(4, #1)
1640         WDAT2$ = INPUT$(4, #1)
1650         WDAT3$ = INPUT$(2, #1)
1660         DUMMY$ = INPUT$(1, #1)
1670         WDAT$ = WDAT1$ + WDAT2$ + WDAT3$
1680         WDATA[I] = VAL(WDAT$) / 8
1690         PRINT I, WDATA[I]
1700     NEXT I
1710     RETURN
1720     '
1730     '
1740     *BINDAT
1750     FOR I=0 TO DATAcnt
1760         WDAT1$ = INPUT$(1, #1)
1770         WDAT2$ = INPUT$(1, #1)
1780         WDAT3$ = INPUT$(1, #1)
1790         WDAT4$ = INPUT$(1, #1)
1800         WD1 = ASC(WDAT1$)
1810         WD2 = ASC(WDAT2$)
1820         WD3 = ASC(WDAT3$)
1830         WD4 = ASC(WDAT4$)
1840         WD = WD1*224 + WD2*216 + WD3*28 + WD4
1850         WDATA[I] = WD / 8
1860         PRINT I, WD, WDATA[I]
1870     NEXT I
1880     RETURN
```

Q8460A  
OPTICAL FIBER REFLECTOMETER  
INSTRUCTION MANUAL

3.8 Label

The information can be labeled to the storage data by using one to 23 alphanumeric characters. The label is set at the top line on the screen. Press the MENU key to select the ADVANCE FUNCTION mode, and select the LABEL option. The follow screen will be displayed. Display the input character in the reverse mode by using the data knob, and press the [ENTER] key. The character will be entered.

- DELETE : Deletes a character from the cursor position.
- ← : Moves the cursor to the left.
- : Moves the cursor to the right.
- ALL DELETE :Deletes all characters simultaneously.

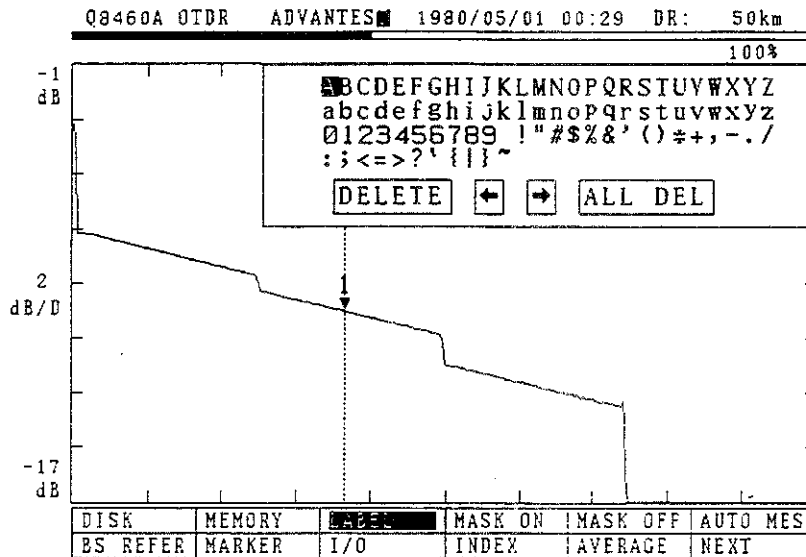

Figure 3 - 44 Label Screen

Q8460A  
OPTICAL FIBER REFLECTOMETER  
INSTRUCTION MANUAL

3.9 Display

---

### 3.9 Display

The operator can select the type of graphic, such as DOT/LINE and dimension units, such as km/kft.

Press the MENU key and select the ADVANCE FUNCTION mode, then select the "DISPLAY" on-screen.

Press the ENTER key and select the SIGNAL/UNITS on-screen.

#### (1) Selecting the DOT/LINE mode

Check that the cursor is on "SIGNAL".

DOT --- Turn the data knob counterclockwise.

LINE --- Turn the data knob clockwise.

#### (2) Selecting the dimension unit

Press the ENTER key and move the cursor to "UNITS" on-screen.

km --- Turn the data knob clockwise.

kft --- Turn the data knob counterclockwise.

Q8460A  
OPTICAL FIBER REFLECTOMETER  
INSTRUCTION MANUAL

3.10 CLOCK

---

### 3.10 Clock

The operator can set time (minute and hour), date, month and year.

Press the MENU key and select the ADVANCE FUNCTION mode, then select "CLOCK" on-screen.

Press the ENTER key and select the setting item.

- (1) Year ---- Check that the cursor is on "YEAR".  
Set an appropriate number by turning the data knob.
- (2) Month --- Press the ENTER key and move the cursor to "MONTH".  
Set an appropriate number by turning the data knob.
- (3) Date ---- Press the ENTER key and move the cursor to "DAY".  
Set an appropriate number by turning the data knob.
- (4) Hour ---- Press the ENTER key and move the cursor to "HOUR".  
Set an appropriate number by turning the data knob.
- (5) Minute -- Press the ENTER key and move the cursor to "MIN".  
Set an appropriate number by turning the data knob.

Q8460A  
OPTICAL FIBER REFLECTOMETER  
INSTRUCTION MANUAL

3.11 I/O

---

3.11 I/O

To specify the following three parameters:

Press the MENU key to select the ADVANCED FUNCTION mode.

Select the parameter and press the ENTER key.

(1) GPIB address

Specifies the device address for remote control via the GPIB. An address can be specified within addresses 0 to 30. Use the data knob for address setup.

(2) HDCOPY

Outputs a hardcopy of the on-screen information of the device. Select one of the following two outputs by using the data knob:

- PRINTER ..... Built-in thermal printer
- PLOTTER ..... External plotter

(3) BUZZER

Turns on or off the key input tone or input disable tone.

- ON: Sounds the key input tone or input disable tone when a key is typed.
- OFF: Does not sound the tone.



Q8460A  
OPTICAL FIBER REFLECTOMETER  
INSTRUCTION MANUAL

3.12 Outputting the Data On-screen

---

3.12 Outputting the Data On-screen

This reflectometer can output the data on-screen by using either the internal printer or an external plotter. As for the procedure of selecting the internal printer or an external plotter, refer to the Section 3.10.

(1) Outputting via the internal printer

Check that the "PRINTER" has been selected in the ADVANCE FUNCTION mode. Press PRINT/PLOT key, and the data is output. If the operator presses the FEED key, the printer feeds the thermosensitive paper.

(2) Outputting via the external plotter

① Procedure

- Using "I/O" of the ADVANCE FUNCTION mode, make sure that "PLOTTER" (plotter output) is selected.
- Make sure that the plotter is set to the LISTEN ONLY mode.
- Press the PRINT/PLOT key to start plotter output.

NOTE

1. To ensure minimum wear on the pen tip and minimum output time, all waveforms are output onto the plotter line-by-line, irrespective of whether the DOT mode or the LINE mode is being displayed on the CRT.
2. Information displayed on the HELP screen will not be output onto the plotter.

② Applicable plotters

R9833 (ADVANTEST)  
HP7470A (HP)  
HP7475A (HP)

Q8460A  
OPTICAL FIBER REFLECTOMETER  
INSTRUCTION MANUAL

3.12 Outputting the Data On-screen

---

③ Selecting the tracing pen

The following table shows pen number and description of the plotter output.

Pen number	Description
1	A character string
2	Window display (including characters in the window)
3	Bar, signal frame, and window frame
4	Waveforms
5	Dual waveforms
6	Marker
7	Cursor

Q8460A  
OPTICAL FIBER REFLECTOMETER  
INSTRUCTION MANUAL

3.13 Automatic Measuring Function

3.13 Automatic Measuring Function

The automatic measuring function can automatically detect features on the optical fiber such as contact position, connection type, and end point (break point) position and measure the splice loss and ORL for each feature.

Up to 16 such connect positions or break points can be measured. They are measured by using the on-screen data only.

There are two types of automatic measuring function:

① ALL mode

Up to 16 splice positions, break points, loss, ORL, and connect position types can be displayed simultaneously.

② STEP mode

Up to 16 connect positions, break points, loss, and connect position types of the on-screen data can be displayed for each point one after the other.

Selecting the automatic measuring function:

Press the MENU key and select the AUTO MES option, and the following screen will be displayed:

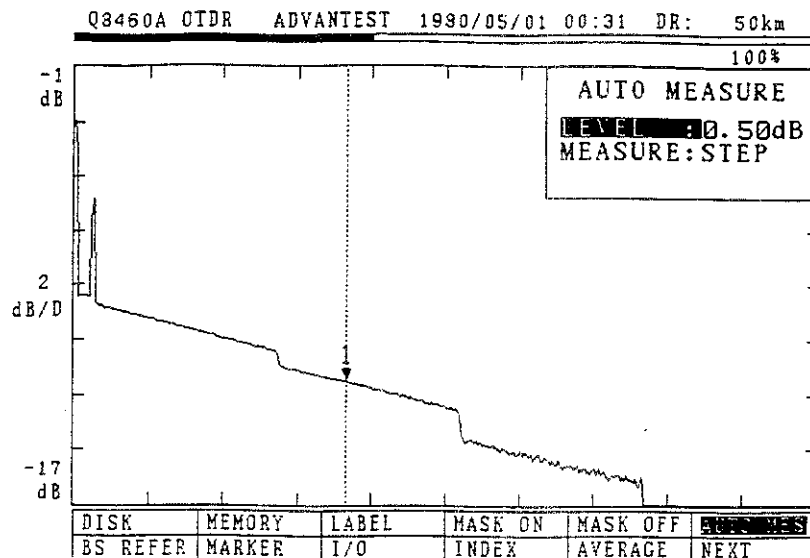

Figure 3 - 45 Automatic Measurement Setup Screen

Q8460A  
OPTICAL FIBER REFLECTOMETER  
INSTRUCTION MANUAL

3.13 Automatic Measuring Function

Select the LEVEL or MEASURE option and press the ENTER key.

LEVEL : Enter the splice loss for detection. It can be entered within 0.05 dB to 9.99 dB at 0.01 dB step.

MEASURE: Select the ALL or STEP mode.

NOTE

The LEVEL value is a threshold, all losses  $\geq$  than this level will be detected. If averaging is insufficient, a non-splice point may also be detected as the splice point. In such case, increase the averaging count or increase the pulse width to provide better S/N for measurement.

When the LEVEL value is increased sufficiently, the Fresnel reflection connect position, broken point, and endpoint only are measured.

(1) Automatic measurement in ALL mode

Press the MENU key to select the AUTO MES mode.

Measure the LEVEL option, and select the ALL option of the MEASURE.

When the measuring conditions are all satisfied, repeat averaging enough times and collect the on-screen waveform data.

Then, press the AUTO key and press the ENTER key for execution. The following screen will be displayed. Scroll the list by using the data knob.

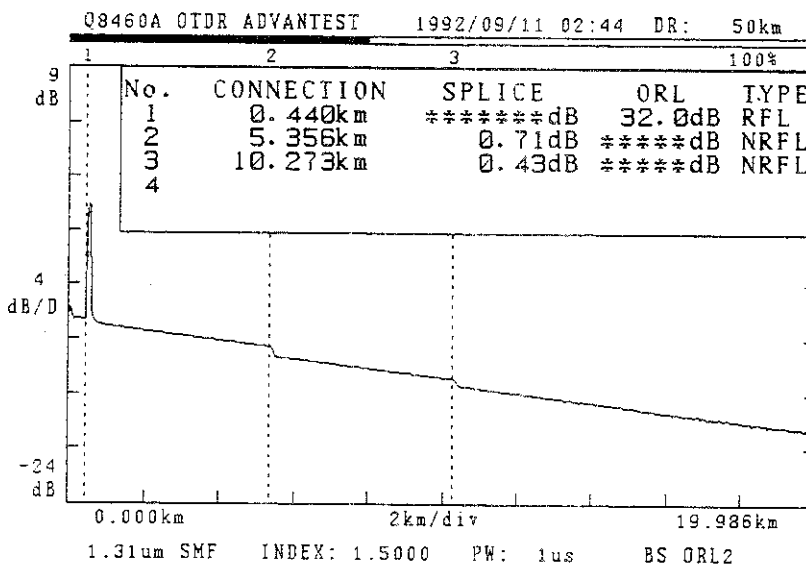

Figure 3 - 46 All Mode Display

Q8460A  
OPTICAL FIBER REFLECTOMETER  
INSTRUCTION MANUAL

3.13 Automatic Measuring Function

---

Explanation of window display

CONNECTION: Displays the feature position.

SPLICE: Displays the splice loss.

ORL : Displays the ORL.

TYPE: Displays the feature type as follows:

RFL: Connect position having the Fresnel reflection

NRFL: Fusion splicing connect position

END: End point or break point of optical fiber cable

Releasing:

Press the AUTO key, and the automatic measurement mode will be released.

NOTE

The automatic measurement fails if the pulse width is  $1\mu\text{s}$  and the horizontal span is 200m or less or if the horizontal span is 50m and the pulse width is not equal to  $1\mu\text{s}$ . Also, the BACKSCATTER and REFLECTION modes can not be switched to each other. The Marker, Vertical Scale, and Horizontal Span cannot be changed.

(2) Automatic measurement in STEP mode

Press the MENU key and select the AUTO MES option.

Set the LEVEL value and select the STEP option for the MEASURE. When the measuring conditions are all satisfied, repeat averaging enough times and collect the on-screen waveform data.

Then, press the AUTO key and press the ENTER key for execution. The following screen will be displayed. Scroll the connect position by using the SAVE and VIEW keys.

Q8460A  
OPTICAL FIBER REFLECTOMETER  
INSTRUCTION MANUAL

3.13 Automatic Measuring Function

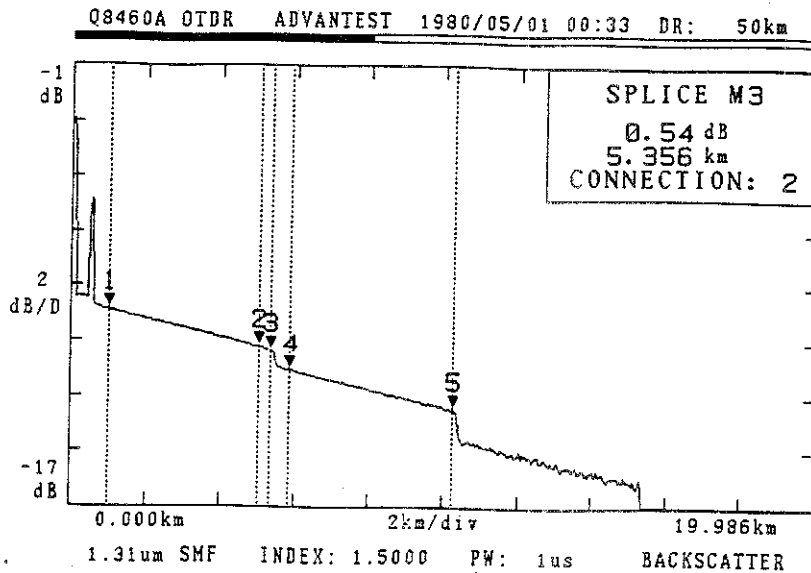

Figure 3 - 47 STEP Mode Display

The window shows the distance from the device output end and the splice loss at this point.

The CONNECTION value shows the "n-th" connection point of the waveform data.

Releasing:

Press the AUTO key, and the automatic measurement will be released.

NOTE

The automatic measurement fails if the pulse width is 1 $\mu$ s and the horizontal span is 200m or less or if the horizontal span is 50m and the pulse width is not equal to 1 $\mu$ s. Also, the BACKSCATTER and REFLECTION modes can not be switched to each other.

Q8460A  
OPTICAL FIBER REFLECTOMETER  
INSTRUCTION MANUAL

3.14 Multiple Reflection

3.14 Multiple Reflection

(1) Multiple reflection due to excessive Fresnel reflection

When optical signals are output from the bulkhead of the Q8460A, part of optical pulses are returned from the breakpoint of optical fiber cable as a Fresnel reflection (called the primary Fresnel reflection). These reflected pulses are reflected at the bulkhead and output again.

Part of optical pulses are again reflected and returned from the breakpoint (called the secondary reflection). Such repeated reflection of pulses are called the multiple reflection. This may cause a Fresnel reflection at point other than the connection point or breakpoint.

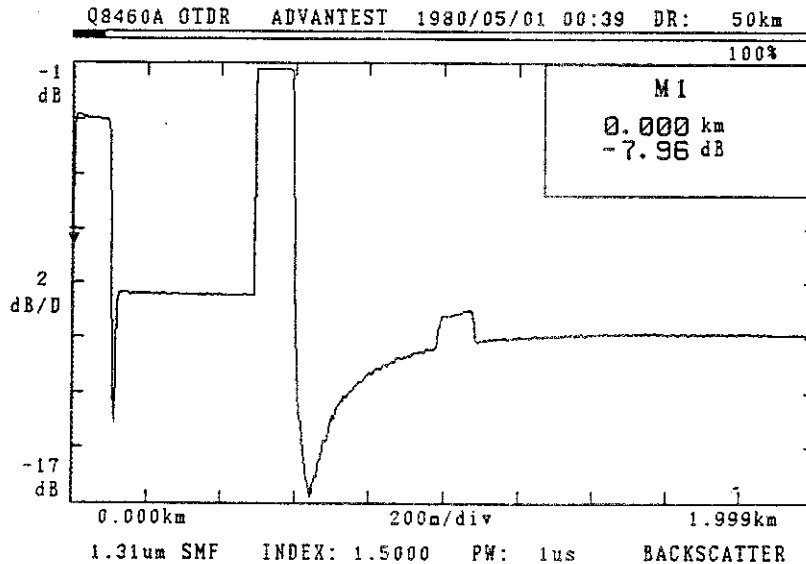
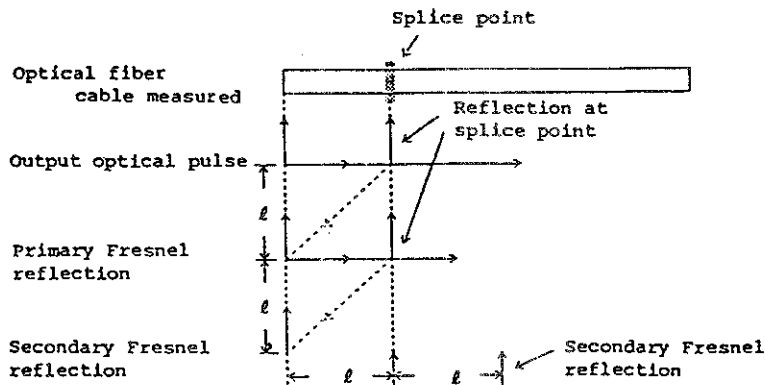

Figure 3 - 48 Multiple Reflection Display

If the optical fiber cable is measured at the connection point which is located in distance  $\ell$  from the output terminal as shown in the figure, the secondary reflection may appear at point  $2\ell$ . Further reflections are very small and does not appear.



Q8460A  
OPTICAL FIBER REFLECTOMETER  
INSTRUCTION MANUAL

3.14 Multiple Reflection

- (2) Fresnel reflection according to the distance range and optical fiber length

If the length of optical fiber cable being measured is a half or more of the length of repeated pulses, the second reflection may occur as shown in the figure below.

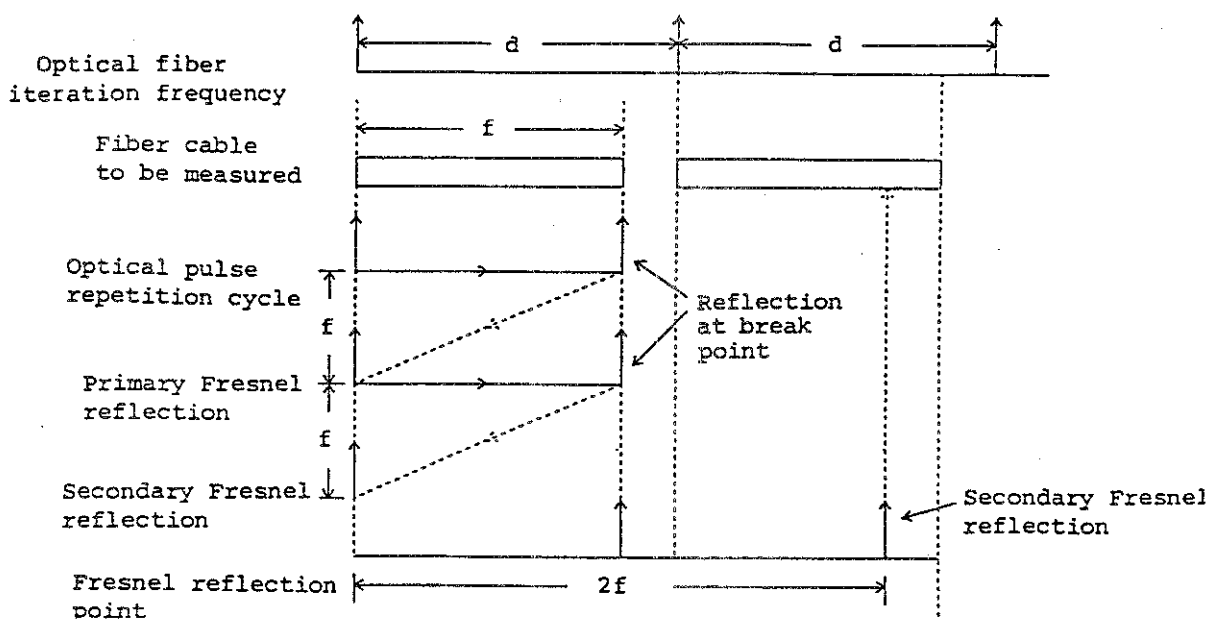

If the optical pulse iteration frequency is "d", the length of optical fiber cable being measured is "f", and if  $d < 2f$ , the primary Fresnel reflection may occur at the far end of the optical fiber cable. The secondary Fresnel reflection may occur at the point in distance "2f". This point is located in the distance of "f-(d-f)" from the optical pulse output terminal. If the range of distance is set to 64 km on the Q8460A system, for example, the optical pulses are repeated every 860 usec (that is roughly equivalent to the 86 km long fiber cable). If the 60 km long optical fiber cable is measured in this range, the location of secondary Fresnel reflection can be calculated as follows:

$$60(\text{km}) - (86(\text{km}) - 60(\text{km})) = 34(\text{km})$$

To eliminate the multiple reflection:

- ① Adjust the connection point to prevent excessive Fresnel reflection or coat the optical fiber cable with the matching oil (optical fiber cable matching solvent).
- ② If the multiple reflection is detected, select the larger range of distance. (Measure the cable in the range of distance that is 2 times or more of the length of the optical cable being measured.)



Q8460A  
OPTICAL FIBER REFLECTOMETER  
INSTRUCTION MANUAL

4.1 Q8460A System

---

4. OPERATION PRINCIPLE

4.1 Q8460A System

The Q8460A system block diagram is shown in Figure 4-1.

The signal of the 100MHz crystal oscillator is divided by the clock generator according to the range of distance and span being set. The timing generator operates by using this clock. It generates signals of adder circuit timing, LD emission trigger timing and mask trigger timing. The LD emission trigger signal is output by the timing generator. This signal is then sent to the plug-in unit to light the LD. Then, the signal is passed through the optical fiber cable being measured. The returned optical signals are converted into electric signals and sent to the system.

The returned signal is converted into digital data by the A/D converter. The A/D converter operates based on the clock generated by the clock generator. Up to 16,000 points of data are converted for a single LD emission. The converted data is added to the data of the same point of RAM1 by the adder circuit. The resulting data is stored in RAM1 again. This addition is called the averaging addition and it is useful to remove the noise components from the signal.

Averaging is executed 256 times in the Monitor mode. While in the Averaging mode, it is executed 2 powered by 12 times minimum or 2 powered by 24 times maximum.

After the averaging addition, the RAM1 data is stored in RAM2 by CPU1. The data logged in RAM2 is converted into the display data by the CRT controller. This data is stored in the video RAM. The CRT controller also outputs the vertical and horizontal sync signals to drive the CRT. The sync signals are combined with the video RAM data, and they are sent to the CRT driver and displayed on the CRT screen.

Similarly, the composite signals are generated by the CRT driver and they are output to a peripheral via the Video Out terminal.

Q8460A  
OPTICAL FIBER REFLECTOMETER  
INSTRUCTION MANUAL

4.1 Q8460A System

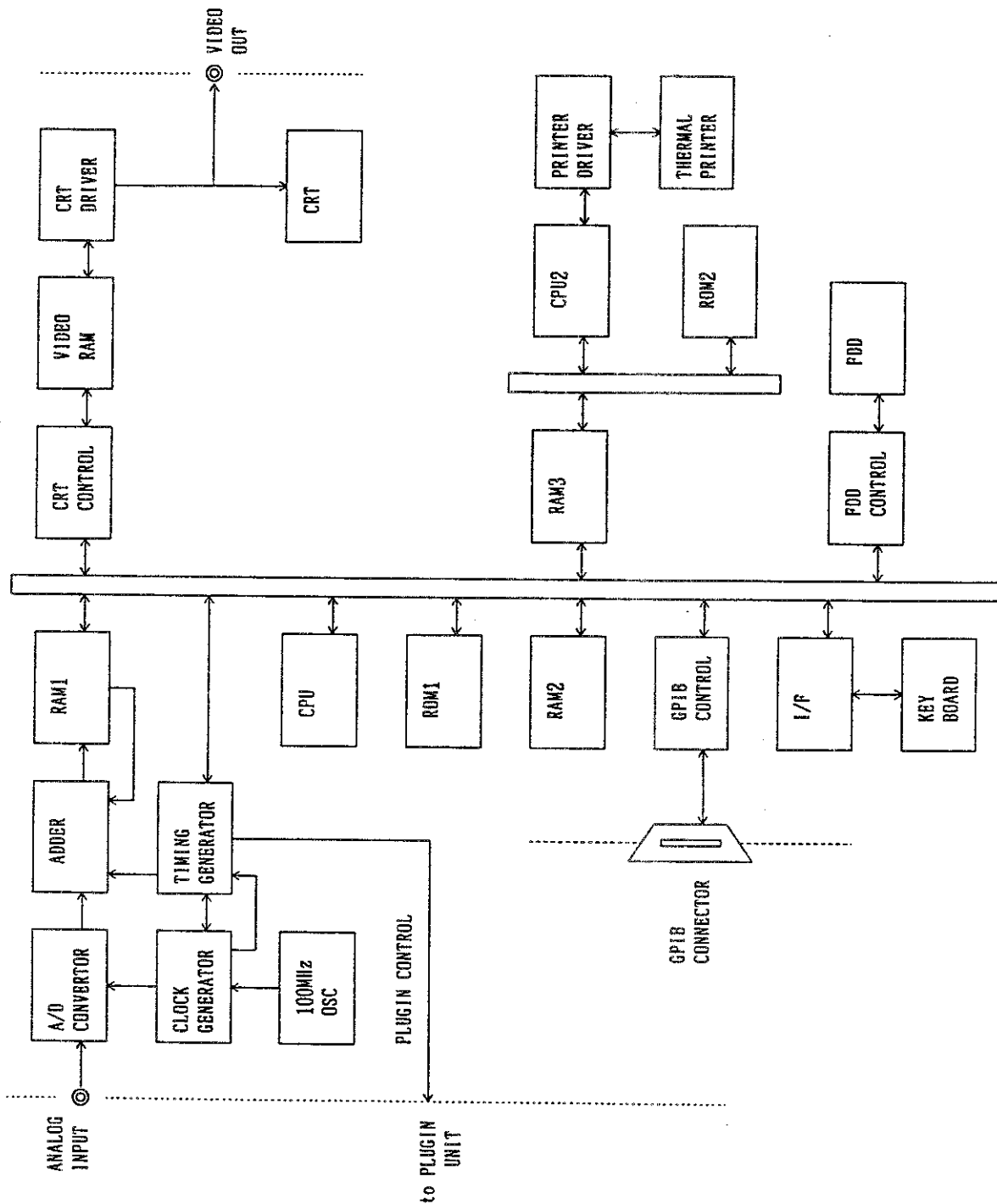

Figure 4 - 1 Q8460A System Block Diagram

Q8460A  
OPTICAL FIBER REFLECTOMETER  
INSTRUCTION MANUAL

4.2 Plug-in Unit

---

#### 4.2 Plug-in Unit

The block diagram of plug-in unit is shown in Figure 4-2. When receiving an LD trigger signal from the Q8460A, the plug-in unit generates LD pulses according to the pulse width set by the LD pulse generator. The LD pulses are sent to the LD driver to emit the LD. The LD pulses are also sent to the mask pulse generator. They are used to output a mask signal, drive the A/O driver to activate the A/O switch, and prevents Fresnel reflection to the optical sensor. (Q84601/Q84621/Q84621A) This can prevent the reduced linearity due to saturation of amplifier during excessive input. The A/O switch is also activated when a Mask Trigger signal is input from the mask pulse generator. The Fresnel reflection can be masked at any point.

The optical pulses are sent to the optical fiber cable being measured. The optical pulses reflected from the optical fiber cable being measured are converted into optoelectric signals by the APD. The converted signals are sent to the I-V converter. Then, they are amplified by the I-V converter and amplifier and the resulting signals are sent to the system. The level of returned optical pulses varies according to the wavelength and pulse width. The amplifier gain must be adjusted to have an appropriate level of signals by using the gain control of the amplifier. The signal level can be adjusted by the input of gain control signals.

Q8460A  
OPTICAL FIBER REFLECTOMETER  
INSTRUCTION MANUAL

4.2 Plug-in Unit

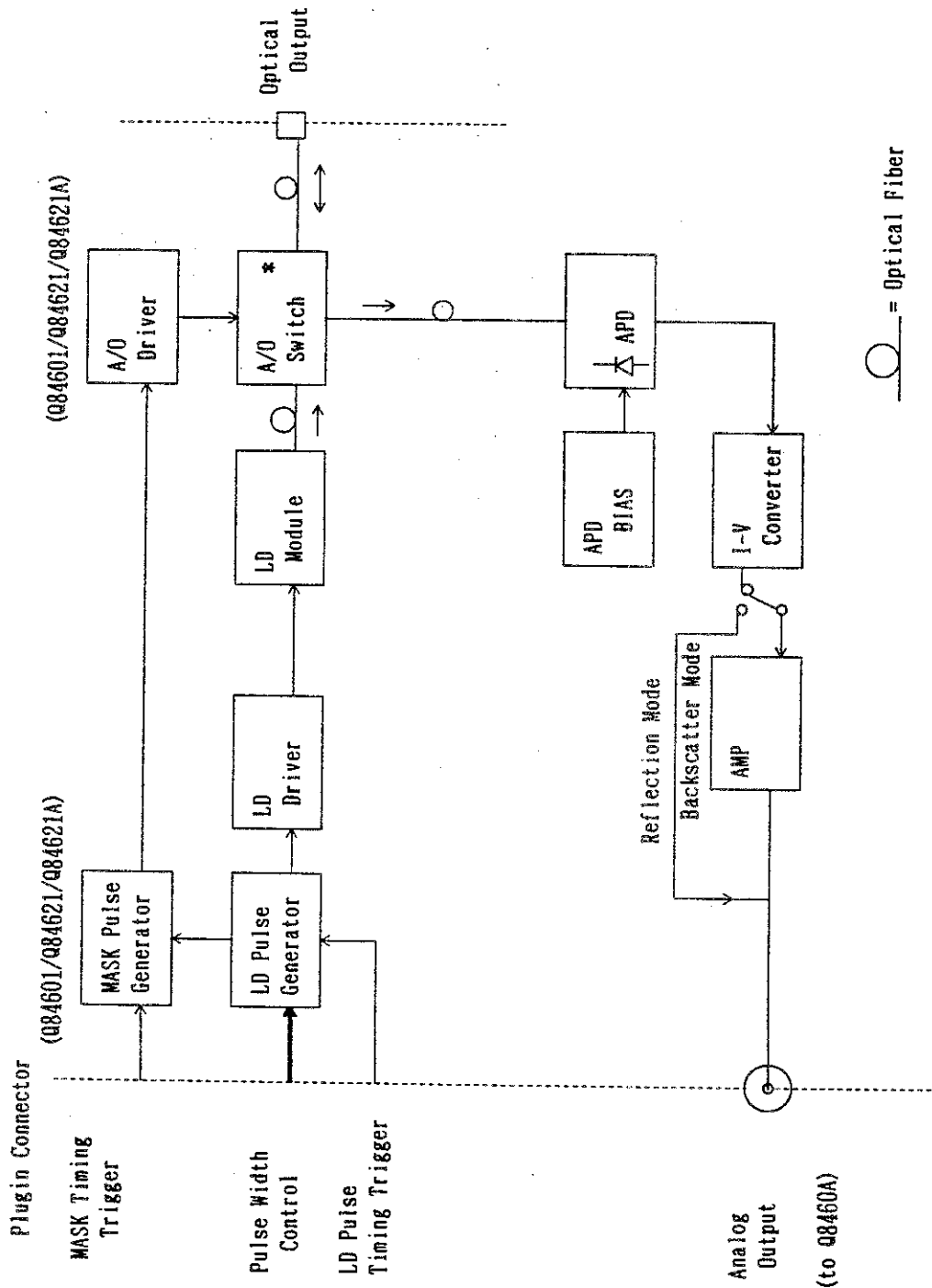

Figure 4 - 2 Block Diagram of Plug-in Unit

Q8460A  
OPTICAL FIBER REFLECTOMETER  
INSTRUCTION MANUAL

5. REMOTE CONTROL VIA GPIB

5.1 General

The Q8460A optical time domain reflectometer can operate in the remote control mode via the standard IEEE-488-1978 GPIB (General-Purpose Interface Bus).

5.1.1 Outline of GPIB

The GPIB is an interface system that can configure an automatic measuring system by simply connecting the controllers and peripheral devices using the bus cable. When compared with the conventional interfacing, the GPIB provides the much higher flexibility in system expansion. Also it provides the electrical, mechanical, and functional compatibility with the products of different manufacturers. A full lineup from the very simple system to the system having the highest functions can be configured by using a single bus cable. For the GPIB system, each device connected via the bus lines must be assigned a different address. Each device can have one or more of controller, talker and listener functions. Only one talker can send data onto the bus lines, and multiple listeners can receive the data. The controller addresses the talker and listeners so that the data can be transferred from the talker to the listeners. Also, the controller (talker) can set the measuring conditions for the listeners. The bit parallel and byte serial eight data lines are provided for data transfer between system devices. Data is transferred asynchronously in both directions. Because the system is asynchronous, both the high-speed and low-speed devices can be mixed. The data (messages) to be transferred between devices are the measuring data and measuring conditions (programs), and various commands. ASCII codes for data are used. In addition to 8 data lines, 3 handshaking lines are provided to control asynchronous data transfer between devices. Also, 5 control lines are provided to control information flow on the buses.

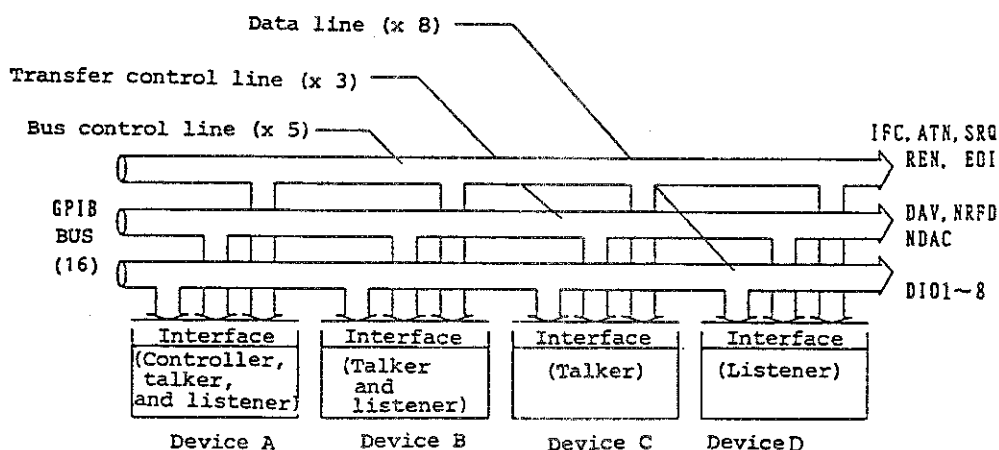

Figure 5 - 1 GPIB Bus Lines

Q8460A  
OPTICAL FIBER REFLECTOMETER  
INSTRUCTION MANUAL

5.1 General

---

- The following signals are transferred via the handshaking lines:

DAV (Data Valid) : The signal indicating the data validity  
NRFD (Not Ready For Data) : The signal indicating the data receive ready status  
NDAC (Not Data Accepted) : The signal indicating the end of data receive status

- The following signals are transferred via the control lines:

ATN (Attention) : The signal which indicates that the signals on the data line are address or command or any other information  
IFC (Interface Clear) : The signal which clears interfacing  
EOI (End of Identify) : The signal used to indicate the end of information transfer  
SRQ (Service Request) : The signal which is sent from any device to the controller to request for service  
REN (Remote Enable) : The signal for remote control of a device that can be programmed for remote control

#### 5.1.2 GPIB Standards and Specifications

Standard : IEEE488-1978  
Codes used : ASCII codes, or binary codes for packed formatted  
Logic level : Logical 0 (high) at +2.4 VDC or more  
                  Logical 1 (low) at +0.4 VDC or less  
Driver specifications  
                  : Open collector (except EOI and DAV)  
                  logical low at +0.4 VDC or less, 48 mA Logical high at +2.4 VDC or more, -5.2 mA  
Receiver specifications  
                  : Logical low at +0.6 VDC or less  
                  Logical high at +2.0n VDC or more  
Addressing : Up to 31 talk and listen addresses can be set by using the ADDRESS switch.  
Cable length : The total length of bus cables is limited to the following:  
                  (No. of devices connected to the bus) x 2 m and less  
                  20 m

Q8460A  
OPTICAL FIBER REFLECTOMETER  
INSTRUCTION MANUAL

5.1 General

Connector: 24-pin GPIB connector (57-20240-D35A Amphenol or equivalent)

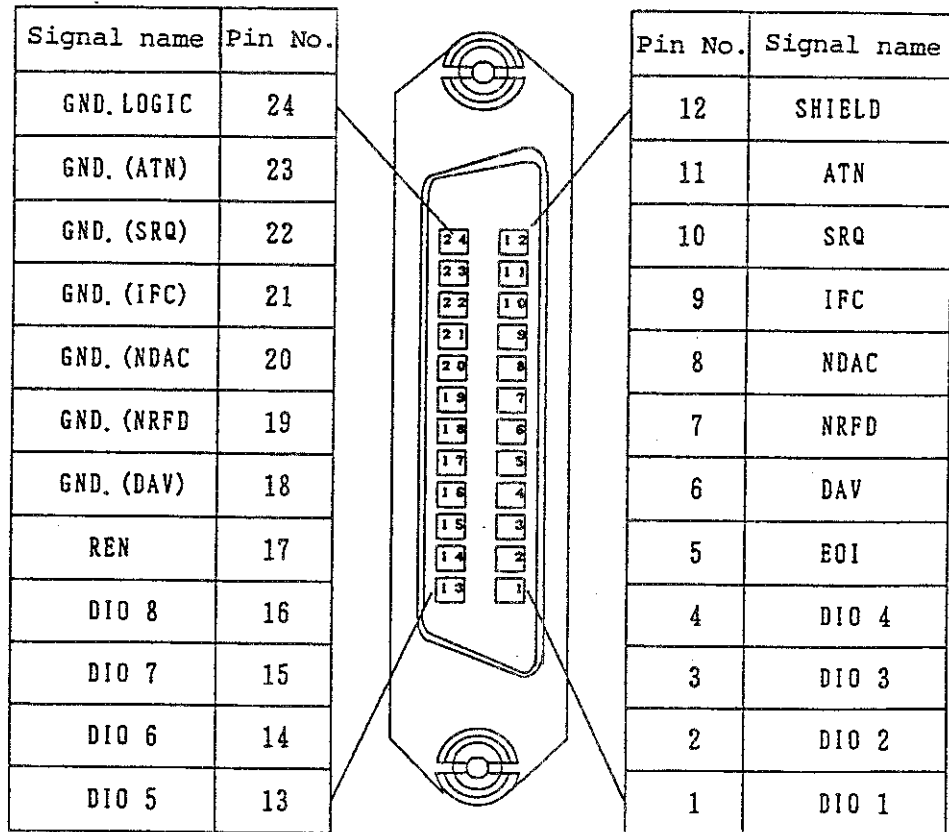

Figure 5 - 2 GPIB Connector

Q8460A  
OPTICAL FIBER REFLECTOMETER  
INSTRUCTION MANUAL

Interface functions:[Table 5-1]

Table 5 - 1 Interface Functions

Code	Function and Explanation
SH1	Source handshaking function
AH1	Acceptor handshaking function
T5	Basic talker function, serial polling function, talker only function, and talker release function by specifying the listener
L4	Basic listener function, and listener release function by specifying the talker
SRI	Service request function
RL1	Remote control function
PPO	Without parallel function
DCO	Device clear function
DTO	Without device trigger function
CO	Without controller function
E2	Tristate output

### 5.1.3 Connecting System Devices

As a GPIB system is configured by various devices and equipment, the following notes should be followed during preparation:

- (1) Check the normal status (for preparation) and operation of the connected devices by referring to the instruction manuals of the controller and peripheral devices.
- (2) Avoid using excessive length of bus cables when connecting the measuring instrument and controller. The length of bus cable should not exceed the following limit:  
(No. of devices connected to the bus) x 2 m and less 20 m



Q8460A  
OPTICAL FIBER REFLECTOMETER  
INSTRUCTION MANUAL

The following standard bus cables are available as optional.

Table 5 - 2 Standard Bus Cables (Optional)

Length	Cable Name
0.5 m	408JE-1P5
1 m	408JE-101
2 m	408JE-102
4 m	408JE-104

- (3) The bus cable has piggy-back connectors. A single connector consists of the male and female connectors and they can be used as a pair. However, do not use 3 or more connectors as a pair. The connector must be secured by using the tightening screws.
  
- (4) Check the power conditions, grounding and setup conditions of each device before turning its power supply on. The power supply of all devices connected to the GPIB must be turned on. If not, the entire system operation is unreliable.

Q8460A  
OPTICAL FIBER REFLECTOMETER  
INSTRUCTION MANUAL

5.1.4 GPIB Keys on Operation Panel

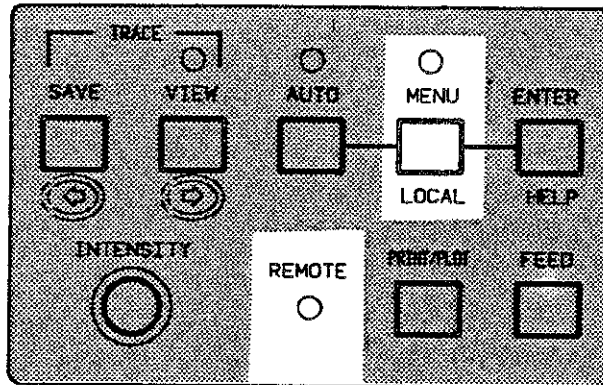

① MENU (LOCAL) key

Releases the remote control mode if the Q8460A system is in the remote control mode (the REMOTE LED is on). In the local mode, the key input on the front panel is made valid.

When the system power supply is turned on, the local mode is selected automatically.

② REMOTE LED

Kept on when the Q8460A system is controlled by an external controller in the remote control mode. In the remote control mode, the key input on the front panel is made invalid.

③ Setting the GPIB address

The setting of the GPIB address can be changed by the ADVANCE FUNCTION mode.

Press the MENU key and select the ADVANCE FUNCTION mode, then select "I/O". Select the GPIB address by turning the data knob.

NOTE

The equipment will enter the TALK ONLY mode if you select "I/O" following setting of the ADVANCE FUNCTION mode using the MENU key and then select "PLT" (plotter output) from "HDCOPY" (hardcopy). To operate the equipment in the ADDRESSABLE mode, therefore, change "PLT" over to "PRT" (printer output).

Q8460A  
OPTICAL FIBER REFLECTOMETER  
INSTRUCTION MANUAL

5.2 Service Request

5.2 Service Request

When the Q8460A system is set to the S0 mode and when each bit of the status byte is set to "1", the Q8460A sends a service request to the controller.

The system sends the status byte after serial polling from the controller.

Status byte

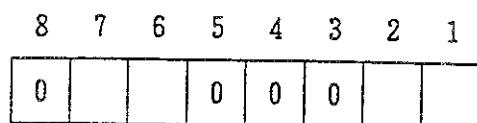

Logical 1 is set at the end of measurement.

Logical 1 is set if a syntax error occurs.

Logical 1 is set at the end of averaging.

Request Service (RQS).

Logical 1 is set if one or more of bits 1, 2 and 6 is (are) set to logical 1.

Q8460A  
OPTICAL FIBER REFLECTOMETER  
INSTRUCTION MANUAL

5.3 GPIB Talker Format

5.3 GPIB Talker Format

Issue the read command to output the GPIB talker format. There are two types of outputs as the following; the binary output and ASCII output according to the read command it has been issued.

① Binary output

Available commands:

- 1 byte per data: RDTB, RMDB, RADB
- 2 bytes per data: RDTW, RMDW, RADW
- 4 bytes per data: RDTL, RMDL, RADL

Format:

Header	Data 1	Data 2		Data N	BD
--------	--------	--------	--	--------	----

Header: 6-byte ASCII data to be set by the "Hn" command.

It is output only when the header output is set to ON (see paragraph ⑧ of Subsection 5.3.1).

Data: See the related read command.

BD: Block delimiter to be set by "DLn".

② ASCII format

If multiple data sets are used:

Header	Data 1	SD	Data 2	SD		SD	Data N	BD
--------	--------	----	--------	----	--	----	--------	----

If a single data set is used:

Header	Data	BD
--------	------	----

Multiple data sets or a single data set can be used depending on the specified read command. See the related read command section.

Header: 6-byte ASCII data to be set by the "Hn" command.

It is output only when the header output is set to ON.

SD: String delimiter to be set by the "SLn" command.  
(see paragraph ⑦ of Subsection 5.3.1).

BD: Block delimiter to be set by the "DLn" command.  
(see paragraph ⑥ of Subsection 5.3.1).

Q8460A  
OPTICAL FIBER REFLECTOMETER  
INSTRUCTION MANUAL

5.3 GPIB Talker Format

5.3.1 GPIB Setting Commands

The following lists the GPIB setting commands and provides their detailed explanation.

Table 5 - 3 GPIB Setting Command List (1 of 2)

	Command	Function	Page
①	C	Clear	5 - 11
②	Z	Clear to initialization	5 - 12
③	Sn	Issue or no issue of service request	5 - 13
④	SMKn	Mask of service request	5 - 13
⑤	CS	Clear the status byte	5 - 13
⑥	DLn	Select the delimiter mode	5 - 14
⑦	SLn	Select the string delimiter mode	5 - 14
⑧	Hn	Display or no display of header	5 - 15
⑨	MON	Select the monitor mode	5 - 16
⑩	AVG	Select the averaging mode	5 - 16
⑪	PSE	Pause	5 - 16
⑫	IDXn	Set an index	5 - 16
⑬	DRn	Set the distance range	5 - 17
⑭	GANN	Select the measuring mode	5 - 17
⑮	XSPn SSPn	Set the horizontal span	5 - 18
⑯	SSTn	Set the horizontal position	5 - 24
⑰	VSLn	Set the vertical scale	5 - 24
⑱	VPSn	Set the vertical position	5 - 25
⑲	PWn	Set the pulse width	5 - 25
⑳	KNBn	Select the rapid mode	5 - 25

Q8460A  
OPTICAL FIBER REFLECTOMETER  
INSTRUCTION MANUAL

5.3 GPIB Talker Format

Table 5 - 3 GPIB Command List (2 of 2)

Command	Function	Page	
⑳	WLn	Set the wavelength	5 - 26
㉑	TST	Save the dual trace waveforms	5 - 26
㉒	TVWn	Display or no display of dual trace waveforms	5 - 26
㉓	LSSn	Select a marker (standard of ADVANCED FUNCTION)	5 - 27
㉔	SPMn	Select a marker (ADVANCED FUNCTION)	5 - 27
㉕	MKAn MKBn MKCn MKDn MKE n	Set a marker	5 - 28
㉖	MSTn	Save the waveform memory	5 - 28
㉗	MRCn	Recall the waveform memory	5 - 29
㉘	MDLn	Delete the waveform memory	5 - 29
㉙	LBLn	Set a label	5 - 29
㉚	PFD	Printer feeding	5 - 29
㉛	PRT	Print out	5 - 30
㉜	CLOCKn	Set a clock	5 - 30
㉝	WAVEn	Set the No. of display dots per line	5 - 30
㉞	MILEn	Select the km or kft display mode	5 - 30
㉟	SAVGn	Set the No. of averaging times	5 - 31
㊱	MSKSn	Set mask	5 - 31
㊲	MSKC	Clear mask	5 - 31
㊳	OREFn	Set the reference level of ORL function	5 - 32
㊴	AUTOn	Start automatic measurement	5 - 33
㊵	ALVLn	Set the automatic measurement detect level	5 - 33
㊶	BZn	Turn the buzzer on or off	5 - 33

Q8460A  
OPTICAL FIBER REFLECTOMETER  
INSTRUCTION MANUAL

5.3 GPIB Talker Format

---

① c

Function:

Clears the system to the initial status that is the same as when its power supply is turned on.

Parameter:

None

Explanation:

The present setup state (such as pulse width and distance range) does not change. The following are set:

Item	Status
MONITOR/AVERAGE	MONITOR
PAUSE	ON
DUAL TRACE function	OFF
MENU	OFF
HELP function	OFF
Auto measurement function	OFF

Q8460A  
OPTICAL FIBER REFLECTOMETER  
INSTRUCTION MANUAL

5.3 GPIB Talker Format

② z

**Function:**

Clears the system to its initial status.

**Parameter:**

None

**Explanation:**

The system is set to the following status:

Item	Initial setting
DISTANCE RANGE	15km
PULSE WIDTH	100ns
INDEX	1.5000
Measurement mode	BACKSCATTER
LABEL	Q8460A OTDR ADVANTEST
RAPID	OFF
MASK	Clear
MEMORY SAVE DATA	Clear
GPIB ADDRESS	Not changed
HDCOPY	PRINTER
DISPLAY SIGNAL	LINE
DISPLAY UNITS	km
AVERAGE repeat count	256
BUZZER	ON
ORL BS REFER LEVEL	-49.0dB (1.31 $\mu$ m) -52.0dB (1.55 $\mu$ m)
AUTO MEASURE LEVEL	STEP 0.50dB
MARKER	STANDARD-DISTANCE
VERTICAL SCALE POSITION	4dB/DIV 0 to -32dB



QB460A  
OPTICAL FIBER REFLECTOMETER  
INSTRUCTION MANUAL

③ Sn

Function:  
Issue a service request.

Parameter:

n = 0	Issues a service request.
n = 1	Does not issue a service request.

Explanation:

The "Sn" command issues a service request if the S0 mode has been selected (as described in Section 5.2).

④ SMKn

Function:  
Masks the service request.

Parameter:  
n = 0 to 127

Explanation:

This command masks the status byte. Once masked, a service request of the masked bit is ignored. Parameter "n" is a decimal value.

Example: If n=3, status bytes 1 and 2 are masked.

8	7	6	5	4	3	2	1
□	□	□	□	□	□	□	□
0	0	0	0	0	0	1	1

⑤ CS

Function:  
Clears the status byte.

Parameter:  
None

Explanation:

The CS command clears a bit if its status has been set to "1".

Q8460A  
OPTICAL FIBER REFLECTOMETER  
INSTRUCTION MANUAL

⑥ DLn

Function:

    Selects the delimiter mode.

Parameter:

n = 0	CR/LF + EOI
n = 1	LF only
n = 2	EOI only

Explanation:

    This command indicates the end of data.

Header	Data	SD	Data	SD	Data	BD
--------	------	----	------	----	------	----

Header	Data	BD
--------	------	----

The specified block delimiter or delimiters are added regardless of a single or multiple data sets or the binary or ASCII output format.

DL0: CR/LF + EOI

DL1: LF only

DL2: EOI only

⑦ SLn

Function:

    Selects the string delimiter mode.

Parameter:

n = 0	“, ”
n = 1	␣ (Space)
n = 2	CRLF

Q8460A  
OPTICAL FIBER REFLECTOMETER  
INSTRUCTION MANUAL

5.3 GPIB Talker Format

Explanation:

An output request is issued by the read command. If its output format is ASCII and multiple data sets are used, the delimiters are added to the output data.

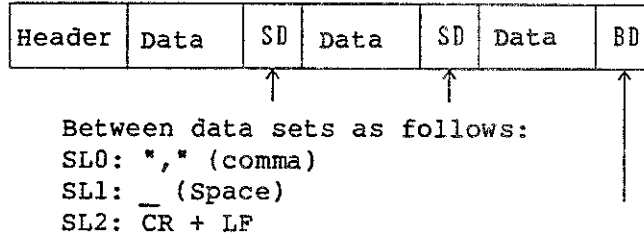

A block delimiter is added as follows:  
 DL0: CR/LF + EOI  
 DL1: LF only  
 DL2: EOI only

⑧ Hn

Function:

Display or no display of header.

Parameter:

n = 0	OFF
n = 1	ON

Explanation:

If an output request is issued by the read command and if the header display mode is selected (ON), this command adds a 6-byte ASCII data to the beginning of the output data as the header. The read command is added as it is.

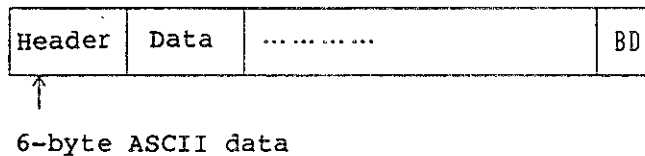

If the header display mode is off, nothing is added to data. It is added if the header display mode is on regardless of the ASCII or binary output format.

Q8460A  
OPTICAL FIBER REFLECTOMETER  
INSTRUCTION MANUAL

⑨ MON

Function:  
Selects the monitor mode.

Parameter:  
None

Explanation:  
Selects the monitor mode in the specified conditions. Some parameters can be changed only in the monitor mode.

⑩ AVG

Function:  
Selects the averaging mode.

Parameter:  
None

Explanation:

- Starts averaging in the setup conditions.
- Averaging continues after pause by Average Pause.
- If you increase the No. of averaging times and issue this command at the end of previous averaging, additional averaging starts.

⑪ PSE

Function:  
Selects the Pause mode.

Parameter:  
None

Explanation:  
This command pauses averaging in the average mode or monitor mode.

⑫ IDXn

Function:  
Sets an index (refractive index) value.

Parameter:  
 $1.4000 \leq n \leq 1.7000$   
0.0001 step

Explanation:  
This command sets the refractive index (see Subsection 3.3.1).

Q8460A  
OPTICAL FIBER REFLECTOMETER  
INSTRUCTION MANUAL

⑬ DRn

Function:  
Sets the distance range.

Parameter:

n = 0	100km
n = 1	50km
n = 2	15km
n = 3	5km
n = 4	2km
n = 5	1km

Explanation:

- The distance range can be set only in the monitor mode.
- Select a distance range longer than the optical fiber length. If not, a multipath reflection may occur and the measurement may fail.
- Some distance ranges cannot be set due to the plug-in unit type.  
Q84605: 100 km  
Q84605P: 50 km or 100 km

⑭ GANn

Function:  
Selects the measuring mode.

Parameter:

n = 0	REFLECTION
n = 1	BACKSCATTER
n = 2	BS ORL1
n = 3	BS ORL2
n = 4	BS ORL3
n = 5	BS ORL4

} Q84621A only

Q8460A  
OPTICAL FIBER REFLECTOMETER  
INSTRUCTION MANUAL

5.3 GPIB Talker Format

Explanation:

- The measuring mode can be selected from the monitor mode only. You cannot select the REFLECTION option in the AUTO (automatic measurement) mode.
- The following shows the setting values of a plug-in unit other than the Q84621A.  
GAN0: REFLECTION  
GAN1: BACKSCATTER
- The following shows the setting values of a plug-in for Q84621A.  
GAN0: REFLECTION  
GAN1: BACKSCATTER  
GAN2: BS ORL1  
GAN3: BS ORL2  
GAN4: BS ORL3  
GAN5: BS ORL4

⑮ XSPn, SSPn

Function:

Sets or changes the horizontal span.

Parameter:

Parameter (n)	0	1	2	3	4	5	6	7	8	9	10	11	12
Span (km)	0.01	0.02	0.05	0.1	0.2	0.5	1	2	5	10	20	50	100

Explanation:

The span enlargement or compression depends on the display status and its distance range. The following summarizes the change of span in the monitor mode. Some parameters may not be set in an XSP command due to the distance range setup.

- o: Can be set
- x: Cannot be set

		Parameter of XSP Command												
		0	1	2	3	4	5	6	7	8	9	10	11	12
DI ST AN CE R AN GE	100km	x	x	o	o	o	o	o	o	o	o	o	o	o
	50km	o	o	o	o	o	o	o	o	o	o	o	o	x
	15km	o	o	o	o	o	o	o	o	o	o	x	x	x
	5km	o	o	o	o	o	o	o	o	o	x	x	x	x
	2km	o	o	o	o	o	o	o	o	x	x	x	x	x
	1km	o	o	o	o	o	o	o	x	x	x	x	x	x

Q8460A  
OPTICAL FIBER REFLECTOMETER  
INSTRUCTION MANUAL

5.3 GPIB Talker Format

The change of span during averaging, after averaging, averaging pause, or monitor pause varies depending on the distance range and specified span.

NOTE

- The span of waveforms recalled from memory is expanded or reduced .
- The span is expanded or compressed around the marker position.

The following lists the range of span that can be changed.

Span Modification Range during Pause (1 of 5)

Explanation:

The span can be compressed to 200 m in the non-monitor mode if DR=1 km and the specified span is 10 m.

When DR is set 1km.

		Adjustable span						
		10m	20m	50m	100m	200m	500m	1km
Setting span	10m	← ○					→ ×	×
	20m	←	○				→ ×	×
	50m	×	×	← ○			→ ×	×
	100m	×	×	×	← ○		→ ×	×
	200m	×	×	×	←	○	→ ×	×
	500m	×	×	×	×	×	← ○	→ ×
	1km	×	×	×	×	×	←	○ →

Q8460A  
OPTICAL FIBER REFLECTOMETER  
INSTRUCTION MANUAL

Span Modification Range during Pause (2 of 5)

When DR is set 2km.

		Adjustable span							
		10m	20m	50m	100m	200m	500m	1km	2km
Setting span	10m	← ○	→	→	→	→	×	×	×
	20m	←	○	→	→	→	×	×	×
	50m	×	×	← ○	→	→	→	×	×
	100m	×	×	×	← ○	→	→	→	×
	200m	×	×	×	←	○	→	→	×
	500m	×	×	×	×	×	← ○	→	→
	1km	×	×	×	×	×	←	○	→
	2km	×	×	×	×	×	←	←	○ →

○ : The span is set under a MONITOR status.

When DR is set 5km.

		Adjustable span								
		10m	20m	50m	100m	200m	500m	1km	2km	5km
Setting span	10m	← ○	→	→	→	→	×	×	×	×
	20m	←	○	→	→	→	×	×	×	×
	50m	×	×	← ○	→	→	→	×	×	×
	100m	×	×	×	← ○	→	→	→	×	×
	200m	×	×	×	←	○	→	→	×	×
	500m	×	×	×	×	×	← ○	→	→	→
	1km	×	×	×	×	×	←	○	→	→
	2km	×	×	×	×	×	←	←	○	→
	5km	×	×	×	×	×	×	←	←	○ →

○ : The span is set under a MONITOR status.



Q8460A  
OPTICAL FIBER REFLECTOMETER  
INSTRUCTION MANUAL

5.3 GPIB Talker Format

Span Modification Range during Pause (3 of 5)

When DR is set 15km.

		Adjustable span									
		10m	20m	50m	100m	200m	500m	1km	2km	5km	10km
Setting span	10m	← ○	→	→	→	→	×	×	×	×	×
	20m	←	← ○	→	→	→	×	×	×	×	×
	50m	×	×	← ○	→	→	→	×	×	×	×
	100m	×	×	×	← ○	→	→	→	×	×	×
	200m	×	×	×	←	← ○	→	→	×	×	×
	500m	×	×	×	×	×	← ○	→	→	→	→
	1km	×	×	×	×	×	←	← ○	→	→	→
	2km	×	×	×	×	×	←	←	← ○	→	→
	5km	×	×	×	×	×	×	←	←	← ○	→
	10km	×	×	×	×	×	×	←	←	←	← ○ →

○ : The span is set under a MONITOR status.

Q8460A  
OPTICAL FIBER REFLECTOMETER  
INSTRUCTION MANUAL

5.3 GPIB Talker Format

Span Modification Range during Pause (4 of 5)

When DR is set 50km.

		Adjustable span												
		10m	20m	50m	100m	200m	500m	1km	2km	5km	10km	20km	50km	
Setting span	10m	← ○	→	→	→	→	×	×	×	×	×	×	×	
	20m	←	○	→	→	→	×	×	×	×	×	×	×	
	50m	×	×	← ○	→	→	→	×	×	×	×	×	×	
	100m	×	×	×	← ○	→	→	→	×	×	×	×	×	
	200m	×	×	×	←	○	→	→	×	×	×	×	×	
	500m	×	×	×	×	×	← ○	→	→	→	→	×	×	
	1km	×	×	×	×	×	←	○	→	→	→	×	×	
	2km	×	×	×	×	×	←	←	○	→	→	×	×	
	5km	×	×	×	×	×	×	←	←	○	→	→	×	
	10km	×	×	×	×	×	×	←	←	←	○	→	×	
	20km	×	×	×	×	×	×	×	←	←	●	→	○	→
	50km	×	×	×	×	×	×	×	×	×	←	←	←	○

- : The span is set under a MONITOR status.
- : The span is not set 5km, but is set 4km.

Q8460A  
OPTICAL FIBER REFLECTOMETER  
INSTRUCTION MANUAL

5.3 GPIB Talker Format

Span Modification Range during Pause (5 of 5)

When DR is set 100km.

		Adjustable span										
		50m	100m	200m	500m	1km	2km	5km	10km	20km	50km	100km
Setting span	50m	← ○			→	×	×	×	×	×	×	×
	100m	×	← ○		→	×	×	×	×	×	×	×
	200m	×	←	○	→	×	×	×	×	×	×	×
	500m	×	×	×	← ○				→	×	×	×
	1km	×	×	×	←	○			→	×	×	×
	2km	×	×	×	←		○		→	×	×	×
	5km	×	×	×	×	←		○	→	×	×	×
	10km	×	×	×	×	←			○	→	×	×
	20km	×	×	×	×	×	←	●		○	→	×
	50km	×	×	×	×	×	×	←			○	→
	100km	×	×	×	×	×	×	←				○ →

- : The span is set under a MONITOR status.
- : The span is not set 5km, but is set 4km.

Q8460A  
OPTICAL FIBER REFLECTOMETER  
INSTRUCTION MANUAL

⑩ SSTn, PSTn

Function:  
Sets the horizontal position.

Parameter:  
0 to approximately 107000

Explanation:  
These commands set the start point on the distance axis (horizontal position) in meters or feet. The horizontal position may not be set by using the distance range, span, or index value. Although a decimal value can be set, the expected result may not be obtained due to the limited resolution of internal data or an error of index.

⑪ VSLn

Function:  
Sets the vertical axis scale.

Parameter:  
Back Scatter mode:

	Vertical Scale
n = 0	4dB/div
n = 1	2
n = 2	1
n = 3	0.5
n = 4	0.2

Reflection mode:

	Vertical Scale
n = 0	× 1
n = 1	× 2
n = 2	× 4
n = 3	× 8

Q8460A  
OPTICAL FIBER REFLECTOMETER  
INSTRUCTION MANUAL

Explanation:

The different scale index may be set between the Back Scatter and Reflection modes.

⑱ VPSn

Function:

Sets the vertical position.

Parameter:

n = -30 to 15

Explanation:

This command sets the vertical axis position in units of dB.

⑲ PWN

Function:

Sets the pulse width.

Parameter:

	Pulse width
n = 0	3ns
n = 1	20ns
n = 2	100ns
n = 3	1 $\mu$ s

Explanation:

The pulse width can be set in the monitor mode only.

⑳ KNBn

Function:

Selects the rapid mode of the data knob.

Parameter:

n = 0	OFF
n = 1	ON

Q8460A  
OPTICAL FIBER REFLECTOMETER  
INSTRUCTION MANUAL

5.3 GPIB Talker Format

---

②① WLn

Function:  
Sets the wavelength.

Parameter:

n = 0	0.85 $\mu$ m
n = 1	1.3 $\mu$ m
n = 2	1.55 $\mu$ m

Explanation:

This command is valid only when issued for the Q84621/Q84621A plug-in unit.

②② TST

Function:  
Saves the waveform data in the dual trace memory.

Parameter:  
None

Explanation:

This command saves only the waveform data in the dual trace memory. If data already exists in this memory, it is overwritten by new waveform data. The previous data is erased. When the system power supply is turned off, all data is erased from memory.

②③ TVWn

Function:  
Displays the dual trace or suppresses to display it.

Parameter:

n = 0	OFF
n = 1	ON

Explanation:

This command specifies the display or no display of save data of the dual trace memory by using the TST command.

Q8460A  
OPTICAL FIBER REFLECTOMETER  
INSTRUCTION MANUAL

②④ LSSn

Function:

Sets the standard marker function.

Parameter:

n = 0	DISTANCE
n = 1	LOSS
n = 2	Splice1
n = 3	Splice2
n = 4	ORL (Q84621A)

Explanation:

This command is valid only when the standard marker function of ADVANCED FUNCTION has been set. The ORL function is valid for the Q84621A only.

②⑤ SPMn

Function:

Selects the ADVANCED FUNCTION marker functions.

Parameter:

n = 0	STANDARD
n = 1	FIX DLT (LSA)
n = 2	FIX DLT (2PA)
n = 3	3 POINTS LOSS
n = 4	5 POINTS LOSS
n = 5	SPLICE, SPLICE
n = 6	LOSS, LOSS (LSA)
n = 7	LOSS, LOSS (2PA)

Q8460A  
OPTICAL FIBER REFLECTOMETER  
INSTRUCTION MANUAL

5.3 GPIB Talker Format

Explanation:

This command selects the ADVANCED FUNCTION marker functions.  
See Section 3.5 for the marker function details.

②⑥ MKAn, MKBn, MKCn, MKDn, MKE n

Function:

MKA moves marker 1.  
MKB moves marker 2.  
MKC moves marker 3.  
MKD moves marker 4.  
MKE moves marker 5.

Parameter:

0 to 500

Explanation:

Set value 0 at the leftmost end of the screen and value 500 at the rightmost end of it. The distance on the horizontal axis is not affected (if the number of points is 500). The number of points varies depending on the specified span. See the table below.

SPAN	The number of points
10m	201
20m	401
the others	501

②⑦ MSTn

Function:

Saves the waveform data and setup conditions in the internal memory.

Parameter:

n = 1 to 32

Explanation:

This command saves both the waveform data and setup conditions in the internal memory. If data already exists in the selected file number, the existing data is overwritten by new data. For memory function details, see paragraph ① "Save mode" of Section 3.6 (2).





Q8460A  
OPTICAL FIBER REFLECTOMETER  
INSTRUCTION MANUAL

5.3 GPIB Talker Format

---

③② PRT

Function:

Prints data on the built-in printer.

Parameter:

None

Explanation:

You must set the I/O of the printer. If the plotter output has been set, no GPIB control is supported.

③③ CLOCKn

Function:

Sets the calendar date and clock time.

Parameter:

Example: To set 20 hours 45 minutes on December 25, 1990, enter:  
n=1990,12,25,20,45

③④ WAVEn

Function:

Sets the waveform display resolution on the CRT screen.

Parameter:

n = 0	dot
n = 1	LINE

③⑤ MILEn

Function:

Selects the unit of waveform display distance.

Parameter:

n = 0	km
n = 1	kft

Q8460A  
OPTICAL FIBER REFLECTOMETER  
INSTRUCTION MANUAL

5.3 GPIB Talker Format

---

③⑥ SAVGn

Function:

Sets the No. of averaging times.

Parameter:

Parameter	0	1	2	3	4	5	6
Count	16	32	64	128	256	512	1024

Parameter	7	8	9	10	11	12
Count	2048	4096	8192	16384	32768	65536

③⑦ MSKSn

Function:

Sets the optical mask.

Parameter:

n = 0 to approximately 100000 (in meters or feet)

Explanation:

The optical mask can be set for the Q84601, Q84621, or Q84621A. Specify the distance (in meters or feet) in the parameter. No unit is required.

③⑧ MSKC

Function:

Clears the optical mask.

Parameter:

None

Explanation:

The MSKC command clears all masks which have been set.

Q8460A  
OPTICAL FIBER REFLECTOMETER  
INSTRUCTION MANUAL

③9 OREFn

Function:

Sets the reference level of the ORL function.

Parameter:

n	Pulse width
-50.0 to -70.0	100ns or less
-40.0 to -60.0	1 $\mu$ s

Explanation:

For the ORL function details, see paragraph (2) of Section 3.5. If the pulse width is 3 ns or 20 ns, the parameter is set based on the 100 ns pulse width.

The following shows the reference level setup according to the wavelength.

Wavelength	Reference level
1.31 $\mu$ m	-49dB
1.55 $\mu$ m	-52dB

Note

If the pulse width is 3 ns or 20 ns, no waveforms can be measured by using the ORL function.

Q8460A  
OPTICAL FIBER REFLECTOMETER  
INSTRUCTION MANUAL

5.3 GPIB Talker Format

---

④① AUTOn

Function:  
Starts automatic measurement.

Parameter:

- n = 0 Exists the automatic measurement mode.
- n = 1 Selects the automatic measurement and starts measurement.

Explanation:

This command executes automatic measurement in the specified conditions. For the automatic measurement details, see paragraph (1) of Section 3.12. When specifying a GPIB command, you cannot select the ALL or STEP option of the MEASURE parameter. You can select them in the ALL mode only. (The ALL mode is selected automatically even when the STEP mode has been selected.)

④② ALVLn

Function:  
Sets the automatic measurement level.

Parameter:  
n = 0.05 to 9.99

Explanation:

This command sets the automatic measurement level. You must enter the splice loss value for the detection level.

④③ BZn

Function:  
Turns the buzzer on or off.

Parameter:

n = 0	OFF
n = 1	ON

Explanation:

This command turns the buzzer sound mode on or off. The valid and invalid GPIB command input can be identified by the buzzer.

Q8460A  
OPTICAL FIBER REFLECTOMETER  
INSTRUCTION MANUAL

5.3 GPIB Talker Format

5.3.2 GPIB Read Commands

The following lists the GPIB read commands and provides their detailed explanation.

Table 5-4 GPIB Read Command List (1 of 2)

Command	Function	Page
① RDTB	Output the on-screen data (binary 1 byte per data)	5 - 36
② RDTW	Output the on-screen data (binary 2 byte per data)	5 - 36
③ RDTL	Output the on-screen data (binary 4 byte per data)	5 - 37
④ RDTS	Output the on-screen data (ASCII 7 bytes per data)	5 - 37
⑤ RMDB	Output the dual trace memory data (binary 1 byte per data)	5 - 38
⑥ RMDW	Output the dual trace memory data (binary 2 bytes per data)	5 - 38
⑦ RMDL	Output the dual trace memory data (binary 4 bytes per data)	5 - 39
⑧ RMDS	Output the dual trace memory data (ASCII 7 bytes per data)	5 - 39
⑨ RADB	Output all internal data (binary 1 byte per data)	5 - 40
⑩ RADW	Output all internal data (binary 2 bytes per data)	5 - 40
⑪ RADL	Output all internal data (binary 4 bytes per data)	5 - 41
⑫ RADS	Output all internal data (ASCII 7 bytes per data)	5 - 41
⑬ RDTC	Read the No. of on-screen data sets	5 - 42
⑭ RMDC	Read the No. of data sets of dual trace memory	5 - 42
⑮ RADC	Read the total No. of internal data sets and the distance between the start and end points	5 - 42
⑯ RPI	Read the plug-in unit	5 - 43
⑰ RGAN	Read the measuring mode	5 - 43
⑱ RVSL	Read the vertical scale	5 - 43
⑲ RVPS	Read the vertical position	5 - 44
⑳ RHPS	Read the horizontal position	5 - 44

Q8460A  
OPTICAL FIBER REFLECTOMETER  
INSTRUCTION MANUAL

5.3 GPIB Talker Format

Table 5-4 GPIB Read Command List (2 of 2)

	Command	Function	Page
②1	RSP	Read the horizontal span	5 - 44
②2	RDR	Read the distance range	5 - 45
②3	RSPM	Read the marker type (Advanced function)	5 - 45
②4	RLSS	Read the marker type (Standard)	5 - 45
②5	RRDO	Read data from window (except automatic measurement)	5 - 46
②6	RATC	Read the No. of connection points during automatic measurement	5 - 48
②7	RAUT	Read the automatic measurement result	5 - 48
②8	RPW	Read the pulse width	5 - 48
②9	RLBL	Read the label	5 - 49
③0	RIDX	Read the index	5 - 49
③1	RCLOCK	Read the date and time	5 - 49
③2	RWAVE	Read the display resolution (No. of dots per line)	5 - 50
③3	RMLE	Read the display distance (in km or kft)	5 - 50
③4	RS AVG	Read the No. of averaging times	5 - 50
③5	RALVL	Read the setup of splice detect level during automatic measurement	5 - 51
③6	ROREF	Read the reference level	5 - 51

Q8460A  
OPTICAL FIBER REFLECTOMETER  
INSTRUCTION MANUAL

5.3 GPIB Talker Format

---

① RDTB

Function:

Reads the on-screen data.

Explanation:

Binary format output: 1 byte per data

Header	Data 1	Data 2	Data 3	· ·	Data n	BD
--------	--------	--------	--------	-----	--------	----

Header: 6-byte ASCII data. It is output only when the header display mode has been turned on by the "Hn" command.

Data: 1-byte (0 to 255) binary data. The bottom of the screen is 0, and the top of the screen is 255. The specified number of data sets is read by the RDTB command.

BD: Block delimiter that can be selected by the "DLn" command

② RDTW

Function:

Reads the on-screen data.

Explanation:

Binary format output: 2 bytes per data

Header	Data 1	Data 2	Data 3	· ·	Data n	BD
--------	--------	--------	--------	-----	--------	----

Header: 6-byte ASCII data. It is output only when the header display mode has been turned on by the "Hn" command.

Data: 2-byte binary data. The high-order 1 byte represents the integer part of data, and the low-order 1 byte is the decimal part. The specified number of data sets is read by the RDTB command.

BD: Block delimiter that can be selected by the "DLn" command



Q8460A  
OPTICAL FIBER REFLECTOMETER  
INSTRUCTION MANUAL

③ RDTL

Function:

Reads the on-screen data.

Explanation:

Binary format output: 4 bytes per data

Header	Data 1	Data 2	Data 3	· ·	Data n	BD
--------	--------	--------	--------	-----	--------	----

Header: 6-byte ASCII data. It is output only when the header display mode has been turned on by the "Hn" command.

Data: 4-byte binary data. The high-order 2 bytes represent the integer part of data, and the low-order 2 bytes are the decimal part. The specified number of data sets is read by the RDTC command.

BD: Block delimiter that can be selected by the "DLn" command

④ RDTS

Function:

Reads the on-screen data.

Explanation:

ASCII format output: 7 bytes per data

Header	Data 1	SD	Data 2	SD	Data 3	SD	· · ·
--------	--------	----	--------	----	--------	----	-------

Data n	BD
--------	----

Header: 6-byte ASCII data. It is output only when the header display mode has been turned on by the "Hn" command.

Data: 7-byte ASCII data. The number of data sets is read by the RDTC command.

SD: String delimiter which can be selected by the "SLn" command

BD: Block delimiter that can be selected by the "DLn" command

Q8460A  
OPTICAL FIBER REFLECTOMETER  
INSTRUCTION MANUAL

5.3 GPIB Talker Format

---

⑤ RMDB

Function:

Reads data from the dual trace memory.

Explanation:

Binary format output: 1 byte per data

Header	Data 1	Data 2	Data 3	· ·	Data n	BD
--------	--------	--------	--------	-----	--------	----

Header: 6-byte ASCII data. It is output only when the header display mode has been turned on by the "Hn" command.

Data: 1-byte (0 to 255) binary data. The bottom of the screen is 0, and the top of the screen is 255. The number of data sets can be read by the RMDC command.

BD: Block delimiter that can be selected by the "DLn" command

⑥ RMDW

Function:

Reads data from the dual trace memory.

Explanation:

Binary format output: 2 bytes per data

Header	Data 1	Data 2	Data 3	· ·	Data n	BD
--------	--------	--------	--------	-----	--------	----

Header: 6-byte ASCII data. It is output only when the header display mode has been turned on by the "Hn" command.

Data: 2-byte binary data. The high-order 1 byte represents the integer part of data, and the low-order 1 byte is the decimal part. The specified number of data sets is read by the RMDC command.

BD: Block delimiter that can be selected by the "DLn" command

Q8460A  
OPTICAL FIBER REFLECTOMETER  
INSTRUCTION MANUAL

⑦ RMDL

Function:

Reads data from the dual trace memory.

Explanation:

Binary format output: 4 bytes per data

Header	Data 1	Data 2	Data 3	. .	Data n	BD
--------	--------	--------	--------	-----	--------	----

Header: 6-byte ASCII data. It is output only when the header display mode has been turned on by the "Hn" command.

Data: 4-byte binary data. The high-order 2 bytes represent the integer part of data, and the low-order 2 bytes are the decimal part. The specified number of data sets is read by the RMDC command.

BD: Block delimiter that can be selected by the "DLn" command

⑧ RMDS

Function:

Reads data from the dual trace memory.

Explanation:

ASCII format output: 7 bytes per data

Header	Data 1	SD	Data 2	SD	Data 3	SD	. . .
--------	--------	----	--------	----	--------	----	-------

Data n	BD
--------	----

Header: 6-byte ASCII data. It is output only when the header display mode has been turned on by the "Hn" command.

Data: 7-byte ASCII data. The number of data sets is read by the RMDC command.

SD: String delimiter which can be selected by the "SLn" command

BD: Block delimiter that can be selected by the "DLn" command

Q8460A  
OPTICAL FIBER REFLECTOMETER  
INSTRUCTION MANUAL

5.3 GPIB Talker Format

---

⑨ RADB

Function:

Reads all internal data.

Explanation:

Binary format output: 1 byte per data

Header	Data 1	Data 2	Data 3	· ·	Data n	BD
--------	--------	--------	--------	-----	--------	----

Header: 6-byte ASCII data. It is output only when the header display mode has been turned on by the "Hn" command.

Data: 1-byte (0 to 255) binary data. The bottom of the screen is 0, and the top of the screen is 255. The specified number of data sets is read by the RADC command.

BD: Block delimiter that can be selected by the "DLn" command

⑩ RADW

Function:

Reads all internal data.

Explanation:

Binary format output: 2 bytes per data

Header	Data 1	Data 2	Data 3	· ·	Data n	BD
--------	--------	--------	--------	-----	--------	----

Header: 6-byte ASCII data. It is output only when the header display mode has been turned on by the "Hn" command.

Data: 2-byte binary data. The high-order 1 byte represents the integer part of data, and the low-order 1 byte is the decimal part. The specified number of data sets is read by the RADC command.

BD: Block delimiter that can be selected by the "DLn" command

Q8460A  
OPTICAL FIBER REFLECTOMETER  
INSTRUCTION MANUAL

⑪ RADL

Function:  
Reads all internal data.

Explanation:  
Binary format output: 4 bytes per data

Header	Data 1	Data 2	Data 3	· ·	Data n	BD
--------	--------	--------	--------	-----	--------	----

Header: 6-byte ASCII data. It is output only when the header display mode has been turned on by the "Hn" command.  
Data: 4-byte binary data. The high-order 2 bytes represent the integer part of data, and the low-order 2 bytes are the decimal part. The specified number of data sets is read by the RADC command.  
BD: Block delimiter that can be selected by the "DLn" command

⑫ RADS

Function:  
Reads all internal data.

Explanation:  
ASCII format output: 7 bytes per data

Header	Data 1	SD	Data 2	SD	Data 3	SD	· · ·
--------	--------	----	--------	----	--------	----	-------

Data n	BD
--------	----

Header: 6-byte ASCII data. It is output only when the header display mode has been turned on by the "Hn" command.  
Data: 7-byte ASCII data. The number of data sets is read by the RADC command.  
SD: String delimiter which can be selected by the "SLn" command  
BD: Block delimiter that can be selected by the "DLn" command

Q8460A  
OPTICAL FIBER REFLECTOMETER  
INSTRUCTION MANUAL

⑬ RDTC

Function:

Reads the number of on-screen data sets

Explanation:

This command reads the number of on-screen data sets.  
Talker format

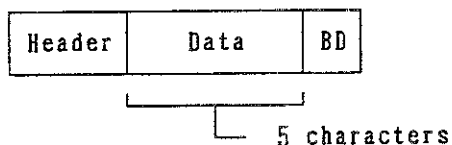

⑭ RMDC

Function:

Reads the number of data sets of the dual trace memory.

Explanation:

This command reads the number of data sets of the dual trace memory.  
Talker format

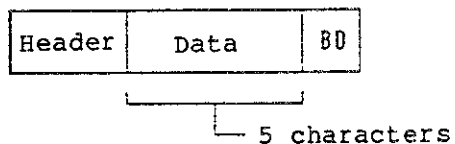

⑮ RADC

Function:

Reads the total number of internal data sets.

Explanation:

This command reads the total number of internal data sets and the distance between the start and end points of data.

Command: RADC

Talker format

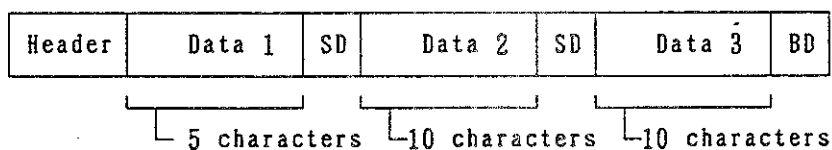

Q8460A  
OPTICAL FIBER REFLECTOMETER  
INSTRUCTION MANUAL

5.3 GPIB Talker Format

---

⑩ RPI

Function:

Reads the attached plug-in unit.

Explanation:

This command reads both the length of waveforms shown at the left lower end of the screen and the optical fiber type.

Talker format

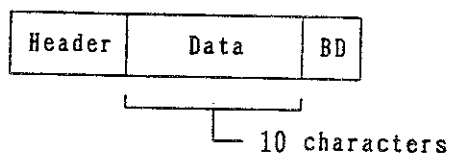

⑪ RGN

Function:

Reads the measuring mode.

Explanation:

This command reads the current measuring mode.

One of the following is read on a plug-in unit other than the Q84621A:

- REFLECTION
- BACKSCATTER

One of the following is read on the Q84621A:

- REFLECTION
- BACKSCATTER, BS ORL1 to 4

Talker format

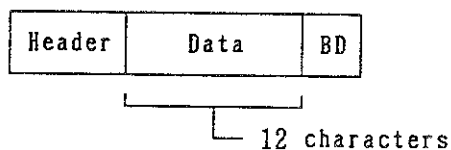

⑫ RVSL

Function:

Reads the vertical scale.

Explanation:

This command reads the on-screen vertical axis scale in units of dB/D.

Talker format

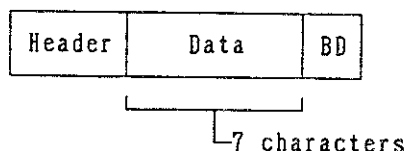

Q8460A  
OPTICAL FIBER REFLECTOMETER  
INSTRUCTION MANUAL

①⑨ RVPS

Function:

Reads the vertical position.

Explanation:

This command reads the vertical axis position. The upper limit value is read.

Talker format

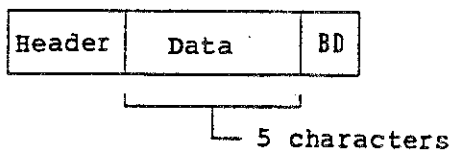

②⑩ RHPS

Function:

Reads the horizontal position.

Explanation:

This command reads the specified distance position. The leftmost end value on the screen is read (in units of km or kft).

Talker format

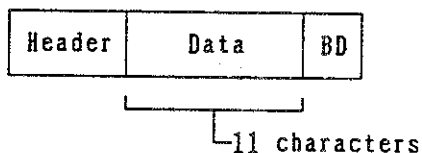

②⑪ RSP

Function:

Reads the horizontal span.

Explanation:

This command reads the specified horizontal span (in units of meters or feet).

Talker format

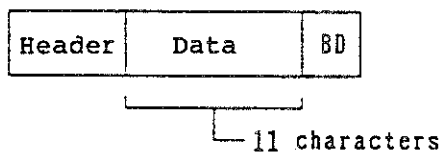



Q8460A  
OPTICAL FIBER REFLECTOMETER  
INSTRUCTION MANUAL

5.3 GPIB Talker Format

---

② RDR

Function:  
Reads the distance range.

Explanation:  
This command reads the distance range shown on the right upper end of the screen.  
Talker format

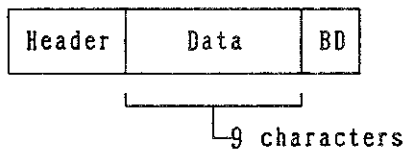

③ RSPM

Function:  
Reads the marker type.

Explanation:  
This command reads the specified marker function (ADVANCED FUNCTION).  
Talker format

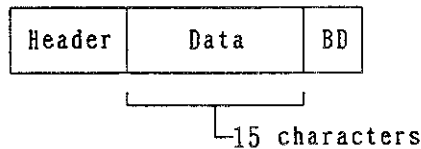

④ RLSS

Function:  
Reads the marker type.

Explanation:  
This command reads the specified marker function (Standard).  
Talker format

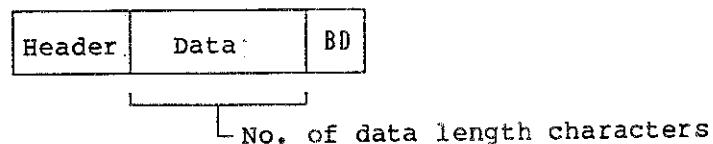

Q8460A  
OPTICAL FIBER REFLECTOMETER  
INSTRUCTION MANUAL

5.3 GPIB Talker Format

② RRDO

Function:

Reads data from window.

Explanation:

This command reads data identified by the on-screen marker.  
Talker format

Header	Data 1	SD	Data 2	SD	.	SD	Data N	BD
--------	--------	----	--------	----	---	----	--------	----

The following shows the number of characters of data 1 to data N.

STANDARD	Data NO.	No. of characters	Contents
(DISTANCE)	1	15	Title
	2	13	Distance
	3	9	Loss
(LOSS)	1	15	Title
	2	13	Distance
	3	9	Loss
	4	14	Loss/distance
(ORL)	1	15	Title
	2	9	ORL
	3	9	Level difference
	4	9	BS level
(SPLICE 1)	1	15	Title
	2	9	Loss
	3	13	Distance
(SPLICE 2)	1	15	Title
	2	9	Loss
	3	13	Distance
FIX DLT (LSA)	1	15	Title
	2	13	Distance
	3	9	Loss
	4	15	Title
	5	13	Distance
	6	15	Title

Q8460A  
OPTICAL FIBER REFLECTOMETER  
INSTRUCTION MANUAL

5.3 GPIB Talker Format

STANDARD	Data No.	No. of characters	Contents
FIX DLT (2PA)	1	14	Loss/distance
	2	15	Title
	3	13	Distance
	4	9	Loss
	5	15	Title
3 Point Loss	1	9	Loss
	2	13	Distance
	3	15	Title
	4	9	Loss
	5	13	Distance
5 Points Splice	1	15	Title
	2	9	Loss
	3	13	Distance
SPLICE SPLICE	1	15	Title
	2	9	Loss
	3	13	Distance
	4	15	Title
	5	9	Loss
	6	13	Distance
LOSS LOSS (LSA)	1	15	Title
	2	13	Distance
	3	9	Loss
	4	15	Title
	5	13	Distance
	6	9	Loss
	7	15	Title
	8	14	Loss/distance
	9	15	Title
	10	14	Loss/distance
LOSS LOSS (2PA)	1	15	Title
	2	13	Distance
	3	15	Title
	4	13	Distance
	5	15	Title
	6	9	Loss
	7	14	Loss/distance
	8	15	Title
	9	9	Loss
	10	14	Loss/distance

Q8460A  
OPTICAL FIBER REFLECTOMETER  
INSTRUCTION MANUAL

②⑥ RATC

Function:

Reads the number of connection points as the result of automatic measurement.

Explanation:

Talker format

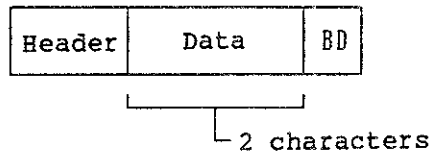

②⑦ RAUT

Function:

Reads the automatic measurement results.

Explanation:

Talker format

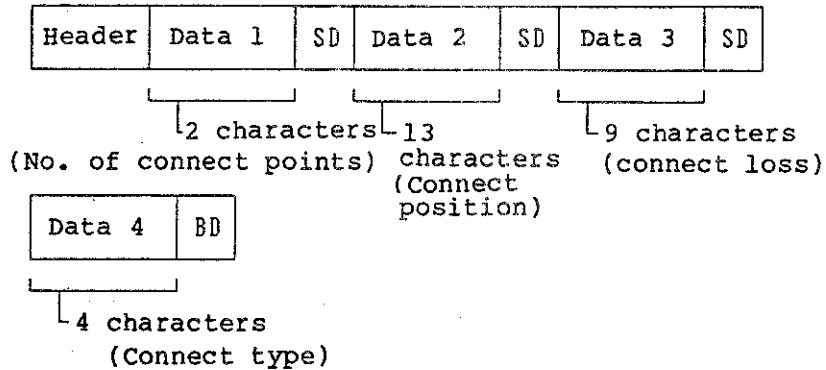

②⑧ RPW

Function:

Reads the specified pulse width.

Explanation:

Talker format

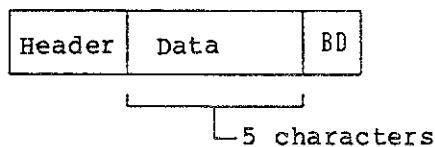

Q8460A  
OPTICAL FIBER REFLECTOMETER  
INSTRUCTION MANUAL

5.3 GPIB Talker Format

---

②⑨ RLBL

Function:  
Reads the specified label.

Explanation:  
Talker format

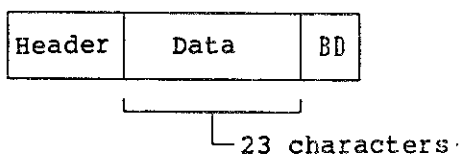

③⑩ RIDX

Function:  
Reads the specified index.

Explanation:  
Talker format

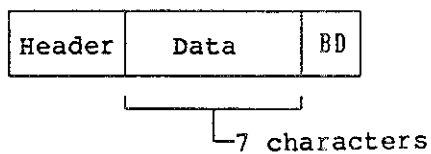

③① RCLOCK

Function:  
Reads the calendar date and clock time.

Explanation:  
Talker format

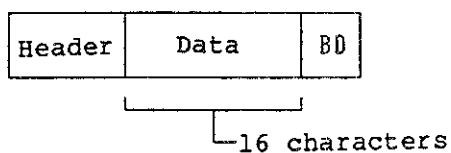

Q8460A  
OPTICAL FIBER REFLECTOMETER  
INSTRUCTION MANUAL

5.3 GPIB Talker Format

---

③② RWAVE

Function:

Reads the display resolution (No. of dots per line).

Explanation:

Talker format

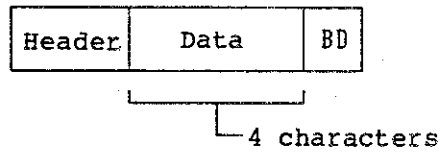

③③ RMILE

Function:

Reads the display distance (in km or kft).

Explanation:

Talker format

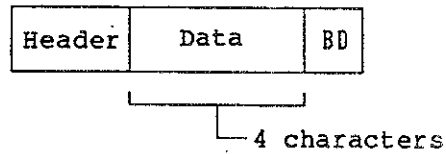

③④ RSAVG

Function:

Reads the number of the specified averaging times.

Explanation:

Talker format

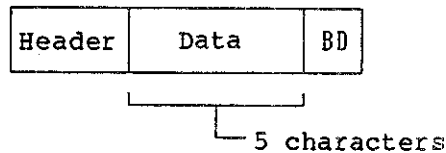

Q8460A  
OPTICAL FIBER REFLECTOMETER  
INSTRUCTION MANUAL

5.3 GPIB Talker Format

---

③⑤ RALVL

Function:

Reads the setup value of splice detect level during automatic measurement.

Explanation:

This command reads the splice detect level which has been set for automatic measurement.

Talker format

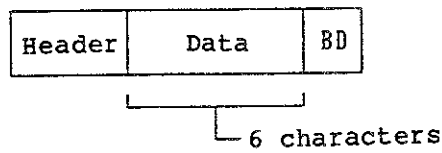

③⑥ ROREF

Function:

Reads the reference level of the ORL function.

Explanation:

This command reads the specified reference level of the ORL function. If the pulse width is 1 microsecond, value -50.0 to -70.0 dB is read.

Talker format

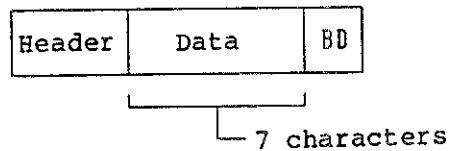

Q8460A  
OPTICAL FIBER REFLECTOMETER  
INSTRUCTION MANUAL

5.4 Programming Examples

5.4 Programming Examples

The following gives programming examples when the PC9801 series controller is used.

(1) Setting the measuring pattern

10	.		
20	.		
30	.	EXAMPLE PROGRAM	
40	.		
50	.	SET DATA	
60	.		
70	.		
80	.		
90		OTDR=11	Defines the unit address of 11.
100	.		
110		ISET IFC	Clears the interface.
120		ISET REN	Enables remote control.
130	.		
140	.		
150		PRINT @OTDR;"MON"	Sets the Monitor function.
160		PRINT @OTDR;"IDX1.4657"	Sets the index to 1.4657.
170		PRINT @OTDR;"DR2,PW1"	Sets the 15 km distance range (pulse width).

(2) Reading the specified data

10	.		
20	.		
30	.	EXAMPLE PROGRAM	
40	.		
50	.	READ SETUP OF OTDR	
60	.		
70	.		
80		DIM A\$(100), B\$(100), C\$(100)	Defines the buffer.
90	.		
100		OTDR=11	Device the unit address of 11.
110	.		
120		ISET IFC	Clears the interface.
130		ISET REN	Enables remote control.
140	.		
150	.		
160		PRINT @OTDR;"RPW"	Selects the pulse width read mode.
170		INPUT @OTDR;A\$	Reads the pulse width in "A\$".
180		PRINT @OTDR;"RLBL"	Selects the label read mode.
190		INPUT @OTDR;B\$	Reads the label in "B\$".
200		PRINT @OTDR;"RIDX"	Selects the index read mode.
210		INPUT @OTDR;C\$	Reads the index in "C\$".
220		PRINT A\$, B\$, C\$	Prints the pulse width, label, and index which have been read.



Q8460A  
OPTICAL FIBER REFLECTOMETER  
INSTRUCTION MANUAL

5.4 Programming Examples

(3) Reading the on-screen waveform data in 4-byte binary format

```
10      '
20      '
30      '
40      '      EXAMPLE PROGRAM
50      '
60      '      READ DATA BLOCK BY 4 BYTE FORMAT
70      '
80      DIM DBUF(501)
90      UNL=&H3F : UNT=&H5F : MTA=&H40 : MLA=&H20
100     '
110     OTDR=11
120     PC98=IEEE(1) AND &H1F
130     '
140     ISET IFC
150     ISET REN
160     '
170     N.BYTE=501
180     PRINT @OTDR;"DL2"
190     PRINT @OTDR;"RDTL"
200     '
210     TALK=MTA+OTDR : LISTEN=MLA+PC98
220     WBYTE UNL, TALK, LISTEN;
230     FOR N=1 TO N.BYTE
240         RBYTE;RDT
250         ANS=RDT
260         RBYTE;RDT
270         ANS=RDT
280         RBYTE;RDT
290         ANS=ANS+RDT/256
300         RBYTE;RDT
310         ANS=ANS+RDT/65536!
320         IF ANS>=128 THEN ANS=256-ANS:ANS=-ANS
330         DBUF(N-1) = ANS
340     NEXT N
350     J = 0
360     FOR I = 0 TO 500
370         IF J < 5 THEN PRINT DBUF(I);:J=J+1 ELSE PRINT DBUF(I):J=0
380     NEXT I
```

The following explains this example program.

Q8460A  
OPTICAL FIBER REFLECTOMETER  
INSTRUCTION MANUAL

5.4 Programming Examples

No.	Explanation
.	
.	
.	
.	
.	
.	
80	Defines the buffer.
90	Assigns the interface message code to the variable.
.	
110	Defines the unit address of 11.
120	Reads the controller address and assigns it to the variable.
.	
140	Clears the interface.
150	Enables remote control.
.	
170	Assigns the number of data sets to the variable.
180	Sets the block delimiter for the EOI only.
190	Selects the waveform data read mode.
.	
210	Assigns the talker and listener addresses to the respective variables.
220	Defines the unit as talker and the controller as listener.
230	Specifies a loop for the number of data sets (501 levels).
240	Reads 1 byte of data.
250	Reads the high-order byte of integer part.
260	Reads 1 byte of data.
270	Reads the low-order byte of integer part.
280	Reads 1 byte of data.
290	Reads the high-order byte of decimal part.
300	Reads 1 byte of data.
310	Reads the low-order byte of decimal part.
320	Generates a negative value.
330	Assigns the read data to the buffer.
340	Loop
350	Initializes the variables.
360	Specifies a loop for the number of data sets (501 levels).
370	Prints 5 data sets on a line.
380	Loop

Q8460A  
OPTICAL FIBER REFLECTOMETER  
INSTRUCTION MANUAL

5.4 Programming Examples

(4) Reading the on-screen waveform data in ASCII format

```
10      :      EXAMPLE PROGRAM
20      :
30      :
40      :      READ DATA BLOCK BY 8 BYTE FORMAT
50      :
60      :
70      DIM A$(4008)
80      UNL=&H3F : UNT=&H5F : MTA=&H40 : MLA=&H20
90      :
100     OTDR=11
110     :
120     ISET IFC
130     ISET REN
140     :
150     DATANO=501
160     CMD DELIM=0
170     PRINT @OTDR;"DLO"
180     PRINT @OTDR;"SL2"
190     PRINT @OTDR;"RDTS"
200     FOR DT=1 TO DATANO
210         INPUT @OTDR;A$(DT-1)
220     NEXT DT
230     :
240     J=0
250     FOR I=0 TO 500
260         IF J<5 THEN PRINT A$(I);:PRINT "    ";:J=J+1 ELSE PRINT A$(I):J=0
270     NEXT I
```

The following explains this example program.

QB460A  
OPTICAL FIBER REFLECTOMETER  
INSTRUCTION MANUAL

5.4 Programming Examples

No.	Explanation
.	
.	
.	
.	
.	
.	
70	Defines the buffer.
80	Assigns the interface message code to the variable.
.	
100	Defines the unit address of 11.
.	
120	Clears the interface.
130	Enables remote control.
.	
150	Assigns the number of data sets to the variable.
160	Sets the block delimiter of the controller as CR+LF.
170	Sets the block delimiter of the unit as CR+LF+EOI.
180	Sets the string delimiter of the unit as CR+LF.
190	Selects the waveform data read mode.
200	Specifies a loop for the number of data sets (501 levels).
210	Reads 1 byte of data.
220	Loop
.	
240	Initializes the variables.
250	Specifies a loop for the number of data sets (501 levels).
260	Prints 5 data sets on a line.
270	Loop

Q8460A  
OPTICAL FIBER REFLECTOMETER  
INSTRUCTION MANUAL

5.4 Programming Examples

---

(5) Reading the on-screen waveform data in 1-byte binary format

```
10      '      EXAMPLE PROGRAM
20      '
30      '
40      '      READ DATA BLOCK BY 1 BYTE FORMAT
50      '
60      '
70      DIM RDT(501)
80      UNL=&H3F : UNT=&H5F : MTA=&H40 : MLA=&H20
90      '
100     OTDR=11
110     PC98=IEEE(1) AND &H1F
120     '
130     ISET IFC
140     ISET REN
150     '
160     N. BYTE=501
170     PRINT @OTDR;"DL2"
180     PRINT @OTDR;"RDTB"
190     '
200     TALK=MTA+OTDR : LISTEN=MLA+PC98
210     WBYTE UNL, TALK, LISTEN;
220     FOR N=1 TO N. BYTE
230         RBYTE;RDT(N-1)
250     NEXT N
300     J = 0
310     FOR I = 0 TO 500
320         IF J <15 THEN PRINT RDT(I);:J=J+1 ELSE PRINT RDT(I): J = 0
330     NEXT I
```

Q8460A  
OPTICAL FIBER REFLECTOMETER  
INSTRUCTION MANUAL

5.4 Programming Examples

No.	Explanation
.	
.	
.	
.	
.	
.	
70	Defines the buffer.
80	Assigns the interface message code to the variable.
.	
100	Defines the unit address of 11.
110	Reads the controller address and assigns it to the variable.
.	
130	Clears the interface.
140	Enables remote control.
.	
160	Assigns the number of data sets to the variable.
170	Sets the block delimiter as EOI only.
180	Selects the waveform data read mode.
.	
200	Assigns the talker and listener addresses to the respective variables.
210	Defines the unit as talker and the controller as listener.
220	Specifies a loop for the number of data sets (501 levels).
230	Reads 1 byte of data and assigns it to the buffer.
250	Loop
300	Initializes the variables.
310	Specifies a loop for the number of data sets (501 levels).
320	Prints 5 data sets on a line.
330	Loop

Q8460A  
OPTICAL FIBER REFLECTOMETER  
INSTRUCTION MANUAL

5.4 Programming Examples

(6) Reading the on-screen waveform data in 2-byte binary format

```
10      '
20      '
30      '
40      '      EXAMPLE PROGRAM
50      '
60      '      READ DATA BLOCK BY 2 BYTE FORMAT
70      '
80      DIM DBUF(501)
90      UNL=&H3F : UNT=&H5F : MTA=&H40 : MLA=&H20
110     OTDR=11
120     PC98=IEEE(1) AND &H1F
130     '
140     ISET IFC
150     ISET REN
160     '
170     DATANO=501
180     PRINT @OTDR;"DL2"
190     PRINT @OTDR;"RDTW"
200     '
210     TALK=MTA+OTDR : LISTEN=MLA+PC98
220     WBYTE UNL,TALK,LISTEN;
230     FOR N=1 TO DATANO
240         RBYTE;RDT
250         ANS=RDT
260         RBYTE;RDT
270         ANS=ANS+RDT/256
280         IF ANS>=128 THEN ANS=256-ANS:ANS=-ANS
290         DBUF(N-1) = ANS
300     NEXT N
310     J = 0
320     FOR I = 0 TO 500
330         IF J <5 THEN PRINT DBUF(I);:J=J+1 ELSE PRINT DBUF(I):J = 0
340     NEXT I
```

Q8460A  
OPTICAL FIBER REFLECTOMETER  
INSTRUCTION MANUAL

5.4 Programming Examples

No.	Explanation
.	
.	
.	
.	
.	
.	
.	
80	Defines the buffer.
90	Assigns the interface message code to the variable.
.	
110	Defines the unit address of 11.
120	Reads the controller address and assigns it to the variable.
.	
140	Clears the interface.
150	Enables remote control.
.	
170	Assigns the number of data sets to the variable.
180	Sets the block delimiter as EOI only.
190	Selects the waveform data read mode.
.	
210	Assigns the talker and listener addresses to the respective variables.
220	Defines the unit as talker and the controller as listener.
230	Specifies a loop for the number of data sets (501 levels).
240	Reads 1 byte of data.
250	Reads the integer data.
260	Reads 1 byte of data.
270	Reads the decimal data.
280	Generates a negative value.
290	Assigns the read data to the buffer.
300	Loop
310	Initializes the variables.
320	Specifies a loop for the number of data sets (501 levels).
330	Prints 5 data sets on a line.
340	Loop



Q8460A  
OPTICAL FIBER REFLECTOMETER  
INSTRUCTION MANUAL

5.4 Programming Examples

---

(7) Service request

```
10      '
20      '
30      '
40      '      EXAMPLE PROGRAM
50      '
60      '      SERVICE REQUEST
70      '
80      '
90      OTDR=11
100     '
110     ISET IFC
120     ISET REN
130     '
141     ON SRQ GOSUB *SRQFUN
150     SRQ ON
160     '
170     PRINT @OTDR;"SO"
180     PRINT @OTDR;"SMK31"
190     PRINT @OTDR;"AVG"
200     *LOOP1
210     GOTO *LOOP1
220     '
230     '
240     '
250     *SRQFUN
260     POLL 11,STS
270     PRINT "AVERAGE COMPLETED"
280     SRQ ON
290     STOP
```

Q8460A  
OPTICAL FIBER REFLECTOMETER  
INSTRUCTION MANUAL

5.4 Programming Examples

No.	Explanation
.	
.	
.	
.	
.	
.	
.	
.	
.	
90	Defines the unit address of 11.
.	
110	Clears the interface.
120	Enables remote control.
.	
140	Specifies the SRQ subroutine.
150	Enables an SRQ reception.
.	
170	Selects the SRQ send mode.
180	Masks a cause except the end of averaging.
190	Sets the function to the average level.
200	*LOOP
210	Permanent loop
.	
.	
.	
250	*SRQFUN
260	Performs serial polling and assigns the status to the variable.
270	Print characters.
280	Stops the program.

Q8460A  
OPTICAL FIBER REFLECTOMETER  
INSTRUCTION MANUAL

6. Specifications

6. SPECIFICATIONS

(1) Q8640A specifications

Parameter	Performance
Distance range	1, 2, 5, 15, 50 and 100km (No 100km for the Q84605 and neither 50km nor 100km for the Q84605P.)
Reading resolution	Min. 5cm
Horizontal axis	
Span	10, 20, 50, 100, 200, 500m, 1km / 1km range 10, 20, 50, 100, 200, 500m, 1, 2km / 2km range 10, 20, 50, 100, 200, 500m, 1, 2, 5km / 5km range 10, 20, 50, 100, 200, 500m, 1, 2, 5, 10km /15km range 10, 20, 50, 100, 200, 500m, 1, 2, 5, 10, 20, 50km /50km range 50, 100, 200, 500m, 1, 2, 5, 10, 20, 50, 100km/100km range
Accuracy	$\pm 0.5m \pm 5 \times 10^{-5} \times$ (measurement value)m Exclusive of any error in setting the group refractive index.
Vertical axis	
Back scatter mode	Back-scattered light measurement mode
Reflection mode	Fault localization (Fresnel reflection) mode
Scale	0.2dB/div, 0.5dB/div, 1dB/div, 2dB/div, 4dB/div
Resolution	0.01dB
Linearity	Less than 0 to 5dB/ $\pm 0.3$ dB, less than 0 to 10dB/ $\pm 0.5$ dB less than 0 to 15dB/ $\pm 0.7$ dB
Averaging	
Monitor mode	$2^8$ times (measurement time: approx. 0.4 sec. for a distance range of 15km and a span of 10km)
Average mode	$2^n$ times ( $12 \leq n \leq 24$ ), may be set at any number (measurement time: approx. 6 sec. for a distance range of 1km, a span of 1km and an averaging frequency of $2^{16}$ )
Refractive index setup	Can be set with an interval of 0.0001 between 1.4000 and 1.7000.

Q8460A  
OPTICAL FIBER REFLECTOMETER  
INSTRUCTION MANUAL

6. Specifications

Parameter	Performance
Waveform manipulation after averaging	Span expansion and relocation of the horizontal axis are possible for post-averaged waveforms.
Memory function	Stores waveforms displayed over the tube surface and settings for as many as 32 screens (provided with back-up functions) and measurement conditions immediately before power is turned off.
Loss-measurement function by markers	Eleven types of marker functions are available including measurement of loss between two points and loss per 1km by two-point markers, measurement of splicing distance and loss by three-point markers and measurement of splicing distance between two points and loss by five-point markers.
Mask function	Up to 30 points can be set by optical procedures (with a setting resolution of 2m). (Q84601, Q84621 and Q84621A only)
Dual tracing function	Function to compare waveforms by simultaneous display of the SAVE waveform and the measured waveform.
Label function	Up to 23 characters can be set.
Timer function	Displays year, month, day and minute (provided with back-up function)
Displaying	Capable of switching between waveform dots and lines
Function to set the unit of distance	Capable of switching between km and kft
Help function	Displays operational procedures on the CRT.
Automatic measurement function	Capable of detecting connections and disconnections for a maximum of 16 points. Capable of setting detect level (0.05dB to 9.99dB, 0.01dB STEP)
ORL (optical return loss) measurement function	Yes (Q84621A only)
Buzzer function	Can be set to ON/OFF.
CRT	5.5 inches
GPIB	Remote control and data output can be achieved by a standard GPIB (in compliance with IEEE488-1978).
Printer	Copying of CRT screens by a built-in thermal printer (printing time of less than 8 seconds) (Operating temperature range: +5 to +40°C)
Video output	Output impedance of 75Ω, BNC connector, composite signals
Direct plotting function	Copying of CRT screens by an external plotter
FDD	Waveform data and setting conditions can be recorded in the MS-DOS format.

Q8460A  
OPTICAL FIBER REFLECTOMETER  
INSTRUCTION MANUAL

6. Specifications

Option specifications																					
Floppy disk function	3.5 inch FDD, MD-DOS format Save to waveform data and setting																				
	Record files																				
	<table border="1" style="width: 100%; border-collapse: collapse;"> <thead> <tr> <th style="width: 30%;">Data type (point)</th> <th colspan="2" style="width: 35%;">Displaying data (501)</th> <th colspan="2" style="width: 35%;">All of measurement data (max 15344)</th> </tr> <tr> <th>Data format</th> <th>BINARY</th> <th>ASCII</th> <th>BINARY</th> <th>ASCII</th> </tr> </thead> <tbody> <tr> <td>2DD (720k bytes)</td> <td style="text-align: center;">112</td> <td style="text-align: center;">101</td> <td style="text-align: center;">11</td> <td style="text-align: center;">5</td> </tr> <tr> <td>2HD (1M bytes)</td> <td style="text-align: center;">192</td> <td style="text-align: center;">174</td> <td style="text-align: center;">19</td> <td style="text-align: center;">9</td> </tr> </tbody> </table>	Data type (point)	Displaying data (501)		All of measurement data (max 15344)		Data format	BINARY	ASCII	BINARY	ASCII	2DD (720k bytes)	112	101	11	5	2HD (1M bytes)	192	174	19	9
	Data type (point)	Displaying data (501)		All of measurement data (max 15344)																	
	Data format	BINARY	ASCII	BINARY	ASCII																
	2DD (720k bytes)	112	101	11	5																
2HD (1M bytes)	192	174	19	9																	
Operating ambient +5 to +40°C																					

General specifications	
Operating ambient range	Ambient temperature: 0 to +40°C, relative humidity: less than 85% RH
Storing temperature range	Ambient temperature: -20 to +60°C
Power supply	90 to 250 VAC, 47 to 440Hz
Power consumption	Less than 170VA (including plug-in unit)
External dimensions	Approx. 330 (width) x 177 (height) x 450 (depth) mm
Weight	Less than 16kg (including plug-in unit)

Q8460A  
OPTICAL FIBER REFLECTOMETER  
INSTRUCTION MANUAL

6. Specifications

(2) Q84601 specifications

Model		Q84601				
Applicable fiber type		10/125 $\mu\text{m}$ Single Mode Fiber				
Output pulse	Wavelength	1.31 $\pm$ 0.02 $\mu\text{m}$				
	Pulse width	3ns	20ns	100ns	1 $\mu\text{s}$	
Dynamic range (One-way back-scattered light)		4dB	7dB	11dB	16dB	
Near-end dead zone		Back-scatter mode	$\leq 25\text{m}$	$\leq 25\text{m}$	$\leq 40\text{m}$	$\leq 130\text{m}$
		Reflection mode	$\leq 5\text{m}$	$\leq 15\text{m}$	$\leq 30\text{m}$	$\leq 150\text{m}$
Spatial resolution	Non-reflective	Back-scatter mode	—	$\leq 5\text{m}$	$\leq 15\text{m}$	$\leq 85\text{m}$
	reflective		$\leq 5\text{m}$	$\leq 10\text{m}$	$\leq 20\text{m}$	$\leq 120\text{m}$
			Reflection mode	$\leq 3\text{m}$	$\leq 5\text{m}$	$\leq 15\text{m}$
Optical mask function		Yes				
Optical connector		FC type*				
Laser class		21CFR Class 1				

\* : Consult us for connectors other than FC type.

Q8460A  
OPTICAL FIBER REFLECTOMETER  
INSTRUCTION MANUAL

6. Specifications

(3) Q84606 specifications

Model		Q84606				
Applicable fiber type		50/125 $\mu$ m Multi Mode Fiber				
Output pulse	Wavelength	1.30 $\pm$ 0.02 $\mu$ m				
	Pulse width	3ns	20ns	100ns	1 $\mu$ s	
Dynamic range (One-way back-scattered light)		6dB	9dB	13dB	18dB	
Near-end dead zone		Back-scatter mode	$\leq$ 10m	$\leq$ 15m	$\leq$ 20m	$\leq$ 120m
		Reflection mode	$\leq$ 1m	$\leq$ 1m	$\leq$ 1m	$\leq$ 1m
Spatial resolution	Non-reflective	Back-scatter mode	$\leq$ 3m	$\leq$ 5m	$\leq$ 15m	$\leq$ 85m
	reflective		$\leq$ 4m	$\leq$ 10m	$\leq$ 20m	$\leq$ 120m
		Reflection mode	$\leq$ 3m	$\leq$ 5m	$\leq$ 15m	$\leq$ 110m
Optical mask function		No				
Optical connector		FC type*				
Laser class		21CFR Class 1				

\* : Consult us for connectors other than FC type.

Q8460A  
OPTICAL FIBER REFLECTOMETER  
INSTRUCTION MANUAL

6. Specifications

(4) Q84605 specifications

Model		Q84605				
Applicable fiber type		50/125 $\mu$ m Multi Mode Fiber				
Output pulse	Wavelength	0.85 $\pm$ 0.02 $\mu$ m				
	Pulse width	3ns	20ns	100ns	1 $\mu$ s	
Dynamic range (One-way back-scattered light)		9dB	13dB	17dB	22dB	
Near-end dead zone		Back-scatter mode	$\leq$ 10m	$\leq$ 15m	$\leq$ 20m	$\leq$ 120m
		Reflection mode	$\leq$ 1m	$\leq$ 1m	$\leq$ 1m	$\leq$ 1m
Spatial resolution	Non-reflective	Back-scatter mode	—	$\leq$ 5m	$\leq$ 15m	$\leq$ 85m
			$\leq$ 5m	$\leq$ 10m	$\leq$ 20m	$\leq$ 120m
	reflective	Reflection mode	$\leq$ 3m	$\leq$ 5m	$\leq$ 15m	$\leq$ 110m
Optical mask function		No				
Optical connector		FC type*				
Laser class		21CFR Class 1				

\* : Consult us for connectors other than FC type.



Q8460A  
OPTICAL FIBER REFLECTOMETER  
INSTRUCTION MANUAL

6. Specifications

(5) Q84605P specifications

Model		Q84605P				
Applicable fiber type		200/230 $\mu\text{m}$ Plastic Clad Fiber				
Output pulse	Wavelength	0.85 $\pm$ 0.02 $\mu\text{m}$				
	Pulse width	3ns	20ns	100ns	1 $\mu\text{s}$	
Dynamic range (One-way back-scattered light)		9dB	13dB	17dB	22dB	
Near-end dead zone		Back-scatter mode	$\leq 10\text{m}$	$\leq 15\text{m}$	$\leq 20\text{m}$	$\leq 120\text{m}$
		Reflection mode	$\leq 1\text{m}$	$\leq 1\text{m}$	$\leq 1\text{m}$	$\leq 1\text{m}$
Spatial resolution	Non-reflective	Back-scatter mode	—	$\leq 5\text{m}$	$\leq 15\text{m}$	$\leq 85\text{m}$
			$\leq 5\text{m}$	$\leq 10\text{m}$	$\leq 20\text{m}$	$\leq 120\text{m}$
	reflective	Reflection mode	$\leq 3\text{m}$	$\leq 5\text{m}$	$\leq 15\text{m}$	$\leq 110\text{m}$
Optical mask function		No				
Optical connector		FC type*				
Laser class		21CFR Class 1				

\* : Consult us for connectors other than FC type.

Q8460A  
OPTICAL FIBER REFLECTOMETER  
INSTRUCTION MANUAL

6. Specifications

(6) Q84621 specifications

Model		Q84621				
Applicable fiber type		10/125 $\mu\text{m}$ Single Mode Fiber				
Output pulse	Wavelength	1.31 $\pm$ 0.02 $\mu\text{m}$ / 1.55 $\pm$ 0.03 $\mu\text{m}$				
	Pulse width	3ns	20ns	100ns	1 $\mu\text{s}$	
Dynamic range (One-way back-scattered light)* <sup>1</sup>		4dB (1.31 $\mu\text{m}$ ) —	7dB (1.31 $\mu\text{m}$ ) 4dB (1.55 $\mu\text{m}$ )	11dB (1.31 $\mu\text{m}$ ) 8dB (1.55 $\mu\text{m}$ )	16dB (1.31 $\mu\text{m}$ ) 13dB (1.55 $\mu\text{m}$ )	
Near-end dead zone		Back-scatter mode	$\leq$ 25m	$\leq$ 25m	$\leq$ 40m	$\leq$ 130m
		Reflection mode	$\leq$ 5m	$\leq$ 15m	$\leq$ 30m	$\leq$ 150m
Spatial resolution	Non-reflective	Back-scatter mode	—	$\leq$ 5m	$\leq$ 15m	$\leq$ 85m
	reflective		$\leq$ 5m	$\leq$ 10m	$\leq$ 20m	$\leq$ 120m
			Reflection mode	$\leq$ 3m	$\leq$ 4m	$\leq$ 15m
Optical mask function		Yes				
Optical connector		FC type* <sup>2</sup>				
Laser class		21CFR Class 1				

\*<sup>1</sup>: Sampling times; 2\*<sup>1</sup>. Span; 20km

\*<sup>2</sup>: Consult us for connectors other than FC type.

Q8460A  
OPTICAL FIBER REFLECTOMETER  
INSTRUCTION MANUAL

6. Specifications

(7) Q84621A specifications

Model		Q84621A				
Applicable fiber type		10/125 $\mu\text{m}$ Single Mode Fiber				
Output pulse	Wavelength	1.31 $\pm$ 0.02 $\mu\text{m}$ / 1.55 $\pm$ 0.03 $\mu\text{m}$				
	Pulse width	3ns	20ns	100ns	1 $\mu\text{s}$	
Dynamic range (One-way back-scattered light) * <sup>1</sup>		4dB (1.31 $\mu\text{m}$ ) —	9dB (1.31 $\mu\text{m}$ ) 6dB (1.55 $\mu\text{m}$ )	13dB (1.31 $\mu\text{m}$ ) 10dB (1.55 $\mu\text{m}$ )	18dB (1.31 $\mu\text{m}$ ) 15dB (1.55 $\mu\text{m}$ )	
Near-end dead zone	Back-scatter mode	* <sup>2</sup>	$\leq$ 25m	$\leq$ 25m	$\leq$ 40m	$\leq$ 130m
		* <sup>3</sup>	$\leq$ 45m	$\leq$ 45m	$\leq$ 50m	$\leq$ 130m
	Reflection mode	$\leq$ 5m	$\leq$ 15m	$\leq$ 30m	$\leq$ 150m	
Spatial resolution	Non-reflective	Back-scatter mode	—	$\leq$ 5m	$\leq$ 15m	$\leq$ 85m
	Reflective		$\leq$ 5m	$\leq$ 10m	$\leq$ 20m	$\leq$ 120m
		Reflection mode	$\leq$ 3m	$\leq$ 5m	$\leq$ 15m	$\leq$ 110m
Optical mask function		Yes				
Optical return loss measurement function* <sup>4</sup>		Accuracy	$\pm$ 2dB			
		Maximum	20dB			
Optical connector		FC type* <sup>5</sup>				
Laser class		21CFR Class 1				

\*<sup>1</sup>: The dynamic range value is obtained by 2<sup>18</sup> averagings.

\*<sup>2</sup>: Temperature; +25 $\pm$ 5  $^{\circ}\text{C}$

\*<sup>3</sup>: Temperature; 0 $^{\circ}\text{C}$  to +40 $^{\circ}\text{C}$

\*<sup>4</sup>: When optical return loss measurement function, dynamic range have gone down 3dB.

\*<sup>5</sup>: Consult us for connectors other than FC type.



## A.1 Optical Terms

## Automatic Power-Control (APC)

Application of electric power so as to make light output constant. When a laser diode is driven by a constant-current source, its light output decreases or its oscillation stops with increase in temperature, and its light output increases with decrease in temperature. When the temperature decreases, the light output may exceed the maximum rating. An APC circuit is designed to receive the monitor light of the laser diode at a photo diode and to feed it back to the driving circuit in order to protect the laser diode and to obtain a stable light output at the same time.

## Avalanche Photodiode

A light-sensitive element which is often used in optical-fiber cable communications. When a high reverse bias voltage (100 to 200 V) is applied to the pn junction of semiconductors, carriers are generated one after another as they move slightly, and the current increasingly accelerates by the avalanche effect. This diode uses this avalanche effect.

## Back-Scattered Light

When light travels through an optical fiber, Rayleigh scattering occurs at all points along the fiber. This scattering occurs both in the forward and backward directions. However, Backward-scattered light refers to low-intensity part of Rayleigh-scattered light that has been scattered backward first and then returns to the end of incidence as the waveguide mode of optical fiber.

## Baseband Transmission Characteristics

When pulse light is incident onto one end of an optical fiber, the width of the output pulse at the other end is greater than that of the incident pulse. This phenomenon is called dispersion. It illustrates the increase of transmission loss in time domain. When converting this dispersion phenomenon into that in the frequency domain, it is determined that the transmission loss in the high-frequency range increases. These transmission characteristics in the frequency domain are called the baseband transmission characteristics. It is an important optical fiber performance factor.

## Beam Divergence Angle

An angle at which radiation intensity becomes one half of that of the optical axis (where the radiation intensity is maximum). In the case of a laser diode, an angle between a junction and a horizontal direction is  $\theta_{//}$ , and an angle between a junction and a vertical direction is  $\theta_{\perp}$ .  
(  $\theta_{\perp} > \theta_{//}$  )

### Breakpoint Detection

Detection of the part of the core of an optical fiber at which a break occurred. When light is directed into a broken optical fiber, it is scattered at the breakpoint and leaks to the outside of the core. The breakpoint in an optical fiber can be found by detecting such leaked light.

### Chopped Light

The intensity of the light modulated by a rectangular wave. That is, the light is intermittently output at certain repetitive periods.

### Cladding

A part of the structure of an optical fiber. An optical fiber consists of a core at the center and cladding surrounding the core. It is generally made of quartz glass or plastic. The cladding has a refractive index which is about 1% lower than that of the core so as to confine the light in the core with stability.

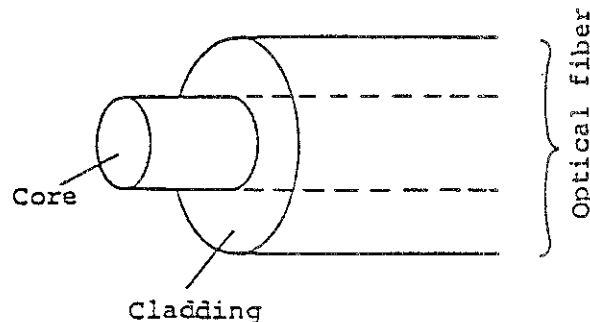

### Coated Fiber

A core and a cladding of an optical fiber covered with a primary coating (of silicone resin) and a secondary coating (of a nylon protective layer).

### Coherence

1. The relationship with respect to time between two or more waves.
2. When the wavelength, phase, and wave front of light coincide completely, such light is said to have coherence. There are two kinds of coherence; temporal coherence and spatial coherence. Temporal coherence is the uniformity of wavelength and the continuity of phase. Spatial coherence means the ability to focus the light to a point by the use of a lens. As typically expressed by laser light, light having coherence and a specific phase relationship with the same wavelength is called the coherent light.

### Coherent

Light is an electromagnetic wave having a very short wavelength. Visible light, however, is greatly different from the electromagnetic waves used in radio and TV broadcasting. That is, the electromagnetic waves for radio and TV broadcasting are waves having completely coinciding in frequency, phase, and wave front, while, light from an electric lamp, for example, has no such completely coinciding frequency, phase, and wave front. Therefore, it can be regarded as a kind of noise. Light having completely coinciding frequency, phase, and wave front is called coherent light. The light from a laser diode used in optical communication is not completely coherent but highly coherent light. [OPE]

### Core

The central part of an optical fiber, which is surrounded by cladding. The light travels through the core. It is made of quartz and its refractive index is greater than that of the cladding by about 1%. There are two kinds of optical fibers, distinguished according to the thickness of the core; multi-mode fiber of about 50 to 100  $\mu\text{m}$  in diameter and single-mode fiber of about 10  $\mu\text{m}$  in diameter. In addition, optical fiber is classified into a GI type and an SI type according to the difference in the distribution of the refractive index of the core/cladding.

### Core and Cladding

The center and the surrounding part of an optical fiber are called a core and cladding respectively. Since the refractive index of the cladding is lower than that of the core, light directed into the core travels through the core in a confined state by repeating the total reflection at the boundary surface between the core and the cladding. Generally, the diameters of the core and the cladding are expressed by the form of 50/125  $\mu\text{m}$ .

This expression means that the core diameter is 50  $\mu\text{m}$  and the cladding diameter is 125  $\mu\text{m}$ .

### CW Light

Light with constant intensity and without modulation. It is also called DC light.

### Dark Current

The output current of a light-sensitive element without incident light.

### Direct Modulation

The use of a modulated signal as a driving current to turn on a light source. When a photo modulator is used for this purpose, such a method is called external modulation. [OPE]

## APPENDIX

### A.1 Optical Terms

#### Directivity

Cases when the light output or the light receiving sensitivity is greater in the specific direction.

#### Double Heterojunction

A heterojunction means a junction between crystals having a different atomic composition. In the case of double heterojunction used in a laser diode, cladding layers having wide energy gaps are placed on both sides of an activated layer to confine the carrier in order to increase the density of the minority carrier. It is used to form an optical waveguiding path.

#### Emission Peak Wavelength

A wavelength at which the energy density of a luminescent spectrum of light emitting elements becomes maximum.

Symbol:  $\lambda_p$

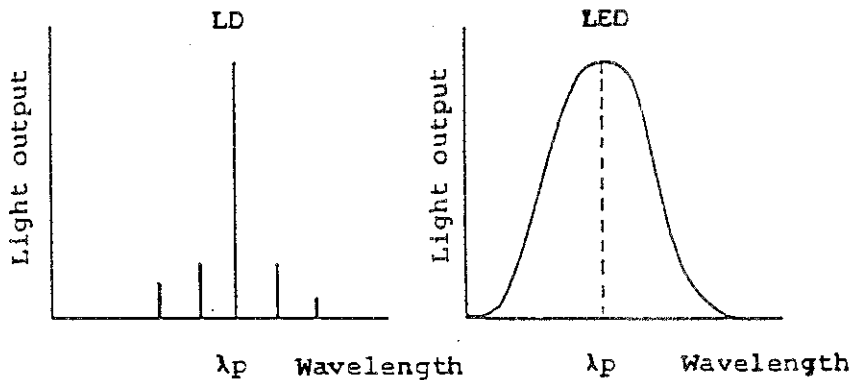

#### Excess Noise Factor

The coefficient of the shot noise multiplied in an avalanche photodiode. It is defined as  $F = M^x$ .

The shot noise current  $i_N$  increases with fluctuations in the multiplication process, according to the following equation:

$$\langle i_N^2 \rangle = 2qIM^{2+x}B$$

- M: multiplication factor
- B: signal bandwidth
- x: excess noise index
- q: charge of electron
- I: Average current flowing through the avalanche region



## APPENDIX

### A.1 Optical Terms

---

#### Exciter

A device to excite an optical fiber to be tested, in the stationary mode, in light loss measurement or transmission characteristics measurement, etc. For this purpose, the following methods are used:

Using a dummy optical fiber of several hundred meters in length; controlling the incident mode power distribution by using microbending of an optical fiber, controlling the mode distribution by sequentially connecting graded type optical fiber, step type optical fiber, and so on. (GSG type or SGS type exciting optical fiber cord, and so on are available.)

#### Fiber Identification

Individual distinction of the many fibers in an optical fiber cable. Particularly, light is directed at one end of an optical fiber and the transmitted light is detected at the other end.

#### Fresnel Reflections

The reflection when light passes through a boundary face between materials of different light refractive indexes. When a light pulse is directed into an optical fiber, a portion of the pulse is reflected from the media boundary face such as that of optical fiber and air, for example, at the end of the optical fiber or at a breakpoint in the optical fiber. Such reflection is called Fresnel reflection. In the case of an ideal break face (a mirror-like break at right angles to the axis of an optical fiber), about 4% reflection (-14 dB) occurs.

#### Fundamental Mode

An electromagnetic distribution of the 0th order. It is also called a single transverse mode.

#### Graded Index Fiber

A kind of a multi-mode fiber having a core with a refractive index distribution in radial form. Therefore, the light through the center of the core travels slower and light through the peripheral part travels faster, so that the light propagation time becomes constant regardless of the path of the light. As a result, it is possible to decrease the spreading of the emitted pulse with time. (In other words, the mode dispersion is less.) Therefore this fiber has a much wider transmission bandwidth compared with that of a step-index fiber (several hundreds MHz-km).

### Infrared Rays

Light having a wavelength which is longer than that of visible light.

Near infrared rays : 0.78 to 3  $\mu\text{m}$  in wavelength  
Middle infrared rays: 3 to 30  $\mu\text{m}$  in wavelength  
Far infrared rays : 30  $\mu\text{m}$  to 1 mm in wavelength  
Microwave : Over 1 mm in wavelength

### Laser

Solid lasers, gas lasers, liquid lasers, and so on are available. A semiconductor laser is used as the light source used in optical fiber communication because of its compactness and the capability of direct modulation, compared with other lasers. The laser has excellent coherence, and has high speed response, compared with LEDs, which means that laser is an important light source. The abbreviation for semiconductor laser is LD.

### Laser Diode

One of the semiconductor light emitting elements. Laser is the abbreviation of light amplification by stimulated emission of radiation. That is, the laser diode is an oscillator which emits light according to this principle. The laser diode has various merits such as a high light output, capability of high speed direct modulation, high connection efficiency to optical fibers, and so on. In the past, however, the LED had been principally used because of its light emission stability. Recently, the problem of laser emission stability has been solved. Therefore, the laser diode is now used as the light emission source for high speed, long distance communications.

### Leak Light

When an optical fiber is bent or when pressure is applied to an optical fiber, the path of the light propagating through a core is bent and can be seen externally. This light is called leak light.

### Light Sensor

In optical fiber communication, a photo diode (PD) utilizing the photovoltaic effect or the photoconductive effect is used. There are two kinds of PDs; pn junction type and a pin type. A PD which uses the avalanche effect by applying a reverse bias voltage to the pn junction is called an avalanche photodiode (APD). Measuring instruments principally use these light sensors. A thermopile, utilizing the thermosensitive effect, is used as the detector in a standard power meter, because its sensitivity is constant regardless of the wavelength.

### Light-Emitting Diode

One type of semiconductor light-emitting element. It uses light which is emitted by re-combination of the carrier injected at the pn junction of semiconductors, similar to a laser diode. The LED differs from a laser diode in that its light is emitted naturally. (In the case of the laser diode, the light is emitted by induction.) The features of the LED include long life and stability, moderated price, and excellent linearity. However, the LED has such disadvantages as low incident power for optical fiber and the impossibility of high-speed modulation. Therefore, the LED is a suitable light emitting element for a system handling small capacities for over relatively short distances, analog systems, and so on.

### Long Wavelength Region

Of the wavelength of light used in optical fiber communications, in this region the wavelength is in the range 1.0 $\mu$  to 1.5  $\mu$ m. This long wavelength region is used for long-distance communications because of its low transmission loss.

### Longitudinal Mode

A status in which emission spectrum having very small half value widths are not continuously present, or else individual luminescent spectra. The difference in wavelength from the adjacent mode is called a longitudinal mode interval. When the number of modes is one, it is called a single longitudinal mode.

### Luminous Flux

Luminous flux is expressed in units of lm (lumen) by the equation given below.

$$F = K_m \int_{380}^{780} V(\lambda) d$$

$K_m$  : Maximum luminous efficacy, 680lm/W

$V(\lambda)$ : Relative spectral luminous efficacy (the value which is determined by the International Commission on Illumination (CIE))

1.00004 for the yellow-green spectrum ( $\lambda = 555$  nm)

## APPENDIX

### A.1 Optical Terms

---

#### Luminous Intensity

Luminous intensity is expressed in (Cd) candella by the equation given below.

$$i = \frac{dF}{d\omega}$$

F: Luminous flux

$\omega$ : Solid angle

The radiant intensity is the luminous intensity in the energy unit.

#### Monitor Current

The output of a monitor diode, when the light emitted from the chip back of a laser diode is received by a monitor diode.

#### Monitor Output

The light which is emitted toward the chip back of a laser diode.

#### Multi-Mode Fiber

For an optical fiber in which multiple light guiding modes exist, many modes (each mode having a different light propagation angle to the central axis of an optical fiber) are transmitted through a core at the same time. There are various kinds of multi-mode fibers according to the difference in the refractive index distribution. These include a step type optical fiber and graded type optical fiber. These optical fibers have a core of relatively large size (50 to 100  $\mu$ m). They also allow easy connection compared with single mode fiber. However, because many modes propagate through the multi-mode fiber, the transmission rate differs according to the mode and so the transmission bandwidth becomes somewhat narrower. (Mode dispersion)

#### Numerical Aperture

The degree of extension of light at the end of an optical fiber, which has a cylindrical core having a refractive index of  $n_1$  and which is surrounded by clad having a refractive index of  $n_2$  ( $n_1 > n_2$ ), due to a similarity in the lens system. Of the light falling on a plane, which includes the axis of the core of the optical fiber and which crosses the axis (the meridian light), if some light, which attains critical angle with respect to the axis, crosses the axis of the core outside the optical fiber at angle  $\theta$ , the NA of the optical fiber can be expressed by the equation given below.

$$NA = n \sin \theta = \sqrt{n_1^2 - n_2^2}$$

n: Refractive index of the media in which the optical fiber is placed

### Optical Fiber

A light guiding path through which light can travel, in spite of bends in the path, by setting the refractive index of the outside to a lower level in comparison with that of the inside. It consists of two kinds of quartz glass (a core and a cladding) having different refractive indexes arranged in the radial direction in the form of a glass fiber of about 0.12 mm in diameter. It has such excellent characteristics as wide bandwidth, low loss, and non-induction.

### Optical Fiber Connector

A detachable connector to connect optical fibers to each other or to connect an optical fiber with a device. Generally, two optical fibers are simply abutted against each other. That is, the end of one optical fiber is directly abutted against that of the other one by means of a connector the center of which is sufficiently aligned with those of the optical fibers. The optical fiber connector is different from an electrical connector in mechanical accuracy and connection loss. That is, the former has a higher mechanical accuracy and a connection loss of about 0.5 to 1 dB. Special care should be taken when handling this connector to protect it from dust.

### Optical Rotary Power

A phenomenon of the rotation of a plane of polarization when linearly polarized light passes through material.

### ORL

If a Fresnel reflection occurs at a point in distance " $\ell$ ", its value " $P_r$ " ( $\ell$ ) can be indicated by the sum of back-scattered light " $P_b$ " and Fresnel reflection " $P_f$ " ( $\ell$ ) as follows:

$$P_r (\ell) = P_b (\ell) + P_f (\ell) \dots\dots\dots (1)$$

The back-scattered light can be expressed as follows:

$$P_b (\ell) = K * P_i * W * \exp (-2 \alpha \ell) \dots\dots\dots (2)$$

K : Optical fiber cable constant  
 P<sub>i</sub>: Incident light strength  
 W : Pulse width

APPENDIX

A.1 Optical Terms

Fresnel reflection "Pf" ( $\ell$ ) can be expressed as follows:

$$Pf(\ell) = Pi * ORL * \exp(-2\alpha\ell) \dots\dots\dots (3)$$

Difference H between the back-scattered light and Fresnel reflection on the OTDR waveforms can be expressed by using parameters Pb ( $\ell$ ) and Pf ( $\ell$ ) as follows:

$$H = 5\log(P_r(\ell)/P_b(\ell)) \dots\dots\dots (4)$$
$$= 5\log(ORL/kw + 1)$$

Therefore, the ORL value can be determined by using K, W and H as follows:

$$ORL(\text{ratio}) = K * W * (10^{H/5} - 1) \dots\dots\dots (5)$$
$$ORL(\text{dB}) = -10\log(kw) - 10\log(10^{H/5} - 1)$$

OTDR Method

An abbreviation of optical time domain reflectometer method. A system to detect a defective point or a loss characteristic of optical cable by using a light pulse as a signal, transmitted through the optical cable to be tested, and detecting the Fresnel reflection at a breakpoint or the Rayleigh scattered light of the optical fiber circle. Fiber optic time domain reflectometer (FOTDR).

Pigtail Fiber

An optical fiber with one or both ends open.

Polarizer

An element to convert natural light into linearly polarized light.

## APPENDIX

### A.1 Optical Terms

---

#### Quantum Efficiency

- Light-emitting element (light emitting diode and laser diode)

The ratio of the number of carriers caused by current application to the number of photons generated (internal quantum effect) or the number of photons emitted (external quantum effect). The quantum efficiency is expressed by the equation given below.

$$\eta = \frac{q\lambda}{hc} \cdot \frac{P}{I} = \frac{\lambda}{1.24} \cdot \frac{P}{I}$$

h: Planck's constant  
c: Velocity of light in a vacuum  
q: Charge of electron  
 $\lambda$ : Wavelength ( $\mu\text{m}$ )  
P: Light output  
I: Current

In the case of a laser diode, the term differential quantum efficiency is also used.

- Light receiving element (pin photodiode, APD)

The ratio of the number of carriers generated to the number of incident photons. The quantum efficiency ( $\eta'$ ) is expressed by the equation given below. This equation is opposite to that for a light emitting element.

$$\eta' = \frac{hc}{q\lambda} \cdot \frac{I}{P} = \frac{1.24}{\lambda} \cdot \frac{I}{P}$$

The quantum efficiency of an avalanche photodiode is expressed on the assumption that the multiplication factor is 1.

#### Radiant Flux

The amount of light energy which is emitted or propagated per unit time.

#### Rayleigh Scattering

Light scattering by a slight fluctuation of the refractive index of material when the light propagates through such material. The light scattering which is generated by the fluctuation of a refractive index which is shorter than the wavelength in an optical fiber.

## APPENDIX

---

### A.1 Optical Terms

#### Responsivity

A current output when a unit radiant flux is directed into a light-sensitive element. It is expressed by the equation given below.

$$R = \frac{I}{P} = 0.806 \times \eta \times \lambda \times M \text{ (A/W)}$$

- R: Responsivity
- $\eta$ : Quantum efficiency
- $\lambda$ : Wavelength
- M: Multiplication constant

#### Short Wavelength Region

The wavelength used in optical fiber communications is about 0.8 to 1.5  $\mu\text{m}$ , namely, in the so-called near-infrared domain. In this wavelength region, light having a wavelength of about 0.8  $\mu\text{m}$  is called the short wavelength region. It has been used in optical fiber communications since early times, and the actual results of the development of practical systems have been most remarkable. Recently, the long wavelength region, the region of light having a wavelength longer than 1  $\mu\text{m}$ , has been developed. [OPE]

#### Short-Term Stability

The stability of an optical output over a short time, when the ambient temperature is constant.

#### Single-Mode Fiber

When the diameter of a core is decreased to about 10  $\mu\text{m}$ , and optical fiber having only one propagating mode is obtained. This optical fiber is called a single-mode fiber. One feature of this fiber is its very wide bandwidth (several GHz), because it is free from the mode dispersion of a multi mode fiber.



## APPENDIX

### A.1 Optical Terms

#### Spatial Resolution

This shows a performance to discriminate the interval between two adjoining fault points by OTDR.

In our company, the reflective fault point is identified by the full width half maximum value FWHM (Full Width at Half Maximum) of the reflected pulse, and the nonreflective fault point is identified by the length where the intensity drops by 3dB.

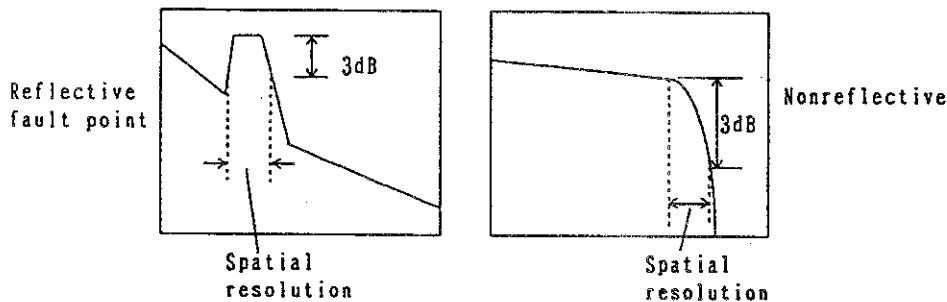

#### Specific Rotatory Power

A quantity to indicate the intensity of optical activity power of optically active substances.

#### Speckle Effect

The noise produced by the interference of coherent light scattered in an optical fiber in an irregular phase relationship.

#### Spectral Width/ Full Width at Half Maximum/ $\Delta\lambda$

The distance between two wavelengths where the energy density of the light emitting spectrum becomes 1/2 of the maximum value of a light emitting element.

#### Spectrum

Normal light is made up of synthesized sine waves. A spectrum is the arrangement of each component on a wavelength axis. A white light source has a flat spectrum with the LD concentrated in a narrow range.

#### Splicing

A permanent connection between one optical fiber and another required in the installation of an optical fiber cable. Various splicing methods are now available. Generally, a fusing connection method is used in which one optical fiber is fused with another by the arc discharge method. This method is predominant because of its minimum connection loss and high stability.

### Threshold Current

The minimum current which can start laser oscillation. Since the domain where spontaneous emission changes to a laser oscillation is not strictly defined in most cases, the intersection between the extended line of the current-light output characteristics in the laser oscillation and the zero value line of the light output is specified as the threshold current.

Symbol:  $I_{th}$

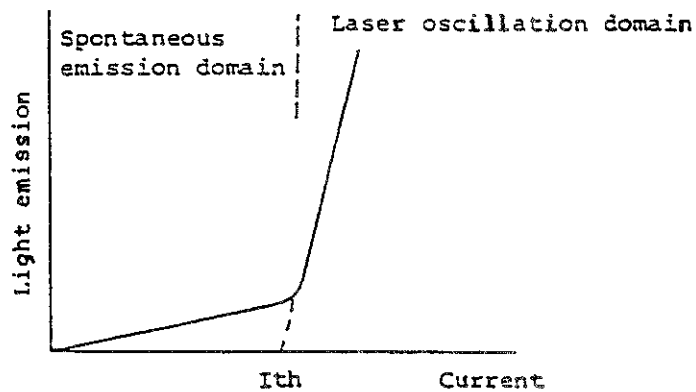

### Ultraviolet rays

Light having a wavelength shorter than that of visible light in the wavelength range of 300 to 380 nm.

### Visible Light

Light which can be seen by the human eye in the wavelength range of 380 to 780 nm.

### Wavelength Division Multiplexing

A communication system to transmit two or more kinds of signals through the one optical fiber at the same time. In this case, as a transmitter, light emitting diodes with various wavelengths and laser diodes are used. Both unidirectional systems and bidirectional systems are available.

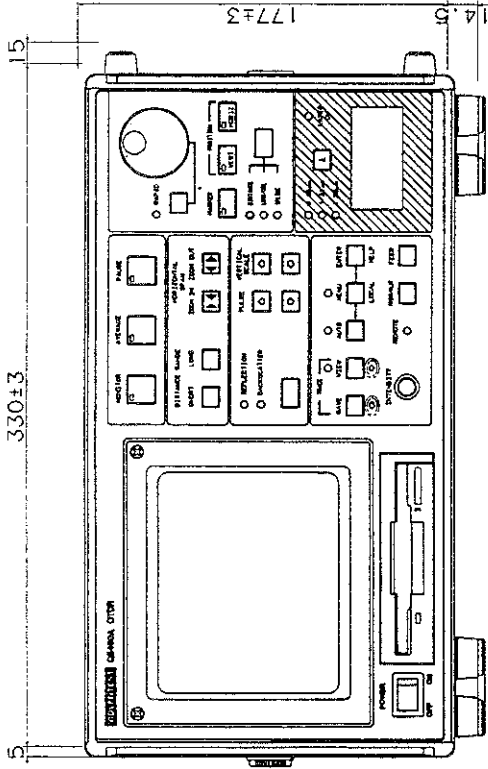
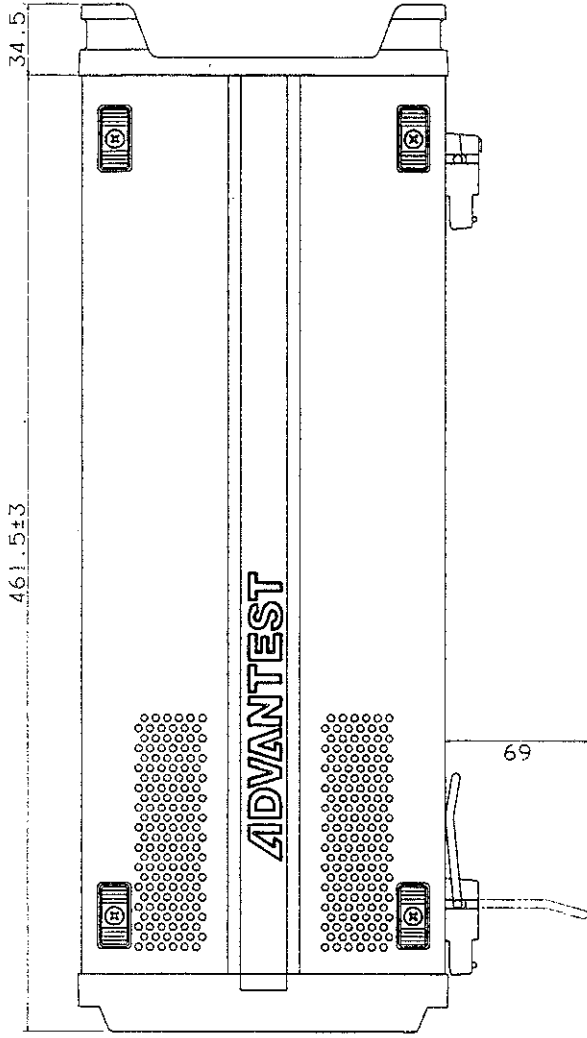

Unit: mm

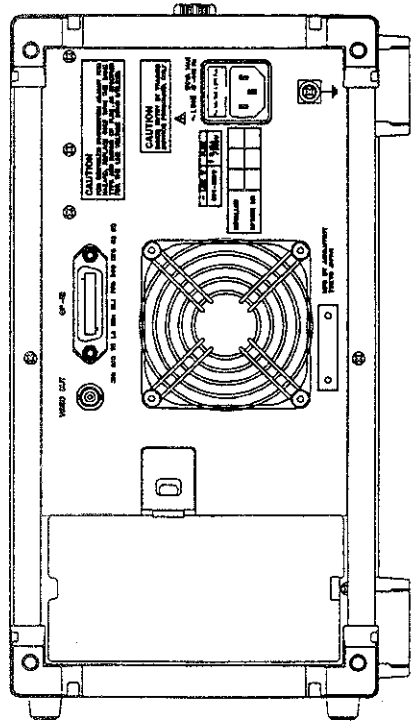

# Q8460A EXTERNAL VIEW



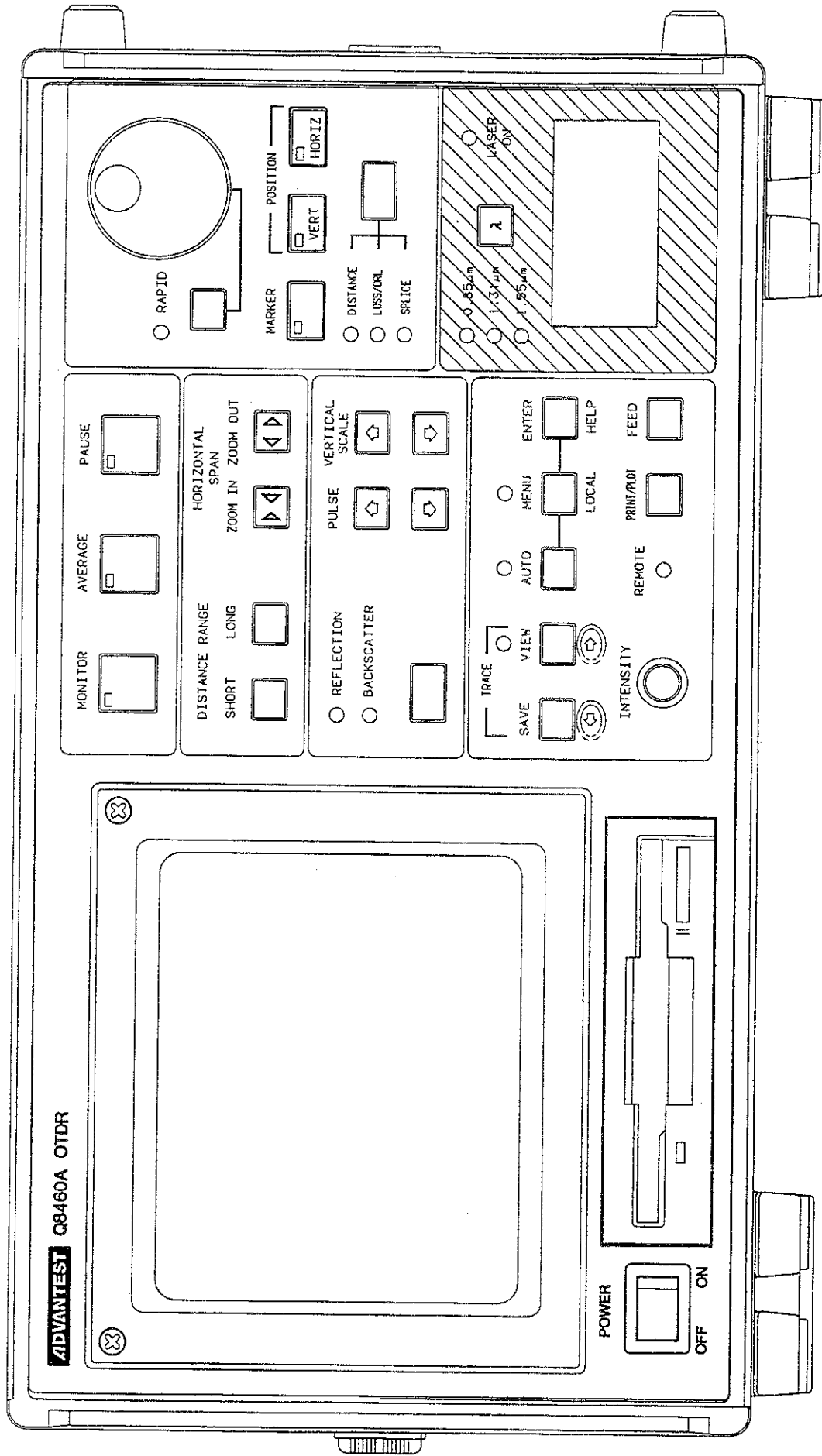

**Q8460A**

**FRONT VIEW**

Q8460A.EXT2-9012-A



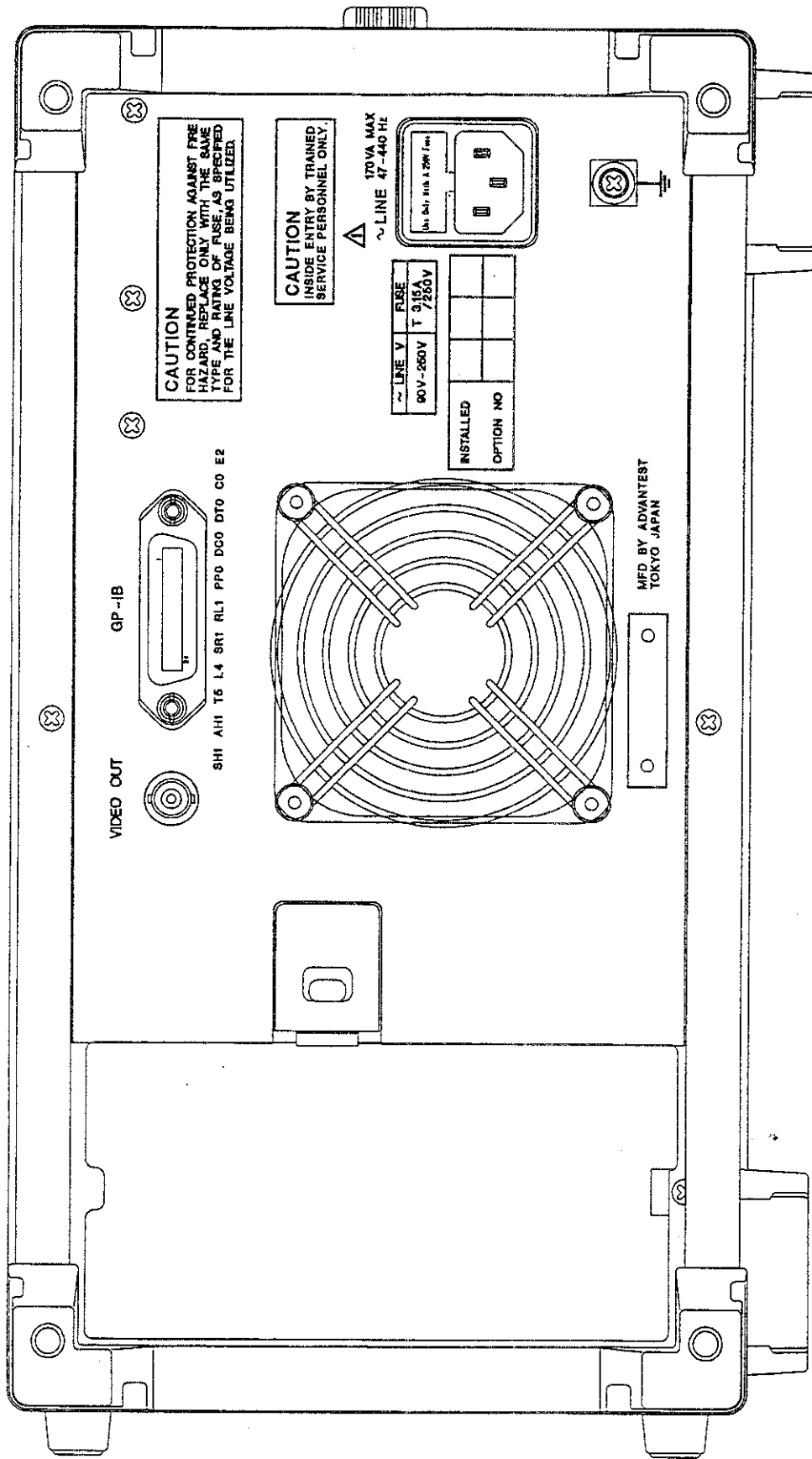

**Q8460A**  
**REAR VIEW**





Q8460A  
OPTICAL FIBER REFLECTOMETER  
INSTRUCTION MANUAL

Alphabetical Index

ALPHABETICAL INDEX

<p style="text-align: center;">[A]</p> <p>ADVANCE FUNCTION ..... 2 - 9</p> <p>ASCII Format ..... 5 - 8</p> <p>Accessories ..... 1 - 5</p> <p>Ambient Conditions ..... 1 - 9</p> <p>Appearance Check ..... 1 - 5</p> <p>Automatic Measuring   Function ..... 3 - 72</p> <p>Averaging ..... 3 - 9</p>	<p style="text-align: center;">[L]</p> <p>Label ..... 3 - 66</p>
<p style="text-align: center;">[B]</p> <p>Backscatter Mode ..... 3 - 8</p> <p>Binary Output ..... 5 - 8</p>	<p style="text-align: center;">[M]</p> <p>Marker Functions ..... 3 - 25</p> <p>Mask Functions ..... 3 - 17</p> <p>Mask Point Cancellation .... 3 - 21</p> <p>Mask Point Setting ..... 3 - 17</p> <p>Measuring Mode ..... 3 - 8</p> <p>Multiple Reflection ..... 3 - 76</p>
<p style="text-align: center;">[C]</p> <p>CMV ..... 1 - 7</p> <p>CRT Display ..... 2 - 8</p> <p>Clock ..... 3 - 68</p>	<p style="text-align: center;">[O]</p> <p>ORL ..... 3 - 40</p> <p>Operation Outline ..... 3 - 1</p> <p>Operation Principle ..... 4 - 1</p>
<p style="text-align: center;">[D]</p> <p>Display ..... 3 - 67</p> <p>Distance Range ..... 3 - 7</p>	<p style="text-align: center;">[P]</p> <p>Plug-in Unit ..... 1 - 10</p> <p>Power Supply ..... 1 - 5</p> <p>Printer ..... 1 - 12</p> <p>Programming Examples ..... 5 - 32</p> <p>Pulse Width ..... 3 - 7</p>
<p style="text-align: center;">[F]</p> <p>Front Panel ..... 2 - 2</p> <p>Fuse ..... 1 - 8</p> <p>Floppy Disk Drive ..... 3 - 47</p>	<p style="text-align: center;">[R]</p> <p>Rear Panel ..... 2 - 7</p> <p>Reflection Mode ..... 3 - 8</p> <p>Refractive Index ..... 3 - 6</p> <p>Remote Control ..... 5 - 1</p>
<p style="text-align: center;">[G]</p> <p>GPIB ..... 5 - 1</p> <p>GPIB Keys ..... 5 - 6</p> <p>GPIB Read Commands ..... 5 - 34</p> <p>GPIB Setting Commands ..... 5 - 9</p> <p>GPIB Standards ..... 5 - 2</p>	<p style="text-align: center;">[S]</p> <p>Service Request ..... 5 - 7</p> <p>Setup ..... 3 - 2</p> <p>Specifications ..... 6 - 1</p> <p>Status Byte ..... 5 - 7</p>
<p style="text-align: center;">[H]</p> <p>Horizontal Span ..... 3 - 13</p> <p>Horizontal position ..... 3 - 13</p>	<p style="text-align: center;">[T]</p> <p>Talker Format ..... 5 - 8</p>
<p style="text-align: center;">[I]</p> <p>I/O ..... 3 - 69</p> <p>Initial setup ..... 3 - 3</p> <p>Interface Functions ..... 5 - 4</p> <p>Inventory Check ..... 1 - 5</p>	<p style="text-align: center;">[V]</p> <p>Vertical Position ..... 3 - 13</p> <p>Vertical Scale ..... 3 - 11</p>
	<p style="text-align: center;">[W]</p> <p>Waveform Memory ..... 3 - 42</p> <p>Write-protection ..... 3 - 47</p>



## **IMPORTANT INFORMATION FOR ADVANTEST SOFTWARE**

PLEASE READ CAREFULLY: This is an important notice for the software defined herein. Computer programs including any additions, modifications and updates thereof, operation manuals, and related materials provided by Advantest (hereafter referred to as "SOFTWARE"), included in or used with hardware produced by Advantest (hereafter referred to as "PRODUCTS").

### **SOFTWARE License**

All rights in and to the SOFTWARE (including, but not limited to, copyright) shall be and remain vested in Advantest. Advantest hereby grants you a license to use the SOFTWARE only on or with Advantest PRODUCTS.

### **Restrictions**

- (1) You may not use the SOFTWARE for any purpose other than for the use of the PRODUCTS.
- (2) You may not copy, modify, or change, all or any part of, the SOFTWARE without permission from Advantest.
- (3) You may not reverse engineer, de-compile, or disassemble, all or any part of, the SOFTWARE.

### **Liability**

Advantest shall have no liability (1) for any PRODUCT failures, which may arise out of any misuse (misuse is deemed to be use of the SOFTWARE for purposes other than its intended use) of the SOFTWARE. (2) For any dispute between you and any third party for any reason whatsoever including, but not limited to, infringement of intellectual property rights.

## LIMITED WARRANTY

1. Unless otherwise specifically agreed by Seller and Purchaser in writing, Advantest will warrant to the Purchaser that during the Warranty Period this Product (other than consumables included in the Product) will be free from defects in material and workmanship and shall conform to the specifications set forth in this Operation Manual.
2. The warranty period for the Product (the "Warranty Period") will be a period of one year commencing on the delivery date of the Product.
3. If the Product is found to be defective during the Warranty Period, Advantest will, at its option and in its sole and absolute discretion, either (a) repair the defective Product or part or component thereof or (b) replace the defective Product or part or component thereof, in either case at Advantest's sole cost and expense.
4. This limited warranty will not apply to defects or damage to the Product or any part or component thereof resulting from any of the following:
  - (a) any modifications, maintenance or repairs other than modifications, maintenance or repairs (i) performed by Advantest or (ii) specifically recommended or authorized by Advantest and performed in accordance with Advantest's instructions;
  - (b) any improper or inadequate handling, carriage or storage of the Product by the Purchaser or any third party (other than Advantest or its agents);
  - (c) use of the Product under operating conditions or environments different than those specified in the Operation Manual or recommended by Advantest, including, without limitation, (i) instances where the Product has been subjected to physical stress or electrical voltage exceeding the permissible range and (ii) instances where the corrosion of electrical circuits or other deterioration was accelerated by exposure to corrosive gases or dusty environments;
  - (d) use of the Product in connection with software, interfaces, products or parts other than software, interfaces, products or parts supplied or recommended by Advantest;
  - (e) incorporation in the Product of any parts or components (i) provided by Purchaser or (ii) provided by a third party at the request or direction of Purchaser or due to specifications or designs supplied by Purchaser (including, without limitation, any degradation in performance of such parts or components);
  - (f) Advantest's incorporation or use of any specifications or designs supplied by Purchaser;
  - (g) the occurrence of an event of force majeure, including, without limitation, fire, explosion, geological change, storm, flood, earthquake, tidal wave, lightning or act of war; or
  - (h) any negligent act or omission of the Purchaser or any third party other than Advantest.
5. **EXCEPT TO THE EXTENT EXPRESSLY PROVIDED HEREIN, ADVANTEST HEREBY EXPRESSLY DISCLAIMS, AND THE PURCHASER HEREBY WAIVES, ALL WARRANTIES, WHETHER EXPRESS OR IMPLIED, STATUTORY OR OTHERWISE, INCLUDING, WITHOUT LIMITATION, (A) ANY WARRANTY OF MERCHANTABILITY OR FITNESS FOR A PARTICULAR PURPOSE AND (B) ANY WARRANTY OR REPRESENTATION AS TO THE VALIDITY, SCOPE, EFFECTIVENESS OR USEFULNESS OF ANY TECHNOLOGY OR ANY INVENTION.**
6. **THE REMEDY SET FORTH HEREIN SHALL BE THE SOLE AND EXCLUSIVE REMEDY OF THE PURCHASER FOR BREACH OF WARRANTY WITH RESPECT TO THE PRODUCT.**
7. **ADVANTEST WILL NOT HAVE ANY LIABILITY TO THE PURCHASER FOR ANY INDIRECT, INCIDENTAL, SPECIAL, CONSEQUENTIAL OR PUNITIVE DAMAGES, INCLUDING, WITHOUT LIMITATION, LOSS OF ANTICIPATED PROFITS OR REVENUES, IN ANY AND ALL CIRCUMSTANCES, EVEN IF ADVANTEST HAS BEEN ADVISED OF THE POSSIBILITY OF SUCH DAMAGES AND WHETHER ARISING OUT OF BREACH OF CONTRACT, WARRANTY, TORT (INCLUDING, WITHOUT LIMITATION, NEGLIGENCE), STRICT LIABILITY, INDEMNITY, CONTRIBUTION OR OTHERWISE. TORT (INCLUDING, WITHOUT LIMITATION, NEGLIGENCE), STRICT LIABILITY, INDEMNITY, CONTRIBUTION OR OTHERWISE.**
8. **OTHER THAN THE REMEDY FOR THE BREACH OF WARRANTY SET FORTH HEREIN, ADVANTEST SHALL NOT BE LIABLE FOR, AND HEREBY DISCLAIMS TO THE FULLEST EXTENT PERMITTED BY LAW ANY LIABILITY FOR, DAMAGES FOR PRODUCT FAILURE OR DEFECT, WHETHER ARISING OUT OF BREACH OF CONTRACT, TORT (INCLUDING, WITHOUT LIMITATION, NEGLIGENCE), STRICT LIABILITY, INDEMNITY, CONTRIBUTION OR OTHERWISE.**

## **CUSTOMER SERVICE DESCRIPTION**

In order to maintain safe and trouble-free operation of the Product and to prevent the incurrence of unnecessary costs and expenses, Advantest recommends a regular preventive maintenance program under its maintenance agreement.

Advantest's maintenance agreement provides the Purchaser on-site and off-site maintenance, parts, maintenance machinery, regular inspections, and telephone support and will last a maximum of ten years from the date the delivery of the Product. For specific details of the services provided under the maintenance agreement, please contact the nearest Advantest office listed at the end of this Operation Manual or Advantest's sales representatives.

Some of the components and parts of this Product have a limited operating life (such as, electrical and mechanical parts, fan motors, unit power supply, etc.). Accordingly, these components and parts will have to be replaced on a periodic basis. If the operating life of a component or part has expired and such component or part has not been replaced, there is a possibility that the Product will not perform properly. Additionally, if the operating life of a component or part has expired and continued use of such component or part damages the Product, the Product may not be repairable. Please contact the nearest Advantest office listed at the end of this Operation Manual or Advantest's sales representatives to determine the operating life of a specific component or part, as the operating life may vary depending on various factors such as operating condition and usage environment.

## SALES & SUPPORT OFFICES

Advantest Korea Co., Ltd.

22BF, Kyobo KangNam Tower,  
1303-22, Seocho-Dong, Seocho-Ku, Seoul #137-070, Korea  
Phone: +82-2-532-7071  
Fax: +82-2-532-7132

Advantest (Suzhou) Co., Ltd.

Shanghai Branch Office:  
Bldg. 6D, NO.1188 Gumei Road, Shanghai, China 201102 P.R.C.  
Phone: +86-21-6485-2725  
Fax: +86-21-6485-2726

Shanghai Branch Office:  
406/F, Ying Building, Quantum Plaza, No. 23 Zhi Chun Road,  
Hai Dian District, Beijing,  
China 100083  
Phone: +86-10-8235-3377  
Fax: +86-10-8235-6717

Advantest (Singapore) Pte. Ltd.

438A Alexandra Road, #08-03/06  
Alexandra Technopark Singapore 119967  
Phone: +65-6274-3100  
Fax: +65-6274-4055

Advantest America, Inc.

3201 Scott Boulevard, Suite, Santa Clara, CA 95054, U.S.A  
Phone: +1-408-988-7700  
Fax: +1-408-987-0691

ROHDE & SCHWARZ Europe GmbH

Mühldorfstraße 15 D-81671 München, Germany  
(P.O.B. 80 14 60 D-81614 München, Germany)  
Phone: +49-89-4129-13711  
Fax: +49-89-4129-13723

**ADVANTEST®**

<http://www.advantest.co.jp>