ADVANTEST®

ADVANTEST CORPORATION

R3267 Series OPT65
cdma2000 Measurement Option
Operation Manual

MANUAL NUMBER FOE-8350461D00

Applicable models

R3264

R3267

R3273

Safety Summary

To ensure thorough understanding of all functions and to ensure efficient use of this instrument, please read the manual carefully before using. Note that Advantest bears absolutely no responsibility for the result of operations caused due to incorrect or inappropriate use of this instrument.

If the equipment is used in a manner not specified by Advantest, the protection provided by the equipment may be impaired.

- **Warning Labels**

Warning labels are applied to Advantest products in locations where specific dangers exist. Pay careful attention to these labels during handling. Do not remove or tear these labels. If you have any questions regarding warning labels, please ask your nearest Advantest dealer. Our address and phone number are listed at the end of this manual.

Symbols of those warning labels are shown below together with their meaning.

DANGER: Indicates an imminently hazardous situation which will result in death or serious personal injury.

WARNING: Indicates a potentially hazardous situation which will result in death or serious personal injury.

CAUTION: Indicates a potentially hazardous situation which will result in personal injury or a damage to property including the product.

- **Basic Precautions**

Please observe the following precautions to prevent fire, burn, electric shock, and personal injury.

- Use a power cable rated for the voltage in question. Be sure however to use a power cable conforming to safety standards of your nation when using a product overseas.
- When inserting the plug into the electrical outlet, first turn the power switch OFF and then insert the plug as far as it will go.
- When removing the plug from the electrical outlet, first turn the power switch OFF and then pull it out by gripping the plug. Do not pull on the power cable itself. Make sure your hands are dry at this time.
- Before turning on the power, be sure to check that the supply voltage matches the voltage requirements of the instrument.
- Connect the power cable to a power outlet that is connected to a protected ground terminal. Grounding will be defeated if you use an extension cord which does not include a protected ground terminal.
- Be sure to use fuses rated for the voltage in question.
- Do not use this instrument with the case open.
- Do not place anything on the product and do not apply excessive pressure to the product. Also, do not place flower pots or other containers containing liquid such as chemicals near this

product.

- When the product has ventilation outlets, do not stick or drop metal or easily flammable objects into the ventilation outlets.
- When using the product on a cart, fix it with belts to avoid its drop.
- When connecting the product to peripheral equipment, turn the power off.

- **Caution Symbols Used Within this Manual**

Symbols indicating items requiring caution which are used in this manual are shown below together with their meaning.

DANGER: Indicates an item where there is a danger of serious personal injury (death or serious injury).

WARNING: Indicates an item relating to personal safety or health.

CAUTION: Indicates an item relating to possible damage to the product or instrument or relating to a restriction on operation.

- **Safety Marks on the Product**

The following safety marks can be found on Advantest products.



: ATTENTION - Refer to manual.



: Protective ground (earth) terminal.



: DANGER - High voltage.



: CAUTION - Risk of electric shock.

- **Replacing Parts with Limited Life**

The following parts used in the instrument are main parts with limited life.

Replace the parts listed below before their expected lifespan has expired to maintain the performance and function of the instrument.

Note that the estimated lifespan for the parts listed below may be shortened by factors such as the environment where the instrument is stored or used, and how often the instrument is used.

The parts inside are not user-replaceable. For a part replacement, please contact the Advantest sales office for servicing.

Each product may use parts with limited life.

For more information, refer to the section in this document where the parts with limited life are described.

Main Parts with Limited Life

Part name	Life
Unit power supply	5 years
Fan motor	5 years
Electrolytic capacitor	5 years
LCD display	6 years
LCD backlight	2.5 years
Floppy disk drive	5 years
Memory backup battery	5 years

- **Hard Disk Mounted Products**

The operational warnings are listed below.

- Do not move, shock and vibrate the product while the power is turned on.
Reading or writing data in the hard disk unit is performed with the memory disk turning at a high speed. It is a very delicate process.
- Store and operate the products under the following environmental conditions.
An area with no sudden temperature changes.
An area away from shock or vibrations.
An area free from moisture, dirt, or dust.
An area away from magnets or an instrument which generates a magnetic field.
- Make back-ups of important data.
The data stored in the disk may become damaged if the product is mishandled. The hard disc has a limited life span which depends on the operational conditions. Note that there is no guarantee for any loss of data.

- **Precautions when Disposing of this Instrument**

When disposing of harmful substances, be sure dispose of them properly with abiding by the state-provided law.

Harmful substances: (1) PCB (polycarbon biphenyl)
(2) Mercury
(3) Ni-Cd (nickel cadmium)
(4) Other
Items possessing cyan, organic phosphorous and hexadic chromium and items which may leak cadmium or arsenic (excluding lead in solder).

Example: fluorescent tubes, batteries

Environmental Conditions

This instrument should be only be used in an area which satisfies the following conditions:

- An area free from corrosive gas
- An area away from direct sunlight
- A dust-free area
- An area free from vibrations
- Altitude of up to 2000 m

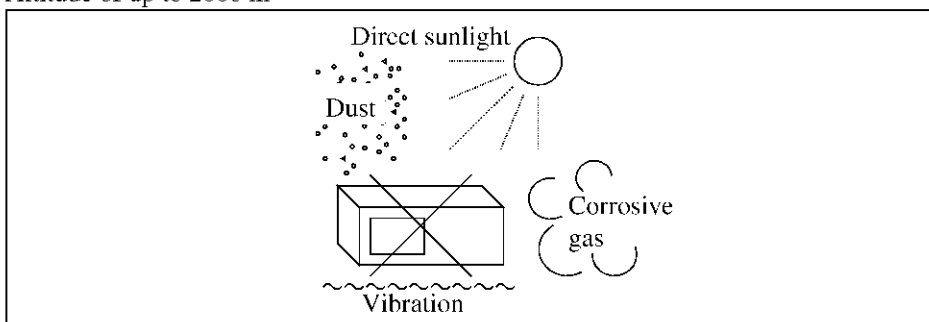

Figure-1 Environmental Conditions

- Operating position

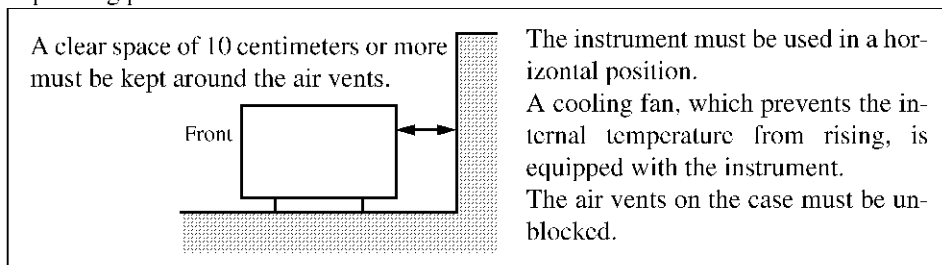

Figure-2 Operating Position

- Storage position

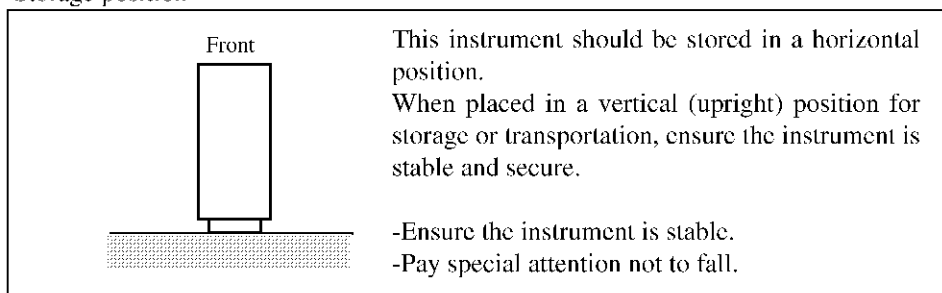

Figure-3 Storage Position

- The classification of the transient over-voltage, which exists typically in the main power supply, and the pollution degree is defined by IEC61010-1 and described below.

Impulse withstand voltage (over-voltage) category II defined by IEC60364-4-443

Pollution Degree 2

Types of Power Cable

Replace any references to the power cable type, according to the following table, with the appropriate power cable type for your country.

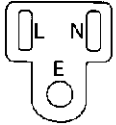
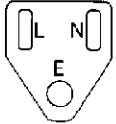
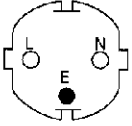
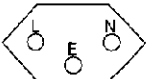
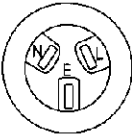
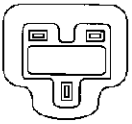
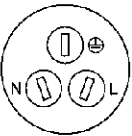
Plug configuration	Standards	Rating, color and length	Model number (Option number)
	PSE: Japan Electrical Appliance and Material Safety Law	125 V at 7 A Black 2 m (6 ft)	Straight: A01402 Angled: A01412
	UL: United States of America CSA: Canada	125 V at 7 A Black 2 m (6 ft)	Straight: A01403 (Option 95) Angled: A01413
	CEE: Europe DEMKO: Denmark NEMKO: Norway VDE: Germany KEMA: The Netherlands CEBEC: Belgium OVE: Austria FIMKO: Finland SEMKO: Sweden	250 V at 6 A Gray 2 m (6 ft)	Straight: A01404 (Option 96) Angled: A01414
	SEV: Switzerland	250 V at 6 A Gray 2 m (6 ft)	Straight: A01405 (Option 97) Angled: A01415
	SAA: Australia, New Zealand	250 V at 6 A Gray 2 m (6 ft)	Straight: A01406 (Option 98) Angled: -----
	BS: United Kingdom	250 V at 6 A Black 2 m (6 ft)	Straight: A01407 (Option 99) Angled: A01417
	CCC: China	250 V at 10 A Black 2 m (6 ft)	Straight: A114009 (Option 94) Angled: A114109

PREFACE

This manual provides the information necessary to check functionality, operate and program the R3267 Series Option 65, cdma2000 measurement.

(1) Organization of this manual

This manual consists of the following chapters:

Safety Summary	To use the analyzer safely, be sure to read this manual first.
1. INTRODUCTION <ul style="list-style-type: none"> • Product Overview • Accessories • Self Test Function • About Calibration • Explanation of the Connectors 	Includes a description of the option and its accessories and a self test error messages.
2. MEASUREMENT EXAMPLES <ul style="list-style-type: none"> • Measuring the Code Domain Power of Base Station Signals • Mobile station (MS) Code Domain Power Measurement • CCDF Measurement 	You can learn the basic operations of the option through the examples shown in this chapter.
3. REFERENCE <ul style="list-style-type: none"> • Menu Index • Menu Map • Functional Description 	Shows a list of operation keys, and describes the function of each key.
4. REMOTE CONTROL <ul style="list-style-type: none"> • GPIB Command Index • GPIB Command Codes 	Included are a list of commands necessary for programming.
5. TECHNICAL INFORMATION <ul style="list-style-type: none"> • Template Edit Function • Measurement Parameter Settings in Due to Transient, Due to Modulation and Inband Spurious • Estimated p in the Code Domain Power Measurement • Peak Factor of Tx Power • Trigger Source INTRVL (EXT) and INTRVL • About Bit Reversal (Paley) Order • About Complementary Filter • About Equalizing Filter • Null Offset Graph • Block Diagram 	Describes the principle of operation necessary for taking measurements more accurately.
6. PERFORMANCE VERIFICATION TEST <ul style="list-style-type: none"> • General • Performance Verification Test Procedure • Performance Verification Test Record Sheet 	Describes how to test performance.

7. SPECIFICATIONS	Shows the specifications of the option.
APPENDIX <ul style="list-style-type: none"> • Messages 	If an error occurs during operation, an error number and its corresponding error message are displayed. The meaning of each error is explained in this section.

(2) Typeface conventions used in this manual

- Panel keys and soft keys are printed in a contrasting typeface to make them stand out from the text as follows:

Panel keys: Boldface type

Example: **TRANSIENT**

Soft keys: Boldface and italic type

Example: ***T-Domain, Detector***

- When a series of key operations are described using a comma between two keys.
- There are various soft menus used to switch between two states such as ON/OFF and AUTO/MNL. For example, when turning off the ***Window ON/OFF*** function, the annotation “***Window ON/OFF(OFF)***” is used.

TABLE OF CONTENTS

1	INTRODUCTION.....	1-1
1.1	Product Overview	1-1
1.2	Accessories	1-1
1.3	Self Test Function.....	1-1
1.4	About Calibration	1-1
1.5	Explanation of the Connectors	1-1
2	MEASUREMENT EXAMPLES	2-1
2.1	Measuring the Code Domain Power of Base Station Signals	2-1
2.2	Mobile Station (MS) Code Domain Power Measurement	2-9
2.3	CCDF Measurement	2-18
3	REFERENCE	3-1
3.1	Menu Index.....	3-1
3.2	Menu Map	3-6
3.3	Functional Description	3-23
3.3.1	Switching Communication Systems	3-24
3.3.2	T-Domain	3-25
3.3.2.1	Power (T-Domain)	3-25
3.3.2.2	ON/OFF Ratio.....	3-28
3.3.2.3	Spurious (T-Domain)	3-31
3.3.3	F-Domain	3-33
3.3.3.1	Power (F-Domain)	3-33
3.3.3.2	OBW	3-37
3.3.3.3	Due to Transient.....	3-38
3.3.3.4	Due to Modulation	3-41
3.3.3.5	Inband Spurious(1)	3-45
3.3.3.6	Inband Spurious(2)	3-48
3.3.3.7	Outband Spurious	3-51
3.3.4	Modulation	3-53
3.3.4.1	Code Domain Power Coef (when FORWARD is set).....	3-53
3.3.4.2	Code Domain Power (when REVERSE (RC 3 & 4) is set).....	3-63
3.3.4.3	Waveform Quality (when REVERSE (RC1&2) is set)	3-70
3.3.4.4	Power	3-73
3.3.4.4.1	Tx Power	3-73
3.3.4.4.2	CCDF	3-74
3.3.4.5	Time & FFT	3-75
3.3.4.6	STD	3-76
4	REMOTE CONTROL	4-1
4.1	GPIO Command Index	4-1

Table of Contents

4.2	GPIB Command Codes	4-11
5	TECHNICAL INFORMATION.....	5-1
5.1	Template Edit Function	5-1
5.1.1	Template Setting in the T-Domain Measuring Mode	5-1
5.1.2	Template Setting in the F-Domain Measuring Mode	5-3
5.2	Measurement Parameter Settings in Due to Transient, Due to Modulation and Inband Spurious.....	5-4
5.2.1	Marker Edit Function.....	5-4
5.2.2	Measurement results Using Due to Modulation, Due to Transient and Inband Spurious Modes.....	5-5
5.2.3	Measurement Result of Inband Spurious.....	5-6
5.3	Estimated ρ in the Code Domain Power Measurement	5-7
5.4	Peak Factor of Tx Power	5-7
5.5	Trigger Source INTRVL (EXT) and INTRVL	5-8
5.6	About Bit Reversal (Paley) Order	5-9
5.7	About Complementary Filter.....	5-14
5.8	About Equalizing Filter	5-15
5.9	Null Offset Graph	5-16
5.10	Block Diagram.....	5-17
6	PERFORMANCE VERIFICATION TEST	6-1
6.1	General	6-1
6.1.1	Introduction.....	6-1
6.1.2	Test Equipment.....	6-1
6.1.3	Specifications Required for Test Signals.....	6-3
6.1.4	Calibration Cycle	6-4
6.1.5	Performance Verification Test Record Sheet	6-4
6.1.6	Performance Verification Procedure	6-4
6.2	Performance Verification Test Procedure	6-5
6.2.1	Code Domain Power Accuracy (FORWARD Link)	6-5
6.2.2	Code Domain Power Accuracy (if REVERSE(RC3&4) is set)	6-7
6.3	Performance Verification Test Record Sheet.....	6-9
7	SPECIFICATIONS.....	7-1
	APPENDIX	A-1
A.1	Messages.....	A-1
	ALPHABETICAL INDEX	I-1

LIST OF ILLUSTRATIONS

No.	Title	Page
2-1	Setup for Base Station Code Domain Power Measurements	2-1
2-2	STD-Measurement parameter set Dialog Box	2-2
2-3	Parameter Setup Dialog Box	2-3
2-4	Meas Options Dialog Box	2-4
2-5	Measurement Results of the cdma 2000 Base Station Signal	2-5
2-6	Scale Setup Example	2-6
2-7	Graph Display Example of the Code Domain Power Coefficient	2-7
2-8	Setup for the MS (Mobile Station) Code Domain Power Measurement	2-9
2-9	STD Measurement Parameter Set Dialog Box	2-10
2-10	Parameter Setup Dialog Box	2-10
2-11	Channel Setup Dialog Box	2-11
2-12	View Setup Dialog box	2-12
2-13	Measurement Result for REVERSE LINK (in CHANNEL Mode)	2-13
2-14	Parameter Setup Dialog Box (Showing PN Delay Search Mode is OFF)	2-14
2-15	View Setup Dialog Box	2-15
2-16	EVM for the FCH	2-15
2-17	DEMOD for the FCH	2-16
2-18	Measurement Result for REVERSE LINK (in WALSH Mode)	2-17
2-19	Setup for CCDF Measurement	2-18
2-20	Spectrum of the Mobile Station Signal	2-19
2-21	CCDF Parameter Setup Dialog Box	2-19
2-22	CCDF Measurement Result	2-20
2-23	CCDF Measurement Result (Trace Write ON)	2-21
3-1	Communication Systems Dialog Box	3-24
3-2	Trigger Setup Dialog Box	3-25
3-3	Parameter Setup Dialog Box	3-27
3-4	Trigger Setup Dialog Box	3-28
3-5	Parameter Setup Dialog Box	3-30
3-6	Trigger Setup Dialog Box	3-31
3-7	Parameter Setup Dialog Box	3-32
3-8	Trigger Setup Dialog Box	3-34
3-9	Detector Dialog Box	3-35
3-10	Parameter Setup Dialog Box	3-36
3-11	Parameter Setup Dialog Box	3-37
3-12	Parameter Setup Dialog Box	3-39
3-13	Trigger Setup Dialog Box	3-41
3-14	Detector Dialog Box	3-42
3-15	Parameter Setup Dialog Box	3-44
3-16	Parameter Setup Dialog Box	3-47
3-17	Parameter Setup Dialog Box	3-50
3-18	Parameter Setup Dialog Box	3-52
3-19	Graph Type of Analysis Dialog Box	3-54
3-20	Scale Setup Dialog Box	3-55
3-21	DUAL Display Example	3-55
3-22	Setup Example for the Parameter Setup	3-57

List of Illustrations

No.	Title	Page
3-23	Setup Example for the Channel Def. Table	3-59
3-24	Meas Options Setup Example	3-61
3-25	Measurement Example for the Code Domain Error	3-62
3-26	Graphic Type of Analysis Dialog Box	3-63
3-27	View Setup Dialog Box	3-64
3-28	Channel Setup Dialog Box	3-66
3-29	Parameter Setup Dialog Box	3-68
3-30	Graphic Type of Analysis Dialog Box	3-70
3-31	Parameter Setup Dialog Box	3-72
3-32	Parameter Setup Dialog Box	3-73
3-33	Scale Setup Dialog Box	3-74
3-34	Parameter Setup Dialog Box	3-75
3-35	Select Type Dialog Box	3-75
3-36	Parameter Setup Dialog Box	3-76
3-37	STD Measurement parameter Setup Dialog Box	3-77
5-1	Template to Be Set	5-1
5-2	Template Settings	5-2
5-3	Template Shifted Using the Shift Y Function	5-2
5-4	Template with the Set Values	5-3
5-5	Template with Margin Delta X	5-3
5-6	Example of Marker Edit Setting (1)	5-4
5-7	Example of Marker Edit Setting (2)	5-5
5-8	Example of Peak Marker Y Delta	5-5
5-9	Reverse Link Constellation	5-16
5-10	Null Offset Constellation	5-16
5-11	Block Diagram	5-17
6-1	Timing Chart of Trigger signal and Mobile Station Signal (Not Scaled)	6-4
6-2	Setup of Code Domain Power Accuracy Measurement (FORWARD Link)	6-5
6-3	Setting of Measurement Parameters for Code Domain Power (FORWARD Link)	6-6
6-4	Setting of Measurement Options for Code Domain Power (FORWARD Link)	6-6
6-5	Setup of Code Domain Power Accuracy Measurement (REVERSE Link)	6-7
6-6	Displaying the Channel Setup for Code Domain Power (REVERSE Link)	6-8
6-7	Setting of Measurement Parameters for Code Domain Power (REVERSE Link)	6-8

LIST OF TABLES

No.	Title	Page
4-1	Operating Mode	4-11
4-2	ATT Key (Attenuator)	4-11
4-3	COPY Key (Hard copy)	4-11
4-4	COUPLE Key (Couple function)	4-12
4-5	FREQ Key (Frequency)	4-12
4-6	LEVEL Key (Reference Level)	4-12
4-7	MKR Key (Marker)	4-13
4-8	PRESET Key (Initialization)	4-13
4-9	RCL Key (Recall)	4-13
4-10	SAVE Key (Save)	4-14
4-11	SPAN Key (Frequency span)	4-14
4-12	TRANSIENT Key	4-15
4-13	Numeric Keys/Step Keys/Data Knob/Unit Keys (Entering Data)	4-57
4-14	Miscellaneous	4-58
6-1	Performance Verification Items	6-1
6-2	Equipment List	6-2
6-3	Specifications Required for Test Signals	6-3

1 INTRODUCTION

1.1 Product Overview

The cdma 2000 modulation analysis option (OPT 65) software allows you to measure and evaluate the modulation accuracy specified by IS-2000.

This option is a factory option which is incorporated into the R3267 Series Spectrum Analyzer prior to shipment.

This option includes the following features:

- Measures the modulation accuracy, frequency error, code domain power and so on.
- Can be used to measure OBW or ACP due to Transient specified by the communication standard with a simple key operation.

1.2 Accessories

Name of accessories	Type of name	Quantity	Remarks
R3267 Series option 65 Operation manual	ER3267/73OPT65	1	English

1.3 Self Test Function

The self test also checks the Option 65 for correct operation when the spectrum analyzer power is turned on. The message shown below will be displayed when an error related to Option 65 occurs. Contact ADVANTEST Corp. for repair.

Error Message
Handshake error occurred to DSP

1.4 About Calibration

When you want to calibrate the R3267 Series, please contact a sales representative.

Desirable Period	1 year
------------------	--------

1.5 Explanation of the Connectors

Connectors used for this option are described as follows:

1. EXT TRIG terminal Connector for inputting the external trigger signal.

2 MEASUREMENT EXAMPLES

This chapter describes how to use this option using practical measurement examples.

2.1 Measuring the Code Domain Power of Base Station Signals

This section provides measurement examples for the code domain coefficient in FORWARD Link when it is used to analyze the base station signal

Measurement conditions:

Measured signals have an output signal with a frequency of 870.03 MHz and a level of -10 dBm based on “Base Station Test Model, Nominal” in IS-97

It is assumed that the Even Second clock, 10 MHz reference signal and measurement signals are output.

Signal specifications:

RC is 1, QOF is 0, Walsh Length is 64 and PN Offset is 0.

Channel	Walsh number
Pilot	0
Paging	1
Traffic	6
Traffic	17
Traffic	20
Sync	32
Traffic	41
Traffic	49
Traffic	58

Connecting the equipment

1. Connect the equipment as shown in Figure 2-1.

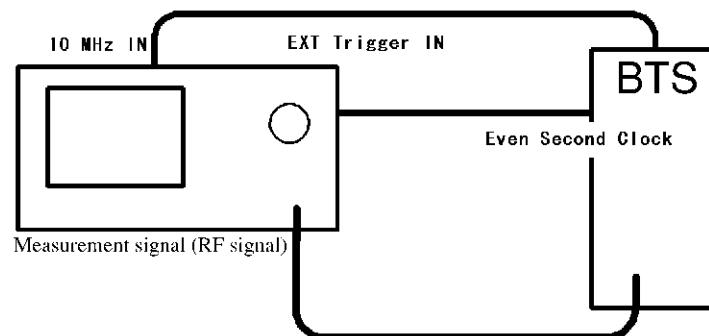

Figure 2-1 Setup for Base Station Code Domain Power Measurements

2.1 Measuring the Code Domain Power of Base Station Signals

Setting the measurement conditions

This changes the analyzer setting so that the input signal displayed more clearly.

2. Press **FREQ, 8, 7, 0, ., 0, 3** and **MHz**.
3. Press **SPAN, 8** and **MHz**.
4. Press **LEVEL, 0** and **GHz(+dBm)**.
5. Press **TRANSIENT, STD** and **STD Setup**.
The STD Measurement Parameter Set dialog box is displayed.

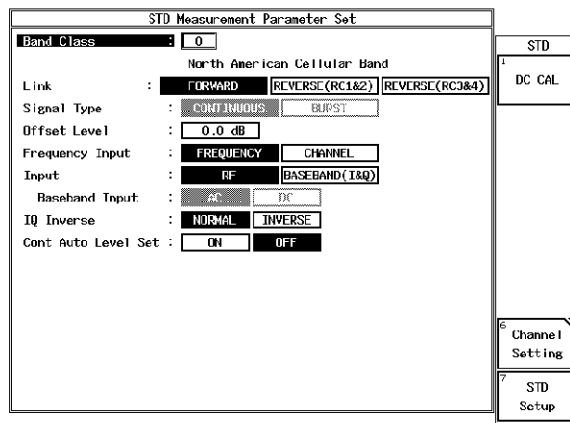

Figure 2-2 STD-Measurement parameter set Dialog Box

6. Press the ∇ key.
The cursor moves to the item Link.
7. Select **FORWARD** from **Link** using the data knob, and press the data knob (or **ENTR**).
The measurement mode is set to the BS measurement.

The following parameters are default settings.

Offset Level:	0.0 dB
Frequency Input:	FREQUENCY
Input:	RF
IQ Inverse:	NORMAL
Cont Auto Level Set:	OFF

8. Press **RETURN**, **Modulation**, **Code Domain Power Coef** and **Parameter Setup**. The Parameter Setup dialog box is displayed.

Parameter Setup	
Meas Range	1280 chip
τ Offset	0.000 μ s
Complementary Filter	ON OFF
Rolloff Factor	0.05
Equalizing Filter	ON OFF
PN Offset Search Mode	ON OFF
PN Offset	0
Carrier Freq. Search	500Hz 10kHz 500kHz
Trigger Source	INTL EXT INTRVL (EXT) INTRVL
EXT Trigger Slope	+ -
Threshold	-77 dB
Auto Rate	ON OFF
Channel Define	ON OFF
Walsh Code Length	4 8 16 32 64 128
DOF	0 1 2 3
Bit Reversal Order	ON OFF

Power Coef
Auto Level Set
Graphics
Scale Setup
Parameter Setup
Channel Def. Table
Meas Options

Figure 2-3 Parameter Setup Dialog Box

9. Press **1, 2, 8, 0** and **Hz(ENTR)** to set **Meas Range**. The measurement range is set to 1280 chips.
10. Press **0** and **Hz (ENTR)** to set **τ Offset**. The measurement start position is set at a position delayed by 0.0 μ s from the trigger.
11. Select **ON** from **Complimentary Filter** using the data knob, and press the data knob (or **ENTR**). The receiving filter is set to the complimentary filter.
12. Press **0, ., 0, 5** and **Hz (ENTR)** to set **Rolloff Factor**. The roll-off factor (after passing through the complimentary filter) is set to 0.05.
13. Select **ON** from **Equalizing Filter** using the data knob, and press the data knob (or **ENTR**). The phase characteristics of the complimentary filter are set to the inverse characteristics of the phase equalizer.
14. Select **OFF** from **PN Offset Search Mode** using the data knob, and press the data knob (or **ENTR**). The PN offset search mode is set to OFF.
15. Press **0** and **Hz (ENTR)** to set **PN Offset**. The PN offset is set to 0.
16. Select **10 kHz** from **Carrier Freq. Search** using the data knob, and press the data knob (or **ENTR**). The carrier frequency search range is set to ± 10 kHz.
17. Select **EXT** from **Trigger Source** using the data knob, and press the data knob (or **ENTR**). The trigger is set to the external trigger.

2.1 Measuring the Code Domain Power of Base Station Signals

18. Select + from *EXT Trigger Slope* to + using the data knob, and press the data knob (or **ENTR**).
19. Press -, 2, 7 and **Hz (ENTR)** to set *Threshold*.
20. Select *OFF* from *Auto Rate* using the data knob, and press the data knob (or **ENTR**).
21. Select *OFF* from *Channel Define* using the data knob, and press the data knob (or **ENTR**).
22. Select *64* from *Walsh Code Length* using the data knob, and press the data knob (or **ENTR**).
23. Select *0* from *QOF* using the data knob, and press the data knob (or **ENTR**).
24. Select *OFF* from *Bit Reversal Order* to OFF using the data knob, and press the data knob (or **ENTR**).
25. Press *Parameter Setup*.
The dialog box is closed.
26. Press *Meas Options*.
The Meas Options dialog box is displayed.

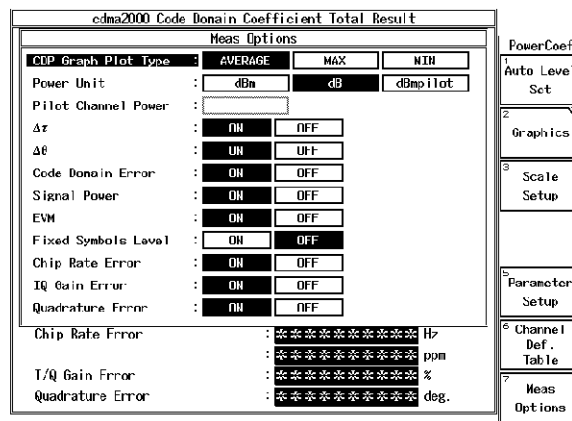

Figure 2-4 Meas Options Dialog Box

27. Use the data knob to set *CDP Graph Plot Type* to *AVERAGE*, then press Hz (**ENTR**).
The Power values of each channel are set to the mean values of each symbol.
28. Select *dB* from *Power Unit* using the data knob, and press the data knob (or **ENTR**).
29. Select *ON* from $\Delta\tau$ using the data knob, and press the data knob (or **ENTR**).
30. Select *ON* from $\Delta\theta$ using the data knob, and press the data knob (or **ENTR**).

2.1 Measuring the Code Domain Power of Base Station Signals

31. Select **ON** from **Code Domain Error** using the data knob, and press the data knob (or **ENTR**).
32. Select **ON** from **Signal Power** using the data knob, and press the data knob (or **ENTR**).
33. Select **ON** from **EVM** using the data knob, and press the data knob (or **ENTR**).
34. Select **OFF** from **Fixed Symbols Level** using the data knob, and press the data knob (or **ENTR**).
35. Select **ON** from **Chip Rate Error** using the data knob, and press the data knob (or **ENTR**).
36. Select **ON** from **IQ Gain Error** using the data knob, and press the data knob (or **ENTR**).
37. Select **ON** from **Quadrature Error** using the data knob, and press the data knob (or **ENTR**).
38. Press **Meas Options**.
The dialog box is closed.
39. Press **Auto Level Set**.
The measurement range is set to the optimum range.
40. Press **SINGLE**.
The sweep is set to a single mode and starts.

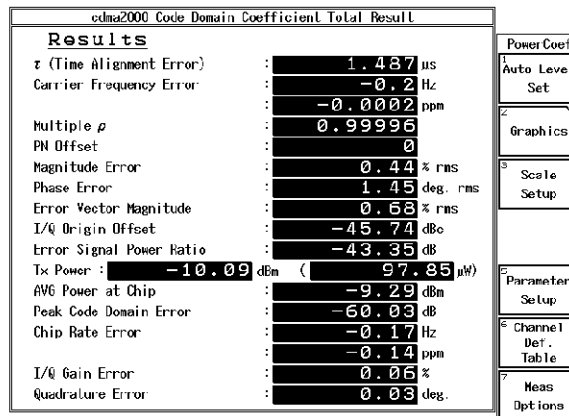

Figure 2-5 Measurement Results of the cdma 2000 Base Station Signal

τ (Time Alignment Error): Time delay (μ s) for the trigger
 Carrier Frequency Error: Carrier frequency error (Hz, ppm) for the center frequency

2.1 Measuring the Code Domain Power of Base Station Signals

Multiple ρ :	Waveform quality of the multiplexed signal (The waveform quality factor value must be compliant with the cdma2000 standard when measuring signals from the Pilot channel.)
PN Offset:	PN offset of the base station signal
Magnitude Error:	Magnitude error (% rms) of the multiplexed signal
Phase Error:	Phase error (degree rms) of the multiplexed signal
Error Vector Magnitude:	Modulation accuracy (% rms) of the multiplexed signal
I/Q Origin Offset:	Offset (dBc) of the I/Q origin
Error Signal Power Ratio:	The ratio (dB) of the error signal power to the power of the multiplexed signal at the chip judgement point
Tx Power:	Power (dBm) of the multiplexed signal before passing through the complimentary filter
AVG Power at Chip:	Power (dBm) of the multiplexed signal at the chip judgement point after passing through the complimentary filter
Peak Code Domain Error:	Maximum value (dB) of the code domain errors
Chip Rate Error:	Chip rate error (Hz and ppm) relative to 1.2288 Mcps
IQ Gain Error:	Q-axis gain error relative to the I-axis gain (%)
Quadrature Error:	Q-axis quadrature error relative to the I-axis (degree)

Displaying the graph

41. Press **Scale Setup**.
The Scale Setup dialog box is displayed.

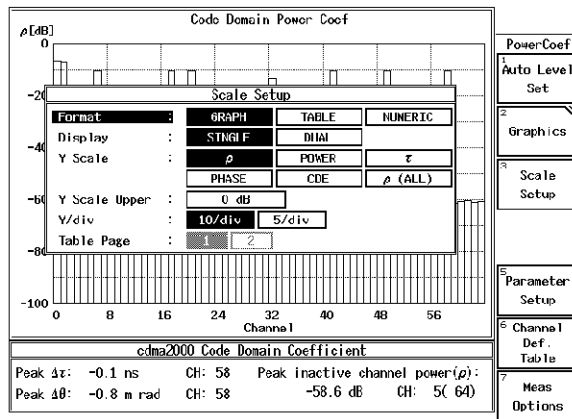

Figure 2-6 Scale Setup Example

2.1 Measuring the Code Domain Power of Base Station Signals

42. Select **GRAPH** from **Format** using the data knob, and press the data knob (or **ENTR**).
43. Select **SINGLE** from **Display** using the data knob, and press the data knob (or **ENTR**).
44. Select ρ from **Y Scale** using the data knob, and press the data knob (or **ENTR**).
45. Press **0** and **GHz (dB)** to set **Y Scale Upper**.
46. Select **10/div** from **Y/div** using the data knob, and press the data knob (or **ENTR**).
47. Press **Scale Setup**.
The dialog box is closed.
48. Press **MKR**.
The marker is displayed.
49. Select **2** from **MKR POSI**, using the data knob.
The marker switches between the active channels only.

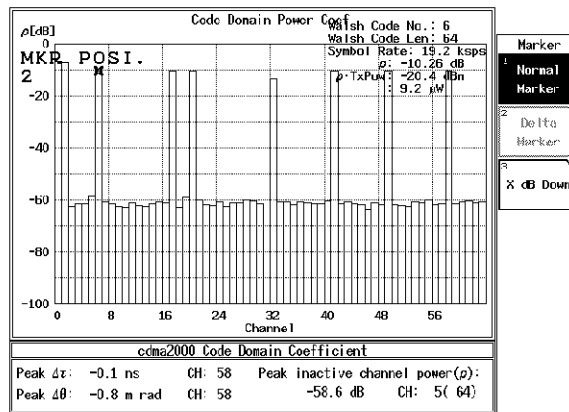

Figure 2-7 Graph Display Example of the Code Domain Power Coefficient

Walsh Code No.:	Walsh code number of the channel specified by the marker
Walsh Code Len:	Walsh code length (number of chips) of the channel specified by the marker
ρ :	Logarithmic value of the channel code domain power coefficient specified by the marker (dB)
Peak Δt CH:	Maximum value of the relative Walsh code domain time offset to the Pilot channel and its channel Walsh code number
Peak $\Delta \theta$ CH:	Maximum value of the relative Walsh code domain phase offset to the Pilot channel and its channel Walsh code number

2.1 Measuring the Code Domain Power of Base Station Signals

Peak inactive channel power (ρ) CH:
This indicates the maximum logarithmic value of the code domain power coefficient for the inactive channel, Walsh code number, and Walsh length for the channel.

2.2 Mobile Station (MS) Code Domain Power Measurement

Measurement conditions:

The measurement signal is output from an IS-2000-compliant unit and has a frequency of 825.03 MHz and a level of -10 dBm.

Signal specifications are as follows:

Long Code Mask: ALL 0

Reverse Traffic Channel Operation signal (which is multiplexed with the PICH, DCCH, SCH2, FCH and SCH1)

SCH1 Walsh function: W_1^2 (M=1)

SCH2 Walsh function: W_2^4 (M=1)

The abbreviations listed above have the following meanings:

PICH:	Reverse Pilot Channel
DCCH:	Reverse Dedicated Control Channel
SCH2:	Reverse Supplemental Channel 2
FCH:	Reverse Fundamental Channel
SCH1:	Reverse Supplemental Channel 1
M:	Walsh Function Repetition Factor

Setup

1. Connect the unit under test as shown in Figure 2-8.

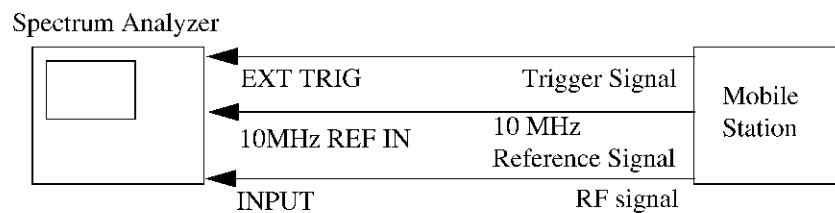

Figure 2-8 Setup for the MS (Mobile Station) Code Domain Power Measurement

Setting the measurement conditions

This sets the measurement frequency to the center frequency of the spectrum analyzer.

2. Press **FREQ, 8, 2, 5, ., 0, 3** and **MHz**.
3. Press **TRANSIENT, STD** and **STD Setup**.
The STD Measurement Parameter Set dialog box is displayed.

2.2 Mobile Station (MS) Code Domain Power Measurement

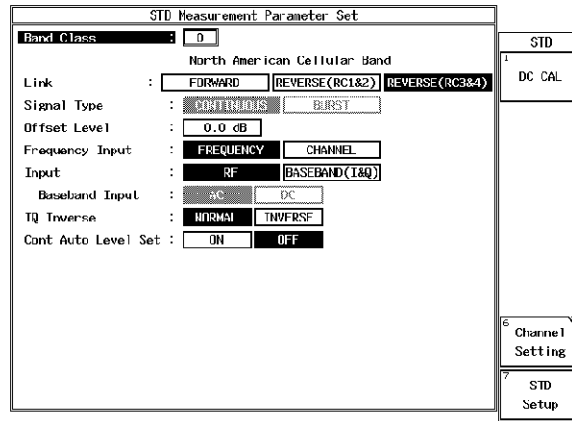

Figure 2-9 STD Measurement Parameter Set Dialog Box

4. Select **0** for *Band Class* using the data knob and press **Hz (ENTR)**.
5. Select **REVERSE (RC3&4)** for *Link* using the data knob and press **Hz (ENTR)**.
6. Press **0, ,, 0** and **GHz(dB)** for *Offset Level*.
7. Select **FREQUENCY** for *Frequency Input* using the data knob and press **Hz (ENTR)**.
8. Select **RF** for *Input* using the data knob and press **Hz (ENTR)**.
9. Select **NORMAL** for *IQ Inverse* using the data knob and press **Hz (ENTR)**.
10. Select **OFF** for *Cont Auto Level Set* using the data knob and press **Hz (ENTR)**.
11. Press **RETURN, Modulation, Code Domain Power** and **Parameter Setup**. The Parameter Setup dialog box is displayed.

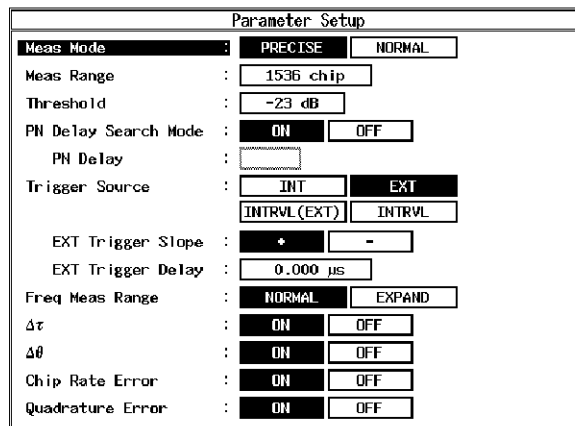

Figure 2-10 Parameter Setup Dialog Box

12. Select **PRECISE** for **Meas Mode** using the data knob and press **Hz (ENTR)**.
13. Select **1536 chip** for **Meas Range** using the data knob and press **Hz (ENTR)**.
14. Press **-, 2, 3** and **GHz (dB)** for **Threshold**.
15. Select **ON** for **PN Delay Search Mode** using the data knob and press **Hz (ENTR)**.
16. Select **EXT** for **Trigger Source** using the data knob and press **Hz (ENTR)**.
17. Select **+** for **EXT Trigger Slope** using the data knob and press **Hz (ENTR)**.
18. Press **0, ,, 0** and **Hz (ENTR)** for **EXT Trigger Delay**.
19. Select **NORMAL** for **Freq Meas Range** using the data knob and press **Hz (ENTR)**.
20. Select **ON** for $\Delta\tau$ using the data knob and press **Hz (ENTR)**.
21. Select **ON** for $\Delta\theta$ using the data knob and press **Hz (ENTR)**.
22. Select **ON** for **Chip Rate Error** using the data knob and press **Hz (ENTR)**.
23. Select **ON** for **Quadrature Error** using the data knob and press **Hz (ENTR)**.
24. Press **Parameter Setup**.
The dialog box is closed.
25. Press **Channel Setup**.
The Channel Setup dialog box is displayed.

Channel Setup			
Operation Mode	TCH	EACH	CCCH
DCCH	ON	OFF	W(8,16)
FCH	ON	OFF	W(4,16)
SCH1 Walsh Function	W(1,2)	W(2,4)	CH OFF
SCH1 Repetition Factor	1	2	4 8 16 32
	614.4 kspcs		
SCH2 Walsh Function	W(2,4)	W(6,8)	CH OFF
SCH2 Repetition Factor	1	2	4 8 16
	307.2 kspcs		
Walsh Code Length	32	64	

Figure 2-11 Channel Setup Dialog Box

26. Select **TCH** for **Operation Mode** using the data knob and press **Hz (ENTR)**.
27. Select **ON** from **DCCH** using the data knob and press **Hz (ENTR)**.
28. Select **ON** from **FCH** using the data knob and press **Hz (ENTR)**.

2.2 Mobile Station (MS) Code Domain Power Measurement

29. Select **W(1, 2)** for **SCH1 Walsh Function** using the data knob and press **Hz (ENTR)**.
30. Select **1** for **SCH1 Repetition Factor** using the data knob and press **Hz (ENTR)**.
31. Select **W(2, 4)** for **SCH2 Walsh Function** using the data knob and press **Hz (ENTR)**.
32. Select **1** for **SCH2 Repetition Factor** using the data knob and press **Hz (ENTR)**.
33. Select **32** from **Walsh Code Length** using the data knob and press **Hz (ENTR)**.
34. Press **Channel Setup**.
The dialog box is closed.

Result display in CHANNEL Mode

35. Press **View Setup**.
The View Setup dialog box is displayed.

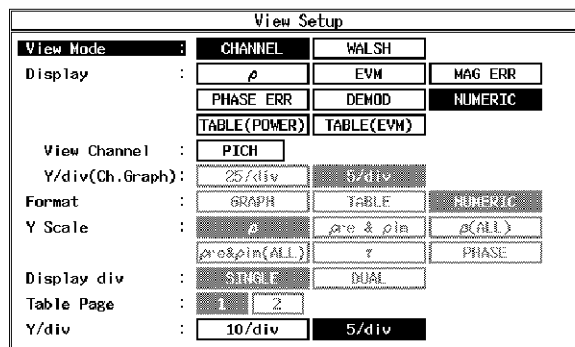
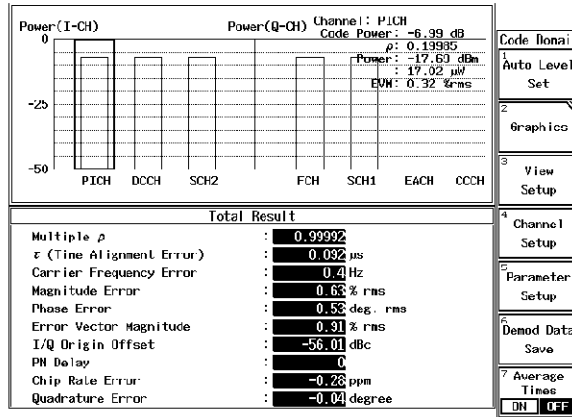

Figure 2-12 View Setup Dialog box

36. Select **CHANNEL** from **View Mode** using the data knob, and press **Hz (ENTR)**.
37. Select **NUMERIC** from **Display** using the data knob, and press **Hz (ENTR)**.
38. Select the desired channel (e.g., **PICH**) from **View Channel** using the data knob, and press **Hz (ENTR)**.
39. Select **5/div** from **Y/div** using the data knob, and press **Hz (ENTR)**.
40. Press **View Setup**.
The dialog box is closed.
41. Press **Auto Level Set**.
The measurement range is optimized.
42. Press **SINGLE**.
The single mode measurement is set and then the measurement results are displayed.



**Figure 2-13 Measurement Result for REVERSE LINK
(in CHANNEL Mode)**

Code Power	Channel power (dB) relative to the total power. (As a result, the total power is treated as 0 dB.)
ρ	Code domain power coefficient which is a ratio between a channel and the total power
Power	Absolute channel power (dBm or W)
EVM	Modulation accuracy per channel (%rms)
Multiple ρ	Waveform quality of the multiplexed signal
τ (Time Alignment Error)	Time delay for the trigger (μ s)
Carrier Frequency Error	(Hz)
Magnitude Error	Magnitude error of the multiplexed signal (%rms)
Phase Error	Phase error of the multiplexed signal (deg. rms)
Error Vector Magnitude	Modulation accuracy of the multiplexed signal (%rms)
I/Q Origin Offset	(dBc)
PN Delay	Synchronization position of pilot PN sequence. This is expressed using a value of 0 to 511.
Chip Rate Error	Chip rate error (ppm) relative to 1.2288 Mcps
Quadrature Error	Q-axis quadrature error relative to the I axis (degree)

2.2 Mobile Station (MS) Code Domain Power Measurement

PN Delay

Since PN Delay Search Mode was set to ON, the PN delay has been measured. The measured PN delay can be used to reduce the measurement time when the PN Delay Search Mode is set to OFF.

Make the note of the measured PN delay so you can use it for the next procedure. In the example shown below, the measured PN delay is 0.

43. Press **Parameter setup**.
The Parameter Setup dialog box is displayed.
44. Press the ∇ key to select **PN Delay Search Mode** with the cursor.
45. Select **OFF** for **PN Delay Search Mode** using the data knob and press **Hz (ENTR)**.
46. Press **0** and **Hz (ENTR)** to set a **PN delay**.

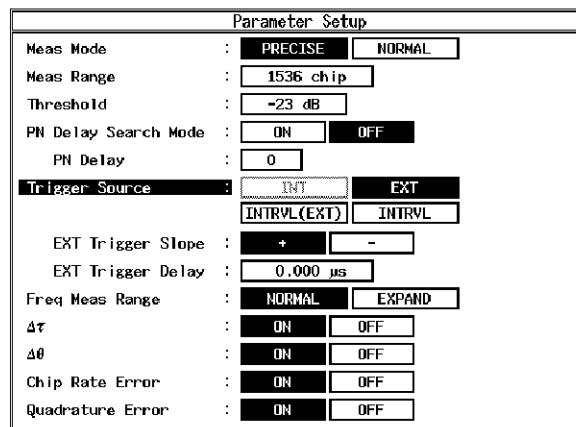

Figure 2-14 Parameter Setup Dialog Box
(Showing PN Delay Search Mode is OFF)

47. Press **Parameter Setup**.
The dialog box is closed.
48. Press **SINGLE**.
The single mode measurement is set and then the measurement results are displayed.

Displaying the EVM for the specified channel

This displays the Error Vector Magnitude vs. symbol graph for the specified channel.

49. Press **View Setup**.
The View Setup dialog box is displayed.

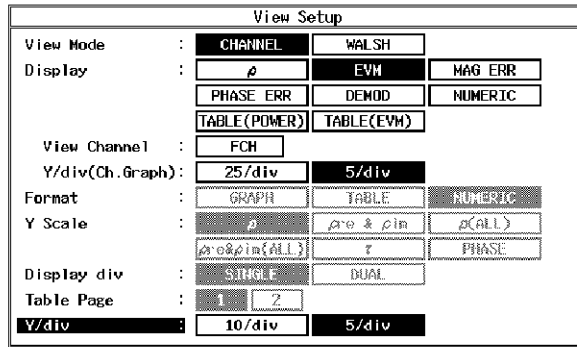

Figure 2-15 View Setup Dialog Box

50. Press the ∇ key to select *Display* with the cursor.
51. Select **EVM** for *Display* using the data knob and press **Hz (ENTR)**.
52. Select the desired channel (e.g., **FCH**) for *View Channel* using the data knob and press **Hz (ENTR)**.
53. Select **5/div** from *Y/div (Ch. Graph)* using the data knob, and press **Hz (ENTR)**.
54. Press *View Setup*.
The dialog box is closed.

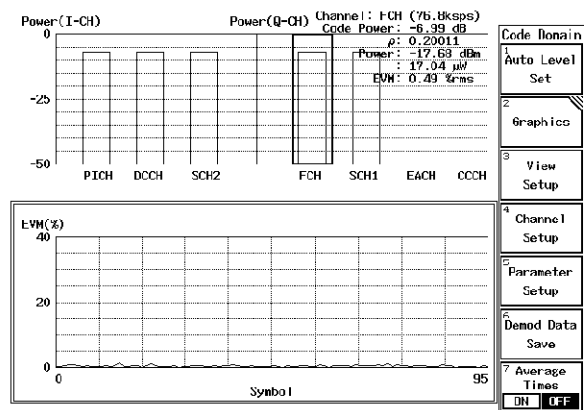

Figure 2-16 EVM for the FCH

Displaying the DEMOD for the specified channel

This displays the demodulated data for the specified channel.

55. Press *View Setup*.
The View Setup dialog box is displayed.
56. Press the ∇ key to select *Display* with the cursor.

2.2 Mobile Station (MS) Code Domain Power Measurement

57. Select **DEMODO** for **Display** using the data knob and press **Hz (ENTR)**.
58. Select a desired channel (e.g., **FCH**) for **View Channel** using the data knob and press **Hz (ENTR)**.
59. Press **View Setup**.
The dialog box is closed.

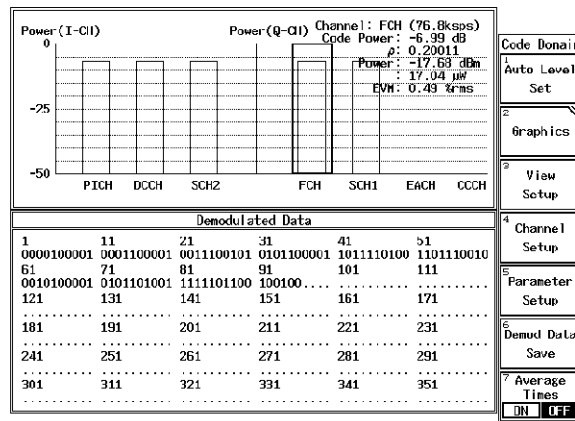
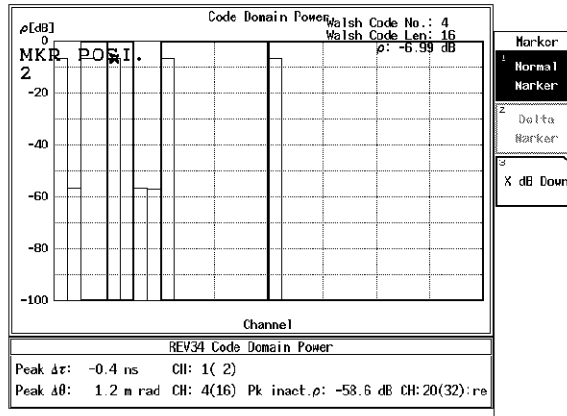

Figure 2-17 DEMOD for the FCH

Result display in WALSH Mode

Measurement result is displayed with the horizontal axis in the Walsh function.

60. Press **View Setup**.
The View Setup dialog box is displayed.
61. Select **WALSH** from **View Mode** using the data knob, and press **Hz (ENTR)**.
62. Select **GRAPH** from **FORMAT** using the data knob, and press **Hz (ENTR)**.
63. Select **p** from **Y Scale** using the data knob, and press **Hz (ENTR)**.
64. Select **SINGLE** from **Display div** using the data knob, and press **Hz (ENTR)**.
65. Select **10/div** from **Y/div** using the data knob, and press **Hz (ENTR)**.
66. Press **View Setup**.
The dialog box is closed.
67. Press **MKR**.
The marker is displayed.
68. Select **2** from **MKR POSI**. using the data knob.
The marker moves between active channels



**Figure 2-18 Measurement Result for REVERSE LINK
(in WALSH Mode)**

Walsh Code No.:		Walsh Code number of the channel specified by the marker
Walsh Code Len:		Walsh Code length of the channel specified by the marker (chips)
ρ :		Logarithmic value of the code domain power coefficient of the channel specified by the marker (dB)
Peak $\Delta\tau$	CH:	The maximum time offset value relative to the pilot channel, and the Walsh code number and length of the channel
Peak $\Delta\theta$	CH:	The maximum phase offset value relative to the pilot channel, and the Walsh code number and length of the channel
Pk inact. ρ	CH:	Displays the maximum power, Walsh code number, Walsh code length and the real and imaginary components for the inactive channel when the real and imaginary components of a code domain power coefficient are measured in log scales.

2.3 CCDF Measurement

2.3 CCDF Measurement

The CCDF (Complementary Cumulative Distribution Function) can be measured.

Setup

1. Connect the unit under test as shown in Figure 2-19.

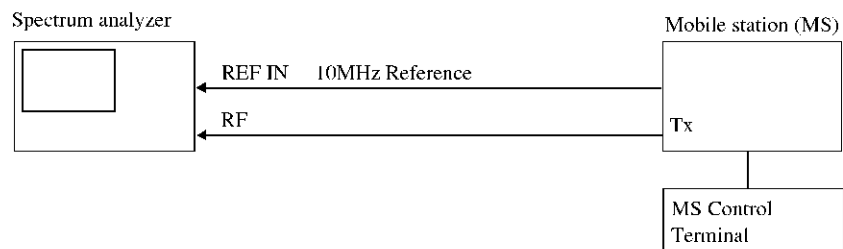

Figure 2-19 Setup for CCDF Measurement

Setting the measurement conditions

This changes the analyzer setting so that the input signal may be displayed more clearly.

2. Press **FREQ, 8, 2, 5, ., 0, 3** and **MHz**.
A center frequency of 825.03 MHz is set.
3. Press **SPAN, 2** and **MHz**.
A frequency span of 2 MHz is set.
4. Press **COUPLE, RBW AUTO/MNL(MNL), 3, 0** and **kHz**.
An RBW of 30 kHz is set.
5. Press **VBW AUTO/MNL(MNL), 1, 0, 0** and **kHz**.
A VBW of 100 kHz is set.
6. Press **LEVEL, 0** and **GHz(+dBm)**.
The reference level is set to 0 dBm.

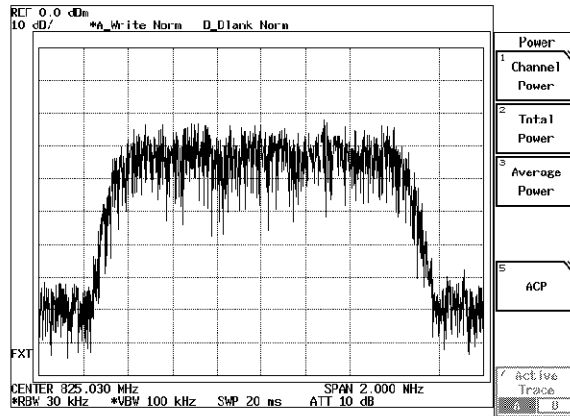

Figure 2-20 Spectrum of the Mobile Station Signal

CCDF Measurement

7. Press **TRANSIENT**, **Modulation**, **Power**, **CCDF** and **Parameter Setup**.
The Parameter Setup dialog box is displayed.
8. Select **INT** from **Trigger Mode** using the data knob, and press the data knob (or **ENTR**).
The measurement mode is set to a mode that uses the internal trigger.
9. Press **1, 0** and **kHz** to set **Meas Length**.
The number of measurement samples is set to 10k.

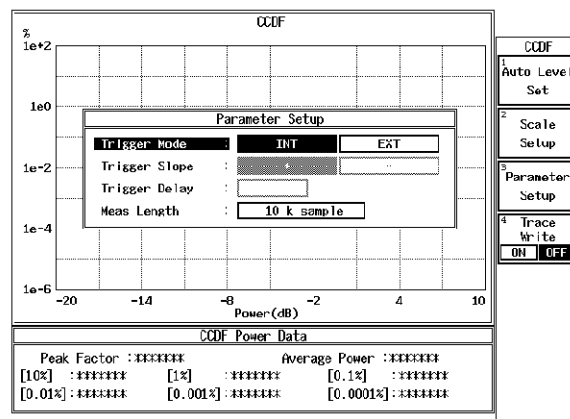

Figure 2-21 CCDF Parameter Setup Dialog Box

10. Press **Parameter Setup**.
The dialog box is removed.
11. Press **Auto Level Set**.
The measurement range is optimally set.

2.3 CCDF Measurement

12. Press **SINGLE**.

The measurement mode is set to the single mode and the measurement mode is displayed.

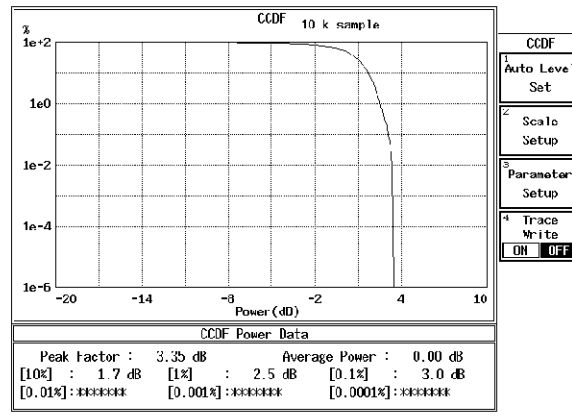

Figure 2-22 CCDF Measurement Result

Peak Factor	Peak factor
Average Power	Average power
[10%]	Power whose distribution is 10%
[1%]	Power whose distribution is 1%
[0.1%]	Power whose distribution is 0.1%
[0.01%]	Power whose distribution is 0.01%
[0.001%]	Power whose distribution is 0.001%
[0.0001%]	Power whose distribution is 0.0001%

Holding waveform

13. Press **Trace Write ON/OFF(ON)**.

The signal waveform is held.

14. Press **SINGLE**.

The measurement mode is set to SINGLE mode so that both the stored and current waveforms are displayed.

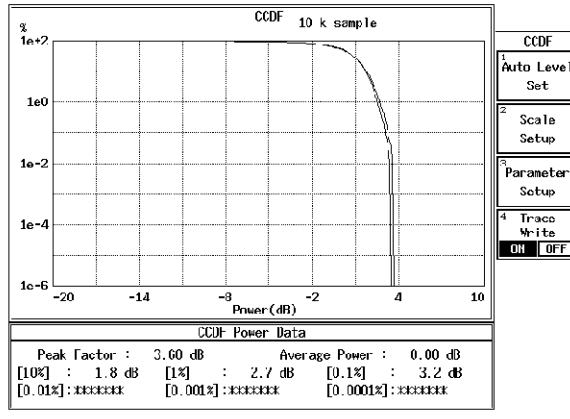

Figure 2-23 CCDF Measurement Result (Trace Write ON)

3 REFERENCE

This chapter describes the functions of the panel and soft keys for option 65 software.

3.1 Menu Index

This menu index is used to easily find the keys described in Chapter 3.

Operation Key	Pages	Operation Key	Pages
$\Delta\theta$	3-18, 3-20, 3-62, 3-69		3-52, 3-70, 3-73, 3-74, 3-76
$\Delta\tau$	3-18, 3-20, 3-61, 3-69	Band Class	3-22, 3-77
τ Offset.....	3-17, 3-57	Band Conversion.....	3-15
Auto Level Set	3-7, 3-8, 3-9, 3-10, 3-11, 3-12, 3-13, 3-14, 3-15, 3-16, 3-17, 3-19, 3-20, 3-21, 3-25, 3-28, 3-31, 3-33, 3-37, 3-38, 3-41, 3-45, 3-48, 3-52, 3-53, 3-63, 3-70, 3-73, 3-74, 3-75	Baseband Input	3-22, 3-78
Auto Rate	3-17, 3-58	Bit Reversal Order	3-17, 3-59
Average Mode.....	3-7, 3-8, 3-9, 3-10, 3-11, 3-12, 3-13, 3-14, 3-15, 3-16, 3-27, 3-30, 3-33, 3-36, 3-37, 3-40, 3-45, 3-48, 3-51, 3-53	Carrier Freq. Search.....	3-17, 3-57
Average Times ON/OFF.....	3-7, 3-8, 3-9, 3-10, 3-11, 3-12, 3-13, 3-14, 3-15, 3-16, 3-19, 3-20, 3-21, 3-27, 3-29, 3-32, 3-35, 3-37, 3-39, 3-43, 3-46, 3-49,	CCDF.....	3-6, 3-21
		CDP Graph Plot Type.....	3-18, 3-61
		Channel.....	3-17, 3-60
		Channel Def. Table.....	3-17, 3-59
		Channel Define	3-17, 3-58
		Channel Setting.....	3-22
		Channel Setup.....	3-20, 3-66
		Chip Rate Error.....	3-18, 3-20, 3-62, 3-69
		Code Domain Error.....	3-18, 3-62
		Code Domain Power (with REVERSE (RC3&4) setting)	3-6, 3-20
		Code Domain Power Coef (FORWARD)	3-53
		Code Domain Power Coef (with FORWARD setting).....	3-6
		Complementary Filter.....	3-17, 3-57
		Config	3-7, 3-8, 3-9, 3-10, 3-11, 3-12, 3-13, 3-14, 3-15, 3-16, 3-27, 3-29, 3-32, 3-36, 3-37, 3-39, 3-43, 3-46, 3-49, 3-52
		Constellation	3-17, 3-19, 3-20, 3-54, 3-63, 3-70
		Constellation(Dot)	3-17, 3-19, 3-20, 3-54, 3-63, 3-70
		Constellation(Line&Dot).....	3-17, 3-19, 3-20, 3-54,

3.1 Menu Index

Constellation(Line)	3-63, 3-71	3-44, 3-47,
	3-17, 3-19,	3-50, 3-53
	3-20, 3-54,	
	3-63, 3-70	Due to Modulation
Cont Auto Level Set	3-22, 3-78	3-6
Copy from STD	3-7, 3-12,	Due to Transient.....
	3-13, 3-14,	3-6
	3-15, 3-16,	E.V.M. vs Chip
	3-22, 3-26,	3-17, 3-19,
	3-38, 3-39,	3-20, 3-54,
	3-43, 3-46,	3-63, 3-71
	3-49, 3-52,	Edit.....
	3-76	3-17, 3-60
Data Rate.....	3-17, 3-60	Edit Table 1 2 3.....
DC CAL	3-22	3-22, 3-76
DCCH	3-20, 3-66	Edit Table 4 5 6.....
Delay Time	3-7, 3-8,	3-22, 3-76
	3-9, 3-10,	Edit Table 7 8 9.....
	3-13, 3-26,	3-22, 3-76
	3-29, 3-31,	Equalizing Filter
	3-34, 3-42	3-17, 3-57
Delete	3-16	EVM.....
Delete Line.....	3-7, 3-9,	3-18, 3-62
	3-12, 3-13,	Ext Gate
	3-14, 3-15,	3-10, 3-13,
	3-26, 3-32,	3-35, 3-42
	3-39, 3-43,	EXT Trigger Delay
	3-46, 3-49,	3-19, 3-20,
	3-52	3-21, 3-69,
Demod Data Save	3-20, 3-69	3-72, 3-73
Detector.....	3-7, 3-8,	EXT Trigger Slope.....
	3-9, 3-10,	3-17, 3-19,
	3-11, 3-12,	3-20, 3-21,
	3-13, 3-14,	3-58, 3-69,
	3-15, 3-16,	3-72, 3-73
	3-27, 3-30,	FCH.....
	3-32, 3-35,	3-20, 3-67
	3-36, 3-37,	F-Domain.....
	3-39, 3-42,	3-6
	3-44, 3-47,	Fixed Symbols Level
	3-50, 3-52	3-18, 3-62
Display	3-17, 3-20,	Format.....
	3-55, 3-64	3-17, 3-20,
Display div	3-20, 3-66	3-55, 3-65
Display Unit	3-7, 3-8,	Freq Meas Range
	3-9, 3-10,	3-19, 3-20,
	3-12, 3-13,	3-69, 3-72
	3-14, 3-15,	Freq. Setting.....
	3-16, 3-27,	3-12, 3-13,
	3-30, 3-32,	3-14, 3-15,
	3-36, 3-40,	3-39, 3-44,
		3-47, 3-50
		Frequency Input
		3-22, 3-77
		Gate Position.....
		3-10, 3-13,
		3-35, 3-42
		Gate Setup.....
		3-10, 3-13,
		3-34, 3-35,
		3-41, 3-42
		Gate Source
		3-10, 3-13,
		3-34, 3-42
		Gate Width.....
		3-10, 3-13,
		3-35, 3-42
		Gated Sweep
		3-10, 3-36
		Gated Sweep ON/OFF
		3-10, 3-13,
		3-35, 3-42
		Graphics
		3-17, 3-19,
		3-20, 3-53,
		3-63, 3-70
		I EYE Diagram
		3-17, 3-19,
		3-20, 3-54,

I/Q EYE Diagram	3-17, 3-19, 3-20, 3-54, 3-63, 3-71	Meas Options	3-17, 3-60
Ich & Qch Time	3-21	Meas Range.....	3-17, 3-19, 3-20, 3-57, 3-68, 3-72
Ich Time & FFT	3-21	Modulation.....	3-6
Inband Spurious(1)	3-6	Multiplier	3-9, 3-32
Inband Spurious(2)	3-6	Null Offset Constellation	3-19, 3-71
Input	3-22, 3-78	Null Offset Constellation(Dot)	3-19, 3-71
Insert Line	3-7, 3-9, 3-12, 3-13, 3-14, 3-15, 3-16, 3-26, 3-32, 3-38, 3-39, 3-43, 3-46, 3-49, 3-52	Null Offset Constellation(Line&Dot).....	3-19, 3-71
Integral Band.....	3-15, 3-51	Null Offset Constellation(Line).....	3-19, 3-71
IQ Complex FFT.....	3-21	Null Offset I EYE Diagram	3-19, 3-71
IQ Gain Error	3-18, 3-62	Null Offset I/Q EYE Diagram	3-19, 3-71
IQ Inverse	3-22, 3-78	Null Offset Q EYE Diagram.....	3-19, 3-71
Judgment.....	3-7, 3-8, 3-9, 3-10, 3-11, 3-12, 3-13, 3-14, 3-15, 3-16, 3-27, 3-30, 3-33, 3-36, 3-37, 3-40, 3-45, 3-48, 3-51, 3-53	OBW	3-6
Link.....	3-22, 3-77	OBW%.....	3-11, 3-37
Load Table	3-9, 3-16, 3-32, 3-52	OFF Position	3-8, 3-29
Lower Limit	3-7, 3-10, 3-11, 3-27, 3-36, 3-37	OFF Width	3-8, 3-29
Mag Error vs Chip	3-17, 3-19, 3-20, 3-54, 3-63, 3-71	Offset Level	3-22, 3-77
Margin ΔX ON/OFF	3-12, 3-13, 3-14, 3-15, 3-38, 3-43, 3-46, 3-49	ON Position.....	3-8, 3-29
Marker Edit.....	3-12, 3-13, 3-14, 3-15, 3-39, 3-43, 3-46, 3-49	ON Width.....	3-8, 3-29
Meas.....	3-20, 3-60	ON/OFF Ratio.....	3-6, 3-8
Meas Length	3-21, 3-75	Operation Mode	3-20, 3-66
Meas Mode	3-20, 3-68	Outband Spurious	3-6
		Parameter Setup	3-7, 3-8, 3-9, 3-10, 3-11, 3-12, 3-13, 3-14, 3-15, 3-16, 3-17, 3-19, 3-20, 3-21, 3-27, 3-30, 3-32, 3-36, 3-37, 3-39, 3-44, 3-47, 3-49, 3-52, 3-67, 3-72, 3-73, 3-74, 3-76
		Peak MKR Y Delta.....	3-9, 3-14, 3-15, 3-16, 3-32, 3-47, 3-50, 3-52
		Phase Error vs Chip	3-19, 3-20, 3-64, 3-71
		Pilot Channel Power	3-18, 3-61
		Plot Type.....	3-17, 3-19, 3-20, 3-54, 3-64, 3-72
		PN Delay	3-20, 3-69
		PN Delay Search Mode.....	3-20, 3-69
		PN Offset	3-17, 3-57

3.1 Menu Index

PN Offset Search Mode	3-17, 3-57	Shift X.....	3-7, 3-12, 3-13, 3-14, 3-15, 3-26, 3-38, 3-43, 3-46, 3-49
Power	3-6, 3-21	Shift Y.....	3-7, 3-12, 3-13, 3-14, 3-15, 3-26, 3-38, 3-43, 3-46, 3-49
Power Unit	3-18, 3-21, 3-61, 3-74	Signal Power.....	3-18, 3-62
Preselector.....	3-9, 3-16, 3-33, 3-53	Signal Type	3-22, 3-77
Q EYE Diagram	3-17, 3-19, 3-20, 3-54, 3-63, 3-71	Slope	3-7, 3-8, 3-9, 3-10, 3-13, 3-25, 3-29, 3-31, 3-34, 3-41
Qch Time & FFT	3-21	Sort.....	3-7, 3-12, 3-13, 3-14, 3-15, 3-27, 3-39, 3-43, 3-46, 3-49
QOF	3-17, 3-59, 3-60	Spurious	3-6
Quadrature Error	3-18, 3-20, 3-62, 3-69	Start Offset.....	3-15, 3-51
RC.....	3-17, 3-60	STD.....	3-6, 3-22
Ref Power	3-12, 3-13, 3-14, 3-15, 3-40, 3-44, 3-47, 3-50	STD Setup.....	3-22, 3-77
Result	3-9, 3-12, 3-13, 3-14, 3-15, 3-32, 3-39, 3-44, 3-47, 3-50	Stop Offset.....	3-15, 3-51
Rolloff Factor.....	3-12, 3-13, 3-17, 3-40, 3-45, 3-57	Symbol Rate 1/T.....	3-12, 3-13, 3-40, 3-45
Save Table.....	3-9, 3-16, 3-32, 3-52	Table Edit.....	3-9, 3-16, 3-32, 3-52
Scale Setup.....	3-17, 3-21, 3-55, 3-74	Table Init.....	3-7, 3-9, 3-12, 3-13, 3-14, 3-15, 3-16, 3-27, 3-32, 3-39, 3-43, 3-46, 3-49, 3-52
SCH1 Repetition Factor.....	3-20, 3-67	Table No. 1/2/3	3-9, 3-16, 3-31, 3-32, 3-52
SCH1 Walsh Function	3-20, 3-67	Table Page.....	3-17, 3-20, 3-56, 3-66
SCH2 Repetition Factor.....	3-20, 3-67	T-Domain.....	3-6, 3-25
SCH2 Walsh Function	3-20, 3-67	Template	3-7, 3-12, 3-13, 3-14, 3-15, 3-26, 3-38, 3-42, 3-46, 3-48
Select Type	3-17, 3-19, 3-20, 3-21, 3-54, 3-63, 3-70, 3-75	Template Couple to Power	3-7, 3-12, 3-13, 3-14,
Set to Default	3-9, 3-16, 3-33, 3-53		
Set to STD.....	3-7, 3-8, 3-10, 3-11, 3-12, 3-13, 3-14, 3-15, 3-26, 3-28, 3-29, 3-30, 3-35, 3-36, 3-38, 3-41, 3-42, 3-45, 3-48, 3-51		

	3-15, 3-27, 3-40, 3-45, 3-48, 3-51	3-19, 3-20, 3-21, 3-25, 3-28, 3-31, 3-34, 3-41, 3-58, 3-69, 3-72, 3-73, 3-76
Template Edit.....	3-7, 3-12, 3-13, 3-14, 3-15, 3-26, 3-38, 3-43, 3-46, 3-49	
Template Limit	3-7, 3-12, 3-13, 3-14, 3-15, 3-27, 3-40, 3-45, 3-48, 3-51	Tx Power..... 3-6, 3-21 Upper Limit..... 3-7, 3-8, 3-10, 3-11, 3-27, 3-30, 3-36, 3-37
Template ON/OFF	3-7, 3-13, 3-14, 3-15, 3-26, 3-38, 3-43, 3-46, 3-49	View Channel 3-20, 3-65 View Mode 3-20, 3-64 View Setup..... 3-20, 3-64 Walsh Code Length 3-17, 3-20, 3-58, 3-67 Walsh Number 3-17, 3-60
Template UP/LOW	3-7, 3-26	Waveform Quality (with REVERSE (RC1&2) setting) 3-6, 3-19
Threshold	3-17, 3-20, 3-58, 3-68	Window ON/OFF 3-7, 3-8, 3-10, 3-26, 3-29, 3-35
Time & FFT	3-6, 3-21	Window Position..... 3-7, 3-10, 3-26, 3-35
Total	3-17, 3-59	Window Setup..... 3-7, 3-8, 3-10, 3-26, 3-29, 3-35
Trace Write ON/OFF.....	3-21, 3-75	Window Width..... 3-7, 3-10, 3-26, 3-35
Trigger	3-10, 3-13, 3-34, 3-42	X Scale Max..... 3-21, 3-74 X Scale Range..... 3-21, 3-74 Y Scale..... 3-17, 3-20, 3-56, 3-65
Trigger Delay	3-21, 3-75, 3-76	Y Scale [dB/div] 10/5/2 3-7, 3-8, 3-10, 3-27, 3-29, 3-35
Trigger Level	3-7, 3-8, 3-9, 3-10, 3-13, 3-21, 3-26, 3-29, 3-31, 3-34, 3-42, 3-73, 3-76	Y Scale Upper..... 3-17, 3-56 Y/div 3-17, 3-20, 3-56, 3-64, 3-66 Y/div(Ch.Graph) 3-20, 3-65
Trigger Mode	3-21, 3-75	
Trigger Position	3-7, 3-8, 3-9, 3-10, 3-13, 3-26, 3-29, 3-31, 3-34, 3-42	
Trigger Setup	3-7, 3-8, 3-9, 3-10, 3-13, 3-25, 3-28, 3-31, 3-34, 3-41	
Trigger Slope	3-21, 3-75, 3-76	
Trigger Source	3-7, 3-8, 3-9, 3-10, 3-13, 3-17,	

3.2 Menu Map

3.2 Menu Map

This section shows the hierarchical menu configuration on a panel key basis

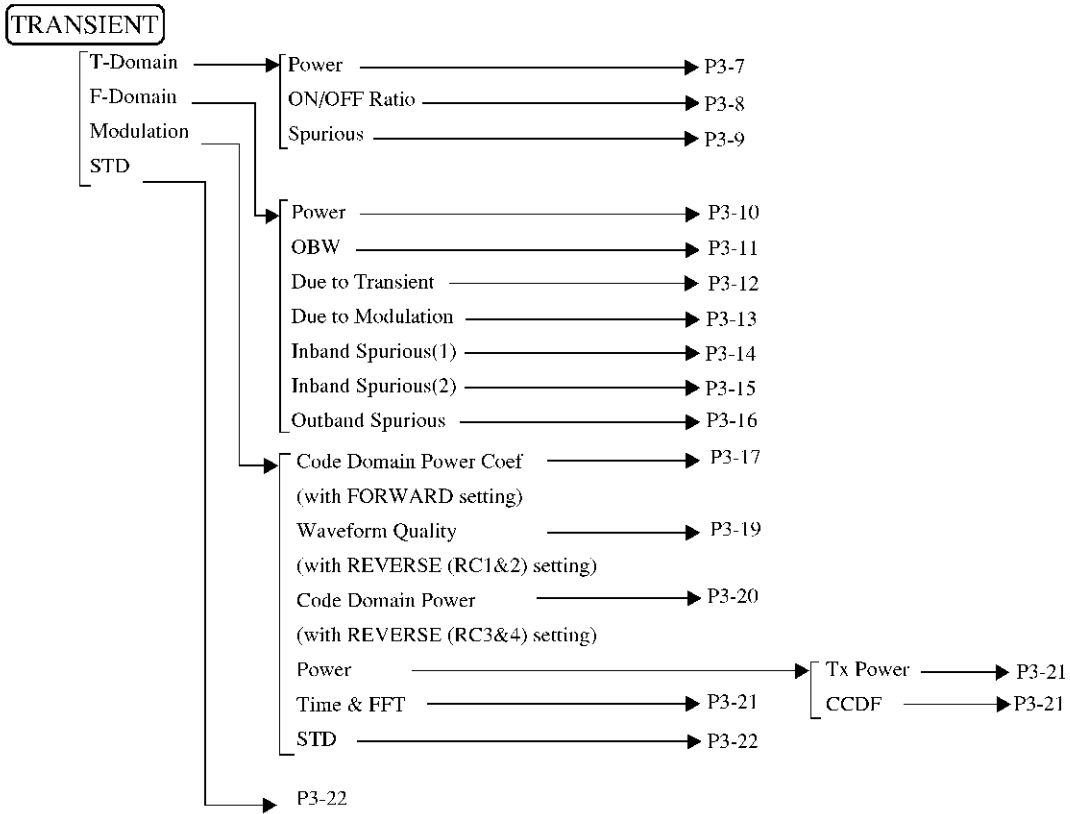

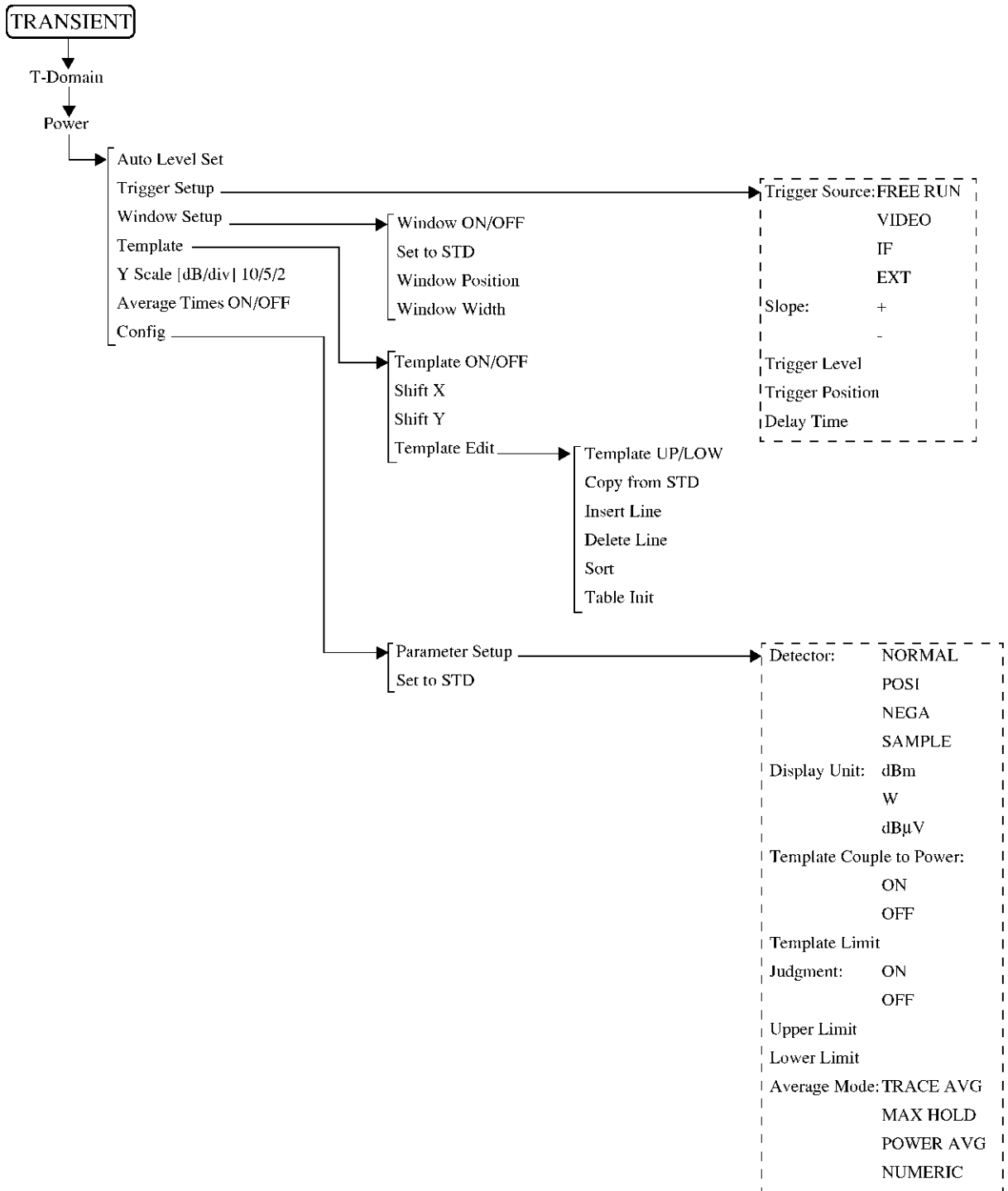

3.2 Menu Map

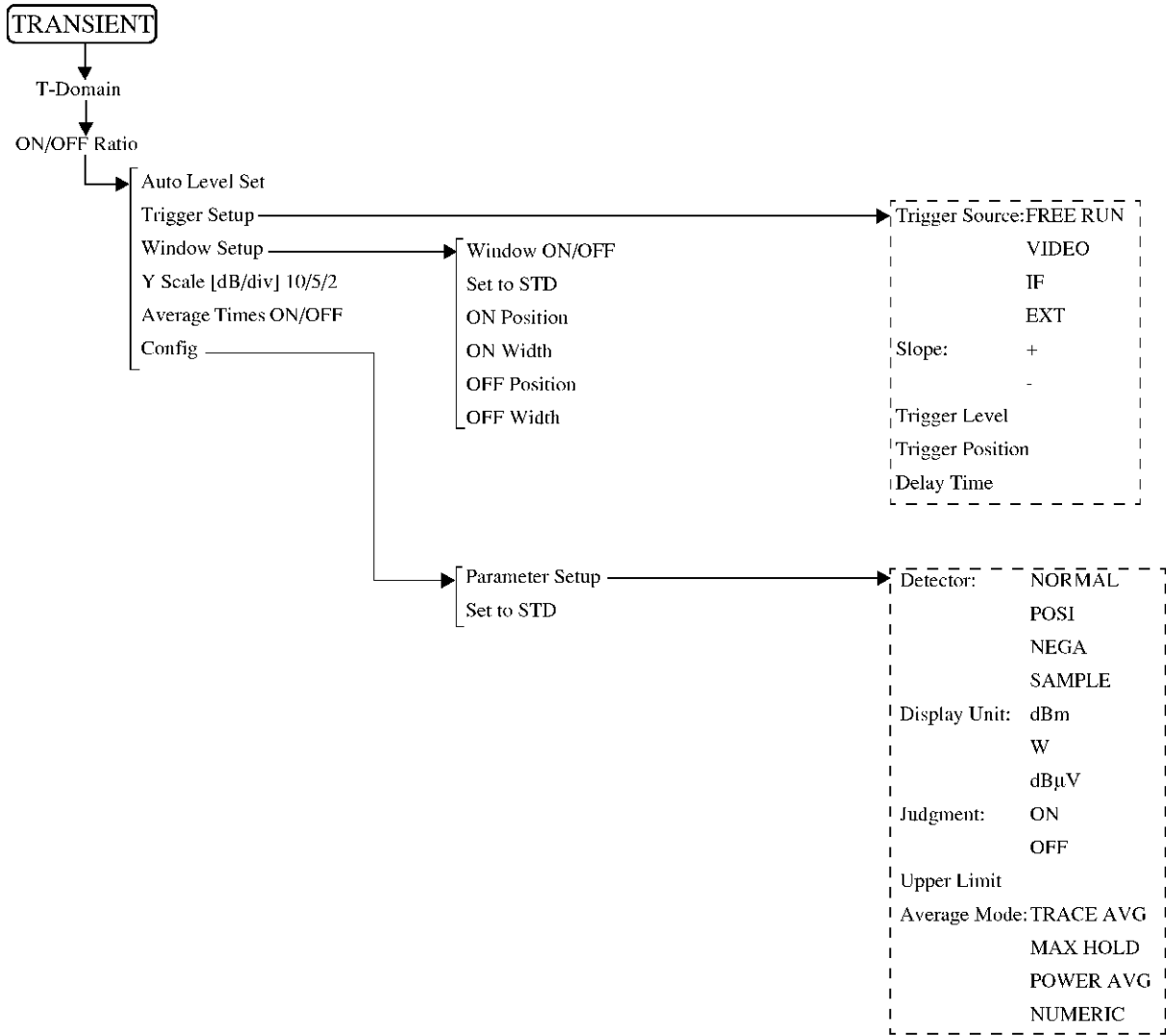

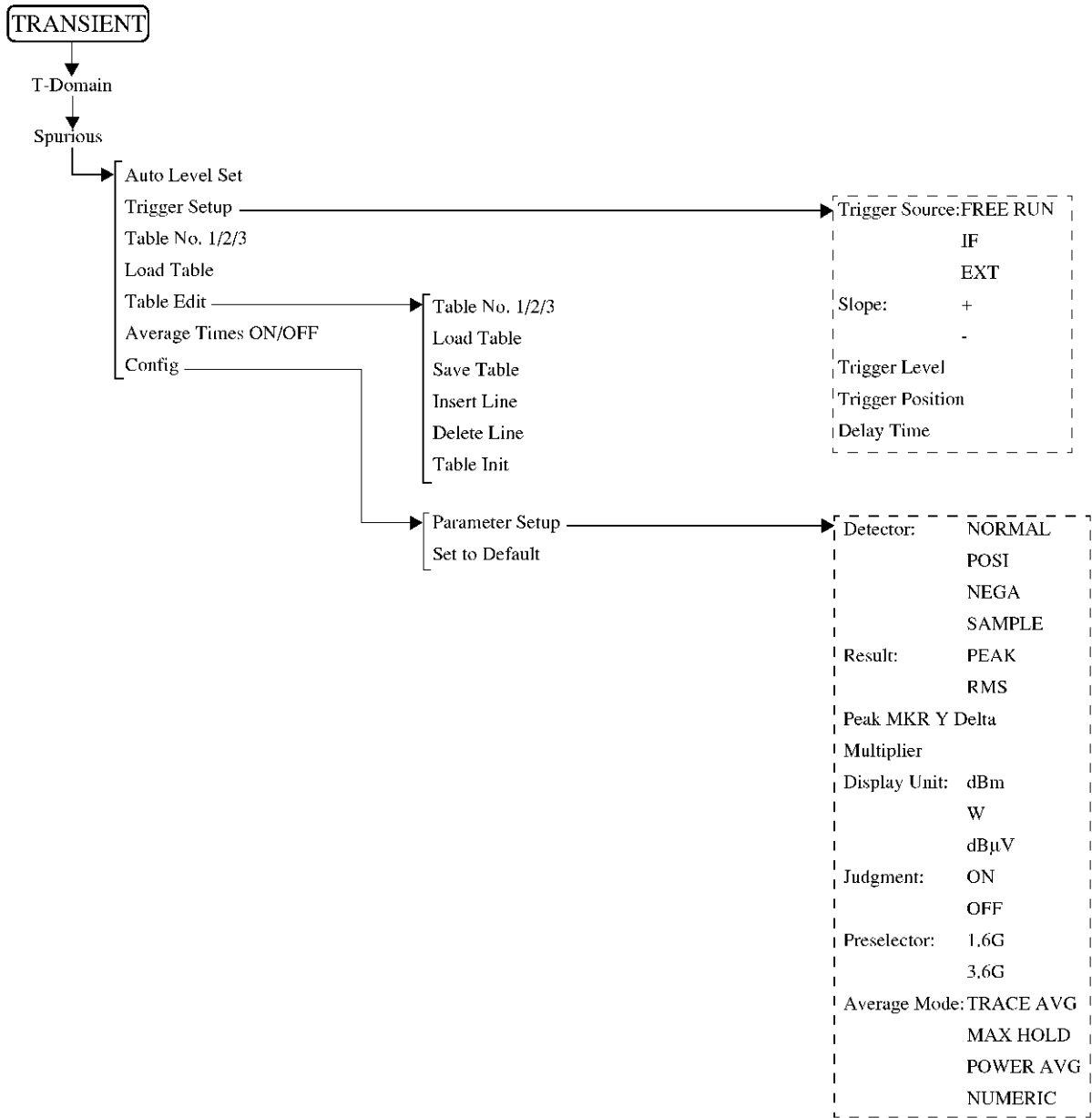

3.2 Menu Map

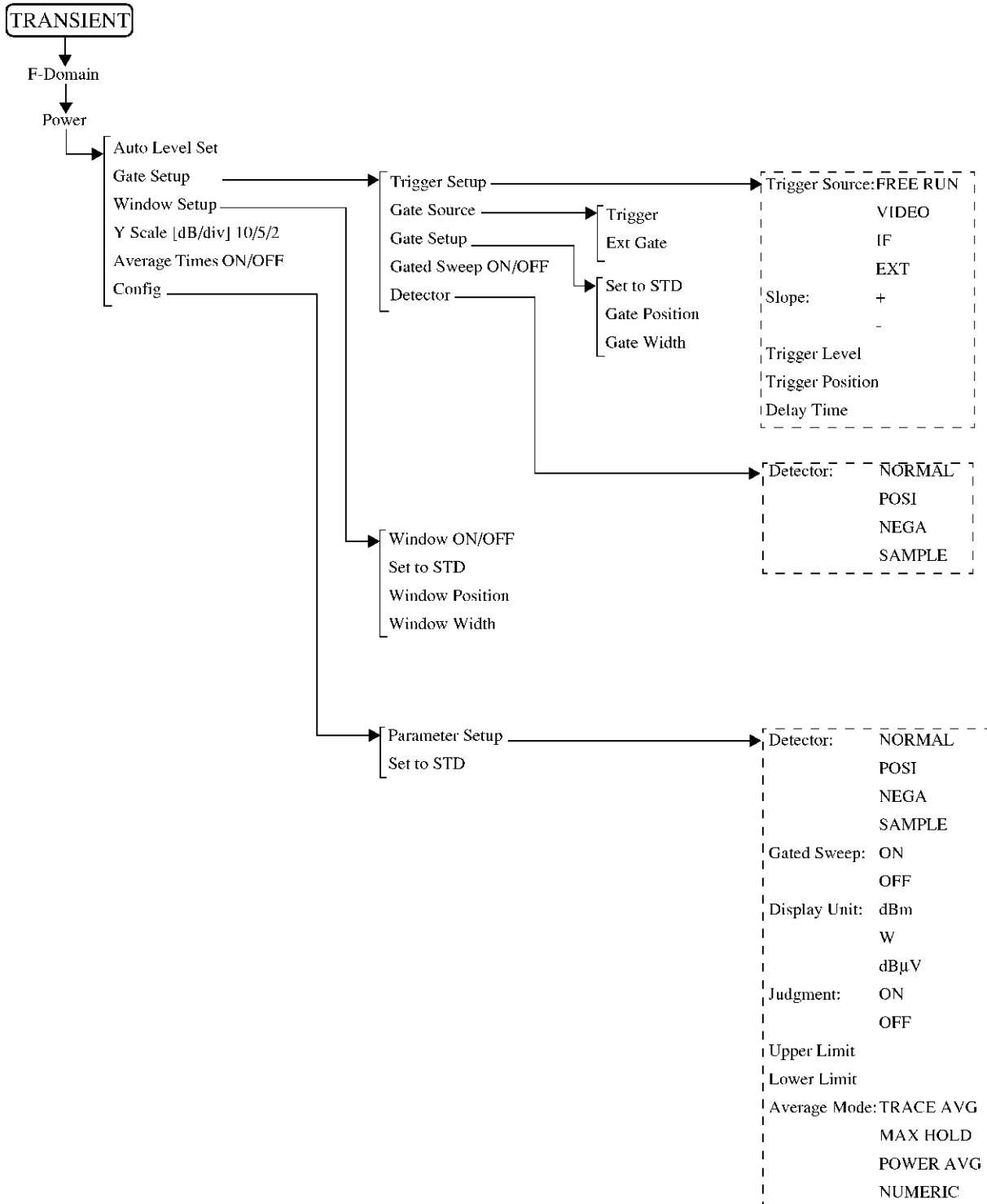

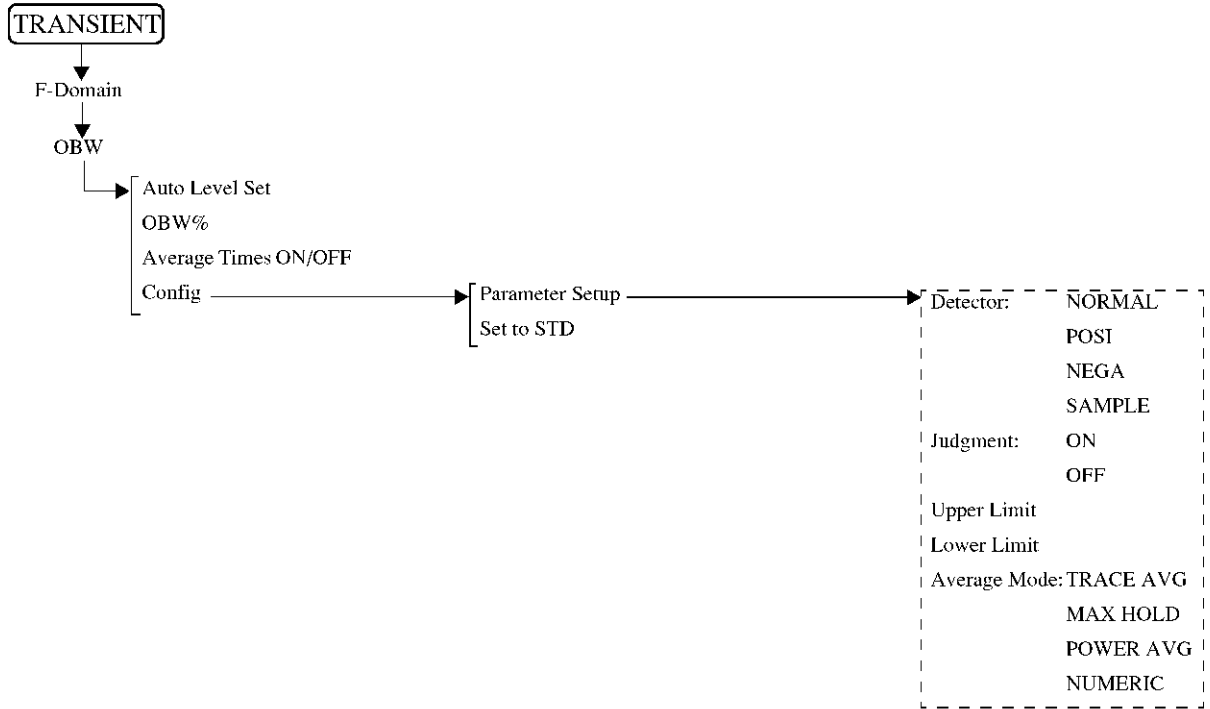

3.2 Menu Map

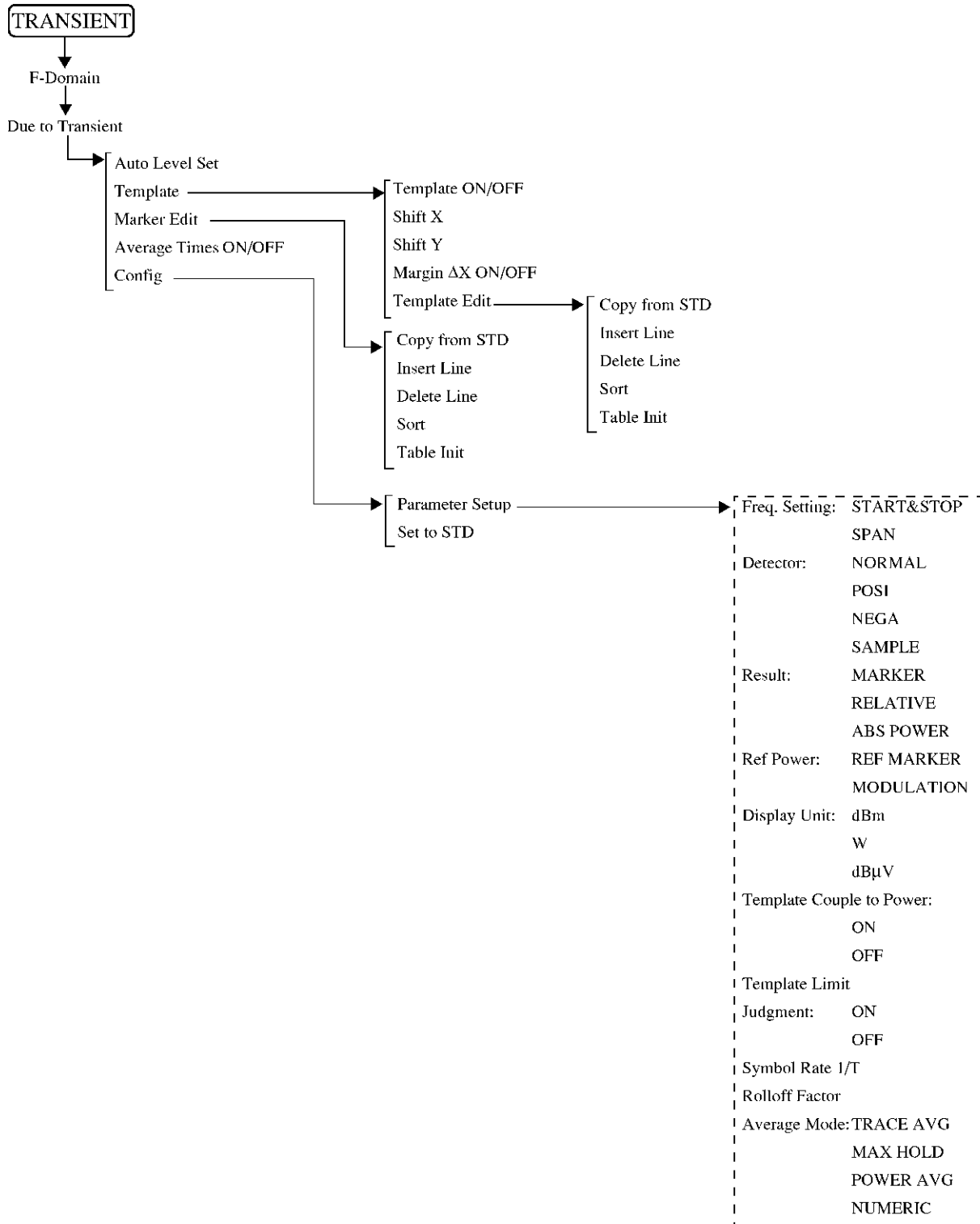

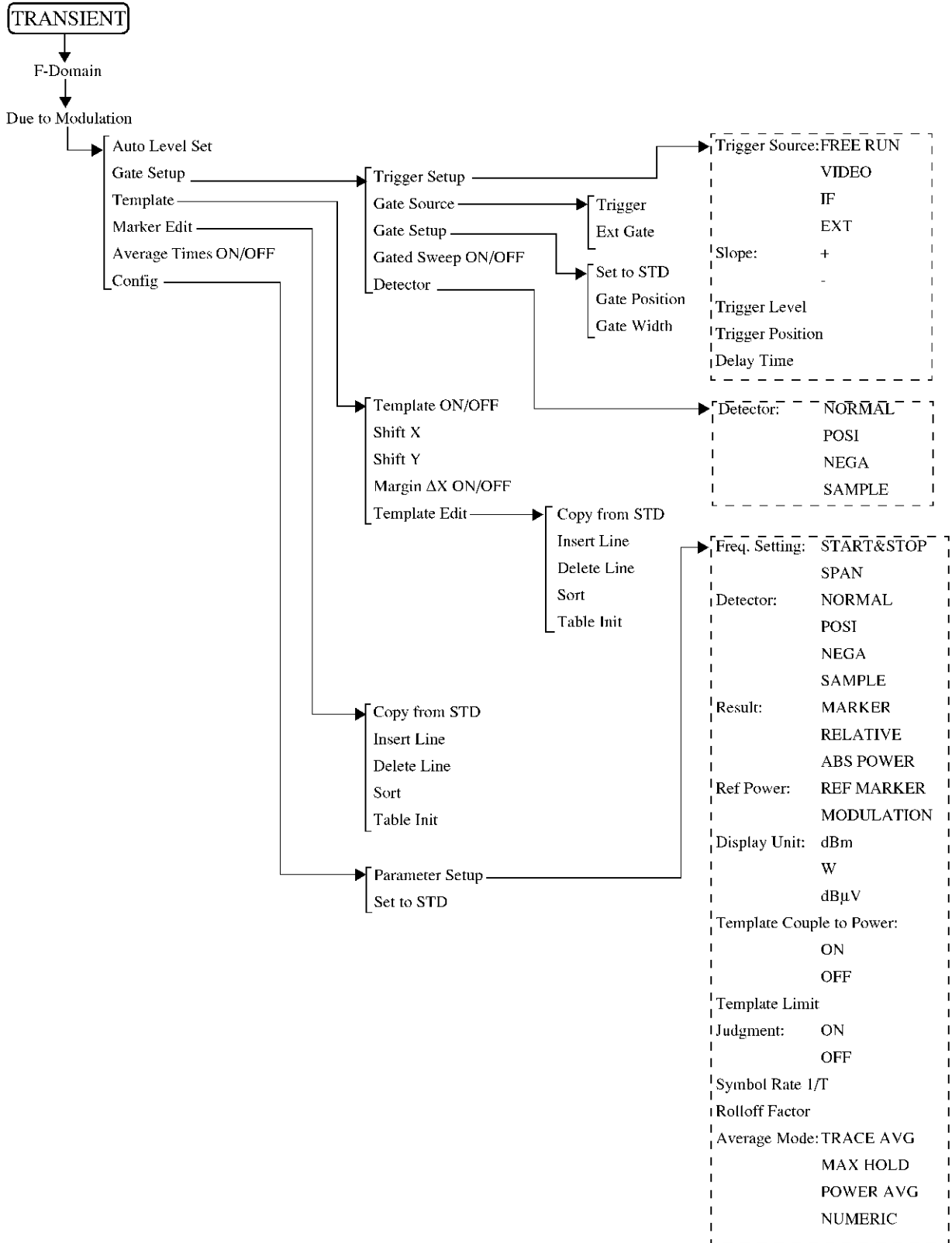

3.2 Menu Map

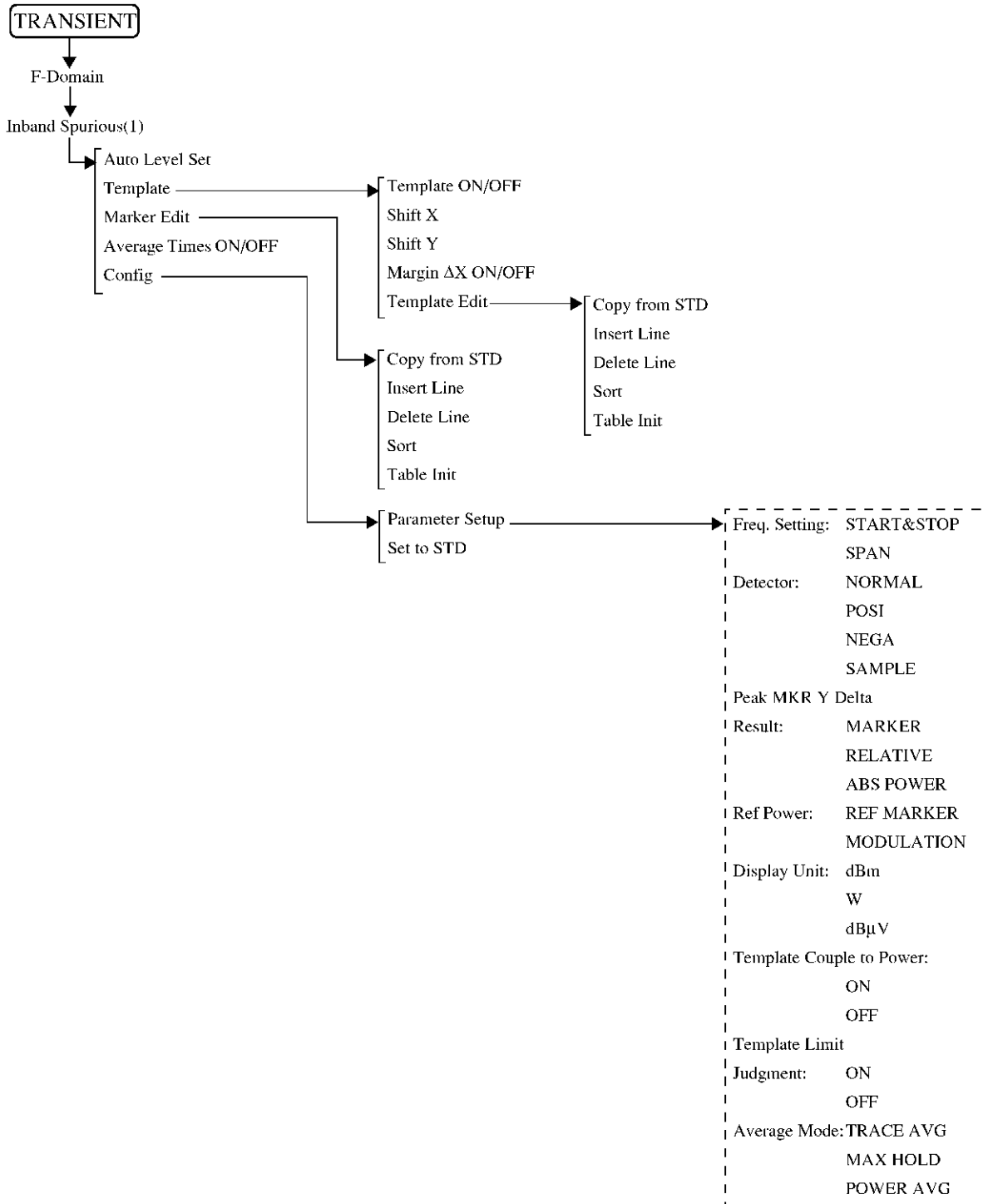

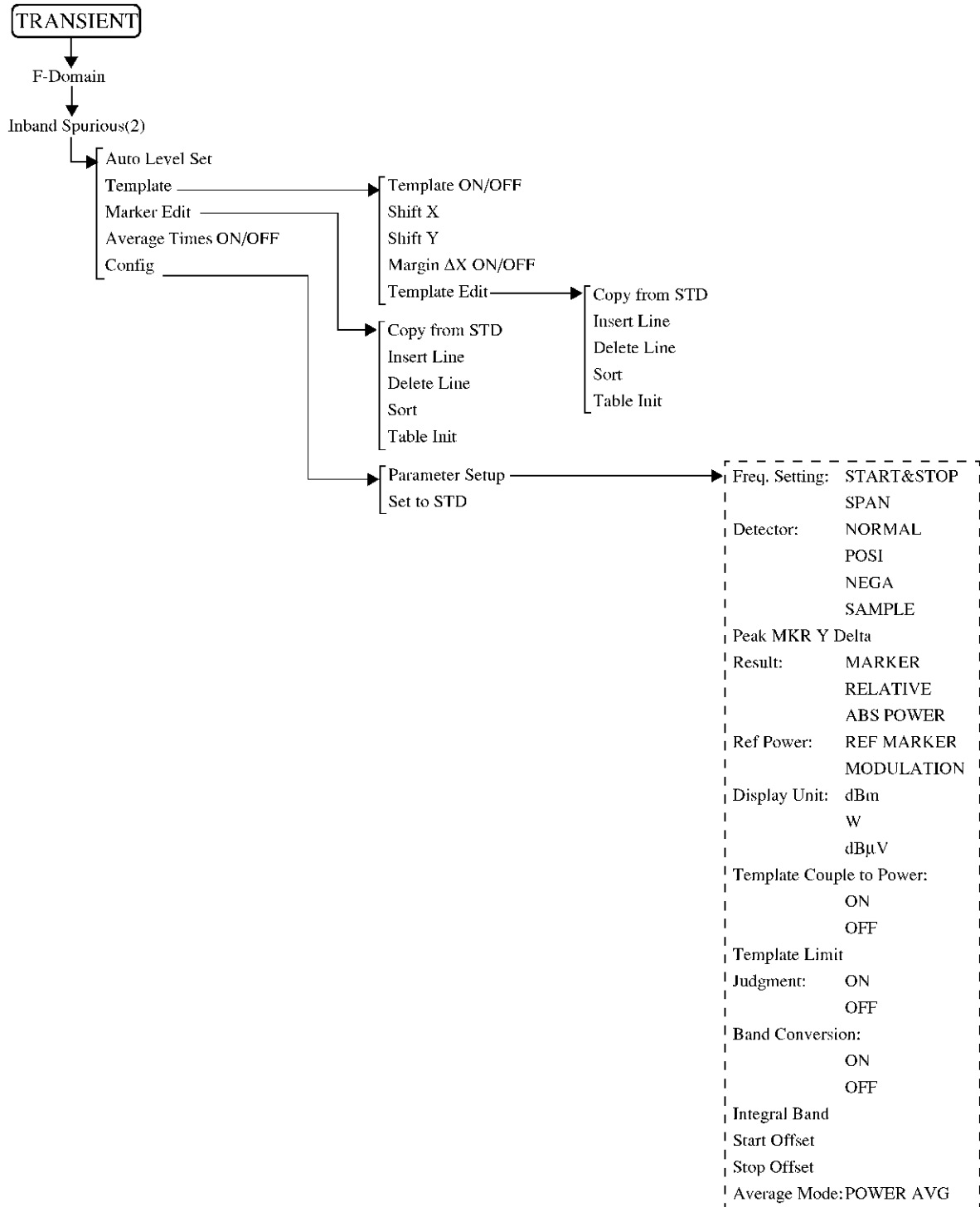

3.2 Menu Map

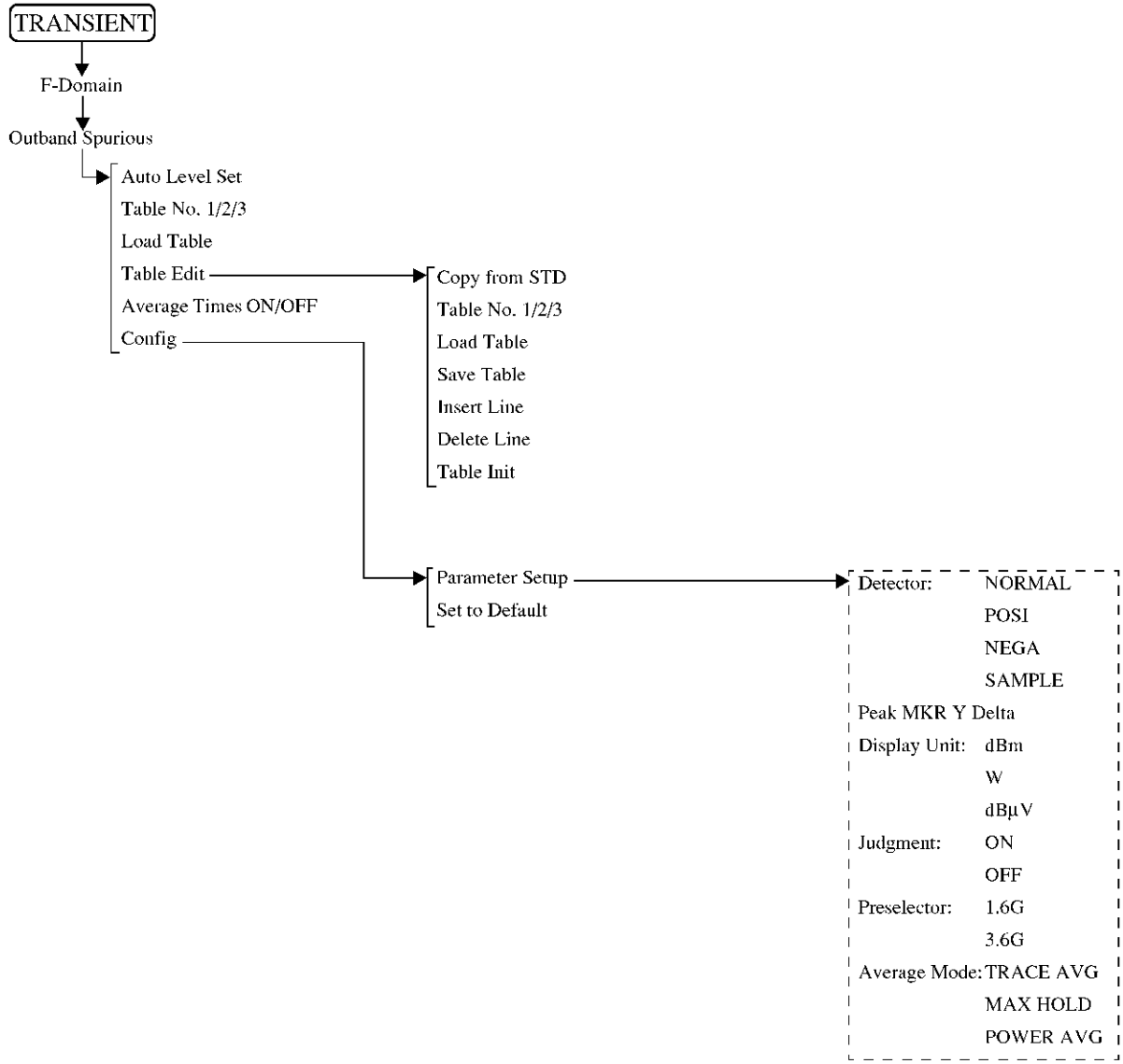

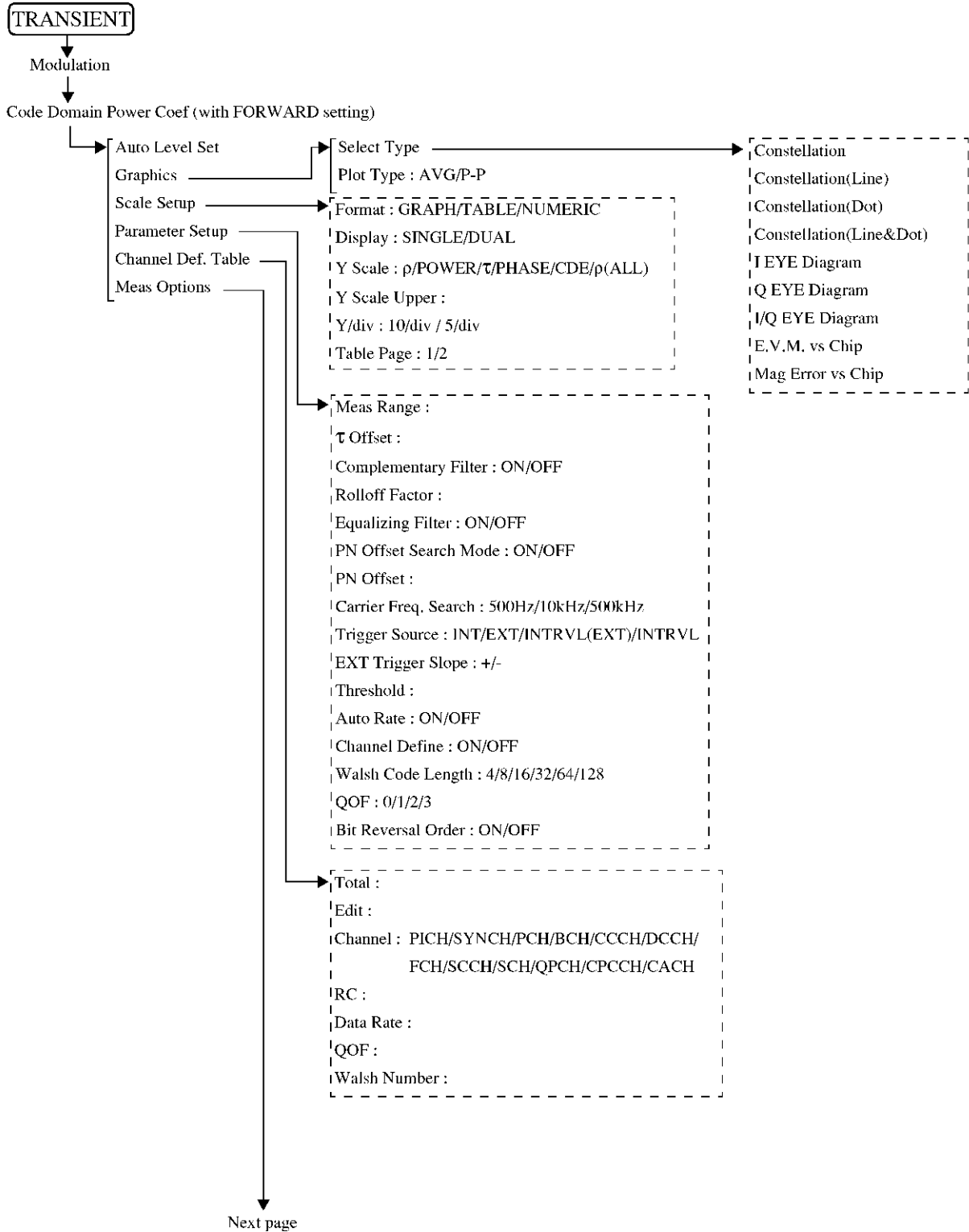

3.2 Menu Map

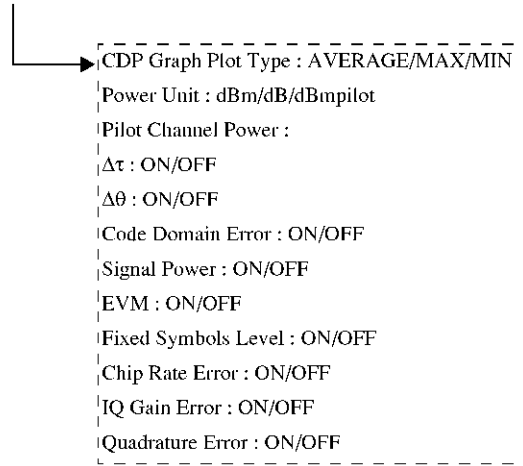

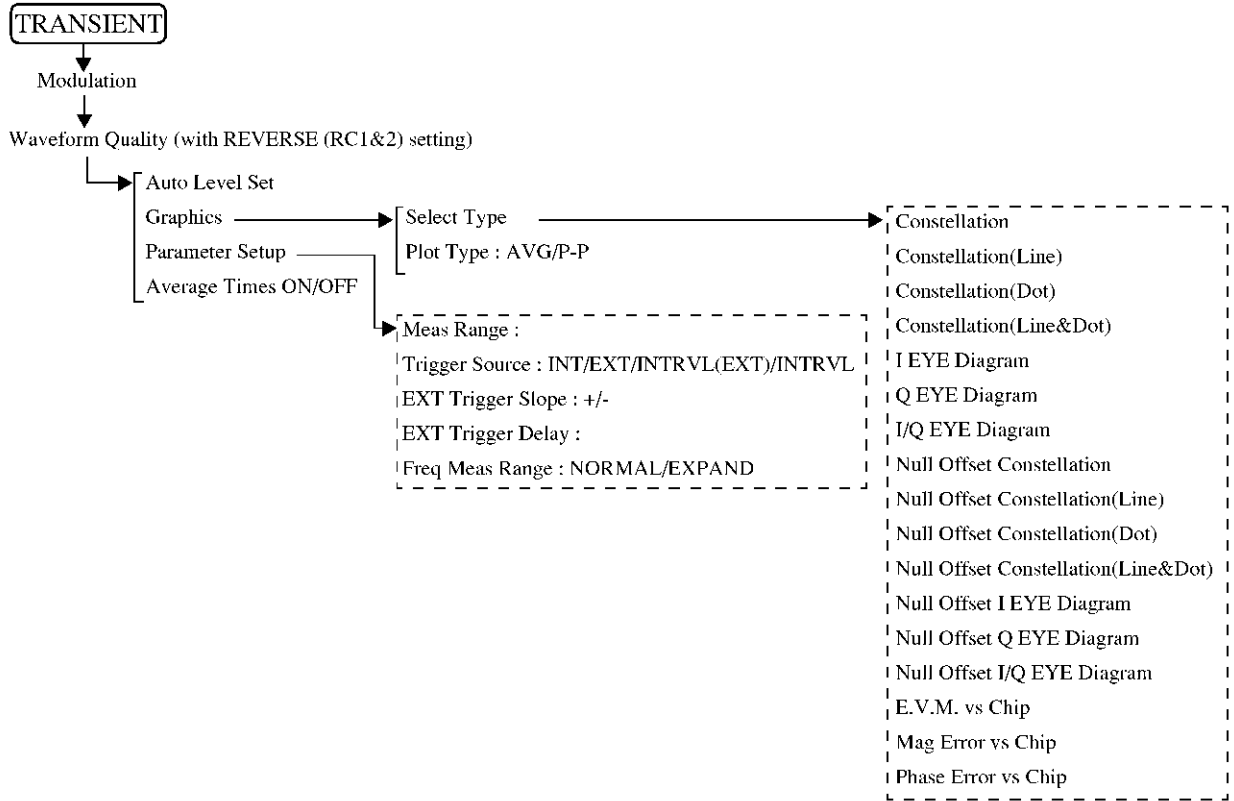

3.2 Menu Map

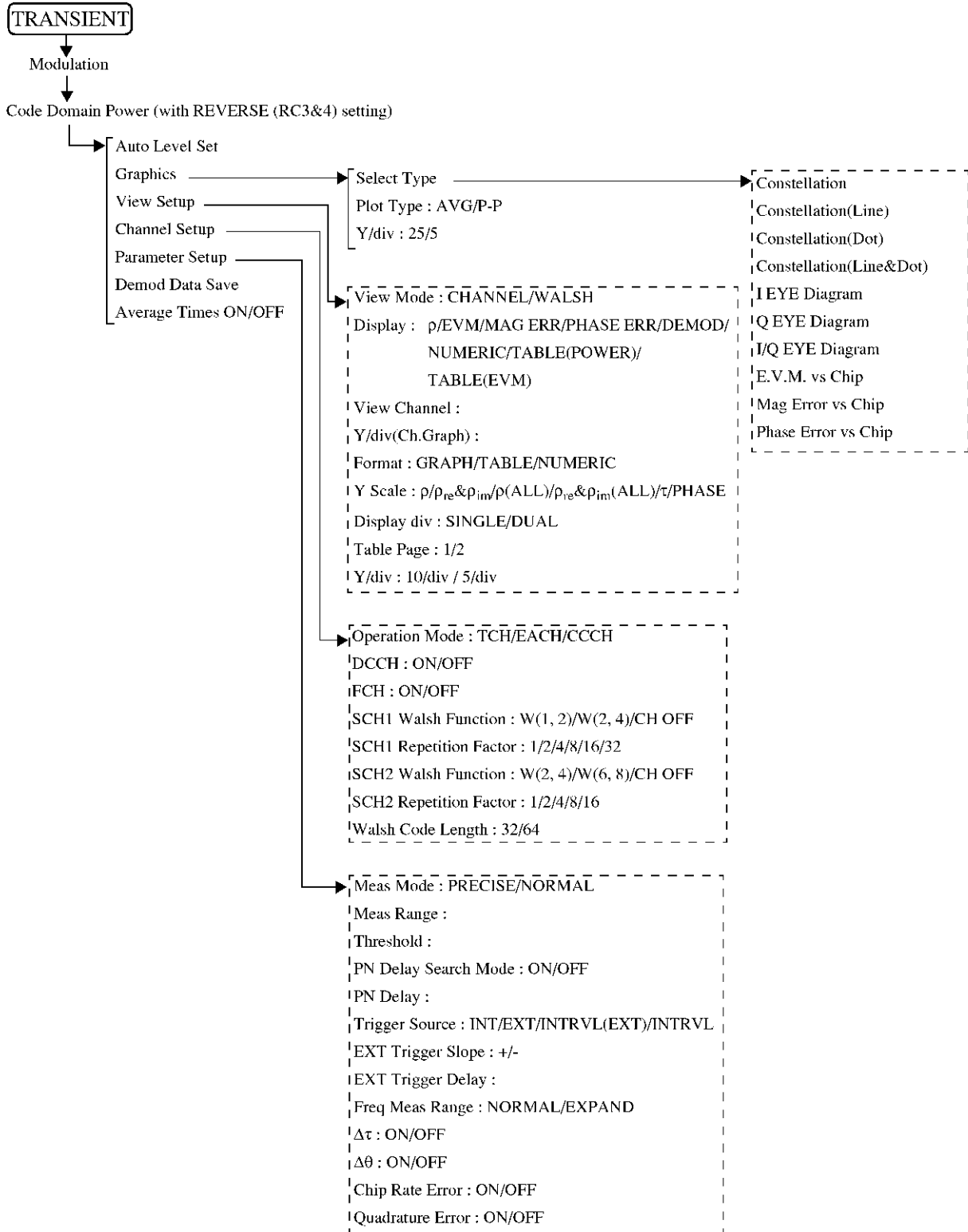

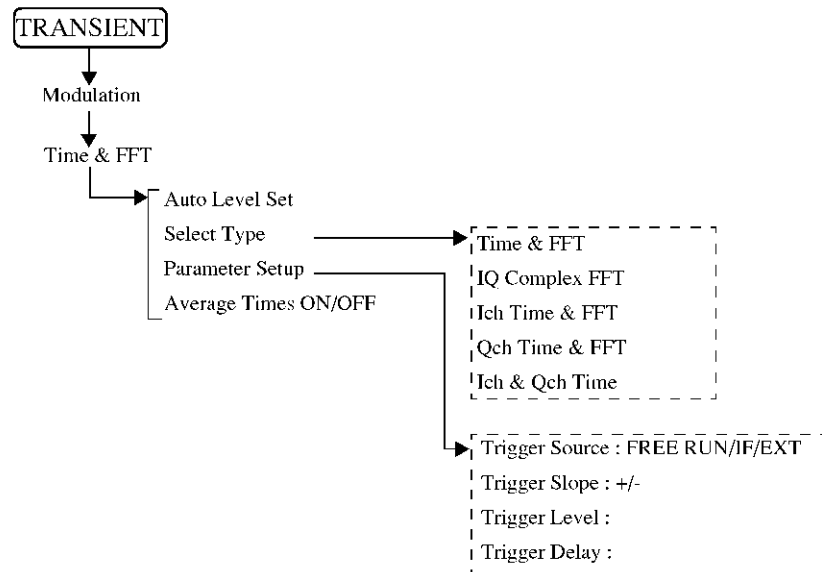
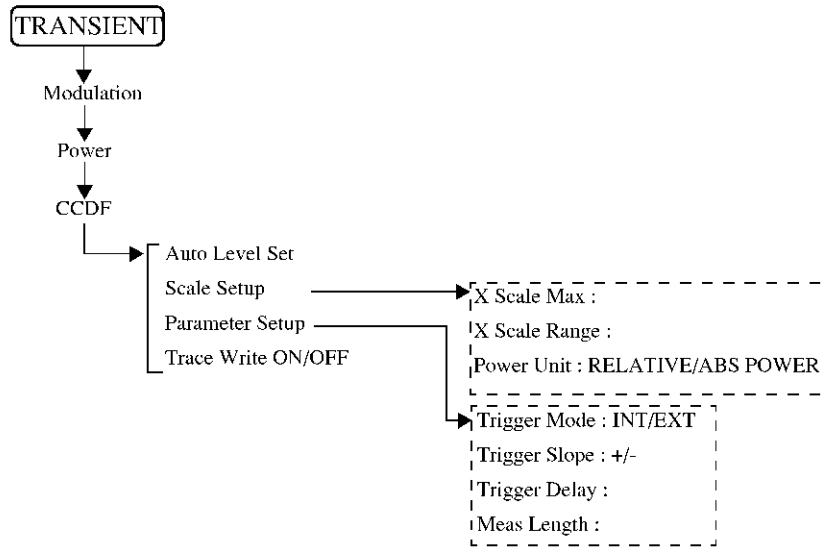
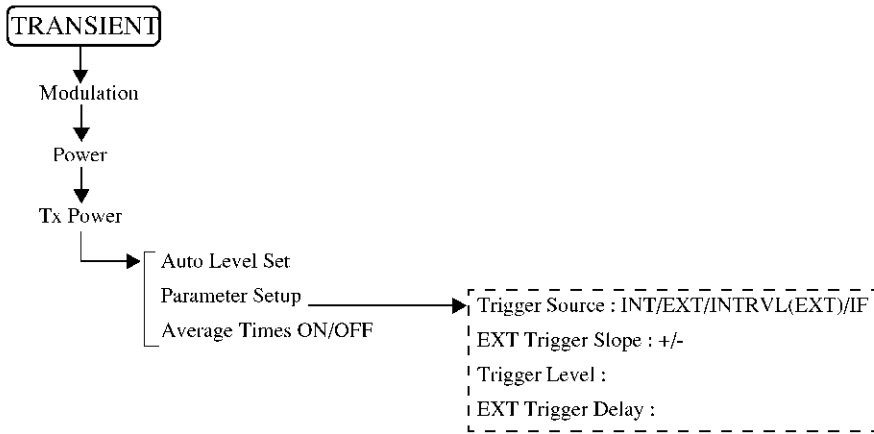

3.2 Menu Map

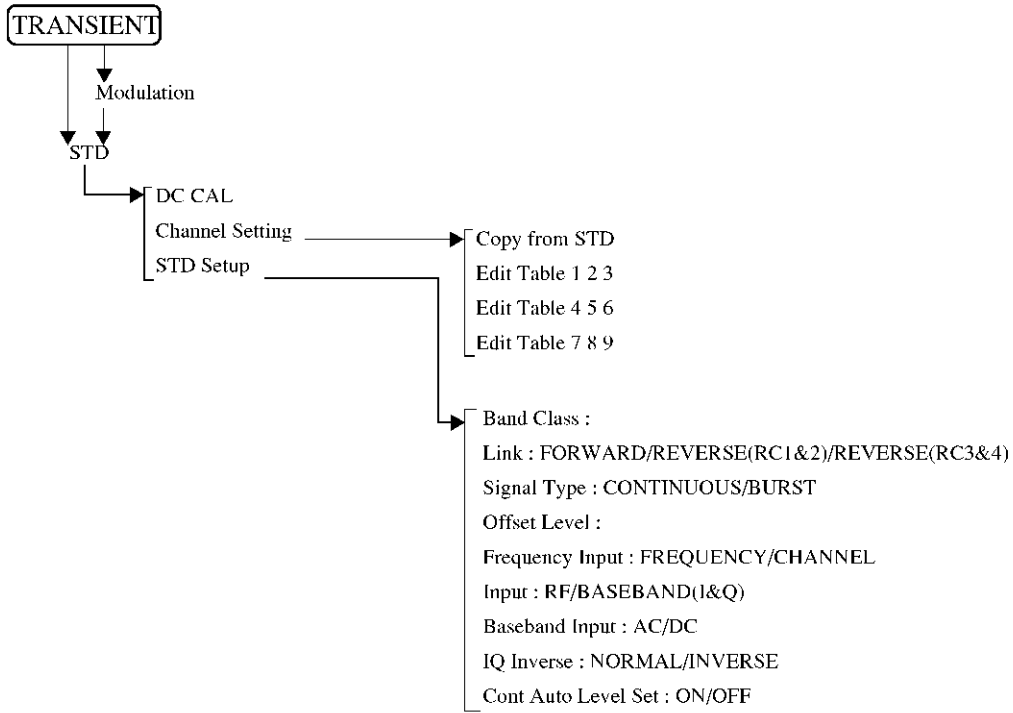

3.3 Functional Description

When modulation analysis hardware and software are installed, the following menus are assigned to the **TRANSIENT** key.

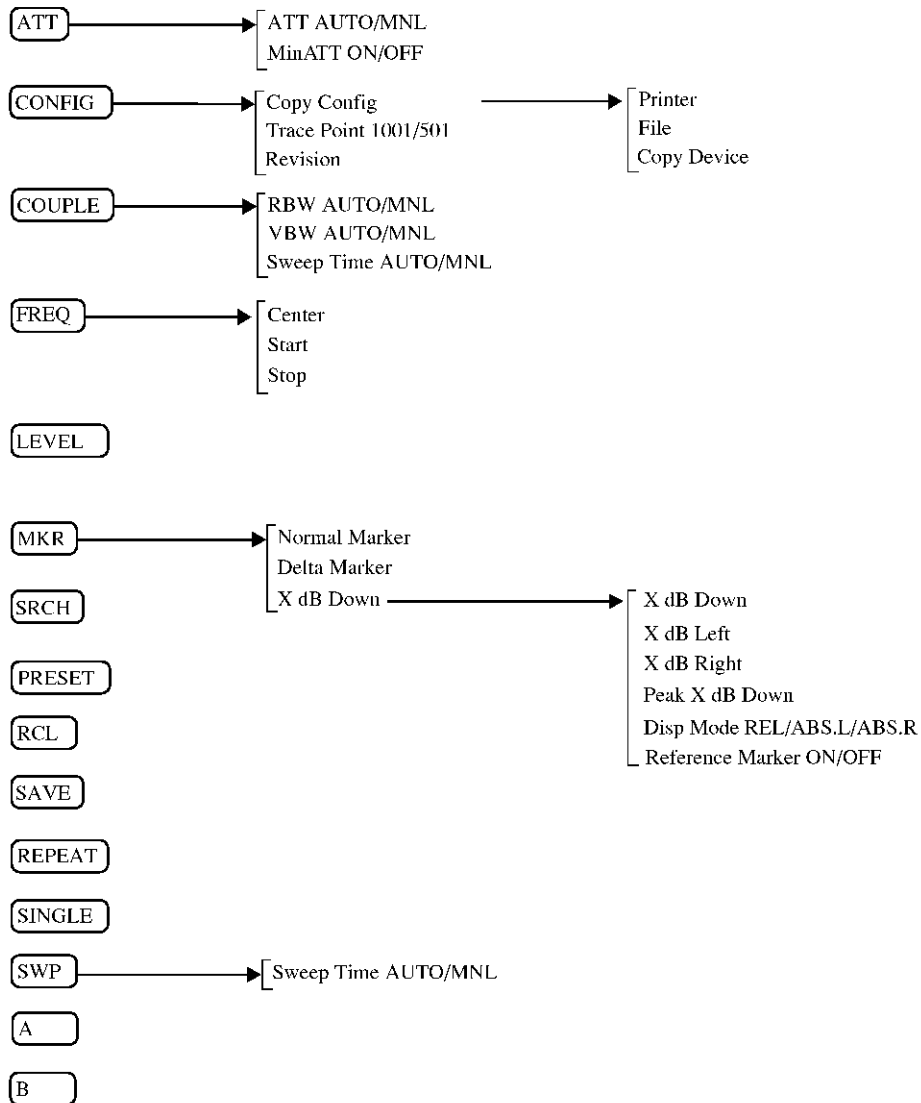

3.3 Functional Description

3.3.1 Switching Communication Systems

This section describes how to switch the communication systems. The analyzer must be set to the SPA mode to switch between the communication systems.

NOTE: *After the communication system has been switched, the parameters previously set for the former communication system will be cleared.
If necessary, save the old parameters, before switching the communication system to another.*

1. Press the **POWER** to enter the SPA mode.
2. Press **CONFIG**.
3. Press *more 1/2*.
If there are other communication systems installed, with which this instrument can analyze, "Comm.System" is displayed in the soft menu.
4. Press **Comm.System**.
Select the communication system you wish using the data knob, and press the knob (or **ENTR**).

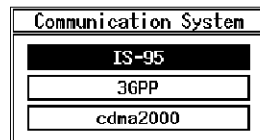

Figure 3-1 Communication Systems Dialog Box

5. When the data knob (or **ENTR**) is pressed, the message "LOADING" is displayed. After the message disappears, the switchover to another system is complete.
6. Press the **TRANSIENT** to confirm that the menu has been changed.

Saving set conditions

1. To save the parameters, press **SHIFT** and **RCL**.
2. Set the SAVE FILE number and press **Save**.

3.3.2 T-Domain

Carries out a measurement according to the standard using the zero span of the spectrum analyzer. Measurement items include power, ON/OFF ratio of a burst signal, and spurious measurements in the time domain with a specified frequency.

In the T-Domain measurement, the setting for the RBW, VBW, Sweep Time, or Detector is saved when exiting from each measurement and recalled when entering each measurement again. To return the setting to the value specified by the standard, press *Config* and *Set to STD*.

3.3.2.1 Power (T-Domain)

This is a function to measure power in the time domain (zero span).

There are two Pass/Fail judgment functions: a judgment function for the template and a judgment function for power.

NOTE: The RBW must be set wider than the modulation band.

Auto Level Set

Sets the internal reference level to an optimum value in accordance with the measurement signal. The reference level is automatically adjusted when this key is pressed.

NOTE: The input signal level must be constant while Auto Level Set is being carried out.

Trigger Setup

Sets a trigger.

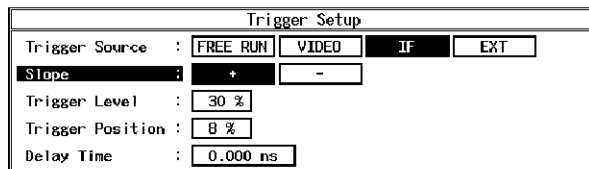

Figure 3-2 Trigger Setup Dialog Box

Trigger Source

Selects a trigger.

FREE RUN:

Captures data using the internal measurement timing.

VIDEO: Captures the signal in sync with the VIDEO signal.

IF: Captures the signal in sync with the IF signal (the leading edge of the burst).

EXT: Captures the signal in sync with the external trigger signal.

Slope

Selects the edge when triggering.

+: Triggers at the leading edge.

-: Triggers at the trailing edge.

3.3 Functional Description

<i>Trigger Level</i>	Sets the level to trigger.
<i>Trigger Position</i>	Sets the trigger position where it is displayed on the screen.
<i>Delay Time</i>	Sets a delay time from the time a trigger signal is detected to the time the signal is captured.
<hr/>	
<i>NOTE: When Delay Time is a negative value, signals before the trigger can be captured.</i>	
<hr/>	
<i>Window Setup</i>	Sets the window used for power measurement.
<i>Window ON/OFF</i>	Displays a window showing the range for power measurement. When OFF is set, the power measurement range covers all points on the display screen.
<i>Set to STD</i>	Sets the window specified by the communication standard.
<i>Window Position</i>	Sets the position of the window.
<i>Window Width</i>	Sets the width of the window.
<hr/>	
<i>NOTE: When the window is partially outside the display, an arrow is shown next to Pose, Width or both in the area indicating the window conditions.</i>	
<hr/>	
<i>Template</i>	Sets the template. For more information, refer to Section 5.1.1, "Template Setting in the T-Domain Measuring Mode."
<i>Template ON/OFF</i>	Sets whether to display the template and to toggles the Pass/Fail judgment function on or off.
<i>Shift X</i>	Sets the amount of template movement in the X-axis direction.
<i>Shift Y</i>	Sets the amount of template movement in the Y-axis direction.
<i>Template Edit</i>	Edits the template.
<i>Template UP/LOW</i>	Selects the upper template or the lower template.
<i>Copy from STD</i>	Initializes the template.
<i>Insert Line</i>	Inserts a line.
<i>Delete Line</i>	Deletes a line.

Sort	Sorts template data in ascending order.
Table Init	Initializes the table.
Y Scale [dB/div] 10/5/2	Switches the display screen scale to 10, 5 or 2 dB/div.
Average Times ON/OFF	Sets the averaging count. For the method of average processing, refer to “Average Mode” in the Config → Parameter Setup.

Config

Parameter Setup

Sets the method of measurement, edits the template, and so forth.

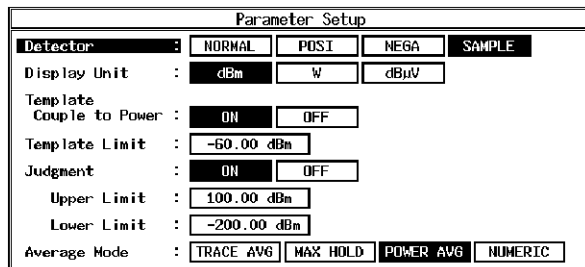

Figure 3-3 Parameter Setup Dialog Box

Detector	NORMAL/POSI/NEGA/SAMPLE Sets the detector.
Display Unit	dBm/W/dBµV Sets the display unit.
Template Couple to Power	Displays the template that is connected to the measured power. ON: Displays the template that is connected to the measured power. On the template edit screen, set the template level to the portion linked with the power value set to 0 dB. OFF: Displays the template regarding the Y-axis value edited by the template as an absolute value.
Template Limit	If the absolute value of the template is smaller than this value when Template Couple to Power is set to ON, clip the template at this value.
Judgment	Sets ON/OFF for Pass/Fail judgments.
Upper Limit	Sets the upper limit value of power.
Lower Limit	Sets the lower limit value of power.
Average Mode	Selects the processing method when Average Times is set to ON.

3.3 Functional Description

TRACE AVG:

Calculates arithmetic average of the measured data (Log data) in the mode LOG.

MAX HOLD:

Displays the maximum value within the average counts of the swept waveforms.

POWER AVG:

Converts the measured data (Log data) to the linear data to take the root mean square value.

NUMERIC:

Converts the measured data (Log data) to the linear data to take the root mean square value.

Using POWER AVG displays the average waveforms, using NUMERIC displays the swept waveforms and takes an average of the measurement results only.

Set to STD

Returns measurement parameters to the values specified by the communication standard.

3.3.2.2 ON/OFF Ratio

Measures the power during the burst-on period and the one during the burst-off period, and calculate the ratio of the powers.

Captures the signal with a trigger and calculates the ratio in reference to the burst on and burst off periods (the former is defined as the period immediately before the trigger point; the latter, immediately after the trigger point).

Auto Level Set

Sets the internal reference level to an optimum value in accordance with the measurement signal. The reference level is automatically adjusted when this key is pressed.

NOTE: The signal level must remain constant while Auto Level Set is being carried out.

Trigger Setup

Sets a trigger.

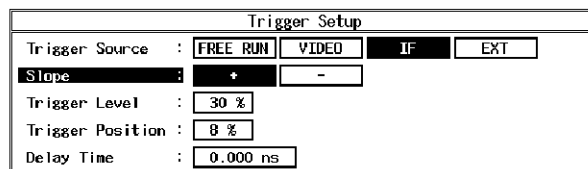

Figure 3-4 Trigger Setup Dialog Box

Trigger Source

Selects a trigger.

FREE RUN:

Captures data using the internal measurement timing.

VIDEO: Captures the signal in sync with the VIDEO signal.

	IF:	Captures the signal in sync with the IF signal (the leading edge of the burst).
	EXT:	Captures the signal in sync with the external trigger signal.
Slope		Selects the edge when triggering.
	+:	Triggers at the leading edge.
	-:	Triggers at the trailing edge.
Trigger Level		Sets the level to trigger.
Trigger Position		Sets where the trigger position is displayed on the screen.
Delay Time		Sets a delay time from the time a trigger signal is detected to the time the signal is captured.
<hr/>		
<i>NOTE: When Delay Time is a negative value, signals before the trigger can be captured.</i>		
<hr/>		
Window Setup		Sets the burst ON and OFF periods.
Window ON/OFF		Displays a window showing the range for power measurement.
Set to STD		Sets the value that is specified by or complies with the communication standard.
ON Position		Sets the desired position during the burst-on period.
ON Width		Sets the desired width during the burst-on period.
OFF Position		Sets the position during the burst-off period.
OFF Width		Sets the width during the burst-off period.
<hr/>		
<i>NOTE: When the window is partially outside the display, an arrow is shown next to Pose, Width or both in the area indicating the window conditions.</i>		
<hr/>		
Y Scale [dB/div] 10/5/2		Selects the display screen scale to 10, 5 or 2 dB/div.
Average Times ON/OFF		Sets the averaging count. For the method of average processing, refer to “Average Mode” in the Config → Parameter Setup.
Config		

3.3 Functional Description

Parameter Setup

Sets measurement parameters and so on.

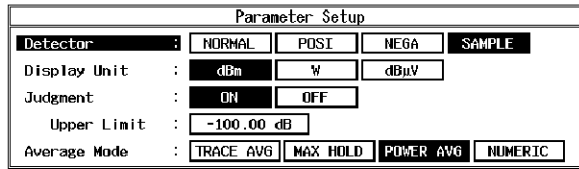

Figure 3-5 Parameter Setup Dialog Box

Detector NORMAL/POSI/NEGA/SAMPLE
Selects the detector.

Display Unit dBm/W/dBμV
Sets the display unit of power.

NOTE: The ON/OFF ratio is displayed in units of dB (fixed).

Judgment Sets ON/OFF of the Pass/Fail judgment for the ON/OFF ratio.

Upper Limit Enters the upper limit value.

Average Mode Selects the processing method when Average Times is set to ON.

TRACE AVG:

Calculates arithmetic average of the measured data (Log data) in the mode LOG.

MAX HOLD:

Displays the maximum value within the average counts of the swept waveforms.

POWER AVG:

Converts the measured data (Log data) to the linear data to take the root mean square value.

NUMERIC:

Converts the measured data (Log data) to the linear data to take the root mean square value.

Using POWER AVG displays the average waveforms, using NUMERIC displays the swept waveforms and takes an average of the measurement results only.

Set to STD

Sets measurement parameters to the values specified by the communication standard.

3.3.2.3 Spurious (T-Domain)

This is a function to measure power (or peak power) according to the frequency specified in the table by sweeping in the zero span mode.

Auto Level Set

Sets the internal reference level to an optimum value in accordance with the measurement signal. The reference level is automatically adjusted when this key is pressed.

NOTE: The signal level must be constant while Auto Level Set is being carried out.

Trigger Setup

Sets a trigger.

Trigger Setup	
Trigger Source :	FREE RUN <input type="checkbox"/> WIDENED <input type="checkbox"/> IF <input checked="" type="checkbox"/> EXT <input type="checkbox"/>
Slope :	+ <input checked="" type="checkbox"/> - <input type="checkbox"/>
Trigger Level :	30 %
Trigger Position :	0 %
Delay Time :	0.000 ns

Figure 3-6 Trigger Setup Dialog Box

Trigger Source

Selects a trigger.

FREE RUN:

Captures data using the internal measurement timing.

IF: Captures the signal in sync with the IF signal (the leading edge of the burst).

EXT: Captures the signal in sync with the external trigger signal.

Slope

Selects the edge when triggering.

+: Triggers at the leading edge.

-: Triggers at the trailing edge.

Trigger Level

Sets the level to trigger.

Trigger Position

Sets where the trigger position is displayed on the screen.

Delay Time

Sets a delay time from the time a trigger signal is detected to the time the signal is captured.

NOTE: When Delay Time is a negative value, signals before the trigger can be captured.

Table No. 1/2/3

Selects the measurement table.

3.3 Functional Description

Load Table	Loads the measurement table.
Table Edit	Edits the measurement table.
Table No. 1/2/3	Selects the table to be edited.
Load Table	Loads the measurement table.
Save Table	Saves the measurement table.
Insert Line	Inserts additional frequency data before the selected frequency number.
Delete Line	Deletes the selected line.
Table Init	Initializes the table.
Average Times ON/OFF	Sets the averaging count. For the method of average processing, refer to “Average Mode” in the Config → Parameter Setup.

Config

Parameter Setup

Sets measurement conditions and so on.

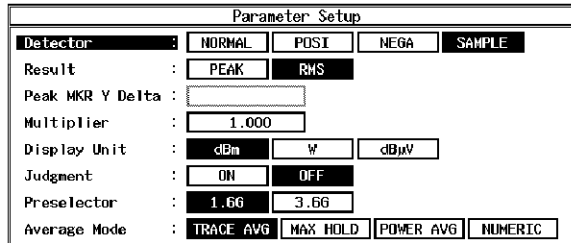

Figure 3-7 Parameter Setup Dialog Box

Detector	NORMAL/POSI/NEGA/SAMPLE Sets the detector.
Result	PEAK/RMS Sets whether to display the result using average power or peak power.
Peak MKR Y Delta	Sets the Y delta of the peak marker.
Multiplier	Multiplies the measurement result by the set value, then displays the resultant value.
Display Unit	dBm/W/dBμV Sets the display units.

Judgment Sets ON/OFF of the Pass/Fail judgment for the limit value.

Preselector Sets the preselector.

NOTE: This menu is displayed on R3267 only.

1.6G: Used to measure harmonics of more than 1.6 GHz or spurious signals when the carrier frequency is lower than 1.6 GHz.

3.6G: Used to set this parameter for cases other than that above.

Average Mode Selects the processing method when Average Times is set to ON.

TRACE AVG:

Calculates arithmetic average of the measured data (Log data) in the mode LOG.

MAX HOLD:

Displays the maximum value within the average counts of the swept waveforms.

POWER AVG:

Converts the measured data (Log data) to the linear data to take the root mean square value.

NUMERIC:

Converts the measured data (Log data) to the linear data to take the root mean square value.

Using POWER AVG displays the average waveforms, using NUMERIC displays the swept waveforms and takes an average of the measurement results only.

Set to Default

Returns the set value to the default.

3.3.3 F-Domain

Carries out a measurement according to the communication standard using the spectrum analyzer's sweep measurement method. Measurement items include power, occupied bandwidth, ACP Due To Transient, ACP Due to Modulation, Inband Spurious, and Outband Spurious measurements in the frequency domain.

In F-Domain measurement, the setting for the RBW, VBW, Sweep Time, or Detector is saved when exiting each measurement and recalled when entering each measurement again. To return the setting to the value specified by the standard, press **Config** and **Set to STD**.

3.3.3.1 Power (F-Domain)

This is a function to measure power in the frequency domain using the spectrum analyzer.

Auto Level Set

Sets the internal reference level to an optimum value in accordance with the measurement signal. The reference level is automatically adjusted when this key is pressed.

3.3 Functional Description

NOTE: The signal level must be constant while Auto Level Set is being carried out.

Gate Setup

Sets the gated sweep.
 This setting is required when the input signal is a bursted signal and Sample Detector is used.

Trigger Setup

Sets a trigger.

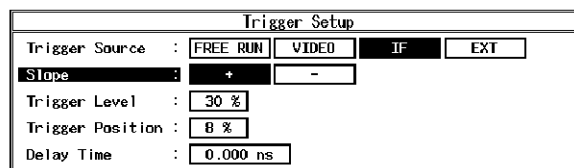

Figure 3-8 Trigger Setup Dialog Box

Trigger Source

Selects a trigger.

FREE RUN:

Captures data using the internal measurement timing.

VIDEO: Captures the signal in sync with the VIDEO signal.

IF: Captures the signal in sync with the IF signal (the leading edge of the burst).

EXT: Captures the signal in sync with the external trigger signal.

Slope

Selects the edge when triggering.

+: Triggers at the leading edge.

-: Triggers at the trailing edge.

Trigger Level

Sets the level to trigger.

Trigger Position

Sets where the trigger position is displayed on the screen.

Delay Time

Sets a delay time from the time a trigger signal is detected to the time the signal is captured.

NOTE: When Delay Time is a negative value, signals before the trigger can be captured.

Gate Source

Trigger

Sets Trigger Source specified by Trigger Setup as Gate Source.

NOTE: When Trigger Source is set to IF and SPAN is set to a frequency higher than 6 MHz, the sweeping seems to be stopped, because the IF trigger bandwidth is approximately 6 MHz and the gate trigger is failing.

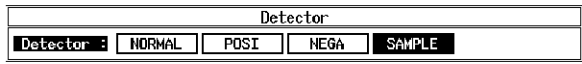
<i>Ext Gate</i>	Sets the gated sweep mode using the gate signal input from the EXT GATE terminal on the rear panel.
<i>Gate Setup</i>	Sets the gated sweep range when Trigger is selected for Gate Source.
<i>Set to STD</i>	Sets the gate position and width to the values specified by the communication standard.
<i>Gate Position</i>	Sets the gate position.
<i>Gate Width</i>	Sets the gate width.
<i>Gated Sweep ON/OFF</i>	Starts the gated sweep.
<i>Detector</i>	NORMAL/POSI/NEGA/SAMPLE Selects the detector.
	
	Figure 3-9 Detector Dialog Box
<i>Window Setup</i>	Sets the frequency range used for power measurement.
<i>Window ON/OFF</i>	Sets the window to ON or OFF. When the window is set to OFF, the power measurement range becomes a sweep band.
<i>Set to STD</i>	Sets the value determined by the communication standard.
<i>Window Position</i>	Sets the position of the window.
<i>Window Width</i>	Sets the width of the window.

NOTE: When the window is partially outside the display, an arrow is shown next to Pose, Width or both in the area indicating the window conditions.

<i>Y Scale [dB/div] 10/5/2</i>	Sets the display scale.
<i>Average Times ON/OFF</i>	Sets the averaging count. For the method of average processing, refer to “Average Mode” in the Config → Parameter Setup.

3.3 Functional Description

Config

Parameter Setup

Sets measurement conditions and so on.

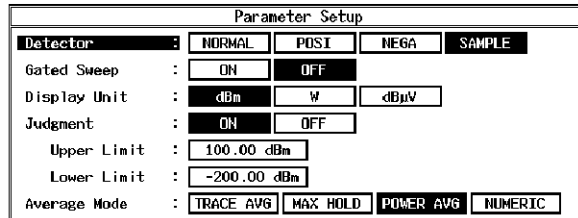

Figure 3-10 Parameter Setup Dialog Box

- Detector*** NORMAL/POSI/NEGA/SAMPLE
Selects the detector.

- Gated Sweep*** Sets the gated sweep to ON or OFF.

- Display Unit*** dBm/W/dBμV
Selects the display unit.

- Judgment*** Sets ON/OFF of the Pass/Fail judgment for measured power.

- Upper Limit*** Sets the upper limit for Pass/Fail judgment.

- Lower Limit*** Sets the lower limit for Pass/Fail judgment.

- Average Mode*** selects the processing method when Average Times is set to ON.
 TRACE AVG:
 Calculates arithmetic average of the measured data (Log data) in the mode LOG.
 MAX HOLD:
 Displays the maximum value within the average counts of the swept waveforms.
 POWER AVG:
 Converts the measured data (Log data) to the linear data to take the root mean square value.
 NUMERIC:
 Converts the measured data (Log data) to the linear data to take the root mean square value.
 Using POWER AVG displays the average waveforms, using NUMERIC displays the swept waveforms and takes an average of the measurement results only.

Set to STD

Sets the measurement parameters to the values specified by the communication standard.

3.3.3.2 OBW

Measure an occupied bandwidth.

Auto Level Set

Sets the internal reference level to an optimum value in accordance with the measurement signal. The reference level is automatically adjusted when this key is pressed.

NOTE: The signal level must be constant while Auto Level Set is being carried out.

OBW%

Sets the frequency, including the percentage of the total power as an occupied bandwidth, when calculating the occupied bandwidth.

Average Times ON/OFF

Sets the averaging count.
For the method of average processing, refer to “Average Mode” in the Config → Parameter Setup.

Config

Parameter Setup

Sets measurement conditions and so on.

Parameter Setup	
Detector :	NORMAL POSI NEGA SAMPLE
Judgment :	ON OFF
Upper Limit :	2.50 MHz
Lower Limit :	750 kHz
Average Mode :	TRACE AVG MAX HOLD POWER AVG NUMERIC

Figure 3-11 Parameter Setup Dialog Box

Detector

NORMAL/POSI/NEGA/SAMPLE
Selects the detector.

Judgment

Sets ON/OFF of the Pass/Fail judgment for the occupied bandwidth.

Upper Limit

Sets the upper limit for Pass/Fail judgment.

Lower Limit

Sets the lower limit for Pass/Fail judgment.

Average Mode

selects the processing method when Average Times is set to ON.
TRACE AVG:

Calculates OBW based on the waveforms, which were generated as a result of arithmetic average of the measured data (Log data) in the log mode.

3.3 Functional Description

MAX HOLD:

Calculates OBW based on the waveform with the maximum value within the average counts of the measured data.

POWER AVG:

Calculates OBW based on the waveforms, which were calculated as a result of the conversion of the measured data (Log data) to the linear data to take the room mean square.

NUMERIC:

Calculates OBW by sweep and calculates arithmetic average to display the result. The displayed waveforms are not averaged.

Set to STD

Sets the measurement parameters to the values specified by the communication standard.

3.3.3.3 Due to Transient

This is a function to measure the spectrum, including the rise and fall times of the burst.

Auto Level Set

Sets the internal reference level to an optimum value in accordance with the measurement signal. The reference level is automatically adjusted when this key is pressed.

NOTE: The signal level must be constant while Auto Level Set is being carried out.

Template

Sets and edits the template.

For more information, refer to Section 5.1.2, "Template Setting in the F-Domain Measuring Mode."

Template ON/OFF

Sets ON/OFF of the template display.

When Template is set to ON, the Pass/Fail judgment for the template is displayed under the sweep screen.

Shift X

Shifts the set template in the frequency direction (X-axis).

Shift Y

Shifts the set template in the level direction (Y-axis).

Margin ΔX ON/OFF

Magnifies the template in the X-axis direction with a set template frequency 0 as the center.

Template Edit

Opens the template edit menu.

Copy from STD

Copies the template defined in the communication standard.

Insert Line

Inserts a line before the selected line.

<i>Delete Line</i>	Deletes the selected line.
<i>Sort</i>	Sorts the tables in order of frequency.
<i>Table Init</i>	Initializes the table.
Marker Edit	Sets the measurement frequency (frequency offset) and measurement band. For more information, refer to Section 5.2.1, “Marker Edit Function.”
<i>Copy from STD</i>	Sets to the parameters specified by the communication standard.
<i>Insert Line</i>	Inserts a line before the selected line.
<i>Delete Line</i>	Deletes the selected line.
<i>Sort</i>	Sorts data in order of frequency.
<i>Table Init</i>	Initializes the table.
Average Times ON/OFF	Sets the averaging count. For the method of average processing, refer to “Average Mode” in the Config → Parameter Setup.

Config

Parameter Setup

Sets measurement conditions and so on.

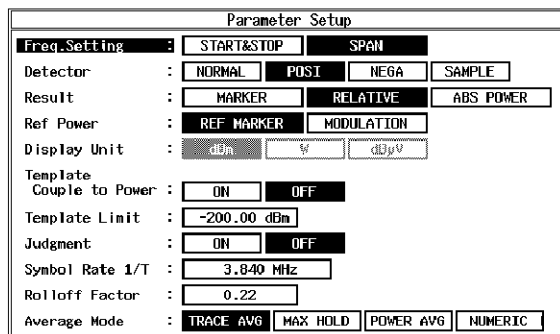

Figure 3-12 Parameter Setup Dialog Box

<i>Freq. Setting</i>	START&STOP/SPAN Selects the measurement mode.
<i>Detector</i>	NORMAL/POSI/NEGA/SAMPLE Selects the detector.
<i>Result</i>	Specifies how to display the result. For more information, refer to Section 5.2.2, “Measurement results Using Due to Modulation, Due to Transient and Inband Spurious Modes.”

3.3 Functional Description

MARKER:
 Displays the marker read value. The position of the marker is set by Marker Edit.

RELATIVE:
 Displays the marker read value using a relative value.

ABS POWER:
 Converts the value displayed by RELATIVE into the absolute value using carrier power and displays it.

Ref Power When RELATIVE is selected for Result, this selects which relative value to use to display the marker read value.

REF MARKER:
 Displays a relative value to Ref Marker set by Marker Edit.

MODULATION:
 Displays a relative value to the measurement result of Tx power in Modulation.

Display Unit dBm/W/dBμV
 Specifies the unit of the result displayed.

NOTE: When RELATIVE is selected for Result, the unit is dB.

Template Couple to Power Sets whether to raise or lower the template with the power set by Ref Power.

Template Limit If the absolute value of the template is smaller than this value when Template Couple to Power is set to ON, clip the template at this value.

Judgment Used to make the Pass/fail judgment for the limit value set by Marker edit. The Pass/Fail judgment result is displayed under the display screen together with the marker list.

Symbol Rate 1/T Sets the symbol rate of the Root Nyquist filter.

Rolloff Factor Sets the roll-off of the Root Nyquist filter.

Average Mode Selects the processing method when Average Times is set to ON.

TRACE AVG:
 Calculates arithmetic average of the measured data (Log data) in the mode LOG.

MAX HOLD:
 Displays the maximum value within the average counts of the swept waveforms.

POWER AVG:

Converts the measured data (Log data) to the linear data to take the root mean square value.

NUMERIC:

Converts the measured data (Log data) to the linear data to take the root mean square value.

Using POWER AVG displays the average waveforms, using NUMERIC displays the swept waveforms and takes an average of the measurement results only.

Set to STD

Returns the measurement parameters to the values specified by the standard.

3.3.3.4 Due to Modulation

Measure the modulation spectrum excluding the rise and fall of the burst.

Auto Level Set

Sets the internal reference level to an optimum value in accordance with the measurement signal. The reference level is automatically adjusted when this key is pressed.

NOTE: The signal level must be constant while Auto Level Set is being carried out.

Gate Setup

Sets the gated sweep.

Trigger Setup

Sets a trigger.

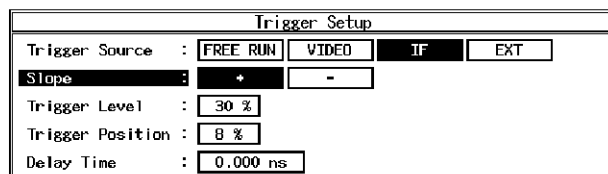

Figure 3-13 Trigger Setup Dialog Box

Trigger Source

Selects a trigger.

FREE RUN:

Captures data using the internal measurement timing.

VIDEO: Captures the signal in sync with the VIDEO signal.

IF: Captures the signal in sync with the IF signal (the leading edge of the burst).

EXT: Captures the signal in sync with the external trigger signal.

Slope

Selects the edge when triggering.

+: Triggers at the leading edge.

-: Triggers at the trailing edge.

3.3 Functional Description

- Trigger Level** Sets the level to trigger.
- Trigger Position** Sets where the trigger position is displayed on the screen.
- Delay Time** Sets a delay time from the time a trigger signal is detected to the time the signal is captured.

NOTE: When Delay Time is a negative value, signals before the trigger can be captured.

Gate Source

- Trigger** Sets Trigger Source specified by Trigger Setup as Gate Source.

NOTE: When Trigger Source is set to IF and SPAN is set to a frequency higher than 6 MHz, the sweeping seems to be stopped, because the IF trigger bandwidth is approximately 6 MHz and the gate trigger is failing.

- Ext Gate** Performs the gated sweep using the gate signal input from the EXT Gate terminal on the rear panel.

- Gate Setup** Sets the gated sweep range when Trigger is selected for Gate Source.

- Set to STD** Sets the gate position and width to the values specified by the communication standard.

- Gate Position** Sets the gate position.

- Gate Width** Sets the gate width.

- Gated Sweep ON/OFF** Starts the gated sweep.

- Detector** NORMAL/POSI/NEGA/SAMPLE
Selects the detector.

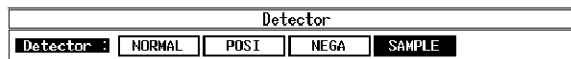

Figure 3-14 Detector Dialog Box

- Template** Sets and edits the template.
For more information, refer to Section 5.1.2, “Template Setting in the F-Domain Measuring Mode.”

<i>Template ON/OFF</i>	Sets the template display to ON or OFF. When Template is set to ON, the Pass/Fail judgment for the template is displayed under the sweep screen.
<i>Shift X</i>	Shifts the set template in the frequency direction (X-axis).
<i>Shift Y</i>	Shifts the set template in the level direction (Y-axis).
<i>Margin ΔX ON/OFF</i>	Magnifies the template in the X-axis direction with a set template frequency 0 as the center.
<i>Template Edit</i>	
<i>Copy from STD</i>	Copies the template defined in the communication standard.
<i>Insert Line</i>	Inserts a line before the selected line.
<i>Delete Line</i>	Deletes the selected line.
<i>Sort</i>	Sorts the tables in frequency order.
<i>Table Init</i>	Initializes the table.
<i>Marker Edit</i>	For more information, refer to Section 5.2.1, “Marker Edit Function.”
<i>Copy from STD</i>	Sets to the parameters specified by the communication standard.
<i>Insert Line</i>	Inserts a line before the selected line.
<i>Delete Line</i>	Deletes the selected line.
<i>Sort</i>	Sorts data in order of frequency.
<i>Table Init</i>	Initializes the table.
<i>Average Times ON/OFF</i>	Sets the averaging count. For the method of average processing, refer to “Average Mode” in the Config → Parameter Setup.
<i>Config</i>	

3.3 Functional Description

Parameter Setup

Sets measurement conditions and so on.

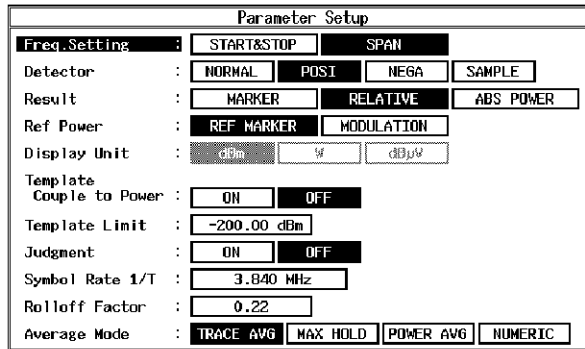

Figure 3-15 Parameter Setup Dialog Box

- Freq. Setting** START&STOP/SPAN
Selects the measurement mode.

- Detector** NORMAL/POSI/NEGA/SAMPLE
Selects the detector.

- Result** Specifies how to display the results.
For more information, refer to Section 5.2.2, “Measurement results Using Due to Modulation, Due to Transient and Inband Spurious Modes.”
MARKER:
 Displays the marker read value. The position of the marker is set by Marker Edit.
RELATIVE:
 Displays the marker read value using a relative value.
ABS POWER:
 Converts the value displayed by RELATIVE into the absolute value using carrier power and displays it.

- Ref Power** When RELATIVE is selected for Result, this selects which relative value to use to display the marker read value.
REF MARKER:
 Displays a relative value to Ref Marker set by Marker Edit.
MODULATION:
 Displays a relative value to the measurement result of Tx power in Modulation.

- Display Unit** dBm/W/dBμV
Selects the display unit.

NOTE: When RELATIVE is selected for Result, the unit is dB.

Template Couple to Power	Sets whether or not to raise or lower the template with the power set by Ref Power.
Template Limit	If the absolute value of the template is smaller than this value when Template Couple to Power is set to ON, clip the template at this value.
Judgment	Used to make the Pass/Fail judgment for the limit value set by Marker edit. The Pass/Fail judgment result is displayed under the display screen together with the marker list.
Symbol Rate 1/T	Sets the symbol rate of the Root Nyquist filter.
Rolloff Factor	Sets the roll-off of the Root Nyquist filter.
Average Mode	Selects the processing method when Average Times is set to ON. TRACE AVG: Calculates arithmetic average of the measured data (Log data) in the mode LOG. MAX HOLD: Displays the maximum value within the average counts of the swept waveforms. POWER AVG: Converts the measured data (Log data) to the linear data to take the root mean square value. NUMERIC: Converts the measured data (Log data) to the linear data to take the root mean square value. Using POWER AVG displays the average waveforms, using NUMERIC displays the swept waveforms and takes an average of the measurement results only.
Set to STD	Returns the measurement parameters to the values specified by the standard.

3.3.3.5 Inband Spurious(1)

This is a function to search for a peak by sweeping the set frequency.

Auto Level Set	Sets the internal reference level to an optimum value in accordance with the measurement signal. The reference level is automatically adjusted when this key is pressed.
-----------------------	--------------------------------------------------------------------------------------------------------------------------------------------------------------------------

NOTE: The signal level must be constant while Auto Level Set is being carried out.

3.3 Functional Description

Template	For more information, refer to Section 5.1.2, “Template Setting in the F-Domain Measuring Mode.”
Template ON/OFF	Sets the template display to ON or OFF. When Template is set to ON, the Pass/Fail judgment for the template is displayed under the sweep screen.
Shift X	Shifts the set template in the frequency direction (X-axis).
Shift Y	Shifts the set template in the level direction (Y-axis).
Margin ΔX ON/OFF	Magnifies the template in the X-axis direction with a set template frequency 0 as the center.
Template Edit	For more information, refer to Section 5.1.2, “Template Setting in the F-Domain Measuring Mode.”
Copy from STD	Copies the template defined in the communication standard.
Insert Line	Inserts a line before the selected line.
Delete Line	Deletes the selected line.
Sort	Sorts the tables in frequency order.
Table Init	Initializes the table.
Marker Edit	For more information, refer to Section 5.2.1, “Marker Edit Function.”
Copy from STD	Sets to the parameters specified by the communication standard.
Insert Line	Inserts a line before the selected line.
Delete Line	Deletes the selected line.
Sort	Sorts data in order of frequency.
Table Init	Initializes the table.
Average Times ON/OFF	Sets the averaging count. For the method of average processing, refer to “Average Mode” in the Config → Parameter Setup.
Config	

Parameter Setup

Sets measurement conditions and so on.

Parameter Setup	
Freq. Setting :	START&STOP SPAN
Detector :	NORMAL POST NEGA SAMPLE
Peak MKR Y Delta :	0.5 div
Result :	MARKER RELATIVE ABS POWER
Ref Power :	REF MARKER MODULATION
Display Unit :	dBm W dBμV
Template Couple to Power :	ON OFF
Template Limit :	-100.00 dBm
Judgment :	ON OFF
Average Mode :	TRACE AVG MAX HOLD POWER AVG

Figure 3-16 Parameter Setup Dialog Box

Freq. Setting	START&STOP/SPAN Selects the measurement mode.
Detector	NORMAL/POST/NEGA/SAMPLE Selects the detector.
Peak MKR Y Delta	Sets the Y delta of the peak marker.
Result	Specifies how to display the results. For more information, refer to Section 5.2.3, "Measurement Result of Inband Spurious." MARKER: Displays the marker read value. The position of the marker is set by Marker Edit. RELATIVE: Displays the marker read value using a relative value. ABS POWER: Converts the value displayed by RELATIVE into the absolute value using carrier power and displays it.
Ref Power	When RELATIVE is selected for Result, this selects which relative value is used to display the marker read value. REF MARKER: Displays a relative value to Ref Marker set by Marker Edit. MODULATION: Displays a relative value to the measurement result of Tx power in Modulation.
Display Unit	dBm/W/dBμV Selects the display unit.

3.3 Functional Description

NOTE: When RELATIVE is selected for Result, the unit is dB.

Template Couple to Power

Sets whether or not to raise or lower the template with the power set by Ref Power.

Template Limit

If the absolute value of the template is smaller than this value when Template Couple to Power is set to ON, clip the template at this value.

Judgment

Used to make the Pass/Fail judgment for the limit value set by Marker edit. The Pass/Fail judgment result is displayed under the display screen together with the marker list.

Average Mode

Selects the processing method when Average Times is set to ON.

TRACE AVG:

Calculates arithmetic average of the measured data (Log data) in the mode LOG.

MAX HOLD:

Displays the maximum value within the average counts of the swept waveforms.

POWER AVG:

Converts the measured data (Log data) to the linear data to take the root mean square value.

Set to STD

Returns the measurement parameters to the values specified by the standard.

3.3.3.6 Inband Spurious(2)

Converts resolution bandwidth (RBW) to search spurious signal.

When the spurious is swept with broadband RBW near the carrier frequency, the carrier signal cannot be separated, which makes the spurious search impossible. In this situation, the sweep with narrow RBW is required to calculate the bandwidth in order to search spurious signal.

Auto Level Set

Sets the internal reference level to an optimum value in accordance with the measurement signal. The reference level is automatically adjusted when this key is pressed.

NOTE: The signal level must be constant while Auto Level Set is being carried out.

Template

For more information, refer to Section 5.1.2, "Template Setting in the F-Domain Measuring Mode."

<i>Template ON/OFF</i>	Sets the template display to ON or OFF. When Template is set to ON, the Pass/Fail judgment for the template is displayed under the sweep screen.
<i>Shift X</i>	Shifts the set template in the frequency direction (X-axis).
<i>Shift Y</i>	Shifts the set template in the level direction (Y-axis).
<i>Margin ΔX ON/OFF</i>	Magnifies the template in the X-axis direction with a set template frequency 0 as the center.
<i>Template Edit</i>	For more information, refer to Section 5.1.2, "Template Setting in the F-Domain Measuring Mode."
<i>Copy from STD</i>	Copies the template specified by the communication standard.
<i>Insert Line</i>	Inserts a line before the selected line.
<i>Delete Line</i>	Deletes the selected line.
<i>Sort</i>	Sorts the tables in frequency order.
<i>Table Init</i>	Initializes the table.
<i>Marker Edit</i>	For more information, refer to Section 5.2.1, "Marker Edit Function."
<i>Copy from STD</i>	Sets the measurement parameters specified by the communication standard.
<i>Insert Line</i>	Inserts a line before the selected line.
<i>Delete Line</i>	Deletes the selected line.
<i>Sort</i>	Sorts data in order of frequency.
<i>Table Init</i>	Initializes the table.
<i>Average Times ON/OFF</i>	Sets the averaging count.
<i>Config</i>	
<i>Parameter Setup</i>	Sets measurement conditions and so on.

3.3 Functional Description

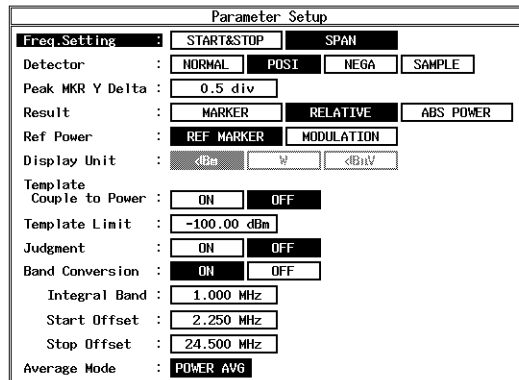

Figure 3-17 Parameter Setup Dialog Box

- Freq. Setting*** START&STOP/SPAN
Selects the measurement mode.
- Detector*** NORMAL/POSI/NEGA/SAMPLE
Selects the detector.
- Peak MKR Y Delta*** Sets the Y delta of the peak marker.
- Result*** Specifies how to display the results.
For more information, refer to Section 5.2.3, “Measurement Result of Inband Spurious.”
MARKER:
 Displays the marker read value. The position of the marker is set by Marker Edit.
RELATIVE:
 Displays the marker read value using a relative value.
ABS POWER:
 Converts the value displayed by RELATIVE into the absolute value using carrier power and displays it.
- Ref Power*** When RELATIVE is selected for Result, this selects which relative value is used to display the marker read value.
REF MARKER:
 Displays a relative value to Ref Marker set by Marker Edit.
MODULATION:
 Displays a relative value to the measurement result of Tx power in Modulation.
- Display Unit*** dBm/W/dBμV
Selects the display unit.

NOTE: When RELATIVE is selected for Result, the unit is dB.

Template Couple to Power

Sets whether or not to raise or lower the template with the power set by Ref Power.

Template Limit

If the absolute value of the template is smaller than this value when Template Couple to Power is set to ON, clip the template at this value.

Judgment

Used to make the Pass/Fail judgment for the limit value set by Marker edit. The Pass/Fail judgment result is displayed under the display screen together with the marker list.

Band Conversion

This function is used to calculate the resolution bandwidth using the swept waveforms.

ON: Calculates resolution bandwidth using the measured data.

OFF: Does not calculate resolution bandwidth using the measured data.

Integral Band

Sets resolution bandwidth that conducts the bandwidth calculation.

Start Offset

Sets the starting frequency that conducts the bandwidth calculation, using the offset frequency from the center frequency.

Stop Offset

Sets the ending frequency that conducts the band calculation, using the offset frequency from the center frequency.

NOTE: Even when the Start Offset and Stop Offset values have been set beyond the frequency display range, data is calculated within the frequency display range.

Average Mode

Sets the processing when Average Times is set to ON. POWER AVG is fixed.

POWER AVG:

Converts the measured data (Log data) to the linear data to take the root mean square

Set to STD

Returns the measurement parameters to the values specified by the standard.

3.3.3.7 Outband Spurious

This is a function to search for a peak by sweeping the frequency according to the table.

3.3 Functional Description

Auto Level Set Sets the internal reference level to an optimum value in accordance with the measurement signal. The reference level is automatically adjusted when this key is pressed.

NOTE: The signal level must be constant while Auto Level Set is being carried out.

Table No. 1/2/3 Selects the table number.

Load Table Loads the table.

Table Edit Edits the table.

Copy from STD Sets measurement parameters to the communication standard.

Table No. 1/2/3 Selects the table number.

Load Table Loads the table.

Save Table Saves the table.

Insert Line Inserts a line before the selected line.

Delete Line Deletes the selected line.

Table Init Initializes the table.

Average Times ON/OFF Sets the averaging count.
For the method of average processing, refer to “Average Mode” in the Config → Parameter Setup.

Config

Parameter Setup Sets measurement conditions and so on.

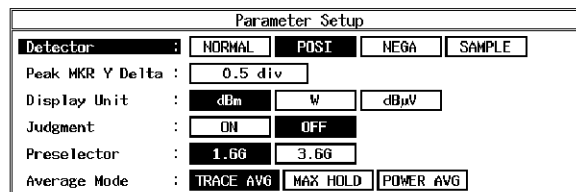

Figure 3-18 Parameter Setup Dialog Box

Detector NORMAL/POSI/NEGA/SAMPLE
Sets the detector.

Peak MKR Y Delta
Sets the Y delta of a peak marker.

<i>Display Unit</i>	dBm/W/dB μ V Sets the display unit.
<i>Judgment</i>	Makes the Pass/Fail judgment using the limit values set by Table Edit.
<i>Preselector</i>	Sets the preselector.

NOTE: This menu is displayed on R3267 only.

- 1.6G: The preselector is activated for frequencies of 1.6 GHz or higher only.
If the carrier frequency is less than 1.6 GHz, selecting this item allows you to measure harmonics of 1.6 GHz or higher.
- 3.6G: Used to set this parameter for cases other than that above.

<i>Average Mode</i>	Selects the processing method when Average Times is set to ON. TRACE AVG: Calculates arithmetic average of the measured data (Log data) in the mode LOG. MAX HOLD: Displays the maximum value within the average counts of the swept waveforms. POWER AVG: Converts the measured data (Log data) to the linear data to take the root mean square value.
---------------------	---------------------------------------------------------------------------------------------------------------------------------------------------------------------------------------------------------------------------------------------------------------------------------------------------------------------------------------------------------------------------

Set to Default Returns the set value to the default.

3.3.4 Modulation

The modulation analysis is performed.

3.3.4.1 Code Domain Power Coef (when FORWARD is set)

The code domain power coefficient of a cdma2000 Forward Link signal is measured.

<i>Auto Level Set</i>	Sets an internal reference level (REF LEVEL) to the optimum value in agreement with the measurement signal.
-----------------------	-------------------------------------------------------------------------------------------------------------

NOTE: The level of an input signal must be constant during the execution of Auto Level Set.

<i>Graphics</i>	Displays a constellation or an eye diagram.
-----------------	---------------------------------------------

3.3 Functional Description

Select Type

Sets the display format. Constellation (Line) and Constellation (Dot) can be set at any time. Other items can be set if EVM of Meas Options is turned on.

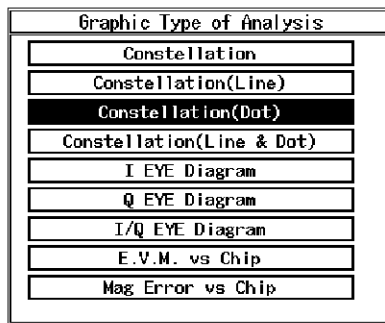

Figure 3-19 Graph Type of Analysis Dialog Box

- Constellation** Displays a constellation graph.
- Constellation(Line)** Display the transition between chips with a line.
- Constellation(Dot)** Display the transition between chips without a line.
- Constellation(Line&Dot)** Displays the transition between chips with connected lines and dots.
- I EYE Diagram** Displays the eye pattern of the I channel.
- Q EYE Diagram** Displays the eye pattern of the Q channel.
- I/Q EYE Diagram** Displays the I channel eye pattern in the upper part of the screen and the Q channel eye pattern in the lower part of the screen.
- E.V.M. vs Chip** Displays EVM for 1 chip.
- Mag Error vs Chip** Displays the magnitude error for 1 chip.

Plot Type

Displays the result of averaging or peak extraction processing in E.V.M. vs Chip or Mag Error vs Chip mode.

- AVG: Performs averaging.
- P-P: Performs peak extraction.

Scale Setup

Switches the result display.

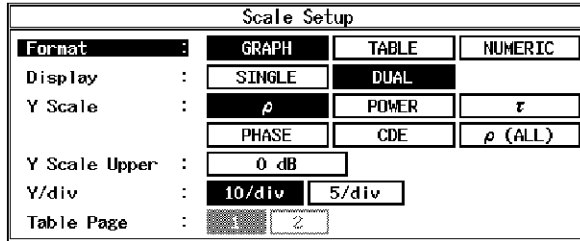

Figure 3-20 Scale Setup Dialog Box

Format

Format dialog box is displayed.

GRAPH: Displays a graph for the code domain power coefficient and the power.

When Auto Rate is set to ON, Channel Define is set to ON, or Bit Reversal Order is set to ON, a blue window is displayed for a channel with a rate that differs from the symbol rate (Walsh code length) of the inactive channel.

TABLE: Displays a list of the code domain power coefficients.

NUMERIC:

Displays the measurement result.

Display

Switches the screen mode between Screen 1 and Screen 2 if Display Format is set to GRAPH.

SINGLE: Displays data on a single screen.

$\Delta\tau$, $\Delta\theta$ and the maximum logarithmic ρ value of the inactive channel is displayed in the lower part of the screen.

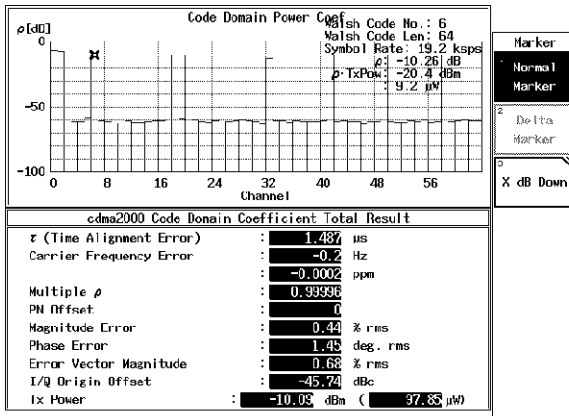

Figure 3-21 DUAL Display Example

3.3 Functional Description

DUAL: Displays data on a dual-screen; displays the graph on the upper screen and the measurement result on the lower screen.
 The measurement values for the time alignment error, carrier frequency error, multiple ρ , PN offset, magnitude error, phase error, error vector magnitude, I/Q origin offset and Tx power are displayed as the measurement result.

Y Scale

Sets the Y Scale unit.
 ρ , POWER and $\rho(\text{ALL})$ can be set at any time. τ , PHASE and CDE can be set if $\Delta\tau$, $\Delta\theta$ and Code Domain Error are turned on, respectively.

ρ : The vertical axis of the graph is in logarithmic value of the code domain power coefficient.
 This display is used to measure the pilot power and code domain power.

POWER: Displays the vertical axis of the graph in units of power.

τ : Displays the vertical axis of the graph as a difference in delay.
 This display is used to measure "Pilot Channel to Code Channel Time Tolerance."

PHASE: Displays the vertical axis of the graph as a difference in phase.
 This display is used to measure "Pilot Channel to Code Channel Phase Tolerance."

CDE: Displays the graph as a measurement value of the code domain error.

$\rho(\text{ALL})$: The vertical axis of the graph is in logarithmic value of the code domain power coefficient.

Y Scale Upper

Specifies the maximum value on the vertical axis of the graph.

Y/div

Selects the vertical axis scale of the graph.

Table Page

Selects the page when Format is set to TABLE.

Parameter Setup

Sets the measurement parameter.

Parameter Setup	
Meas Range	1280 chip
τ Offset	0.000 μ s
Complementary Filter	<input checked="" type="checkbox"/> ON <input type="checkbox"/> OFF
Rolloff Factor	0.05
Equalizing Filter	<input checked="" type="checkbox"/> ON <input type="checkbox"/> OFF
PN Offset Search Mode	<input checked="" type="checkbox"/> ON <input type="checkbox"/> OFF
PN Offset	0
Carrier Freq. Search	<input type="checkbox"/> 500Hz <input checked="" type="checkbox"/> 10kHz <input type="checkbox"/> 500kHz
Trigger Source	<input type="checkbox"/> INT <input checked="" type="checkbox"/> EXT
	<input type="checkbox"/> INTRVL(EXT) <input type="checkbox"/> INTRVL
EXT Trigger Slope	<input checked="" type="checkbox"/> + <input type="checkbox"/> -
Threshold	-27 dB
Auto Rate	<input checked="" type="checkbox"/> ON <input type="checkbox"/> OFF
Channel Define	<input checked="" type="checkbox"/> ON <input type="checkbox"/> OFF
Walsh Code Length	<input type="checkbox"/> 4 <input type="checkbox"/> 8 <input checked="" type="checkbox"/> 16 <input type="checkbox"/> 32 <input type="checkbox"/> 64 <input type="checkbox"/> 128
QOF	<input checked="" type="checkbox"/> 0 <input type="checkbox"/> 1 <input type="checkbox"/> 2 <input type="checkbox"/> 3
Bit Reversal Order	<input checked="" type="checkbox"/> ON <input type="checkbox"/> OFF

Figure 3-22 Setup Example for the Parameter Setup

Meas Range

Sets the measurement range.
A range between 128 and 36864 chips can be set.

 τ Offset

Sets the value by which the trigger position is delayed.
When the time alignment error value previously measured is entered, the value is set to zero on the next time onward.

Complementary Filter

Sets ON or OFF for the complimentary filter as specified by IS-97.

Rolloff Factor

Sets the roll-off factor used to determine the complimentary filter characteristics.
A range of 0.05 to 0.2 can be set.

Equalizing Filter

Sets ON or OFF for the equalizing filter.
Set to ON when the phase characteristics of the base station output are obtained after passing through the phase equalizer.

PN Offset Search Mode

Sets ON or OFF for the PN offset search.
This mode is turned on if the signal satisfies all of the following conditions:
QOFs are all zeros.
The maximum Walsh length is 64.
The PN Offset value of the base station is not known.

PN Offset

Sets the PN offset value of the base station.
Values of 0 through 511 can be set.

Carrier Freq. Search

Sets the search range of the carrier frequency.
The carrier frequency is searched using ranges of ± 500 Hz, ± 10 kHz and ± 500 kHz.

3.3 Functional Description

<i>Trigger Source</i>	<p>Sets the trigger. Input the even second time reference signal to the external trigger connector.</p> <p>INT: Used to capture data using internal timing.</p> <p>EXT: Used to capture data in sync with the external trigger.</p> <p>INTRVL (EXT): Causes the internal counter to generate a trigger signal every 26.6 ms. The internal counter operates in sync with the external trigger signal. This mode can be used if the signal consists of QOFs of all zeros and a maximum Walsh length of 64.</p> <p>INTRVL: Causes the internal counter to generate a trigger signal every 26.6 ms. The internal counter does not operate in sync with the external trigger signal. This mode can be used if the signal consists of QOFs of all zeros and a maximum Walsh length of 64.</p>
<i>EXT Trigger Slope</i>	Used to set the rise and fall times of the external trigger.
<i>Threshold</i>	<p>Sets a threshold value which is used to judge whether or not the channel is active.</p> <p>An active channel judgment is made for each symbol consisting of 64 chips or greater.</p> <hr/> <p><i>NOTE: When a large threshold value is set, an active channel is judged as passive. As a result, ρ and modulation accuracy become worse than actual values, causing incorrect measurements.</i></p> <hr/>
<i>Auto Rate</i>	<p>Turned on if a measurement is made after the rate for each channel has automatically been recognized.</p> <p>The automatic judgment is performed on a channel whose QOF is set to 0.</p> <p>This function is used together with the Channel Define function if the signal contains special control channels such as CPCCH.</p> <p>If Auto Rate and Channel Define are both turned on, the channels specified by Channel Def. Table have higher priority. The rates for other channels are automatically judged.</p> <p>If Auto Rate is turned on, QOF is set to 0, and Bit Reversal Order is turned on.</p>
<i>Channel Define</i>	When measuring a channel set in Channel Def. Table, set this parameter to ON.
<i>Walsh Code Length</i>	Sets the Walsh Code length of the channel to be measured if Auto Rate and Channel Define are turned off.

QOF

When Channel Define is set to ON, the QOF of the channel to be displayed is set in the form of a graph or table.

When the channels with different QOFs are set in Channel Def. Table, only the channel with the set QOF is displayed.

When Channel Define is set to OFF, the QOF of the channel to be measured is set.

For channels other than the Pilot channel and Sync channel, only the channel with the set QOF is measured.

As a result, channels with different QOFs are regarded as noise.

Bit Reversal Order

Set Bit Reversal Order to ON to display the channels in the Bit Reversal (Paley).

When Bit Reversal Order is set to ON while Channel Define is set to ON, bar graphs are displayed at the positions of the channels corresponding with the Bit Reversal order, depending on the Walsh lengths of each channel.

When Bit Reversal Order is set to OFF, channels are displayed in the order set in Channel Def. Table.

When Channel Define is set to OFF, bar graphs are displayed at the channel positions corresponding to the set values of the Walsh code lengths.

Channel Def. Table

Set the name of the channel to be transmitted and the properties (data rate, QOF and Walsh code number) of the signal under measurement in Channel Def. Table.

This channel definition table is enabled if Channel Define in Parameter Setup is set to ON.

No.	Channel	RC	Data Rate	QOF	Length	Num
0	PTCH	-	-	-	128	0
1	SYNCH	-	1200 bps	-	64	32
2	PCH	-	9600 bps	0	64	1
3	FCH	3	9600 bps	0	64	8
4	FCH	3	9600 bps	0	64	9
5	SCH	3	19200 bps	0	32	17
6	SCH	3	19200 bps	0	32	18
7	SCH	3	19200 bps	0	32	19
8	SCH	3	19200 bps	0	32	20

Figure 3-23 Setup Example for the Channel Def. Table

Total

Set the number of channels multiplexed on the signal under measurement.

One through 128 channels can be set in the table.

3.3 Functional Description

<i>Edit</i>	Specify the number of the channel in Channel Def. Table you wish to edit.
<i>Channel</i>	<p>Set the name of the channel to be transmitted with the channel number specified by Edit.</p> <p>The channels that can be set are: PICH, SYNCH, PCH, BCH, CCCH, DCCH, FCH, SCCH, SCH, QPCH, CPCCH and CACH.</p> <p>The abbreviations for the channel names are as follows:</p> <p>PICH: Pilot channel SYNCH: Sync channel PCH: Paging channel BCH: Broadcast channel CCCH: Common Control channel DCCH: Dedicated Control channel FCH: Fundamental channel SCCH: Supplemental Code channel SCH: Supplemental channel QPCH: Quick Paging channel CPCCH: Common Power Control channel CACH: Common Assignment channel</p>
<i>RC</i>	Set the radio configuration of the channel to be transmitted specified by Channel.
<i>Data Rate</i>	<p>Set the data rate of the channel to be transmitted specified by Channel.</p> <p>When the data rate is changed, the Walsh length is changed according to the data rate.</p>
<i>QOF</i>	Set the QOF of the channel to be transmitted specified by Channel.
<i>Walsh Number</i>	Set the Walsh code number of the channel to be transmitted specified by Channel.

NOTE: *When a Walsh code number that does not meet orthogonality between different channels is set, a measurement error will occur.*

Meas Options Sets the optional measurement items.

Meas Options			
CDP Graph Plot Type :	<input checked="" type="radio"/> AVERAGE	<input type="radio"/> MAX	<input type="radio"/> MIN
Power Unit :	<input type="radio"/> dBm	<input type="radio"/> dB	<input checked="" type="radio"/> dBmpilot
Pilot Channel Power :	<input type="text" value="0.0 dBm"/>		
$\Delta\tau$:	<input checked="" type="radio"/> ON	<input type="radio"/> OFF	
$\Delta\theta$:	<input checked="" type="radio"/> ON	<input type="radio"/> OFF	
Code Domain Error :	<input checked="" type="radio"/> ON	<input type="radio"/> OFF	
Signal Power :	<input checked="" type="radio"/> ON	<input type="radio"/> OFF	
EVM :	<input checked="" type="radio"/> ON	<input type="radio"/> OFF	
Fixed Symbols Level :	<input type="radio"/> ON	<input checked="" type="radio"/> OFF	
Chip Rate Error :	<input type="radio"/> ON	<input checked="" type="radio"/> OFF	
IQ Gain Error :	<input type="radio"/> ON	<input checked="" type="radio"/> OFF	
Quadrature Error :	<input type="radio"/> ON	<input checked="" type="radio"/> OFF	

Figure 3-24 Meas Options Setup Example

CDP Graph Plot Type

Sets the display format for POWER and CDE of the code domain power graph.

If Y Scale in Scale Setup is set to POWER and CDE, this function is used to display the average, minimum, maximum values after the code domain power for each symbol in a channel has been measured, the average values have been calculated, and then the maximum and minimum values have been extracted.

AVERAGE:

Averages the power of each symbol that is higher than the set threshold value and displays the averaged power as the code domain power of the channel.

MAX: Displays the maximum power for each symbol.

MIN: Displays the minimum power that is higher than the set threshold value for each symbol.

Power Unit

Sets the display format for POWER and CDE of the code domain power graph.

dBm: Displays the ratio of channel power to AVG Power at Chip measurement value in dBm for each channel.

dB: Display each channel power ratio (dB) rated against the multiplex signal power.

dBmpilot:

Displays each channel power rated against the absolute pilot channel power which is calculated from the Pilot Channel Power setting and the channel power ratio.

Pilot Channel Power

Sets the absolute power of the Pilot channel.

This is a reference power for channel powers calculated when dBm pilot is selected.

 $\Delta\tau$

Measures the delay time for each channel.

Displays the direction in which the channel lags behind the Pilot channel as a plus sign.

3.3 Functional Description

$\Delta\theta$ Measures the phase difference for each channel with reference to the Pilot channel.

Code Domain Error Measures the code domain power for an error signal that is obtained by excluding an ideal signal from the measurement signal.

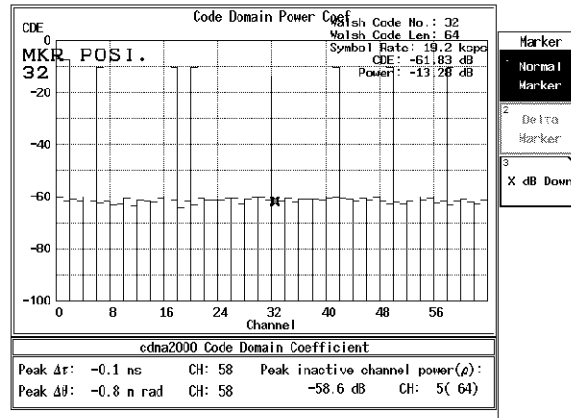

Figure 3-25 Measurement Example for the Code Domain Error

Signal Power Measures the power of the signal within the setting range of Meas Range.

EVM Measures the modulation accuracy. When EVM is set to ON, it measures the magnitude error, phase error, error vector magnitude and I/Q origin offset. In addition, analysis result graphs such as the EYE diagram and E.V.M. vs. Chip graph can be displayed.

Fixed Symbols Level Measures the symbol levels by assuming that the power of each symbol in one channel is constant. When the symbol power changes in the same way as the power control bit of the Fundamental channel, the measured value becomes worse.

Chip Rate Error Measures chip rate error. Error in the unit Hz relative to 1.2288 MHz. Error ratio in the unit ppm relative to 1.2288 Mcps.

IQ Gain Error Measures the gain difference between the I- and Q-axes. The IQ gain error (%) is a ratio of the Q-axis gain to the I-axis gain.

Quadrature Error Measures the orthogonality error of an orthogonal modulator. The angle of deviation of the Q-axis in relation to the I-axis is defined as the angle between the Q-axis and the axis obtained by rotating the I-axis 90 degrees.

3.3.4.2 Code Domain Power (when REVERSE (RC 3 & 4) is set)

This section describes how to measure the power, modulation accuracy and demodulated data of each Walsh channel.

Auto Level Set Adjusts the reference level automatically.

NOTE: *The input signal level must be constant while Auto Level Set is being carried out.*

Graphics Displays a constellation or an eye diagram.

Select Type Selects a graph type.

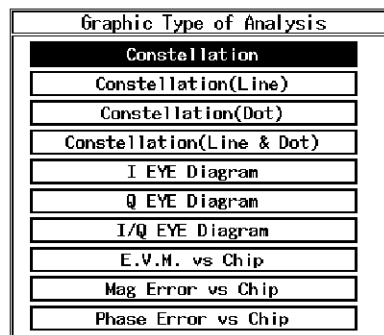

Figure 3-26 Graphic Type of Analysis Dialog Box

Constellation Displays a constellation graph.

Constellation(Line) Uses a line to connect the transition between chips and displays it.

Constellation(Dot) Display the transition between chips without a line.

Constellation(Line&Dot) Displays the transition between chips with connected lines and dots.

I EYE Diagram Displays the eye pattern of the I channel.

Q EYE Diagram Displays the eye pattern of the Q channel.

I/Q EYE Diagram Displays the I channel eye pattern in the upper part of the screen and the Q channel eye pattern in the lower part of the screen.

E.V.M. vs Chip Displays EVM for each chip.

Mag Error vs Chip Displays the magnitude error for each chip.

3.3 Functional Description

Phase Error vs Chip

Displays the phase error for each chip.

Plot Type

Displays the result of averaging or peak extraction processing in E.V.M. vs Chip, Mag Error vs Chip or Phase Error vs Chip mode.

AVG: Performs averaging.

P-P: Performs peak extraction.

Y/div

Allows you to select the vertical scale of a graph.

View Setup

Setting up screen information.

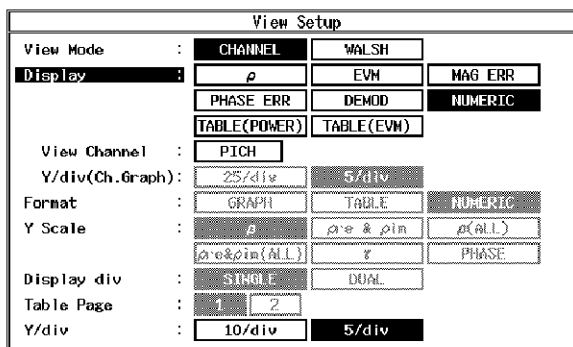

Figure 3-27 View Setup Dialog Box

View Mode

Allows you to select a screen display mode.

CHANNEL:

Displays the test result as a graph with the horizontal axis as the channel name.

WALSH: Displays the test result as a graph with the horizontal axis as the Walsh function (for PRECISE only).

Display

Allows you to select the data to be displayed on the lower screen (if View Mode is set to CHANNEL).

ρ : Displays the code domain power coefficient.

EVM: Displays the graph of Error Vector Magnitude vs Symbol for the specified channel (for PRECISE only).

MAG ERR:

Displays the graph of Magnitude Error vs Symbol for the specified channel (for PRECISE only).

PHASE ERR:

Displays the graph of Phase Error vs Symbol for the specified channel (for PRECISE only).

DEMOD: Displays demodulated data for the specified channel (for PRECISE only).

NUMERIC:

Displays the numerical result for a multiplexed signal.

TABLE (POWER):

Displays the summary list as the numerical result of the power for each channel.

TABLE (EVM):

Displays the summary list as the numerical result of Error Vector Magnitude, Magnitude Error and Phase Error for each channel.

View Channel

The numerical result for the selected channel is displayed on the upper screen. If Display is set to EVM, MAG ERR, PHASE ERR or DEMOD, the graph and demodulated data are displayed for each symbol of the selected channel (if View Mode is set to CHANNEL).

For TCH mode, the channel listed below can be selected.

PICH:	Reverse Pilot Channel
DCCH:	Reverse Dedicated Control Channel
SCH2:	Reverse Supplemental Channel 2
FCH:	Reverse Fundamental Channel
SCH1:	Reverse Supplemental Channel 1

For EACH mode, the channels listed below can be selected.

PICH:	Reverse Pilot Channel
EACH:	Enhanced Access Channel

For CCCH mode, the channels listed below can be selected.

PICH:	Reverse Pilot Channel
CCCH:	Reverse Common Control Channel

Y/div(Ch.Graph)

Select the vertical scale for the lower screen if Display is set to EVM, MAG ERR or PHASE ERR.

Format

Allows you to set a display format (if View Mode is set to WALSH).

GRAPH:	Displays data (such as the code domain power coefficient) as a graph.
TABLE:	Displays data (such as the code domain power coefficient) as a list.
NUMERIC:	Displays the numerical result for multiplexed signals.

Y Scale

Allows you to set the unit for the vertical axis of a graph (if View Mode is set to WALSH).

ρ :	Displays the vertical axis of a graph as the code domain power coefficient.
ρ_{re} & ρ_{im} :	Displays the vertical axis on the upper screen as ρ_{re} (the real part of ρ), and the vertical axis on the lower screen as ρ_{im} (the imaginary part of ρ).

3.3 Functional Description

ρ (ALL): Displays the vertical axis of a graph as the code domain power coefficient. All channels can be specified using a marker.

ρ_{re} & ρ_{im} (ALL): Displays the vertical axis on the upper screen as ρ_{re} , and the vertical axis on the lower screen as ρ_{im} . All channels can be specified using a marker.

τ : Displays the vertical axis of a graph as the delay difference.

PHASE: Displays the vertical axis of a graph as the phase difference.

NOTE: If Y Select is set to ρ_{re} & ρ_{im} or to ρ_{re} & ρ_{im} (ALL), pressing MKR, and then A displays the ρ_{re} marker; pressing MKR, and then B displays ρ_{im} marker.

Display div

Allows you to switch the screen mode between the 1- and 2-screen modes (if View Mode is set to WALSH).

Table Page

Allows you to select a page if Format is set to TABLE (if View Mode is set to WALSH).

Y/div

Allows you to select the vertical scale of a graph.

Channel Setup

Setting up a channel for measurement.

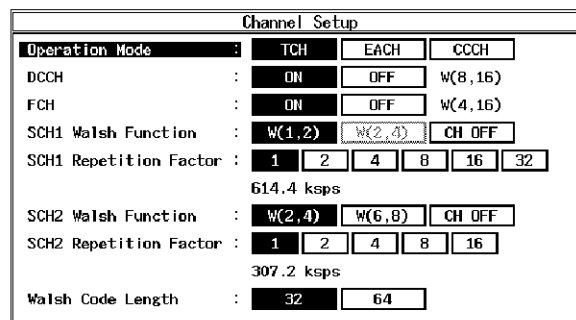

Figure 3-28 Channel Setup Dialog Box

Operation Mode

Selects one of channels listed below for Operation mode.

TCH: Traffic Channel

EACH: Enhanced Access Channel

CCCH: Common Control Channel

DCCH

Sets whether the DCCH transmission status is turned on or off when Operation Mode is set to TCH.

- ON: Sets the conditions under which DCCH data is transmitted.
- OFF: Sets the conditions under which DCCH data is not transmitted.

FCH Sets whether the FCH transmission status is turned on or off when Operation Mode is set to TCH.

- ON: Sets the conditions under which FCH data is transmitted.
- OFF: Sets the conditions under which FCH data is not transmitted.

SCH1 Walsh Function Selects one of the SCH1 (supplemental channel 1) Walsh functions listed below when Operation Mode is set to TCH.

- W(1, 2): W_1^2 is set.
- W(2, 4): W_2^4 is set.
- CH OFF: Sets the conditions under which SCH1 data is not transmitted.

SCH1 Repetition Factor Sets the number of times that the SCH1 (supplemental channel 1) Walsh function is repeated when Operation Mode is set to TCH.

SCH2 Walsh Function Selects one of the SCH2 (supplemental channel 2) Walsh functions listed below when Operation Mode is set to TCH.

- W(2, 4): W_2^4 is set.
- W(6, 8): W_6^8 is set.
- CH OFF: Sets the conditions under which SCH2 data is not transmitted.

NOTE: Both SCH1 and SCH2 Walsh functions cannot be set to W(2, 4). For example, if the SCH2 Walsh function is set to W(2,4), the SCH1 Walsh function cannot be set to W(2,4) as shown in Figure 3-28. If this happens, first set the SCH2 Walsh function to W(6,8) or CH OFF and then set the SCH1 Walsh function to W(2,4).

SCH2 Repetition Factor Sets the number of times that the SCH2 (supplemental channel 2) Walsh function is repeated when Operation Mode is set to TCH.

Walsh Code Length Sets the Walsh function length.

Parameter Setup Sets measurement parameters.

3.3 Functional Description

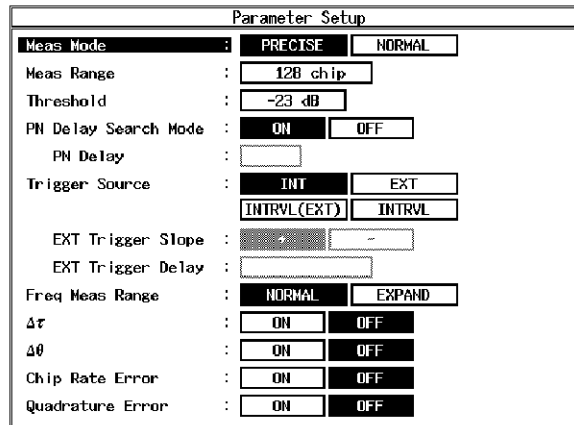

Figure 3-29 Parameter Setup Dialog Box

Meas Mode

Selects a measurement mode.

- PRECISE: Measures the modulation accuracy and demodulation data in addition to the ρ and power ratio for each channel at the same time.
- NORMAL: Measures the ρ and power ratio for each channel.

Meas Range

Enters the measurement range using the number ($64 \times N$) of chips.

Threshold

Sets a threshold level to judge whether or not the channel being measured in PRECISE Mode is an active channel. Set the threshold higher than a noise floor and lower than the signal. In addition, this parameter is used as a reference for judging whether or not there is a signal or a noise in the Estimated ρ measurement.

NOTE: For NORMAL Mode, active channels are displayed as yellow graphs, and inactive channels are displayed as green graphs.
 For PRECISE Mode:
 If View Mode is set to CHANNEL, only active channels are displayed.
 If View Mode is set to WALSH, and if Y Scale is set to $\rho(ALL)$ or ρ_{re} & $\rho_{im}(ALL)$ all channels are displayed as yellow graphs.
 If View Mode is set to WALSH, and if Y Scale is set to ρ or ρ_{re} & ρ_{im} active channels are displayed as yellow graphs and inactive channels are displayed as green graphs.

<i>PN Delay Search Mode</i>	<p>ON: Searches for a PN delay from the captured signal when the relationship between the external trigger and the input signal PN delay is not clear.</p> <p>OFF: Sets the PN delay when the relationship between the external trigger and the input signal PN delay is already known.</p>
<i>PN Delay</i>	Sets a value between 0 and 511 as a synchronization position for the pilot PN sequence.
<i>Trigger Source</i>	<p>INT: Captures data using the internal timing.</p> <p>EXT: Captures data in sync with the external trigger.</p> <p>INTRVL (EXT): Causes the built-in counter to generate a trigger every 26.6 milliseconds. The built-in counter operates in sync with the external trigger.</p> <p>INTRVL: Causes the built-in counter to generate a trigger every 26.6 milliseconds. The built-in counter does not operate in sync with the external trigger.</p>
<i>EXT Trigger Slope</i>	Sets the rise and fall times for the external trigger.
<i>EXT Trigger Delay</i>	Corrects the delay time when the signal (the head of PN) lags behind the external trigger.
<i>Freq Meas Range</i>	Set whether or not to expand the estimated frequency range for measurement.
	<p>NORMAL: Does not expand the measurement range for a frequency error.</p> <p>EXPAND: Expands the estimated range of a frequency error.</p>
$\Delta\tau$	Measures the delay value relative to the pilot channel for each channel.
$\Delta\theta$	Measures the phase difference relative to the pilot channel for each channel.
<i>Chip Rate Error</i>	Measures chip rate error relative to 1.2288 Mcps. Error ratios (ppm) relative to 1.2288 Mcps.
<i>Quadrature Error</i>	Measures the angle between the Q-axis and the axis obtained by rotating the I-axis 90 degrees.
<i>Demod Data Save</i>	Saves the demodulation data to a floppy disk (only when PRECISE is selected).

3.3 Functional Description

Average Times ON/OFF Averaging is performed on the measured data.
This function allows you to set the averaging count.

NOTE: *Peak Inactive ρ , Peak $\Delta\tau$, Peak $\Delta\theta$ in NUMERIC, and EVM PEAK, MAG PEAK, PHASE PEAK in TABLE (EVM) display the measured peak resulting from the measurement counts.*

3.3.4.3 Waveform Quality (when REVERSE (RC1&2) is set)

Measures the waveform quality, frequency error and modulation accuracy of a OQPSK signal that is not “code multiplexed.”

Auto Level Set Adjusts the reference level automatically.

NOTE: *Maintain the signal level constant while Auto Level Set is being executed.*

Graphics Displays constellations and eye diagrams.

Select Type Allows you to select a graphic display format.

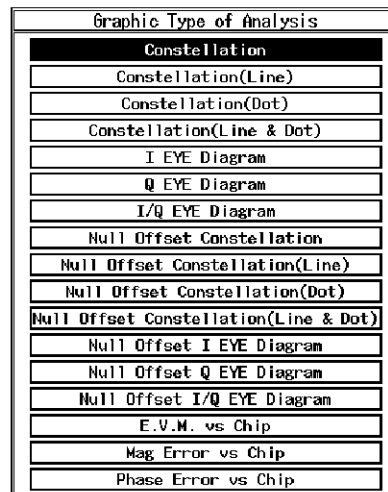

Figure 3-30 Graphic Type of Analysis Dialog Box

Constellation Displays a graph containing constellations.

Constellation(Line) Displays the transition between two adjacent points, 0.5 chips away, using a straight line (connecting the two points).

Constellation(Dot) Displays the transition between two adjacent points, 0.5 chips away, using dots.

Constellation(Line&Dot)

Displays the transition between two adjacent points, 0.5 chips away, using dots and a line (connecting the two points).

I EYE Diagram Displays I channel's eye pattern.

Q EYE Diagram Displays Q channel's eye pattern.

I/Q EYE Diagram Displays I channel's eye pattern on the upper screen, and Q channel's eye pattern on the lower screen simultaneously.

Null Offset Constellation

Displays a constellation graph after I and Q offsets have been reset to zero and filtering has been performed in order to converge chips to one point.

Null Offset Constellation(Line)

Displays changes between two adjacent chips using a straight line that connects the two chips.

Null Offset Constellation(Dot)

Displays changes between two adjacent chips using dots only, without a line that connects the two chips.

Null Offset Constellation(Line&Dot)

Displays changes between two adjacent chips using dots and a line that connects the two chips.

Null Offset I EYE Diagram

Displays an eye pattern of the I channel after I and Q offsets have been reset to zero and filtering has been performed in order to converge chips to one point.

Null Offset Q EYE Diagram

Displays an eye pattern of the Q channel after I and Q offsets have been reset to zero and filtering has been performed in order to converge chips to one point.

Null Offset I/Q EYE Diagram

Null Offset I EYE Diagram is displayed on the upper screen, and Null Offset Q EYE Diagram is displayed on the lower screen simultaneously.

E.V.M. vs Chip Displays EVM every half a chip.

Mag Error vs Chip Displays the magnitude error every half a chip.

Phase Error vs Chip

Displays the phase error every half a chip.

3.3 Functional Description

Plot Type

Displays the result of averaging or peak extraction processing in E.V.M. vs Chip, Mag Error vs Chip or Phase Error vs Chip mode.

AVG: Performs averaging.

P-P: Performs peak extraction.

Parameter Setup

Sets the parameters used for measurements.

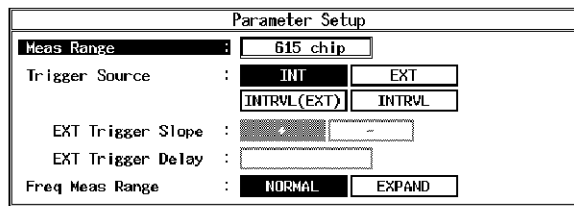

Figure 3-31 Parameter Setup Dialog Box

Meas Range

Enter a measurement range in chips

Trigger Source

INT: Captures data using the internal timing of the instrument.

EXT: Captures data in synchronization with the external trigger.

INTRVL (EXT): The built-in counter, which is synchronized with the external trigger, generates a trigger every 26.6 ms.

INTRVL (INT): The built-in counter, which is not synchronized with the external trigger, generates a trigger every 26.6 ms.

EXT Trigger Slope

Sets the polarity (positive or negative slope) of the external trigger.

EXT Trigger Delay

Compensates for the signal (head of PN) delay in relation to the external trigger.

Freq Meas Range

Sets whether or not to expand the estimated frequency range for measurement.

NORMAL: Does not expand the measurement range of a frequency error.

NOTE: Use this mode when signals exist in the adjacent channels, or when measuring a signal including a large number of noise components.

EXPAND: Expands the estimated range of a frequency error.

Average Times ON/OFF: Averaging is performed on the measured data. This function allows you to set the averaging count.

3.3.4.4 Power

3.3.4.4.1 Tx Power

Measures the power of a modulation signal.

Auto Level Set Sets an internal reference level (REF LEVEL) to the optimum value in agreement with the measurement signal.

NOTE: The level of an input signal must be constant during the execution of Auto Level Set.

Parameter Setup Sets measurement conditions and so on.

Figure 3-32 Parameter Setup Dialog Box

Trigger Source

Selects a trigger signal.

INT: Sweeps in synchronization with an internal trigger signal.

EXT: Sweeps in synchronization with an external trigger signal, which is input from the Ext Trigger connector on the rear panel.

INTRVL (EXT): The built-in counter generates triggers every 26.6 milliseconds. The built-in counter is in sync with the external trigger.

IF: Captures data in synchronization with the IF signal (the leading edge of the burst).

EXT Trigger Slope

Changes the polarity of the trigger slope.

+: Starts sweeping at the leading edge of the trigger.

-: Starts sweeping at the trailing edge of the trigger.

Trigger Level

Sets the trigger level.

EXT Trigger Delay

Corrects the delay time when the signal (the head of PN) lags behind the external trigger.

3.3 Functional Description

NOTE: When a negative value is set, a signal before the trigger can be observed.

Average Times ON/OFF

Selects an averaging process.

ON: Activates the number of times of averaging and performs averaging the specified number of times.

OFF: Does not perform an averaging process.

NOTE: Peak Factor obtained as a result of a power measurement calculates the peak power and average power within the measurement counts.

3.3.4.4.2 CCDF

The CCDF (Complementary Cumulative Distribution Function), average power and peak factor of the signal under measurement can be measured.

Auto Level Set

Automatically adjusts the reference level.

Scale Setup

Switches between measurement results.

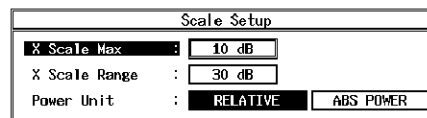

Figure 3-33 Scale Setup Dialog Box

X Scale Max

Sets the maximum value along the horizontal axis between -20 dB(m) and 70 dB(m) in steps of 10 dB.

X Scale Range

Sets the display range along the horizontal axis between 10 dB(m) and 50 dB(m) in steps of 10 dB.

Power Unit

Sets the unit to be displayed.

RELATIVE:

Displays the power relative to the average power.

ABS POWER:

Displays the power in absolute value.

Parameter Setup

Sets the parameters used for measurements.

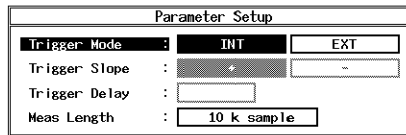

Figure 3-34 Parameter Setup Dialog Box

Trigger Mode

Selects the timing for retrieving data.

INT: Captures data using the internal trigger.

EXT: Captures data using the external trigger.

Trigger Slope

Toggles the external trigger slope between + and -.

+: Captures data at the rising edge.

-: Captures data at the falling edge.

Trigger Delay

Delays the external trigger timing.

Can be set between $-250\ \mu\text{s}$ and $250\ \mu\text{s}$ in steps of $1\ \mu\text{s}$.

Meas Length

The number of measurement samples is set.

Can be set between 10k sample and 100M sample in steps of 10k sample.

Trace Write ON/OFF

Sets whether or not the waveform is held.

ON: Holds the waveform.

OFF: Does not hold the waveform.

3.3.4.5 Time & FFT

Displays a time-domain IF signal or FFT trace to confirm the input signal.

Auto Level Set

Sets the internal reference level to an optimum value in accordance with the measurement signal. The reference level is automatically adjusted when this key is pressed.

NOTE: The signal level must stay constant while Auto Level Set is being carried out.

Select Type

Selects the graph to be displayed.

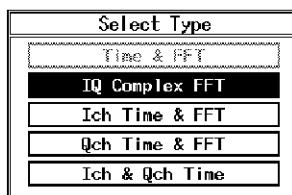

Figure 3-35 Select Type Dialog Box

3.3 Functional Description

Parameter Setup

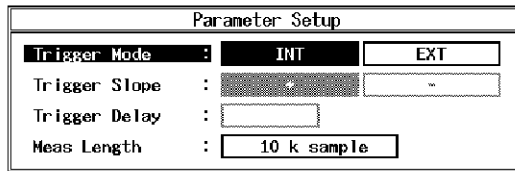

Figure 3-36 Parameter Setup Dialog Box

Trigger Source

Sets the trigger signal.

FREE RUN:

Captures data using the internal measurement timing.

IF: Captures the signal in sync with the IF signal (the leading edge of the burst).

EXT: Captures the signal in sync with the external trigger signal.

NOTE: The external trigger signal is input to the EXT TRIG connector on the rear panel.

Trigger Slope

Selects the polarity (leading or trailing edge) of a trigger signal.

Trigger Level

Sets the trigger level.

Trigger Delay

Sets a time period between the trigger and the data being captured.

Average Times ON/OFF

Sets the averaging count.

3.3.4.6 STD

Sets parameters used for measurement and relationship between the channel number and frequency.

DC CAL

Compensates for direct current components inside the circuit.

Channel Setting

Sets the relationship between the channel number and frequency.

Copy from STD

Sets the relationship between the channel number and frequency specified by the communication standard.

Reverse: If Link is set to Reverse, the channel number of the mobile station (MS).

Forward: If Link is set to Forward, the channel number of the base station (BS).

Edit Table 1 2 3

Displays tables 1 through 3.

Edit Table 4 5 6

Displays tables 4 through 6.

Edit Table 7 8 9

Displays tables 7 through 9.

STD Setup

Sets the parameters for measurement.

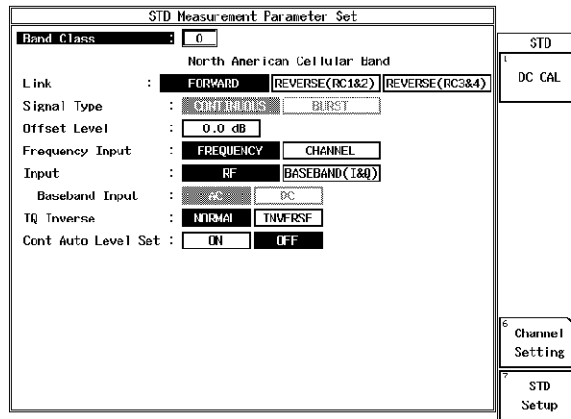
**Figure 3-37 STD Measurement parameter Setup Dialog Box****Band Class**

Selects a measurement frequency band, which is used to calculate a frequency from the channel number.

Link

Sets the signal direction.

FORWARD: Measures the signal transferred from the base station.**REVERSE (RC1&2):** Measures RC1 and RC2 signals on the mobile station.**REVERSE (RC3&RC4):** Measures RC3 and RC4 signals on the mobile station.**Signal Type**

Sets whether or not the signal to be measured is a burst signal if Link is REVERSE (RC1&2).

CONTINUOUS: Selected when the signal to be measured is a continuous signal.**BURST:** Selected when the signal to be measured is a burst signal. To measure F-Domain power, the gated sweep is enabled. Tx Power is measured by searching for a burst wave.**Offset Level**

Sets reference level's offset value within a range of -100 dB to +100 dB.

Frequency Input

Sets the method of entering the center frequency to the instrument.

FREQUENCY: Enters a frequency.

3.3 Functional Description

	CHANNEL:	Enters a channel number.
<i>Input</i>		Sets the input signal route.
	RF:	Selects the RF input route
	BASEBAND (I&Q):	Sets the IQ input path. The input signal magnitude range is from 0.25 V to 0.9 Vp-p (± 0.47 V or less).
	<hr/> NOTE: <i>When the baseband is input, Tx Power is displayed in relative power.</i> <hr/>	
<i>Baseband Input</i>		
	AC:	Allows you to select AC coupling.
	DC:	Allows you to select DC coupling.
<i>IQ Inverse</i>		Sets whether or not the phase of the IQ signal is inverted.
	NORMAL:	The sign of the Q signal is not inverted.
	INVERSE:	The sign of the Q signal is inverted.
<i>Cont Auto Level Set</i>		Sets whether to carry out the auto ranging.
	ON:	The auto ranging is carried out on a measurement basis.
	OFF:	The auto ranging is not carried out.
	<hr/> NOTE: <i>When RF is selected for Input, Cont Auto Level Set takes effect only for Code Domain Power Coef, Code Domain Power, Tx Power and CCDF. Use the soft key Auto Level Set when adjusting the reference level.</i> <hr/>	

4 REMOTE CONTROL

4.1 GPIB Command Index

This GPIB command index can be used as the index for Chapter 4.

<u>GPIB Command</u>	<u>Pages</u>	<u>GPIB Command</u>	<u>Pages</u>
*CLS	4-58	C2CDE ON	4-42
*ESE	4-58	C2CDDISP DUAL	4-47
*ESR	4-58	C2CDDISP SNGL	4-47
*IDN	4-58	C2CDEV M	4-51
*SRE	4-58	C2CDFMT GRP	4-47
*RST	4-58	C2CDFMT NUM	4-47
*STB	4-58	C2CDFMT TBL	4-47
.	4-57	C2CDGPLOT AVG	4-46
0 to 9	4-57	C2CDGPLOT PP	4-46
AA	4-11	C2CDGTYP CON	4-46
AD	4-58	C2CDGTYP CONDOT	4-46
ALS OFF	4-16	C2CDGTYP CONLIN	4-46
ALS ON	4-16	C2CDGTYP CONLINDOT	4-46
AS	4-12	C2CDGTYP EVM	4-46
AT	4-11	C2CDGTYP ICHEYE	4-46
ATMIN	4-11	C2CDGTYP IQCHEYE	4-46
ATMIN OFF	4-11	C2CDGTYP MAGERR	4-46
ATMIN ON	4-11	C2CDGTYP QCHEYE	4-46
AUTOLVL	4-39, 4-46, 4-53, 4-55, 4-56	C2CDGTYP PHAERR	4-46
AUTOWFL	4-17	C2CDGYDIV P25	4-46
C2ACTTRC A	4-50	C2CDGYDIV P5	4-46
C2ACTTRC B	4-50	C2CDIQOFS	4-51
C2AUTORATE OFF	4-41	C2CDMAG	4-51
C2AUTORATE ON	4-41	C2CDMK	4-50
C2CCDF	4-56	C2CDMK EVM	4-50
C2CCDFMK	4-56	C2CDMKPOW	4-49
C2CCDFMLN	4-56	C2CDMKPWR	4-50
C2CCDFUNIT ABS	4-56	C2CDMKRHO	4-49
C2CCDFUNIT REL	4-56	C2CDMKWLEN	4-50
C2CCDFTRC OFF	4-56	C2CDMKWNUM	4-50
C2CCDFTRC ON	4-56	C2CDMKWPHA	4-50
C2CCDFTRG EXT	4-56	C2CDMKWRHO	4-50
C2CCDFTRG INT	4-56	C2CDMKWRHOLOG	4-50
C2CCDFTRGDLY	4-56	C2CDMKWTAU	4-50
C2CCDFTRGSLP FALL	4-56	C2CDMMOD NORM	4-48
C2CCDFTRGSLP RISE	4-56	C2CDMMOD PREC	4-48
C2CCDFXMAX	4-56	C2CDP	4-49
C2CCDFXRNG	4-56	C2CDPAGE 1	4-48
C2CDAVG	4-49	C2CDPAGE 2	4-48
C2CDCFER	4-51	C2CDPHE	4-51
C2CDCHIPERR	4-51	C2CDPLOT AVG	4-42
C2CDE OFF	4-42	C2CDPLOT MAX	4-42
		C2CDPLOT MIN	4-42
		C2CDPN DLY	4-51

4.1 GPIB Command Index

C2CDQUAD.....	4-51	C2DLTTAU ON.....	4-49
C2CDRHO.....	4-51	C2DLTTHE OFF.....	4-49
C2CDTAU.....	4-51	C2DLTTHE ON.....	4-49
C2CDTOTAL.....	4-51	C2EQFLT OFF.....	4-40
C2CDTXPOW.....	4-51	C2EQFLT ON.....	4-40
C2CDYSCL PHA.....	4-47	C2EVM OFF.....	4-42
C2CDYSCL RHO.....	4-47	C2EVM ON.....	4-42
C2CDYSCL RHOALL.....	4-47	C2EVMMKEVM.....	4-50
C2CDYSCL RHORHO.....	4-47	C2EVMMKSYM.....	4-50
C2CDYSCL RHORHOALL.....	4-47	C2FCH OFF.....	4-48
C2CDYSCL TAU.....	4-47	C2FCH ON.....	4-48
C2CHDEF OFF.....	4-41	C2FIXSYM OFF.....	4-42
C2CHDEF ON.....	4-41	C2FIXSYM ON.....	4-42
C2CHEDIT.....	4-41	C2GMK.....	4-46, 4-52
C2CHGYDIV P25.....	4-47	C2FSRCH 10KHZ.....	4-40
C2CHGYDIV P5.....	4-47	C2FSRCH 500HZ.....	4-40
C2CHIPERR OFF.....	4-42, 4-49	C2FSRCH 500KHZ.....	4-40
C2CHIPERR ON.....	4-42, 4-49	C2FRRNG EXP.....	4-49
C2CHNAME CACH.....	4-41	C2FRRNG NORM.....	4-49
C2CHNAME CCCH.....	4-41	C2INACTRHO.....	4-43, 4-52
C2CHNAME BCH.....	4-41	C2IQGAIN OFF.....	4-42
C2CHNAME CPCCH.....	4-41	C2IQGAIN ON.....	4-42
C2CHNAME DCCH.....	4-41	C2MAGMKMAG.....	4-50
C2CHNAME FCH.....	4-41	C2MAGMKSYM.....	4-50
C2CHNAME PCH.....	4-41	C2MKCHIP.....	4-46, 4-52
C2CHNAME PICH.....	4-41	C2MKDEG.....	4-52
C2CHNAME QPCH.....	4-41	C2MKERR.....	4-46, 4-52
C2CHNAME SCCH.....	4-41	C2MKI.....	4-46, 4-52
C2CHNAME SCH.....	4-41	C2MKQ.....	4-46, 4-52
C2CHNAME SYNCH.....	4-41	C2MRNG.....	4-48
C2CHQOF.....	4-41	C2OP CCCH.....	4-48
C2CHRATE.....	4-41	C2OP EACH.....	4-48
C2CHRC.....	4-41	C2OP TCH.....	4-48
C2CHTOTAL.....	4-41	C2PC.....	4-43
C2BITREV OFF.....	4-41	C2PCAVGPOW.....	4-43
C2BITREV ON.....	4-41	C2PCCFER.....	4-43
C2CHWNUM.....	4-42	C2PCCHIPERR.....	4-43
C2CMPFLT OFF.....	4-40	C2PCDISP DUAL.....	4-39
C2CMPFLT ON.....	4-40	C2PCDISP SNGL.....	4-39
C2DCCH OFF.....	4-48	C2PCERPOW.....	4-43
C2DCCH ON.....	4-48	C2PCEVM.....	4-43
C2DEMOSDV.....	4-49	C2PCFMT GRP.....	4-39
C2DISP DEMOD.....	4-47	C2PCFMT NUM.....	4-39
C2DISP EVM.....	4-47	C2PCFMT TBL.....	4-39
C2DISP MAGERR.....	4-47	C2PCGPHABSPOW.....	4-45
C2DISP NUM.....	4-47	C2PCGPHABSPOWW.....	4-45
C2DISP PHAERR.....	4-47	C2PCGPHCDE.....	4-45
C2DISP RHO.....	4-47	C2PCGPHPHA.....	4-45
C2DISP TBL.....	4-47	C2PCGPHPOW.....	4-45
C2DISP TBLEVM.....	4-47	C2PCGPHRHO.....	4-44
C2DLTTAU OFF.....	4-49	C2PCGPHRHOLOG.....	4-45

C2PCGPHSYMRT	4-45	C2PKINACT	4-43
C2PCGPHTAU	4-45	C2PKTAU	4-43, 4-52
C2PCGPHWLEN	4-44	C2PKTHETA	4-43, 4-52
C2PCGPHWNUM	4-44	C2PNDLY	4-49
C2PCGPLOT AVG	4-39	C2QOF	4-41
C2PCGPLOT PP	4-39	C2PNMOD OFF	4-40, 4-48
C2PCGTYP CON	4-39	C2PNMOD ON	4-40, 4-48
C2PCGTYP CONDOT	4-39	C2PNOFS	4-40
C2PCGTYP CONLIN	4-39	C2QUAD OFF	4-42, 4-49
C2PCGTYP CONLINDOT	4-39	C2QUAD ON	4-42, 4-49
C2PCGTYP EVM	4-39	C2PWRUNIT DB	4-42
C2PCGTYP ICHEYE	4-39	C2PWRUNIT DBM	4-42
C2PCGTYP IQCHEYE	4-39	C2PWRUNIT DBMPI	4-42
C2PCGTYP MAGERR	4-39	C2SCH1REP	4-48
C2PCGTYP QCHEYE	4-39	C2SCH1WALSH	4-48
C2PCIQGAIN	4-43	C2SCH1WALSH OFF	4-48
C2PCIQOFS	4-43	C2SCH1WALSH W12	4-48
C2PCMAG	4-43	C2SCH1WALSH W24	4-48
C2PCMK	4-44	C2SCH2REP	4-48
C2PCMKABSPOW	4-44	C2SCH2WALSH W24	4-48
C2PCMKCDE	4-44	C2SCH2WALSH W68	4-48
C2PCMKPHA	4-44	C2RFACT	4-40
C2PCMKPOW	4-44	C2SIGPOW OFF	4-42
C2PCMKRHO	4-44	C2SIGPOW ON	4-42
C2PCMKRHOLOG	4-44	C2TAU OFF	4-42
C2PCMKSYMRT	4-44	C2TAU ON	4-42
C2PCMKTAU	4-44	C2THETA OFF	4-42
C2PCMKWLEN	4-44	C2THETA ON	4-42
C2PCMKWNUM	4-44	C2THRSH	4-41, 4-48
C2PCMRNG	4-40	C2TOFS	4-40
C2PCPAGE 1	4-40	C2TRG EXT	4-40, 4-49
C2PCPAGE 2	4-40	C2TRG INT	4-40, 4-49
C2PCPHE	4-43	C2TRG INTRVL1	4-40, 4-49
C2PCPKCDE	4-43	C2TRG INTRVL2	4-40, 4-49
C2PCPNOFS	4-43	C2TRGDLY	4-49
C2PCQUAD	4-43	C2TRGSLP FALL	4-41, 4-49
C2PCRHO	4-43	C2TRGSLP RISE	4-41, 4-49
C2PCTAU	4-43	C2WLEN	4-41
C2PCTXPOW	4-43	C2WLSLEN W32	4-48
C2PCTXPOWW	4-43	C2WLSLEN W64	4-48
C2PCYSCL CDE	4-40	C2VWCH CCCH	4-47
C2PCYSCL PHA	4-40	C2VWCH EACH	4-47
C2PCYSCL POW	4-40	C2VWCH DCCH	4-47
C2PCYSCL RHO	4-40	C2VWCH FCH	4-47
C2PCYSCL RHOALL	4-40	C2VWCH PICH	4-47
C2PCYSCL TAU	4-40	C2VWCH SCH1	4-47
C2PDIV P10	4-40, 4-48	C2VWCH SCH2	4-47
C2PDIV P5	4-40, 4-48	C2VWMODE CHL	4-47
C2PHAMKPHA	4-50	C2VWMODE WALSH	4-47
C2PHAMKSYM	4-50	C2YUPR	4-40
C2PIPWR	4-42	BA	4-12

4.1 GPIB Command Index

CAVGAT.....	4-18	COBW	4-27
CAVGCHP	4-25	COBWCP.....	4-30
CAVGOBW	4-26	COBWDET NEG	4-27
CAVGRAT	4-20	COBWDET NRM.....	4-27
CAVGSPR	4-34	COBWDET POS	4-27
CAVGWF.....	4-54	COBWDET SMP.....	4-27
BBINPUT AC.....	4-16	COBWPER	4-26
BBINPUT DC.....	4-16	BNDCLS 0.....	4-15
CCHPOW	4-26	BNDCLS 1.....	4-15
CF.....	4-12	BNDCLS 2.....	4-15
CH.....	4-15	BNDCLS 3.....	4-15
CHEDFR1.....	4-15	BNDCLS 4.....	4-15
CHEDFR2.....	4-15	BNDCLS 5.....	4-15
CHEDFR3.....	4-15	BNDCLS 6.....	4-15
CHEDFR4.....	4-15	BNDCLS 7.....	4-15
CHEDFR5.....	4-15	BNDCLS 8.....	4-15
CHEDFR6.....	4-15	BNDCLS 9.....	4-15
CHEDFR7.....	4-15	COMMSYS CDMA2000	4-11
CHEDFR8.....	4-15	CPWDIV P10DB.....	4-25
CHEDFR9.....	4-15	CPWDIV P5DB	4-25
CHEDRV1	4-15	CPWDX	4-25
CHEDRV2.....	4-15	CPWLX	4-25
CHEDRV3.....	4-15	DB	4-57
CHEDRV4.....	4-15	DC0.....	4-13
CHEDRV5.....	4-15	DC1	4-13
CHEDRV6.....	4-15	DC2	4-13
CHEDRV7.....	4-16	DEL.....	4-14
CHEDRV8.....	4-16	DEL REG_nn.....	4-14
CHEDRV9.....	4-16	DELSTBL.....	4-22
CINBMAX.....	4-35	DL0	4-58
CINBSPR.....	4-35	DL1	4-58
CHSETSTD	4-16	DL2	4-58
CHTBL1 ENBL.....	4-16	DL3	4-58
CHTBL1 DSBL	4-16	DL4	4-58
CHTBL2 ENBL.....	4-16	ENT.....	4-57
CHTBL2 DSBL	4-16	ERRNO.....	4-58
CHTBL3 ENBL.....	4-16	DTMAUTOLVL.....	4-30
CHTBL3 DSBL	4-16	DTMAVG.....	4-31
CHTBL4 ENBL.....	4-16	DTMAVGCNT	4-31
CHTBL4 DSBL	4-16	DTMAVGMD MAX	4-32
CHTBL5 ENBL.....	4-16	DTMAVGMD NUMERIC	4-32
CHTBL5 DSBL	4-16	DTMAVGMD POWER	4-32
CHTBL6 ENBL.....	4-16	DTMAVGMD TRACE	4-32
CHTBL6 DSBL	4-16	DTMDET NEG.....	4-32
CHTBL7 ENBL.....	4-16	DTMDET NRM.....	4-32
CHTBL7 DSBL	4-16	DTMDET POS	4-32
CHTBL8 ENBL.....	4-16	DTMDET SMP.....	4-32
CHTBL8 DSBL	4-16	DTMFRMD	4-32
CHTBL9 ENBL.....	4-16	DTMFRMD CFSP	4-32
CHTBL9 DSBL	4-16	DTMFRMD STSP	4-32
CLDC.....	4-16	DTMJGDG OFF	4-32

DTMJJDG ON	4-32	DTSRES REL	4-29
DTMMEAS	4-33	DTSSETSTD	4-29
DTMMKRCLR	4-31	DTSRFACT	4-29
DTMMKRCP	4-31	DTSSYMRT	4-29
DTMMKRED	4-31	DTSTMPL OFF	4-28
DTMREF MKR	4-33	DTSTMPL ON	4-28
DTMREF MOD	4-33	DTSTMPLCLR	4-28
DTMREFPWR	4-33	DTSTMPLCP	4-28
DTMRES ABS	4-32	DTSTMPLBTM	4-29
DTMRES MKR	4-32	DTSTMPLIED	4-28
DTMRES REL	4-32	DTSTMPLDX	4-28
DTMSETSTD	4-33	DTSTMPLPW OFF	4-29
DTMRFACT	4-33	DTSTMPLPW ON	4-29
DTMSYMRT	4-33	DTSTMPLSX	4-28
DTMTMPL OFF	4-31	DTSTMPLSY	4-28
DTMTMPL ON	4-31	DTSUNIT DBM	4-29
DTMTMPLCLR	4-31	DTSUNIT DBUV	4-29
DTMTMPLCP	4-31	DTSUNIT W	4-29
DTMTMPLBTM	4-32	FA	4-12
DTMTMPLED	4-31	GATEPOW	4-19
DTMTMPLDX	4-31	FB	4-12
DTMTMPLPW OFF	4-32	FDPAUTOLVL	4-24
DTMTMPLPW ON	4-32	FDPAVG	4-25
DTMTMPLSX	4-31	FDPAVGCNT	4-25
DTMTMPLSY	4-31	FDPAVGMD MAX	4-25
DTMUNIT DBM	4-32	FDPAVGMD NUMERIC	4-25
DTMUNIT DBUV	4-32	FDPAVGMD POWER	4-25
DTMUNIT W	4-32	FDPAVGMD TRACE	4-25
DTSAUTOLVL	4-28	FDPDET NEG	4-25
DTSAVG	4-28	FDPDET NRM	4-25
DTSAVGCNT	4-28	FDPDET POS	4-25
DTSAVGMD MAX	4-28	FDPDET SMP	4-25
DTSAVGMD NUMERIC	4-28	FDPDIV P10DB	4-25
DTSAVGMD POWER	4-28	FDPDIV P2DB	4-25
DTSAVGMD TRACE	4-28	FDPDIV P5DB	4-25
DTSDET NEG	4-29	FDPJDG OFF	4-25
DTSDET NRM	4-29	FDPJDG ON	4-25
DTSDET POS	4-29	FDPJDGLOW	4-26
DTSDET SMP	4-29	FDPJDGUP	4-26
DTSFRMD CFSP	4-29	FDPMEAS	4-26
DTSFRMD STSP	4-29	FDPSETSTD	4-26
DTSJDG OFF	4-29	FDPUNIT DBM	4-25
DTSJDG ON	4-29	FDPUNIT DBUV	4-25
DTSMEAS	4-29, 4-30	FDPUNIT W	4-25
DTSMKRCLR	4-28	FDPWDO OFF	4-25
DTSMKRCP	4-28	FDPWDO ON	4-25
DTSMKRED	4-28	FDPWPOS	4-25
DTSREF MKR	4-29	FDPWWID	4-25
DTSREF MOD	4-29	FDSAUTOLVL	4-38
DTSRES ABS	4-29	FDSAVG	4-38
DTSRES MKR	4-29	FDSAVGCNT	4-38

4.1 GPIB Command Index

FDSAVGMD MAX.....	4-38	MKN	4-13
FDSAVGMD POWER	4-38	MKOFF.....	4-13
FDSAVGMD TRACE.....	4-38	ML	4-13
FDSCLR	4-38	LMCPSL STD	4-18
FDSCP	4-38	MO	4-13
FDSDET NEG.....	4-38	MS.....	4-57
FDSDET NRM	4-38	MV	4-57
FDSDET POS.....	4-38	MW	4-57
FDSDET SMP	4-38	MZ	4-57
FDSJDG OFF	4-38	OBWAUTOLVL	4-26
FDSJDG ON	4-38	OBWAVG	4-26
FDSL D.....	4-38	OBWAVGCNT	4-26
FDSMEAS	4-39	OBWAVGMD MAX.....	4-26
FDSPKMKY	4-38	OBWAVGMD NUMERIC.....	4-26
FDSPRE 16G.....	4-39	OBWAVGMD POWER.....	4-26
FDSPRE 36G.....	4-39	OBWAVGMD TRACE	4-26
FDSSETSTD	4-39	OBWDET NEG	4-27
FDSSV	4-38	OBWDET NRM	4-27
FDSTBL.....	4-38	OBWDET POS	4-27
FDSTBLED	4-38	OBWDET SMP	4-27
FDSUNIT DBM	4-38	OBWJDG OFF	4-27
FDSUNIT DBUV	4-38	OBWJDG ON.....	4-27
FDSUNIT W.....	4-38	OBWJDGLOW.....	4-27
FINPMD CHL	4-15	OBWJDGUP.....	4-27
FINPMD FREQ.....	4-15	OBWMEAS	4-27
GMK	4-55	OBWPER.....	4-26
GMKCHIP.....	4-55	OBWSETSTD	4-27
GMKCHIPNO	4-55	OORAUTOLVL	4-20
GMKDEG.....	4-55	OORAVG	4-20
GMKERR	4-55	OORAVGCNT	4-20
GMKI.....	4-55	OORAVGMD MAX.....	4-20
GMKQ.....	4-55	OORAVGMD NUMERIC	4-20
GZ	4-57	OORAVGMD POWER	4-20
HCOPY	4-11	OORAVGMD TRACE.....	4-20
INPUT IQ.....	4-16	OORDET NEG	4-21
INPUT RF.....	4-16	OORDET NRM	4-21
IP.....	4-13	OORDET POS.....	4-21
IQMD INV.....	4-16	OORDET SMP	4-21
IQMD NORM.....	4-16	OORDIV P10DB	4-20
HZ	4-57	OORDIV P2DB	4-20
KZ	4-57	OORDIV P5DB	4-20
MA	4-57	OORJDG OFF	4-21
LC	4-58	OORJDG ON.....	4-21
MF.....	4-13	OORJDGUP.....	4-21
MFL	4-13	OORMEAS	4-21
LINK FWD.....	4-15	OORSETSTD	4-21
LINK REV12.....	4-15	OORUNIT DBM	4-21
LINK REV34.....	4-15	OORUNIT DBUV	4-21
MK	4-13	OORUNIT W.....	4-21
MKBW.....	4-13	OORTRGDT.....	4-20
MKD	4-13	OORTRGLVL	4-20

OORTRGPOS.....	4-20	SPR2DET SMP.....	4-36
OORTRGSLP FALL.....	4-20	SPR2FRMD CFSP.....	4-37
OORTRGSLP RISE.....	4-20	SPR2FRMD STSP.....	4-37
OORTRGSRC EXT.....	4-20	SPR2INTE.....	4-37
OORTRGSRC FREE.....	4-20	SPR2JDG OFF.....	4-37
OORTRGSRC IF.....	4-20	SPR2JDG ON.....	4-37
OORTRGSRC VIDEO.....	4-20	SPR2MEAS.....	4-37
OORWDO OFF.....	4-20	SPR2MKRCLR.....	4-36
OORWDO ON.....	4-20	SPR2MKRCP.....	4-36
OORWOFPOS.....	4-20	SPR2MKRED.....	4-36
OORWOFWID.....	4-20	SPR2OFSSP.....	4-37
OORWONPOS.....	4-20	SPR2OFSSST.....	4-37
OORWONWID.....	4-20	SPR2PKMKY.....	4-37
OPF.....	4-58	SPR2REF MKR.....	4-37
OPR.....	4-58	SPR2REF MOD.....	4-37
OPREVT.....	4-58	SPR2REFPWR.....	4-37
PS.....	4-13	SPR2RES ABS.....	4-37
S0.....	4-58	SPR2RES MKR.....	4-37
S1.....	4-58	SPR2RES REL.....	4-37
S2.....	4-58	SPR2SETSTD.....	4-37
RATIO.....	4-21	SPR2TMPL OFF.....	4-35
RB.....	4-12	SPR2TMPL ON.....	4-35
RC.....	4-13	SPR2TMPLCLR.....	4-36
SC.....	4-57	SPR2TMPLCP.....	4-36
RC REG_nn.....	4-13	SPR2TMPLBTM.....	4-37
RCLTBL.....	4-22	SPR2TMPLIED.....	4-36
SETFUNC CW.....	4-11	SPR2TMPLDX.....	4-36
SETFUNC TRAN.....	4-11	SPR2TMPLPW OFF.....	4-37
SI.....	4-19, 4-21, 4-23, 4-26, 4-27, 4-29, 4-33, 4-35, 4-37, 4-39, 4-43, 4-49, 4-54, 4-55, 4-56	SPR2TMPLPW ON.....	4-37
SIGTYP CONT.....	4-15	SPR2TMPLSX.....	4-36
SIGTYP BURST.....	4-15	SPR2TMPLSY.....	4-36
RL.....	4-12	SPR2UNIT DBM.....	4-36
RO.....	4-15	SPR2UNIT DBUV.....	4-36
SP.....	4-14	SPR2UNIT W.....	4-36
RQS.....	4-58	SPRAUTOLVL.....	4-33
SPR2AUTOLVL.....	4-35	SPRAVG.....	4-34
SPR2AVG.....	4-36	SPRAVGCNT.....	4-34
SPR2AVGCNT.....	4-36	SPRAVGMD MAX.....	4-34
SPR2AVGMD POWER.....	4-36	SPRAVGMD POWER.....	4-34
SPR2CONV OFF.....	4-37	SPRAVGMD TRACE.....	4-34
SPR2CONV ON.....	4-37	SPRDET NEG.....	4-34
SPR2DET NEG.....	4-36	SPRDET NRM.....	4-34
SPR2DET NRM.....	4-36	SPRDET POS.....	4-34
SPR2DET POS.....	4-36	SPRDET SMP.....	4-34
		SPRFRMD CFSP.....	4-34
		SPRFRMD STSP.....	4-34
		SPRJDG OFF.....	4-34
		SPRJDG ON.....	4-34
		SPRMEAS.....	4-35
		SPRMKRCLR.....	4-33
		SPRMKRCP.....	4-33

4.1 GPIB Command Index

SPRMKRED.....	4-33	TDPJDGLow	4-19
SPRMod ABS	4-35	TDPJDGUP	4-19
SPRMod MKR.....	4-35	TDPMEAS.....	4-19
SPRMod REL	4-35	TDPSETSTD	4-19
SPRPkMKY	4-35	TDPTMPL OFF.....	4-18
SPRREF DSP.....	4-35	TDPTMPL ON	4-18
SPRREF MKR.....	4-35	TDPTMPLCLR	4-18
SPRREF Mod.....	4-35	TDPTMPLCP	4-18
SPRREF SWP.....	4-35	TDPTMPLBTM.....	4-19
SPRREFPWR	4-35	TDPTMPLED.....	4-18
SPRRES ABS	4-35	TDPTMPLPW OFF.....	4-19
SPRRES MKR.....	4-35	TDPTMPLPW ON	4-19
SPRRES REL	4-35	TDPTMPLSEL Low.....	4-18
SPRSETSTD.....	4-35	TDPTMPLSEL UP	4-18
SPRTMPL OFF	4-33	TDPTMPLSX	4-18
SPRTMPL ON.....	4-33	TDPTMPLSY	4-18
SPRTMPLCLR.....	4-33	TDPUNIT DBM	4-19
SPRTMPLCP.....	4-33	TDPUNIT DBUV	4-19
SPRTMPLBTM.....	4-34	TDPUNIT W.....	4-19
SPRTMPLED	4-33	TDPTRGDT.....	4-17
SPRTMPLDX.....	4-33	TDPTRGLVL.....	4-17
SPRTMPLPW OFF	4-34	TDPTRGPOS.....	4-17
SPRTMPLPW ON.....	4-34	TDPTRGSLP FALL.....	4-17
SPRTMPLSX.....	4-33	TDPTRGSLP RISE	4-17
SPRTMPLSY.....	4-33	TDPTRGSRC EXT.....	4-17
SPRUNIT DBM.....	4-34	TDPTRGSRC FREE.....	4-17
SPRUNIT DBUV	4-34	TDPTRGSRC IF.....	4-17
SPRUNIT W	4-34	TDPTRGSRC VIDEO.....	4-17
SPULVL	4-24	TDPWDO OFF	4-17
SPUR	4-23	TDPWDO ON.....	4-17
ST.....	4-12	TDPWPOS.....	4-17
SV	4-14	TDPWWID	4-17
SW	4-12	TDSAUTOLVL.....	4-22
SV REG_nm	4-14	TDSAVG	4-22
SVSTBL.....	4-22	TDSAVGCNT	4-22
TDPAUTOLVL.....	4-17	TDSAVGMD MAX	4-23
TDPAVG	4-18	TDSAVGMD NUMERIC	4-23
TDPAVCNT	4-18	TDSAVGMD POWER.....	4-23
TDPAVGMD MAX	4-18	TDSAVGMD TRACE.....	4-23
TDPAVGMD NUMERIC	4-18	TDSCLR	4-22
TDPAVGMD POWER.....	4-18	TDSDET NEG.....	4-23
TDPAVGMD TRACE.....	4-18	TDSDET NRM.....	4-23
TDPDET NEG.....	4-18	TDSDET POS.....	4-23
TDPDET NRM.....	4-18	TDSDET SMP	4-23
TDPDET POS.....	4-18	TDSJDG OFF	4-23
TDPDET SMP.....	4-18	TDSJDG ON.....	4-23
TDPDIV P10DB	4-17	TDSLd.....	4-22
TDPDIV P2DB	4-17	TDSMEAS	4-23
TDPDIV P5DB	4-17	TDSMULTI	4-23
TDPJDG OFF	4-19	TDSPKMKY	4-23
TDPJDG ON.....	4-19	TDSPRE 16G.....	4-23

TDSPRE 36G.....	4-23	TRGSLP FALL.....	4-17
TDSRES PK	4-23	TRGSLP RISE.....	4-17
TDSRES RMS	4-23	TRGSRC EXT	4-17
TDSSETSTD	4-23	TRGSRC FREE	4-17
TDSSV.....	4-22	TRGSRC IF	4-17
TDSTBL	4-22	TRGSRC VIDEO	4-17
TDSTBLED.....	4-22	TRSPMD EXT.....	4-22
TDSTBLF ABS	4-22	TRSPMD FREE.....	4-22
TDSTBLF REL.....	4-22	TRSPMD IF.....	4-22
TDSUNIT DBM	4-23	TRSPSLP FALL.....	4-22
TDSUNIT DBUV	4-23	TRSPSLP RISE	4-22
TDSUNIT W.....	4-23	TWDO OFF	4-17
TDSTRGDT.....	4-22	TWDO ON.....	4-17
TDSTRGLVL	4-22	TWDX	4-17
TDSTRGPOS.....	4-22	TWLX.....	4-17
TDSTRGSLP FALL.....	4-22	TXAVG	4-55
TDSTRGSLP RISE	4-22	TXPWR	4-55
TDSTRGSRC EXT.....	4-22	TXTRG EXT	4-55
TDSTRGSRC FREE.....	4-22	TXTRG IF.....	4-55
TDSTRGSRC IF.....	4-22	TXTRG INT	4-55
TGTDET NEG.....	4-24, 4-31	TXTRG INTRVL1	4-55
TGTDET NRM.....	4-24, 4-31	TXTRGDLY	4-55
TGTDET POS.....	4-24, 4-31	TXTRGSLP FALL	4-55
TGTDET SMP.....	4-24, 4-31	TXTRGSLP RISE.....	4-55
TGTPOS	4-24, 4-30	TXTRLVL	4-55
TGTSETUP OFF	4-24, 4-30	VA.....	4-12
TGTSETUP ON.....	4-24, 4-30	VB.....	4-12
TGTSRC EXT	4-24, 4-30	WFCFER	4-54
TGTSRC TRG	4-24, 4-30	WFEVM.....	4-54
TGTSWP OFF.....	4-24, 4-31	WFGPLOT AVG.....	4-53
TGTSWP ON.....	4-24, 4-31	WFGPLOT PP.....	4-53
TGTTRG EXT.....	4-24, 4-30	WFGTYP CON.....	4-53
TGTTRG FREE.....	4-24, 4-30	WFGTYP CONDOT	4-53
TGTTRG IF.....	4-24, 4-30	WFGTYP CONLIN.....	4-53
TGTTRG VIDEO	4-24, 4-30	WFGTYP CONLINDOT.....	4-53
TGTTRGDT	4-24, 4-30	WFGTYP EVM.....	4-53
TGTTRGLVL.....	4-24, 4-30	WFGTYP ICHEYE	4-53
TGTTRGPOS	4-24, 4-30	WFGTYP IQCHEYE	4-53
TGTTRGSLP FALL.....	4-24, 4-30	WFGTYP MAGERR	4-53
TGTTRGSLP RISE.....	4-24, 4-30	WFGTYP NCON.....	4-53
TGTWID.....	4-24, 4-30	WFGTYP NCONDOT	4-53
TLMASFT	4-18	WFGTYP NCONLIN	4-53
TLMDEL	4-18	WFGTYP NCONLINDOT.....	4-53
TLMIN.....	4-18	WFGTYP NICHEYE	4-53
TLMSFT	4-18	WFGTYP NIQCHEYE.....	4-53
TLMT OFF	4-18	WFGTYP NQCHEYE.....	4-53
TLMT ON.....	4-18	WFGTYP QCHEYE.....	4-53
US	4-57	WFGTYP PHAERR	4-53
TRGDT	4-17	WFIQOFS	4-54
TRGLVL.....	4-17	WFMAG	4-54
TRGPOS	4-17	WFPHE.....	4-54

4.1 GPIB Command Index

WFQUA.....	4-54
WFRHO.....	4-54
WFRRNG EXP.....	4-54
WFRRNG NORM.....	4-54
WMRNG.....	4-53
WTRGDLY.....	4-54
WTRGSLP FALL.....	4-54
WTRGSLP RISE.....	4-54
WTRGSRC EXT.....	4-54
WTRGSRC INT.....	4-54
WTRGSRC INTRVL1.....	4-54
WTRGSRC INTRVL2.....	4-54
XDB.....	4-13
XDL.....	4-13
XDR.....	4-13

4.2 GPIB Command Codes

The following table list the GPIB commands by function.

Table 4-1 Operating Mode

Function		Listener Code	Talker Request		Remarks
			Code	Output Format	
Operating mode	Spectrum analyzer mode	SETFUNC CW	SETFUNC?	0:Spectrum analyzer	
	TRANSIENT mode	SETFUNC TRAN		1:TRANSIENT	
Communication system	cdma2000 mode	COMMSYS CDMA2000	COMMSYS?	12:cdma2000	*1

*1: Listener code is available only when the analyzer is set to the CW mode. The codes within the talker request are available for both the CW and TRANSIENT modes.

Table 4-2 ATT Key (Attenuator)

Function		Listener Code	Talker Request		Remarks
			Code	Output Format	
Attenuator	AT	AT *	AT?	Level	
	ATT AUTO	AA	AA?	0: Manual 1: AUTO	
	Min. ATT	ATMIN *	ATMIN?	Level	
	Min. ATT ON OFF	ATMIN ON [*] ATMIN OFF	ATMINON?	0: OFF 1: ON	

Table 4-3 COPY Key (Hard copy)

Function		Listener Code	Talker Request		Remarks
			Code	Output Format	
Printer output	Execution of the command	HCOPY	-	-	
File output					

4.2 GPIB Command Codes

Table 4-4 COUPLE Key (Couple function)

Function		Listener Code	Talker Request		Remarks
			Code	Output Format	
Couple function	RBW	RB *	RB?	Frequency	
	RBW AUTO	BA	BA?	0:Manual 1:AUTO	
	VBW	VB *	VB?	Frequency	
	VBW AUTO	VA	VA?	0:Manual 1:AUTO	
	Sweep Time	SW * ST *	SW? ST?	Time	
	Sweep Time Auto	AS	AS?	0:Manual 1:AUTO	

Table 4-5 FREQ Key (Frequency)

Function		Listener Code	Talker Request		Remarks
			Code	Output Format	
Frequency	Center frequency	CF *	CF?	Frequency	
	Start frequency	FA *	FA?	Frequency	
	Stop frequency	FB *	FB?	Frequency	

Table 4-6 LEVEL Key (Reference Level)

Function		Listener Code	Talker Request		Remarks
			Code	Output Format	
Reference level		RL *	RL?	Level	

Table 4-7 MKR Key (Marker)

Function	Listener Code	Talker Request		Remarks
		Code	Output Format	
Marker	ΔMarker ON	MKD [*]	-	Frequency(Time)
	OFF	MKOFF MO	-	-
	Reading marker frequency (time)	-	MF?	Frequency(Time)
	Reading marker level	-	ML?	Level
	Reading marker frequency (time) and marker level	-	MFL?	Frequency(Time), Level
	Normal marker	MK [*] MKN [*]	-	Frequency(Time)
	Peak search	PS	-	-
	X-dB Down			
	X-dB Down width	MKBW *	MKBW?	Level
	X-dB Down	XDB	-	-
	X-dB Down Left	XDL	-	-
	X-dB Down Right	XDR	-	-
	Display mode REL. ABS.L. ABS.R.	DC0 DC1 DC2	DC?	0: Relative mode 1: Absolute mode (Left side) 2: Absolute mode (Right side)

Table 4-8 PRESET Key (Initialization)

Function	Listener Code	Talker Request		Remarks
		Code	Output Format	
Preset	Instrument preset	IP	-	-

Table 4-9 RCL Key (Recall)

Function	Listener Code	Talker Request		Remarks
		Code	Output Format	
Recall	RC REG_nn RC file name	-	nn: 01 to 10 File name: Max.8 character	

4.2 GPIB Command Codes

Table 4-10 SAVE Key (Save)

Function		Listener Code	Talker Request		Remarks
			Code	Output Format	
Save	Save	SV REG_nn SV file name	-	nn: 01 to 10 File name: Max.8 character	
	Deletion	DEL REG_nn DEL file name	-	nn: 01 to 10 File name: Max.8 character	

Table 4-11 SPAN Key (Frequency span)

Function		Listener Code	Talker Request		Remarks
			Code	Output Format	
Frequency span		SP *	SP?	Frequency	

Table 4-12 TRANSIENT Key

Function	Listener Code	Talker Request		Remarks
		Code	Output Format	
STD Setup	Band Class			
	0 (North American Cellular)	BNDCLS 0	BNDCLS?	0: North American Cellular
	1 (North American PCS)	BNDCLS 1		1: North American PCS
	2 (TACS)	BNDCLS 2		2: TACS
	3 (JTACS)	BNDCLS 3		3: JTACS
	4 (Korean PCS)	BNDCLS 4		4: Korean PCS
	5 (NMT-450)	BNDCLS 5		5: NMT-450
	6 (IMT-2000)	BNDCLS 6		6: IMT-2000
	7 (North American 700MHz Cellular)	BNDCLS 7		7: North American 700MHz Cellular
8 (1800MHz)	BNDCLS 8		8: 1800MHz	
9 (900MHz)	BNDCLS 9		9: 900MHz	
Link	FORWARD	LINK FWD	LINK?	0:FORWARD
	REVERSE(RC3&4)	LINK REV34		1:REVERSE(RC3&4)
	REVERSE(RC1&2)	LINK REV12		2:REVERSE(RC1&2)
Signal Type	CONTINUOUS	SIGTYP CONT	SIGTYP?	0:CONTINUOUS
	BURST	SIGTYP BURST		1:BURST
Offset Level	RO *	RO?	Level	
Frequency setting mode	Frequency input mode	FINPMD FREQ	FINPMD?	0: Frequency input
	Channel input mode	FINPMD CHL		1: Channel input
Channel setting	CH *	CH?	Integer (Channel number)	
Channel edition	Input #1 (FORWARD)	CHEDFR1 *,*,*,*	CHEDFR1?	ch1,ch2,f1,f2,chof
	Input #2 (FORWARD)	CHEDFR2 *,*,*,*	CHEDFR2?	ch1,ch2,f1,f2,chof
	Input #3 (FORWARD)	CHEDFR3 *,*,*,*	CHEDFR3?	ch1,ch2,f1,f2,chof
	Input #4 (FORWARD)	CHEDFR4 *,*,*,*	CHEDFR4?	ch1,ch2,f1,f2,chof
	Input #5 (FORWARD)	CHEDFR5 *,*,*,*	CHEDFR5?	ch1,ch2,f1,f2,chof
	Input #6 (FORWARD)	CHEDFR6 *,*,*,*	CHEDFR6?	ch1,ch2,f1,f2,chof
	Input #7 (FORWARD)	CHEDFR7 *,*,*,*	CHEDFR7?	ch1,ch2,f1,f2,chof
	Input #8 (FORWARD)	CHEDFR8 *,*,*,*	CHEDFR8?	ch1,ch2,f1,f2,chof
	Input #9 (FORWARD)	CHEDFR9 *,*,*,*	CHEDFR9?	ch1,ch2,f1,f2,chof
	Input #1 (REVERSE)	CHEDRV1 *,*,*,*	CHEDRV1?	ch1,ch2,f1,f2,chof
	Input #2 (REVERSE)	CHEDRV2 *,*,*,*	CHEDRV2?	ch1,ch2,f1,f2,chof
	Input #3 (REVERSE)	CHEDRV3 *,*,*,*	CHEDRV3?	ch1,ch2,f1,f2,chof
Input #4 (REVERSE)	CHEDRV4 *,*,*,*	CHEDRV4?	ch1,ch2,f1,f2,chof	
Input #5 (REVERSE)	CHEDRV5 *,*,*,*	CHEDRV5?	ch1,ch2,f1,f2,chof	
Input #6 (REVERSE)	CHEDRV6 *,*,*,*	CHEDRV6?	ch1,ch2,f1,f2,chof	

4.2 GPIB Command Codes

Table 4-12 TRANSIENT Key

Function	Listener Code	Talker Request		Remarks	
		Code	Output Format		
STD Setup	Input #7 (REVERSE) Input #8 (REVERSE) Input #9 (REVERSE)	CHEDRV7 *,*,*,* CHEDRV8 *,*,*,* CHEDRV9 *,*,*,*	CHEDRV7? CHEDRV8? CHEDRV9?	ch1,ch2,f1,f2,chof ch1,ch2,f1,f2,chof ch1,ch2,f1,f2,chof ch1: Start channel no. ch2: Stop channel no. f1: Base frequency(Hz) f2: Channel space(Hz) chof: Channel Offset	Units of frequency are necessary for f1 and f2.
Channel table ENABLE/DISABLE selection					
#1 ENABLE DISABLE	CHTBL1 ENBL CHTBL1 DSBL	CHTBL1?	0: Disable 1: Enable		
#2 ENABLE DISABLE	CHTBL2 ENBL CHTBL2 DSBL	CHTBL2?	0: Disable 1: Enable		
#3 ENABLE DISABLE	CHTBL3 ENBL CHTBL3 DSBL	CHTBL3?	0: Disable 1: Enable		
#4 ENABLE DISABLE	CHTBL4 ENBL CHTBL4 DSBL	CHTBL4?	0: Disable 1: Enable		
#5 ENABLE DISABLE	CHTBL5 ENBL CHTBL5 DSBL	CHTBL5?	0: Disable 1: Enable		
#6 ENABLE DISABLE	CHTBL6 ENBL CHTBL6 DSBL	CHTBL6?	0: Disable 1: Enable		
#7 ENABLE DISABLE	CHTBL7 ENBL CHTBL7 DSBL	CHTBL7?	0: Disable 1: Enable		
#8 ENABLE DISABLE	CHTBL8 ENBL CHTBL8 DSBL	CHTBL8?	0: Disable 1: Enable		
#9 ENABLE DISABLE	CHTBL9 ENBL CHTBL9 DSBL	CHTBL9?	0: Disable 1: Enable		
Channel Copy from STD	CHSETSTD	-	-		
Input RF BASEBAND(I&Q)	INPUT RF INPUT IQ	INPUT?	0: RF 1: Baseband(I&Q)		
Baseband Input AC DC	BBINPUT AC BBINPUT DC	BBINPUT?	0: AC 1: DC		
IQ Inverse NORMAL INVERSE	IQMD NORM IQMD INV	IQMD?	0:NORMAL 1:INVERSE		
Auto Level setting Auto Level OFF Auto Level ON	ALS OFF ALS ON	ALS?	0: OFF 1: ON		
DC CAL	CLDC	-	-		

Table 4-12 TRANSIENT Key

Function	Listener Code	Talker Request		Remarks	
		Code	Output Format		
T-Domain Power	Auto Level Set	AUTOWFL TDPAUTOLVL	-	-	
	Trigger Setup				
	Trigger Source				
	FREERUN	TRGSRC FREE TDPTRGSRC FREE	TRGSRC? TDPTRGSRC?	0:FREERUN 1:VIDEO	
	VIDEO	TRGSRC VIDEO TDPTRGSRC VIDEO		2:IF 3:EXT	
	IF	TRGSRC IF TDPTRGSRC IF			
	EXT	TRGSRC EXT TDPTRGSRC EXT			
	Trigger Slope				
	+	TRGSLP RISE TDPTRGSLP RISE	TRGSLP? TDPTRGSLP?	0:- 1:+	
	-	TRGSLP FALL TDPTRGSLP FALL			
	Trigger Level	TRGLVL * TDPTRGLVL *	TRGLVL? TDPTRGLVL?	Integer (0 to 100)	
	Trigger Position	TRGPOS * TDPTRGPOS *	TRGPOS? TDPTRGPOS?	Integer (0 to 100)	
	Delay Time	TRGDT * TDPTRGDT *	TRGDT? TDPTRGDT?	Time	
Window Setup					
Window					
ON	TDPWDO ON TWDO ON	TDPWDO? TWDO?	0:OFF 1:ON		
OFF	TDPWDO OFF TWDO OFF				
Window Position	TDPWPOS * TWLX *	TDPWPOS? TWLX?	Time		
Window Width	TDPWWID * TWDX *	TDPWWID? TWDX?	Time		
Y Scale					
10dB/div	TDPDIV P10DB	TDPDIV?	0:10dB/div		
5dB/div	TDPDIV P5DB		1: 5dB/div		
2dB/div	TDPDIV P2DB		2: 2dB/div		

4.2 GPIB Command Codes

Table 4-12 TRANSIENT Key

Function	Listener Code	Talker Request		Remarks	
		Code	Output Format		
T-Domain Power	Average Times	TDPAVGCNT *	TDPAVGCNT?	Integer (1:OFF,2 to 999)	
		TDPAVG *	TDPAVG?	Integer (1:OFF,2 to 999)	*1
		CAVGAT *	CAVGAT?	Integer (1:OFF,2 to 999)	*1
	Average Mode				
	TRACE AVG	TDPAVGMD TRACE	TDPAVGMD?	0: Trace Avg	
	MAX HOLD	TDPAVGMD MAX		1: Max Hold	
	POWER AVG	TDPAVGMD POWER		2: Power Avg	
	NUMERIC	TDPAVGMD NUMERIC		3: Numeric	
	Template				
	Template				
ON	TDPTMPL ON TLMT ON	TDPTMPL? TLMT?	0:OFF 1:ON		
OFF	TDPTMPL OFF TLMT OFF				
Template Shift					
Shift X	TDPTMPLSX * TLMSFT *	TDPTMPLSX? TLMSFT?	Time Time		
Shift Y	TDPTMPLSY * TLMASFT *	TDPTMPLSY? TLMASFT?	Level Level		
Template Edit					
Template UP/LOW select	TDPTMPLSEL UP TDPTMPLSEL LOW	TDPTMPLSEL?	0:UP 1:LOW		
Copy from STD	TDPTMPLCP	-	-		
	LMCPSL STD				
Data entry	TDPTMPLED *,* TLMIN *,*	-	t1,l1 l1:Time l1:Level (dBm/W/dBμV)		
Init Table	TDPTMPLCLR TLMDEL	-	-		
Parameter Setup					
Detector					
Normal	TDPDET NRM	TDPDET?	0:Normal		
Posi	TDPDET POS		1:Posi		
Nega	TDPDET NEG		2:Nega		
Sample	TDPDET SMP		3:Sample		

*1: Average Mode is set to POWER AVG.

Table 4-12 TRANSIENT Key

Function	Listener Code	Talker Request		Remarks
		Code	Output Format	
T-Domain Power	Display Unit dBm W dB μ V	TDPUNIT DBM TDPUNIT W TDPUNIT DBUV	TDPUNIT?	0:dBm 1:W 2:dB μ V
	Template Couple to Power ON OFF	TDPTMPLPW ON TDPTMPLPW OFF	TDPTMPLPW?	0:OFF 1:ON
	Template Limit	TDPTMPLBTM *	TDPTMPLBTM?	Level (dBm/W/dB μ V)
	Judgment ON OFF	TDPJDG ON TDPJDG OFF	TDPJDG?	0:OFF 1:ON
	Upper Limit	TDPJDGUP *	TDPJDGUP?	Level
	Lower Limit	TDPJDGLOW *	TDPJDGLOW?	Level
	Set to STD	TDPSETSTD	-	-
	Starts measurement T-Domain Power	GATEPOW TDPMEAS	-	-
	Starts measurement in the same mode	SI	-	-
	Measurement results T-Domain Power	-	TDPMEAS? GATEPOW?	11,j1 11:Level (dBm/W/dBmV) j1:Integer (0:FAIL,1:PASS, -1:Judgment OFF) 11:Level (dBm)

4.2 GPIB Command Codes

Table 4-12 TRANSIENT Key

Function	Listener Code	Talker Request		Remarks	
		Code	Output Format		
ON/OFF Ratio	Auto Level Set	OORAUTOLVL	-	-	
	Trigger Setup				
	Trigger Source				
	FREERUN	OORTRGSRC FREE	OORTRGSRC?	0:FREERUN	
	VIDEO	OORTRGSRC VIDEO		1:VIDEO	
	IF	OORTRGSRC IF		2:IF	
	EXT	OORTRGSRC EXT		3:EXT	
	Trigger Slope				
	+	OORTRGSLP RISE	OORTRGSLP?	0:-	
	-	OORTRGSLP FALL		1:+	
	Trigger Level	OORTRGLVL *	OORTRGLVL?	Integer (0 to 100)	
	Trigger Position	OORTRGPOS *	OORTRGPOS?	Integer (0 to 100)	
	Delay Time	OORTRGDT *	OORTRGDT?	Time	
	Window Setup				
	Window				
	ON	OORWDO ON	OORWDO?	0:OFF	
	OFF	OORWDO OFF		1:ON	
	ON Position	OORWONPOS *	OORWONPOS?	Time	
	ON Width	OORWONWID *	OORWONWID?	Time	
	OFF Position	OORWOFPOS *	OORWOFPOS?	Time	
OFF Width	OORWOFWID *	OORWOFWID?	Time		
Y Scale					
10dB/div	OORDIV P10DB	OORDIV?	0:10dB/div		
5dB/div	OORDIV P5DB		1:5dB/div		
2dB/div	OORDIV P2DB		2:2dB/div		
Average Times	OORAVGCNT *	OORAVGCNT?	Integer (1:OFF,2 to 999)		
	OORAVG *	OORAVG?	Integer (1:OFF,2 to 999)	*1	
	CAVGRAT *	CAVGRAT?	Integer (1:OFF,2 to 999)	*1	
Average Mode					
TRACE AVG	OORAVGMD TRACE	OORAVGMD?	0: Trace Avg		
MAX HOLD	OORAVGMD MAX		1: Max Hold		
POWER AVG	OORAVGMD POWER		2: Power Avg		
NUMERIC	OORAVGMD NUMERIC		3: Numeric		

*1: Average Mode is set to NUMERIC.

Table 4-12 TRANSIENT Key

Function	Listener Code	Talker Request		Remarks
		Code	Output Format	
ON/OFF Ratio	Parameter Setup			
	Detector			
	Normal	OORDET NRM	OORDET?	0:Normal
	Posi	OORDET POS		1:Posi
	Nega	OORDET NEG		2:Nega
	Sample	OORDET SMP		3:Sample
	Display Unit			
	dBm	OORUNIT DBM	OORUNIT?	0:dBm
	W	OORUNIT W		1:W
	dB μ V	OORUNIT DBUV		2:dB μ V
	Judgment			
	ON	OORJDG ON	OORJDG?	0:OFF
	OFF	OORJDG OFF		1:ON
Upper Limit	OORJDGUP *	OORJDGUP?	Level	
Set to STD	OORSETSTD	-	-	
Starts measurement				
ON/OFF Ratio	OORMEAS RATIO	-	-	
Starts measurement in the same mode	SI	-	-	
Measurement results				
ON/OFF Ratio	-	OORMEAS?	l1,l2,d1,j1 l1:ON Level (dBm/W/dB μ V) l2:OFF Level (dBm/W/dB μ V) d1:ON/OFF Ratio (dB) j1:Integer (0:FAIL,1:PASS, -1:Judgment OFF)	
		RATIO?	d1,l1 d1:ON/OFF Ratio (dB) l1:Gated Power (dBm)	

4.2 GPIB Command Codes

Table 4-12 TRANSIENT Key

Function	Listener Code	Talker Request		Remarks	
		Code	Output Format		
T-Domain Spurious	Auto Level Set	TDSAUTOLVL	-	-	
	Trigger Setup				
	Trigger Source				
	FREERUN	TDSTRGSRC FREE TRSPMD FREE	TDSTRGSRC? TRSPMD?	0:FREERUN 2:IF 3:EXT	
	IF	TDSTRGSRC IF TRSPMD IF			
	EXT	TDSTRGSRC EXT TRSPMD EXT			
	Trigger Slope				
	+	TDSTRGSLP RISE TRSPSLP RISE	TDSTRGSLP? TRSPSLP?	0:- 1:+	
	-	TDSTRGSLP FALL TRSPSLP FALL			
	Trigger Level	TDSTRGLVL *	TDSTRGLVL?	Integer (0 to 100)	
	Trigger Position	TDSTRGPOS *	TDSTRGPOS?	Integer (0 to 100)	
	Delay Time	TDSTRGDT *	TDSTRGDT?	Time	
	Table				
	Table No. 1/2/3	TDSTBL *	TDSTBL?	Integer (1 to 3)	
	Table Edit	TDSTBLED *,*	-	f1,l1 f1:Frequency l1:Limit Level	
	Load Table	TDSL D	-	-	
	Load Table 1/2/3	RCLTBL *	-	Integer (1 to 3)	
	Save Table	TDSSV	-	-	
	Save Table 1/2/3	SVSTBL *	-	Integer (1 to 3)	
	Init Table	TDSCLR DELSTBL	-	-	
	Table Freq. Input				
	ABS	TDSTBLF ABS	TDSTBLF?	0:ABS	
	REL	TDSTBLF REL		1:REL	
	Average Times	TDSAVGCNT *	TDSAVGCNT?	Integer (1:OFF,2 to 999)	
		TDSAVG *	TDSAVG?	Integer (1:OFF,2 to 999)	*1

*1: When Detector is set to Positive, Average Mode is set to MAX HOLD. When Detector is set to something other than Positive, Average Mode is set to TRACE AVG.

Table 4-12 TRANSIENT Key

Function	Listener Code	Talker Request		Remarks
		Code	Output Format	
T-Domain Spurious	Average Mode TRACE AVG MAX HOLD POWER AVG NUMERIC	TDSAVGMD TRACE TDSAVGMD MAX TDSAVGMD POWER TDSAVGMD NUMERIC	TDSAVGMD?	0: Trace Avg 1: Max Hold 2: Power Avg 3: Numeric
	Parameter Setup Detector Normal Posi Nega Sample	TDSDET NRM TDSDET POS TDSDET NEG TDSDET SMP	TDSDET?	0:Normal 1:Posi 2:Nega 3:Sample
	Display Unit dBm W dB μ V	TDSUNIT DBM TDSUNIT W TDSUNIT DBUV	TDSUNIT?	-
	Judgment ON OFF	TDSJDG ON TDSJDG OFF	TDSJDG?	0:OFF 1:ON
	Result Peak RMS	TDSRES PK TDSRES RMS	TDSRES?	0:Peak 1:RMS
	Multiplier	TDSMULTI *	TDSMULTI?	Real number
	Peak Marker Y-Delta	TDSPKMKY *	TDSPKMKY?	Real number
	Preselector 1.6G 3.6G	TDSPRE 16G TDSPRE 36G	TDSPRE?	0:1.6G 1:3.6G
	Set to Default	TDSSETSTD	-	-
	Starts measurement Spurious	TDSMEAS SPUR	-	-
	Starts measurement in the same mode	SI	-	-
	Measurement results Spurious	-	TDSMEAS?	n<CR+LF> +f1,l1,j1<CR+LF> +fn,ln,jn<CR+LF> n:Amount (Integer) fn:Frequency ln:Level (dBm/W/dB μ V)

4.2 GPIB Command Codes

Table 4-12 TRANSIENT Key

Function		Listener Code	Talker Request		Remarks
			Code	Output Format	
T-Domain Spurious			SPULVL?	jn:Integer (0:FAIL,1:PASS, -1:Judgment OFF) n<CR+LF> +f1,l1<CR+LF> +fn,ln<CR+LF> n:Amount (Integer) fn:Frequency ln:Level (dBm)	
F-Domain Power	Auto Level Set	FDPAUTOLVL	-	-	
	Gate Setup				
	ON	TGTSETUP ON	TGTSETUP?	0:OFF	
	OFF	TGTSETUP OFF		1:ON	
	Trigger Source				
	FREERUN	TGTTRG FREE	TGTTRG?	0:FREERUN	
	VIDEO	TGTTRG VIDEO		1:VIDEO	
	IF	TGTTRG IF		2:IF	
	EXT	TGTTRG EXT		3:EXT	
	Trigger Slope				
	-	TGTTRGSLP FALL	TGTTRGSLP?	0:-	
	+	TGTTRGSLP RISE		1:+	
	Trigger Level	TGTTRGLVL *	TGTTRGLVL?	Integer (0 to 100)	
	Trigger Position	TGTTRGPOS *	TGTTRGPOS?	Integer (0 to 100)	
	Delay Time	TGTTRGDT *	TGTTRGDT?	Time	
Gate Source					
Trigger	TGTSRC TRG	TGTSRC?	0:Trigger		
Ext Gate	TGTSRC EXT		1:EXT		
Gate Position	TGTPOS *	TGTPOS?	Time		
Gate Width	TGTWID *	TGTWID?	Time		
Detector					
Normal	TGTDET NRM	TGTDET?	0:Normal		
Posi	TGTDET POS		1:Posi		
Nega	TGTDET NEG		2:Nega		
Sample	TGTDET SMP		3:Sample		
Gated Sweep ON/OFF					
ON	TGTSWP ON	TGTSWP?	0:OFF		
OFF	TGTSWP OFF		1:ON		

Table 4-12 TRANSIENT Key

Function	Listener Code	Talker Request		Remarks	
		Code	Output Format		
F-Domain Power	Window Setup				
	Window				
	ON	FDPWDO ON	FDPWDO?	0:OFF	
	OFF	FDPWDO OFF		1:ON	
	Window Position	FDPWPOS * CPWLX *	FDPWPOS? CPWLX?	Frequency	
	Window Width	FDPWWID * CPWDX *	FDPWWID? CPWDX?	Frequency	
	Y Scale				
	10dB/div	FDPDIV P10DB CPWDIV P10DB	FDPDIV? CPWDIV?	0:10dB/div 1:5dB/div 2:2dB/div	
	5dB/div	FDPDIV P5DB CPWDIV P5DB			
	2dB/div	FDPDIV P2DB CPWDIV P2DB			
	Average Times	FDPAVGCNT * FDPAVG * CAVGCHP *	FDPAVGCNT? FDPAVG? CAVGCHP?	Integer (1:OFF,2 to 999) Integer (1:OFF,2 to 999) Integer (1:OFF,2 to 999)	 *1 *1
	Average Mode				
	TRACE AVG	FDPAVGMD TRACE	FDPAVGMD?	0: Trace Avg	
MAX HOLD	FDPAVGMD MAX		1: Max Hold		
POWER AVG	FDPAVGMD POWER		2: Power Avg		
NUMERIC	FDPAVGMD NUMERIC		3: Numeric		
Parameter Setup					
Detector					
Normal	FDPDET NRM	FDPDET?	0:Normal		
Posi	FDPDET POS		1:Posi		
Nega	FDPDET NEG		2:Nega		
Sample	FDPDET SMP		3:Sample		
Display Unit					
dBm	FDPUNIT DBM	FDPUNIT?	0:dBm		
W	FDPUNIT W		1:W		
dB μ V	FDPUNIT DBUV		2:dB μ V		
Judgment					
ON	FDPJDG ON	FDPJDG?	0:OFF		
OFF	FDPJDG OFF		1:ON		

*1: Average Mode is set to POWER AVG.

4.2 GPIB Command Codes

Table 4-12 TRANSIENT Key

Function		Listener Code	Talker Request		Remarks
			Code	Output Format	
F-Domain Power	Upper Limit	FDPJDGUP *	FDPJDGUP?	Level (dBm/W/dBμV)	
	Lower Limit	FDPJDGLOW *	FDPJDGLOW?	Level (dBm/W/dBμV)	
	Set to STD	FDPSETSTD	-	-	
	Starts measurement F-Domain Power	FDPMEAS CCHPOW	-	-	
	Starts measurement in the same mode	SI	-	-	
	Measurement results F-Domain Power	-	FDPMEAS? CCHPOW?	l1,j1 l1:Level (dBm/W/dBmV) j1:Integer (0:FAIL,1:PASS, -1:Judgment OFF) l1,l2 l1:Level (dBm) l2:Level (dBm/Hz)	
OBW	Auto Level Set	OBWAUTOLVL	-	-	
	OBW%	OBWPER *	OBWPER?	Real number (0.5 to 99.5)	
		COBWPER *	COBWPER?		
	Average Times	OBWAVGCNT *	OBWAVGCNT?	Integer (1:OFF,2 to 999)	
		OBWAVG *	OBWAVG?	Integer (1:OFF,2 to 999)	*1
		CAVGOBW *	CAVGOBW?	Integer (1:OFF,2 to 999)	*1
	Average Mode				
TRACE AVG	OBWAVGMD TRACE	OBWAVGMD?	0: Trace Avg		
MAX HOLD	OBWAVGMD MAX		1: Max Hold		
POWER AVG	OBWAVGMD POWER		2: Power Avg		
NUMERIC	OBWAVGMD NUMERIC		3: Numeric		

*1: When Detector is set to Positive, Average Mode is set to MAX HOLD. When Detector is set to something other than Positive, Average Mode is set to TRACE AVG.

Table 4-12 TRANSIENT Key

Function	Listener Code	Talker Request		Remarks
		Code	Output Format	
OBW	Parameter Setup			
	Detector			
	Normal	OBWDET NRM COBWDET NRM	OBWDET? COBWDET?	0:Normal 1:Posi
	Posi	OBWDET POS COBWDET POS		2:Nega 3:Sample
	Nega	OBWDET NEG COBWDET NEG		
	Sample	OBWDET SMP COBWDET SMP		
	Judgment			
	ON	OBWJDG ON	OBWJDG?	0:OFF
	OFF	OBWJDG OFF		1:ON
	Upper Limit	OBWJDGUP *	OBWJDGUP?	Frequency
	Lower Limit	OBWJDGLOW *	OBWJDGLOW?	Frequency
	Set to STD	OBWSETSTD	-	-
	Starts measurement			
OBW	OBWMEAS COBW	-	-	
Starts measurement in the same mode	SI	-	-	
Measurement results				
OBW	-	OBWMEAS? COBW?	f1,f2,f3,j1 f1:OBW Frequency f2:Lower side frequency f3:Higher side frequency j1: Integer (0: FAIL, 1: PASS, -1: Judgment OFF) f1,f2,f3 f1:OBW Frequency f2:Lower side frequency f3:Higher side frequency	

4.2 GPIB Command Codes

Table 4-12 TRANSIENT Key

Function	Listener Code	Talker Request		Remarks	
		Code	Output Format		
Due to Transient	Auto Level Set	DTSAUTOLVL	-	-	
	Template				
	Template				
	ON	DTSTMPL ON	DTSTMPL?	0: OFF	
	OFF	DTSTMPL OFF		1: ON	
	Template Shift				
	Shift X	DTSTMPLSX *	DTSTMPLSX?	Frequency	
	Shift Y	DTSTMPLSY *	DTSTMPLSY?	Level	
	Margin delta X	DTSTMPLDX *	DTSTMPLDX?	Frequency (0:OFF)	
	Copy from STD	DTSTMPLCP	-	-	
Data entry	DTSTMPLD *,*	-	f1,l1 f1: Frequency l1: Level (dBm/W/dBμV)		
Init Table	DTSTMPLCLR	-	-		
Marker Edit	Copy from STD	DTSMKRCP	-	-	Set the reference bandwidth to f2, after initializing the table.
	Data entry	DTSMKRED *,*,*,*	-	d1,f1,f2,l1 d1: (0:Normal 1: Integral 2: √Nyquist) f1: Offset Frequency f2: Band width l1: Limit level	
	Init Table	DTSMKRCLR	-	-	
Average Times	DTSAVGCNT *	DTSAVGCNT?	Integer (1:OFF, 2 to 999)	*1	
	DTSAVG *	DTSAVG?	Integer (1:OFF, 2 to 999)		
Average Mode	TRACE AVG	DTSAVGMD TRACE	DTSAVGMD?	0: Trace Avg	
	MAX HOLD	DTSAVGMD MAX		1: Max Hold	
	POWER AVG	DTSAVGMD POWER		2: Power Avg	
	NUMERIC	DTSAVGMD NUMERIC		3: Numeric	

*1: When Detector is set to Positive, Average Mode is set to MAX HOLD. When Detector is set to something other than Positive, Average Mode is set to TRACE AVG.

Table 4-12 TRANSIENT Key

Function	Listener Code	Talker Request		Remarks
		Code	Output Format	
Due to Transient	Parameter Setup			
	Detector			
	Normal	DTSDET NRM	DTSDET?	0: Normal
	Posi	DTSDET POS		1: Posi
	Nega	DTSDET NEG		2: Nega
	Sample	DTSDET SMP		3: Sample
	Display Unit			
	dBm	DTSUNIT DBM	DTSUNIT?	0: dBm
	W	DTSUNIT W		1: W
	dB μ V	DTSUNIT DBUV		2: dB μ V
	Template Couple to Power			
	ON	DTSTMPLPW ON	DTSTMPLPW?	0: OFF
	OFF	DTSTMPLPW OFF		1: ON
	Template Limit	DTSTMPLBTM *	DTSTMPL-BTM?	Level (dBm/W/dB μ V)
	Judgment			
ON	DTSJDG ON	DTSJDG?	0: OFF	
OFF	DTSJDG OFF		1: ON	
Freq. Setting				
CFSP	DTSFRMD CFSP	DTSFRMD?	0: Center/Span mode	
STSP	DTSFRMD STSP		1: Start/Stop mode	
Result				
ABS	DTSRES ABS	DTSRES?	0: Absolute	
REL	DTSRES REL		1: Relative	
MKR	DTSRES MKR		2: Marker	
Ref Power				
MKR	DTSREF MKR	DTSREF?	0: Reference Marker	
MOD	DTSREF MOD		1: Modulation	
Symbol Rate 1/T	DTSSYMRT *	DTSSYMRT?	Frequency	
Rolloff Factor	DTSRFACT *	DTSRFACT?	Real number	
Set to STD	DTSSSETSTD	-	-	
Starts measurement				
Due to Transient	DTSMEAS	-	-	
Starts measurement in the same mode	SI	-	-	

4.2 GPIB Command Codes

Table 4-12 TRANSIENT Key

Function		Listener Code	Talker Request		Remarks
			Code	Output Format	
Due to Transient	Measurement results Due to Transient	-	DTSMEAS?	n<CR+LF> +d1,j1<CR+LF> +dn,jn<CR+LF> n: Amount (Integer) dn: Power jn: Integer (0: FAIL, 1: PASS, -1: Judgment OFF)	
	Ref. Power	-	COBWCP?	l1,l2,d1,d2,d3,d4 l1: Level (dBm: Reference power) l2: Level (W: Reference power) d1: -1st ACP(dBc) d2: +1st ACP(dBc) d3: -2nd ACP(dBc) d4: +2nd ACP(dBc)	
Due to Modulation	Auto Level Set	DTMAUTOLVL	-	-	
	Gate Setup ON OFF	TGTSETUP ON TGTSETUP OFF	TGTSETUP?	0: OFF 1: ON	
	Trigger Source FREERUN VIDEO IF EXT	TGTTRG FREE TGTTRG VIDEO TGTTRG IF TGTTRG EXT	TGTTRG?	0: FREERUN 1: VIDEO 2: IF 3: EXT	
	Trigger Slope - +	TGTTRGSLP FALL TGTTRGSLP RISE	TGTTRGSLP?	0: - 1: +	
	Trigger Level	TGTTRGLVL *	TGTTRGLVL?	Integer (0 to 100)	
	Trigger Position	TGTTRGPOS *	TGTTRGPOS?	Integer (0 to 100)	
	Delay Time	TGTTRGDT *	TGTTRGDT?	Time	
	Gate Source Trigger Ext Gate	TGTSRC TRG TGTSRC EXT	TGTSRC?	0: Trigger 1: EXT	
	Gate Position	TGTPOS *	TGTPOS?	Time	
	Gate Width	TGTWID *	TGTWID?	Time	

Table 4-12 TRANSIENT Key

Function	Listener Code	Talker Request		Remarks
		Code	Output Format	
Duc to Modulation	Detector			
	Normal	TGTDET NRM	TGTDET?	0: Normal
	Posi	TGTDET POS		1: Posi
	Nega	TGTDET NEG		2: Nega
	Sample	TGTDET SMP		3: Sample
	Gated Sweep ON/OFF			
	ON	TGTSWP ON	TGTSWP?	0: OFF
	OFF	TGTSWP OFF		1: ON
	Template			
	Template			
	ON	DTMTMPL ON	DTMTMPL?	0: OFF
	OFF	DTMTMPL OFF		1: ON
	Template Shift			
	Shift X	DTMTMPLSX *	DTMTMPLSX?	Frequency
Shift Y	DTMTMPLSY *	DTMTMPLSY?	Level	
Margin delta X	DTMTMPLDX *	DTMTMPLDX?	Frequency (0:OFF)	
Copy from STD	DTMTMPLCP	-	-	
Data entry	DTMTMPLED *,*	-	f1,l1 f1: frequency l1: Level (dBm/W/dBμV)	
Init Table	DTMTMPLCLR	-	-	
Marker Edit				
Copy from STD	DTMMKRCP	-	-	
Data entry	DTMMKRED *,*,*,*	-	d1,f1,f2,l1 d1: (0:Normal 1: Integral 2: √Nyquist) f1: Offset Frequency f2: Bandwidth l1: Limit Level	
Init Table	DTMMKRCLR	-	-	
Average Times	DTMAVGCNT *	DTMAVGCNT?	Integer (1:OFF, 2 to 999)	
	DTMAVG *	DTMAVG?	Integer (1:OFF, 2 to 999)	

*1: When Detector is set to Positive, Average Mode is set to MAX HOLD. When Detector is set to something other than Positive, Average Mode is set to TRACE AVG.

4.2 GPIB Command Codes

Table 4-12 TRANSIENT Key

Function	Listener Code	Talker Request		Remarks
		Code	Output Format	
Due to Modulation	Average Mode TRACE AVG MAX HOLD POWER AVG NUMERIC	DTMAVGMD TRACE DTMAVGMD MAX DTMAVGMD POWER DTMAVGMD NUMERIC	DTMAVGMD?	0: Trace Avg 1: Max Hold 2: Power Avg 3: Numeric
	Parameter Setup Detector Normal Posi Nega Sample	DTMDET NRM DTMDET POS DTMDET NEG DTMDET SMP	DTMDET?	0: Normal 1: Posi 2: Nega 3: Sample
	Display Unit dBm W dB μ V	DTMUNIT DBM DTMUNIT W DTMUNIT DBUV	DTMUNIT?	0: dBm 1: W 2: dB μ V
	Template Couple to Power ON OFF	DTMTMPLPW ON DTMTMPLPW OFF	DTMTMPLPW?	0: OFF 1: ON
	Template Limit	DTMTMPLBTM *	DTMTMPLBTM?	Level (dBm/W/dB μ V)
	Judgment ON OFF	DTMJJDG ON DTMJJDG OFF	DTMJJDG?	0: OFF 1: ON
	Freq. Setting CFSP STSP	DTMFRMD CFSP DTMFRMD STSP	DTMFRMD?	0: Center/Span mode 1: Start/Stop mode
	Result ABS REL MKR	DTMRES ABS DTMRES REL DTMRES MKR	DTMRES?	0: Absolute 1: Relative 2: Marker

Table 4-12 TRANSIENT Key

Function	Listener Code	Talker Request		Remarks	
		Code	Output Format		
Due to Modulation	Ref Power MKR MOD	DTMREF MKR DTMREF MOD	DTMREF MKR?	0: Reference Marker 1: Modulation	
	Symbol Rate 1/T	DTMSYMRT *	DTMSYMRT?	Frequency	
	Rolloff Factor	DTMRFACT *	DTMRFACT?	Real number	
	Set to STD	DTMSETSTD	-	-	
	Starts measurement Due to Modulation	DTMMEAS	-	-	
	Starts measurement in the same mode	SI	-	-	
	Measurement results Duc to Modulation	-	DTMMEAS?	n<CR+LF>+d1, j1<CR+LF>+dn,jn<CR+LF> n: Amount (Integer) dn: Power jn: Integer (0: FAIL, 1: PASS, -1: Judgment OFF)	
	Ref. Power	-	DTMREFPWR?	Level	
Inband Spurious (1)	Auto Level Set	SPRAUTOLVL	-	-	Set the refer- ence band- width to f2, after initializ- ing the table.
	Template Template ON OFF	SPRTMPL ON SPRTMPL OFF	SPRTMPL?	0: OFF 1: ON	
	Template Shift Shift X Shift Y	SPRTMPLSX * SPRTMPLSY *	SPRTMPLSX? SPRTMPLSY?	Frequency Level	
	Margin delta X	SPRTMPLDX *	SPRTMPLDX?	Frequency (0:OFF)	
	Copy from STD	SPRTMPLCP	-	-	
	Data entry	SPRTMPLED *,*	-	f1,l1 f1: Frequency l1: Level (dBm/W/dBμV)	
	Init Table	SPRTMPLCLR	-	-	
	Marker Edit Copy from STD	SPRMKRCP	-	-	
	Data entry	SPRMKRED *,*,* *,*,*	-	d1,f1,f2,l1 d1:(0:Peak, 1:Integral) f1: Start Frequency f2: Stop Frequency l1: Limit Level	
	Init Table	SPRMKRCLR	-	-	

4.2 GPIB Command Codes

Table 4-12 TRANSIENT Key

Function	Listener Code	Talker Request		Remarks	
		Code	Output Format		
Inband Spurious (1)	Average Times	SPRAVGCNT *	SPRAVGCNT?	Integer (1:OFF, 2 to 999)	
		SPRAVG *	SPRAVG?	Integer (1:OFF, 2 to 999)	*1
		CAVGSPR *	CAVGSPR?	Integer (1:OFF, 2 to 999)	*1
	Average Mode				
	TRACE AVG	SPRAVGMD TRACE	SPRAVGMD?	0: Trace Avg	
	MAX HOLD	SPRAVGMD MAX		1: Max Hold	
	POWER AVG	SPRAVGMD POWER		2: Power Avg	
	Parameter Setup				
Detector					
Normal	SPRDET NRM	SPRDET?	0: Normal		
Posi	SPRDET POS		1: Posi		
Nega	SPRDET NEG		2: Nega		
Sample	SPRDET SMP		3: Sample		
Display Unit					
dBm	SPRUNIT DBM	SPRUNIT?	0: dBm		
W	SPRUNIT W		1: W		
dBμV	SPRUNIT DBUV		2: dBμV		
Template Couple to Power					
ON	SPRTMPLPW ON	SPRTMPLPW?	0: OFF		
OFF	SPRTMPLPW OFF		1: ON		
Template Limit	SPRTMPLBTM *	SPRTMPLBTM?	Level (dBm/W/dBμV)		
Judgment					
ON	SPRJGDG ON	SPRJGDG?	0: OFF		
OFF	SPRJGDG OFF		1: ON		
Freq. Setting					
CFSP	SPRFRMD CFSP	SPRFRMD?	0: Center/Span mode		
STSP	SPRFRMD STSP		1: Start/Stop mode		

*1: When Detector is set to Positive, Average Mode is set to MAX HOLD. When Detector is set to something other than Positive, Average Mode is set to TRACE AVG.

Table 4-12 TRANSIENT Key

Function	Listener Code	Talker Request		Remarks
		Code	Output Format	
Inband Spurious (1)	Result			
	ABS	SPRRES ABS SPRMOD ABS	SPRRES? SPRMOD?	0: Absolute 1: Relative 2: Marker
	REL	SPRRES REL SPRMOD REL		
	MKR	SPRRES MKR SPRMOD MKR		
	Ref Power			
	MKR	SPRREF MKR SPRREF SWP	SPRREF?	0: Reference Marker 1: Modulation
	MOD	SPRREF MOD SPRREF DSP		
	Peak Marker Y-Delta	SPRPKMKY *	SPRPKMKY?	Real number
	Set to STD	SPRSETSTD	-	-
	Starts measurement			
Inband Spurious	SPRMEAS CINBSPR	-	-	
Starts measurement in the same mode	SI	-	-	
Measurement results				
Inband Spurious	-	SPRMEAS?	n<CR+LF> +f1,l1,j1<CR+LF> +fn,ln,jn<CR+LF> n: Amount (Integer) fn: Frequency ln: Level (dBm/W/dBμV) jn: Integer (0: FAIL, 1: PASS, -1: Judgment OFF)	
max.value output on the each period	-	CINBMAX?	n1,f1,l1....n4,f4,l4 (4set output) nn: 0;Disable (Without data) 1; Enable (With data) fn: Frequency ln: Level (dBm)	
Ref. Power	-	SPRREFPWR?	Level	
Inband Spurious (2)	Auto Level Set	SPR2AUTOLVL	-	-
	Template			
	Template ON OFF	SPR2TMPL ON SPR2TMPL OFF	SPR2TMPL?	0: OFF 1: ON

4.2 GPIB Command Codes

Table 4-12 TRANSIENT Key

Function	Listener Code	Talker Request		Remarks
		Code	Output Format	
Inband Spurious (2)	Template Shift			
	Shift X	SPR2TMPLSX *	SPR2TMPLSX?	Frequency
	Shift Y	SPR2TMPLSY *	SPR2TMPLSY?	Level
	Margin delta X	SPR2TMPLDX *	SPR2TMPLDX?	Frequency (0:OFF)
	Copy from STD	SPR2TMPLCP	-	-
	Data entry	SPR2TMPLD *,*	-	f1,l1 f1: Frequency l1: Level (dBm/W/dBμV)
	Init Table	SPR2TMPLCLR	-	-
	Marker Edit			
	Copy from STD	SPR2MKRCP	-	-
	Data entry	SPR2MKRED *,*,*,*	-	d1,f1,f2,l1 d1:(0:Peak, 1:Integral) f1: Start Frequency f2: Stop Frequency l1: Limit Level
	Init Table	SPR2MKRCLR	-	-
	Average Times	SPR2AVGCNT *	SPR2AVGCNT?	Integer (1:OFF, 2 to 999)
		SPR2AVG *	SPR2AVG?	Integer (1:OFF, 2 to 999)
	Average Mode			
POWER AVG	SPR2AVGMD POWER	SPR2AVGMD?	2: Power Avg	
Parameter Setup				
Detector				
Normal	SPR2DET NRM	SPR2DET?	0: Normal	
Posi	SPR2DET POS		1: Posi	
Nega	SPR2DET NEG		2: Nega	
Sample	SPR2DET SMP		3: Sample	
Display Unit				
dBm	SPR2UNIT DBM	SPR2UNIT?	0: dBm	
W	SPR2UNIT W		1: W	
dBμV	SPR2UNIT DBUV		2: dBμV	

Table 4-12 TRANSIENT Key

Function	Listener Code	Talker Request		Remarks	
		Code	Output Format		
Inband Spurious (2)	Template Couple to Power ON OFF	SPR2TMPLPW ON SPR2TMPLPW OFF	SPR2TMPLPW?	0: OFF 1: ON	
	Template Limit Judgment ON OFF	SPR2TMPLBTM * SPR2JDG ON SPR2JDG OFF	SPR2TMPLBTM? SPR2JDG?	Level (dBm/W/dBμV) 0: OFF 1: ON	
	Freq. Setting CFSP STSP	SPR2FRMD CFSP SPR2FRMD STSP	SPR2FRMD?	0: Center/Span mode 1: Start/Stop mode	
	Result ABS REL MKR	SPR2RES ABS SPR2RES REL SPR2RES MKR	SPR2RES?	0: Absolute 1: Relative 2: Marker	
	Ref Power MKR MOD	SPR2REF MKR SPR2REF MOD	SPR2REF?	0: Reference Marker 1: Modulation	
	Peak MKR Y-Delta	SPR2PKMKY *	SPR2PKMKY?	Real number	
	Band Conversion ON OFF	SPR2CONV ON SPR2CONV OFF	SPR2CONV?	0: OFF 1: ON	
	Integral Band	SPR2INTE *	SPR2INTE?	Frequency	
	Start Offset	SPR2OFSST *	SPR2OFSST?	Frequency	
	Stop Offset	SPR2OFSSP *	SPR2OFSSP?	Frequency	
	Set to STD	SPR2SETSTD	-	-	
	Starts measurement Inband Spurious	SPR2MEAS	-	-	
	Starts measurement in the same mode	SI	-	-	
	Measurement results Inband Spurious	-	SPR2MEAS?	n<CR+LF> +f1,l1 j1<CR+LF> +fn,ln,jn<CR+LF> n: Amount (Integer) fn: Frequency ln: Level (dBm/W/dBμV) jn: Integer (0: FAIL, 1: PASS, -1: Judgment OFF)	
	Ref. Power	-	SPR2REFPWR?	Level	

4.2 GPIB Command Codes

Table 4-12 TRANSIENT Key

Function	Listener Code	Talker Request		Remarks	
		Code	Output Format		
Outband Spurious	Auto Level Set	FDSAUTOLVL	-	-	*1
	Table				
	Copy from STD	FDSCP			
	Table No.1/2/3	FDSTBL *	FDSTBL?	Integer (1 to 3)	
	Table Edit	FDSTBLED *,*,*,*,*,*	-	f1,f2,f3,f4,d1,l1 f1: Start frequency f2: Stop frequency f3: RBW f4: VBW d1: Sweep time l1: Limit Level	
	Load Table	FDSLDD	-	-	
	Save Table	FDSSV	-	-	
	Init Table	FDSCLR	-	-	
	Average Times	FDSAVGCNT *	FDSAVGCNT?	Integer (1:OFF, 2 to 999)	
		FDSAVG *	FDSAVG?	Integer (1:OFF, 2 to 999)	
	Average Mode				
	TRACE AVG	FDSAVGMD TRACE	FDSAVGMD?	0: Trace Avg	
	MAX HOLD	FDSAVGMD MAX		1: Max Hold	
	POWER AVG	FDSAVGMD POWER		2: Power Avg	
Parameter Setup					
Detector					
Normal	FDSDET NRM	FDSDET?	0: Normal		
Posi	FDSDET POS		1: Posi		
Nega	FDSDET NEG		2: Nega		
Sample	FDSDET SMP		3: Sample		
Display Unit					
dBm	FDSUNIT DBM	FDSUNIT?	0: dBm		
W	FDSUNIT W		1: W		
dBµV	FDSUNIT DBUV		2: dBµV		
Judgment					
ON	FDSJDG ON	FDSJDG?	0: OFF		
OFF	FDSJDG OFF		1: ON		
Peak Marker Y-Delta	FDSPKMKY *	FDSPKMKY?	Real number		

*1: When Detector is set to Positive, Average Mode is set to MAX HOLD. When Detector is set to something other than Positive, Average Mode is set to TRACE AVG.

Table 4-12 TRANSIENT Key

Function	Listener Code	Talker Request		Remarks	
		Code	Output Format		
Outband Spurious	Preselector 1.6G 3.6G	FDSPRE 16G FDSPRE 36G	FDSPRE?	0: 1.6G 1: 3.6G	
	Set to Default	FDSSETSTD	-	-	
	Starts measurement				
	Outband Spurious	FDSMEAS	-	-	
	Starts measurement in the same mode	SI	-	-	
Measurement results Outband Spurious	-	FDSMEAS?	n<CR+LF> +f1,l1,j1<CR+LF> +fn,ln,jn<CR+LF> n:Amount (Integer) fn: Frequency ln: Level (dBm/W/dBmV) jn: Integer(0: FAIL, 1: PASS,-1: Judgment OFF)		
Code Domain Power Cocf	Auto Level Set	AUTOLVL	-	-	
with FOR- WARD Link selected	Graphics				
	Select Type				
	Constellation	C2PCGTYP CON	C2PCGTYP?	0: Constellation	
	Constellation(Line)	C2PCGTYP CONLIN		1: Constellation(Line)	
	Constellation(Dot)	C2PCGTYP CONDOT		2: Constellation(Dot)	
	Constellation (Line&Dot)	C2PCGTYP CONLINDOT		3: Constellation (Line&Dot)	
	I EYE Diagram	C2PCGTYP ICHEYE		4: I EYE Diagram	
	Q EYE Diagram	C2PCGTYP QCHEYE		5: Q EYE Diagram	
	I/Q EYE Diagram	C2PCGTYP IQCHEYE		6: I/Q EYE Diagram	
	E.V.M. vs Chip	C2PCGTYP EVM		7: E.V.M. vs Chip	
Mag Error vs Chip	C2PCGTYP MAGERR		8: Mag Error vs Chip		
Plot Type					
AVG	C2PCGPLOT AVG	C2PCGPLOT?	0:AVG		
P-P	C2PCGPLOT PP		1:P-P		
Scale Setup					
Format					
GRAPH	C2PCFMT GRP	C2PCFMT?	0:GRAPH		
TABLE	C2PCFMT TBL		1:TABLE		
NUMERIC	C2PCFMT NUM		2:NUMERIC		
Display					
SINGLE	C2PCDISP SNGL	C2PCDISP?	0:SINGLE		
DUAL	C2PCDISP DUAL		1:DUAL		

4.2 GPIB Command Codes

Table 4-12 TRANSIENT Key

Function	Listener Code	Talker Request		Remarks
		Code	Output Format	
Code Domain Power Coef with FORWARD Link selected	Y Scale			
	ρ POWER	C2PCYSCL RHO C2PCYSCL POW	C2PCYSCL?	0: ρ 1:POWER
	τ PHASE	C2PCYSCL TAU C2PCYSCL PHA		2: τ 3:PHASE
	CDE	C2PCYSCL CDE		4:CDE
	ρ(ALL)	C2PCYSCL RHOALL		5:ρ(ALL)
	Y Scale Upper	C2YUPR *	C2YUPR?	Level (-50 to 70 dBm/dB/dBmpilot)
	Y/div			
	10/div	C2PDIV P10	C2PDIV?	0:10/div
	5/div	C2PDIV P5		1: 5/div
	Table Page			
	1	C2PCPAGE 1	C2PCPAGE?	1: 1/2
	2	C2PCPAGE 2		2: 2/2
	Parameter Setup			
	Meas Range	C2PCMRNG *	C2PCMRNG?	Integer (128 to 36864 chip)
	τ Offset	C2TOFS *	C2TOFS?	Time (-500.000 to 500.000 μsec)
	Complementary Filter			
	ON	C2CMPFLT ON	C2CMPFLT?	0:OFF
	OFF	C2CMPFLT OFF		1:ON
	Rolloff Factor	C2RFACT *	C2RFACT?	Real number (0.05 to 0.20)
	Equalizing Filter			
	ON	C2EQFLT ON	C2EQFLT?	0:OFF
	OFF	C2EQFLT OFF		1:ON
	PN Offset Search Mode			
ON	C2PNMOD ON	C2PNMOD?	0:OFF	
OFF	C2PNMOD OFF		1:ON	
PN Offset	C2PNOFS *	C2PNOFS?	Integer (0 to 511)	
Carrier Freq. Search				
500Hz	C2FSRCH 500HZ	C2FSRCH?	0:500Hz	
10kHz	C2FSRCH 10KHZ		1:10kHz	
500kHz	C2FSRCH 500KHZ		2:500k Hz	
Trigger Source				
INT	C2TRG INT	C2TRG?	0:INT	
EXT	C2TRG EXT		1:EXT	
INTRVL(EXT)	C2TRG INTRVL1		2:INTRVL(EXT)	
INTRVL	C2TRG INTRVL2		3:INTRVL	

Table 4-12 TRANSIENT Key

Function	Listener Code	Talker Request		Remarks
		Code	Output Format	
Code Domain Power Coef with FORWARD Link selected	EXT Trigger Slope +	C2TRGSLP RISE	C2TRGSLP?	0:-
	-	C2TRGSLP FALL		1:+
	Threshold	C2THRSH *	C2THRSH?	Level (-50 to 0 dB)
	Auto Rate ON	C2AUTORATE ON	C2AUTORATE?	0:OFF
	OFF	C2AUTORATE OFF		1:ON
	Channel Define ON	C2CHDEF ON	C2CHDEF?	0:OFF
	OFF	C2CHDEF OFF		1:ON
	Walsh Code Length	C2WLEN *	C2WLEN?	Integer (4/8/16/32/64/128)
	QOF	C2QOF *	C2QOF?	Integer (0/1/2/3)
	Bit Reversal Order ON	C2BITREV ON	C2BITREV?	0:OFF
	OFF	C2BITREV OFF		1:ON
	Channel Def. Table Total	C2CHTOTAL *	C2CHTOTAL ?	Integer (1 to 128)
	Edit Channel	C2CHEDIT *	C2CHEDIT?	Integer (0 to 127)
	Channel Name PICH	C2CHNAME PICH	C2CHNAME?	0:PICH
	SYNCH	C2CHNAME SYNCH		1:SYNCH
	PCH	C2CHNAME PCH		2:PCH
	BCH	C2CHNAME BCH		3:BCH
	CCCH	C2CHNAME CCCH		4:CCCH
	DCCH	C2CHNAME DCCH		5:DCCH
	FCH	C2CHNAME FCH		6:FCH
SCCH	C2CHNAME SCCH		7:SCCH	
SCH	C2CHNAME SCH		8:SCH	
QPCH	C2CHNAME QPCH		9:QPCH	
CPCCH	C2CHNAME CPCCH		10:CPCCH	
CACH	C2CHNAME CACH		11:CACH	
RC (Radio Configuration)	C2CHRC *	C2CHRC?	Integer (1/2/3/4/5)	
Data Rate	C2CHRATE *	C2CHRATE?	Integer (1200/1350/1500/1800 2400/2700/3600/4800 7200/9600/14400/19200 28800/38400/57600 76800/115200/153600 230400/307200) bps	
QOF	C2CHQOF *	C2CHQOF?	Integer (0/1/2/3)	

4.2 GPIB Command Codes

Table 4-12 TRANSIENT Key

Function	Listener Code	Talker Request		Remarks
		Code	Output Format	
Code Domain Power Coef with FORWARD Link selected	Walsh Code Number	C2CHWNUM *	C2CHWNUM?	Integer (0 to 127)
	Meas Options			
	CDP Graph Plot Type			
	AVERAGE	C2CDPLOT AVG	C2CDPLOT?	0:AVERAGE
	MAX	C2CDPLOT MAX		1:MAX
	MIN	C2CDPLOT MIN		2:MIN
	Power Unit			
	dBm	C2PWRUNIT DBM	C2PWRUNIT?	0:dBm
	dB	C2PWRUNIT DB		1:dB
	dBmpilot	C2PWRUNIT DBMPI		2:dBmpilot
	Pilot Channel Power	C2PIPWR *	C2PIPWR?	Level (-50 to 50 dBm)
	$\Delta\tau$			
	ON	C2TAU ON	C2TAU?	0:OFF
	OFF	C2TAU OFF		1:ON
	$\Delta\theta$			
	ON	C2THETA ON	C2THETA?	0:OFF
	OFF	C2THETA OFF		1:ON
	Code Domain Error			
ON	C2CDE ON	C2CDE?	0:OFF	
OFF	C2CDE OFF		1:ON	
Signal Power				
ON	C2SIGPOW ON	C2SIGPOW?	0:OFF	
OFF	C2SIGPOW OFF		1:ON	
EVM				
ON	C2EVM ON	C2EVM?	0:OFF	
OFF	C2EVM OFF		1:ON	
Fixed Symbols Level				
ON	C2FIXSYM ON	C2FIXSYM?	0:OFF	
OFF	C2FIXSYM OFF		1:ON	
Chip Rate Error				
ON	C2CHIPERR ON	C2CHIPERR?	0:OFF	
OFF	C2CHIPERR OFF		1:ON	
IQ Gain Error				
ON	C2IQGAIN ON	C2IQGAIN?	0:OFF	
OFF	C2IQGAIN OFF		1:ON	
Quadrature Error				
ON	C2QUAD ON	C2QUAD?	0:OFF	
OFF	C2QUAD OFF		1:ON	

Table 4-12 TRANSIENT Key

Function	Listener Code	Talker Request		Remarks
		Code	Output Format	
Code Domain Power Coef	Starts measurement			
	Code Domain Power Coef	C2PC	-	-
with FORWARD Link selected	Starts measurement in the same mode	SI	-	-
	Measurement results			
	τ (Time Alignment Error)	-	C2PCTAU?	Time (sec)
	Carrier Frequency Error		C2PCCFER?	d1,d2 d1: Frequency(Hz) d2: Real number(ppm)
	Multiple ρ		C2PCRHO?	Real number
	PN Offset		C2PCPNOS?	Integer
	Magnitude Error		C2PCMAG?	Real number (%rms)
	Phase Error		C2PCPHE?	Real number (deg.rms)
	Error Vector Magnitude		C2PCEVM?	Real number (%rms)
	I/Q Origin Offset		C2PCIQOFS?	Real number (dBc)
	Error Signal Power Ratio		C2PCERPOW?	Real number (dB)
	Tx Power		C2PCTXPOW?	Real number (dBm)
	Tx Power(W)		C2PCTXPOWW?	Real number (W)
	AVG Power at Chip		C2PCAVGPOW?	Real number (dBm)
	Peak Code Domain Error		C2PCPKCDE?	Real number (dB)
	Chip Rate Error		C2PCCCHIPERR?	d1,d2 d1:(Hz) d2:(ppm)
	I/Q Gain Error		C2PCIQGAIN?	Real number (%)
	Quadrature Error		C2PCQUAD?	Real number (degrce)
	Peak $\Delta\tau$	-	C2PKTAU?	d1, d2 d1: (sec) d2: (Channel number)
	Peak $\Delta\theta$		C2PKTHETA?	d1, d2 d1: (rad.) d2: (Channel number)
	Peak inactive channel power (ρ)		C2INACTRHO?	d1,d2 d1: (dB) d2: (Channel number)
			C2PKINACT?	d1,d2,d3 d1: (dB) d2: (Channel number) d3: (Walsh Length)

4.2 GPIB Command Codes

Table 4-12 TRANSIENT Key

Function		Listener Code	Talker Request		Remarks
			Code	Output Format	
Code Domain Power Coef with FORWARD Link selected	Marker Position	C2PCMK *	C2PCMK?	Integer (0 to 127)	
	Walsh Code Length		C2PCMKWLEN?	Integer	
Walsh Code Number	C2PCMKWNUM?		Integer		
ρ	C2PCMKRHO?		Real number		
Power	C2PCMKPOW?		(dBm/dB/dBmpilot)		
$\Delta\tau$	C2PCMKTAU?		(sec)		
$\Delta\theta$	C2PCMKPHA?		(rad.)		
CDE	C2PCMKCDE?		(dBm/dB/dBmpilot)		
ρ (dB)	C2PCMKRHOLOG?		(dB)		
Symbol Rate	C2PCMKSYMRT?		Real number(ksp/s)		
$\rho \cdot TxPow$	C2PCMKABSPOW?		d1, d2 d1: Level(dBm) d2: Level(W)		
Reads all Marker Data	Walsh Code Length		C2PCGPHWLEN?	n<CR+LF>+d1<CR+LF>+... +dn<CR+CF> n: The number of output data (integer) dn: Walsh Code Length (integer)	
	Walsh Code Number		C2PCGPHWNUM?	n<CR+LF>+d1<CR+LF>+... +dn<CR+CF> n: The number of output data (integer) dn: Walsh Code Number (integer)	
	ρ		C2PCGPHRHO?	n<CR+LF>+d1<CR+LF>+... +dn<CR+CF> n: The number of output data (integer) dn: ρ (real number)	

Table 4-12 TRANSIENT Key

Function		Listener Code	Talker Request		Remarks
			Code	Output Format	
Code Domain Power Coef with FORWARD Link selected	Power		C2PCGPHPOW?	n<CR+LF>+d1<CR+LF>+...+dn<CR+CF> n: The number of output data (integer) dn: Power (dBm/dB/dBmpilot)	
	$\Delta\tau$		C2PCGPHTAU?	n<CR+LF>+d1<CR+LF>+...+dn<CR+CF> n: The number of output data (integer) dn: $\Delta\tau$ (sec)	
	$\Delta\theta$		C2PCGPHPHA?	n<CR+LF>+d1<CR+LF>+...+dn<CR+CF> n: The number of output data (integer) dn: $\Delta\theta$ (rad.)	
	CDE		C2PCGPHCDE?	n<CR+LF>+d1<CR+LF>+...+dn<CR+CF> n: The number of output data (integer) dn: CDE(dBm/dB/dBmpilot)	
	ρ (dB)		C2PCGPHRHOLOG?	n<CR+LF>+d1<CR+LF>+...+dn<CR+CF> n: The number of output data (integer) dn: ρ (dB)	
	Symbol Rate		C2PCGPHSYMRT?	n<CR+LF>+d1<CR+LF>+...+dn<CR+CF> n: The number of output data (integer) dn: Symbol Rate(ksps)	
	$\rho \cdot \text{TxPow}$		C2PCGPHABSPow?	n<CR+LF>+d1<CR+LF>+...+dn<CR+CF> n: The number of output data (integer) dn: Level(dBm)	
			C2PCGPHABSPowW?	n<CR+LF>+d1<CR+LF>+...+dn<CR+CF> n: The number of output data (integer) dn: Level(W)	

4.2 GPIB Command Codes

Table 4-12 TRANSIENT Key

Function	Listener Code	Talker Request		Remarks	
		Code	Output Format		
Code Domain Power Coef with FORWARD Link selected	Graphics Marker Constellation Constellation(Line) Constellation(Dot) Constellation(Line&Dot) I EYE Diagram Q EYE Diagram I/Q EYE Diagram Chip number I-Phase data Q-Phase data	C2MKCHIP *	C2MKCHIP? C2MKI? C2MKQ?	Integer Phase Phase	
	E.V.M. vs Chip Mag Error vs Chip Marker Position Chip number	C2GMK *	C2GMK? C2MKCHIP? C2MKERR?	Integer Integer %	
Code Domain Power with REVERSE (RC3&4) Link selected	Auto Level Set	AUTOLVL	-	-	
	Graphics Select Type Constellation Constellation (Line) Constellation (Dot) Constellation (Line&Dot) I EYE Diagram Q EYE Diagram I/Q EYE Diagram E.V.M. vs Chip Mag Error vs Chip Phase Error vs Chip	C2CDGTYP CON C2CDGTYP CONLIN C2CDGTYP CONDOT C2CDGTYP CONLINDOT C2CDGTYP ICHEYE C2CDGTYP QCHEYE C2CDGTYP IQCHEYE C2CDGTYP EVM C2CDGTYP MAGERR C2CDGTYP PHAERR	C2CDGTYP?	0: Constellation 1: Constellation (Line) 2: Constellation (Dot) 3: Constellation (Line&Dot) 4: I EYE Diagram 5: Q EYE Diagram 6: I/Q EYE Diagram 7: E.V.M. vs Chip 8: Mag Error vs Chip 9: Phase Error vs Chip	
	Plot Type AVG P-P	C2CDGPLOT AVG C2CDGPLOT PP	C2CDGPLOT?	0:AVG 1:P-P	
	Y/div 25 5	C2CDGYDIV P25 C2CDGYDIV P5	C2CDGYDIV?	0:25/div 1:5/div	

Table 4-12 TRANSIENT Key

Function	Listener Code	Talker Request		Remarks	
		Code	Output Format		
Code Domain Power with REVERSE (RC3&4) Link selected	View Setup				
	View Mode				
	CHANNEL	C2VWMODE CHL	C2VWMODE?	0:CHANNEL	
	WALSH	C2VWMODE WALSH		1:WALSH	
	Display				
	ρ	C2DISP RHO	C2DISP?	0: ρ	
	EVM	C2DISP EVM		1:EVM	
	DEMOD	C2DISP DEMOD		2:DEMOD	
	NUMERIC	C2DISP NUM		3:NUMERIC	
	TABLE(POWER)	C2DISP TBL		4:TABLE(POWER)	
	MAG ERR	C2DISP MAGERR		5:MAG ERR	
	PHASE ERR	C2DISP PHAERR		6:PHASE ERR	
	TABLE(EVM)	C2DISP TBLEVM		7:TABLE(EVM)	
View Channel					
PICH	C2VWCH PICH	C2VWCH?	0:PICH		
DCCH	C2VWCH DCCH		1:DCCH		
SCH2	C2VWCH SCH2		2:SCH2		
FCH	C2VWCH FCH		3:FCH		
SCH1	C2VWCH SCH1		4:SCH1		
EACH	C2VWCH EACH		5:EACH		
CCCH	C2VWCH CCCH		6:CCCH		
Y/div(Ch. Graph)					
25/div	C2CHGYDIV P25	C2CHGYDIV?	0:25/div		
5/div	C2CHGYDIV P5		1:5/div		
Format					
GRAPH	C2CDFMT GRP	C2CDFMT?	0:GRAPH		
TABLE	C2CDFMT TBL		1:TABLE		
NUMERIC	C2CDFMT NUM		2:NUMERIC		
Y Scale					
ρ	C2CDYSCL RHO	C2CDYSCL?	0: ρ		
ρ re & ρ im	C2CDYSCL RHORHO		1: ρ re & ρ im		
ρ (ALL)	C2CDYSCL RHOALL		2: ρ (ALL)		
ρ re & ρ im(ALL)	C2CDYSCL RHORHOALL		3: ρ re & ρ im(ALL)		
τ	C2CDYSCL TAU		4: τ		
PHASE	C2CDYSCL PHA		5:PHASE		
Display div					
SINGLE	C2CDDISP SNGL	C2CDDISP?	0:SINGLE		
DUAL	C2CDDISP DUAL		1:DUAL		

4.2 GPIB Command Codes

Table 4-12 TRANSIENT Key

Function	Listener Code	Talker Request		Remarks
		Code	Output Format	
Code Domain Power	Table Page			
	1	C2CDPAGE 1	C2CDPAGE?	1:1/2
with REVERSE (RC3&4) Link selected	2	C2CDPAGE 2		2:2/2
	CDP Y/div			
	10/div	C2PDIV P10	C2PDIV?	0:10/div
	5/div	C2PDIV P5		1: 5/div
Channel Setup				
Operation Mode				
	TCH	C2OP TCH	C2OP?	0:TCH
	EACH	C2OP EACH		1:EACH
	CCCH	C2OP CCCH		2:CCCH
DCCH				
	ON	C2DCCH ON	C2DCCH?	0:OFF
	OFF	C2DCCH OFF		1:ON
FCH				
	ON	C2FCH ON	C2FCH?	0:OFF
	OFF	C2FCH OFF		1:ON
SCH1 Walsh Function				
	W(1,2)	C2SCH1 WALSH W12	C2SCH1 WALSH?	0:W(1,2)
	W(2,4)	C2SCH1 WALSH W24		1:W(2,4)
	CH OFF	C2SCH1 WALSH OFF		2:CH OFF
SCH1 Repetition Factor		C2SCH1REP *	C2SCH1REP?	Integer (1/2/4/8/16/32)
SCH2 Walsh Function				
	W(2,4)	C2SCH2WALSH W24	C2SCH2WALSH?	0:W(2,4)
	W(6,8)	C2SCH2WALSH W68		1:W(6,8)
	CH OFF	C2SCH2WALSH OFF		2:CH OFF
SCH2 Repetition Factor		C2SCH2REP *	C2SCH2REP?	Integer (1/2/4/8/16)
Walsh Code Length				
	32	C2WLSLEN W32	C2WLSLEN?	0:32
	64	C2WLSLEN W64		1:64
Parameter Setup				
Meas Mode				
	PRECISE	C2CDMMOD PREC	C2CDMMOD?	0:PRECISE
	NORMAL	C2CDMMOD NORM		1:NORMAL
Meas Range		C2MRNG *	C2MRNG?	Integer (128 to 1536 chip)
Threshold		C2THRSH *	C2THRSH?	Level (-50 to 0 dBm)
PN Delay Search Mode				
	ON	C2PNMOD ON	C2PNMOD?	0:OFF
	OFF	C2PNMOD OFF		1:ON

Table 4-12 TRANSIENT Key

Function	Listener Code	Talker Request		Remarks
		Code	Output Format	
Code Domain Power	PN Delay	C2PNDLY *	C2PNDLY?	Integer (0 to 511)
with REVERSE (RC3&4) Link selected	Trigger Source			
	INT	C2TRG INT	C2TRG?	0:INT
	EXT	C2TRG EXT		1:EXT
	INTRVL(EXT)	C2TRG INTRVL1		2:INTRVL(EXT)
	INTRVL	C2TRG INTRVL2		3:INTRVL
	EXT Trigger Slope			
	+	C2TRGSLP RISE	C2TRGSLP?	0:-
	-	C2TRGSLP FALL		1:+
	EXT Trigger Delay	C2TRGDLY *	C2TRGDLY?	Time (-5000.000 to 6250.000 μsec)
	Freq Meas Range			
	NORMAL	C2FRRNG NORM	C2FRRNG?	0:NORMAL
	EXPAND	C2FRRNG EXP		1:EXPAND
	$\Delta\tau$			
	ON	C2DLTTAU ON	C2DLTTAU?	0:OFF
	OFF	C2DLTTAU OFF		1:ON
	$\Delta\theta$			
	ON	C2DLTTHE ON	C2DLTTHE?	0:OFF
	OFF	C2DLTTHE OFF		1:ON
	Chip Rate Error			
	ON	C2CHIPERR ON	C2CHIPERR?	0:OFF
OFF	C2CHIPERR OFF		1:ON	
Quadrature Error				
ON	C2QUAD ON	C2QUAD?	0:OFF	
OFF	C2QUAD OFF		1:ON	
Demod Data Save	C2DEMOSV	-	-	
Average Times	C2CAVG *	C2CAVG?	Integer (1:OFF, 2 to 32)	
Starts measurement				
Code Domain Power	C2CDP	-	-	
Starts measurement in the same mode	SI	-	-	
Measurement results				
When View Mode is set to CHANNEL	-			
Code Domain Power Marker				
Code Power		C2CDMKPOW?	Level (dB)	
ρ		C2CDMKRHO?	Real number	

4.2 GPIB Command Codes

Table 4-12 TRANSIENT Key

Function	Listener Code	Talker Request		Remarks
		Code	Output Format	
Code Domain Power with REVERSE (RC3&4) Link selected	Power		C2CDMKPWR?	d1, d2 d1: Level(dBm) d2: Level(W)
	EVM		C2CDMKEVM?	Real number (%rms)
	EVM Graph Marker	C2EVMMKSYM *	C2EVMMKSYM?	Integer (Symbol)
	Marker Position		C2EVMMKEVM?	Real number (%)
	EVM	C2MAGMKSYM *	C2MAGMKSYM?	Integer (Symbol)
	MAG ERROR Graph Marker		C2MAGMKMAG?	Real number (%)
	Marker Position	C2PHAMKSYM *	C2PHAMKSYM?	Integer (Symbol)
	MAG ERROR		C2PHAMKPHA?	Real number (degree)
	PHASE ERROR Graph Marker	C2ACTTRC A C2ACTTRC B	C2ACTTRC?	0:Upper 1:Lower
	Marker Position		C2CDMK *	Integer (0 to 63)
Switching Marker display when View Mode is set to WALSH		C2CDMKWLEN?	Integer	
Upper screen (Upper)		C2CDMKWNUM?	Integer	
Lower screen (Lower)		C2CDMKWRHOLOG?	(dB)	
Marker Position		C2CDMKWRHO?	Real number	
Walsh Code Length		C2CDMKWTAU?	(sec)	
Walsh Code Number		C2CDMKWPHA?	(rad.)	
Reads all Marker Data		C2CDGPHWLEN?	n<CR+LF>+d1<CR+LF>+...+dn<CR+CF> n: The number of output data (integer) dn: Walsh Code Length (integer)	
Walsh Code Length		C2CDGPHWNUM?	n<CR+LF>+d1<CR+LF>+...+dn<CR+CF> n: The number of output data (integer) dn: Walsh Code Number (integer)	
Walsh Code Number				

Table 4-12 TRANSIENT Key

Function		Listener Code	Talker Request		Remarks
			Code	Output Format	
Code Domain Power with REVERSE (RC3&4) Link selected	ρ (dB)		C2CDGPHWRHOLOG?	n<CR+LF>+d1<CR+LF>+...+dn<CR+CF> n: The number of output data (integer) dn: ρ (dB)	
	ρ		C2CDGPHWRHO?	n<CR+LF>+d1<CR+LF>+...+dn<CR+CF> n: The number of output data (integer) dn: ρ (real number)	
	$\Delta\tau$		C2CDGPHWTAU?	n<CR+LF>+d1<CR+LF>+...+dn<CR+CF> n: The number of output data (integer) dn: $\Delta\tau$ (sec)	
	$\Delta\theta$		C2CDGPHWPHA?	n<CR+LF>+d1<CR+LF>+...+dn<CR+CF> n: The number of output data (integer) dn: $\Delta\theta$ (rad.)	
Total Result					
Multiple ρ / Estimated ρ	-	C2CDRHO?	d1		
τ (Time Alignment Error)		C2CDTAU?	d2:(sec)		
Carrier Frequency Error		C2CDCFER?	d3:(Hz)		
Magnitude Error		C2CDMAG?	d4:(%rms)		
Phase Error		C2CDPHE?	d5:(deg.rms)		
Error Vector Magnitude		C2CDEVMM?	d6:(%rms)		
I/Q Origin Offset		C2CDIQOFS?	d7:(dBc)		
PN Delay		C2CDPNDLY?	d8		
Entire result output		C2CDTOTAL?	d1,d2,d3,d4,d5,d6,d7,d8		
Chip Rate Error		C2CDCHIPERR?	Real number (ppm)		
Quadrature Error		C2CDQUAD?	Real number (degree)		
Tx Power		C2CDTXPOW?	Real number (dBm)		

4.2 GPIB Command Codes

Table 4-12 TRANSIENT Key

Function	Listener Code	Talker Request		Remarks
		Code	Output Format	
Code Domain Power with REVERSE (RC3&4) Link selected	Peak Inactive ρ	-	C2INACTRHO?	d1, d2, d3, d4 d1: (dB) d2: (Channel number) d3: (Walsh Length) d4: (Phase) 0: re, I: im
	Peak $\Delta\tau$		C2PKTAU?	d1, d2, d3 d1: (sec) d2: (Channel number) d3: (Walsh Length)
	Peak $\Delta\theta$		C2PKTHETA?	d1, d2, d3 d1: (rad.) d2: (Channel number) d3: (Walsh Length)
Graphics Marker Constellation Constellation(Line) Constellation(Dot) Constellation(Line&Dot) I EYE Diagram Q EYE Diagram I/Q EYE Diagram Chip number I-Phase data Q-Phase data		C2MKCHIP *	C2MKCHIP? C2MKI? C2MKQ?	Integer Phase Phase
E.V.M. vs Chip Mag Error vs Chip Marker Position Chip number		C2GMK *	C2GMK? C2MKCHIP? C2MKERR?	Integer Integer %
Phase Error vs Chip Marker Position Chip number		C2GMK *	C2GMK? C2MKCHIP? C2MKDEG?	Integer Integer degree

Table 4-12 TRANSIENT Key

Function		Listener Code	Talker Request		Remarks
			Code	Output Format	
Waveform Quality with REVERSE (RC1&2) Link selected	Auto Level Set	AUTOLVL			
	Graphics				
	Select Type				
	Constellation	WFGTYP CON	WFGTYP?	0: Constellation	
	Constellation(Line)	WFGTYP CONLIN		1: Constellation(Line)	
	Constellation(Dot)	WFGTYP CONDOT		2: Constellation(Dot)	
	Constellation (Line&Dot)	WFGTYP CONLINDOT		3: Constellation (Line&Dot)	
	I EYE Diagram	WFGTYP ICHEYE		4: I EYE Diagram	
	Q EYE Diagram	WFGTYP QCHEYE		5: Q EYE Diagram	
	I/Q EYE Diagram	WFGTYP IQCHEYE		6: I/Q EYE Diagram	
	E.V.M. vs Chip	WFGTYP EVM		7: E.V.M. vs Chip	
	Mag Error vs Chip	WFGTYP MAGERR		8: Mag Error vs Chip	
	Phase Error vs Chip	WFGTYP PHAERR		9: Phase Error vs Chip	
	Null Offset Constellation	WFGTYP NCON		10: Null Offset Constellation	
	Null Offset Constellation(Line)	WFGTYP NCONLIN		11: Null Offset Constellation (Line)	
	Null Offset Constellation(Dot)	WFGTYP NCONDOT		12: Null Offset Constellation (Dot)	
	Null Offset Constellation (Line&Dot)	WFGTYP NCONLINDOT		13: Null Offset Constellation (Line&Dot)	
Null Offset I EYE Diagram	WFGTYP NICHEYE		14: Null Offset I EYE Diagram		
Null Offset Q EYE Diagram	WFGTYP NQCHEYE		15: Null Offset Q EYE Diagram		
Null Offset I/Q EYE Diagram	WFGTYP NIQCHEYE		16: Null Offset I/Q EYE Diagram		
Plot Type					
AVG	WFGPLOT AVG	WFGPLOT?	0:AVG		
P-P	WFGPLOT PP		1:P-P		
Parameter Setup					
Meas Range	WMRNG *	WMRNG?	Integer (615 to 800chip)		

4.2 GPIB Command Codes

Table 4-12 TRANSIENT Key

Function	Listener Code	Talker Request		Remarks
		Code	Output Format	
Waveform Quality with REVERSE (RC1&2) Link selected	Trigger Source			
	INT	WTRGSRC INT	WTRGSRC?	0:INT
	EXT	WTRGSRC EXT		1:EXT
	INTRVL(EXT)	WTRGSRC INTRVL1		2:INTRVL(EXT)
	INTRVL	WTRGSRC INTRVL2		3:INTRVL
	EXT Trigger Slope			
	+	WTRGSLP RISE	WTRGSLP?	0:-
	-	WTRGSLP FALL		1:+
	EXT Trigger Delay	WTRGDLY *	WTRGDLY?	Time (-5000.000 to 6250.000 μsec)
	Freq Meas Range			
	NORMAL	WFRRNG NORM	WFRRNG?	0:NORMAL
	EXPAND	WFRRNG EXP		1:EXPAND
	Average Times	CAVGWF *	CAVGWF?	Integer (1:OFF, 2 to 32)
Starts measurement				
Waveform Quality	WFQUA			
Starts measurement in the same mode	SI			
Measurement results				
Total Result				
ρ		WFRHO?	Real number	
Carrier Frequency Error		WFCFER?	Hz	
I/Q Origin Offset		WFIQOFS?	dBc	
Magnitude Error		WFMAG?	% rms	
Phase Error		WFPHE?	deg. rms	
Error Vector Magnitude		WFEVM?	% rms	
Graphics Marker				
Constellation				
Constellation(Line)				
Constellation(Dot)				
Constellation(Line&Dot)				
I EYE Diagram				
Q EYE Diagram				
I/Q EYE Diagram				
Null Offset Constellation				
Null Offset Constellation (Line)				
Null Offset Constellation (Dot)				

Table 4-12 TRANSIENT Key

Function		Listener Code	Talker Request		Remarks
			Code	Output Format	
Waveform Quality with REVERSE (RC1&2) Link selected	Null Offset Constellation (Line&Dot) Null Offset I EYE Diagram Null Offset Q EYE Diagram Null Offset I/Q EYE Diagram	GMKCHIP *	GMKCHIP?	Integer	
	Chip number		GMK1?	Phase	
	I-Phase data		GMKQ?	Phase	
	Q-Phase data				
E.V.M. vs Chip Mag Error vs Chip Marker Position Chip number	GMK *	GMK?	Integer	Real number %	
		GMKCHIPNO? GMKERR?			
Phase Error vs Chip Marker Position Chip number	GMK *	GMK?	Integer	Real number degree	
		GMKCHIPNO? GMKDEG?			
Tx Power	Auto Level Set	AUTOLVL	-	-	
	Parameter Setup				
	Trigger Source				
	INT	TXTRG INT	TXTRG?	0:INT	
	EXT	TXTRG EXT		1:EXT	
	INTRVL(EXT)	TXTRG INTRVL1		2:INTRVL(EXT)	
	IF	TXTRG IF		3:IF	
	EXT Trigger Slope				
	+	TXTRGSLP RISE	TXTRGSLP?	0:-	
	-	TXTRGSLP FALL		1:+	
	Trigger Level	TXTRLVL *	TXTRLVL?	Integer (0 to 100)	
EXT Trigger Delay	TXTRGDLY *	TXTRGDLY?	Time		
Average Times	TXAVG *	TXAVG?	Integer (1:OFF, 2 to 32)		
Starts measurement					
Tx Power	TXPWR	-	-		
Starts measurement in the same mode	SI	-	-		
Measurement results					
Tx Power	-	TXPWR?	d1,d2,d3 d1: Tx Power(dBm/dB) d2: Tx Power(W) d3: Peak Factor(dB)		

4.2 GPIB Command Codes

Table 4-12 TRANSIENT Key

Function		Listener Code	Talker Request		Remarks
			Code	Output Format	
CCDF	Auto Level Set	AUTOLVL	-	-	
	Scale Setup				
	X Scale Max	C2CCDFXMAX *	C2CCDFXMAX?	Integer (-20 to 70 dB/dBm)	
	X Scale Range	C2CCDFXRNG *	C2CCDFXRNG?	Integer (10 to 50 dB/dBm)	
	Power Unit				
	RELATIVE	C2CCDFUNIT REL	C2CCDFUNIT?	0:ABS POWER	
	ABS POWER	C2CCDFUNIT ABS		1:RELATIVE	
	Parameter Setup				
	Trigger Mode				
	INT	C2CCDFTRG INT	C2CCDFTRG?	0:INT	
	EXT	C2CCDFTRG EXT		1:EXT	
	Trigger Slope				
	+	C2CCDFTRGSLP RISE	C2CCDFTRGSLP?	0:-	
	-	C2CCDFTRGSLP FALL		1:+	
	Trigger Delay	C2CCDFTRGDLY *	C2CCDFTRGDLY ?	Time	
Meas Length	C2CCDFMLEN *	C2CCDFMLEN?	Integer (10000 to 100000000)		
Trace Write					
ON	C2CCDFTRC ON	C2CCDFTRC?	0:OFF		
OFF	C2CCDFTRC OFF		1:ON		
Starts measurement					
CCDF	C2CCDF	-	-		
Starts measurement in the same mode	SI	-	-		
Measurement results					
CCDF	-	C2CCDF?	d1,d2,d3,d4,d5,d6,d7,d8 d1:Peak Factor d2:Average Power d3:10% d4:1% d5:0.1% d6:0.01% d7:0.001% d8:0.0001%		
Marker Position	C2CCDFMK *	-	Level		
Distribution/Power	-	C2CCDFMK?	d1,d2 d1:Distribution d2:Power		

Table 4-13 Numeric Keys/Step Keys/Data Knob/Unit Keys (Entering Data)

Function		Listener Code	Talker Request		Remarks
			Code	Output Format	
Entering data	0 to 9	0 to 9	-	-	
	. (Decimal point)	.	-	-	
	GHz	GZ	-	-	
	MHz	MZ	-	-	
	kHz	KZ	-	-	
	Hz	HZ	-	-	
	mV	MV	-	-	
	mW	MW	-	-	
	dB	DB	-	-	
	mA	MA	-	-	
	sec	SC	-	-	
	ms	MS	-	-	
	μs	US	-	-	
	ENTER	ENT	-	-	

4.2 GPIB Command Codes

Table 4-14 Miscellaneous

Function	Listener Code	Talker Request		Remarks
		Code	Output Format	
Miscellaneous	Judgment result reading	-	OPF?	0: PASS 1: FAIL(Upper) 2: FAIL(Lower) 3: FAIL(Upper&Lower) 4: Error
	Outputting error number	-	ERRNO?	Integer
	Local	LC	-	-
	Reading GPIB address	-	AD?	Integer (0 to 30)
	Specification of the delimiter CR LF <EOI> LF <EOI> CR LF LF <EOI>	DL0 DL1 DL2 DL3 DL4	-	-
	Service request interruption ON OFF	S0 S1	-	-
	Status clear	S2	-	-
	Service request mask	RQS *	RQS?	Decimal number corresponding to the SRQ bit
	Outputting ID of the instrument	-	*IDN?	Manufacturer name (character string), instrument type (character string), 0 and revision (character string)
	Initializing the instrument	*RST	-	-
	Clearing the queues related to the status byte	*CLS	-	-
	Accessing the standard event enable register	*ESE *	*ESE?	Decimal number corresponding to the register bits
	Reading or clearing the standard event enable register	-	*ESR?	Decimal number corresponding to the register bits
	Accessing the service request enable register	*SRE *	*SRE?	Decimal number corresponding to the register bits
	Reading the status byte and MSS bit	-	*STB?	Decimal number corresponding to the status byte
	Accessing the operation status enable register	OPR *	OPR?	Decimal number corresponding to the register bits
	Reading or clearing the operation status register	-	OPREVT?	Decimal number corresponding to the register bits

5 TECHNICAL INFORMATION

5.1 Template Edit Function

In TRANSIENT mode, the user can change template. It is necessary to pay attention when entering template, because the data can be interpreted as a relative or absolute value, depending on the setting of Template Couple to Power ON/OFF in the Config menu.

The PASS/FAIL judgment is performed and then the result is displayed on the screen, when Template ON/OFF in the Template menu is set to ON.

5.1.1 Template Setting in the T-Domain Measuring Mode

When Template Couple to Power is set to OFF, template (Y axis data) is interpreted as an absolute value. As a result, the template consists of the data you entered.

Use the Shift X/Y keys to adjust the template position over the measured value.

When Template Couple to Power is set to ON, template (Y axis data) is interpreted as a relative value to the average power.

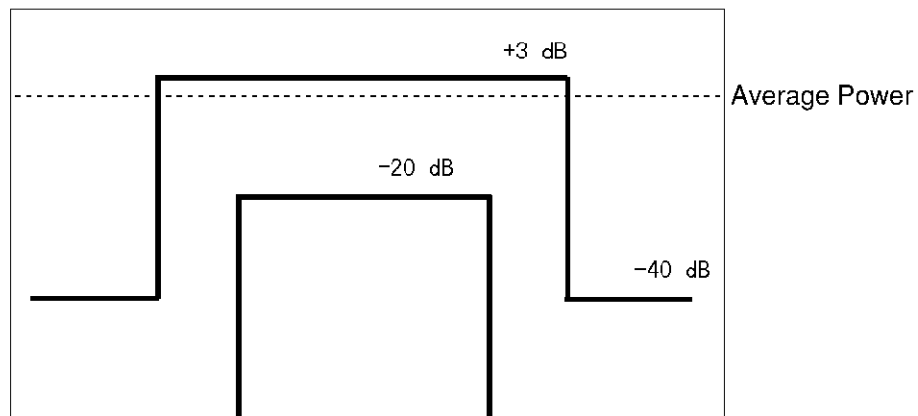

Figure 5-1 Template to Be Set

For example, the upper template defines the power of the signal during the burst period as +3 dB and -40 dB. To set this power to the template, use the settings shown in Figure 5-2. Set the template using the relative values with reference to the average power.

5.1 Template Edit Function

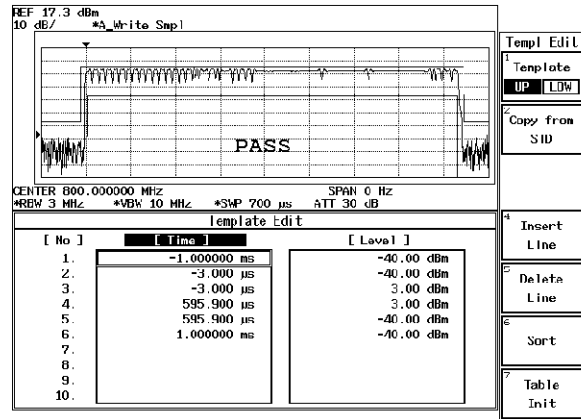

Figure 5-2 Template Settings

When you shift the template to the direction of Y axis using Shift X/Y function while the Template Couple to Power is set to ON, the relative value to the average power is: Relative value (set on the template) + Shifted data on Y axis.

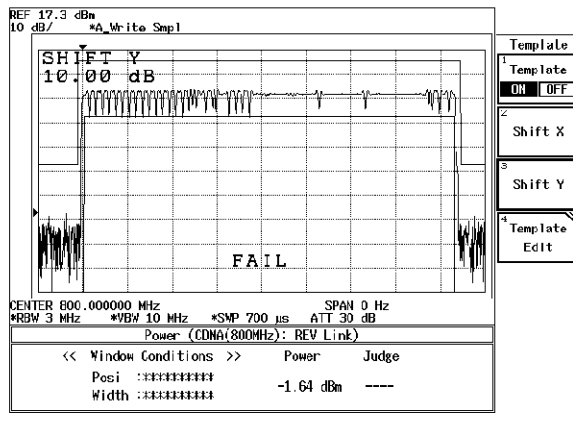

Figure 5-3 Template Shifted Using the Shift Y Function

5.1.2 Template Setting in the F-Domain Measuring Mode

In F-Domain measurement mode, the carrier frequencies depend on the channel numbers. As a result, use the offset frequency from the carrier frequency for template's X axis data.

Set the carrier frequency on the template to 0 Hz so that you can use plus or minus values for the offset frequencies.

The analyzer sets the template by adding the center frequency currently used to X value in the Shift X menu.

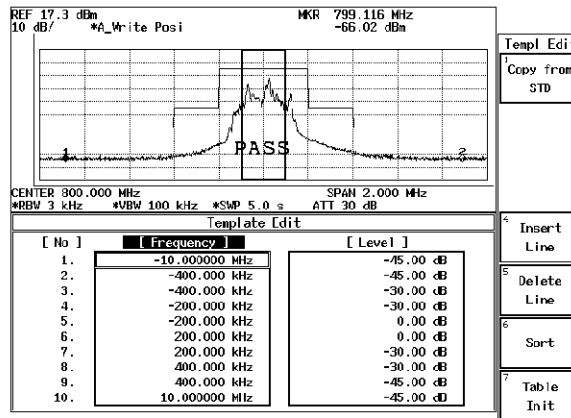

Figure 5-4 Template with the Set Values

Soft menu Margin delta X expands the template frequency by (X/2 to both sides toward plus and minus frequency directions) from the 0 Hz on the template.

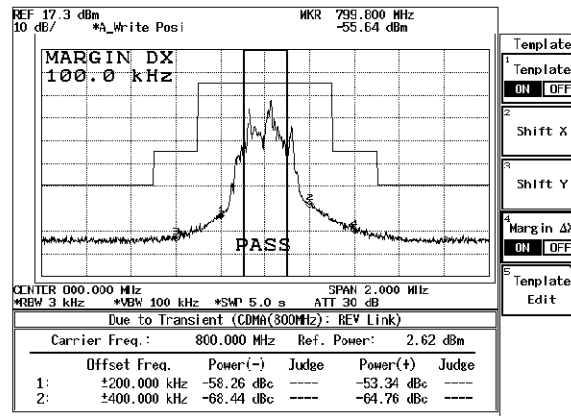

Figure 5-5 Template with Margin Delta X

When Template Couple to Power is set to OFF, template (Y axis data) is interpreted as an absolute value. As a result, the template is made up of the data you entered.

Use the Shift X/Y keys to adjust the template position over the measured value.

When Template Couple to Power is set to ON, template (Y axis data) is interpreted as a relative value to the average power.

When the template is shifted on Y axis using the Shift X/Y function, the relative value to the average power is: Relative value (set on the template) + Shifted data on Y axis.

5.2 Measurement Parameter Settings in Due to Transient, Due to Modulation and Inband Spurious

5.2 Measurement Parameter Settings in Due to Transient, Due to Modulation and Inband Spurious

In TRANSIENT mode, any parameters are compliant with the communication standard when you specify the communication standard. You can also change the measuring frequency and the secondary processing of the measured results.

For the method of changing these, refer to the following

5.2.1 Marker Edit Function

Measurement frequency can be set using Marker Edit in Due to Transient, Due to Modulation or Inband Spurious function (these three functions are found within the Transient mode). In addition, each limit level can be set using Marker Edit.

(1) Marker Edit used in the Due to Transient and Due to Modulation

The measuring frequency is set using the offset frequency from a carrier frequency. If you set the offset frequency to 200 kHz, the offset frequencies (+200 kHz and -200 kHz) can be measured. The Normal marker, Integral marker and Root Nyquist marker are available.

Normal marker is used to read the level of the frequency previously set, and the Integral marker is used to calculate the power of the bandwidth whose center frequency is specified by Marker Edit.

When Root Nyquist is selected, calculates the power of the bandwidth to which the Root Nyquist filter is applied. Set the Root Nyquist filter at Config in Parameter Setup.

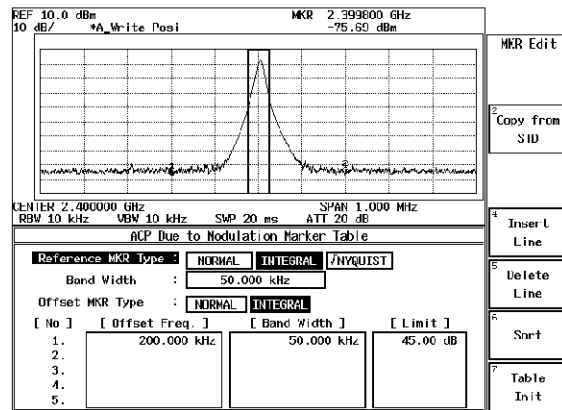

Figure 5-6 Example of Marker Edit Setting (1)

(2) Marker Edit used in the Inband Spurious

Measuring frequency range is set using the offset frequency from the carrier frequency. If you set 3 MHz and 10 MHz, the peak search is performed for two ranges: one of the two offset frequency range is between -3 MHz and -10 MHz; another range is between +3 MHz and +10 MHz.

5.2 Measurement Parameter Settings in Due to Transient, Due to Modulation and Inband Spurious

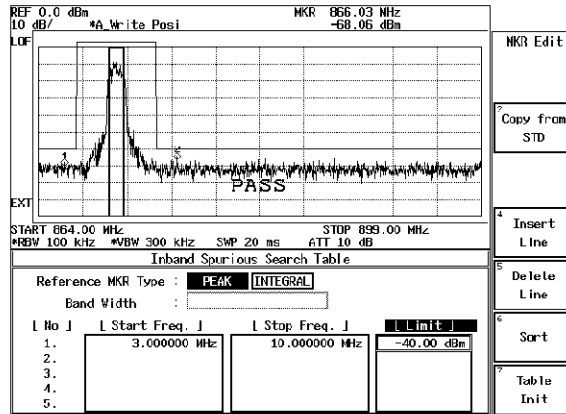

Figure 5-7 Example of Marker Edit Setting (2)

Peak marker is set using the Peak Marker Y Delta soft key in the Config menu.

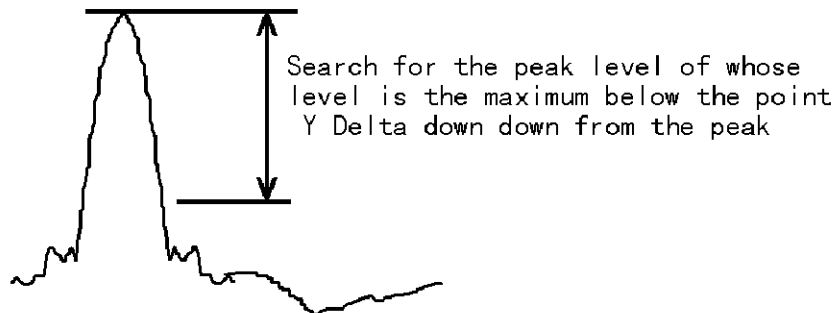

Figure 5-8 Example of Peak Marker Y Delta

5.2.2 Measurement results Using Due to Modulation, Due to Transient and Inband Spurious Modes

In spectrum measurements, there are three methods for displaying results of adjacent or alternate adjacent channel leakage power measurements.

- (1) The measured value displays the absolute level of the marker, which is located at an offset frequency from the carrier frequency.
- (2) The ratio of the absolute level of the marker to the absolute level of the carrier is displayed. The marker point is located at an offset frequency from the carrier frequency.
- (3) The value obtained in (2) is multiplied by the level by the power meter. The calculated value is then displayed.

This method is used when the absolute value of the adjacent channel power cannot be measured. The ratio of the adjacent channel power to the carrier power can be measured only when Detector is set to Posi. However, the absolute level cannot be measured.

5.2 Measurement Parameter Settings in Due to Transient, Due to Modulation and Inband Spurious

To display a measured value in (1), select **MARKER** on the Result: **MARKER/RELATIVE/ABS POWER** menu in the Parameter Setup dialog box.

To display the measured value in (2), select **RELATIVE**.

To display a measured value in (3), select **ABS POWER**. In addition, use the Marker Edit menu to set up measurement conditions for the carrier power. Set the MKR Type to **NORMAL**, **INTEGRAL** or **√NYQUIST** in the Reference Marker in order to measure the carrier power.

To measure the power of the bandwidth by integration, Reference MKR Type must be set to **INTEGRAL**.

To measure a point level (marker reading), Reference MKR Type must be set to **NORMAL**.

To measure adjacent channel power, set Offset MKR Type to **NORMAL**, **INTEGRAL** or **√NYQUIST**. To measure the carrier power in (2) or (3), there are two methods: one is by setting the Marker Edit to the Reference MKR type (set the Ref Power to **REF MARKER**. Ref Power is in the Parameter Setup dialog box on the config menu); another is to measure power using the DSP (set the Ref Power to **MODULATION**. Ref Power is in the Parameter Setup dialog box on the config menu).

When **REF MARKER** is selected, the carrier power is measured by setting Reference MKR Type in the Marker Edit menu.

When **MODULATION** is selected, the carrier power is measured by Tx Power (Modulation, Tx Power).

When **ABS POWER** of the Result is selected from the Parameter Setup dialog box in the Config Menu, the ratio of Offset MKR to Reference MKR is calculated, the measurement value from Tx Power is multiplied by this ratio. Then, the result will be displayed.

5.2.3 Measurement Result of Inband Spurious

In Spurious measurements, there are two methods:

- (1) After searching for the peak on the trace, the frequency and level at the marker are displayed.
- (2) After searching for the peak on the trace, the ratio of the marker level to the carrier level is displayed.
- (3) The calculated level, which is calculated using the result obtained in (2) and the level on the power meter is displayed.

To display the measured value in (1), select **MARKER** on the Result: **MARKER/RELATIVE/ABS POWER** menu in the Parameter Setup dialog box. And also, to display the measured value in (2), select **RELATIVE**; for the (3), select **ABS POWER**. The measurement conditions for the carrier power is set up using the Marker Edit menu. To measure the carrier power, set Reference MKR Type to **PEAK** or **NORMAL**.

To measure the carrier power at the specified frequency, **NORMAL** is set; and to measure the carrier power at the peak on the trace, **PEAK** is set.

To measure the carrier power in (2) or (3), there are two methods: one is by setting the instrument to the Reference MKR type in the Marker Edit menu; another is by the DSP.

When Ref Power is set to **REF MARKER**, the carrier power is measured by Reference MKR Type in the Marker Edit menu.

When Ref Power is set to **MODULATION**, the carrier power is measured by the Tx Power (Modulation, Tx Power).

5.3 Estimated ρ in the Code Domain Power Measurement

This instrument sums up the ρ of the channels greater than the threshold level set in Parameter Setup and displays the sum as Estimated ρ .

5.4 Peak Factor of Tx Power

The calculation of a peak factor is made using the following equation:

Peak Factor = Peak power/Average power.

The peak power and average power are obtained from the envelope after down-converting the input signal into the base band.

Make sure the RF status of the input signal is not the peak power of IF.

5.5 Trigger Source INTRVL (EXT) and INTRVL

5.5 Trigger Source INTRVL (EXT) and INTRVL

The instrument has the internal trigger generated every 26.6 milliseconds (PN Sequence repetition rate). For this internal trigger, there are two modes: one sets the trigger to Free Run state and the other makes the signal synchronize with the external trigger.

In the code domain power measurement, the even second signal produced every two seconds is normally used as an external trigger.

Even when there is no external trigger, the measurement is made possible by measuring the PN delay using the INTRVL trigger and setting this delay value. In this case, however, the drift of the PN delay occurs due to the frequency reference error due to a measurement for a long time. Applying the 10 MHz reference signal in synch with the DUT signal to the instrument allows you to prevent this drift from occurring.

5.6 About Bit Reversal (Paley) Order

The order of the Walsh code numbers used in cdma 2000 is referred to as the Hadamard order.

There is another order, which is different from the Hadamard order. This order is known as the Bit Reversal (Paley) order.

Listing the Walsh codes in the Bit Reversal order allows you to display Walsh codes with different lengths hierarchically in a tree-structured chart.

As a practical example, a comparison between the Hadamard and Bit Reversal orders for the Walsh code length of 8 is made.

	8 x 8 matrix	Walsh code number
cdma 2000 Walsh code Hadamard Order	00000000 01010101 00110011 01100110 00001111 01011010 00111100 01101001	0 1 2 3 4 5 6 7
Bit Reversal (Paley) Order	00000000 00001111 00110011 00111100 01010101 01011010 01100110 01101001	0 4 2 6 1 5 3 7

5.6 About Bit Reversal (Paley) Order

Next, a list showing how Walsh code numbers for Walsh code lengths of 4, 8, 16, 32, 64 and 128 are arranged in the Bit Reversal (Paley) order is presented.

W4	W8	W16	W32	W64	W128
0	0	0	0	0	0
				64	
				32	32
			96		
			16	16	16
			80		
		48	48	48	
		112			
		8	8	8	8
		72			
		40	40	40	
		104			
	24	24	24	24	
	88				
	56	56	56		
	120				
	4	4	4	4	
	68				
	36	36	36		
	100				
	20	20	20	20	
	84				
	52	52	52		
	116				
12	12	12	12		
76					
44	44	44			
108					
28	28	28	28		
92					
60	60	60			
124					

W4	W8	W16	W32	W64	W128	
2	2	2	2	2	2	
					66	
				34	34	
				98		
			18	18		
				82		
			50	50		
				114		
		10	10	10		
				74		
			42	42		
				106		
		26	26			
			90			
		58	58			
			122			
		6	6	6	6	6
					70	
	38				38	
				102		
	22			22		
				86		
			54	54		
				118		
14	14		14			
			78			
	46		46			
			110			
	30	30				
		94				
	62	62				
		126				

5.6 About Bit Reversal (Paley) Order

W4	W8	W16	W32	W64	W128
1	1	1	1	1	1
				65	
				33	33
				97	
				17	17
				81	
			49	49	
			113		
			9	9	
			73		
			41	41	
			105		
	25	25			
	89				
	57	57			
	121				
	5	5			
	69				
	37	37			
	101				
	21	21			
	85				
	53	53			
	117				
13	13				
77					
45	45				
109					
29	29				
93					
61	61				
125					

W4	W8	W16	W32	W64	W128
3	3	3	3	3	3
					67
				35	35
				99	
			19	19	
				83	
			51	51	
				115	
		11	11		
				75	
			43	43	
				107	
		27	27		
			91		
		59	59		
			123		
		7	7		
			71		
			39	39	
				103	
			23	23	
				87	
			55	55	
				119	
		15	15		
			79		
			47	47	
				111	
			31	31	
				95	
			63	63	
				127	

References

“Walsh Analysis” written by Yasushi Endo and published by Tokyo Electric University Press.

“Hadamard Matrix and Its Application” written by Zenichi Kiyasu and published by Institute of Electronics and Communication Engineers of Japan.

5.7 About Complementary Filter

5.7 About Complementary Filter

The complementary filter is used to measure the waveform quality and code domain power specified by the IS-97(Waveform Quality Measurement Equipment) standard.

This complementary filter is used to generate a signal which is equivalent to the signal that passed through the Nyquist filter.

Since IS-97 does not specify the roll-off coefficient of the Nyquist filter, a coefficient range of 0.05 to 0.2 can be set on this instrument.

When the roll-off coefficient is changed, the bandwidth of the complementary filter is changed accordingly.

The following graph shows an example of the complementary filter bandwidth when the roll-off coefficient is changed.

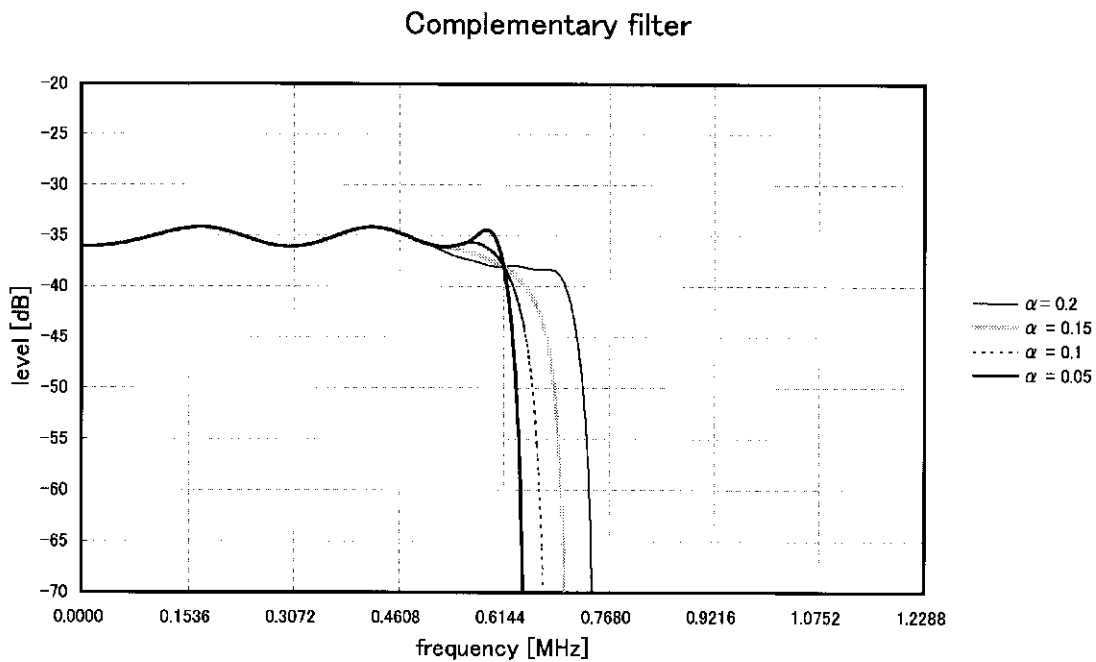

5.8 About Equalizing Filter

For the IS-97 Phase Characteristics, it is specified that the base station shall equalize the phase of a signal to be transmitted through the path. The equalizing filter is defined by the following expression.

$$H(W) = k \frac{W^2 + j \alpha W W_0 - W_0^2}{W^2 - j \alpha W W_0 - W_0^2}$$

k	: Arbitrary gain
j	: $\sqrt{-1}$
α	: 1.36
W_0	: $2\pi \times 3.15 \times 10^5$
W	: Radian frequency

When a signal sent from the base station passes through the Equalizing Filter, the R3267 Series can analyze the waveform using a filter with the inverted characteristics of the Equalizing Filter.

To do this, set the Equalizing Filter setting in the Parameter Setup soft menu to ON.

To analyze a signal which is not passing through the Equaling Filter, set the Filter to OFF.

5.9 Null Offset Graph

5.9 Null Offset Graph

When Reverse (RC1&2) is set, the graph display function used with Waveform Quality measurements is enabled to display a graph such as Null Offset Constellation and Null Offset I(Q) Eye.

In this mode, Constellation does not converge to a point, because Offset QPSK modulation method is used.

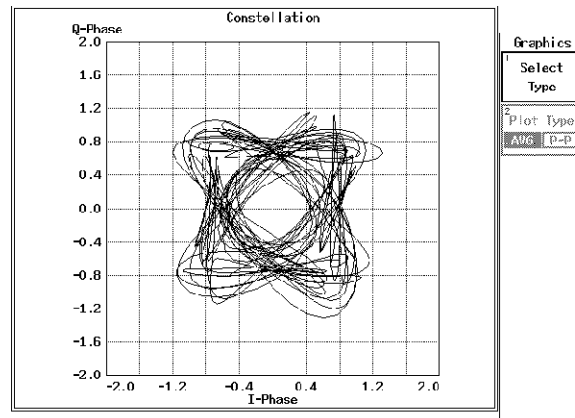

Figure 5-9 Reverse Link Constellation

After the offset value of Offset QPSK signal has been shifted (returned to the original value) and the signal has been filtered with a reverse baseband filter specified by IS-2000, QPSK Constellation is obtained as shown in Figure 5-10 (Null Offset Constellation) in which each of symbol points converged to a point.

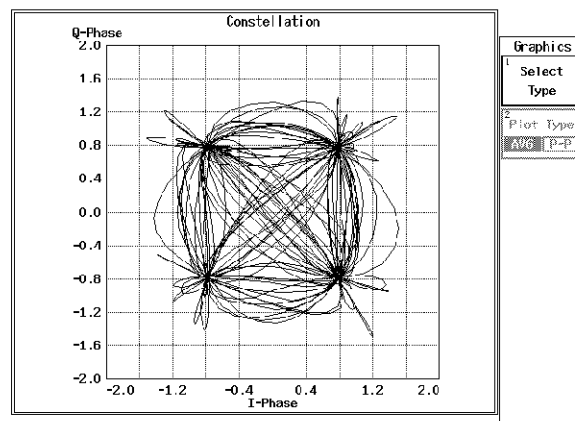

Figure 5-10 Null Offset Constellation

NOTE: Because of the interference between symbols due to baseband filter specified by IS-2000, the constellation does not converge to a point, even if the offset value is shifted using the Offset QPSK function.

5.10 Block Diagram

This section shows the block diagram for the modulation analysis hardware.

The Figure 5-11 shows the modulation analysis part. Therefore the spectrum analyzer part is simplified. The area inside the double lines is the block diagram for the spectrum analyzer, and the part outside that area represents the modulation analysis hardware.

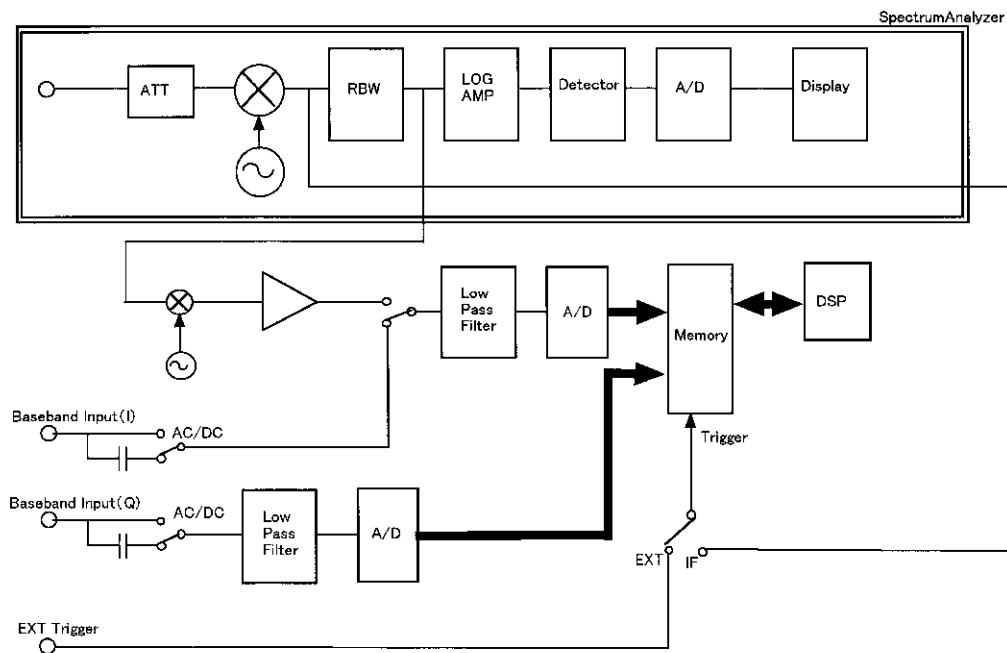

Figure 5-11 Block Diagram

6 PERFORMANCE VERIFICATION TEST

6.1 General

6.1.1 Introduction

This chapter provides R3267 Series OPT65 performance verification test procedures, item by item as listed in Table 6-1

Performance verification test will be carried out under following condition.

Temperature range: 20 °C to 30 °C

Relative Humidity: 85 % or less

Table 6-1 Performance Verification Items

No.	Items
1	Code Domain Power Accuracy (FORWARD Link)
2	Code Domain Power Accuracy (REVERSE Link)

6.1.2 Test Equipment

The Table 6-2 lists recommended test equipment.

The equipment needed to perform all of the performance test.

Equipment lists for individual tests are provided in each performance verification test.

NOTE:

1. *The R3267 Series with OPT65 to be tested should be warm up for at least 30 minutes before starting test.*
 2. *Make sure that the test equipment used meets its own published specifications.*
 3. *Any equipment that meets the critical specifications given in the table can be substituted for recommended models.*
 4. *When SMIQ03 is used as IQ modulation signal generator, set SMIQ03 controls as follows;*
VECTOR MOD: STATE ON
IQ SWAP: ON
-

6.1 General

Table 6-2 Equipment List

No.	Description	Critical Specification	Recommended Model	Manufacturer	Usage	Notes
1	Arbitrary Signal Generator	Output Channels: 3 channel required Capable to assign the output signal I-CH signal at CH1 Q-CH signal at CH2 Trigger signal (TTL) at CH3	AWG2021	Tektronix	PV	SG1
2	I/Q Modulation Signal Generator	Comply with IS-95, IS-97, IS-98 Standard: Base Station Test Model, Nominal Frequency Range: 30 MHz to 3 GHz IQ Modulation Bandwidth: > 5 MHz ρ : < 0.999	SMIQ03	Rohde&Schwarz	PV	SG2
3	RF Cable	BNC(m)-BNC(m), 50 Ω	A01036-1500	Advantest	PV	-
4	Adapter	Type N(m)-BNC(f)	JUG-201-U	Advantest	PV	-

6.1.3 Specifications Required for Test Signals

Table 6-3 provides the specifications required for performance verification test signals based on the requirements.

Table 6-3 Specifications Required for Test Signals

No.	Name of test Signal	Specification Required	Usage		
1	Base Station	Comply with the IS-97 Standard: Base Station Test Model, Nominal	Code Domain Power Accuracy (FORWARD Link)		
		Channel No.		Amplitude	
		0 (Pilot)		-6.99 dB	
		1 (Paging)		-7.25 dB	
		6 (Traffic)		-10.26 dB	
		17 (Traffic)		-10.26 dB	
		20 (Traffic)		-10.26 dB	
		32 (Sync)		-13.27 dB	
		41 (Traffic)		-10.26 dB	
		49 (Traffic)		-10.26 dB	
58 (Traffic)	-10.26 dB				
2	Mobile Station	Based on IS-98 Long Code Mask: ALL 0 Reverse Traffic Channel	Code Domain Power Accuracy (if REVERSE(RC3&4) is set)		
		Channel		Walsh Function	Amplitude
		PICH		W_0^{32}	-6.99 dB
		DCCH		W_8^{16}	-6.99 dB
		SCH2		$W_6^8 (M=2)$	-6.99 dB
		FCH		W_4^{16}	-6.99 dB
		SCH1		$W_2^4 (M=4)$	-6.99 dB
M: Walsh Function Repetition Factor					

6.1 General

Figure 6-1 shows the timing chart of the trigger signal and No.1 Base Station and No.2 Mobile Station signals listed in Table 6-3.

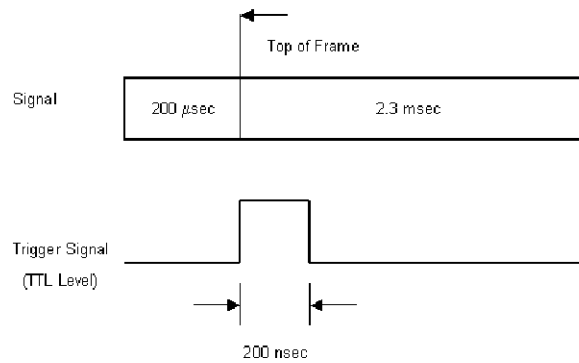

Figure 6-1 Timing Chart of Trigger signal and Mobile Station Signal (Not Scaled)

6.1.4 Calibration Cycle

The performance verifications test should be used to check the spectrum analyzer against its specifications once a year recommended.

6.1.5 Performance Verification Test Record Sheet

The performance verification test record sheet and performance check record sheet is provided at the end of this chapter.

The test record lists test specification and acceptable limits.

Recommend that make a copy of this table, record the complete test results on the copy, and keep the copy for calibration test record.

This record could prove invaluable in tracking gradual changes in test result over long periods of the time.

6.1.6 Performance Verification Procedure

Typeface conventions used in this manual.

*Panel keys and soft keys are printed in a contrasting typestyle to make them stand out form the text as follows:

Panel keys: Boldface type Example: **FREQ, FORMAT**

Soft keys: Boldface and Italic Example: ***Center, Trace Detector***

*When a series of key operations are described using a comma between two keys.

*There are various soft menus used to switch between two states such as ON/OFF and AUTO/MNL.

For example, when turning off the ***Display ON/OFF*** function, the annotation “***Display ON/OFF (OFF)***” is used.

When switching the RBW AUTO/MNL function to MNL, the annotation “***RBW AUTO/MNL (MNL)***” is used.

6.2 Performance Verification Test Procedure

6.2.1 Code Domain Power Accuracy (FORWARD Link)

(1) Description

Test a carrier frequency accuracy and code domain power accuracy in FORWARD Link measurement mode of base station.

(2) Specification

Carrier Frequency Accuracy : ± 10 Hz
Code Domain Power Accuracy : ± 0.1 dB

(3) Equipment used

Arbitrary Waveform Generator : SG1
IQ Modulation Signal Generator : SG2
RF Cable : BNC (m)-BNC (m)
Adapter : Type N (m)-BNC (f)

(4) Setup

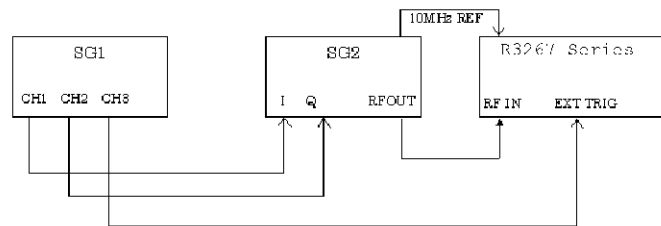

Figure 6-2 Setup of Code Domain Power Accuracy Measurement (FORWARD Link)

(5) Procedure

1. Connect equipment as shown in Figure 6-2.
2. On the SG1, set controls to generate the signal complied with No.1 (Base Station) signal listed in Table 3 at CH1 and CH2.
3. On the SG1, set controls to generate trigger signal at CH3.
4. On the SG2, set controls as follows;

Modulation	:External IQ Modulation
Frequency	:870.03 MHz
Output Level	:0 dBm
5. On the R3267 Series, set controls as follows;

Center Frequency	:870.03 MHz
Input	:RF
Link	:FORWARD

6.2 Performance Verification Test Procedure

6. On the R3267 Series, set the measurement parameters as shown in Figure 6-3.

Parameter Setup	
Meas Range	1280 chip
τ Offset	0.000 μ s
Complementary Filter	<input checked="" type="checkbox"/> ON <input type="checkbox"/> OFF
Rolloff Factor	0.05
Equalizing Filter	<input checked="" type="checkbox"/> ON <input type="checkbox"/> OFF
PN Offset Search Mode	<input checked="" type="checkbox"/> ON <input type="checkbox"/> OFF
PN Offset	0
Carrier Freq. Search	<input checked="" type="checkbox"/> 500Hz <input type="checkbox"/> 10kHz <input type="checkbox"/> 500kHz
Trigger Source	<input type="checkbox"/> INT <input checked="" type="checkbox"/> EXT
	<input checked="" type="checkbox"/> INTRVL(EXT) <input type="checkbox"/> INTRVL
EXT Trigger Slope	<input checked="" type="checkbox"/> + <input type="checkbox"/> -
Threshold	-27 dB
Auto Rate	<input checked="" type="checkbox"/> ON <input type="checkbox"/> OFF
Channel Define	<input checked="" type="checkbox"/> ON <input type="checkbox"/> OFF
Walsh Code Length	<input type="checkbox"/> 4 <input type="checkbox"/> 8 <input type="checkbox"/> 16 <input type="checkbox"/> 32 <input checked="" type="checkbox"/> 64 <input type="checkbox"/> 128
QOF	<input checked="" type="checkbox"/> 0 <input type="checkbox"/> 1 <input type="checkbox"/> 2 <input type="checkbox"/> 3
Bit Reversal Order	<input checked="" type="checkbox"/> ON <input type="checkbox"/> OFF

Figure 6-3 Setting of Measurement Parameters for Code Domain Power (FORWARD Link)

7. On the R3267 Series, set measurement options as shown in Figure 6-4.

Meas Options	
CDP Graph Plot Type	<input checked="" type="checkbox"/> AVERAGE <input type="checkbox"/> MAX <input type="checkbox"/> MIN
Power Unit	<input type="checkbox"/> dBm <input checked="" type="checkbox"/> dB <input type="checkbox"/> dBmpilot
Pilot Channel Power	
$\Delta\tau$	<input checked="" type="checkbox"/> ON <input type="checkbox"/> OFF
$\Delta\theta$	<input checked="" type="checkbox"/> ON <input type="checkbox"/> OFF
Code Domain Error	<input checked="" type="checkbox"/> ON <input type="checkbox"/> OFF
Signal Power	<input checked="" type="checkbox"/> ON <input type="checkbox"/> OFF
EVN	<input checked="" type="checkbox"/> ON <input type="checkbox"/> OFF
Fixed Symbols Level	<input checked="" type="checkbox"/> ON <input type="checkbox"/> OFF
Chip Rate Error	<input checked="" type="checkbox"/> ON <input type="checkbox"/> OFF
IQ Gain Error	<input checked="" type="checkbox"/> ON <input type="checkbox"/> OFF
Quadrature Error	<input checked="" type="checkbox"/> ON <input type="checkbox"/> OFF

Figure 6-4 Setting of Measurement Options for Code Domain Power (FORWARD Link)

8. On the R3267 Series, press **DC CAL** and **AUTO LEVEL** to perform dc calibration and auto level.
9. On the R3267 Series, press **SINGLE** for a single sweep.
10. After single sweep has completed, record the measurement result in the performance verification test record sheet.

6.2.2 Code Domain Power Accuracy (if REVERSE(RC3&4) is set)

(1) Description

Test a carrier frequency accuracy and code domain power accuracy in REVERSE Link measurement mode of mobile station.

(2) Specification

Carrier Frequency Accuracy : ± 10 Hz

Code Domain Power Accuracy : ± 0.1 dB

(3) Equipment used

Arbitrary Waveform Generator : SG1

IQ Modulation Signal Generator : SG2

RF Cable : BNC (m)-BNC (m)

Adapter : Type N (m)-BNC (f)

(4) Setup

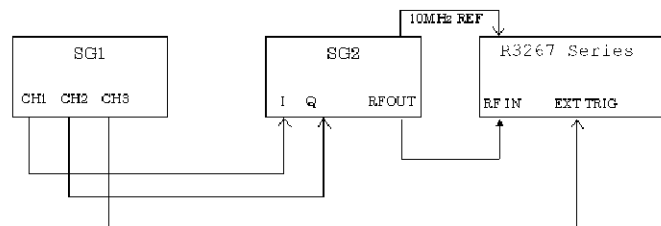

Figure 6-5 Setup of Code Domain Power Accuracy Measurement (REVERSE Link)

(5) Procedure

1. Connect equipment as shown in Figure 6-5.
2. On the SG1, set controls to generate the signal complied with No.2 (Mobile Station) signal listed in Table 3 at CH1 and CH2.
3. On the SG1, set controls to generate trigger signal at CH3.
4. On the SG2, set controls as follows;

Modulation	: External IQ Modulation
Frequency	: 825.03 MHz
Output Level	: 0 dBm
5. On the R3267 Series, set controls as follows;

Center Frequency	: 825.03 MHz
Input	: RF
Link	: REVERSE (RC3&4)

6.2 Performance Verification Test Procedure

6. On the R3267 Series, set the measurement parameters as shown in Figure 6-6 and Figure 6-7.

Channel Setup		
Operation Mode	<input checked="" type="radio"/> TCH	<input type="radio"/> EACH <input type="radio"/> CCCH
DCCH	<input checked="" type="radio"/> ON	<input type="radio"/> OFF W(8,16)
FCH	<input checked="" type="radio"/> ON	<input type="radio"/> OFF W(4,16)
SCH1 Walsh Function	<input checked="" type="radio"/> W(1,2)	<input type="radio"/> W(2,4) <input type="radio"/> CH OFF
SCH1 Repetition Factor	<input type="radio"/> 1 <input type="radio"/> 2 <input checked="" type="radio"/> 4 <input type="radio"/> 8 <input type="radio"/> 16 <input type="radio"/> 32 76.8 kbps	
SCH2 Walsh Function	<input checked="" type="radio"/> W(2,4)	<input type="radio"/> W(6,8) <input type="radio"/> CH OFF
SCH2 Repetition Factor	<input type="radio"/> 1 <input checked="" type="radio"/> 2 <input type="radio"/> 4 <input type="radio"/> 8 <input type="radio"/> 16 76.8 kbps	
Walsh Code Length	<input checked="" type="radio"/> 32	<input type="radio"/> 64

Figure 6-6 Displaying the Channel Setup for Code Domain Power (REVERSE Link)

Parameter Setup	
Meas Mode	<input checked="" type="radio"/> PRECISE <input type="radio"/> NORMAL
Meas Range	1536 chip
Threshold	-23 dB
PN Delay Search Mode	<input checked="" type="radio"/> ON <input type="radio"/> OFF
PN Delay	
Trigger Source	<input type="radio"/> INT <input checked="" type="radio"/> EXT
	<input checked="" type="radio"/> INTRVL(EXT) <input type="radio"/> INTRVL
EXT Trigger Slope	<input checked="" type="radio"/> + <input type="radio"/> -
EXT Trigger Delay	0.000 μ s
Freq Meas Range	<input type="radio"/> NORMAL <input checked="" type="radio"/> EXPAND
$\Delta\tau$	<input checked="" type="radio"/> ON <input type="radio"/> OFF
$\Delta\theta$	<input checked="" type="radio"/> ON <input type="radio"/> OFF
Chip Rate Error	<input checked="" type="radio"/> ON <input type="radio"/> OFF
Quadrature Error	<input checked="" type="radio"/> ON <input type="radio"/> OFF

Figure 6-7 Setting of Measurement Parameters for Code Domain Power (REVERSE Link)

7. On the R3267 Series, press *DC CAL* and *AUTO LEVEL* to perform dc calibration and auto level.
8. On the R3267 Series, press *SINGLE* for a single sweep.
9. After single sweep has completed, record the measurement result in the performance verification test record sheet.

6.3 Performance Verification Test Record Sheet

Model: OPT3264/67/73+65

S/N:

(1) FORWARD Link

Items		Specification			Result
		Min.	Measured Value	Max.	Pass/Fail
Carrier Frequency Accuracy		-10 Hz		+10 Hz	
Code Domain Power	CH No.				
	0	-7.09 dB		-6.89 dB	
	1	-7.35 dB		-7.15 dB	
	6	-10.36 dB		-10.16 dB	
	17	-10.36 dB		-10.16 dB	
	20	-10.36 dB		-10.16 dB	
	32	-13.37 dB		-13.17 dB	
	41	-10.36 dB		-10.16 dB	
	49	-10.36 dB		-10.16 dB	
	58	-10.36 dB		-10.16 dB	

(2) REVERSE Link (if REVERSE(RC3&4) is set)

Items		Specification			Result
		Min.	Measured Value	Max.	Pass/Fail
Carrier Frequency Accuracy		-10 Hz		+10 Hz	
Code Domain Power	Channel				
	PICH	-7.09 dB		-6.89 dB	
	DCCH	-7.09 dB		-6.89 dB	
	SCH2	-7.09 dB		-6.89 dB	
	FCH	-7.09 dB		-6.89 dB	
	SCH1	-7.09 dB		-6.89 dB	

7 SPECIFICATIONS

RF input

- Code Domain Power (FORWARD Link)

Characteristics	Specification
Measurement frequency range	30 MHz to 3.0 GHz
Input level range	-30dBm to +30 dBm (Total power at ATT:AUTO)
POWER i Carrier frequency Error	measure at 1280chip Measurement accuracy : $<\pm 0.1$ dB (at $\Delta\tau_i=0$, $\Delta\theta_i=0$) $<\pm$ (Reference frequency accuracy \times Carrier frequency + 10 Hz) (Carrier frequency is within a range of ± 4 kHz at Carrier Freq. Search 10 kHz.)
$\Delta\tau_i$	Measurement accuracy : $<\pm 10$ nsec
$\Delta\theta_i$	Measurement accuracy : $<\pm 10$ mrad

Note: The measurement signal is specified by IS-97 "Base Station Test Model".

- Code Domain Power (if REVERSE(RC3&4) is set)

Characteristics	Specification
Measurement frequency range	30 MHz to 3.0 GHz
Input level range	-30dBm to +30 dBm (Total power at ATT:AUTO)
Precise Mode POWER i Code Domain Power Carrier frequency Error	measure at 1536chip Measurement accuracy : $<\pm 0.1$ dB (at $\Delta\tau_i=0$, $\Delta\theta_i=0$) $<\pm$ (Reference frequency accuracy \times Carrier frequency + 10 Hz) (Carrier frequency is within a range of ± 4 kHz at Expand mode.)

Note: The measurement signal is the mobile station signal No.2 listed in Table 6-1.

APPENDIX

A.1 Messages

In this section, the messages that are displayed while the analyzer is being used are described.

Code	Messages	Remarks
700	System Error. Cannot allocate the required memory.	Fatal Error occurred. Data area for the calculation is insufficient on the memory. Contact a sales representative.
701	System Error. Clock is not operational.	Fatal Error occurred. System clock is not in operation. Contact a sales representative.
702	Modulation Gain CAL error. Check 30 MHz CAL signal for connection.	-
703	Modulation DC CAL error. Remove input signals and try again.	-
704	Time Out! No Trigger Detected.	Time out error on the trigger signal occurred. Check the trigger settings.
705	Input Level is out of Range. Check the Ref. level.	-
706	No graph data. Execute measurement.	-
707	Input level is too low. Adjust the Ref. level.	-
708	System Error. Contact qualified engineer.	-
710	Auto Level completed !	-
711	Auto Level Set can not be succeed. Signal level is not stable.	-
712	Cannot execute measurement. Because ρ is too low.	-
715	Frequency Error is out of Meas. Range.	-
719	Burst signal is not detected. Check Burst length or Ref. level.	-

A.1 Messages

Code	Messages	Remarks
721	Modulation Gain CAL error!(#100) Check 30 MHz CAL signal for connection.	-
722	Modulation Gain CAL error!(#200) Check 30 MHz CAL signal for connection.	-
723	Modulation Gain CAL error!(#300) Check 30 MHz CAL signal for connection.	-
724	Modulation Gain CAL error!(#110) Check 30 MHz CAL signal for connection.	-
725	Modulation Gain CAL error!(#120) Check 30 MHz CAL signal for connection.	-
726	Modulation Gain CAL error!(#210) Check 30 MHz CAL signal for connection.	-
727	Modulation Gain CAL error!(#220) Check 30 MHz CAL signal for connection.	-
728	Modulation Gain CAL error!(#310) Check 30 MHz CAL signal for connection.	-
729	Modulation Gain CAL error!(#320) Check 30 MHz CAL signal for connection.	-
750	Handshake error occurred to DSP. Contact qualified engineer.	-
751	Cannot Detect Mod. DSP board. Contact qualified engineer.	-

Code	Messages	Remarks
780	Cannot execute measurement. Check the QOF and Data Rate of the Channel Def. Table.	Cannot execute the measurement because multiple channels with different QOFs and high-speed data rates exist. Check the settings and adjust accordingly.
781	Incorrect Channel Def. Table settings. Check the Channel Def. Table.	The combination of the Channel Def. Table settings used is not suitable for the measurement. Check the parameters displayed in red on the Channel Def. Table display and adjust accordingly.
782	Cannot synchronize to PICH. Adjust Threshold.	Cannot be synchronized with the pilot channel signal. Change the threshold setting.
783	Cannot synchronize to PICH. Adjust PN Delay.	Cannot be synchronized with the pilot channel signal. Change the PN delay setting.

ALPHABETICAL INDEX

	[Symbol]	
$\Delta\theta$	3-18, 3-20, 3-62, 3-69	
$\Delta\tau$	3-18, 3-20, 3-61, 3-69	
τ Offset	3-17, 3-57	3-76
[A]		
About Bit Reversal (Paley) Order	5-9	
About Complementary Filter	5-14	
About Equalizing Filter	5-15	
Accessories	1-1	
Auto Level Set	3-7, 3-8, 3-9, 3-10, 3-11, 3-12, 3-13, 3-14, 3-15, 3-16, 3-17, 3-19, 3-20, 3-21, 3-25, 3-28, 3-31, 3-33, 3-37, 3-38, 3-41, 3-45, 3-48, 3-52, 3-53, 3-63, 3-70, 3-73, 3-74, 3-75	
Auto Rate	3-17, 3-58	
Average Mode	3-7, 3-8, 3-9, 3-10, 3-11, 3-12, 3-13, 3-14, 3-15, 3-16, 3-27, 3-30, 3-33, 3-36, 3-37, 3-40, 3-45, 3-48, 3-51, 3-53	
Average Times ON/OFF	3-7, 3-8, 3-9, 3-10, 3-11, 3-12, 3-13, 3-14, 3-15, 3-16, 3-19, 3-20, 3-21, 3-27, 3-29, 3-32, 3-35, 3-37, 3-39, 3-43, 3-46, 3-49, 3-52, 3-70, 3-73, 3-74,	
[B]		
Band Class	3-22, 3-77	
Band Conversion	3-15	
Baseband Input	3-22, 3-78	
Bit Reversal Order	3-17, 3-59	
Block Diagram	5-17	
[C]		
Calibration	1-1	
Calibration Cycle	6-4	
Carrier Freq. Search	3-17, 3-57	
CCDF	3-6, 3-21, 3-74	
CCDF Measurement	2-18	
CDP Graph Plot Type	3-18, 3-61	
Channel	3-17, 3-60	
Channel Def. Table	3-17, 3-59	
Channel Define	3-17, 3-58	
Channel Setting	3-22, 3-76	
Channel Setup	3-20, 3-66	
Chip Rate Error	3-18, 3-20, 3-62, 3-69	
Code	A-1	
Code Domain Error	3-18, 3-62	
Code Domain Power (when REVERSE (RC 3 & 4) is set)	3-63	
Code Domain Power (with REVERSE (RC3&4) setting)	3-6, 3-20	
Code Domain Power Accuracy (FORWARD Link)	6-5	
Code Domain Power Accuracy (REVERSE Link)	6-7	
Code Domain Power Coef (FORWARD)	3-53	
Code Domain Power Coef (with FORWARD setting)	3-6	
Communication Systems	3-24	
Complementary Filter	3-17, 3-57	
Config	3-7, 3-8, 3-9, 3-10, 3-11, 3-12, 3-13, 3-14, 3-15, 3-16, 3-27, 3-29, 3-32, 3-36, 3-37, 3-39, 3-43, 3-46, 3-49, 3-52	

Alphabetical Index

Connectors	1-1		
Constellation	3-17, 3-19, 3-20, 3-54, 3-63, 3-70	Display div	3-55, 3-64 3-20, 3-66
Constellation(Dot)	3-17, 3-19, 3-20, 3-54, 3-63, 3-70	Display Unit	3-7, 3-8, 3-9, 3-10, 3-12, 3-13, 3-14, 3-15, 3-16, 3-27, 3-30, 3-32, 3-36, 3-40, 3-44, 3-47, 3-50, 3-53
Constellation(Line&Dot)	3-17, 3-19, 3-20, 3-54, 3-63, 3-71	Due to Modulation	3-6, 3-41, 5-4, 5-5
Constellation(Line)	3-17, 3-19, 3-20, 3-54, 3-63, 3-70	Due to Transient	3-6, 3-38, 5-4, 5-5
Cont Auto Level Set	3-22, 3-78		
Copy from STD	3-7, 3-12, 3-13, 3-14, 3-15, 3-16, 3-22, 3-26, 3-38, 3-39, 3-43, 3-46, 3-49, 3-52, 3-76		
		[E]	
		E.V.M. vs Chip	3-17, 3-19, 3-20, 3-54, 3-63, 3-71
[D]		Edit	3-17, 3-60
Data Rate	3-17, 3-60	Edit Table 1 2 3	3-22, 3-76
DC CAL	3-22, 3-76	Edit Table 4 5 6	3-22, 3-76
DCCH	3-20, 3-66	Edit Table 7 8 9	3-22, 3-76
Delay Time	3-7, 3-8, 3-9, 3-10, 3-13, 3-26, 3-29, 3-31, 3-34, 3-42	Equalizing Filter	3-17, 3-57
Delete	3-16	Estimated ρ in the Code Domain	
Delete Line	3-7, 3-9, 3-12, 3-13, 3-14, 3-15, 3-26, 3-32, 3-39, 3-43, 3-46, 3-49, 3-52	Power Measurement	5-7
Demod Data Save	3-20, 3-69	EVM	3-18, 3-62
Detector	3-7, 3-8, 3-9, 3-10, 3-11, 3-12, 3-13, 3-14, 3-15, 3-16, 3-27, 3-30, 3-32, 3-35, 3-36, 3-37, 3-39, 3-42, 3-44, 3-47, 3-50, 3-52	Ext Gate	3-10, 3-13, 3-35, 3-42
Display	3-17, 3-20,	EXT Trigger Delay	3-19, 3-20, 3-21, 3-69, 3-72, 3-73
		EXT Trigger Slope	3-17, 3-19, 3-20, 3-21, 3-58, 3-69, 3-72, 3-73
		[F]	
		FCH	3-20, 3-67
		F-Domain	3-6, 3-33
		Fixed Symbols Level	3-18, 3-62
		Format	3-17, 3-20, 3-55, 3-65
		Freq Meas Range	3-19, 3-20, 3-69, 3-72
		Freq. Setting	3-12, 3-13, 3-14, 3-15, 3-39, 3-44, 3-47, 3-50
		Frequency Input	3-22, 3-77
		Functional Description	3-23

- [G]**
- Gate Position 3-10, 3-13, 3-11, 3-12, 3-13, 3-14, 3-35, 3-42, 3-15, 3-16,
 - Gate Setup 3-10, 3-13, 3-27, 3-30, 3-33, 3-36, 3-41, 3-42, 3-37, 3-40,
 - Gate Source 3-10, 3-13, 3-45, 3-48, 3-34, 3-42, 3-51, 3-53
 - Gate Width 3-10, 3-13, 3-35, 3-42
 - Gated Sweep 3-10, 3-36
 - Gated Sweep ON/OFF 3-10, 3-13, 3-35, 3-42
 - General 6-1
 - GPIB Command Codes 4-11
 - GPIB Command Index 4-1
 - Graphics 3-17, 3-19, 3-20, 3-53, 3-63, 3-70
- [I]**
- I EYE Diagram 3-17, 3-19, 3-20, 3-54, 3-63, 3-71
 - I/Q EYE Diagram 3-17, 3-19, 3-20, 3-54, 3-63, 3-71
 - Ich & Qch Time 3-21
 - Ich Time & FFT 3-21
 - Inband Spurious 5-4, 5-6
 - Inband Spurious Modes 5-5
 - Inband Spurious(1) 3-6, 3-45
 - Inband Spurious(2) 3-6, 3-48
 - Input 3-22, 3-78
 - Insert Line 3-7, 3-9, 3-12, 3-13, 3-14, 3-15, 3-16, 3-26, 3-32, 3-38, 3-39, 3-43, 3-46, 3-49, 3-52
 - Integral Band 3-15, 3-51
 - INTRODUCTION 1-1
 - Introduction 6-1
 - IQ Complex FFT 3-21
 - IQ Gain Error 3-18, 3-62
 - IQ Inverse 3-22, 3-78
- [J]**
- Judgment 3-7, 3-8, 3-9, 3-10,
- [L]**
- Link 3-22, 3-77
 - Load Table 3-9, 3-16, 3-32, 3-52
 - Lower Limit 3-7, 3-10, 3-11, 3-27, 3-36, 3-37
- [M]**
- Mag Error vs Chip 3-17, 3-19, 3-20, 3-54, 3-63, 3-71
 - Margin ΔX ON/OFF 3-12, 3-13, 3-14, 3-15, 3-38, 3-43, 3-46, 3-49
 - Marker Edit 3-12, 3-13, 3-14, 3-15, 3-39, 3-43, 3-46, 3-49
 - Marker Edit Function 5-4
 - Meas 3-20, 3-60
 - Meas Length 3-21, 3-75
 - Meas Mode 3-20, 3-68
 - Meas Options 3-17, 3-60
 - Meas Range 3-17, 3-19, 3-20, 3-57, 3-68, 3-72
 - MEASUREMENT EXAMPLES 2-1
 - Measuring the Code Domain Power of Base Station Signals 2-1
 - Menu Index 3-1
 - Menu Map 3-6
 - Messages A-1
 - Mobile Station (MS) Code Domain Power Measurement 2-9
 - Modulation 3-6, 3-53
 - Multiplier 3-9, 3-32
- [N]**
- Null Offset Constellation 3-19, 3-71
 - Null Offset Constellation(Dot) 3-19, 3-71
 - Null Offset Constellation(Line&Dot) 3-19, 3-71

Alphabetical Index

Null Offset Constellation(Line) 3-19, 3-71
 Null Offset I EYE Diagram 3-19, 3-71
 Null Offset I/Q EYE Diagram 3-19, 3-71
 Null Offset Q EYE Diagram 3-19, 3-71

[O]

OBW 3-6, 3-37
 OBW% 3-11, 3-37
 OFF Position 3-8, 3-29
 OFF Width 3-8, 3-29
 Offset Level 3-22, 3-77
 ON Position 3-8, 3-29
 ON Width 3-8, 3-29
 ON/OFF Ratio 3-6, 3-8,
 3-28
 Operation Mode 3-20, 3-66
 Outband Spurious 3-6, 3-51

[P]

Parameter Setup 3-7, 3-8,
 3-9, 3-10,
 3-11, 3-12,
 3-13, 3-14,
 3-15, 3-16,
 3-17, 3-19,
 3-20, 3-21,
 3-27, 3-30,
 3-32, 3-36,
 3-37, 3-39,
 3-44, 3-47,
 3-49, 3-52,
 3-67, 3-72,
 3-73, 3-74,
 3-76
 Peak Factor of Tx Power 5-7
 Peak MKR Y Delta 3-9, 3-14,
 3-15, 3-16,
 3-32, 3-47,
 3-50, 3-52
 Performance Verification Procedure 6-4
 PERFORMANCE VERIFICATION
 TEST 6-1
 Performance Verification Test
 Procedure 6-5
 Performance Verification Test Record
 Sheet 6-4, 6-9
 Phase Error vs Chip 3-19, 3-20,
 3-64, 3-71
 Pilot Channel Power 3-18, 3-61
 Plot Type 3-17, 3-19,
 3-20, 3-54,
 3-64, 3-72

PN Delay 3-20, 3-69
 PN Delay Search Mode 3-20, 3-69
 PN Offset 3-17, 3-57
 PN Offset Search Mode 3-17, 3-57
 Power 3-6, 3-21,
 3-73
 Power (F-Domain) 3-33
 Power (T-Domain) 3-25
 Power Unit 3-18, 3-21,
 3-61, 3-74
 Preselector 3-9, 3-16,
 3-33, 3-53
 Product Overview 1-1

[Q]

Q EYE Diagram 3-17, 3-19,
 3-20, 3-54,
 3-63, 3-71
 Qch Time & FFT 3-21
 QOF 3-17, 3-59,
 3-60
 Quadrature Error 3-18, 3-20,
 3-62, 3-69

[R]

RC 3-17, 3-60
 Ref Power 3-12, 3-13,
 3-14, 3-15,
 3-40, 3-44,
 3-47, 3-50
 REFERENCE 3-1
 REMOTE CONTROL 4-1
 Result 3-9, 3-12,
 3-13, 3-14,
 3-15, 3-32,
 3-39, 3-44,
 3-47, 3-50
 Rolloff Factor 3-12, 3-13,
 3-17, 3-40,
 3-45, 3-57

[S]

Save Table 3-9, 3-16,
 3-32, 3-52
 Scale Setup 3-17, 3-21,
 3-55, 3-74
 SCH1 Repetition Factor 3-20, 3-67
 SCH1 Walsh Function 3-20, 3-67
 SCH2 Repetition Factor 3-20, 3-67
 SCH2 Walsh Function 3-20, 3-67
 Select Type 3-17, 3-19,
 3-20, 3-21,

	3-54, 3-63, 3-70, 3-75	Table Init	3-7, 3-9, 3-12, 3-13, 3-14, 3-15, 3-16, 3-27, 3-32, 3-39, 3-43, 3-46, 3-49, 3-52
Self Test Function	1-1	Table No. 1/2/3	3-9, 3-16, 3-31, 3-32, 3-52
Set to Default	3-9, 3-16, 3-33, 3-53	Table Page	3-17, 3-20, 3-56, 3-66
Set to STD	3-7, 3-8, 3-10, 3-11, 3-12, 3-13, 3-14, 3-15, 3-26, 3-28, 3-29, 3-30, 3-35, 3-36, 3-38, 3-41, 3-42, 3-45, 3-48, 3-51	T-Domain	3-6, 3-25
		TECHNICAL INFORMATION	5-1
Shift X	3-7, 3-12, 3-13, 3-14, 3-15, 3-26, 3-38, 3-43, 3-46, 3-49	Template	3-7, 3-12, 3-13, 3-14, 3-15, 3-26, 3-38, 3-42, 3-46, 3-48
Shift Y	3-7, 3-12, 3-13, 3-14, 3-15, 3-26, 3-38, 3-43, 3-46, 3-49	Template Couple to Power	3-7, 3-12, 3-13, 3-14, 3-15, 3-27, 3-40, 3-45, 3-48, 3-51
Signal Power	3-18, 3-62	Template Edit	3-7, 3-12, 3-13, 3-14, 3-15, 3-26, 3-38, 3-43, 3-46, 3-49
Signal Type	3-22, 3-77	Template Edit function	5-1
Slope	3-7, 3-8, 3-9, 3-10, 3-13, 3-25, 3-29, 3-31, 3-34, 3-41	Template Limit	3-7, 3-12, 3-13, 3-14, 3-15, 3-27, 3-40, 3-45, 3-48, 3-51
Sort	3-7, 3-12, 3-13, 3-14, 3-15, 3-27, 3-39, 3-43, 3-46, 3-49	Template ON/OFF	3-7, 3-13, 3-14, 3-15, 3-26, 3-38, 3-43, 3-46, 3-49
SPECIFICATIONS	7-1	Template Setting in the F-Domain Measuring Mode	5-3
Specifications Required for Test Signals	6-3	Template Setting in the T-Domain Measuring Mode	5-1
Spurious	3-6	Template UP/LOW	3-7, 3-26
Spurious (T-Domain)	3-31	Test Equipment	6-1
Start Offset	3-15, 3-51	Threshold	3-17, 3-20, 3-58, 3-68
STD	3-6, 3-22, 3-76	Time & FFT	3-6, 3-21, 3-75
STD Setup	3-22, 3-77	Total	3-17, 3-59
Stop Offset	3-15, 3-51	Trace Write ON/OFF	3-21, 3-75
Symbol Rate 1/T	3-12, 3-13, 3-40, 3-45	Trigger	3-10, 3-13,
[T]			
Table Edit	3-9, 3-16, 3-32, 3-52		

Alphabetical Index

Trigger Delay	3-21, 3-75, 3-76	Walsh Number	3-17, 3-60
Trigger Level	3-7, 3-8, 3-9, 3-10, 3-13, 3-21, 3-26, 3-29, 3-31, 3-34, 3-42, 3-73, 3-76	Waveform Quality (with REVERSE (RC1&2) setting)	3-6, 3-19
Trigger Mode	3-21, 3-75	Window ON/OFF	3-7, 3-8, 3-10, 3-26, 3-29, 3-35
Trigger Position	3-7, 3-8, 3-9, 3-10, 3-13, 3-26, 3-29, 3-31, 3-34, 3-42	Window Position	3-7, 3-10, 3-26, 3-35
Trigger Setup	3-7, 3-8, 3-9, 3-10, 3-13, 3-25, 3-28, 3-31, 3-34, 3-41	Window Setup	3-7, 3-8, 3-10, 3-26, 3-29, 3-35
Trigger Slope	3-21, 3-75, 3-76	Window Width	3-7, 3-10, 3-26, 3-35
Trigger Source	3-7, 3-8, 3-9, 3-10, 3-13, 3-17, 3-19, 3-20, 3-21, 3-25, 3-28, 3-31, 3-34, 3-41, 3-58, 3-69, 3-72, 3-73, 3-76		
Trigger Source INTRVL (EXT) and INTRVL	5-8		
Tx Power	3-6, 3-21, 3-73		

[X]

X Scale Max	3-21, 3-74
X Scale Range	3-21, 3-74

[Y]

Y Scale	3-17, 3-20, 3-56, 3-65
Y Scale [dB/div] 10/5/2	3-7, 3-8, 3-10, 3-27, 3-29, 3-35
Y Scale Upper	3-17, 3-56
Y/div	3-17, 3-20, 3-56, 3-64, 3-66
Y/div(Ch.Graph)	3-20, 3-65

[U]

Upper Limit	3-7, 3-8, 3-10, 3-11, 3-27, 3-30, 3-36, 3-37
-------------------	----------------------------------------------

[V]

View Channel	3-20, 3-65
View Mode	3-20, 3-64
View Setup	3-20, 3-64

[W]

Walsh Code Length	3-17, 3-20, 3-58, 3-67
-------------------------	------------------------

IMPORTANT INFORMATION FOR ADVANTEST SOFTWARE

PLEASE READ CAREFULLY: This is an important notice for the software defined herein. Computer programs including any additions, modifications and updates thereof, operation manuals, and related materials provided by Advantest (hereafter referred to as "SOFTWARE"), included in or used with hardware produced by Advantest (hereafter referred to as "PRODUCTS").

SOFTWARE License

All rights in and to the SOFTWARE (including, but not limited to, copyright) shall be and remain vested in Advantest. Advantest hereby grants you a license to use the SOFTWARE only on or with Advantest PRODUCTS.

Restrictions

- (1) You may not use the SOFTWARE for any purpose other than for the use of the PRODUCTS.
- (2) You may not copy, modify, or change, all or any part of, the SOFTWARE without permission from Advantest.
- (3) You may not reverse engineer, de-compile, or disassemble, all or any part of, the SOFTWARE.

Liability

Advantest shall have no liability (1) for any PRODUCT failures, which may arise out of any misuse (misuse is deemed to be use of the SOFTWARE for purposes other than its intended use) of the SOFTWARE. (2) For any dispute between you and any third party for any reason whatsoever including, but not limited to, infringement of intellectual property rights.

LIMITED WARRANTY

1. Unless otherwise specifically agreed by Seller and Purchaser in writing, Advantest will warrant to the Purchaser that during the Warranty Period this Product (other than consumables included in the Product) will be free from defects in material and workmanship and shall conform to the specifications set forth in this Operation Manual.
2. The warranty period for the Product (the "Warranty Period") will be a period of one year commencing on the delivery date of the Product.
3. If the Product is found to be defective during the Warranty Period, Advantest will, at its option and in its sole and absolute discretion, either (a) repair the defective Product or part or component thereof or (b) replace the defective Product or part or component thereof, in either case at Advantest's sole cost and expense.
4. This limited warranty will not apply to defects or damage to the Product or any part or component thereof resulting from any of the following:
 - (a) any modifications, maintenance or repairs other than modifications, maintenance or repairs (i) performed by Advantest or (ii) specifically recommended or authorized by Advantest and performed in accordance with Advantest's instructions;
 - (b) any improper or inadequate handling, carriage or storage of the Product by the Purchaser or any third party (other than Advantest or its agents);
 - (c) use of the Product under operating conditions or environments different than those specified in the Operation Manual or recommended by Advantest, including, without limitation, (i) instances where the Product has been subjected to physical stress or electrical voltage exceeding the permissible range and (ii) instances where the corrosion of electrical circuits or other deterioration was accelerated by exposure to corrosive gases or dusty environments;
 - (d) use of the Product in connection with software, interfaces, products or parts other than software, interfaces, products or parts supplied or recommended by Advantest;
 - (e) incorporation in the Product of any parts or components (i) provided by Purchaser or (ii) provided by a third party at the request or direction of Purchaser or due to specifications or designs supplied by Purchaser (including, without limitation, any degradation in performance of such parts or components);
 - (f) Advantest's incorporation or use of any specifications or designs supplied by Purchaser;
 - (g) the occurrence of an event of force majeure, including, without limitation, fire, explosion, geological change, storm, flood, earthquake, tidal wave, lightning or act of war; or
 - (h) any negligent act or omission of the Purchaser or any third party other than Advantest.
5. **EXCEPT TO THE EXTENT EXPRESSLY PROVIDED HEREIN, ADVANTEST HEREBY EXPRESSLY DISCLAIMS, AND THE PURCHASER HEREBY WAIVES, ALL WARRANTIES, WHETHER EXPRESS OR IMPLIED, STATUTORY OR OTHERWISE, INCLUDING, WITHOUT LIMITATION, (A) ANY WARRANTY OF MERCHANTABILITY OR FITNESS FOR A PARTICULAR PURPOSE AND (B) ANY WARRANTY OR REPRESENTATION AS TO THE VALIDITY, SCOPE, EFFECTIVENESS OR USEFULNESS OF ANY TECHNOLOGY OR ANY INVENTION.**
6. **THE REMEDY SET FORTH HEREIN SHALL BE THE SOLE AND EXCLUSIVE REMEDY OF THE PURCHASER FOR BREACH OF WARRANTY WITH RESPECT TO THE PRODUCT.**
7. **ADVANTEST WILL NOT HAVE ANY LIABILITY TO THE PURCHASER FOR ANY INDIRECT, INCIDENTAL, SPECIAL, CONSEQUENTIAL OR PUNITIVE DAMAGES, INCLUDING, WITHOUT LIMITATION, LOSS OF ANTICIPATED PROFITS OR REVENUES, IN ANY AND ALL CIRCUMSTANCES, EVEN IF ADVANTEST HAS BEEN ADVISED OF THE POSSIBILITY OF SUCH DAMAGES AND WHETHER ARISING OUT OF BREACH OF CONTRACT, WARRANTY, TORT (INCLUDING, WITHOUT LIMITATION, NEGLIGENCE), STRICT LIABILITY, INDEMNITY, CONTRIBUTION OR OTHERWISE. TORT (INCLUDING, WITHOUT LIMITATION, NEGLIGENCE), STRICT LIABILITY, INDEMNITY, CONTRIBUTION OR OTHERWISE.**
8. **OTHER THAN THE REMEDY FOR THE BREACH OF WARRANTY SET FORTH HEREIN, ADVANTEST SHALL NOT BE LIABLE FOR, AND HEREBY DISCLAIMS TO THE FULLEST EXTENT PERMITTED BY LAW ANY LIABILITY FOR, DAMAGES FOR PRODUCT FAILURE OR DEFECT, WHETHER ARISING OUT OF BREACH OF CONTRACT, TORT (INCLUDING, WITHOUT LIMITATION, NEGLIGENCE), STRICT LIABILITY, INDEMNITY, CONTRIBUTION OR OTHERWISE.**

CUSTOMER SERVICE DESCRIPTION

In order to maintain safe and trouble-free operation of the Product and to prevent the incurrence of unnecessary costs and expenses, Advantest recommends a regular preventive maintenance program under its maintenance agreement.

Advantest's maintenance agreement provides the Purchaser on-site and off-site maintenance, parts, maintenance machinery, regular inspections, and telephone support and will last a maximum of ten years from the date the delivery of the Product. For specific details of the services provided under the maintenance agreement, please contact the nearest Advantest office listed at the end of this Operation Manual or Advantest's sales representatives.

Some of the components and parts of this Product have a limited operating life (such as, electrical and mechanical parts, fan motors, unit power supply, etc.). Accordingly, these components and parts will have to be replaced on a periodic basis. If the operating life of a component or part has expired and such component or part has not been replaced, there is a possibility that the Product will not perform properly. Additionally, if the operating life of a component or part has expired and continued use of such component or part damages the Product, the Product may not be repairable. Please contact the nearest Advantest office listed at the end of this Operation Manual or Advantest's sales representatives to determine the operating life of a specific component or part, as the operating life may vary depending on various factors such as operating condition and usage environment.

SALES & SUPPORT OFFICES

Advantest Korea Co., Ltd.

22BF, Kyobo KangNam Tower,
1303-22, Seocho-Dong, Seocho-Ku, Seoul #137-070, Korea
Phone: +82-2-532-7071
Fax: +82-2-532-7132

Advantest (Suzhou) Co., Ltd.

Shanghai Branch Office:
Bldg. 6D, NO.1188 Gumei Road, Shanghai, China 201102 P.R.C.
Phone: +86-21-6485-2725
Fax: +86-21-6485-2726

Shanghai Branch Office:
406/F, Ying Building, Quantum Plaza, No. 23 Zhi Chun Road,
Hai Dian District, Beijing,
China 100083
Phone: +86-10-8235-3377
Fax: +86-10-8235-6717

Advantest (Singapore) Pte. Ltd.

438A Alexandra Road, #08-03/06
Alexandra Technopark Singapore 119967
Phone: +65-6274-3100
Fax: +65-6274-4055

Advantest America, Inc.

3201 Scott Boulevard, Suite, Santa Clara, CA 95054, U.S.A
Phone: +1-408-988-7700
Fax: +1-408-987-0691

ROHDE & SCHWARZ Europe GmbH

Mühldorfstraße 15 D-81671 München, Germany
(P.O.B. 80 14 60 D-81614 München, Germany)
Phone: +49-89-4129-13711
Fax: +49-89-4129-13723

ADVANTEST®

<http://www.advantest.co.jp>