ADVANTEST®
ADVANTEST CORPORATION

R3465 Series OPT52/57/58

DECT Measurement Option

Operation Manual

MANUAL NUMBER FOE-8311291B02

Applicable models

***R3263
R3465***

Safety Summary

To ensure thorough understanding of all functions and to ensure efficient use of this instrument, please read the manual carefully before using. Note that Advantest bears absolutely no responsibility for the result of operations caused due to incorrect or inappropriate use of this instrument.

If the equipment is used in a manner not specified by Advantest, the protection provided by the equipment may be impaired.

- **Warning Labels**

Warning labels are applied to Advantest products in locations where specific dangers exist. Pay careful attention to these labels during handling. Do not remove or tear these labels. If you have any questions regarding warning labels, please ask your nearest Advantest dealer. Our address and phone number are listed at the end of this manual.

Symbols of those warning labels are shown below together with their meaning.

DANGER: Indicates an imminently hazardous situation which will result in death or serious personal injury.

WARNING: Indicates a potentially hazardous situation which will result in death or serious personal injury.

CAUTION: Indicates a potentially hazardous situation which will result in personal injury or a damage to property including the product.

- **Basic Precautions**

Please observe the following precautions to prevent fire, burn, electric shock, and personal injury.

- Use a power cable rated for the voltage in question. Be sure however to use a power cable conforming to safety standards of your nation when using a product overseas.
- When inserting the plug into the electrical outlet, first turn the power switch OFF and then insert the plug as far as it will go.
- When removing the plug from the electrical outlet, first turn the power switch OFF and then pull it out by gripping the plug. Do not pull on the power cable itself. Make sure your hands are dry at this time.
- Before turning on the power, be sure to check that the supply voltage matches the voltage requirements of the instrument.
- Connect the power cable to a power outlet that is connected to a protected ground terminal. Grounding will be defeated if you use an extension cord which does not include a protected ground terminal.
- Be sure to use fuses rated for the voltage in question.
- Do not use this instrument with the case open.
- Do not place anything on the product and do not apply excessive pressure to the product. Also, do not place flower pots or other containers containing liquid such as chemicals near this

Safety Summary

product.

- When the product has ventilation outlets, do not stick or drop metal or easily flammable objects into the ventilation outlets.
- When using the product on a cart, fix it with belts to avoid its drop.
- When connecting the product to peripheral equipment, turn the power off.

- **Caution Symbols Used Within this Manual**

Symbols indicating items requiring caution which are used in this manual are shown below together with their meaning.

DANGER: Indicates an item where there is a danger of serious personal injury (death or serious injury).

WARNING: Indicates an item relating to personal safety or health.

CAUTION: Indicates an item relating to possible damage to the product or instrument or relating to a restriction on operation.

- **Safety Marks on the Product**

The following safety marks can be found on Advantest products.



: ATTENTION - Refer to manual.



: Protective ground (earth) terminal.



: DANGER - High voltage.



: CAUTION - Risk of electric shock.

- **Replacing Parts with Limited Life**

The following parts used in the instrument are main parts with limited life.

Replace the parts listed below before their expected lifespan has expired to maintain the performance and function of the instrument.

Note that the estimated lifespan for the parts listed below may be shortened by factors such as the environment where the instrument is stored or used, and how often the instrument is used.

The parts inside are not user-replaceable. For a part replacement, please contact the Advantest sales office for servicing.

Each product may use parts with limited life.

For more information, refer to the section in this document where the parts with limited life are described.

Main Parts with Limited Life

Part name	Life
Unit power supply	5 years
Fan motor	5 years
Electrolytic capacitor	5 years
LCD display	6 years
LCD backlight	2.5 years
Floppy disk drive	5 years
Memory backup battery	5 years

- **Hard Disk Mounted Products**

The operational warnings are listed below.

- Do not move, shock and vibrate the product while the power is turned on.
Reading or writing data in the hard disk unit is performed with the memory disk turning at a high speed. It is a very delicate process.
- Store and operate the products under the following environmental conditions.
An area with no sudden temperature changes.
An area away from shock or vibrations.
An area free from moisture, dirt, or dust.
An area away from magnets or an instrument which generates a magnetic field.
- Make back-ups of important data.
The data stored in the disk may become damaged if the product is mishandled. The hard disc has a limited life span which depends on the operational conditions. Note that there is no guarantee for any loss of data.

- **Precautions when Disposing of this Instrument**

When disposing of harmful substances, be sure dispose of them properly with abiding by the state-provided law.

Harmful substances: (1) PCB (polycarbon biphenyl)
(2) Mercury
(3) Ni-Cd (nickel cadmium)
(4) Other
Items possessing cyan, organic phosphorous and hexadic chromium and items which may leak cadmium or arsenic (excluding lead in solder).

Example: fluorescent tubes, batteries

Environmental Conditions

This instrument should only be used in an area which satisfies the following conditions:

- An area free from corrosive gas
- An area away from direct sunlight
- A dust-free area
- An area free from vibrations
- Altitude of up to 2000 m



Figure-1 Environmental Conditions

- Operating position



Figure-2 Operating Position

- Storage position



Figure-3 Storage Position

- The classification of the transient over-voltage, which exists typically in the main power supply, and the pollution degree is defined by IEC61010-1 and described below.

Impulse withstand voltage (over-voltage) category II defined by IEC60364-4-443

Pollution Degree 2

Types of Power Cable

Replace any references to the power cable type, according to the following table, with the appropriate power cable type for your country.

Plug configuration	Standards	Rating, color and length	Model number (Option number)
	PSE: Japan Electrical Appliance and Material Safety Law	125 V at 7 A Black 2 m (6 ft)	Straight: A01402 Angled: A01412
	UL: United States of America CSA: Canada	125 V at 7 A Black 2 m (6 ft)	Straight: A01403 (Option 95) Angled: A01413
	CEE: Europe DEMKO: Denmark NEMKO: Norway VDE: Germany KEMA: The Netherlands CEBEC: Belgium OVE: Austria FIMKO: Finland SEMKO: Sweden	250 V at 6 A Gray 2 m (6 ft)	Straight: A01404 (Option 96) Angled: A01414
	SEV: Switzerland	250 V at 6 A Gray 2 m (6 ft)	Straight: A01405 (Option 97) Angled: A01415
	SAA: Australia, New Zealand	250 V at 6 A Gray 2 m (6 ft)	Straight: A01406 (Option 98) Angled: -----
	BS: United Kingdom	250 V at 6 A Black 2 m (6 ft)	Straight: A01407 (Option 99) Angled: A01417
	CCC: China	250 V at 10 A Black 2 m (6 ft)	Straight: A114009 (Option 94) Angled: A114109

TABLE OF CONTENTS

1	OVERVIEW	1-1
1.1	Product Overview	1-1
1.2	Operation Flowchart	1-2
2	SWITCHING STANDARD MEASUREMENT (ONLY OPT52/58)	2-1
3	MEASUREMENT UNDER CW MODE	3-1
3.1	Center frequency setting (FREQ key)	3-1
3.2	Measurement of Occupied Bandwidth (OBW Key)	3-2
3.3	Measurement of Adjacent Channels Leakage Power (ACP Key)	3-3
3.4	Measurement of Harmonics (HARM Key)	3-4
4	MEASUREMENT UNDER TRANSIENT MODE	4-1
4.1	TDMA Waveform Analysis and Burst Envelope Waveform Display	4-2
4.2	Average Power Measurement in the Time Domain	4-10
4.3	'Emission due to Modulation' Measurement	4-13
4.4	'Emission due to Transient' Measurement	4-14
4.5	Spurious Measurement	4-16
4.6	Power Measurement	4-17
4.7	Power vs Time Measurement	4-18
4.8	FM-Deviation Measurement	4-20
4.9	Timing Jitter Measurement	4-22
4.10	Using the communication system setting menu	4-23
5	NOTES FOR THE RECALL FUNCTION	5-1
6	GPIB CODE LIST	6-1
7	SPECIFICATIONS OF DECT MEASUREMENT OPTION	7-1
	APPENDIX	A-1
A.1	Menu List of TRANSIENT Keys	A-1
A.2	List of Messages	A-4

LIST OF ILLUSTRATIONS

No.	Title	Page
Figure 1-1	Dialog Box	2-1
Figure 4-1	Power Template Measurement Screen	4-2
Figure 4-2	Trigger Setup Dialog Box	4-4
Figure 4-3	Waveform at Gate Sweep OFF	4-5
Figure 4-4	Waveform at Gate Sweep ON	4-6
Figure 4-5	Expansion of Display Using Window	4-8
Figure 4-6	Sample of Power (Time Domain) Measurement	4-12
Figure 4-7	Example of 'Emission due to Modulation' Measurement	4-14
Figure 4-8	Example of the 'Emission due to Transient' Measurement.	4-16
Figure 4-9	Example of Spurious Measurement	4-17
Figure 4-10	Template Setup Screen	4-19
Figure 4-11	Example of Power vs Time Measurement	4-19
Figure 4-12	Example of FM-Deviation Measurement	4-20
Figure 4-13	Example of Bit-Frequency Measurement	4-21
Figure 4-14	Example of EYE-Diagram Measurement	4-21
Figure 4-15	Example of Demodulated Data Measurement	4-21
Figure 4-16	Example of Timing Jitter Measurement	4-22
Figure 4-17	Communication System Setting Menu	4-23
Figure 5-1	Recall screen	5-1

1 OVERVIEW

1.1 Product Overview

The spectrum analyzer R3263 and the modulation spectrum analyzer R3465 are equipped with an one-touch function (TRANSIENT mode) to measure the transmitting characteristics of each digital radio system in addition to conventional spectrum analyzer functions(CW mode). By displaying necessary measurement items together in the soft menu by digital radio system, measurements can be performed easily according to desired setting

- DECT Option

By adding the DECT option to models R3263 and R3465, the TRANSIENT mode can be used as a tester to make a transmitting characteristics test of DECT RFP (Radio Fixed Part) and PP (Portable Part) alone.

Since each parameter in the system selected by the Setup STD menu is set automatically, the power of DECT, burst envelope, timing jitter, and FM deviation can each be measured without complicated panel operation. In addition, PASS/FAIL judgments by standard values or by user's values can be performed at the same time.

1.2 Operation Flowchart

1.2 Operation Flowchart

Steps depends on options you select.

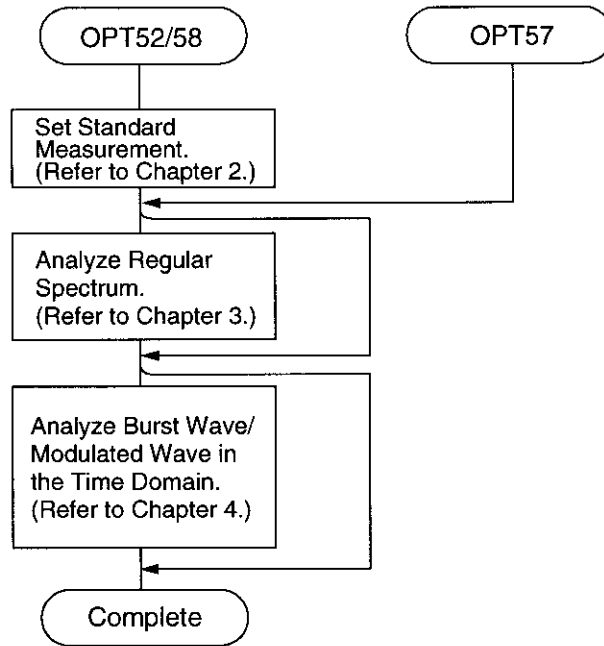

2 SWITCHING STANDARD MEASUREMENT (ONLY OPT52/58)

Model R3465

For OPT52, it is necessary to change the selected system from PDC/PHS/NADC standard measurement to DECT standard measurement.

For OPT58, it is necessary to change the selected system from GSM standard measurement to DECT standard measurement.

Model R3263

For both OPT52 and OPT58, it is necessary to change the selected system from GSM standard measurement to DECT standard measurement.

Note: As OPT57 is set to DECT standard measurement system, no further setting is needed.

[Operating procedure]

- ① Press [LCL] then {Comm. System} keys display the dialog box in Figure 1-1.

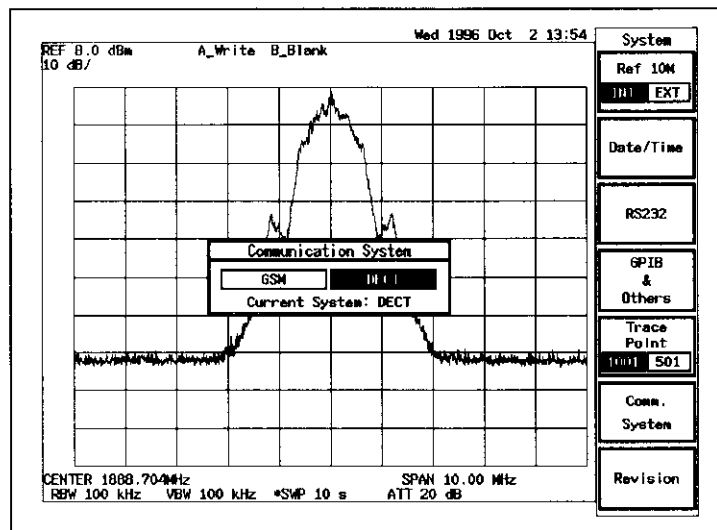

Figure 1-1 Dialog Box

- ② Select a communication system (PDC/PHS/NADC (or GSM) or CDMA) with the data knob.
- ③ Press [Hz] or turn the data knob to determine the setting.
Then a box for a confirmation appears. If you want to make the setting effective, select "Confirm". If making it ineffective, select "Cancel" and press [Hz].
- ④ If the power is turned off once then turned on, the communication system to be measured and the menu for measurement are switched. Following this, the previous selected standard measurement (see ② above) is enabled.
Then the standard measurement set at ② becomes executable.

Note1: After the system is switched by using Comm. System, always execute a calibration.

Note2: If the power is turned on after the system is switched by using the Comm. System, the unit reverts to the original factory settings.

3 MEASUREMENT UNDER CW MODE

Model R3465

When OPT52/57/58 are selected, the specifications of the basic key FREQ and OBW/ACP/HARM key in the MEASUREMENT section are changed as follows.

Model R3263 does not have the OBW key, ACP key, and HRAM key.

3.1 Center frequency setting (FREQ key)

- Using the FREQ key menu

[FREQ]



{Center} Sets the center frequency setting mode.

{Start} Sets the start frequency setting mode.

{Stop} Sets the stop frequency setting mode.

{CF Step Size AUTO MNL}

When MANUAL is selected, step size of the center frequency can be set. In MANUAL, data can be entered and the step size data of the center frequency is displayed on the screen.

In AUTO, the step size is set to 1/10 of the frequency span.

{Freq Offset ON OFF}

When ON is selected, an offset frequency can be set in the range of 0 to $\pm 100,000$ MHz. If a value less than the display resolution is entered, it will be replaced with the value of the display resolution.

Center frequency (displayed) = Center frequency (set) + Offset

When OFF is selected, the offset is canceled.

{Freq Input} Sets the method of inputting the center frequency with the FREQ key.

FREQ: Frequency input method

CHANNEL No.: Channel input method

The correspondence between input channel and center frequency depends on the setting of the communication type and link.

The channel input method uses the Offset Frequency function and the Offset Channel function to change channel frequencies.

These functions are summarized as follow:

Channel Offset:

Channel No. = Channel No. (selected) + an Offset

Frequency Offset:

Center frequency = Original center frequency allocated by a channel + an offset frequency

3.2 Measurement of Occupied Bandwidth (OBW Key)

*Note: The offset frequency value depends on the frequency set in the channel setting or the "Due to transient" mode.
To change the frequency offset value, set the channel number again using the **FREQ** keys. Changing only the offset frequency value will not change the setting.*

3.2 Measurement of Occupied Bandwidth (OBW Key)

Pressing **[OBW]** enters OBW measurement mode, halting sweep.

This is the condition waiting for OBW measurement related parameters being input or measurement start command being input.

When setup parameters are not necessary to be changed, press **[REPEAT]** or **[SINGLE]** to start measurement.

When measurement has been started with **[REPEAT]**, measurement is continued after the end of a measurement.

When measurement has been started with **[SINGLE]**, operation stops after the end of a measurement.

- Using the OBW key menu

[OBW] Calculates the occupied bandwidth of the waveform displayed on the screen. For the result, occupied bandwidth and carrier frequency (Fc) which is equal to the central frequency in the occupied bandwidth are displayed in the result display area on the screen.

↓
{OBW%} Sets the ratio to the total power in the occupied bandwidth. Setting range is 10% to 99.8%, and initial value is 99%.

{AVG Times ON OFF}
Sets average times.
When turned ON, executes operation for measuring occupied bandwidth after executing trace averaging the set times.

{Parameter Setup}
Displays the parameter select menu for the measurement of occupied bandwidth.

{User} Specify to measure under the conditions set with **{Define → User}**.

{Manual} Specify to measure with parameter setting other than the measurement parameters which are already specified or set with **{Define → User}**.
When this measurement is selected, set necessary parameters before executing measurement.

{Define → User} Stores the current set condition and makes it the condition on selecting the **{User}**.

{return} Returns to the preceding menu.

{Quit} Returns from OBW measurement mode to normal spectrum measurement mode.

3.3 Measurement of Adjacent Channels Leakage Power (ACP Key)

Pressing **[ACP]** enters ACP measuring mode, halting sweep.

When currently set parameters need not to be changed, press **[REPEAT]** or **[SINGLE]** to start measurement.

When measurement has been started with **[REPEAT]**, measurement is continued after the end of a measurement.

When measurement has been started with **[SINGLE]**, operation stops after the end of a measurement.

- Using the ACP key menu

[ACP]



Calculates the total power from measured data displayed on the screen, and integrates power in specified bandwidth to obtain the ratio to the total power.

For out-of-spec measurement, 2 measuring methods are available: "Full mode" to measure based on the measured data which is displayed on a single screen and "Sepa mode" to measure based on the data obtained by dividing screen for specified channel and upper and lower channels.

{Channel spacing}

Sets the distance between channels.

{Specified Band Width}

Sets specified bandwidth.

{Parameter Setup}

Displays the parameters select menu for measuring the leak power from adjacent channels.

{User}

Specifies to measure under the conditions set with *{Define → User}*.

{Manual}

Specifies to measure under the condition set at present.

When this mode is selected, set necessary parameters before starting measurement.

{Define → User}

Stores the current set condition and makes it the condition on selecting the *{User}*.

{return}

Returns to the preceding menu.

{Screen Full Sepa}

Selects the measuring mode for carrier and adjacent channels. In Full mode, the data in a single screen is fetched to execute calculation.

In Sepa mode, specified channel and upper and lower channels are independently swept and thus fetches the data for 3 screens to execute calculation.

3.4 Measurement of Harmonics (HARM Key)

- {Graph}* Displays leakage power for all the frequency points displayed on the screen.
The leakage power in all the frequency points displayed on the screen with bandwidth specified at *{Specified Bandwidth}* is calculated and the graph displays it as trace B.
{Graph ON OFF} If the leakage power graph display is selected, the graph is displayed in trace B after the measurement and Δ marker is automatically centered.
 Δ marker can be set at any location on the graph, allowing the user to determine the leakage power for each frequency at this points.
- {Multi MRK Set}* By using multi marker, leakage power in multi points can be obtained simultaneously. Move the multi markers to the frequency points you want to measure.
As the data of multi marker No. 1 to No. 6 are displayed on the upper right screen, the leakage power on the multi points can be obtained at the same time.
- {return}* Returns to the preceding menu.
- {Quit}* Returns from ACP measurement mode to normal spectrum measurement mode.

3.4 Measurement of Harmonics (HARM Key)

Pressing **[HARM]** enters harmonics measuring mode, halting sweep.
Entering harmonics measuring mode automatically sets start/stop frequency according to the parameters preset at selecting the mode.
When currently set parameters need not to be changed, press **[REPEAT]** or **[SINGLE]** to start measurement.
When measurement has been started with **[REPEAT]**, measurement is continued after the end of a measurement.
When measurement has been started with **[SINGLE]**, operation stops after the end of a measurement.

- Using the HARM key menu

[HARM]



{FUND Frequency}

Set the frequency of fundamental wave.

{Harmonic Number}

Sets with order harmonic to measure.

The initial value is 3, however the user can set a value from 2 to 10 by choosing the appropriate number key.

{Quit}

Returns from HARM measurement mode to normal spectrum measurement mode.

4 MEASUREMENT UNDER TRANSIENT MODE

- Using the TRANSIENT key menu

[TRANSIENT] Select TRANSIENT mode to perform burst and modulation waveform analysis in the time domain and envelope analysis in the frequency domain of a burst signal. This is used exclusively from the conventional spectrum analysis mode (CW mode).



{Burst Env Spectrum}

This is used when performing waveform analysis of burst signals.

{Time Domain Meas}

This is used when performing electric power measurements and On/Off ratio measurements of the burst waveform in the time domain.

{Spectrum}

This is used when performing measurements in the frequency domain and when performing spurious measurements.

{Output Power} Calculates the quality of waveform of the input signal (ρ , τ , Carrier Feed through, Magnitude Error, Phase Error or E.V.M.).

{FM Deviation} Calculates the frequency deviation.

{Timing Jitter} Measures burst jitter between PP \rightarrow PP, RFP \rightarrow RFP, and RFP \rightarrow PP.

{Setup STD} This is used when setting parameters such as specifications for the measurement signal and transmission direction.

CAUTION!

In general, operation in TRANSIENT mode are performed using soft keys. The following keys which can be used when performing conventional spectrum measurements (in CW mod) cannot be used in this mode.

SWEEP, INPUT, FORMAT, WINDOW, \rightarrow CF, \rightarrow RL

Also, only settings made using numeric values, knobs, and arrow keys can be made for the following keys (the corresponding soft key menu will not be displayed).

FREQ, LEVEL, SPAN (1*), ATT (2*)

(1): SPAN can only be used during frequency domain measurements.*

(2): ATT can only be used when the setting is MNL.*

All measurements are started and stopped using the SINGLE/REPEAT keys. Be sure that the system is in stop mode when changing measurement parameters.

When using the external trigger, input a trigger signal with the TTL level into the external trigger input terminal on the rear panel.

4.1 TDMA Waveform Analysis and Burst Envelope Waveform Display

4.1 TDMA Waveform Analysis and Burst Envelope Waveform Display

[TRANSIENT] → {Burst Env Spectrum}

Select the TDMA waveform analysis function.
It is possible to measure temporal waveforms anywhere in the range 50μs to 2s using the [SWP T].

A template (limit line) conforming to specifications is automatically displayed, and the burst pulse is judged for Pass/Fail.

Note: *No template will be displayed if the limit line mode is OFF or if a limit line defined by the user is selected but no user definition table data exists. The rising edge position and wave level of the temporal waveform displayed does not necessarily match standard template (limit line) values. In order to use this function efficiently, it is necessary to adjust the horizontal (time axis) positions and vertical (level) positions of the burst pulse and template. This is used to adjust Shift X of the Trigger Position and limit line in the horizontal direction and Shift Y of the limit line in the vertical direction. Once these settings have been made, subsequent measurements can be made without having to make the adjustments again. Also, adjust the setting value of the resolution bandwidth.*

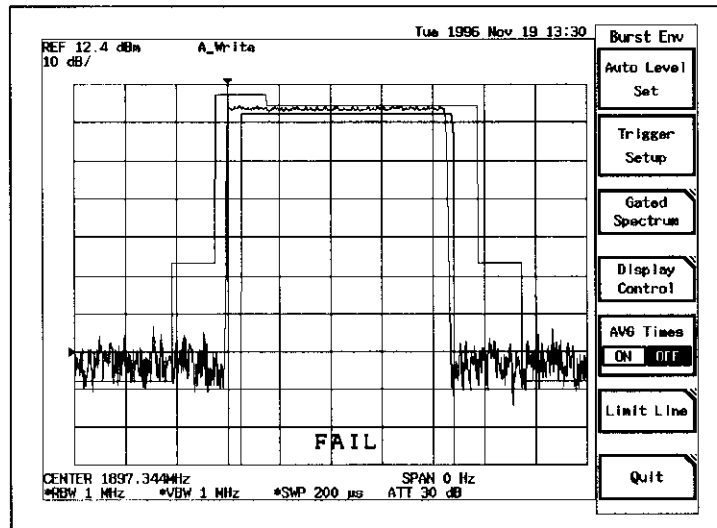

Figure 4-1 Power Template Measurement Screen

{Auto Level Set}

This is used to set the internal reference level (REF LEVEL), which is used in the time waveform analysis and the frequency waveform analysis, to the optimum value according to the measurement signal.

4.1 TDMA Waveform Analysis and Burst Envelope Waveform Display

{Trigger Setup}

A Dialog Box for trigger settings will appear. It can be used to set trigger source, trigger level, trigger position, and delay time settings.

When making settings, select the parameter to be set using the step key and select the parameter value to be set using the data knob. After parameters have been selected, you can set them by pressing the data knob or pressing the **[Hz]**.

The Dialog Box will disappear either of these keys is pressed.

Trigger: Selects the trigger source (signal from which synchronization is taken) for controlling the measurement timing for the burst signal or other.

Free run: Selects asynchronous measurement mode. (Measure using internal measurement timing.)

Video: Selects a measurement mode synchronized with the internal Video signal.

If Signal: Selects a measurement mode synchronized with the internal IF signal (21.4 MHz).

Exit: Selects a measurement mode synchronized with a signal input from an external source (EXT TRIG connector on the rear panel).

Slope: Select whether to match the sync position with the rising edge (+) of the signal (Video, IF Signal or EXT) or with the falling edge (-) of the signal.

Trigger Level:

Specifies the level position of the trigger source signal (video, IF Signal or EXT) at which to take synchronization. A trigger level position mark (▶) will be displayed at the left of the display scale.

The data can be set by using the data knob or ten-key and pressing the **[Hz]**.

Source Monitor:

Select whether or not to display the temporal waveform for the trigger source. This is automatically set to OFF whenever the trigger source is changed. (This selection is only available when the trigger source is the IF signal.)

Trigger Position:

Sets the X axis position (time) of the trigger source signal (Video, IF Signal or EXT) at which to synchronize. A trigger position mark (▼) will be displayed above the display scale. The data can be set by using the data knob or ten-key and pressing the **[Hz]**.

Full Slot Number:

Half Slot Number:

When the trigger source is set as Ext, the Delay Time is automatically set according to the following equation.

$$\begin{aligned} \text{Delay Time} &= \text{Full Slot Number} \times (10/24) \\ &\quad + \text{Half Slot Number} \times (10/48) \text{ ms} \end{aligned}$$

Delay Time:

Sets the delay time to be added to the trigger source signal.

4.1 TDMA Waveform Analysis and Burst Envelope Waveform Display

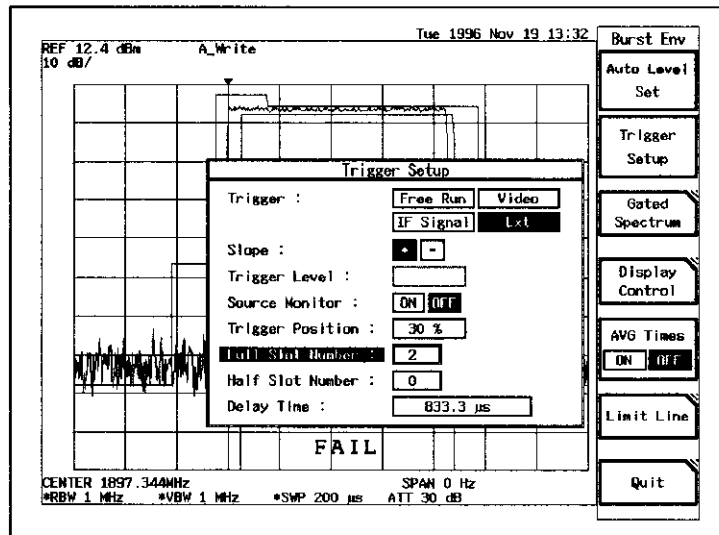

Figure 4-2 Trigger Setup Dialog Box

{Gated Spectrum}

Parameter settings for gated sweep can be made while monitoring the waveform in the time domain or in the frequency domain. In this mode, a split screen display results with the frequency waveform in the upper screen and the temporal waveform in the lower screen.

{Save Parameter} This records all gated sweep parameters. Parameters recorded here are used as the gated sweep parameters for the "Emission due to Modulation" measurement. The following parameters are inherited by the Channel Power measurement: Gate Position, Gate Width, Gate Source, Slope, Gate Threshold.

{Gate Setup} This is used to set the gate position/width to be used for gated sweep.

{Default} This sets the gate position/width to the default value.

{Gate Position} This sets the gate position.

{Gate Width} This sets the gate width.

{return} This returns to the previous menu.

Note: The default value of the gate position/width is set as follows.

- Gate position = Trigger position + 33μs
- Gate width = 0.6 × Burst length

4.1 TDMA Waveform Analysis and Burst Envelope Waveform Display

{Gate Source IF Sig EXIT}

This selects the gate signal source. The source is set to the internal IF signal when IF Sig is selected. The source is set to the external signal input to the "EXT TRIG" connector on the rear panel when Ext is selected.

{Slope + -}

This selects the polarity of the gate signal source.

{Gate Threshold}

This is used to set the IF signal level anywhere between 0% and 100% when IF Sig is selected as the gate signal source. This setting changes the timing of gate signal generation.

{Gated SWP ON OFF}

This alternately sets the sweep mode to gated sweep ON/OFF. Gated sweep results when ON is selected.

Note1: When gated sweep is selected, sweep for both the frequency waveform and the temporal waveform will appear as if stopped if the parameters set for gated sweep are inappropriate, but sweep can be started when changing to appropriate settings.

Note2: When IF Sig. is selected as the Gate Source, the gated sweep will appear as if it has stopped if the span is widened more than 7 MHz, but the sweep can be started by adjusting the setting appropriately.

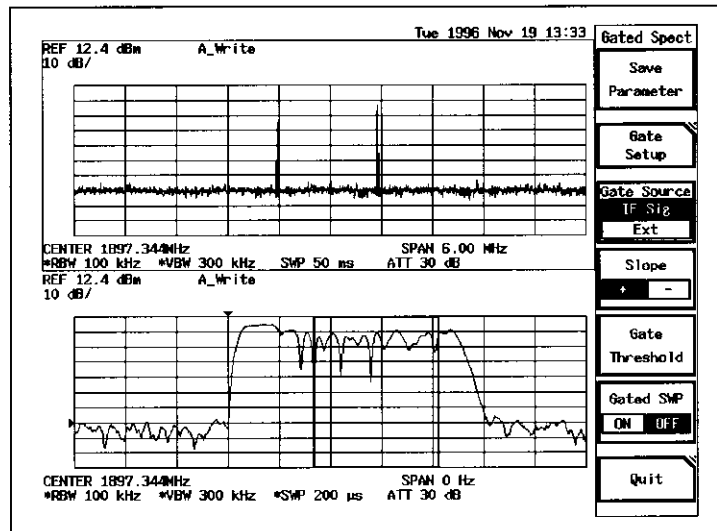

Figure 4-3 Waveform at Gate Sweep OFF

4.1 TDMA Waveform Analysis and Burst Envelope Waveform Display

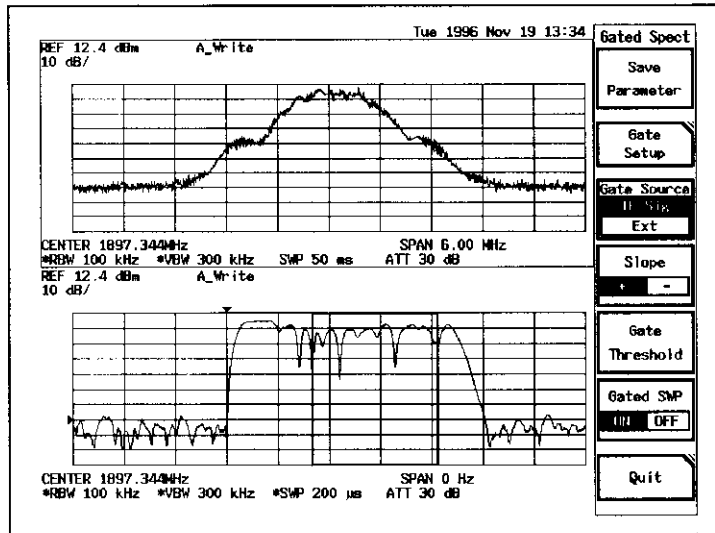

Figure 4-4 Waveform at Gate Sweep ON

{Quit} This escapes from gated sweep mode and returns to the menu of the previous level. The split screen display will automatically return to a single screen display once Quit is selected.

{Display Control}

This is used for an enlarged split-screen display (T-Zoom) of the time scale using windows, to switch the waveform display of the time scale where the window is open, and to switch horizontal axis scales.

{T-Zoom} This results in a split-screen display with the waveform in the upper screen and width of current window displayed in the lower screen.

{Zoom on Window} This automatically sets the trigger delay time and sweep time in accordance with the width of the current window and enlarges the waveform in the window using a single screen display.

{Zoom Off} This cancels the enlarged display mode set by Zoom on Window. The Dialog Box will appear when this key is pressed, and you can select one of the three cancellation methods (Last State, Burst, Frame) using the data knob. Once the method has been selected, it can be activated by pressing the data knob or **[Hz]** key.

Last state: Returns to the trigger delay time, sweep time, and trigger position used before zooming with the Zoom on Window function.

4.1 TDMA Waveform Analysis and Burst Envelope Waveform Display

Burst: Makes the following settings according to single slot burst waveform monitoring, and cancels Zoom mode.

Trigger delay time:

Delay time before executing Zoom on Window.

Sweep time and trigger position varies according to the Physical Packet. (See chart below.)

Physical packet	Sweep time	Trigger position
P00	200 μ s	30%
P32	500 μ s	13%
P32 + Zfield	500 μ s	13%
P08j	300 μ s	23%
P08j + Zfield	300 μ s	23%
P80	1ms	10%
P80 + Zfield	1ms	10%

Frame: Makes the following settings according to frame burst waveform monitoring, and cancels Zoom mode.

Trigger delay time: 0 sec

Sweep time: 10 msec

Trigger position: 0%

4.1 TDMA Waveform Analysis and Burst Envelope Waveform Display

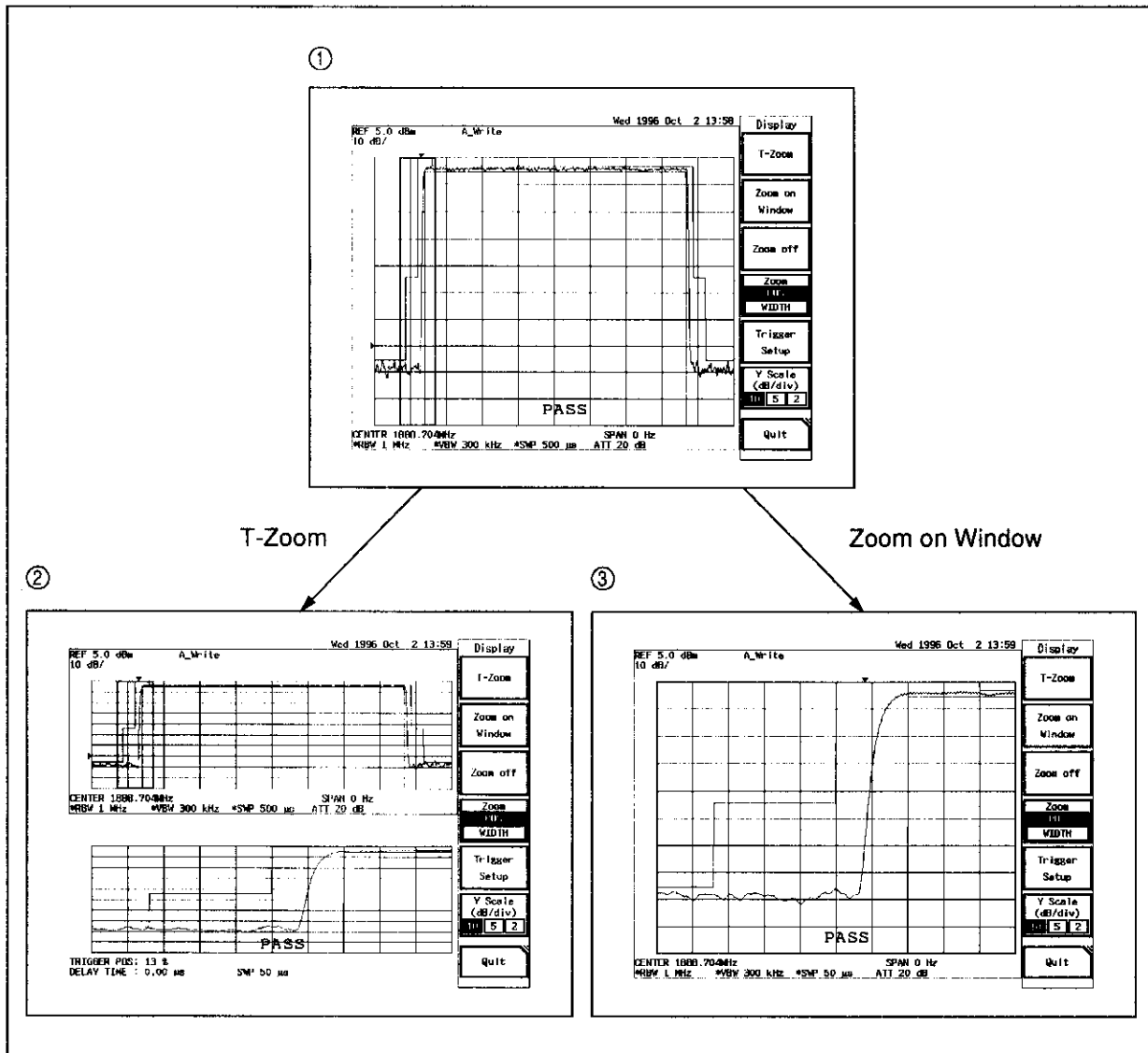

Figure 4-5 Expansion of Display Using Window

{Zoom POS WIDTH}

This allows the window position to be changed when POS is selected, and allows the window width to be changed when WIDTH is selected. Delay time and sweep time for the lower screen when in T-Zoom mode, and the delay time and sweep time when enlarged under Window to Span mode are set automatically. Window width can be set between 50 μ sec and 2 sec.

4.1 TDMA Waveform Analysis and Burst Envelope Waveform Display

- {Trigger Setup}* A Dialog Box for making trigger settings will appear. It can be used to make trigger source, trigger level, trigger position, and delay time settings.
When making settings, select the parameter to be set using the step key and select the parameter value to be set using the data knob. After parameters have been selected, you can set them by pressing the data knob or pressing the [Hz]. The Dialog Box will disappear once either of these keys is pressed.
- {Y Scale [dB/div] 10 5 2}*
This changes the vertical scale of the display.
- {Quit}* This cancels T-Zoom mode, and escapes from the Display Control.
- {AVG Times ON OFF}*
Set the number of averaging.
The available number is 2 to 32.
- {Limit Line}* This sets the limit line in the time domain.
- {Table STD USER}*
STD: This uses the specification value of DECT.
USER: This uses the table input using the Limit Line Edit key.
- {Shift X Y}* This shifts time data (X) or level data (Y) which has already been input.
- {Limit Line ON OFF}*
Switches between limit line ON and OFF.
- {Limit Line Edit}* This displays a menu for copying and/or editing the limit data table.
- {Limit Line UP LOW}*
Switches between limit line UP and LOW.
- {Input INSERT OVERWRT}*
This selects insert mode (INSERT) or overwrite mode (OVERWRT) when editing.
- {Cursor Change}*
This switches input (frequency and/or time and level).
- {Delete Line}* This delete the line the cursor is on.
- {Table Init}* This initializes the limit line table data.
- {Copy Table STD to USER}*
This copies data corresponding to a specification to a user-defined table.

4.2 Average Power Measurement in the Time Domain

{return} This returns to the previous menu.

{return} This returns to the previous menu.

{Quit} This escapes from the TDMA waveform analysis.

4.2 Average Power Measurement in the Time Domain

[TRANSIENT] → *{Power}*

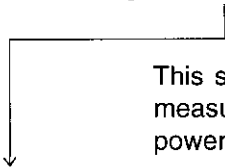

This selects average power measurement in the time domain. It is possible to measure the average power of the entire signal being displayed or the average power within the window.

{Auto Level Set}

This sets the internal reference level (REF LEVEL), which is used in the time waveform analysis to the optimum value according to the measurement signal.

{Trigger Setup} Selects the trigger source (signal from which synchronization is taken) for controlling the measurement timing for the burst signal or other. When making settings, select the parameter to be set using the step key and select the parameter value to be set using the data knob. After parameters have been selected, you can set them by pressing the data knob or pressing the **[Hz]**. The Dialog Box will disappear once either of these keys is pressed.

- Trigger: Selects the trigger source (signal from which synchronization is taken) for controlling the measurement timing for the burst signal or other.
- Free Run: Selects asynchronous measurement mode. (Measure using internal measurement timing.)
- Video: Selects a measurement mode synchronized with the internal Video signal.
- If Signal: Selects a measurement mode synchronized with the internal IF signal (21.4 MHz).
- Ext: Selects a measurement mode synchronized with a signal input from an external source (EXT TRIG connector on the rear panel).
- Slope: Select whether to match the sync position with the rising edge (+) of the signal (Video, IF Signal or EXT) or with the falling edge (-) of the signal.
- Trigger Level: Specifies the level position of the trigger source signal (Video or IF Signal) at which to synchronize. A trigger level position mark (▶) will be displayed to the left of the display scale. The data can be set by using the data knob or ten-key and pressing the **[Hz]**.
- Source Monitor: Select whether or not to display the waveform for the trigger source. This is automatically set to OFF whenever the trigger source is changed. (This selection is only available when the trigger source is the IF signal.)

4.2 Average Power Measurement in the Time Domain

Trigger Position: Sets the X axis position (time) of the trigger source signal (Video, IF Signal or EXT) at which to synchronize. A trigger position mark (▼) will be displayed above the display scale. The data can be set by using the data knob or ten-key and pressing the [Hz].

Full Slot Number:

Half Slot Number:

When the trigger source is set as Ext, the Delay Time is automatically set according to the following equation.

$$\text{Delay Time} = \text{Full Slot Number} \times (10/24) + \text{Half Slot Number} \times (10/48) \text{ ms}$$

Delay Time:

Sets the delay time to be added to the trigger source signal.

{Window Setup}

This sets the position/width of the window displayed.

{Window ON OFF}

This display is a window which limits the measurement range. When the window is displayed, all points within the window are used to calculate electric power. When the window is not displayed, all points with in the screen are used.

{Default}

Window position and width are varies according to the Physical Packet. (See chart below.)

Physical packet	Position	Width
P00	65 μs	82.47 μs
P32	70 μs	363.7 μs
P32 + Zfield	70 μs	367.2 μs
P08j	74 μs	155.4 μs
P08j + Zfield	74 μs	158.9 μs
P80	105 μs	780.4 μs
P80 + Zfield	105 μs	783.9 μs

{Window Position}

This sets the position of the window.

{Window Width} This sets the width of the window.

{return}

{Y Scale [dB/div] 10 5 2}

This sets the vertical scale of the display.

4.2 Average Power Measurement in the Time Domain

{AVG Times ON OFF}

This sets the average processing count for making the average power measurement. The count can be set from 2 to 999.

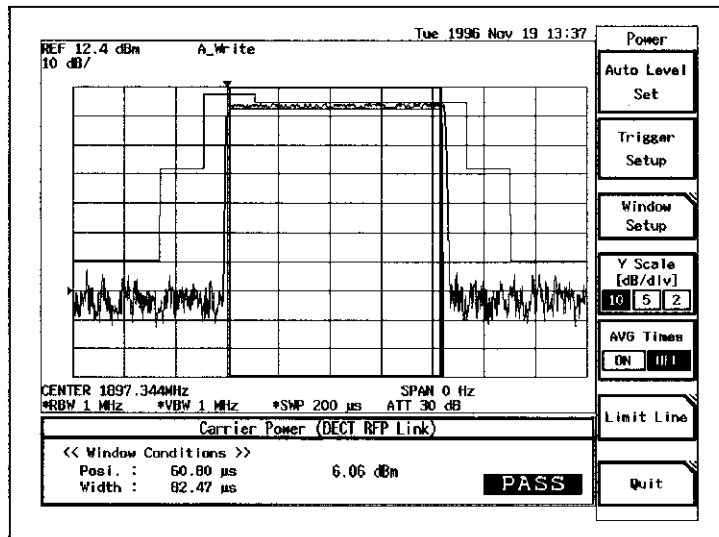

Figure 4-6 Sample of Power (Time Domain) Measurement

{Limit Line} This sets the limit line in the time domain.

{Table STD USER}

STD: This uses the specification value of DECT.

USER: This uses the table input using the Limit Line Edit key.

{Shift X Y} This shifts time data (X) or level data (Y) which has already been input.

{Limit Line Adjust AUTO MNL}

This sets the template to link to power measurement or not.

AUTO: This adjust the template by the power in the window.

MNL: This does not adjust the template automatically.

{Limit Line ON OFF}

Switches between limit line ON and OFF.

- {Limit Line Edit}* This displays a menu for copying and/or editing the limit line data table.
- {Limit Line UP LOW}*
Switches between limit line UP and LOW.
- {Input INSERT OVERWRT}*
This selects insert mode (INSERT) or overwrite mode (OVERWRT) when editing.
- {Cursor Change}*
This switches input (frequency and/or time and level).
- {Delete Line}*
This delete the line the cursor is on.
- {Table Init}* This initializes the limit line table data.
- {Copy Table STD to USER}*
This copies data corresponding to a specification to a user-defined table.
- {return}* This returns to the previous menu.
- {return}* This returns to the previous menu.
- {Quit}* This escapes from the average power measurement.

4.3 'Emission due to Modulation' Measurement

[TRANSIENT] → *{spectrum}* → *{Emi. Due to Modulation}*

Gated-sweeps depend on the condition saved by BurstEnv. Spectrum → Gated Spectrum → Save Parameter.

{Parameter Setup}

Displays each parameter selection menu for the measurement of 'Emission due to Modulation'.

{STD} Measures using RBW, VBW, Span, and Sweep Time which are set according to the specifications. (RBW: 100kHz, VBW: 300kHz, Span: 6MHz, Sweep Time: Auto)

{User} Measures under the condition set at *{Define → User}*.

{Manual} Measures with optional parameters other than the measurement parameter previous set at *{Define → User}*.

{Define → User} Stores the present setting conditions as *{User}* can subsequently be selected from the power menu. (It becomes *{User}* active.)

{return}

4.4 'Emission due to Transient' Measurement

{Max Hold ON OFF}

Sets the number of Max Hold from a range of 2 to 999.

{Limit Setup}

Sets the ON/OFF of the Pass/Fail display and the limit value.

Type: Uses STD/USER(STD/DECT) specification value.

Judgment: Sets ON/OFF of the ON/OFF: Pass/Fail.

M ± 1 : Sets the limit value of M ± 1 channel. (Initial set value: 160.0 μW)

M ± 2 : Sets the limit value of M ± 2 channel. (Initial set value: 1.0 μW)

M ± 3 : Sets the limit value of M ± 3 channel. (Initial set value: 20nW)

{Quit}

Exits from 'Emission due to Modulation' measurement.

Note The measurement for M ± 2 channel is performed only when the SPAN is set to more than 7.92MHz. However, the sweep may not be performed depending on the signal level if IF Sig. is selected as the gate signal source because of gated-sweeping. In this case, the sweep can be restarted by narrowing the span.

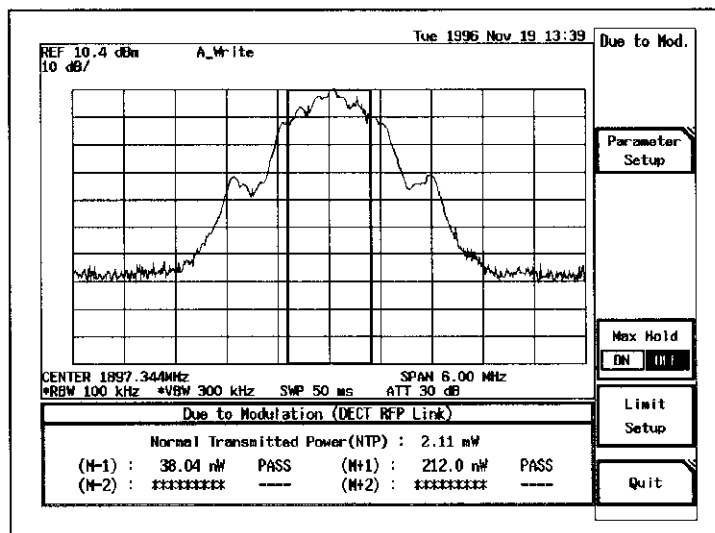

Figure 4-7 Example of 'Emission due to Modulation' Measurement

4.4 'Emission due to Transient' Measurement

[TRANSIENT] → | {spectrum} → | {Emi. Due to Transient}

{Parameter Setup}

Displays each parameter selection menu for the measurement of 'Emission due to Transient'.

{STD}

Measures with RBW, VBW, Span, and Sweep Time which are decided in the specifications. (RBW: 100kHz, VBW: 100kHz, Span: 27.64MHz, Sweep Time: 5s)

{User}

Measures under the condition set at {Define → User}.

- {Manual}* Measures with an optional parameter other than the measurement parameter previously set at *{Define → User}*.
- {Define → User}* Stores the present setting conditions as *{User}* can subsequently be selected from the parameter menu. (It becomes *{User}* active.)
- {return}*
- {Max Hold ON OFF}*
Sets the number of Max Hold from a range of 2 to 999.
- {Limit Line}*
- {Table STD USER}*
STD: Uses the specification value of DECT.
USER: Uses the table input with Limit Line Edit key.
- {Shift X Y}* Shifts the template in X direction or Y direction.
- {Limit Line ON OFF}*
Switches the limit line to ON/OFF.
- {Limit Line Edit}* Displays the menu to copy or edit the data table of the Limit Line.
- {Input INSERT OVERWRT}*
Selects insert mode (INSERT) or overwrite mode (OVERWRT).
- {Cursor Change}*
Switches the input (frequency and level).
- {Delete Line}* Deletes the cursor line.
- {Table Init}* Initializes the Limit Line table data.
- {Copy Table STD to USER}*
Copies the standard specification data to the user defined table.
- {return}* Returns to the previous menu.
- {return}* Returns to the previous menu.
- {Quit}* Exits from 'Emission due to Transient' measurement.

4.5 Spurious Measurement

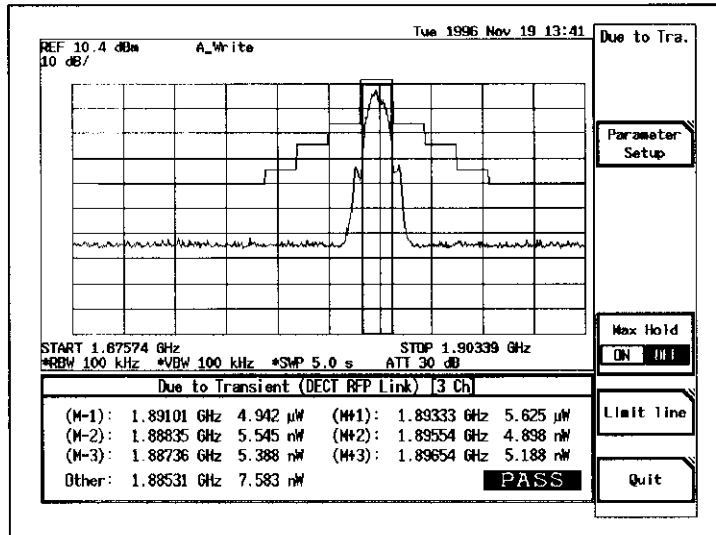
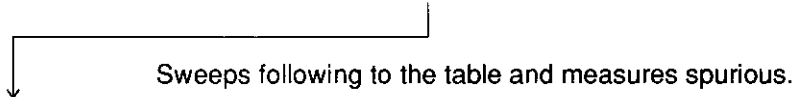

Figure 4-8 Example of the 'Emission due to Transient' Measurement.

4.5 Spurious Measurement

[TRANSIENT] → {Spectrum} → {Spurious}



{Table STD USER}

STD: Uses the specifications of DECT.
USER: Uses the data edited in the Edit Table.

{Table No. 1 2 3}

Specifies a table number to be used.
The following data are input in STD table 1, 2, and 3.
1: TBR006 12.5.2 Radiated emissions
2: TBR006 12.5.2 Radiated emissions
3: TBR006 13.7 Spurious emission when the pp has no allocated transmit channel

{Load Table} Loads the data into the STD table.

{Show Results} Displays the measured results (maximum 10 pcs. of spurious is displayed per 1 measurement).

{Prev Result} Displays the previous sweep result.

{Next Result} Displays the next sweep result.

{return} Returns to the previous menu.

- {Edit Table}* Edits the sequence table.
- {Table No. 1 2 3}* Specifies the table No.
- {Save Table}* Saves the data in the table (USER).
- {Load Table}* Loads the data from the table.
- {Insert Line}* Inserts 1 line.
- {Delete Line}* Deletes 1 line.
- {Clear Table}* Clears the table.
- {return}* Returns to the previous menu.
- {Quit}* Exits from Spurious measurement.

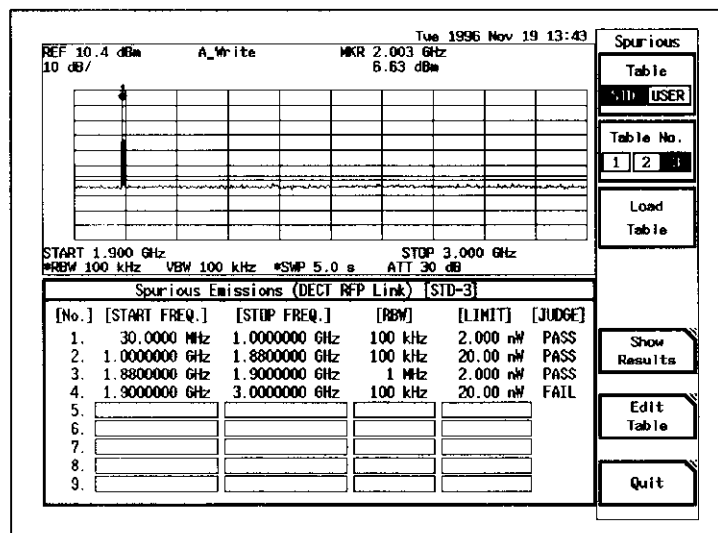

Figure 4-9 Example of Spurious Measurement

4.6 Power Measurement

[TRANSIENT] → *{Output Power}* → *{Tx Power (NTP)}*

Demodulates internally synchronizes with sync word to find burst, and measures the power inside of the burst.

{AutoLevel Set}

Sets the inside reference level (REF LEVEL) to the optimum value according to the measurement signal.

{AVG Times ON OFF}

Sets the average processing number for the power measurement within a range of 2 to 32.

4.7 Power vs Time Measurement

{Limit Setup} ON/OFF setting of the Pass/Fail display and the limit value.

Type:STD/USER	STD: Uses DECT specification data. USER: Uses the value set by user.
Judgement:ON/OFF	Sets ON/OFF of Pass/Fail display.
Upper Limit:	Sets the upper limit value.
Lower Limit:	Sets the lower limit value.

{Quit} Exits from power measurement.

4.7 Power vs Time Measurement

[TRANSIENT] → *{Output Power}* → *{Power vs Time}*



{Auto Level Set}
Sets the internal reference level (REF LEVEL) to the optimum value according to the measurement signal.

{Y Scale [dB/div] 10 5 2}
Sets the display scale of vertical axis to 10dB/div, 5dB/div, and 2dB/div.

{Template Entry}
Sets the template.

{Template Type #1}
Sets to template Type #1.

{Template Type #2}
Sets to template Type #2.

{Template Type #3}
Sets to template Type #3.

{return} Exits from template setup.

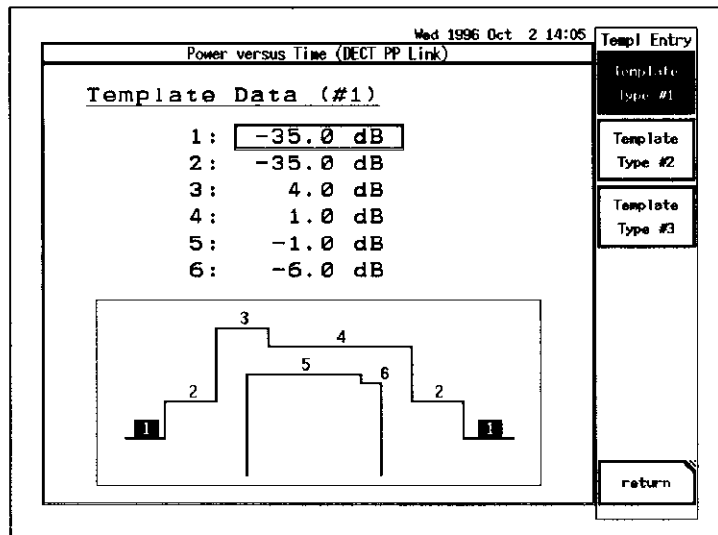

Figure 4-10 Template Setup Screen

Note Default template is shown as Fig. 4-10 because of dynamic range shortage. As it does not satisfy the dynamic range of the specifications, use it with "Burst Env. Spectrum" measurement.

{AVG Times ON OFF}

Sets the average processing number for Power vs Time measurement. The number can be set between 2 and 32.

{Quit}

Exits from Power vs Time measurement.

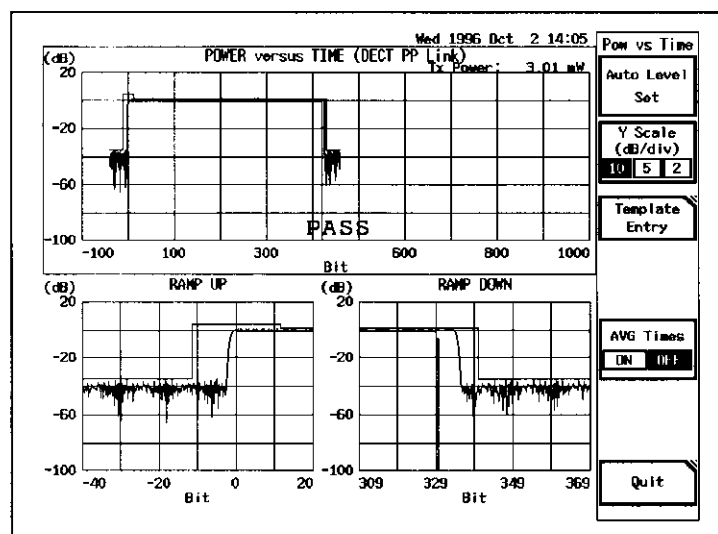

Figure 4-11 Example of Power vs Time Measurement

Data on each bit point can be read out by displaying marker with [ON]. To turn the marker OFF, press the key again.

4.8 FM-Deviation Measurement

4.8 FM-Deviation Measurement

[TRANSIENT] → {FM Deviation}

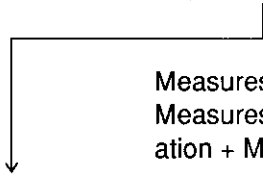

Measures frequency deviation.
Measures Max deviation and Min deviation to obtain Frequency Error = (Max deviation + Min deviation)/2.

{Auto Level Set}

Sets the internal reference level (REF LEVEL) to the optimum value according to the measurement signal.

{Graphics}

{Start Bit}

Sets the start bit of graph display.
From Start Bit to 100Bit is displayed in Bit-Frequency.
300Bit is displayed in Demodulated Data.

{Select Type}

Selects graph display. Selects from the following 3 types.
1. Bit Frequency
2. EYE Diagram
3. Demodulated Data

{AVG Times ON OFF}

Sets the average processing number. The number can be set between 2 and 32.
Max deviation and Min deviation are the maximum value and the minimum value in the set number of times.

{Quit}

Exits from FM-Deviation measurement.

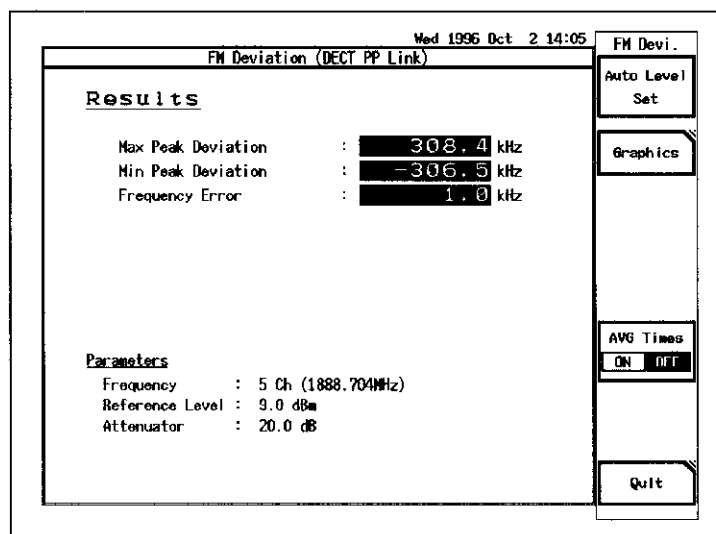

Figure 4-12 Example of FM-Deviation Measurement

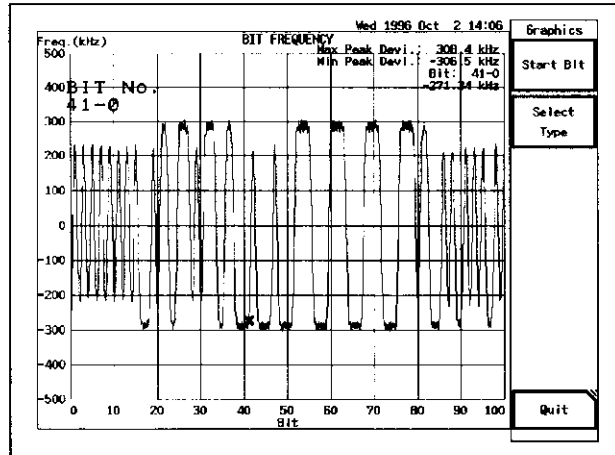

Figure 4-13 Example of Bit-Frequency Measurement

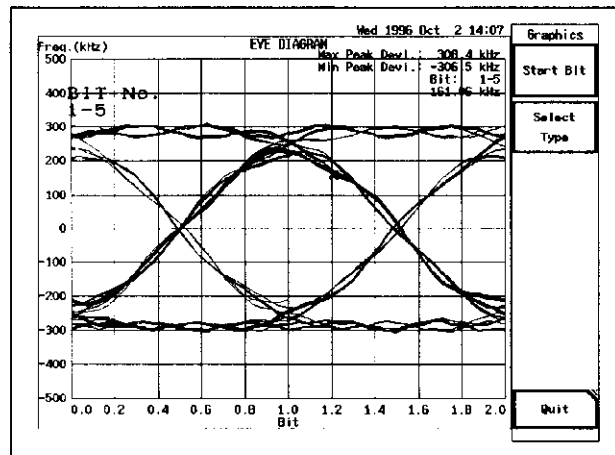

Figure 4-14 Example of EYE-Diagram Measurement

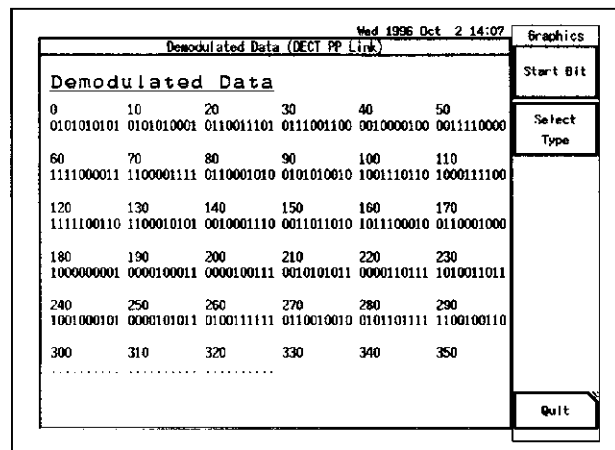

Figure 4-15 Example of Demodulated Data Measurement

4.9 Timing Jitter Measurement

4.9 Timing Jitter Measurement

[TRANSIENT] → {Timing Jitter}



{AutoLevel Set}

Sets the inside reference level (REF LEVEL) to the optimum value according to the measurement signal.

{REP → PP ON OFF}

ON: Sets PP burst timing based on RFP.

OFF: Measures the burst timing of the signal which is selected in Setup STD.

{AVG Times ON OFF}

Sets the number of averaging. The number can be set between 2 and 32.

Max Peak Jitter and Min Peak Jitter are the maximum value and the minimum value in the AVG times measurements.

{Limit Setup}

Makes a Pass/Fail display setting.

Type: Sets the limit value to the value decided by the specifications or to an optional value.

Judgment: Enable/disables PASS/Fail judgment.

Upper Limit: Sets the limit value.

{Quit}

Exits from Timing Jitter measurement.

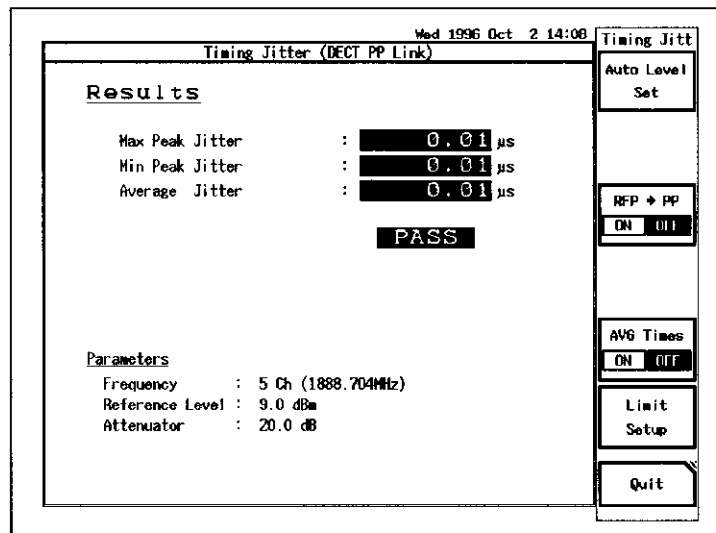

Figure 4-16 Example of Timing Jitter Measurement

Note: In order to perform Timing Jitter measurement correctly, set SYNC Type to "SYNC WORD" in "Setup STD" menu.

4.10 Using the communication system setting menu

Pressing [TRANSIENT] → {Setup STD} in order or pressing [STD] displays the communication system setting menu. Signal link to be measured or measuring method is set.

Note: R3263 does not have STD key.

Wed 1996 Oct 2 14:11 Setup STD

Measurement parameter set

Type : DECT

Meas Mode : BURST CONTINUOUS

Link : RFP(Radio Fixed Part) PP(Portable Part)

Sync Type : SYNC WORD NO SYNC WORD

Sync Word : 0101010101010101 0001011001110101

Physical Packet : P00 P32 P0B P80

Z-Field : ON OFF

Offset Level : 0.0 dB

Freq Input : FREQUENCY CHANNEL NO.

Channel Offset : 0

Data Capture Trigger : AUDIO SOFTWARE EXT

EXT Trigger Slope : + -

Cont. Auto Level Set : ON OFF

return

Figure 4-17 Communication System Setting Menu

Type	: DECT
Meas Mode	: Sets the signal to be measured to burst or to continuous signal. In DECT, generally the signal is burst, but continuous signal such as test signal can be measured too.
Link	: Sets the direction of communication channel. RFP (Radio Fixed Part) ; Measures the base station signal. PP (Portable Part) ; Measures the mobile unit signal.
SYNC Type	: Makes the setting to synchronize by sync word or not, at FM-Deviation, Tx Power (NTP), Power vs Time, and Timing Jitter measurements. SYNC WORD ; Synchronizes by sync word. NO SYNC WORD ; Synchronizes without using sync word.
SYNC Word	: Sync word RFP or PP is displayed.
Physical Packet	: Select communication packet.
Z-Field	: Sets ON/OFF of Z-Field.
Offset Level	: Offset value of reference level can be set within ± 100 dB. For the setting of this value, ten keys and data knob can be used.
Freq. Input	: FREQUENCY/CHANNEL NO. Makes the setting to input the center frequency of measurement equipment by frequency or by channel number.
Channel Offset	: Only when CHANNEL NO. is selected, Channel Offset is effective and "Channel Offset + Input channel number" becomes the channel number to be set.

4.11 Display Unit Selection of Spectrum Measurement

The following settings are effective at FM-Deviation, Tx Power (NTP), Power vs Time, and Timing Jitter measurements.

- Data Capture Trigger : Selects the trigger to capture signal.
- AUTO ; When Signal Type is BURST, captures data by triggering.
When Signal Type is CONTINUOUS, captures data by internal timing.
 - SOFTWARE ; Captures data by the internal timing of measurement equipment.
When signal Type is BURST, detects BURST with software.
 - EXT ; Captures data by external trigger signal.
- Ext Trigger Slope : When EXT is selected at "Data Capture Trigger", selects EXT trigger slope.
- + ; Captures data at external trigger signal rising.
 - ; Captures data at external trigger signal falling.
- Cont. Auto Level Set : Makes the setting to measure or not while setting the reference level automatically.
- ON ; Measures while setting the reference level automatically.
 - OFF ; Reference level is not set.

4.11 Display Unit Selection of Spectrum Measurement

Either [W] or [dBm] can be selected as a display unit when showing the measurement (Emission due to Modulation/due to Transient, Spurious).

[TRANSIENT] → {Spectrum} → {Disp unit [W] [dBm]}

Select either [W] or [dBm] as a level unit to show the results in.

- [W] : W display
- [dBm] : dBm display

Note : *This selection applies to the measurement result display and the level output value measured through GPIB, and does not apply to the unit used for the input data, such as limit value.*

5 NOTES FOR THE RECALL FUNCTION

- (1) Turning the power on after the system is switched by Comm.System, factory-shipped initial setting screen appears.
- (2) Files or registers in the different communication systems (PDC/PHS/NADC/GSM ←→ DECT) cannot be recalled. ("Communication system unmatched." is displayed on the screen.)

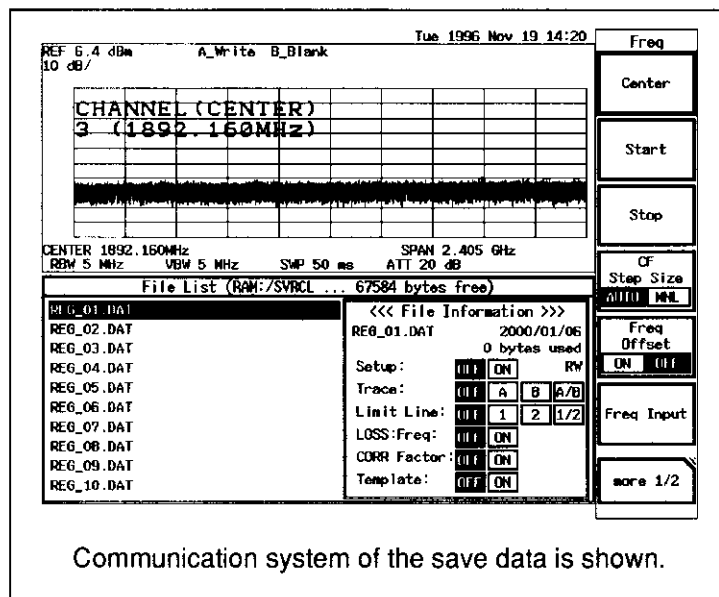

Figure 5-1 Recall screen

6 GPIB CODE LIST

Function	Listener Code	Talker Request Code	Talker Request Output Format
Standard Operation Mode CW TRANSIENT	SETFUNC CW SETFUNC TRAN	SETFUNC?	0: CW 1: TRANSIENT
Communication System DECT	MODTYP DECT	MODTYP?	0: PDC 1: PHS 2: NADC 3: GSM 4: DCS1800 5: DCS1900 6: CDMA (800MHz band) 7: CDMA (1.8GHz band) 8: CDMA (1.9GHz band) 9: DECT
Signal Type Burst Wave Continuous Wave	MEASMD BURST MEASMD CONT	MEASMD?	0: BURST 1: CONTINUOUS
Link RFP PP (Effective at "MEASMD BURST")	LINK RFP LINK PP	LINK?	0: RFP 1: PP
SYNK Type SYNC WORD NO SYNC WORD (Effective at "MEASMD BURST")	SYNC SYNC SYNC NO	SYNC?	0: SYNC WORD 1: NO SYNC WORD
Physical Packet P00 P32 P08j P80 (Effective at "MEASMD BURST")	PHYPKT P00 PHYPKT P32 PHYPKT P08 PHYPKT P80	PHYPKT?	0: P00 1: P32 2: P08j 3: P80
Z-Field OFF ON (Effective at "MEASMD BURST" and not "PHYPKT P00")	ZFILD OFF ZFILD ON	ZFILD?	0: OFF 1: ON
Data Capture Trigger AUTO SOFTWARE EXT	DCAPTRG AUTO DCAPTRG SOFT DCAPTRG EXT	DCAPTRG?	0: AUTO 1: SOFTWARE 2: EXTERNAL
Ext. Trigger Slope - + (Effective at "DCAPTRG EXT")	DTRGSLP FALL DTRGSLP RISE	DTRGSLP?	0: - 1: +
CH setting CF setting Offset Frequency offset	CH* CHOFs* CHFO*	CH? CHOFs? CHFO?	Integer (Channel Number) Integer (Offset, Channel) Frequency

DECT Measurement Option OPERATION MANUAL

6 GPIB CODE LIST

Function	Listener Code	Talker Request Code	Talker Request Output Format
Auto-level Execution (except Burst Env, Power) Auto Level ON Auto Level OFF	AUTOLVL AUTOWFL ALS ON ALS OFF		
Level Offset	RO*	RO?	Level
Measurement conditions Source FREE VIDEO IF EXT Slope + - Level (Effective at "TRGSRC VIDEO/ IF") Position Source Monitor ON OFF Full Slot Number (Effective at "TRGSRC EXT") Half Slot Number (Effective at "TRGSRC EXT") Delay Time	TRGSRC FREE TRGSRC VIDEO TRGSRC IF TRGSRC EXT TRGSLP RISE TRGSLP FALL TRGLVL* TRGPOS* TRGMON ON TRGMON OFF FULSLT* HAFSLT* TRGDT*	TRGMON? FULSLT? HAFSLT? TRGDT?	Integer (0 to 100)% Integer (0 to 100) 0: OFF 1: ON Integer (0 to 23) Integer (0 to 1) Time
Gated Spectrum Gate Position Width Default Source If Signal EXT Trigger Slope + - Threshold Save Parameters Gate Sweep ON OFF	TGTPOS* TGTWID* TGTDEF TGTSRC IF TGTSRC EXT TGTSRP RISE TGTSRP FALL TGTTHD* TGTSV TGTSWP ON TGTSWP OFF	TGTPOS? TGTWID? TGTSRC? TGTTHD? TGTSWP?	Time Time 0: IF Signal 1: EXT Trigger Integer (0: OFF to 100) 0: OFF 1: ON

Function	Listener Code	Talker Request Code	Talker Request Output Format
Display Control Window Position Width T-Zoom ON Reset Zoom on Window Return to Last Span Span to 1 Burst Span to 1 Frame Vertical Zoom ON OFF Y Scale (dB/div) 10dB/ 5dB/ 2dB/	DCPOS* DCWID* DCZOM DCRST DCHZOM ON DCHZOM OFF DCHZOM BURST DCHZOM FRAME DCVZOM ON DCVZOM OFF DCVDIV P10DB DCVDIV P5DB DCVDIV P2DB	DCPOS? DCWID? DCVDIV?	Time Time 0: 10dB/div 1: 5dB/div 2: 2dB/div
Power Window ON OFF Default Position Width Y Scale (dB/div) 10dB/ 5dB/ 2dB/	TWDO ON TWDO OFF TWDEF TWLX* TWDX* DCPDIV P10DB DCPDIV P5DB DCPVID P2DB	TWDO? TWLX? TWDX? DCPDIV?	0: OFF 1: ON Time Time 0: 10dB/div 1: 5dB/div 2: 2dB/div
Display unit selection for spectrum measurement	DSPUNT W DSPUNT DBM	DSPUNT ?	0: W 1: dBm
Due to Modulation Parameter Setup STD User Manual Limit Setup Type STD USER Judgement OFF ON M \pm 1 M \pm 2	DMDPRM STD DMDPRM USER DMDPRM MNAL DMDTYP STD DMDTYP USER DMDJDG OFF DMDJDG ON DMDM1* (Effective only at "DMDTYP USER") DMDM2* (Effective only at "DMDTYP USER")	DMDPRM? DMDTYP? DMDJDG? DMDM1? DMDM2?	0: STD 1: User 2: Manual 0: STD 1: USER 0: OFF 1: ON Watt Watt
Due to Transient Parameter setup STD User Manual	DTRPRM STD DTRPRM USER DTRPRM MNAL	DTRPRM?	0: STD 1: User 2: Manual

6 GPIB CODE LIST

Function	Listener Code	Talker Request Code	Talker Request Output Format
Spurious Table STD USER Table Number 1/2/3 Save Table Load Table Clear Table Edit Table	DSPTYP STD DSPTYP USER DSPTBL *(1 to 3) DSPSV DSPLD DSPCLR DSPEDIT*, *, *, *, *	DSPTYP? DSPTBL?	0: STD 1: USER 1: Table 1 2: Table 2 3: Table 3 n, f1, f2, f3, 11 n: "ENT" should be added after the entry number (1 to 15) n. f1: Start-Frequency f2: Start-Frequency f3: RBW 11: Limit Data (W)
Tx Power Limit Setup Type STD USER Judgement OFF ON Upper Limit Lower Limit	DTXTYP STD DTXTYP USER DTXJDG OFF DTXJDG ON DTXUP* (Effective only at "DTXTYP USER") DTXLW* (Effective only at "DTXTYP USER")	DTXTYP? DTXJDG? DTXUP? DTXLW?	0: STD 1: USER 0: OFF 1: ON Watt Watt
Power vs Time Y Scale 10dB/ 5dB/ 2dB/ Template Type 1/2/3 Template Entry	DPTDIV P10DB DPTDIV P5DB DPTDIV P2DB DPTTYP* (1 to 3) DPTENT*, *, *, *, *	DPTDIV? DPTTYP?	0: 10dB/DIV 1: 5dB/DIV 2: 2dB/DIV 1: Template #1 2: Template #2 3: Template #3 d1, d2, d3, d4, d5, d6 d1 to d6: Relative level (dB)
FM Deviation Start Bit Graph Type selection Bit Frequency Eye Diagram Demodulated Data	DSTTBIT* DFMGTYP BIT DFMGTYP EYE DFMGTYP DEMOD	DSTTBIT? DFMGTYP?	Integer (0 to 810 bit) 0: Bit Frequency 1: Eye Diagram 2: Demodulated Data

Function	Listener Code	Talker Request Code	Talker Request Output Format
Timing Jitter RFP → PP OFF ON Limit Setup Type STD USER Judgement OFF ON Upper Limit DTJLMT* (Effective only at "DTJTYP USER")	DTJLNK OFF DTJLNK ON DTJTYP STD DTJTYP USER DTJJDG OFF DTJJDG ON DTJLMT* (Effective only at "DTJTYP USER")	DTJLNK? DTJTYP? DTJJDG? DTJLMT?	0: OFF 1: ON 0: STD 1: USER 1: OFF 1: ON Time
Average Burst Env. Spectrum Power Due to Modulation Due to Transient Tx Power Power vs Time FM Deviation Timing Jitter	TAVGBST* TPWTM* DMDAVG* DTRAVG* DTXAVG* DPTAVG* DFMAVG* DTJAVG*	TAVGBST? TPWTM? DMDAVG? DTRAVG? DTXAVG? DPTAVG? DFMAVG? DTJAVG?	Integer (1: OFF to 32) Integer (1: OFF to 999) Integer (1: OFF to 999) Integer (1: OFF to 999) Integer (1: OFF to 32) Integer (1: OFF to 32) Integer (1: OFF to 32) Integer (1: OFF to 32)
Limit line Type selection *1 Burst Env. Spectrum Power Due to Transient Spurious STD USER Shift X Shift Y Limit Line ON *2 OFF Table data *3 Table input Table delete	TLMTYP TM1 TLMTYP TM2 TLMTYP FR1 TLMTYP FR2 LMCPSL STD LMCPSL USR TLMSFT* TLMASFT* TLMT ON TLMT OFF TLMIN*, * TLMDEL	TLMSFT? TLMASFT? TLMT?	Frequency or Time Level 0: OFF 1: ON Frequency/Time, Level

*1 It is necessary to select type before setting STD/USER, Shift X/Y, etc.

*2 As the set ON/OFF condition may be changed according to each measurement execution, execute "SI" command (same measurement execution) after setting ON/OFF after entering in measurement mode.

*3 The type selection to input or delete table data is limit-line-specified to UPPER for TM1 and LOWER for TM2.

6 GPIB CODE LIST

Function	Listener Code	Talker Request Code	Talker Request Output Format
PASS/FAIL Judgment ON OFF Test conclusion Test conclusion (details) Fail point reading UPPER side LOWER side	PFC ON PFC OFF	PFC? PFJ? OPF? FPU? FPL?	0: OFF 1: ON 0: FAIL 1: PASS 0: PASS 1: UPPER FAIL 2: LOWER FAIL 3: UPPER & LOWER FAIL 4: ERROR Fail number <CR + LF> + Frequency/Time Level <CR + LF> (Repeats Fail for several minutes.) * For 256 points maximum Same as UPPER side.
Measurement start Burst Env. Spectrum Power Due to Modulation Due to transient Spurious Tx Power Power vs Time FM Deviation (Graph) Timing Jitter Measurement execution of the same item	PWRTIME TPWAVG DUTMOD DUTTRA DSPURI DTXPOW DPWRM DFMDEV DEMGPH DTJIT SI		Numeric result Numeric result
Measurement result reading Burst Env. Spectrum Power		TPWAVG?	Judge by PASS/FAIL d1: Level (dBm)

Function	Listener Code	Talker Request Code	Talker Request Output Format
Due to Modulation (NTP value reading)		DUTMOD? DTXPOW?	d1, j1, ... d4, j4 d1: (M-2) level [W] or [dBm] j1: (M-2) integer (0: FAIL, 1: PASS) d2: (M-1) level [W] or [dBm] j2: (M-1) integer (0: FAIL, 1: PASS) d3: (M+1) level [W] or [dBm] j3: (M+1) integer (0: FAIL, 1: PASS) d4: (M+2) level [W] or [dBm] j4: (M+2) integer (0: FAIL, 1: PASS) double d1, d2 d1: level (W) d2: level (dBm)
Due to Transient		DUTTRA?	f1, l1, ...f7, l7 f1: (M-3) frequency[Hz] l1: (M-3) level [W] or [dBm] f2: (M-2) frequency[Hz] l2: (M-2) level [W] or [dBm] f3: (M-1) frequency[Hz] l3: (M-1) level [W] or [dBm] f4: (M+1) frequency[Hz] l4: (M+1) level [W] or [dBm] f5: (M+2) frequency[Hz] l5: (M+2) level [W] or [dBm] f6: (M+3) frequency[Hz] l6: (M+3) level [W] or [dBm] f7: Other frequency[Hz] l7: Other level [W] or [dBm]

6 GPIB CODE LIST

Function	Listener Code	Talker Request Code	Talker Request Output Format
Spurious		DSPURI?	n1 <CR + LF> n2 <CR + LF> f1, l1, j1 <CR + LF> ..., fn, ln, jn <CR + LF> n2 <CR + LF> f1, l1, j1 <CR + LF> ..., fn, ln, jn <CR + LF> n2 <CR + LF> f1, l1, j1 <CR + LF> ..., fn, ln, jn <CR + LF> n1: Measurement table number (0 to 15) (Repeats for n1 times.) n2: Spurious number (0 to 10) (Repeats for n2 times.) fn: Spurious frequency (Hz) ln: Spurious level (W) or [dBm] jn: Test conclusion (0: FAIL, 1: PAS)
Tx Power		DTXPOW?	double d1, d2 d1: Level (W) d2: Level (dBm)
Power vs Time		DPWRTM?	float d1 d1: Leven (W)
		DPTJDG?	Test conclusion (Integer) (0: FAIL, 1: PASS)
		DPTFAIL?	FAIL value (Integer)
FM Deviation		DFMDEV?	float d1, d2, d3 d1: Max Peak Devi. (Hz) d2: Min Peak Devi. (Hz) d3: Frequency Error (Hz)
Timing Jitter		DTJIT?	float d1, d2, d3 d1: Max Peak Jitter (sec) d2: Min Peak Jitter (sec) d3: Average Jitter (sec)

Function	Listener Code	Talker Request Code	Talker Request Output Format
Graph results reading Power vx Time X data (Bit number) Y data (level)		GPHX? GPHY?	n, d1, ... dn n : Number (Integer) d1 to dn : Integer n, d1, ... dn n : Number (Integer) d1 to dn : Level (dB)
Bit Frequency X data (Bit number) Y data (Frequency)		GPHX? GPHY?	n, d1, ... dn n : Number (Integer) d1 to dn : Integer n, d1, ... dn n : Number (Integer) d1 to dn : Frequency (Hz)
Annotation part Eye Diagram X data (Bit number) Y data (Frequency)		DFMBIT? GPHX? GPHY?	float d1, d2 d1: Max Peak Devi. (Hz) d2: Min Peak Devi. (Hz) n, d1, ... dn n : number (Integer) d1 to dn : Integer n, d1, ... dn n : number (Integer) d1 to dn : Frequency (Hz)
Demodulated Data		DEMODO?	n-str, d1 \$, ... dn \$ n-str : number (Integer) d1 \$ to dn \$: String (1 data : 10bit)
Graph marker Marker ON OFF	GMK ON GMK OFF	GMK?	0: OFF 1: ON
Power vs Time Marker movement (Bit number) Marker Y data	GMKX*	GMKX? GMKY?	Bit number Level (dB)
Bit Frequency Marker movement (Bit number) Marker Y data	GMKX*	GMKX? GMKY?	Bit number Frequency (Hz)
Eye Diagram Marker movement (Bit number) Marker Y data	GMKX*	GMKX? GMKY?	Bit number Frequency (Hz)

7 SPECIFICATIONS OF DECT MEASUREMENT OPTION

- For modulation system GFSK
- Analysis input range Spectrum analysis
 9kHz to 8GHz (R3465), 9kHz to 3GHz (R3263)
 Modulation analysis
 10MHz to 7GHz (R3465), 10MHz to 3GHz (R3263)
 -30dBm to +30dBm
- Emission due to Modulation (by gated-sweep)
- Emission due to Transient
- Spurious (Measurement by sequence table)
- Average power measurement (Computation by DSP)
 (After calibration)
 Measurement accuracy $\pm 0.8\text{dB}$ (15°C to 35°C)
 $\pm 1.0\text{dB}$ (0°C to 50°C)
- Power vs Time measurement
 In synchronization with sync word after demodulation, template is displayed.
- Frequency deviation
 Maximum deviation, Minimum deviation
 Measurement accuracy $\pm (10\text{kHz} + \text{Carrier frequency} \times \text{Frequency standard accuracy})$
 Frequency error is displayed with the average of maximum deviation and minimum deviation.
 Frequency-bit graph, Eye diagram, and demodulation data can be displayed.
- Jitter measurement
 Jitter measurement between bursts (PP \rightarrow PP, RFP \rightarrow RFP, RFP \rightarrow PP)
 Measurement accuracy $\pm 0.1\mu\text{s}$

APPENDIX

A.1 Menu List of TRANSIENT Keys

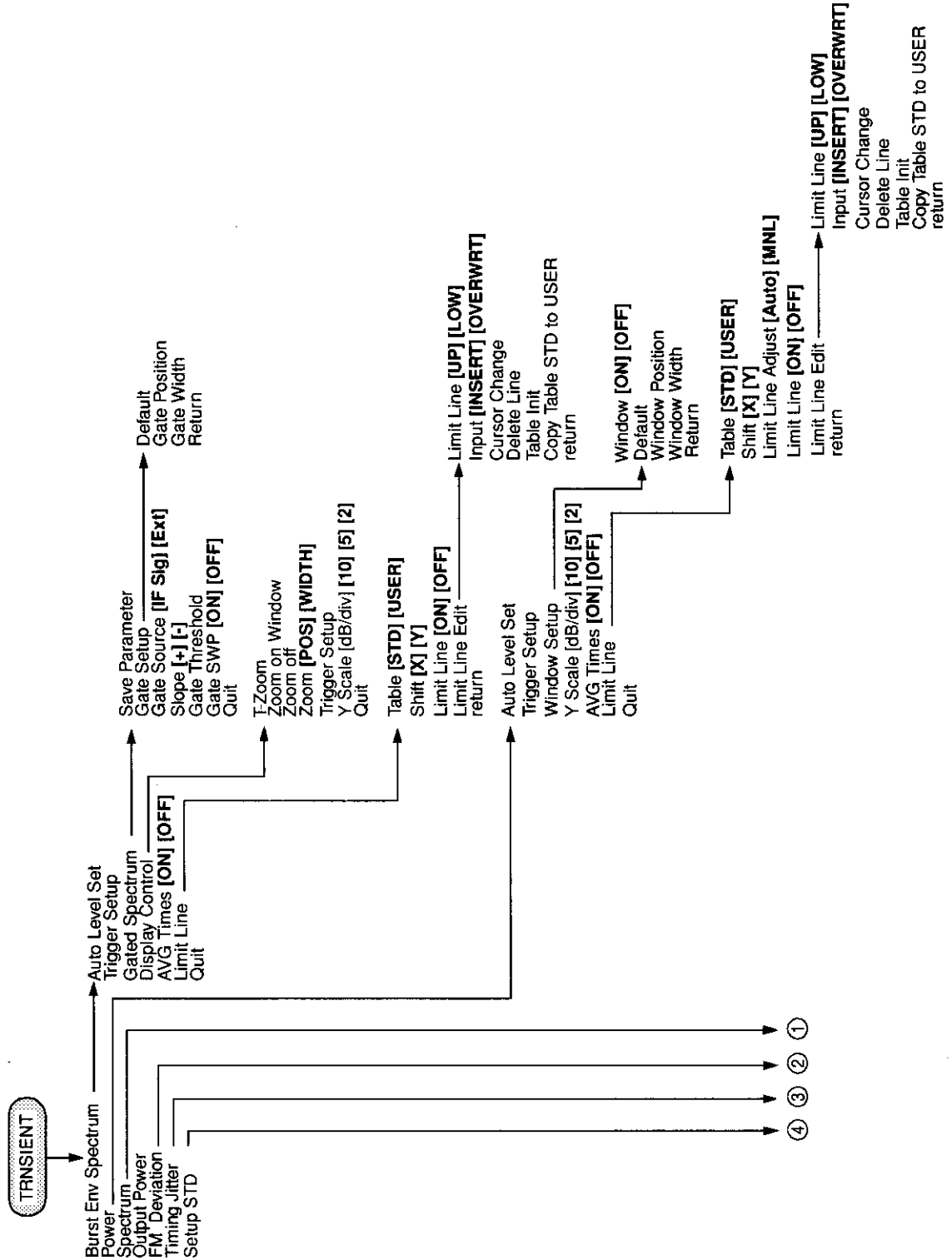

A.1 Menu List of TRANSIENT Keys

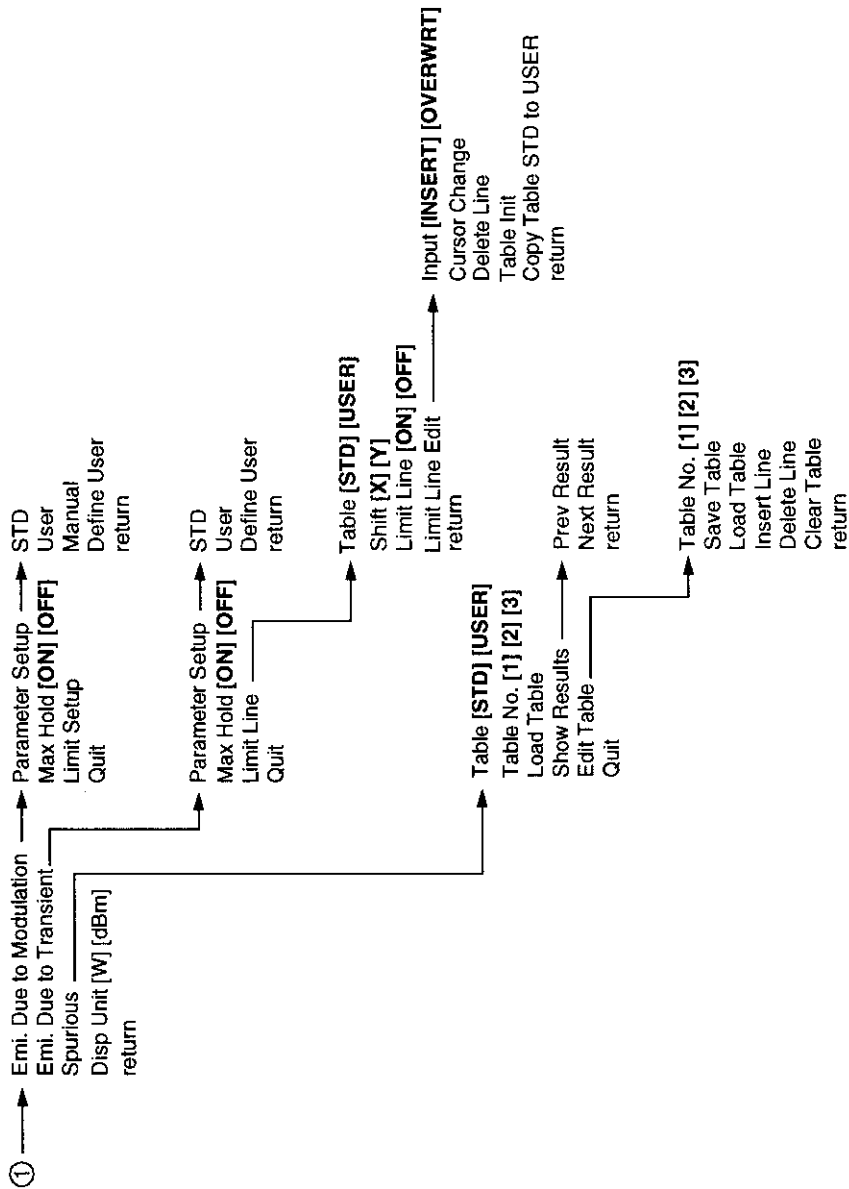

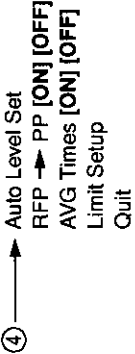
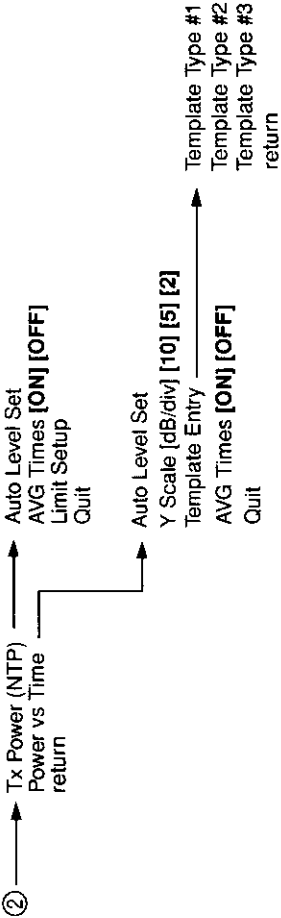

A.2 List of Messages

A.2 List of Messages

Message	Explanation	Error No.
Sound demodulation is working. Please turn off the Sound mode. [CW 1/2]	Sound demodulation is working.	1
Span is set 0Hz. Please change a span.	It is set in Zero span.	5
Power Measure is working. Please turn off each item. [CW - > Power Meas]	Power Measure is working.	9
Signal Track is working. Please turn off Signal Track. [Maker 1/3]	Signal Track is working.	10
Noise/Hz is working. Please quit the Noise/Hz. [CW 2/2]	Noise/Hz is working.	11
Only dBm and dB μ V is useful while Noise/Hz is been working.	It is not possible to select because Noise/ Hz is been working.	12
Counter is working. Please turn off the Counter. [CW 1/2]	Counter is working.	13
Δ MKR is not active. Please activate the Δ MKR. [Maker 1/3]	The delta marker is not active.	14
Not available in Multi Screen. Please reset Multi Screen mode. [Window 1/1]	It is not possible to execute in Multi Screen mode.	17
View or Blank trace is selected. Please select Write mode. [Format - > Trace A]	It is not possible to execute in View/Blank.	18
Trigger source is not Video. Please select Video trigger. [Sweep - > Trigger Source]	Trigger source is not Video.	19

Message	Explanation	Error No.
MKR is not on Trace A. Please execute Trace MKR Move. [Maker 3/3]	The marker is not on Trace A.	20
Calculated power is out of range.	The calculated power is out of range.	25
Edit table is opened. Please return to execute menu.	It is not possible to execute in the Edit mode.	26
Frequency table is empty. Please edit a table and execute.	There are no table data.	27
Calibration signal was not detected. Please check CAL OUT signal.	There is no CAL signal connected.	28
Trace Average is working. Please turn Average off. [Format - > Trace A]	Trace average is working.	39
Trace Point is set to 501. Please change mode to 1001. [SYS 1/1]	Trace 501 Point mode is set.	41
Not available while Zooming.	It is not possible to execute while Zooming.	42
No trace data. Please start a measure.	Trace data is not displayed. Start the measurement.	43
Attenuator is MANUAL mode. Please select AUTO mode.	Attenuator is set to the Manual mode. Change the mode to Auto, then execute the measurement.	44
Now, Sweeping. Please stop the sweep.	The function cannot be carried out during sweep. Carried out the sweep after stop.	52
Center freq. is out of band. Please change center frequency into band.	Carrier frequency is out of the band in the DECT standard. Set up into the band again.	55
Printer is not ready. Please check a printer setting.	It is not possible to print. Please check the printer setting.	300*
Printer cable problem. Please check a cable or connection.	The printer cable is defective. Please check the cable or connection.	301*
Printer is not active.	The printer is not active.	302*

A.2 List of Messages

Message	Explanation	Error No.
Plotter cable problem or plotter is not active.	The plotter cable is defective or the plotter does not operate.	303*
INPUT ATT: Calibration failure.	It is a failure of the Calibration.	400
IF STEP AMP: Calibration failure.	It is a failure of the Calibration.	401
LOG LINEARITY: Calibration failure.	It is a failure of the Calibration.	402
TOTAL GAIN: Calibration failure.	It is a failure of the Calibration.	403
RBW SWITCHING: Calibration failure.	It is a failure of the Calibration.	404
AMPTD MAG: Calibration failure.	It is a failure of the Calibration.	405
Calibration data is not enough. Please execute CAL ALL.	It is not possible to execute because source calibration data is missing	406
HS ADC: Calibration failure.	It is a failure of the Calibration.	407
MOD DSP: Calibration failure.	It is a failure of the Calibration.	408
NORMAL ADC: Calibration failure.	It is a failure of the Calibration.	409
Illegal parameters.	The specified parameters are illegal.	600
Illegal file or device name.	The file or device name is illegal.	601
Software version unmatched.	Software version is unmatched.	602
Cannot format a device.	The memory card cannot be initialized.	603
Cannot rename a file in RAM disk.	The file name in RAM disk cannot be changed.	604
Broken saved block data.	The saved data is lost.	605
Device already exists.	The device already has been selected.	606
Device not found.	There are no devices.	607
Device not ready.	The device cannot be referred.	608

Message	Explanation	Error No.
Directory not found.	There are no directions.	609
File already exists.	The file already exists.	610
File not found.	There are no files.	611
Invalid BPB. Please format a card.	BPB is invalid. The card needs to be initialized.	612
Cannot delete a file. (Read-only file)	It is not possible to delete because it is a read-only file.	613
No disk space.	Card/Disk capacity is full.	614
Read-only file.	It is the read-only file.	615
Read-only media.	It is the read-only media.	616
Read-only volume.	The card is in the write protection.	617
Invalid boot sector signature.	The boot sector signature cannot be recognized.	618
CRC error.	CRC error occurred.	619
Any trouble in DSP or AD module.	DSP or AD module has some trouble.	620
Broken Freq-Correction data. Please report to qualified service person.	An error of the frequency characteristic correction data occurred.	621*
Handshake error occurred to TBC. Please report to qualified service person.	A handshake error occurred.	622*
Handshake error occurred to DSP. Please report to qualified service person.	A handshake error occurred.	623*
Cannot detect Mod. DSP board. Please report to qualified service person.	Connection error has occurred.	624*
File or register empty.	It is impossible to recall a file or a register that is empty	634
Communication system unmatched.	The communication system is improper.	635
Time Out ! No Trigger detected.	Trigger is not detected.	700

A.2 List of Messages

Message	Explanation	Error No.
System Error. Cannot allocate memory.	Cannot allocate memory space.	701
Input level is out of range. Please check Reference level.	Input level is out of allowable range.	702
Burst signal is not detected. Please check Burst length.	Burst signal cannot be detected.	703
Cannot demodulate.	Cannot demodulate.	704
Sync word detection failure.	Sync word cannot be detected.	706
Trigger timing is not proper.	Trigger timing is not proper.	707
Signal Type is set to CONTINUOUS. Please set BURST in STD menu.	Continuous wave was detected.	709
No graph data. Please execute measure.	The graphic data is not existed, therefore, carried out the measurement.	712
System error ! System clock does not work.	System error is occurred. System clock is stopped.	714
Auto Level completed!	Auto level completed.	801
Auto Level failed !	Auto level failed.	802

Note: *It is possible to read error numbers by using the GPIB query, "ERRNO?", but impossible to read codes marked by (*).*

IMPORTANT INFORMATION FOR ADVANTEST SOFTWARE

PLEASE READ CAREFULLY: This is an important notice for the software defined herein. Computer programs including any additions, modifications and updates thereof, operation manuals, and related materials provided by Advantest (hereafter referred to as "SOFTWARE"), included in or used with hardware produced by Advantest (hereafter referred to as "PRODUCTS").

SOFTWARE License

All rights in and to the SOFTWARE (including, but not limited to, copyright) shall be and remain vested in Advantest. Advantest hereby grants you a license to use the SOFTWARE only on or with Advantest PRODUCTS.

Restrictions

- (1) You may not use the SOFTWARE for any purpose other than for the use of the PRODUCTS.
- (2) You may not copy, modify, or change, all or any part of, the SOFTWARE without permission from Advantest.
- (3) You may not reverse engineer, de-compile, or disassemble, all or any part of, the SOFTWARE.

Liability

Advantest shall have no liability (1) for any PRODUCT failures, which may arise out of any misuse (misuse is deemed to be use of the SOFTWARE for purposes other than its intended use) of the SOFTWARE. (2) For any dispute between you and any third party for any reason whatsoever including, but not limited to, infringement of intellectual property rights.

LIMITED WARRANTY

1. Unless otherwise specifically agreed by Seller and Purchaser in writing, Advantest will warrant to the Purchaser that during the Warranty Period this Product (other than consumables included in the Product) will be free from defects in material and workmanship and shall conform to the specifications set forth in this Operation Manual.
2. The warranty period for the Product (the "Warranty Period") will be a period of one year commencing on the delivery date of the Product.
3. If the Product is found to be defective during the Warranty Period, Advantest will, at its option and in its sole and absolute discretion, either (a) repair the defective Product or part or component thereof or (b) replace the defective Product or part or component thereof, in either case at Advantest's sole cost and expense.
4. This limited warranty will not apply to defects or damage to the Product or any part or component thereof resulting from any of the following:
 - (a) any modifications, maintenance or repairs other than modifications, maintenance or repairs (i) performed by Advantest or (ii) specifically recommended or authorized by Advantest and performed in accordance with Advantest's instructions;
 - (b) any improper or inadequate handling, carriage or storage of the Product by the Purchaser or any third party (other than Advantest or its agents);
 - (c) use of the Product under operating conditions or environments different than those specified in the Operation Manual or recommended by Advantest, including, without limitation, (i) instances where the Product has been subjected to physical stress or electrical voltage exceeding the permissible range and (ii) instances where the corrosion of electrical circuits or other deterioration was accelerated by exposure to corrosive gases or dusty environments;
 - (d) use of the Product in connection with software, interfaces, products or parts other than software, interfaces, products or parts supplied or recommended by Advantest;
 - (e) incorporation in the Product of any parts or components (i) provided by Purchaser or (ii) provided by a third party at the request or direction of Purchaser or due to specifications or designs supplied by Purchaser (including, without limitation, any degradation in performance of such parts or components);
 - (f) Advantest's incorporation or use of any specifications or designs supplied by Purchaser;
 - (g) the occurrence of an event of force majeure, including, without limitation, fire, explosion, geological change, storm, flood, earthquake, tidal wave, lightning or act of war; or
 - (h) any negligent act or omission of the Purchaser or any third party other than Advantest.
5. **EXCEPT TO THE EXTENT EXPRESSLY PROVIDED HEREIN, ADVANTEST HEREBY EXPRESSLY DISCLAIMS, AND THE PURCHASER HEREBY WAIVES, ALL WARRANTIES, WHETHER EXPRESS OR IMPLIED, STATUTORY OR OTHERWISE, INCLUDING, WITHOUT LIMITATION, (A) ANY WARRANTY OF MERCHANTABILITY OR FITNESS FOR A PARTICULAR PURPOSE AND (B) ANY WARRANTY OR REPRESENTATION AS TO THE VALIDITY, SCOPE, EFFECTIVENESS OR USEFULNESS OF ANY TECHNOLOGY OR ANY INVENTION.**
6. **THE REMEDY SET FORTH HEREIN SHALL BE THE SOLE AND EXCLUSIVE REMEDY OF THE PURCHASER FOR BREACH OF WARRANTY WITH RESPECT TO THE PRODUCT.**
7. **ADVANTEST WILL NOT HAVE ANY LIABILITY TO THE PURCHASER FOR ANY INDIRECT, INCIDENTAL, SPECIAL, CONSEQUENTIAL OR PUNITIVE DAMAGES, INCLUDING, WITHOUT LIMITATION, LOSS OF ANTICIPATED PROFITS OR REVENUES, IN ANY AND ALL CIRCUMSTANCES, EVEN IF ADVANTEST HAS BEEN ADVISED OF THE POSSIBILITY OF SUCH DAMAGES AND WHETHER ARISING OUT OF BREACH OF CONTRACT, WARRANTY, TORT (INCLUDING, WITHOUT LIMITATION, NEGLIGENCE), STRICT LIABILITY, INDEMNITY, CONTRIBUTION OR OTHERWISE. TORT (INCLUDING, WITHOUT LIMITATION, NEGLIGENCE), STRICT LIABILITY, INDEMNITY, CONTRIBUTION OR OTHERWISE.**
8. **OTHER THAN THE REMEDY FOR THE BREACH OF WARRANTY SET FORTH HEREIN, ADVANTEST SHALL NOT BE LIABLE FOR, AND HEREBY DISCLAIMS TO THE FULLEST EXTENT PERMITTED BY LAW ANY LIABILITY FOR, DAMAGES FOR PRODUCT FAILURE OR DEFECT, WHETHER ARISING OUT OF BREACH OF CONTRACT, TORT (INCLUDING, WITHOUT LIMITATION, NEGLIGENCE), STRICT LIABILITY, INDEMNITY, CONTRIBUTION OR OTHERWISE.**

CUSTOMER SERVICE DESCRIPTION

In order to maintain safe and trouble-free operation of the Product and to prevent the incurrence of unnecessary costs and expenses, Advantest recommends a regular preventive maintenance program under its maintenance agreement.

Advantest's maintenance agreement provides the Purchaser on-site and off-site maintenance, parts, maintenance machinery, regular inspections, and telephone support and will last a maximum of ten years from the date the delivery of the Product. For specific details of the services provided under the maintenance agreement, please contact the nearest Advantest office listed at the end of this Operation Manual or Advantest's sales representatives.

Some of the components and parts of this Product have a limited operating life (such as, electrical and mechanical parts, fan motors, unit power supply, etc.). Accordingly, these components and parts will have to be replaced on a periodic basis. If the operating life of a component or part has expired and such component or part has not been replaced, there is a possibility that the Product will not perform properly. Additionally, if the operating life of a component or part has expired and continued use of such component or part damages the Product, the Product may not be repairable. Please contact the nearest Advantest office listed at the end of this Operation Manual or Advantest's sales representatives to determine the operating life of a specific component or part, as the operating life may vary depending on various factors such as operating condition and usage environment.

SALES & SUPPORT OFFICES

Advantest Korea Co., Ltd.

22BF, Kyobo KangNam Tower,
1303-22, Seocho-Dong, Seocho-Ku, Seoul #137-070, Korea
Phone: +82-2-532-7071
Fax: +82-2-532-7132

Advantest (Suzhou) Co., Ltd.

Shanghai Branch Office:
Bldg. 6D, NO.1188 Gumei Road, Shanghai, China 201102 P.R.C.
Phone: +86-21-6485-2725
Fax: +86-21-6485-2726

Shanghai Branch Office:
406/F, Ying Building, Quantum Plaza, No. 23 Zhi Chun Road,
Hai Dian District, Beijing,
China 100083
Phone: +86-10-8235-3377
Fax: +86-10-8235-6717

Advantest (Singapore) Pte. Ltd.

438A Alexandra Road, #08-03/06
Alexandra Technopark Singapore 119967
Phone: +65-6274-3100
Fax: +65-6274-4055

Advantest America, Inc.

3201 Scott Boulevard, Suite, Santa Clara, CA 95054, U.S.A
Phone: +1-408-988-7700
Fax: +1-408-987-0691

ROHDE & SCHWARZ Europe GmbH

Mühldorfstraße 15 D-81671 München, Germany
(P.O.B. 80 14 60 D-81614 München, Germany)
Phone: +49-89-4129-13711
Fax: +49-89-4129-13723

ADVANTEST[®]

<http://www.advantest.co.jp>