

---

---

**ADVANTEST<sup>®</sup>**  
**ADVANTEST CORPORATION**

---

***R3465 Series OPT77***  
***GSM Graphics Option***  
***Operation Manual***

**MANUAL NUMBER FOE-8324143A01**

---

***Applicable models***

***R3263***

***R3465***



---

## Safety Summary

To ensure thorough understanding of all functions and to ensure efficient use of this instrument, please read the manual carefully before using. Note that Advantest bears absolutely no responsibility for the result of operations caused due to incorrect or inappropriate use of this instrument.

If the equipment is used in a manner not specified by Advantest, the protection provided by the equipment may be impaired.

- **Warning Labels**

Warning labels are applied to Advantest products in locations where specific dangers exist. Pay careful attention to these labels during handling. Do not remove or tear these labels. If you have any questions regarding warning labels, please ask your nearest Advantest dealer. Our address and phone number are listed at the end of this manual.

Symbols of those warning labels are shown below together with their meaning.

**DANGER:** Indicates an imminently hazardous situation which will result in death or serious personal injury.

**WARNING:** Indicates a potentially hazardous situation which will result in death or serious personal injury.

**CAUTION:** Indicates a potentially hazardous situation which will result in personal injury or a damage to property including the product.

- **Basic Precautions**

Please observe the following precautions to prevent fire, burn, electric shock, and personal injury.

- Use a power cable rated for the voltage in question. Be sure however to use a power cable conforming to safety standards of your nation when using a product overseas.
- When inserting the plug into the electrical outlet, first turn the power switch OFF and then insert the plug as far as it will go.
- When removing the plug from the electrical outlet, first turn the power switch OFF and then pull it out by gripping the plug. Do not pull on the power cable itself. Make sure your hands are dry at this time.
- Before turning on the power, be sure to check that the supply voltage matches the voltage requirements of the instrument.
- Connect the power cable to a power outlet that is connected to a protected ground terminal. Grounding will be defeated if you use an extension cord which does not include a protected ground terminal.
- Be sure to use fuses rated for the voltage in question.
- Do not use this instrument with the case open.
- Do not place anything on the product and do not apply excessive pressure to the product. Also, do not place flower pots or other containers containing liquid such as chemicals near this

---

## Safety Summary

product.

- When the product has ventilation outlets, do not stick or drop metal or easily flammable objects into the ventilation outlets.
- When using the product on a cart, fix it with belts to avoid its drop.
- When connecting the product to peripheral equipment, turn the power off.

- **Caution Symbols Used Within this Manual**

Symbols indicating items requiring caution which are used in this manual are shown below together with their meaning.

**DANGER:** Indicates an item where there is a danger of serious personal injury (death or serious injury).

**WARNING:** Indicates an item relating to personal safety or health.

**CAUTION:** Indicates an item relating to possible damage to the product or instrument or relating to a restriction on operation.

- **Safety Marks on the Product**

The following safety marks can be found on Advantest products.



: ATTENTION - Refer to manual.



: Protective ground (earth) terminal.



: DANGER - High voltage.



: CAUTION - Risk of electric shock.

- **Replacing Parts with Limited Life**

The following parts used in the instrument are main parts with limited life.

Replace the parts listed below before their expected lifespan has expired to maintain the performance and function of the instrument.

Note that the estimated lifespan for the parts listed below may be shortened by factors such as the environment where the instrument is stored or used, and how often the instrument is used.

The parts inside are not user-replaceable. For a part replacement, please contact the Advantest sales office for servicing.

Each product may use parts with limited life.

For more information, refer to the section in this document where the parts with limited life are described.

## Main Parts with Limited Life

Part name	Life
Unit power supply	5 years
Fan motor	5 years
Electrolytic capacitor	5 years
LCD display	6 years
LCD backlight	2.5 years
Floppy disk drive	5 years
Memory backup battery	5 years

- **Hard Disk Mounted Products**

The operational warnings are listed below.

- Do not move, shock and vibrate the product while the power is turned on.  
Reading or writing data in the hard disk unit is performed with the memory disk turning at a high speed. It is a very delicate process.
- Store and operate the products under the following environmental conditions.  
An area with no sudden temperature changes.  
An area away from shock or vibrations.  
An area free from moisture, dirt, or dust.  
An area away from magnets or an instrument which generates a magnetic field.
- Make back-ups of important data.  
The data stored in the disk may become damaged if the product is mishandled. The hard disc has a limited life span which depends on the operational conditions. Note that there is no guarantee for any loss of data.

- **Precautions when Disposing of this Instrument**

When disposing of harmful substances, be sure dispose of them properly with abiding by the state-provided law.

Harmful substances: (1) PCB (polycarbon biphenyl)  
(2) Mercury  
(3) Ni-Cd (nickel cadmium)  
(4) Other  
Items possessing cyan, organic phosphorous and hexadic chromium and items which may leak cadmium or arsenic (excluding lead in solder).

Example: fluorescent tubes, batteries

# Environmental Conditions

This instrument should only be used in an area which satisfies the following conditions:

- An area free from corrosive gas
- An area away from direct sunlight
- A dust-free area
- An area free from vibrations
- Altitude of up to 2000 m



**Figure-1 Environmental Conditions**

- Operating position



**Figure-2 Operating Position**

- Storage position



**Figure-3 Storage Position**

- The classification of the transient over-voltage, which exists typically in the main power supply, and the pollution degree is defined by IEC61010-1 and described below.

Impulse withstand voltage (over-voltage) category II defined by IEC60364-4-443

Pollution Degree 2

## Types of Power Cable

Replace any references to the power cable type, according to the following table, with the appropriate power cable type for your country.

Plug configuration	Standards	Rating, color and length	Model number (Option number)
	PSE: Japan  Electrical Appliance and Material Safety Law	125 V at 7 A Black 2 m (6 ft)	Straight: A01402  Angled: A01412
	UL: United States of America  CSA: Canada	125 V at 7 A Black 2 m (6 ft)	Straight: A01403 (Option 95)  Angled: A01413
	CEE: Europe DEMKO: Denmark NEMKO: Norway VDE: Germany KEMA: The Netherlands CEBEC: Belgium OVE: Austria FIMKO: Finland SEMKO: Sweden	250 V at 6 A Gray 2 m (6 ft)	Straight: A01404 (Option 96)  Angled: A01414
	SEV: Switzerland	250 V at 6 A Gray 2 m (6 ft)	Straight: A01405 (Option 97)  Angled: A01415
	SAA: Australia, New Zealand	250 V at 6 A Gray 2 m (6 ft)	Straight: A01406 (Option 98)  Angled: -----
	BS: United Kingdom	250 V at 6 A Black 2 m (6 ft)	Straight: A01407 (Option 99)  Angled: A01417
	CCC: China	250 V at 10 A Black 2 m (6 ft)	Straight: A114009 (Option 94)  Angled: A114109





## Table of Power Cable Options

There are six power cable options (refer to following table).

Order power cable options by Model number.

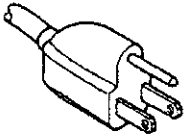
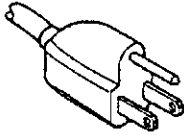
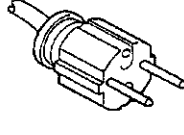
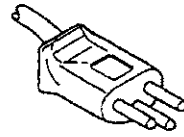
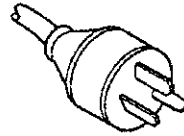
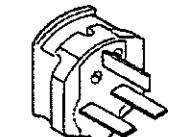
	Plug configuration	Standards	Rating, color and length	Model number (Option number)
1		JIS: Japan Law on Electrical Appliances	125 V at 7 A Black 2 m (6 ft)	Straight: A01402 Angled: A01412
2		UL: United States of America CSA: Canada	125 V at 7 A Black 2 m (6 ft)	Straight: A01403 (Option 95) Angled: A01413
3		CEE: Europe DEMKO: Denmark NEMKO: Norway VDE: Germany KEMA: The Netherlands CEBEC: Belgium OVE: Austria FIMKO: Finland SEMKO: Sweden	250 V at 6 A Gray 2 m (6 ft)	Straight: A01404 (Option 96) Angled: A01414
4		SEV: Switzerland	250 V at 6 A Gray 2 m (6 ft)	Straight: A01405 (Option 97) Angled: A01415
5		SAA: Australia, New Zealand	250 V at 6 A Gray 2 m (6 ft)	Straight: A01406 (Option 98) Angled: -----
6		BS: United Kingdom	250 V at 6 A Black 2 m (6 ft)	Straight: A01407 (Option 99) Angled: A01417



## TABLE OF CONTENTS

### Chapter 1 Measurement Function

- 1. About GSM Graphics Option ..... 1-2
  - How to measure ..... 1-3
  - Examples of display ..... 1-4

### Chapter 2 GPIB

- 1. List of GPIB Code ..... 2-2
- 2. GPIB Sample Program ..... 2-3
  - HP200, 300 Series/HP-BASIC ..... 2-3

### Chapter 3 Specifications

- 1. Specifications of GSM Graphics Option ..... 3-2
  - Bit-Frequency Display ..... 3-2
  - Phase Error Display ..... 3-2
  - FFT of Phase Error Display ..... 3-2
  - Trellis Display ..... 3-2
  - Demodulated Display ..... 3-2



## LIST OF ILLUSTRATIONS

<u>NO.</u>	<u>Title</u>	<u>Page</u>
1-1	GSM Graphics Selection Window .....	1-3
1-2	Bit-Frequency .....	1-4
1-3	Phase Error .....	1-4
1-4	FFT of Phase Error .....	1-5
1-5	Trellis .....	1-5
1-6	Demodulated Data .....	1-6



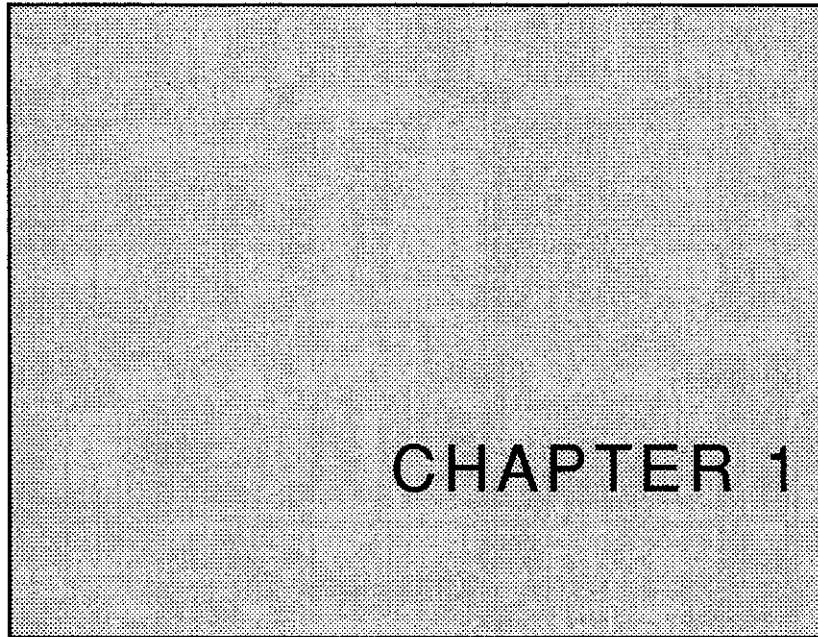

# Measurement Function

This chapter describes about GSM Graphics Option.

---

## CONTENTS

---

1. About GSM Graphics Option .....	1-2
How to measure .....	1-3
Examples of display .....	1-4

---

# 1. About GSM Graphics Option

The GSM Graphics Option includes Display of Bit-Frequency, Phase Error, FFT of Phase Error, Demodulated Data. Followings are software key list.

《Software-key-menu list》

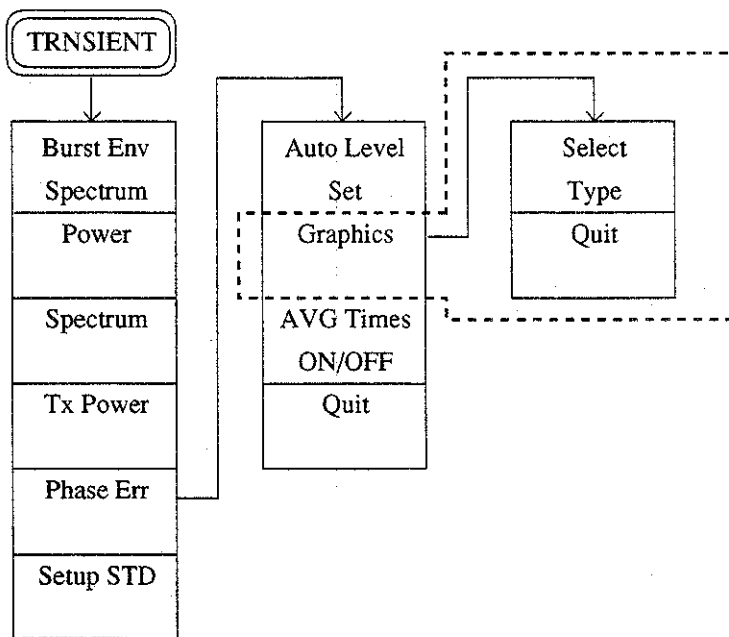

The part enclosed with  is the menus added by this option.



■ How to measure

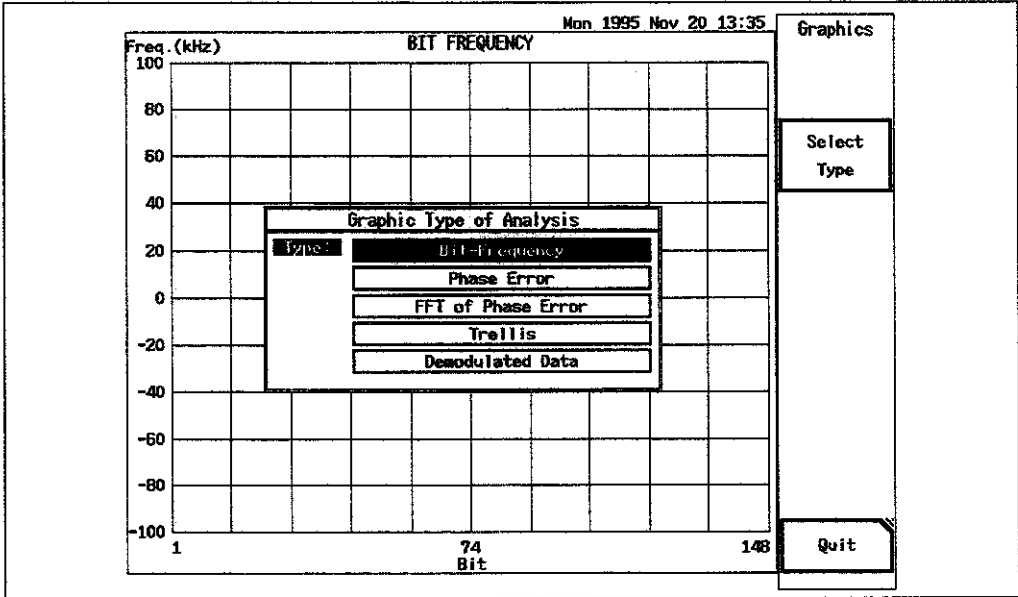
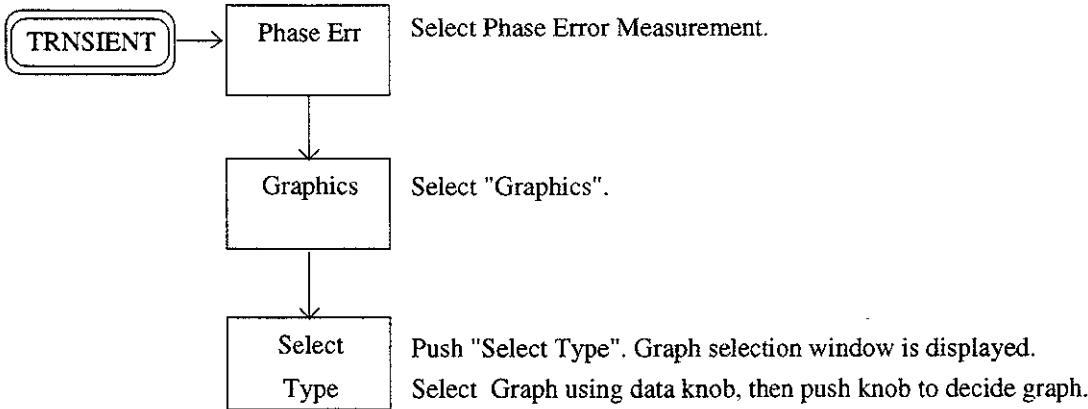

Figure 1-1 GSM Graphics Selection Window

Push **SINGLE** or **REPEAT** to measure.

MARKER  
To display marker, push **ON**

MARKER  
To turn off marker, push **ON** again.

1. About GSM Graphics Option

■ Examples of display

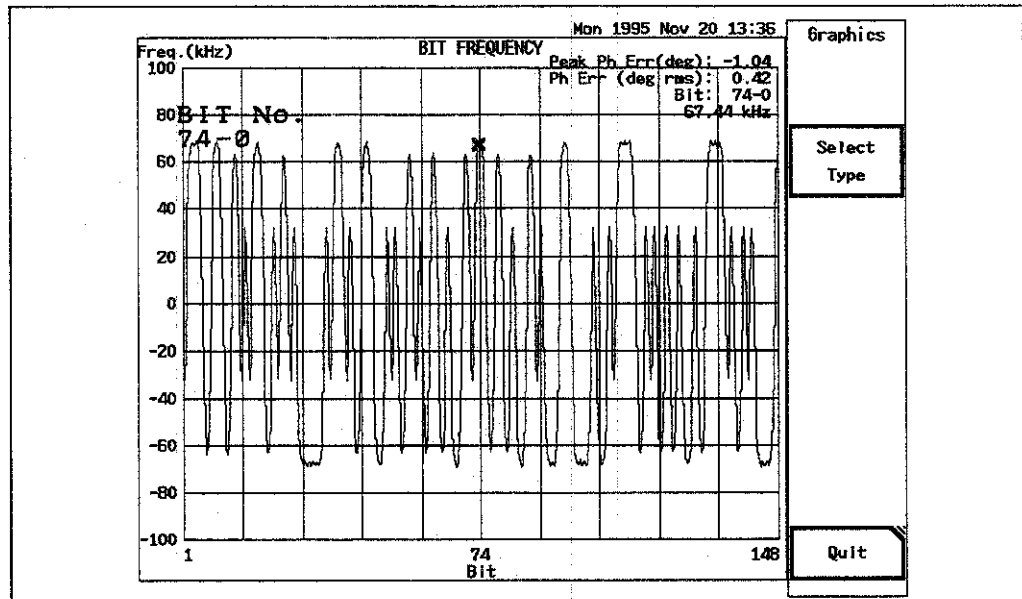

Figure 1-2 Bit-Frequency

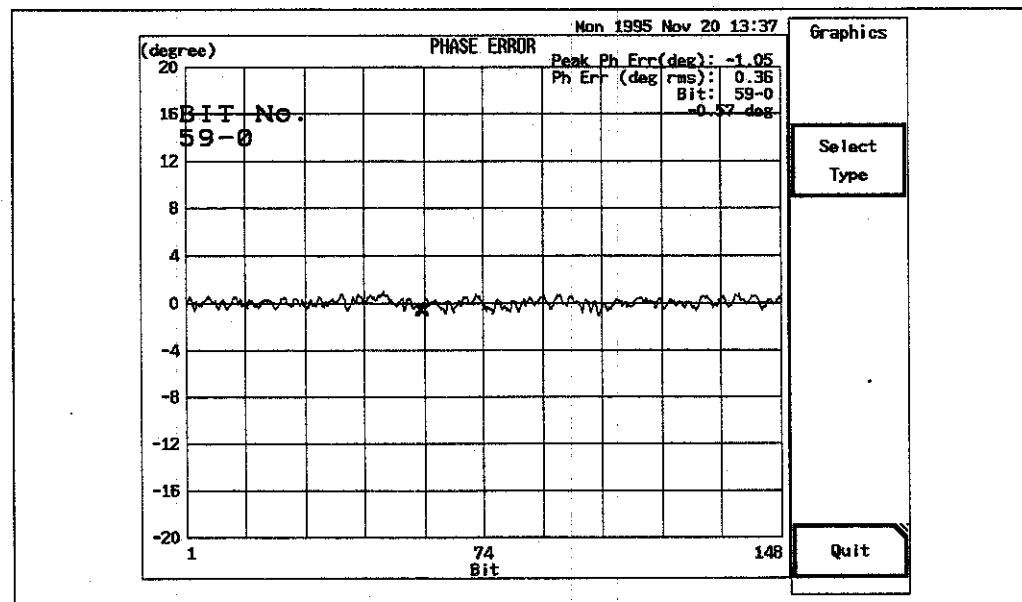

Figure 1-3 Phase Error

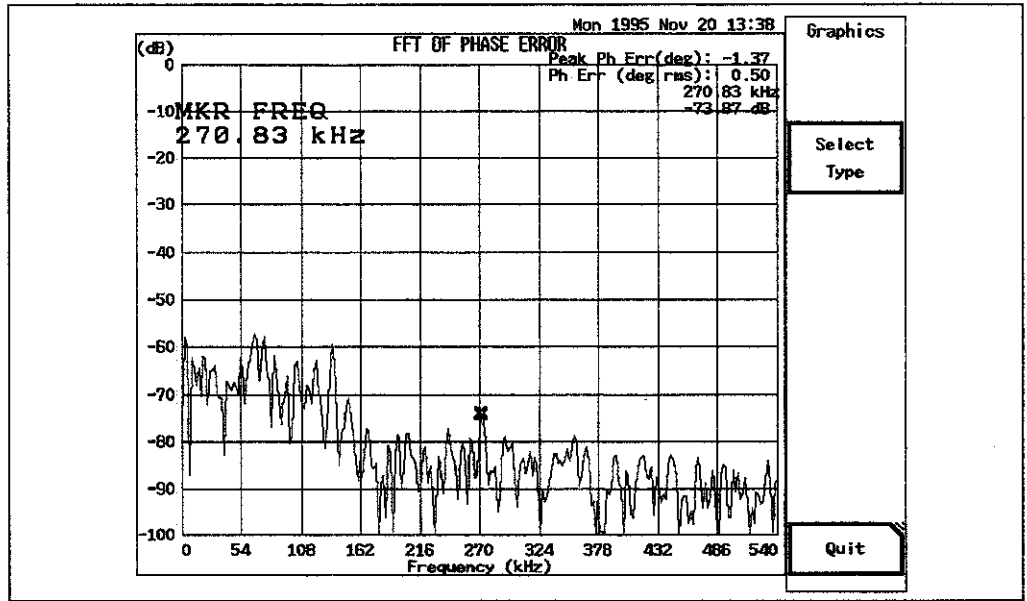

Figure 1-4 FFT of Phase Error

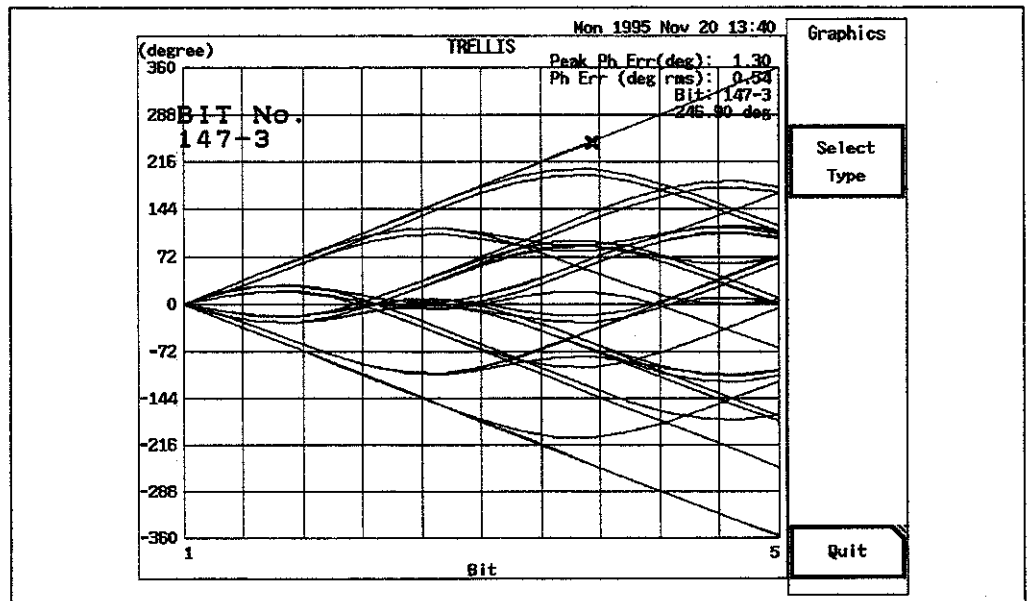

Figure 1-5 Trellis

1. About GSM Graphics Option

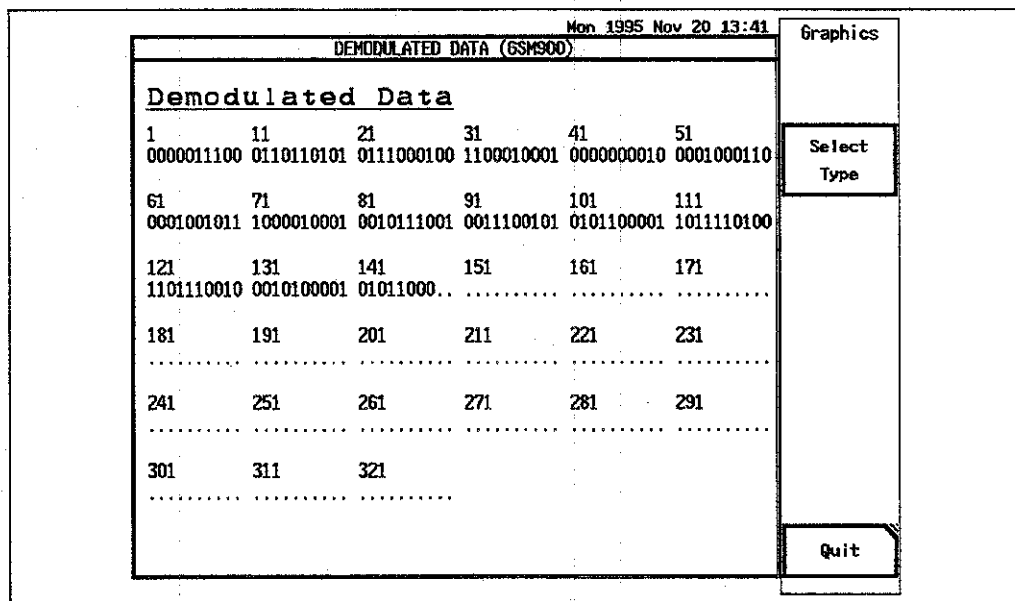
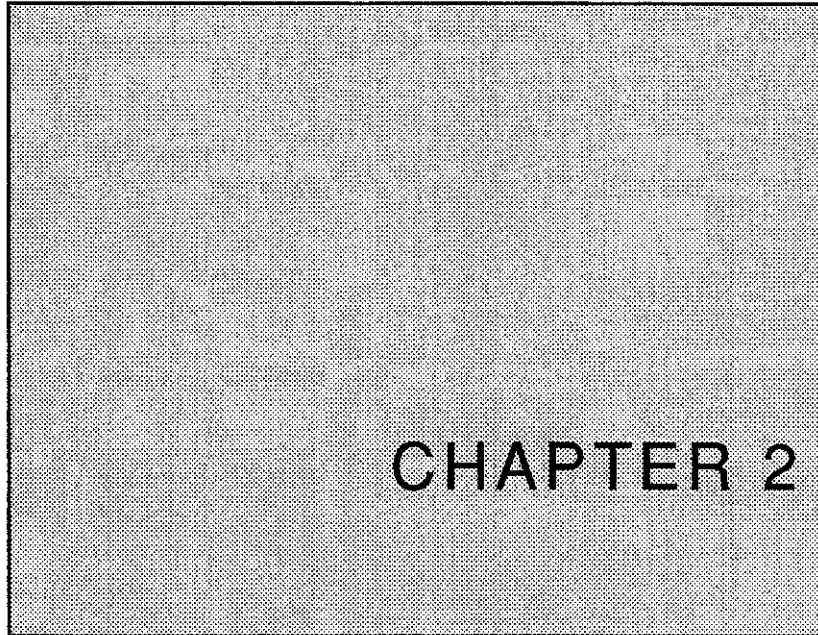

Figure 1-6 Demodulated Data



# GPIB

This chapter lists GPIB code of GSM Graphics Option and Example program.

---

## CONTENTS

---

1. List of GPIB Code .....	2-2
2. GPIB Sample Program .....	2-3

---

# 1. List of GPIB Code

Function	Listener code	Talker request		Remarks
		Code	Output format	
<u>○Setting Condition</u>				
<Graphics Type>				
Bit-Frequency	GGPTYP BF	GGPTYP?	0	
Phase Error	GGPTYP PE		1	
FFT of Phase Error	GGPTYP FPE		2	
Trellis	GGPTYP TR		3	
Demodulated Data	GGPTYP DE		4	
<u>○Measurement Start/Execution</u>				
Graphics display execution	GSMGPH	—		
<u>○Data Output</u>				
X data (Bit number)	—	GPHX?	n data, d1, ..., dn d1 to dn = integer (16bit)	
X data (Frequency)	—	GPHF?	n data, d1, ..., dn d1 to dn = float (32bit)	
Y data (Frequency) (Level) (Phase)	—	GPHY?	n data, d1, ..., dn d1 to dn = float (32bit) n data : Number of output data	
Demodulated Data	—	DEMODO?	n-str, d1\$, ..., dn\$ n-str : Number of output character strings d1\$ to dn\$ = Character string data (1 data : 10bit)	
Phase Accuracy	—	PHACC?	Pk, Ph, Fr Pk : Peak Phase Error Ph : Phase Error Fr : Frequency Error	
<u>○Marker</u>				
Marker ON	GMK ON	GMK?	ON/OFF	
Marker OFF	GMK OFF			
Marker movement (Bit number)	GMKX *	GMKX?	Bit number	
Marker movement (Frequency)	GMKF *	GMKF?	Frequency	
Marker Y Data	—	GMKY?	Frequency Level Phase	

## 2. GPIB Sample Program

The following example is the program that reads the frequency data (Y axis) of Bit-Frequency.

(It is assumed that the graph of Bit-Frequency is displayed on the screen.)

### ■ HP200, 300 Series/HP-BASIC

```
10 DIM Freq(600)           'Defines the area of frequency data. (Number of data=147×4)
20 OUTPUT 708;"DL0"        'Sets the delimiter to CR and LF.
30 OUTPUT 708;"GPHY?"      'Specifies for reading the Y axis data.
40 ENTER 708;N             'The first data shows the number of data.
50 FOR I=0 TO N-1         'Executes the loop N times.
60   ENTER 708;Freq(I)    'Reads data as the numeric variable.
70 NEXT I
80 END
```





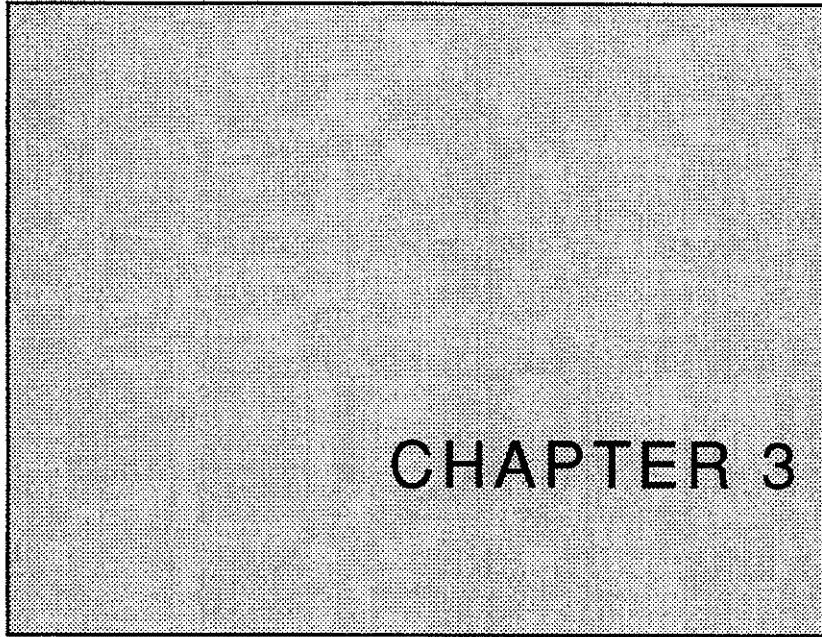

# Specifications

This chapter describes about the specification of GSM Graphics Option.

---

## CONTENTS

---

1. Specifications of GSM Graphics Option .....	3-2
--	-----

---

## 1. Specifications of GSM Graphics Option

■ Bit-Frequency Display

■ Phase Error Display

■ FFT of Phase Error Display

■ Trellis Display

■ Demodulated Display

## **IMPORTANT INFORMATION FOR ADVANTEST SOFTWARE**

PLEASE READ CAREFULLY: This is an important notice for the software defined herein. Computer programs including any additions, modifications and updates thereof, operation manuals, and related materials provided by Advantest (hereafter referred to as "SOFTWARE"), included in or used with hardware produced by Advantest (hereafter referred to as "PRODUCTS").

### **SOFTWARE License**

All rights in and to the SOFTWARE (including, but not limited to, copyright) shall be and remain vested in Advantest. Advantest hereby grants you a license to use the SOFTWARE only on or with Advantest PRODUCTS.

### **Restrictions**

- (1) You may not use the SOFTWARE for any purpose other than for the use of the PRODUCTS.
- (2) You may not copy, modify, or change, all or any part of, the SOFTWARE without permission from Advantest.
- (3) You may not reverse engineer, de-compile, or disassemble, all or any part of, the SOFTWARE.

### **Liability**

Advantest shall have no liability (1) for any PRODUCT failures, which may arise out of any misuse (misuse is deemed to be use of the SOFTWARE for purposes other than its intended use) of the SOFTWARE. (2) For any dispute between you and any third party for any reason whatsoever including, but not limited to, infringement of intellectual property rights.

## LIMITED WARRANTY

1. Unless otherwise specifically agreed by Seller and Purchaser in writing, Advantest will warrant to the Purchaser that during the Warranty Period this Product (other than consumables included in the Product) will be free from defects in material and workmanship and shall conform to the specifications set forth in this Operation Manual.
2. The warranty period for the Product (the "Warranty Period") will be a period of one year commencing on the delivery date of the Product.
3. If the Product is found to be defective during the Warranty Period, Advantest will, at its option and in its sole and absolute discretion, either (a) repair the defective Product or part or component thereof or (b) replace the defective Product or part or component thereof, in either case at Advantest's sole cost and expense.
4. This limited warranty will not apply to defects or damage to the Product or any part or component thereof resulting from any of the following:
  - (a) any modifications, maintenance or repairs other than modifications, maintenance or repairs (i) performed by Advantest or (ii) specifically recommended or authorized by Advantest and performed in accordance with Advantest's instructions;
  - (b) any improper or inadequate handling, carriage or storage of the Product by the Purchaser or any third party (other than Advantest or its agents);
  - (c) use of the Product under operating conditions or environments different than those specified in the Operation Manual or recommended by Advantest, including, without limitation, (i) instances where the Product has been subjected to physical stress or electrical voltage exceeding the permissible range and (ii) instances where the corrosion of electrical circuits or other deterioration was accelerated by exposure to corrosive gases or dusty environments;
  - (d) use of the Product in connection with software, interfaces, products or parts other than software, interfaces, products or parts supplied or recommended by Advantest;
  - (e) incorporation in the Product of any parts or components (i) provided by Purchaser or (ii) provided by a third party at the request or direction of Purchaser or due to specifications or designs supplied by Purchaser (including, without limitation, any degradation in performance of such parts or components);
  - (f) Advantest's incorporation or use of any specifications or designs supplied by Purchaser;
  - (g) the occurrence of an event of force majeure, including, without limitation, fire, explosion, geological change, storm, flood, earthquake, tidal wave, lightning or act of war; or
  - (h) any negligent act or omission of the Purchaser or any third party other than Advantest.
5. **EXCEPT TO THE EXTENT EXPRESSLY PROVIDED HEREIN, ADVANTEST HEREBY EXPRESSLY DISCLAIMS, AND THE PURCHASER HEREBY WAIVES, ALL WARRANTIES, WHETHER EXPRESS OR IMPLIED, STATUTORY OR OTHERWISE, INCLUDING, WITHOUT LIMITATION, (A) ANY WARRANTY OF MERCHANTABILITY OR FITNESS FOR A PARTICULAR PURPOSE AND (B) ANY WARRANTY OR REPRESENTATION AS TO THE VALIDITY, SCOPE, EFFECTIVENESS OR USEFULNESS OF ANY TECHNOLOGY OR ANY INVENTION.**
6. **THE REMEDY SET FORTH HEREIN SHALL BE THE SOLE AND EXCLUSIVE REMEDY OF THE PURCHASER FOR BREACH OF WARRANTY WITH RESPECT TO THE PRODUCT.**
7. **ADVANTEST WILL NOT HAVE ANY LIABILITY TO THE PURCHASER FOR ANY INDIRECT, INCIDENTAL, SPECIAL, CONSEQUENTIAL OR PUNITIVE DAMAGES, INCLUDING, WITHOUT LIMITATION, LOSS OF ANTICIPATED PROFITS OR REVENUES, IN ANY AND ALL CIRCUMSTANCES, EVEN IF ADVANTEST HAS BEEN ADVISED OF THE POSSIBILITY OF SUCH DAMAGES AND WHETHER ARISING OUT OF BREACH OF CONTRACT, WARRANTY, TORT (INCLUDING, WITHOUT LIMITATION, NEGLIGENCE), STRICT LIABILITY, INDEMNITY, CONTRIBUTION OR OTHERWISE. TORT (INCLUDING, WITHOUT LIMITATION, NEGLIGENCE), STRICT LIABILITY, INDEMNITY, CONTRIBUTION OR OTHERWISE.**
8. **OTHER THAN THE REMEDY FOR THE BREACH OF WARRANTY SET FORTH HEREIN, ADVANTEST SHALL NOT BE LIABLE FOR, AND HEREBY DISCLAIMS TO THE FULLEST EXTENT PERMITTED BY LAW ANY LIABILITY FOR, DAMAGES FOR PRODUCT FAILURE OR DEFECT, WHETHER ARISING OUT OF BREACH OF CONTRACT, TORT (INCLUDING, WITHOUT LIMITATION, NEGLIGENCE), STRICT LIABILITY, INDEMNITY, CONTRIBUTION OR OTHERWISE.**

## **CUSTOMER SERVICE DESCRIPTION**

In order to maintain safe and trouble-free operation of the Product and to prevent the incurrence of unnecessary costs and expenses, Advantest recommends a regular preventive maintenance program under its maintenance agreement.

Advantest's maintenance agreement provides the Purchaser on-site and off-site maintenance, parts, maintenance machinery, regular inspections, and telephone support and will last a maximum of ten years from the date the delivery of the Product. For specific details of the services provided under the maintenance agreement, please contact the nearest Advantest office listed at the end of this Operation Manual or Advantest's sales representatives.

Some of the components and parts of this Product have a limited operating life (such as, electrical and mechanical parts, fan motors, unit power supply, etc.). Accordingly, these components and parts will have to be replaced on a periodic basis. If the operating life of a component or part has expired and such component or part has not been replaced, there is a possibility that the Product will not perform properly. Additionally, if the operating life of a component or part has expired and continued use of such component or part damages the Product, the Product may not be repairable. Please contact the nearest Advantest office listed at the end of this Operation Manual or Advantest's sales representatives to determine the operating life of a specific component or part, as the operating life may vary depending on various factors such as operating condition and usage environment.

## SALES & SUPPORT OFFICES

Advantest Korea Co., Ltd.

22BF, Kyobo KangNam Tower,  
1303-22, Seocho-Dong, Seocho-Ku, Seoul #137-070, Korea  
Phone: +82-2-532-7071  
Fax: +82-2-532-7132

Advantest (Suzhou) Co., Ltd.

Shanghai Branch Office:  
Bldg. 6D, NO.1188 Gumei Road, Shanghai, China 201102 P.R.C.  
Phone: +86-21-6485-2725  
Fax: +86-21-6485-2726

Shanghai Branch Office:  
406/F, Ying Building, Quantum Plaza, No. 23 Zhi Chun Road,  
Hai Dian District, Beijing,  
China 100083  
Phone: +86-10-8235-3377  
Fax: +86-10-8235-6717

Advantest (Singapore) Pte. Ltd.

438A Alexandra Road, #08-03/06  
Alexandra Technopark Singapore 119967  
Phone: +65-6274-3100  
Fax: +65-6274-4055

Advantest America, Inc.

3201 Scott Boulevard, Suite, Santa Clara, CA 95054, U.S.A  
Phone: +1-408-988-7700  
Fax: +1-408-987-0691

ROHDE & SCHWARZ Europe GmbH

Mühldorfstraße 15 D-81671 München, Germany  
(P.O.B. 80 14 60 D-81614 München, Germany)  
Phone: +49-89-4129-13711  
Fax: +49-89-4129-13723

**ADVANTEST®**

<http://www.advantest.co.jp>