

---

**ADVANTEST®**  
ADVANTEST CORPORATION

---

***R3561L***  
***CDMA Test Source Unit***  
***Operation Manual***

MANUAL NUMBER FOE-8311264D00

---



---

## Safety Summary

To ensure thorough understanding of all functions and to ensure efficient use of this instrument, please read the manual carefully before using. Note that Advantest bears absolutely no responsibility for the result of operations caused due to incorrect or inappropriate use of this instrument.

If the equipment is used in a manner not specified by Advantest, the protection provided by the equipment may be impaired.

- **Warning Labels**

Warning labels are applied to Advantest products in locations where specific dangers exist. Pay careful attention to these labels during handling. Do not remove or tear these labels. If you have any questions regarding warning labels, please ask your nearest Advantest dealer. Our address and phone number are listed at the end of this manual.

Symbols of those warning labels are shown below together with their meaning.

**DANGER:** Indicates an imminently hazardous situation which will result in death or serious personal injury.

**WARNING:** Indicates a potentially hazardous situation which will result in death or serious personal injury.

**CAUTION:** Indicates a potentially hazardous situation which will result in personal injury or a damage to property including the product.

- **Basic Precautions**

Please observe the following precautions to prevent fire, burn, electric shock, and personal injury.

- Use a power cable rated for the voltage in question. Be sure however to use a power cable conforming to safety standards of your nation when using a product overseas.
- When inserting the plug into the electrical outlet, first turn the power switch OFF and then insert the plug as far as it will go.
- When removing the plug from the electrical outlet, first turn the power switch OFF and then pull it out by gripping the plug. Do not pull on the power cable itself. Make sure your hands are dry at this time.
- Before turning on the power, be sure to check that the supply voltage matches the voltage requirements of the instrument.
- Connect the power cable to a power outlet that is connected to a protected ground terminal. Grounding will be defeated if you use an extension cord which does not include a protected ground terminal.
- Be sure to use fuses rated for the voltage in question.
- Do not use this instrument with the case open.
- Do not place anything on the product and do not apply excessive pressure to the product. Also, do not place flower pots or other containers containing liquid such as chemicals near this

---

## Safety Summary

product.

- When the product has ventilation outlets, do not stick or drop metal or easily flammable objects into the ventilation outlets.
- When using the product on a cart, fix it with belts to avoid its drop.
- When connecting the product to peripheral equipment, turn the power off.

- **Caution Symbols Used Within this Manual**

Symbols indicating items requiring caution which are used in this manual are shown below together with their meaning.

**DANGER:** Indicates an item where there is a danger of serious personal injury (death or serious injury).

**WARNING:** Indicates an item relating to personal safety or health.

**CAUTION:** Indicates an item relating to possible damage to the product or instrument or relating to a restriction on operation.

- **Safety Marks on the Product**

The following safety marks can be found on Advantest products.



: ATTENTION - Refer to manual.



: Protective ground (earth) terminal.



: DANGER - High voltage.



: CAUTION - Risk of electric shock.

- **Replacing Parts with Limited Life**

The following parts used in the instrument are main parts with limited life.

Replace the parts listed below before their expected lifespan has expired to maintain the performance and function of the instrument.

Note that the estimated lifespan for the parts listed below may be shortened by factors such as the environment where the instrument is stored or used, and how often the instrument is used.

The parts inside are not user-replaceable. For a part replacement, please contact the Advantest sales office for servicing.

Each product may use parts with limited life.

For more information, refer to the section in this document where the parts with limited life are described.

## Main Parts with Limited Life

Part name	Life
Unit power supply	5 years
Fan motor	5 years
Electrolytic capacitor	5 years
LCD display	6 years
LCD backlight	2.5 years
Floppy disk drive	5 years
Memory backup battery	5 years

- **Hard Disk Mounted Products**

The operational warnings are listed below.

- Do not move, shock and vibrate the product while the power is turned on.  
Reading or writing data in the hard disk unit is performed with the memory disk turning at a high speed. It is a very delicate process.
- Store and operate the products under the following environmental conditions.  
An area with no sudden temperature changes.  
An area away from shock or vibrations.  
An area free from moisture, dirt, or dust.  
An area away from magnets or an instrument which generates a magnetic field.
- Make back-ups of important data.  
The data stored in the disk may become damaged if the product is mishandled. The hard disc has a limited life span which depends on the operational conditions. Note that there is no guarantee for any loss of data.

- **Precautions when Disposing of this Instrument**

When disposing of harmful substances, be sure dispose of them properly with abiding by the state-provided law.

Harmful substances: (1) PCB (polycarbon biphenyl)  
(2) Mercury  
(3) Ni-Cd (nickel cadmium)  
(4) Other  
Items possessing cyan, organic phosphorous and hexadic chromium and items which may leak cadmium or arsenic (excluding lead in solder).

Example: fluorescent tubes, batteries

# Environmental Conditions

This instrument should only be used in an area which satisfies the following conditions:

- An area free from corrosive gas
- An area away from direct sunlight
- A dust-free area
- An area free from vibrations
- Altitude of up to 2000 m



**Figure-1 Environmental Conditions**

- Operating position



**Figure-2 Operating Position**

- Storage position



**Figure-3 Storage Position**

- The classification of the transient over-voltage, which exists typically in the main power supply, and the pollution degree is defined by IEC61010-1 and described below.

Impulse withstand voltage (over-voltage) category II defined by IEC60364-4-443

Pollution Degree 2

## Types of Power Cable

Replace any references to the power cable type, according to the following table, with the appropriate power cable type for your country.

Plug configuration	Standards	Rating, color and length	Model number (Option number)
	PSE: Japan  Electrical Appliance and Material Safety Law	125 V at 7 A Black 2 m (6 ft)	Straight: A01402  Angled: A01412
	UL: United States of America  CSA: Canada	125 V at 7 A Black 2 m (6 ft)	Straight: A01403 (Option 95)  Angled: A01413
	CEE: Europe DEMKO: Denmark NEMKO: Norway VDE: Germany KEMA: The Netherlands CEBEC: Belgium OVE: Austria FIMKO: Finland SEMKO: Sweden	250 V at 6 A Gray 2 m (6 ft)	Straight: A01404 (Option 96)  Angled: A01414
	SEV: Switzerland	250 V at 6 A Gray 2 m (6 ft)	Straight: A01405 (Option 97)  Angled: A01415
	SAA: Australia, New Zealand	250 V at 6 A Gray 2 m (6 ft)	Straight: A01406 (Option 98)  Angled: -----
	BS: United Kingdom	250 V at 6 A Black 2 m (6 ft)	Straight: A01407 (Option 99)  Angled: A01417
	CCC: China	250 V at 10 A Black 2 m (6 ft)	Straight: A114009 (Option 94)  Angled: A114109





## Cautions on Using the R3561L

The operating procedures and functions of the R3561L depend on the system revision used.

### For the System Revisions B00 to B02:

- When the R3561L power is turned on, the R3267, R3463 or R3465 is ready for setting up the parameters immediately after the R3267, R3463 or R3465 is set to the CDMA test source control mode or the tracking generator control mode.
- The backup operation of the user-defined buffer data is not available (see Note).

**NOTE:** When the R3561L power is turned on, the start frame number is 1 and the number of output frames is 600 by default.  
In addition, the contents of the user-defined buffer must be entered because they are unpredictable.

### For the System Revisions B03 or later:

- When the R3561L power is turned on, wait 60 seconds until you can set the R3267, R3463 or R3465 to the CDMA test source control mode or the tracking generator control mode. This procedure is required only when the R3561L power is turned on.
- The backup operation of the user-defined buffer data is available.

## How to Verify the System Revision

Set the R3267, R3463 or R3465 to the CDMA test source control mode to display the CDMA Test Source screen. The system revision is displayed in the upper right-hand corner of the screen (see the figure shown below).

For information on how to start the CDMA test source control mode, refer to Section 3.1, "CDMA Test Source Control."

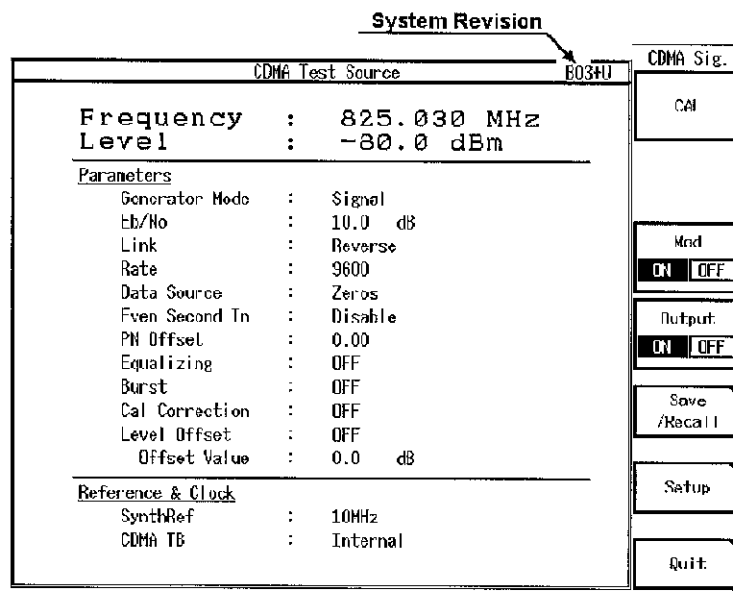

Display Position of System Revision



## Table of Power Cable Options

There are six power cable options (refer to following table).

Order power cable options by Model number.

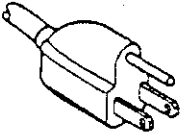
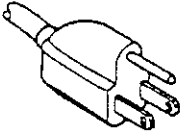
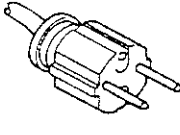
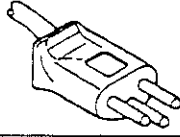
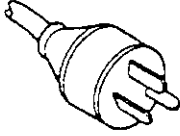
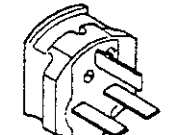
	Plug configuration	Standards	Rating, color and length	Model number (Option number)
1		JIS: Japan Law on Electrical Appliances	125 V at 7 A Black 2 m (6 ft)	Straight: A01402 Angled: A01412
2		UL: United States of America CSA: Canada	125 V at 7 A Black 2 m (6 ft)	Straight: A01403 (Option 95) Angled: A01413
3		CEE: Europe DEMKO: Denmark NEMKO: Norway VDE: Germany KEMA: The Netherlands CEBEC: Belgium OVE: Austria FIMKO: Finland SEMKO: Sweden	250 V at 6 A Gray 2 m (6 ft)	Straight: A01404 (Option 96) Angled: A01414
4		SEV: Switzerland	250 V at 6 A Gray 2 m (6 ft)	Straight: A01405 (Option 97) Angled: A01415
5		SAA: Australia, New Zealand	250 V at 6 A Gray 2 m (6 ft)	Straight: A01406 (Option 98) Angled: -----
6		BS: United Kingdom	250 V at 6 A Black 2 m (6 ft)	Straight: A01407 (Option 99) Angled: A01417



# PREFACE

## (1) Preface

This manual describes the after-purchase procedures up to the actual operation of the CDMA Test Source Unit R3561L.

The R3561L is used with a Spectrum Analyzer R3267 or Modulation Spectrum Analyzer R3463 or R3465 which is equipped with the CDMA Source Control Option (OPT09).

In this manual, the R3267, R3463 or R3465 Panel keys and Soft keys are indicated as [ ] and { }, respectively.

- ex) Panel key: **[FREQ], [SPAN]**
- Soft key: **{Mod ON OFF}, {Setup}**

The contents of this manual are subject to change without prior notice.

This manual may not be reproduced, in part or in whole, in any form or by any means without the prior written permission of the publisher.

If you have any questions, contact your sales representative or our sales office; see the addresses and telephone Nos. at the end of this manual.

## (2) Confirmation of the product and accessories

Upon unpacking, confirm the items of the R3561L main unit and accessories. If there are any missing or damaged items, please contact our nearest sales office or your sales representative.

- R3561L main unit

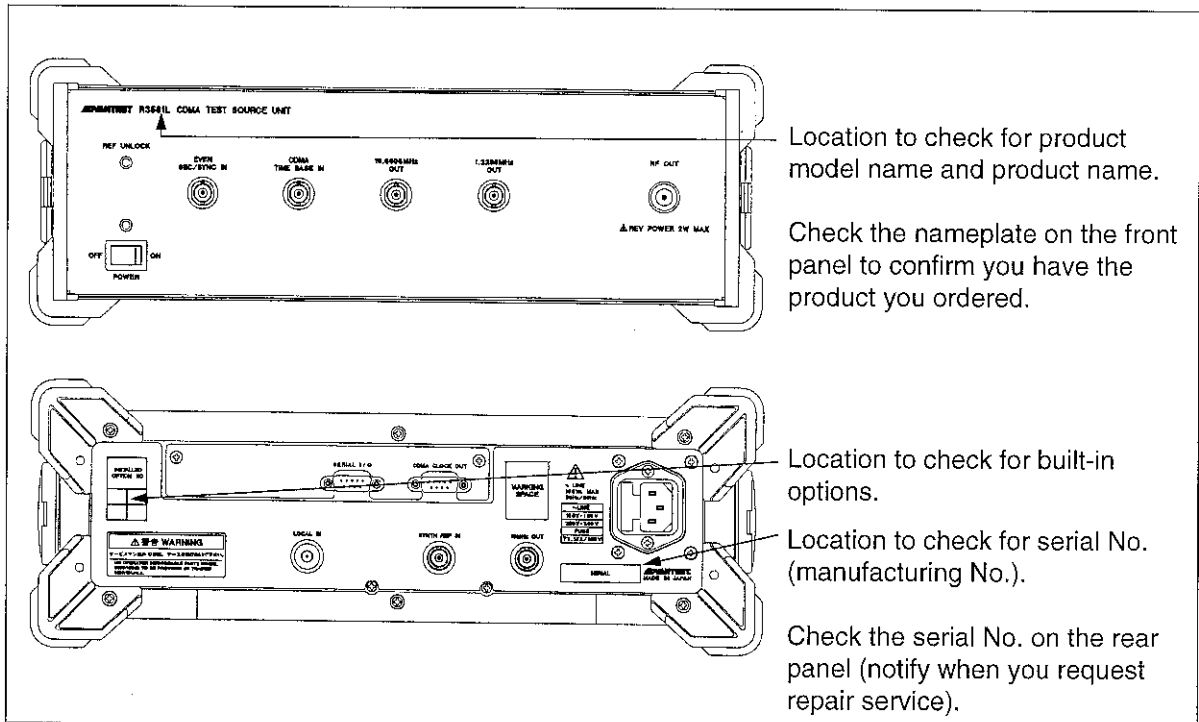

Preface

- List of standard accessories

Notice

Please use the model name for ordering an additional accessory.

Product Name	Model Name	Q'ty	Remarks
Power cable	*	1	
BNC cable	A01037-1500	3	
Serial cable	A01274	1	
Local cable	DPM010-00400A	1	
N-BNC conversion adaptor	JUG-201A/U	1	
BNC T-adaptor	UG-274/U	1	
Carrying belt	—	1	
R3561L Operation Manual	ER3561L	1	English

- \* ADVANTEST provides the power cables for each country.  
See yellow page of "Table of Power Cable Options" at this manual.

## TABLE OF CONTENTS

1	BEFORE STARTING MEASUREMENT .....	1-1
1.1	Product Overview .....	1-1
1.2	Operating Environment .....	1-2
1.3	Power Supply .....	1-3
1.3.1	Power Supply Conditions .....	1-3
1.3.2	Power Voltage Change .....	1-3
1.3.3	Power Fuse Replacement .....	1-3
1.3.4	Power Cable Connection .....	1-5
1.4	Precautions in Use .....	1-6
1.5	Cleaning, Storage, and Transport .....	1-9
1.6	Warm up .....	1-9
1.7	Calibration .....	1-9
1.8	Replacing Parts with Limited Life .....	1-9
2	PANEL DESCRIPTION .....	2-1
2.1	Front Panel .....	2-1
2.2	Rear Panel .....	2-2
2.3	Connection to R3267 .....	2-3
2.4	Connection to R3463 or R3465 .....	2-4
3	OPERATING CONTROL AND FEATURES .....	3-1
3.1	CDMA Test Source Control .....	3-1
3.1.1	Key Functions .....	3-3
3.1.2	Functions of the User Defined Buffer .....	3-11
3.2	Tracking Generator Control .....	3-15
3.2.1	Key Functions .....	3-16
4	GPIB .....	4-1
4.1	GPIB Command Syntax (Description) .....	4-1
4.1.1	Control Command of the CDMA Test Source .....	4-1
4.1.2	TG Control Command .....	4-9
4.2	GPIB Sample Program .....	4-11
5	OPERATION PRINCIPLE .....	5-1
5.1	R3561L Operation Principle .....	5-1
5.2	Block Diagram .....	5-3
5.3	Simplified Operation Check .....	5-4
6	PERFORMANCE SPECIFICATIONS .....	6-1
6.1	CDMA Test Source .....	6-1

Table of Contents

6.1.1	Output Frequency .....	6-1
6.1.2	Output Level .....	6-1
6.1.3	Signal Purity .....	6-1
6.1.4	Modulation .....	6-1
6.1.5	AWGN Source .....	6-2
6.1.6	Reference Source .....	6-2
6.2	Tracking Generator .....	6-2
6.2.1	Output Frequency .....	6-2
6.2.2	Output Level .....	6-2
6.3	Others .....	6-2
6.4	General Specifications .....	6-3
DIMENSIONAL OUTLINE DRAWING .....		EXT-1



## LIST OF ILLUSTRATIONS

No.	Title	Page
1-1	Operating Environment.....	1-2
1-2	Human body.....	1-7
1-3	Floor in the work area .....	1-8
1-4	Benchboard.....	1-8
2-1	Front Panel .....	2-1
2-2	Rear Panel.....	2-2
2-3	Connection to R3267 .....	2-3
2-4	Connection to R3463 or R3465 .....	2-4
3-1	Setup Status Screen.....	3-2
3-2	RS232 Setting Screen .....	3-2
3-3	Setup Status Screen and Numeric Input Window.....	3-4
3-4	Setup Dialog Box Screen.....	3-5
3-5	Output Signal With Burst ON/OFF (Case of Rate 7200 (4800) bits/sec).....	3-7
3-6	Reference Clock Dialog Box Screen.....	3-9
3-7	Save/Recall Screen .....	3-10
3-8	Relationship Between Transfer Buffer and User Defined Buffer.....	3-11
3-9	Transfer Rate and User Defined Buffer Frame Configuration.....	3-12
3-10	Control Bits Block.....	3-12
3-11	Start Frame No. and Output Frame Count.....	3-14
3-12	Relationship between the RBW and TG Level Error (Typical values when Used with the R3267).....	3-18
4-1	GPIO Command Syntax.....	4-1



---

## LIST OF TABLES

No.	Title	Page
3-1	Parameters and Values Initialized by Link Setting Change .....	3-5
3-2	R3561L Initial Setting Status .....	3-8
4-1	Numeric Data Output Format .....	4-3
4-2	Correspondence of Set Data and Query Data (Return Value for Query) .....	4-7



# 1 BEFORE STARTING MEASUREMENT

Be sure to read this section before starting measurement. This section describes the product overview, operating environment, and safety precautions.

## 1.1 Product Overview

The R3561L generates modulated signals conforming to the TIA/EIA/IS-95 standards to perform signal receipt characteristic tests of base stations in digital radio communication systems. The various modulation analysis functions of the R3267, R3463 or R3465 can be combined with the R3561L to establish a complete compact test system for signal transmission and receipt.

The R3561L can also act as a tracking generator, measuring antenna and filter characteristics.

### Features

- Light-weight, complete compact test system for signal transmission/receipt.
- High-quality waveform (see the example output waveform in the diagram below).
- Wide frequency band (cellular, PCS) covered by a single unit.
- Easy-to-view operation panel with color LCD

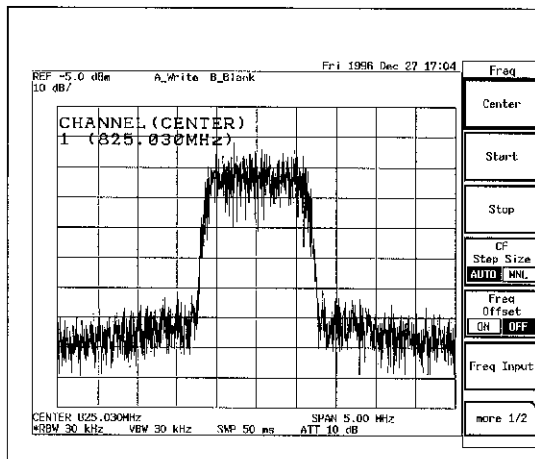

<Example CDMA Signal Output>  
(Using the R3465)

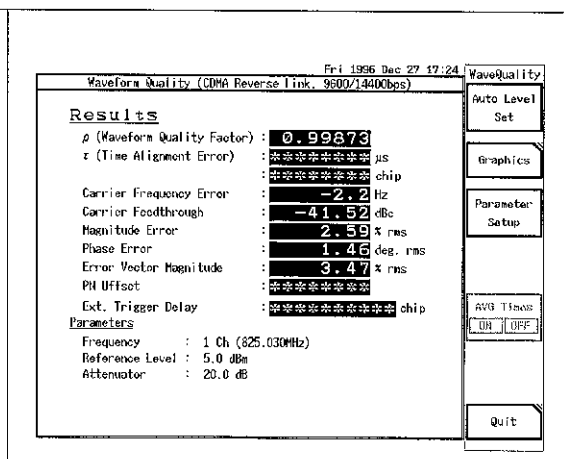

<Example Waveform Quality Measurement>  
(Using the R3465)

1.2 Operating Environment

1.2 Operating Environment

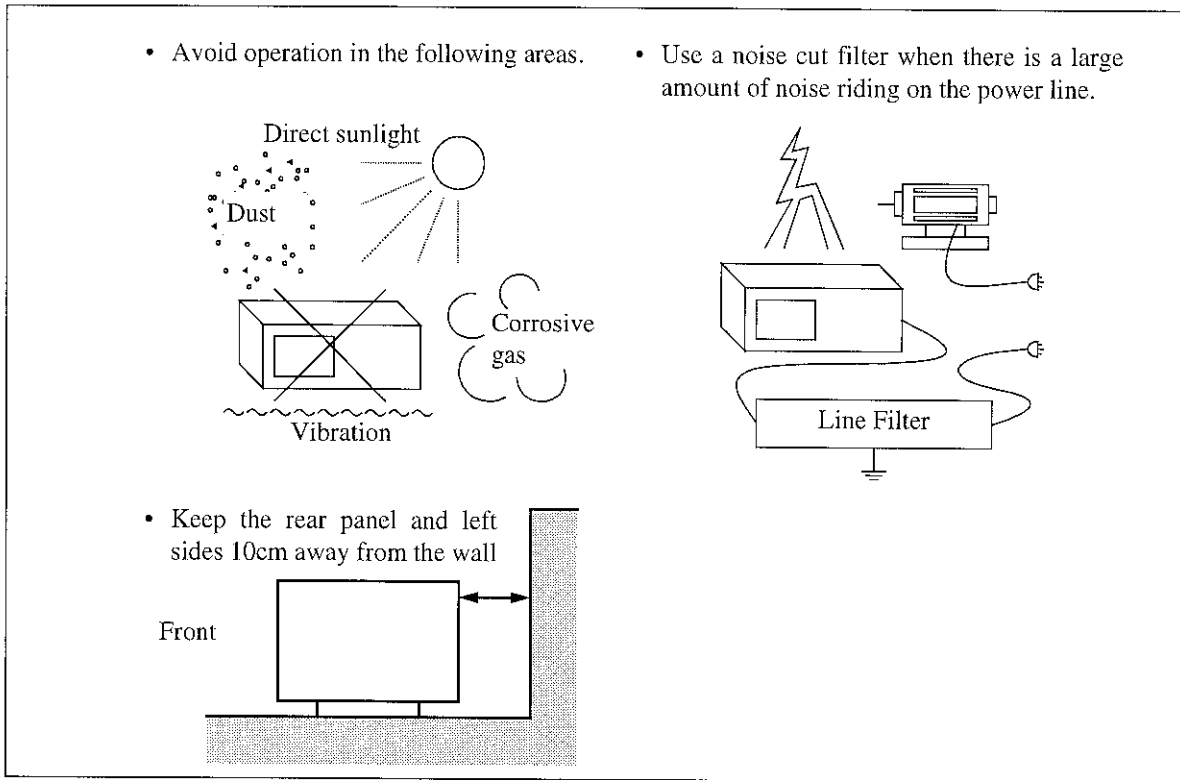

Figure 1-1 Operating Environment

- (1) Install the R3561L in a location satisfying the following conditions.
  - Ambient temperature: 0°C to +50°C (operating temperature range)  
-20°C to +60°C (storage temperature range)
  - Relative humidity: 85% or less (no condensation)
  - No corrosive gas generated
  - Not exposed to direct sunlight
  - No dust
  - No vibration
  - No line noise

The R3561L is designed with careful consideration of AC power line noise. Use the R3561L in an environment with as little noise as possible. If noise influence cannot be avoided, use a noise eliminating filter or equivalent.
- (2) An exhaust cooling fan is mounted on the R3561L left side panel and the R3267, R3463 or R3465 rear panel. Use care not to block air discharge from this fan.
- (3) The R3561L can be used safely under the following conditions:
  - Altitude: 2000m maximum above the sea level
  - Installation category II
  - Pollution degree 2

## 1.3 Power Supply

### 1.3.1 Power Supply Conditions

**WARNING!**

*Use the R3561L according to the following power supply conditions. An improper power supply can damage this unit.*

Be sure to use the power cable suitable to the R3561L power supply conditions.

	100VAC operation	200VAC operation
Input voltage range	90V to 132V	198V to 250V
Frequency range	48Hz to 66Hz	48Hz to 66Hz
Power fuse	T3.15A/250V	
Power consumption	150VA or less	

### 1.3.2 Power Voltage Change

The R3561L power voltage (100V-200V) automatically changes according to the supplied power voltage. Use the power cable which conforms to the supplied power voltage and standards.

### 1.3.3 Power Fuse Replacement

**WARNING!**

1. *Before replacing the power fuse, be sure to turn off the power switch and unplug the power cable.*
2. *Use a power fuse conforming to the supplied power voltage to implement constant protection against fire.*

The power fuse is housed in the fuse holder on the rear panel. Use the following procedure to verify or replace the power fuse.

1.3 Power Supply

<Procedure>

- ① Use a screwdriver (-) to remove the FUSE holder cap.

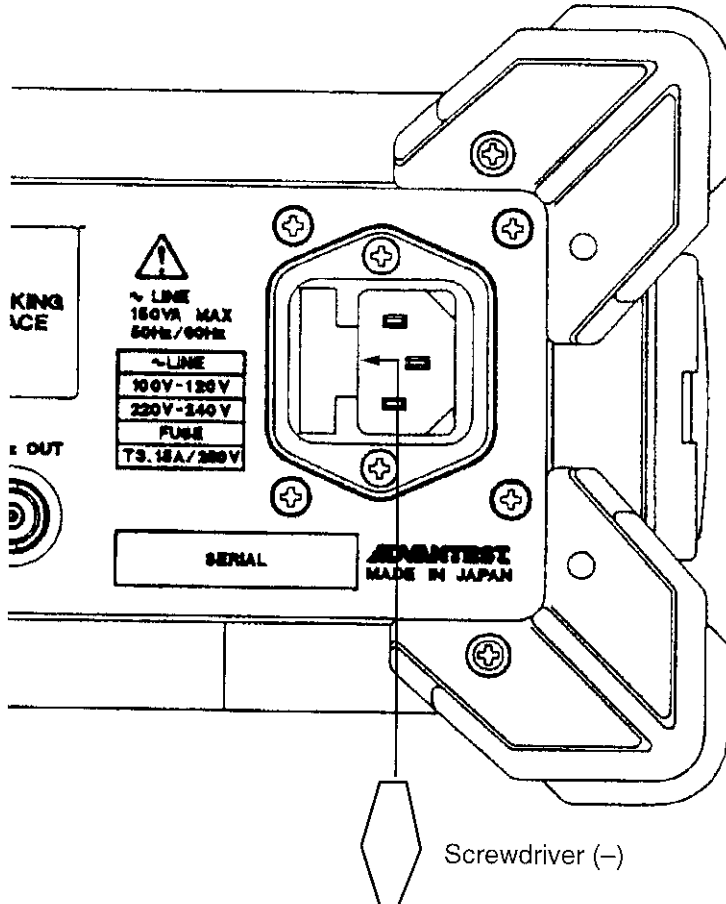

When the cap is removed, the fuse holder extends about 3mm from the rear panel.

- ② Pull out the fuse holder and replace the fuse with a new one.

The fuse holder contains two fuses; the one near the outside is the spare. Use the power fuse conforming to the following specifications.

Input Voltage Range	Fuse
90VAC to 132VAC	T3.15A/250V
198VAC to 250VAC	T3.15A/250V

- ③ Upon completion of fuse replacement, reinsert the fuse holder and fix the cap.



### 1.3.4 Power Cable Connection

**WARNING!**

**1. About the Power Cable**

- *Use only the attached power cable to prevent electrocution and fire.*
- *Make sure that the attached power cable meets the safety standards of your country.*
- *Be sure to turn off the power switch before plugging in the power cable.*
- *Be sure to hold onto the plug portion of the power cable when plugging or unplugging the R3561L.*

**2. About Protective Grounding**

- *Connect the power cable plug to the power supply outlet equipped with a protective ground terminal.*
- *Use of an extension cable without a protective ground terminal is prohibited.*

ADVANTEST provides the power cables for each country. See yellow page of "Table of Power Cable Options" at this manual.

1.4 Precautions in Use

1.4 Precautions in Use

- (1) Before starting the measurement

When turning on the power, don't connect DUT.  
Before starting the measurement, check to see the output power level.

- (2) Removing of case

Do not open the case to one except service man of our company.  
The R3561L has a high temperature part and a high pressure part.

- (3) When abnormality occurs

When smoke rises from the R3561L, smell nastily, or rear unusual sound feel, turn off the power switch. Pull out power cable from the outlet. And contact to our company.  
The address and the telephone number of our company are in the end of this manual.

- (4) Caution in using carrying belt

- Attachment of the belt

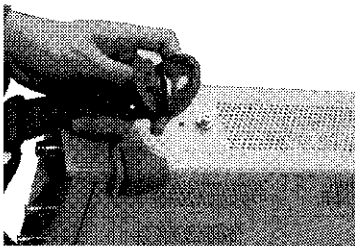

Raise the lever of the belt.

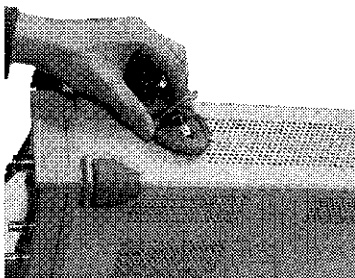

Hang the lever to the projections of the main unit.

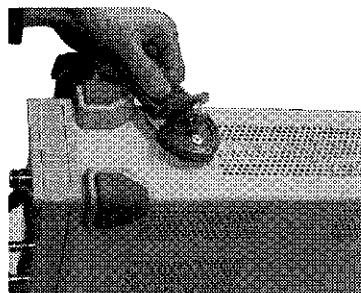

Be careful not to give excessive power to the lever.

Misoperation

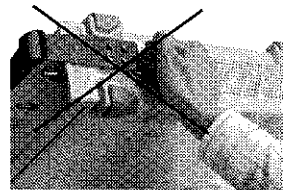

Twisting

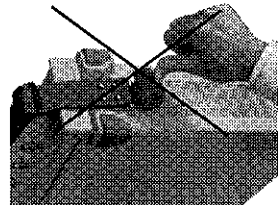

Pushing

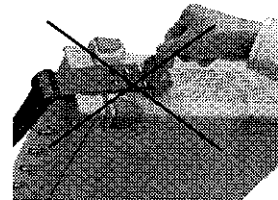

Pulling

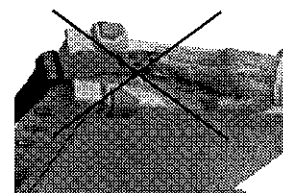

Pushing in

- Check after attaching the belt

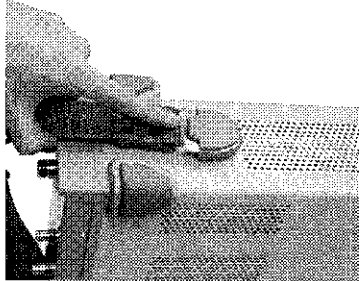

After attaching, make certain of any abnormal rattle or gap.

(5) Electromagnetic interference.

Electromagnetic interference may be caused to the television or the radio. If the R3561L power is turned off and the electromagnetic interference is reduced, then the R3561L has caused the problem.

Prevent electromagnetic interference by the following procedure.

- Change the direction of antenna of the television or the radio.
- Place the R3561L the other side of the television or the radio.
- Place the R3561L away from the television or the radio.
- Use another line of power source for the television or the radio than the R3561L.

(6) Prevention of Electrostatic Buildup

To prevent damages to semiconductor parts from electrostatic discharge (ESD), the precautions shown below should be taken. We recommend that two or more measures be combined to provide adequate protection from ESD. (Static electricity can easily be built up when a person moves or an insulator is rubbed.)

Countermeasure example

- |                         |  |
|-------------------------|--|
| Human body:             | Use of a wrist strap (see Figure 1-2).   |
| Floor in the work area: | Installation of a conductive mat, the use of conductive shoes, and grounding (see Figure 1-3). |
| Benchboard:             | Installation of a conductive mat and grounding (see Figure 1-4).                               |

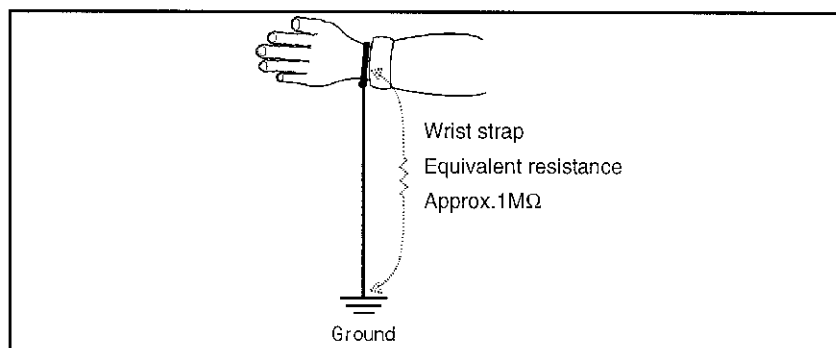

Figure 1-2 Human body

1.4 Precautions in Use

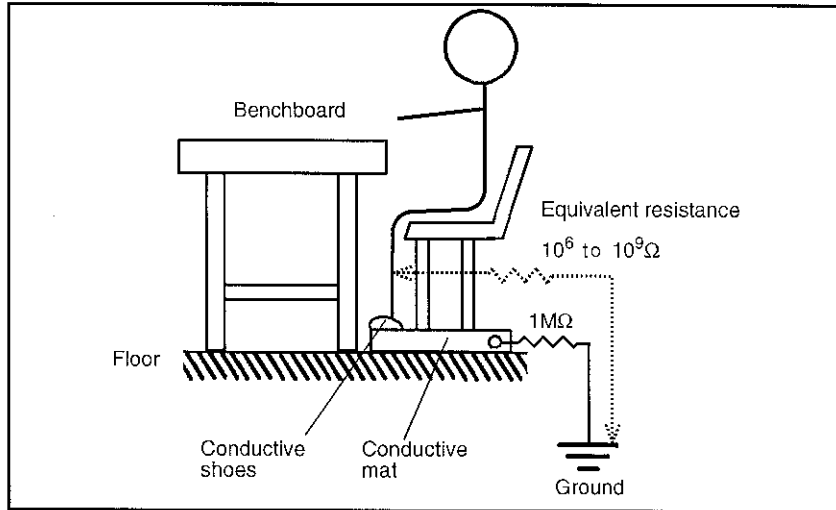

Figure 1-3 Floor in the work area

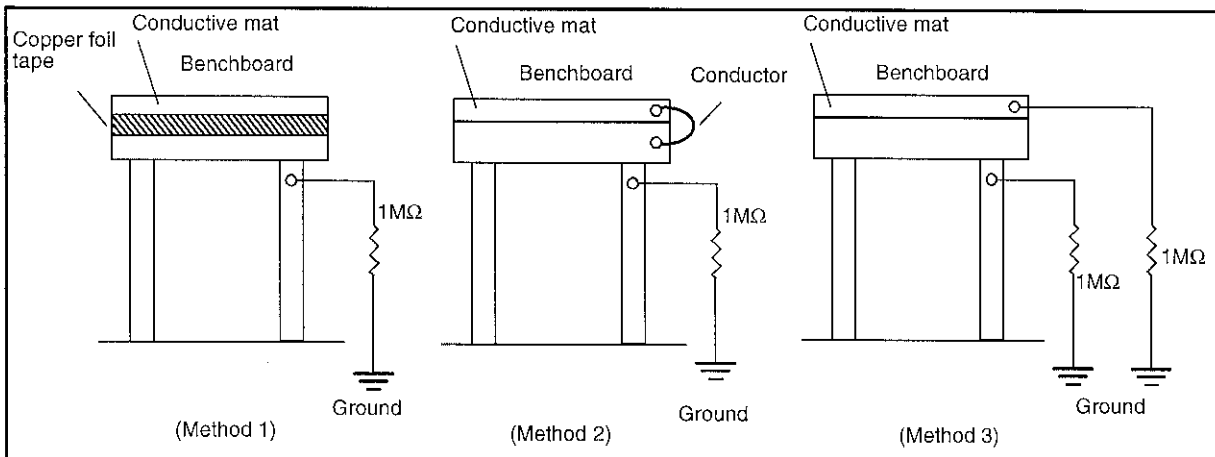

Figure 1-4 Benchboard

## 1.5 Cleaning, Storage, and Transport

### (1) Cleaning

Wipe off dirt on the R3561L with a soft cloth (or a moistened cloth) when necessary. Pay attention to the following points at that time.

1. Use care to completely remove cloth lint and to prevent moisture from entering the unit.
2. Do not use organic solvents (e.g., benzene, acetone) which will damage the surface of the unit.

### (2) Storage

Make sure to store the R3561L in the temperature range from -20°C to +60°C. If this unit is not used for a long period of time, cover with a protective sheet or place in a cardboard box to exclude dust, and store in a dry location without exposure to direct sunlight.

### (3) Transport

Before transportation, pack the R3561L with the original packing material or at least equivalent packing material (cardboard box with thickness of 5mm or more).

<Packing Procedure>

- ① Place the R3561L in the cardboard box by wrapping with a cushioning material.
- ② Next, place the accessories with cushioning material.
- ③ Close the cardboard box, and fix with the packing string.
  - For hand carry  
Use the dedicated transit case, which is available as an optional accessory.

## 1.6 Warm up

After the R3561L temperature has reached the room temperature level, turn the power switch ON and warm it up for 60 minutes.

## 1.7 Calibration

Calibration work should be performed at an ADVANTEST CORPORATION site. When you want to calibrate the R3561L, please contact a sales representative.

Desirable Period	One year
------------------	----------

## 1.8 Replacing Parts with Limited Life

The R3561L uses the following parts with limited life that are not listed in Safety Summary. Replace the parts listed below after their expected lifespan has expired.

Part Name	Life	Description
Output attenuator	2,000,000 times	When the output signal level at the RF OUT terminal is out of specifications, contact ADVANTEST Corp. or our nearest agency for consultation.



## 2 PANEL DESCRIPTION

This chapter describes the components and functions of the R3561L front and rear panels. It also illustrates the standard connections to the R3267, R3463 or R3465.

### 2.1 Front Panel

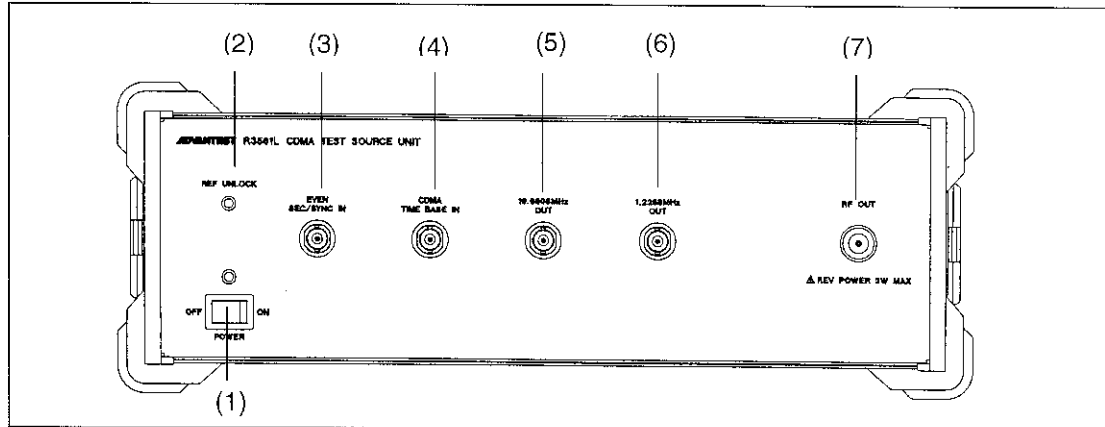

**Figure 2-1 Front Panel**

- |         |                              |  |        |             |            |        |             |                             |        |             |                    |         |             |  |         |              |  |
|---------|------------------------------|--|--------|-------------|------------|--------|-------------|-----------------------------|--------|-------------|--------------------|---------|-------------|--|---------|--------------|--|
| (1)     | Power switch:<br>POWER lamp: | Turn the power ON/OFF.<br>Lit when the power is ON.  |        |             |            |        |             |                             |        |             |                    |         |             |  |         |              |  |
| (2)     | REF UNLOCK lamp:             | Lit when the internal synthesizer reference or CDMA reference frequency is asynchronous.   |        |             |            |        |             |                             |        |             |                    |         |             |  |         |              |  |
| (3)     | EVEN SEC/SYNC IN terminal:   | Inputs the Even Second Clock signal coming from the Base Station.  |        |             |            |        |             |                             |        |             |                    |         |             |  |         |              |  |
| (4)     | CDMA TIME BASE IN terminal:  | Inputs the Time Base signal for CDMA reference synchronization. The following signals are available:<br><table border="0" style="margin-left: 20px;"> <tr> <td>· 1MHz</td> <td>· 1.2288MHz</td> <td>· Internal</td> </tr> <tr> <td>· 2MHz</td> <td>· 2.4576MHz</td> <td>Default selection: Internal</td> </tr> <tr> <td>· 5MHz</td> <td>· 4.9152MHz</td> <td>50Ω, 0dBm to 23dBm</td> </tr> <tr> <td>· 10MHz</td> <td>· 9.8304MHz</td> <td></td> </tr> <tr> <td>· 15MHz</td> <td>· 19.6608MHz</td> <td></td> </tr> </table> | · 1MHz | · 1.2288MHz | · Internal | · 2MHz | · 2.4576MHz | Default selection: Internal | · 5MHz | · 4.9152MHz | 50Ω, 0dBm to 23dBm | · 10MHz | · 9.8304MHz |  | · 15MHz | · 19.6608MHz |  |
| · 1MHz  | · 1.2288MHz                  | · Internal   |        |             |            |        |             |                             |        |             |                    |         |             |  |         |              |  |
| · 2MHz  | · 2.4576MHz                  | Default selection: Internal  |        |             |            |        |             |                             |        |             |                    |         |             |  |         |              |  |
| · 5MHz  | · 4.9152MHz                  | 50Ω, 0dBm to 23dBm   |        |             |            |        |             |                             |        |             |                    |         |             |  |         |              |  |
| · 10MHz | · 9.8304MHz                  |  |        |             |            |        |             |                             |        |             |                    |         |             |  |         |              |  |
| · 15MHz | · 19.6608MHz                 |  |        |             |            |        |             |                             |        |             |                    |         |             |  |         |              |  |
| (5)     | 19.6608MHz OUT terminal:     | Outputs the 19.6608MHz TTL signal (16 x CDMA chip rate).   |        |             |            |        |             |                             |        |             |                    |         |             |  |         |              |  |
| (6)     | 1.2288MHz OUT terminal:      | Outputs the 1.2288MHz TTL signal (CDMA chip rate).   |        |             |            |        |             |                             |        |             |                    |         |             |  |         |              |  |
| (7)     | RF OUT terminal:             | Outputs the RF signal.<br>Frequency range: 50MHz to 2000MHz<br>Level range: -125dBm to +0dBm<br>Max. reversed input power: 2W  |        |             |            |        |             |                             |        |             |                    |         |             |  |         |              |  |

2.2 Rear Panel

2.2 Rear Panel

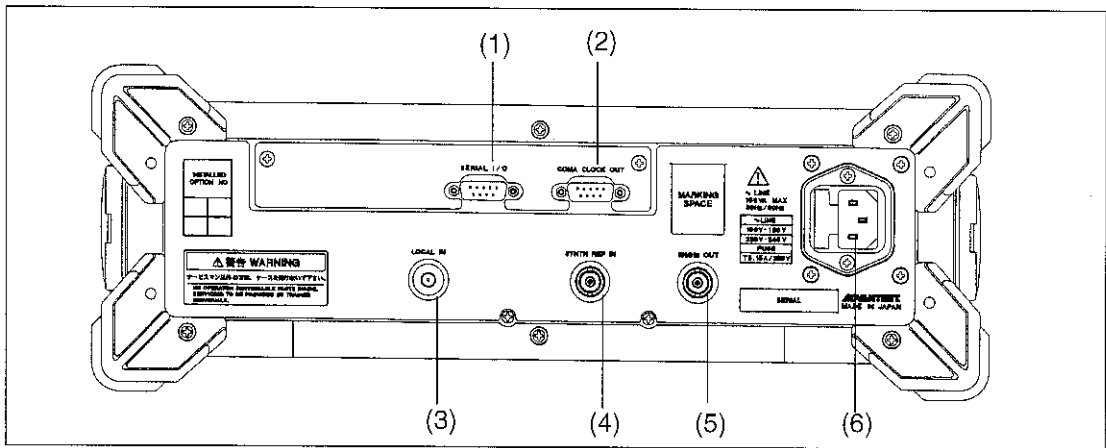
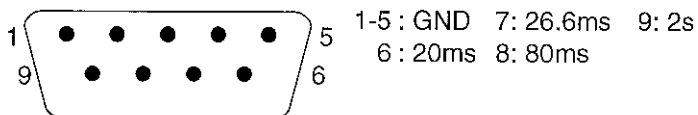

Figure 2-2 Rear Panel

- (1) SERIAL I/O connector: Dedicated interface for control from the ADVANTECH R3267, R3463 or R3465.
- (2) CDMA CLOCK OUT connector:  
Outputs the CDMA frame clock TTL signal of 20ms, 26.66ms, 80ms, or 2s.



- (3) LOCAL IN terminal: Inputs the 1st LOCAL signal coming from the ADVANTECH R3267, R3463 or R3465.
- (4) SYNTH REF IN terminal:  
Inputs the reference signal to the RF synthesizer. The following signals are available.
 

· 1MHz	· 1.2288MHz	· Internal
· 2MHz	· 2.4576MHz	Default selection: 10MHz
· 5MHz	· 4.9152MHz	50Ω, 0dBm to 23dBm
· 10MHz	· 9.8304MHz	
· 15MHz	· 19.6608MHz	
- (5) 10MHz OUT terminal: Outputs the 10MHz signal synchronous with the input to the SYNTH REF.  
Output level:  $\geq 0$ dBm
- (6) AC power connector: 3-pin connector.  
100V to 120V/220V to 240V, 50Hz/60Hz, 150VA or less



## 2.3 Connection to R3267

Connect the R3561L to the R3267 as shown below.

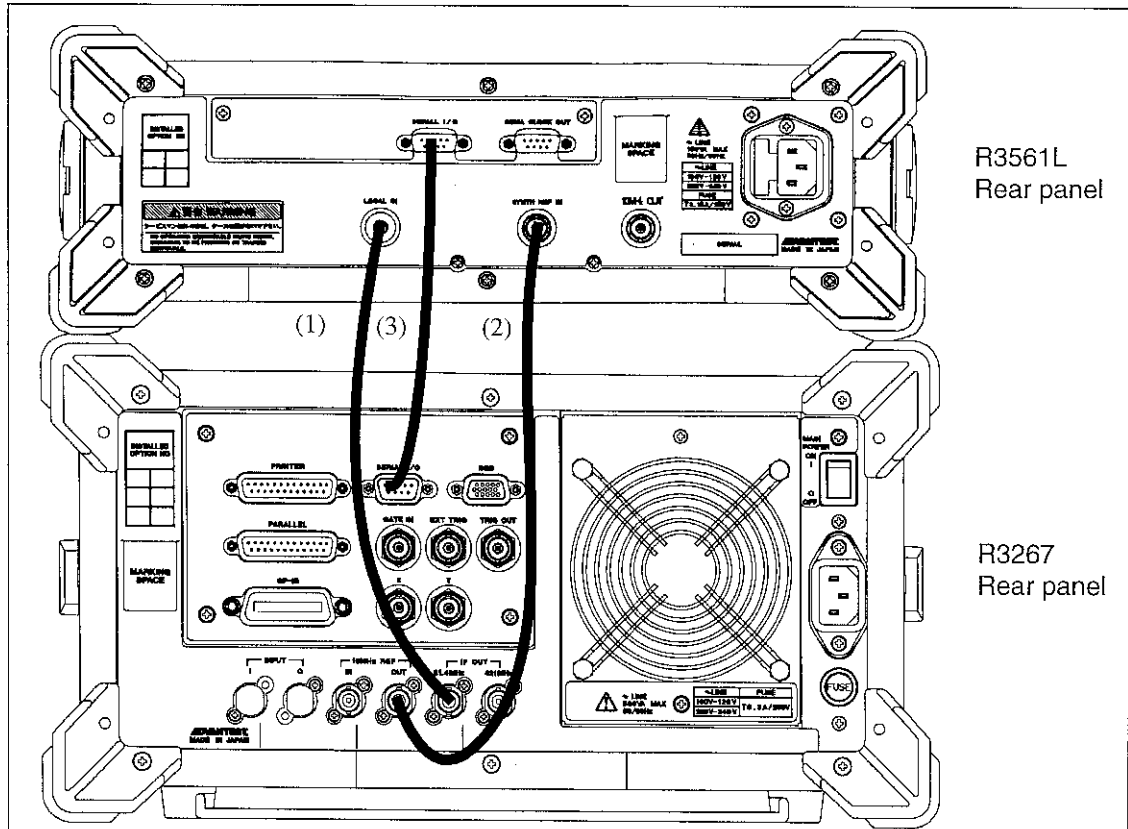

**Figure 2-3 Connection to R3267**

- (1) LOCAL signal connection:  
Use the attached LOCAL cable to connect the R3267 LOCAL OUT terminal and the R3561L LOCAL IN terminal. It supplies the R3267 LOCAL OUT signal to the R3561L.
- (2) Frequency reference connection:  
Use the attached BNC cable to connect the R3267 10MHz REF OUT terminal and the R3561L SYNTH REF terminal. It supplies the R3267 10MHz REF signal to the R3561L.
- (3) Serial interface connection:  
Use the attached serial cable to connect the R3267 SERIAL I/O terminal and the R3561L SERIAL I/O terminal. It enables controlling the R3561L from the R3267.

2.4 Connection to R3463 or R3465

2.4 Connection to R3463 or R3465

Connect the R3561L to the R3463 or R3465 as shown below.

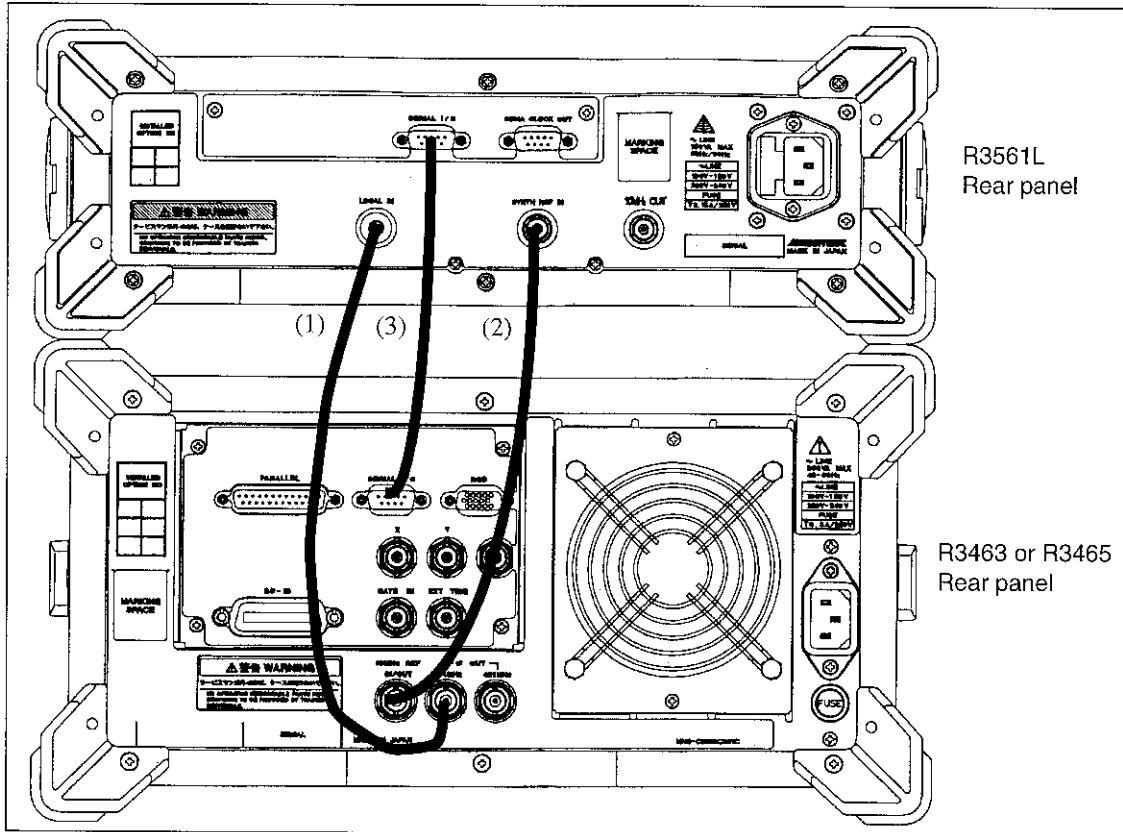

Figure 2-4 Connection to R3463 or R3465

- (1) LOCAL signal connection:  
Use the attached LOCAL cable to connect the R3463 or R3465 LOCAL OUT terminal and the R3561L LOCAL IN terminal. It supplies the R3463 or R3465 LOCAL OUT signal to the R3561L.
- (2) Frequency reference connection:  
Use the attached BNC cable to connect the R3463 or R3465 10MHz REF terminal and the R3561L SYNTH REF terminal. It supplies the R3463 or R3465 10MHz REF signal to the R3561L.  
Note: Set the R3463 or R3465 10MHz Ref setting parameter to internal (INT).
- (3) Serial interface connection:  
Use the attached serial cable to connect the R3463 or R3465 SERIAL I/O terminal and the R3561L SERIAL I/O terminal. It enables controlling the R3561L from the R3463 or R3465.

### 3 OPERATING CONTROL AND FEATURES

The R3561L can be used as the CDMA test source or the tracking generator in combination with the R3267, R3463 or R3465 including OPT 09.

For the CDMA test source, see Section 3.1.

For the tracking generator, see Section 3.2.

**Note 1:** *Key operations and displays in the screen of the R3267 (including OPT 09) are explained in this chapter.*

**Note 2:** *The R3267, R3463 or R3465 panel keys and soft keys are indicated as [ ] and { }, respectively.*

*ex) Panel key:[FREQ ], [SPAN ]*

*Soft key:{Mod ON OFF}, {Setup}*

#### 3.1 CDMA Test Source Control

This section explain how to use the R3561L as the CDMA test source.

Pressing the [ADVANCE] and {CDMA sig} keys in order displays the Setup Status screen (See Figure 3-1) and causes the R3267, R3463 or R3465 to enter the CDMA test source control mode and enables the CDMA test source setup.

##### **CAUTION!**

1. *If the message "SIO port is busy." is displayed after the {CDMA Sig.} key is pressed, execute the following key operation to display the RS232 setting screen.*

*[CONFIG] → {RS232} (for the R3267)*

*[LCL] → {RS232} (for the R3463 or R3465)*

This message is displayed when the R3267, R3463 or R3465 cannot enter the control mode of the CDMA Test Source. Check the Select section within the RS232 setting dialog (see Figure 3-2) to make sure "Rx Control" is selected, so that the R3267, R3463 or R3465 can communicate with R3561L.

2. *The operating procedure depends on the system revision of the R3561L used. For more information, refer to Cautions on Using the R3561L.*

In the control mode of the CDMA Test Source, the soft keys and dialog boxes are used to control the operation. The panel keys available in normal operation mode cannot be used except for the [FREQ], [LEVEL], and their related keys. To return from this mode to the normal R3267, R3463 or R3465 operation mode, press the [POWER] (for the R3267), [CW] (for the R3463 or R3465) or [TRANSIENT] key.

3.1 CDMA Test Source Control

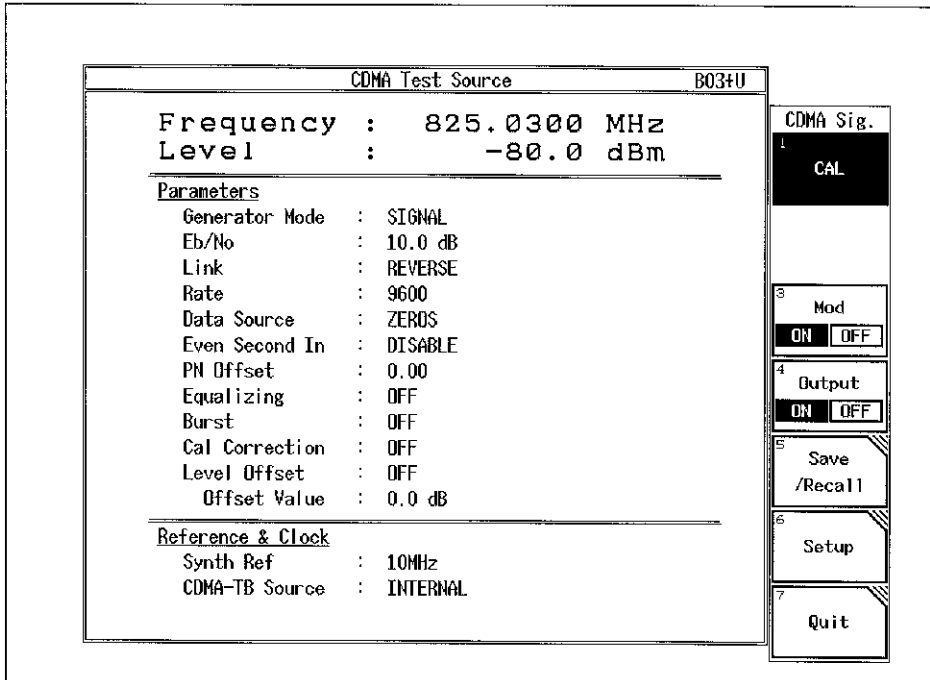

Figure 3-1 Setup Status Screen

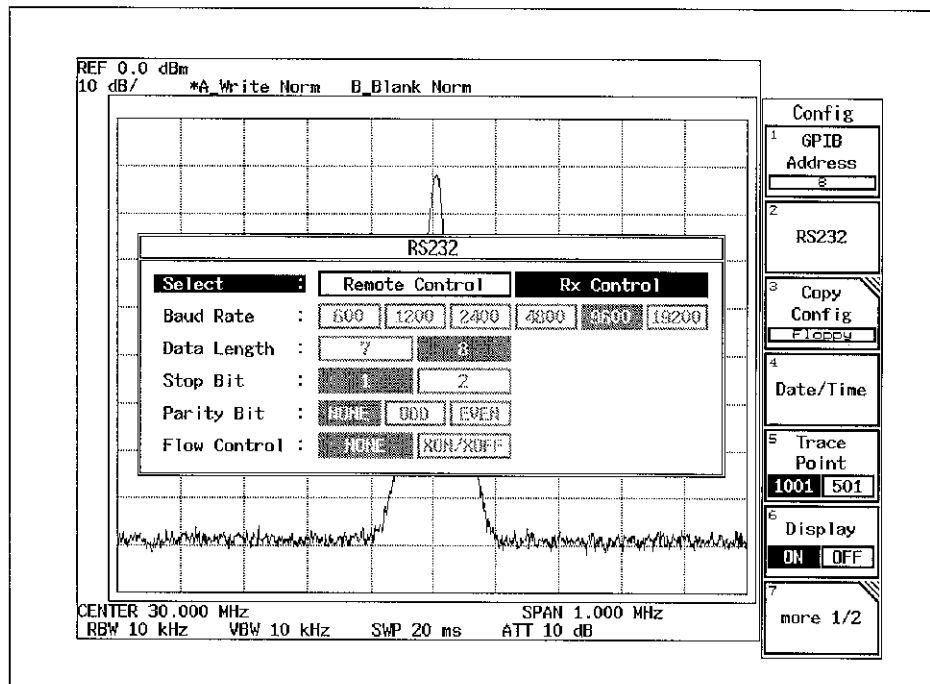
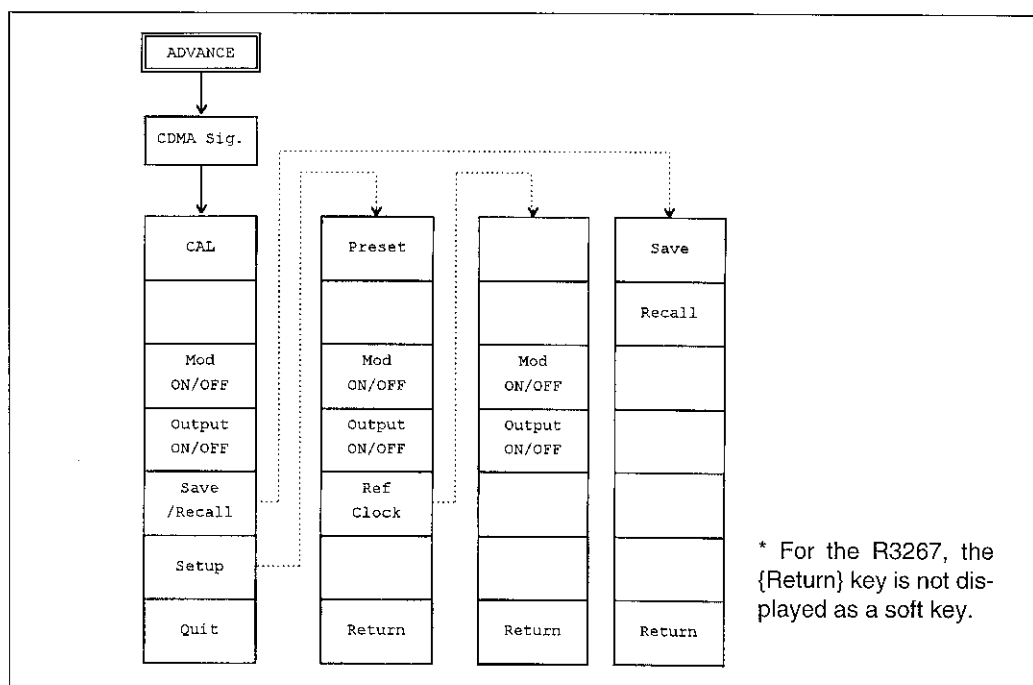

Figure 3-2 RS232 Setting Screen

- Soft key menu list



### 3.1.1 Key Functions

- (1) Output frequency setting

**[FREQ]** : When this key is pressed, the numeric input window is opened in the left lower portion of the screen. The frequency can be set in the range from 10 MHz to 2,300MHz in steps of 1Hz with the [UP]/[DOWN], [DATA KNOB], or number keys. (See Figure 3-3.)

- (2) Output level setting

**[LEVEL]** : When this key is pressed, the numeric input window is opened in the left lower portion of the screen. The output level can be set in the range from -125.0dBm to +6.0dBm in steps of 0.1dB with the [UP]/[DOWN], [DATA KNOB], or number keys. (See Figure 3-3.)

- (3) AWGN Calibration

**{CAL}** : Additive White Gaussian Noise (AWGN) and CDMA signals are calibrated. When you have changed the generator mode to Eb/No, you need to perform this calibration. After calibration, {CAL} is displayed in reverse video. (Figure. 3-3 shows that the calibration has been completed.)

**Note:** The calibration takes 4 to 10 seconds.

3.1 CDMA Test Source Control

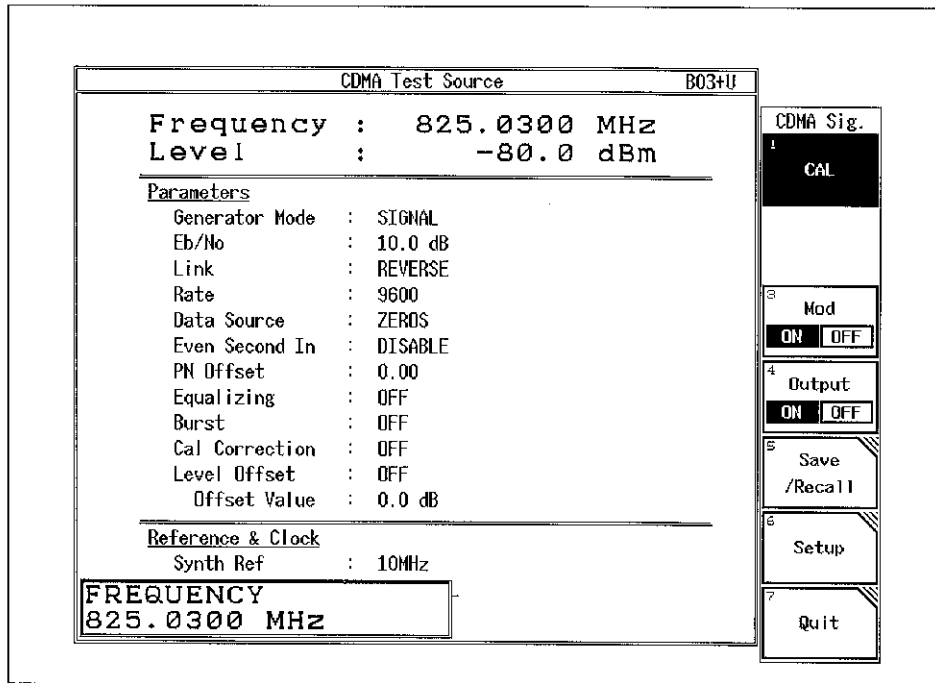

Figure 3-3 Setup Status Screen and Numeric Input Window

- (4) Modulation ON/OFF setting

**{Mod ON OFF}** : Set the output modulation status (see Figure 3-3).  
 ON: Modulated signal  
 OFF: Non-modulated signal

- (5) Output ON/OFF setting

**{Output ON OFF}**: Set the signal output status (see Figure 3-3).  
 ON: Signal is output.  
 OFF: No signal is output.

- (6) System mode setting

**{Setup}** : Set the R3561L operating parameters such as Link.  
 When this key is pressed, the setup dialog box is opened on the screen. Use the [DATA KNOB] and [STEP] keys to select the setting parameter and value; in the same way as other R3267, R3463 or R3465 dialog boxes.

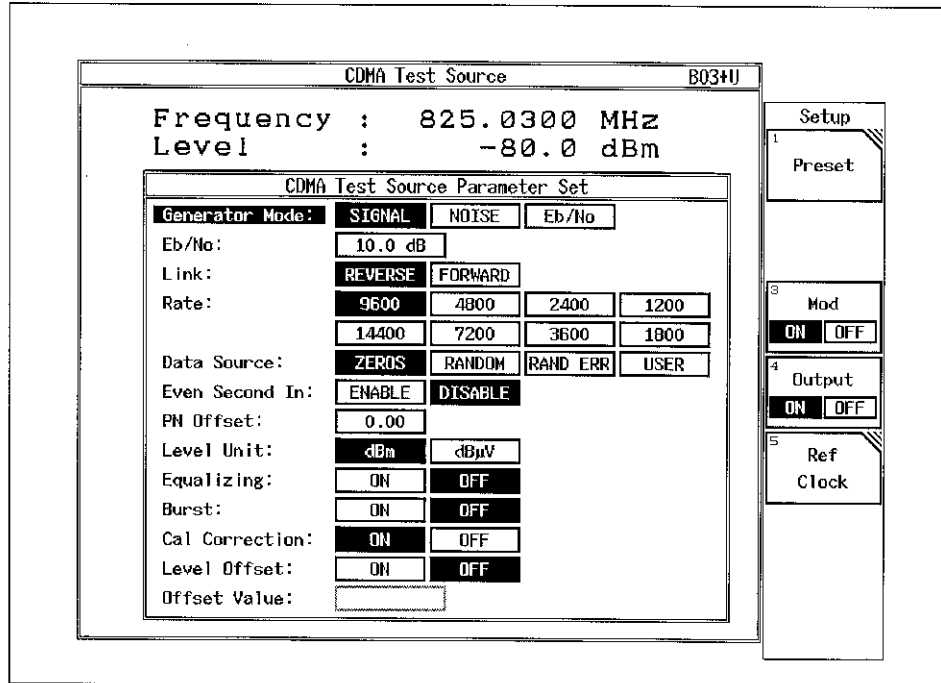

Figure 3-4 Setup Dialog Box Screen

Link: Specify the link direction of the R3561L signal. When this setting is changed, other settings are initialized (see Table 3-1).  
 REVERSE: Outputs the signal in the direction of Mobile Station → Base Station. The modulation method is OQPSK.  
 FORWARD: Outputs the signal in the direction of Base Station → Mobile Station. The modulation method is QPSK.

Table 3-1 Parameters and Values Initialized by Link Setting Change

Parameter	Link Setting	
	REVERSE	FORWARD
Rate	9600	
Data Source	ZEROS	
Even Second In	DISABLE	
PN Offset	0.00	
Equalizing	OFF	ON
Burst	OFF	

3.1 CDMA Test Source Control

- Rate:** Set the R3561L data transfer rate.  
 Select 9600, 4800, 2400, 1200, 14400, 7200, 3600, or 1800 bits/sec.  
 When the Data Source setting is RANDERR, only 9600, 4800, 14400, and 7200 can be selected.
- Data Source:** Specify a data pattern to be input to the Quadrature Spreader of the Base Band for the R3561L. When the Link setting is FORWARD, only ZEROS can be selected. When the Rate setting is other than 9600, 4800, 14400, and 7200, RANDERR cannot be selected.  
**ZEROS:** Selects the data pattern with all 0.  
**RANDOM:** Selects pseudorandom data without a frame error.  
**RANDERR:** Selects pseudorandom data with 2% frame errors added.  
**USER:** Selects the User Defined Buffer data pattern within the Base Band. For the data pattern setting method of this buffer, see Section 3.1.2 'Functions of the User Defined Buffer.'
- Even Second In:** Select whether to activate the Base Band Block of the R3561L in synchronization with the signal of the EVENSEC/SYNC IN terminal in the front panel.  
**DISABLE:** Does not use the Even Second Clock signal. In this case, the R3561L Base Band Block operates using the Even Second signal generated internally.  
**ENABLE:** Uses the Even Second Clock signal. The R3561L Base Band Block operates synchronously with the EVENSEC/SYNC IN terminal signal.
- PN Offset:** Set the PN sequence offset value. This value is internally converted into chip units and set in the PN\_SEQ block of the Base Band section. Since the PN Offset value 1 (PN1 Offset) is equivalent to 64 chips, a value calculated by (Expression 1) is actually set in the PN\_SEQ block of the Base Band section.  

$$N[\text{chip}] = \text{FIX}(64\text{PNs} + 0.5) \cdot \cdot \cdot \cdot \cdot (\text{Expression 1})$$
  - N: Offset value in units of chips set in the PN\_SEQ block.
  - FIX: Converts into an integer by rounding off the decimal number.
  - PNs: A set offset value of the PN sequence.
- Level Unit:** Set the signal level and select the indication unit.  
**dBm:** Sets the level unit to dBm.  
**dB $\mu$ V:** Sets the level unit to dB $\mu$ V<sub>rms</sub>.
- Equalizing:** Set the Equalizing Filter to ON or OFF. If the Link setting is changed, this value is automatically changed (see Table 3-1).  
**ON:** Inserts the Equalizing Filter circuit.  
**OFF:** Bypasses the Equalizing Filter circuit.
- Burst:** Set whether to burst data or not (see Figure 3-5).  
**ON:** Burst data.  
**OFF:** Non-burst data.



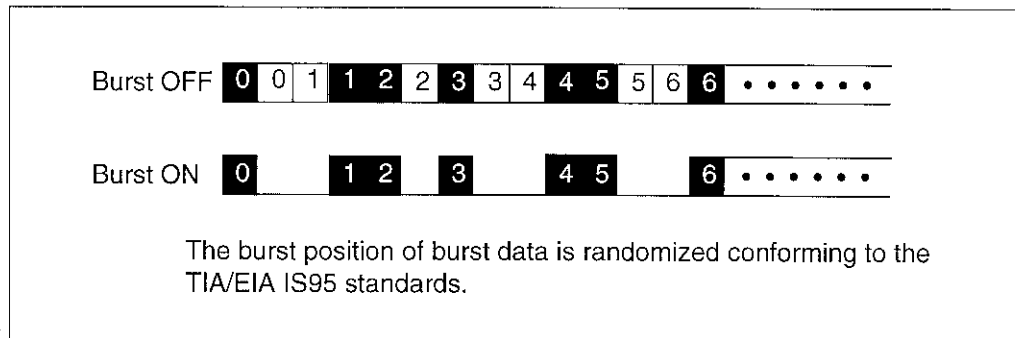

**Figure 3-5 Output Signal With Burst ON/OFF (Case of Rate 7200 (4800) bits/sec)**

**Generator Mode:** Selects the input signal that is applied to the IQ-Modulator of the MOD/ CONV block from the following menus.

**SIGNAL:** A source signal.

**NOISE:** An AWGN output with a bandwidth of 2MHz.

**Eb/No:** A source signal mixed with an AWGN output.

The ratio between the source signal and the AWGN signal can be changed in the Eb/No menu shown in the next line.

**Eb/No:** Sets the ratio between information bit energy and noise spectral density. To set this, select Eb/No in the GeneratorMode menu. The setting range is from 0.0 dB to 15.0 dB in 0.1 dB steps.

**Note:** Eb : Information bit energy No : noise spectral density  
Eb/No is given with the data rate of 9600bps.

**Cal Correction :** Selects whether or not the correction values obtained after using AWGN calibration are used.

**ON:** Correction values are used.

**OFF:** Default values are used.

**Level Offset:** Turns the level offset on or off.

**ON:** The level offset becomes effective.

**OFF:** The level offset becomes ineffective.

**Offset Value:** Sets a level offset value.

The output level  $L_m$  of the RF terminal is

$$L_m = L + L_{\text{offset}}$$

Where  $L$  is the output level and  $L_{\text{offset}}$  is the level offset.

This setting become effective when the level offset is turned on.

The level offset ( $L_{\text{offset}}$ ) must satisfy the range defined as

$$-125.0 \text{ [dBm]} \leq L + L_{\text{offset}} \leq +6.0 \text{ [dBm]}.$$

3.1 CDMA Test Source Control

(7) Preset key

**{Setup}** → **{Preset}** : Initializes the R3561L (factory settings). (See Table 3-2.)

**Table 3-2 R3561L Initial Setting Status**

Item	Initial Value
Output frequency	825.030 [MHz]
Output level	-80.0 [dBm]
Modulation ON/OFF	ON
Output ON/OFF	ON
Generator mode	Signal
Eb/No	+10.0 [dB]
Link	REVERSE
Rate	9600 [bit/sec]
Data Source	ZEROS
Even Second In	DISABLE
PN Offset	0.00
Level Unit	dBm
Equalizing	OFF
Burst	OFF
Level Offset ON/OFF	OFF
Level Offset value	0.0 [dB]
Synthe Ref	10 [MHz]
CDMA TB	INTERNAL

(8) Ref Clock key

**{Setup} → {Ref Clock}**: Set the reference clock of the RF-SYNTHESIZER REFERENCE circuit and CDMA-TIMEBASE circuit (REFERENCE section) in the R3561L (see Figure 3-6). Both reference clocks can be externally input. If the set value is not synchronous with the clock value input externally, the REF UNLOCK lamp LED is lit on the front panel.

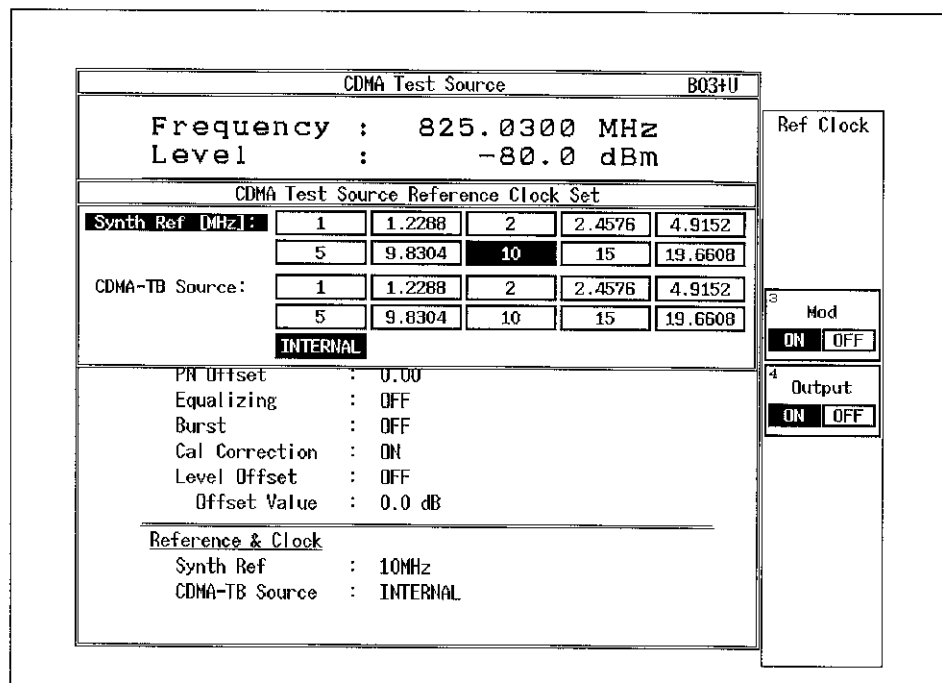

Figure 3-6 Reference Clock Dialog Box Screen

**Synth Ref:** Select the reference clock input to the RF-SYNTHESIZER REFERENCE circuit. Set the frequency corresponding to the clock input to the SYNTH REF IN terminal. Normally, the 10 MHz REF IN connector on the R3267 or the 10MHz REF IN/OUT connector on the R3463 or R3465 is connected to the SYNTH REF IN terminal on the R3561L.

**CDMA-TB Source:** Select the reference clock input to the CDMA-TIMEBASE circuit. Select whether to use the clock generated in the RF-SYNTHESIZER REFERENCE circuit (: INTERNAL) or an external signal input from the CDMA TIMEBASE IN terminal as the reference clock. When the external input signal is used as the reference clock, set the frequency corresponding to the clock to be input.

3.1 CDMA Test Source Control

(9) Save/Recall key

**{Save/Recall}** : Displays the screen for saving/recalling current setting data.

(10) Save key

**{Save/Recall}** → **{Save}** : Activates the function of saving the current settings to R3561L backup memory. When this key is pressed, the R3561L backup memory content is displayed (see Figure 3-7). Select the file No. using the [DATA KNOB] key, and press the [DATA KNOB] or **[ENTER]** key to save the current settings. Maximum 10 settings can be stored in backup memory.

(11) Recall key

**{Save/Recall}** → **{Recall}**: Activates the function of reading settings from R3561L backup memory and changing the current settings. When this key is pressed, the R3561L backup memory content is displayed. Select the file No. using the [DATA KNOB] key, and press the [DATA KNOB] or **[ENTER]** key to read the current settings from backup memory to change the current settings.

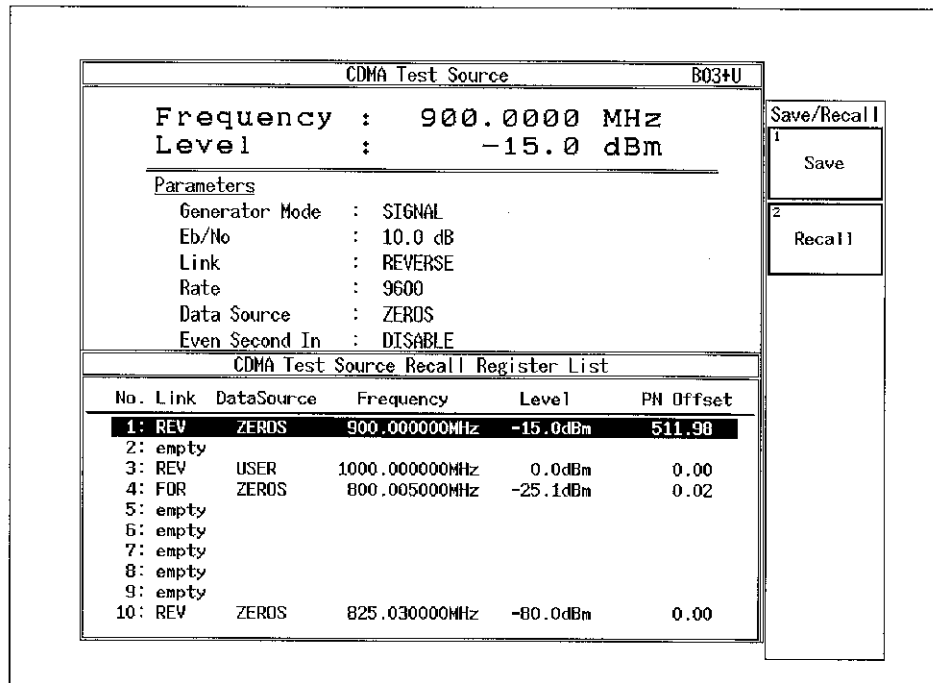

Figure 3-7 Save/Recall Screen

### 3.1.2 Functions of the User Defined Buffer

This section describes the functions of the User Defined Buffer provided in the R3561L. These functions are operated via the GPIB interface (cannot be operated from the R3561L control screen).

**CAUTION!**

*The specifications for the R3561L depend on their system revisions.  
For more information, refer to Cautions on Using the R3561L.*

(1) About the User Defined Buffer

The User Defined Buffer is used to write Data Source information bits (data patterns). This buffer can contain a maximum of 600 frames. Information bits can be written in units of one (1) frame via the Transfer Buffer (see Figure 3-8).

All frames in the User Defined Buffer consist of the Control bits Block (8 bits), Traffic channel information bits Block (bit length variable depending on the data transfer rate), and Tail bits Block (bit length variable depending on the data transfer rate). The bit length of a frame varies depending on the data transfer rate (see Figure 3-9). The following describes each block.

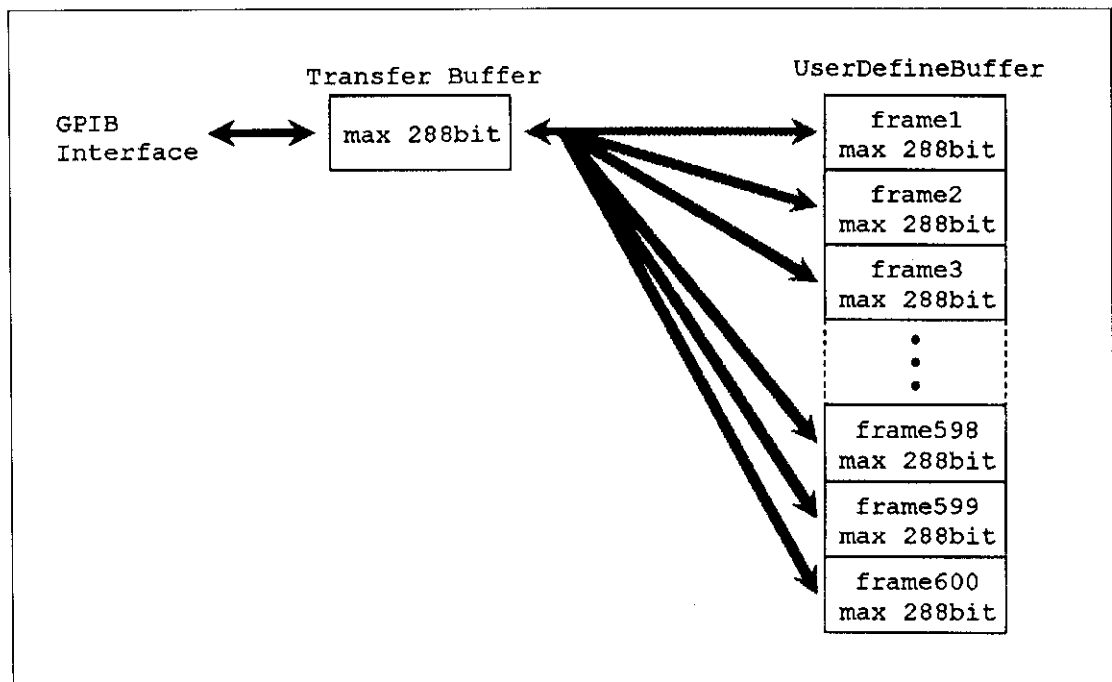

Figure 3-8 Relationship Between Transfer Buffer and User Defined Buffer

3.1 CDMA Test Source Control

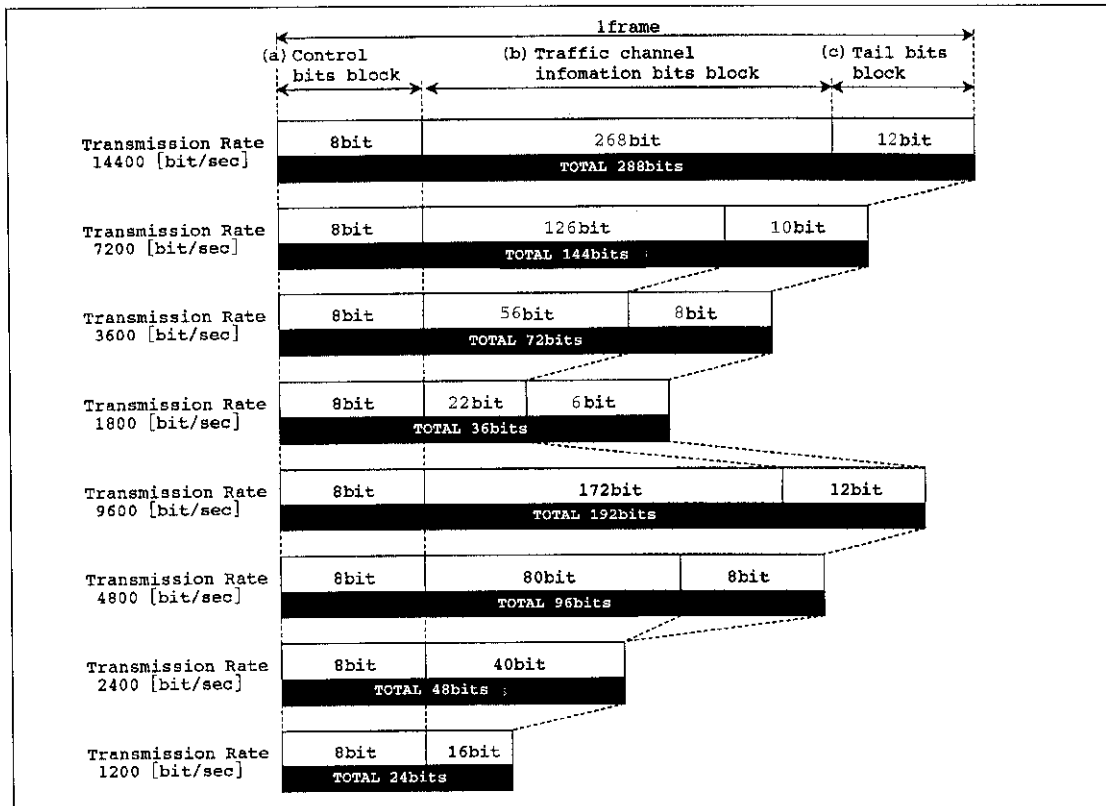

Figure 3-9 Transfer Rate and User Defined Buffer Frame Configuration

- (a) Control Bits Block: Consists of 8 bits used to control the Base Band coder. This block is used for R3561L internal control and is not used for output signals. Figure 3-10 shows the function of each bit in this block.

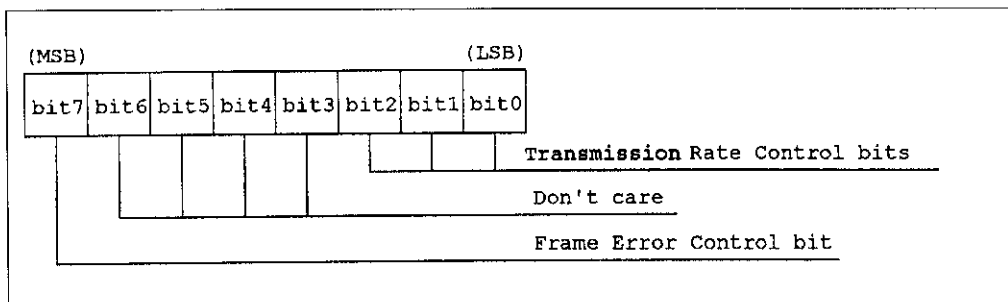

Figure 3-10 Control Bits Block

Frame Error Control bit: Specifies whether to calculate CRC using a value of the Traffic Channel Information Bits Block or to set CRC to zero.

- 1: Sets CRC to zero.
- 0: Calculates CRC using a value of the Traffic Channel Information Bits Block.

Transmission Rate Control bits: Specify the data transfer rate of the Traffic Channel Information Bits Block. The value specified by the Transmission Rate Control bits must be the same as the Rate setting value of the system mode settings. Since there is no interlocking between the Transmission Rate Control bits and the Rate setting of the system mode settings, correct either value in the case of different values.

Data transfer rate	Bit 2	Bit 1	Bit 0
9600 bits/sec	0	0	0
4800 bits/sec	0	0	1
2400 bits/sec	0	1	0
1200 bits/sec	0	1	1
14400 bits/sec	1	0	0
7200 bits/sec	1	0	1
3600 bits/sec	1	1	0
1800 bits/sec	1	1	1

- (b) Traffic Channel Information Bits Block: Contains an output signal data pattern.
- (c) Tail Bits Block: Consists of space added to match the bit length which the Base Band coder can handle. Writing data to this block can be omitted. In the same way as Control Bits Block data, this block is used for R3561L internal control and not used for the output signal.

(2) Output Control of the User Defined Buffer

For output control of the User Defined Buffer, set the start frame No. and specify the output frame count (the number of frames to output) from the start frame. To output from frame 3 to frame 6, specify 3 for the start frame No. and 4 for the output frame count (see Figure 3-11). However, the start frame No. and output frame count must meet the following condition.

$$1 \leq \text{Start frame No.} + \text{Output frame count} - 1 \leq 600$$

The User Defined Buffer output is activated by setting Data Source of the system mode settings to USER.

3.1 CDMA Test Source Control

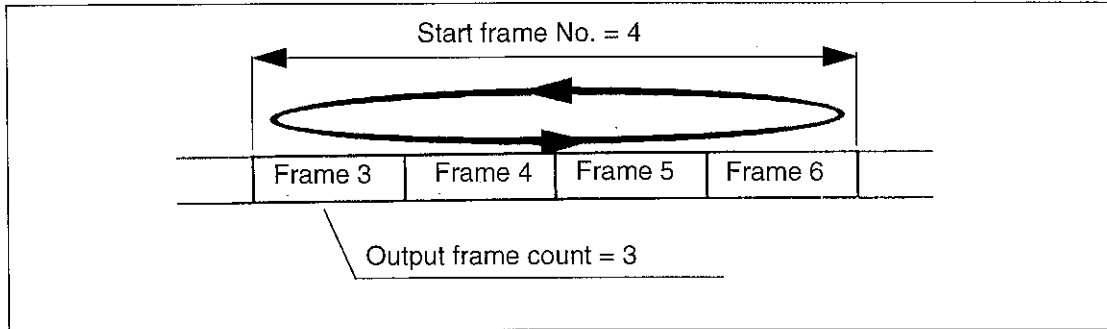

Figure 3-11 Start Frame No. and Output Frame Count



### 3.2 Tracking Generator Control

This section explains how to use the R3561L as a tracking generator (TG).

Pressing the [ADVANCE] and {R3561L TG} keys in order causes the R3267, R3463 or R3465 to enter the tracking generator control mode and enables the tracking generator setup.

**CAUTION!**

1. If the message "SIO port is busy." is displayed after the {R3561L TG} key is pressed, execute the following key operation to display the RS232 setting screen.

[CONFIG] → {RS232} (R3267)

[LCL] → {RS232} (R3463 or R3465)

*This message is displayed when the R3267, R3463 or R3465 cannot enter the control mode tracking generator. Check the Select section within the RS232 setting dialog (see Figure 3-2) to make sure "Rx Control" is selected, so that the R3267, R3463 or R3465 can communicate with R3561L.*

2. The operating procedure depends on the system revision of the R3561L used. For more information, refer to Cautions on Using the R3561L.

- Soft key menu list

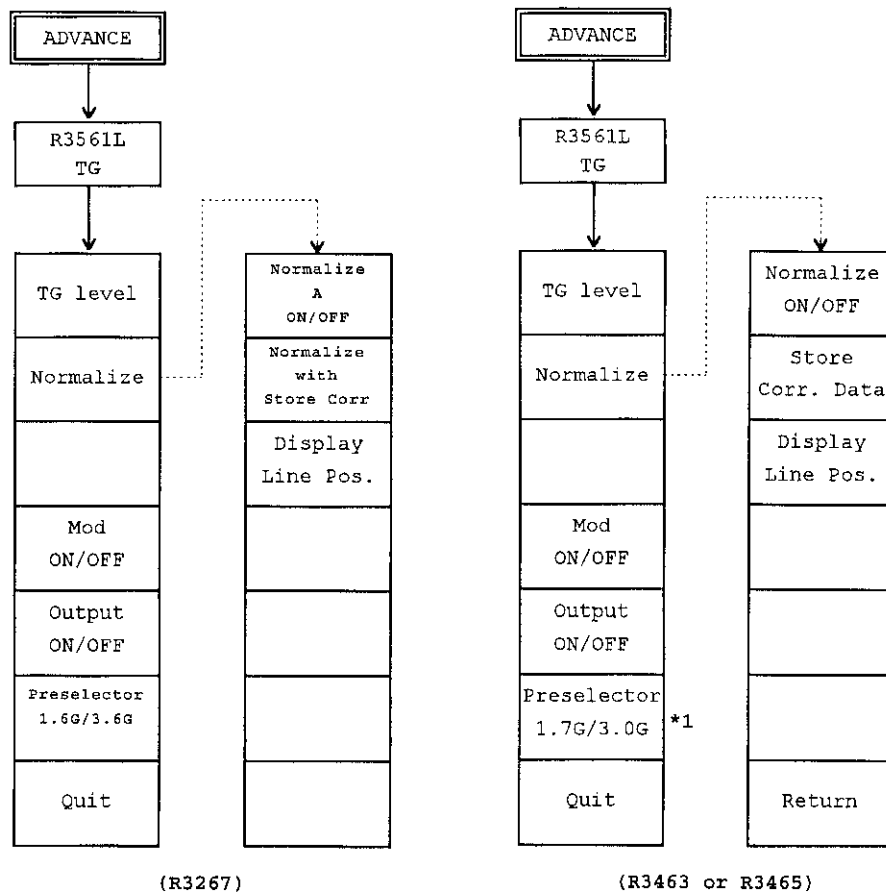

\*1:For the R3465 only

### 3.2 Tracking Generator Control

#### 3.2.1 Key Functions

- (1) TG Level
  - {TG level}** : Sets the TG output level.  
The TG output level can be set from +6.0 to -125.0 [dBm] in 0.1 [dB] steps.
  
- (2) Normalizing
  - {Normalize}** : The normalizing soft-key menu is displayed.  
Normalization is to compute the waveform traced.  
This mode displays the input signal minus the correction data stored in memory plus the vertical reference level.  
The DISPLAY LINE value is used for the vertical reference level.  
The normalized waveform is calculated according to the equation given as  
Normalized Waveform = Input Signal -Correction Data + DISPLAY LINE value
  
- (3) Turning normalization on or off.
  - {Normalize}** → **{Normalize A ON OFF}** (R3267)
  - {Normalize}** → **{Normalize ON OFF}** (R3463 or R3465):  
When selecting ON, the Display Line is displayed in the middle of maximum and minimum values to show the normalization reference level. Then, the input signal is normalized with the correction data obtained through the Store Correction Data operation.  
If the Display Line has been displayed before selecting ON, the existing Display Line level will be effective.  
When selecting OFF, the WRITE mode is activated.
  
- (4) Storing Correction Data
  - {Normalize}** → **{Normalize with Store Corr}** (R3267)
  - {Normalize}** → **{Store Corr. Data}** (R3463 or R3465):  
The Store Correction Data function stores the currently-displayed waveform data into memory as correction data. After storing the data, the R3267, R3463 or R3465 automatically starts to normalize the input signal. The R3267, R3463 or R3465 keeps the stored data in memory even if it is turned off.
  
  - Note: The SAVE/RECALL function of the R3267, R3463 or R3465 is useful for changing and using a variety of correction data settings with the normalizing measurement.

- (5) Setting the DISPLAY LINE position  
**{Normalize}** → **{Display Line Pos.}**:  
 Sets the DISPLAY LINE position to be used for normalization.  
 The DISPLAY LINE position is the reference for normalization.
- (6) Setting modulation on or off  
**{Mod ON OFF}** : Specifies whether the TG output is modulated. When performing TG, select **{Mod OFF}** not to modulate the TG output.  
 ON: Modulated signal  
 OFF: Non-modulated signal
- (7) Setting the output state  
**{Output ON OFF}** : Set the signal output status  
 ON: Signal is output.  
 OFF: No signal is output.
- (8) Setting the preselector operating frequency  
**{Preselector 1.6G 3.6G}** (R3267)  
**{Preselector 1.7G 3.0G}** (R3465):  
 Set the lower frequency limit of the preselector.

**Note 1:** When the TG is being used for measurements, the lower frequency limit of the preselector must be 3.6 GHz (for the R3267) or 3.0 GHz (for the R3465).  
 Set **{Preselector 3.6G}** (for the R3267), or **{Preselector 3.0G}** (for the R3465).

**Note 2:** The R3463 is not equipped with a preselector. Accordingly the **{Preselector 1.7G 3.0G}** key is not displayed.

**Note 3: Sweep Time**  
 Sets the sweep time for the span frequency. The appropriate sweep time for the span frequency is listed in the table shown below.

**Suitable Combination between Span Frequency and Sweep Time**

Span Frequency	Sweep Time	Remarks
SPAN $\geq$ 100MHz	$\geq$ 2sec	Manual sweep time setup
SPAN $\geq$ 10MHz	$\geq$ 1sec	
SPAN < 10MHz	Automatic sweep time setup	

**Note 4:** When tuned by the LOCAL OUT signal from the R3267, the output frequency from the R3561L is output with an offset of +20.5 kHz. As a result, the displayed level is decreased if an RBW less than 300 kHz is used. Use an RBW of 300 kHz or higher to prevent the level from being decreased when the TG is being used.  
 Figure 3-12 shows a typical relationship between the RBW and TG level error when used with the R3267.

3.2 Tracking Generator Control

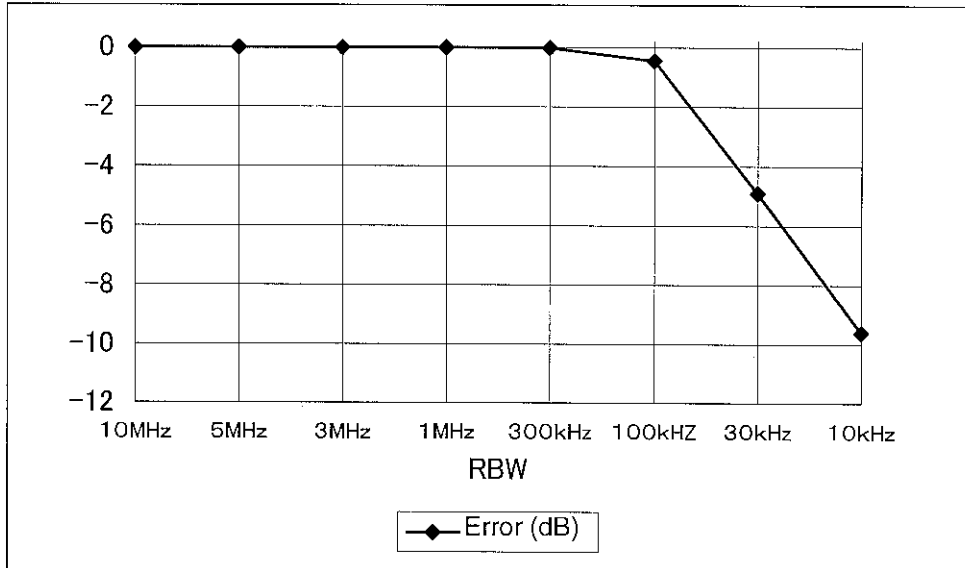

Figure 3-12 Relationship between the RBW and TG Level Error (Typical values when Used with the R3267)

## 4 GPIB

This chapter explains the GPIB command syntax (description) and the GPIB sample programs.

### 4.1 GPIB Command Syntax (Description)

A GPIB command consists of a header, a space (which is the delimiter between the header and the data) and data in that order. Addition of a question mark (?) after the header enables generating a query command (see Figure 4-1).

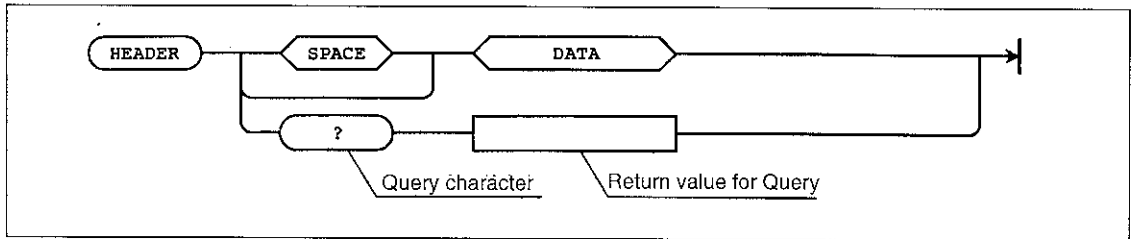
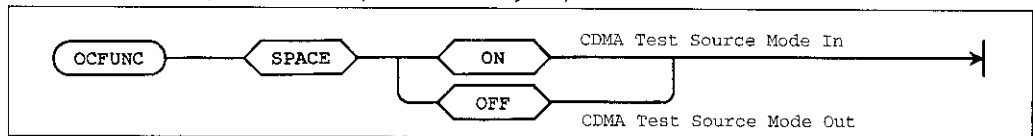

Figure 4-1 GPIB Command Syntax

#### 4.1.1 Control Command of the CDMA Test Source

##### (1) Control Mode IN/OUT Change Command

Changes control mode to IN or OUT. To control the CDMA Test Source, the mode must be set to Mode IN (ON). When the control mode is set to Mode OUT (OFF), the R3267, R3463 or R3465 (modulation spectrum analyzer) can be controlled.



**Note:** For the R3267, Mode In (ON) is available only in the SPA mode.

##### (2) Output Frequency Setting Command

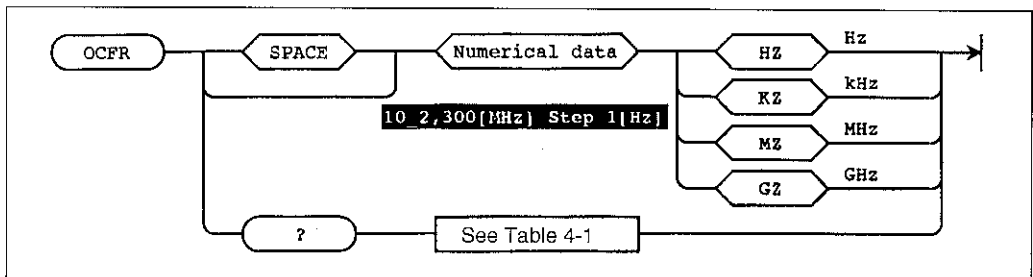

##### (3) Output Level Setting Command

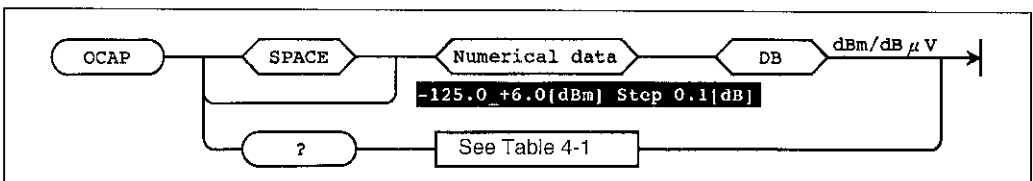

The output level unit specified by Level Unit setting is effective both for this level setting and query.

4.1 GPIB Command Syntax (Description)

(4) Modulation ON/OFF Setting Command

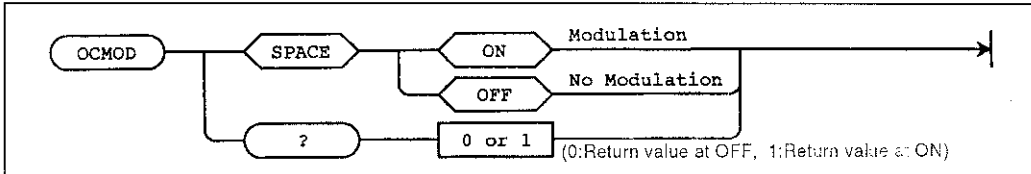

(5) Output ON/OFF Setting Command

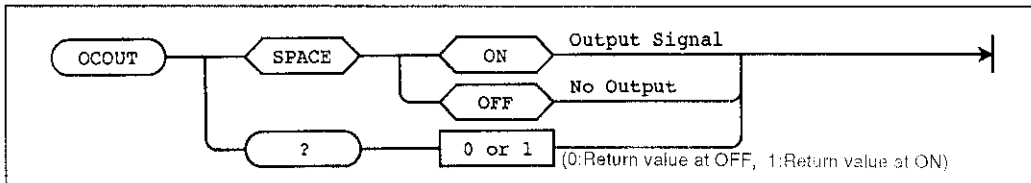

(6) Link Setting Command

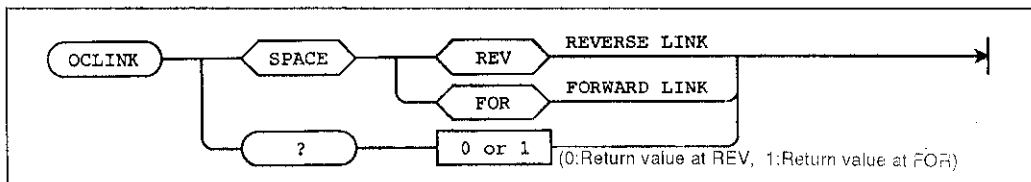

(7) Rate Setting Command

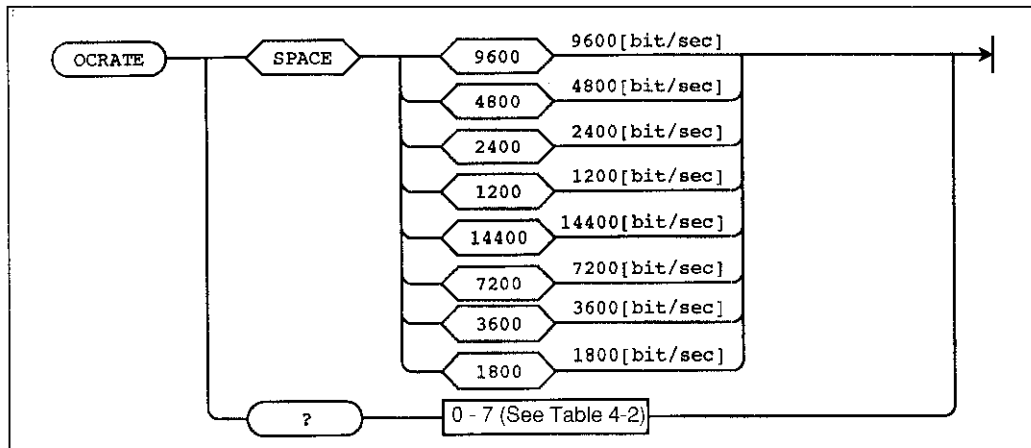

(8) Data Source Setting Command

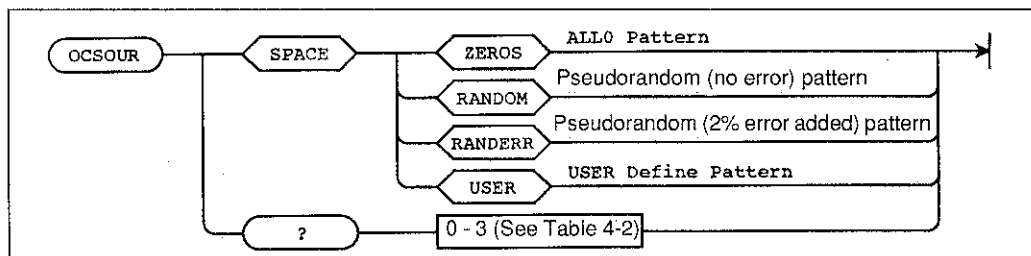

4.1 GPIB Command Syntax (Description)

(9) Even Second In Setting Command

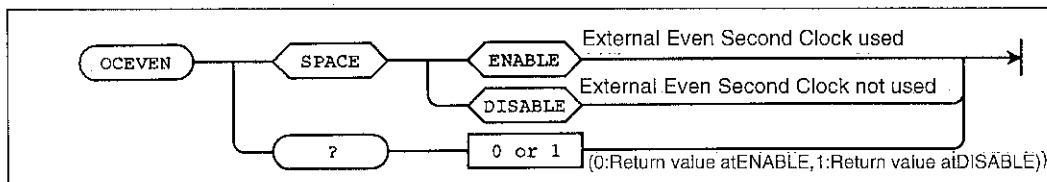

(10) PN Offset Setting Command

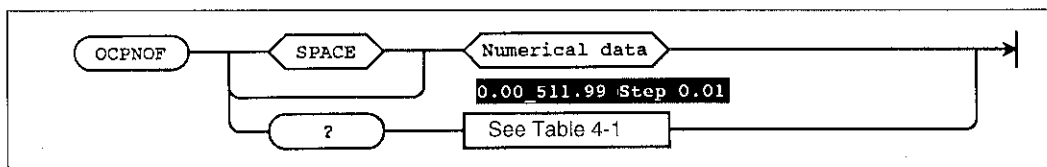
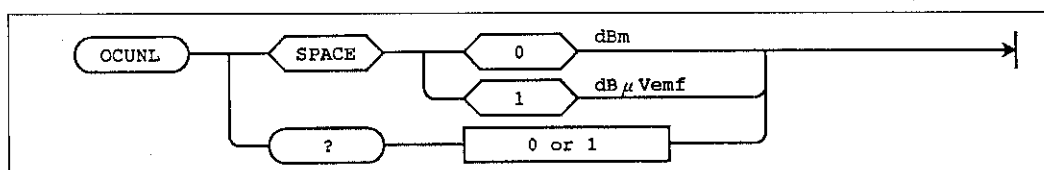

Table 4-1 Numeric Data Output Format

Item	Output Format	Units
Output frequency setting	±D.DDDDDDDDDDDDD±D	Hz
Output level setting		dBm or dB $\mu$ Vemf (specified by Level Unit setting)
PN Offset setting		None
Eb/No setting		dB
Level Offset value setting		dB
Display Line value setting		

(11) Level Unit Setting Command



(12) Equalizing Filter Setting Command

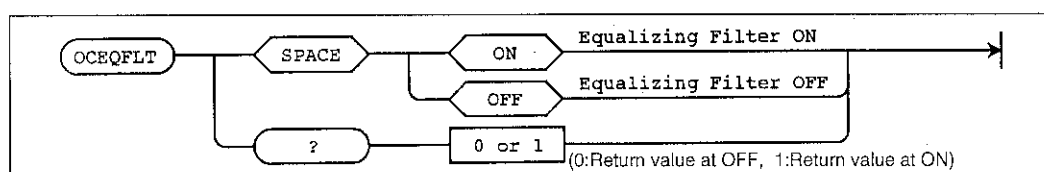

4.1 GPIB Command Syntax (Description)

(13) Burst Setting Command

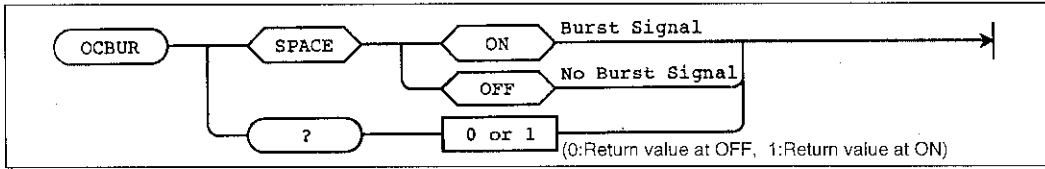

(14) Preset (initialization) Command



(15) Ref Clock Setting (Reference Clock Selection) Command

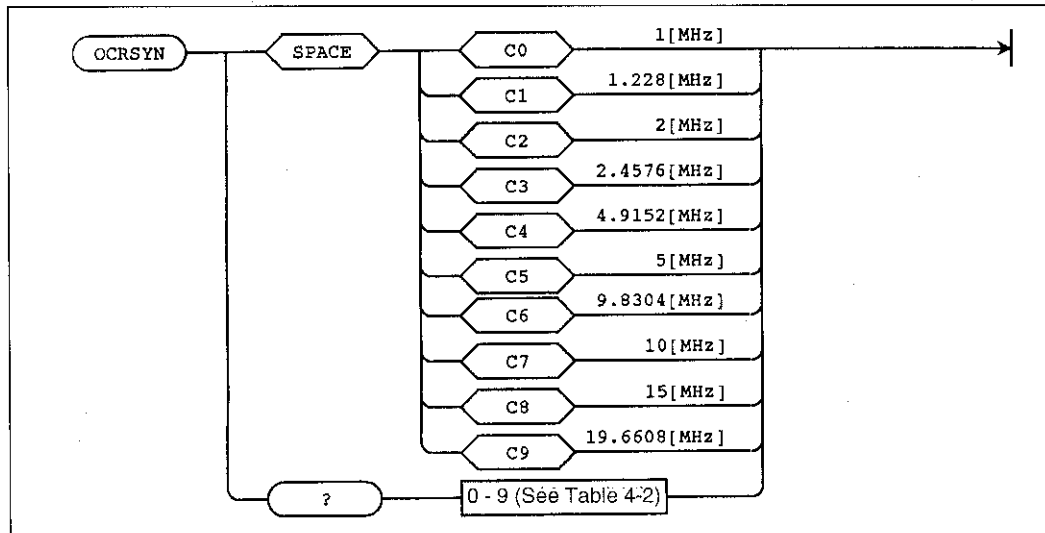



(16) CDMA TB Setting (DCMA Time Base Clock Selection) Command

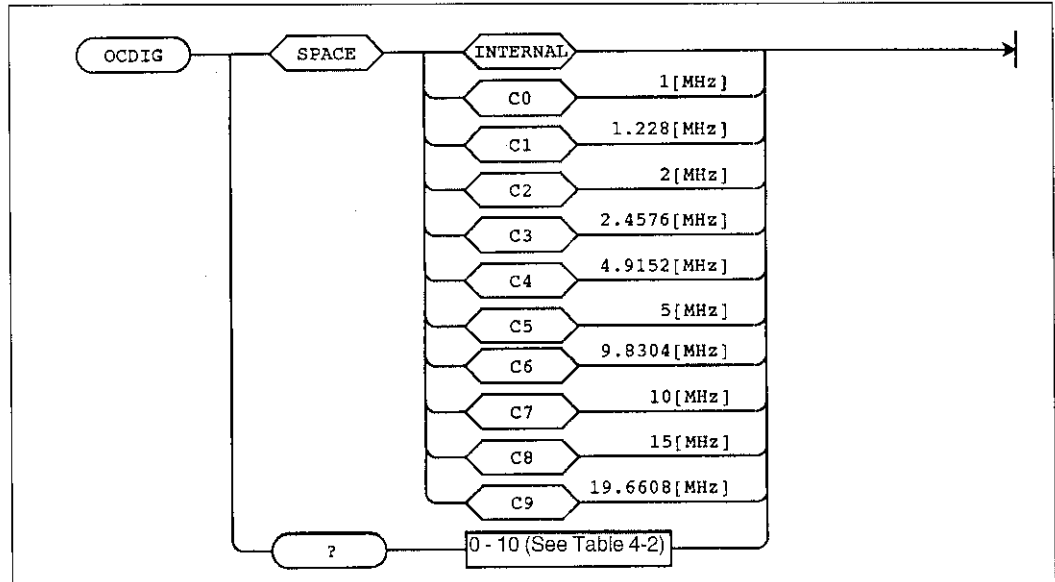

(17) Save/Recall Related Commands

- Command to save the current settings to backup memory by specifying the memory No.

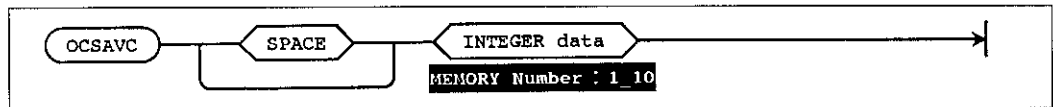

- Command to recall the settings from backup memory by specifying the memory No.

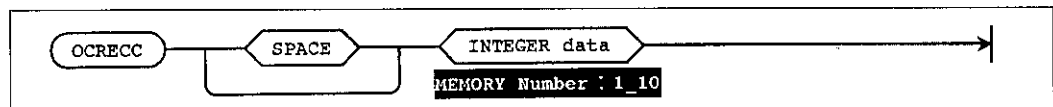

(18) User Defined Buffer Related Commands

- Edit Frame Specification Command  
Specifies the frame No. for data write/read. The target frame must be specified with this command before the Frame Data Edit Command is issued.

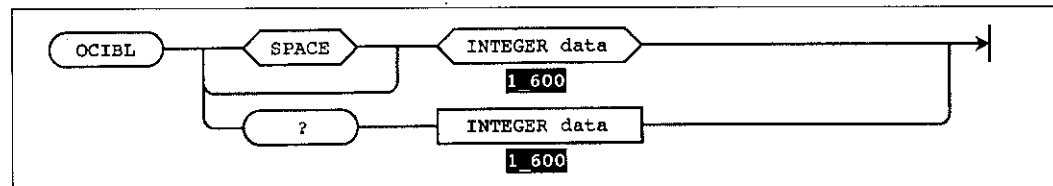

4.1 GPIB Command Syntax (Description)

- Frame Data Edit Command

Writes/reads data of a single frame. The frame subject to data write/read must be specified by the Edit Frame Specification Command.

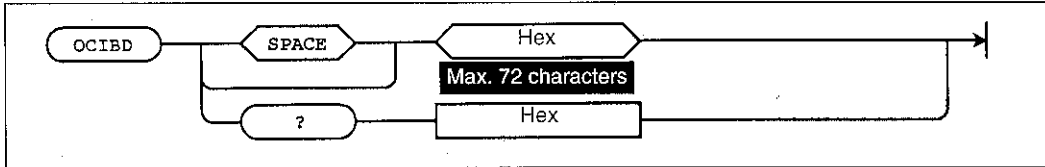

- Start Frame Specification Command

Specifies the start frame No. of data output.

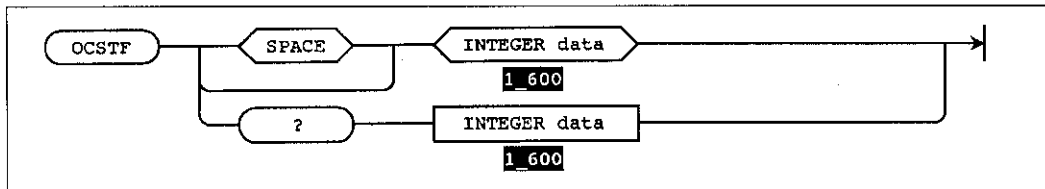

- Output Frame Count Specification Command

Specifies the number of output frames counted from the start frame specified by the Start Frame Specification Command.

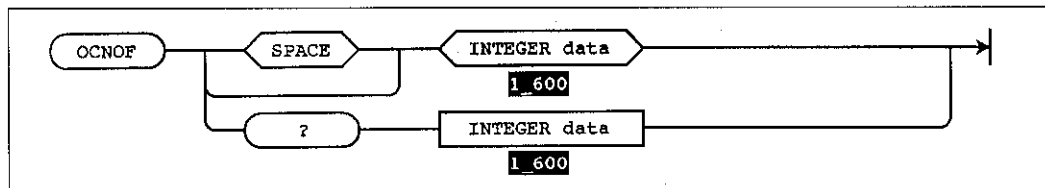
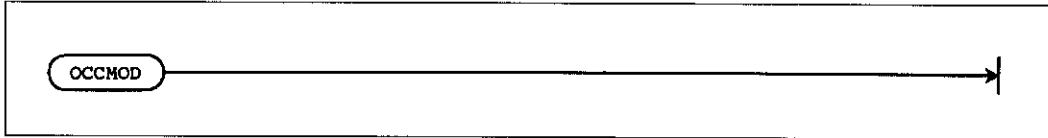

**Table 4-2 Correspondence of Set Data and Query Data (Return Value for Query)**

Command	Set Data	Return Value for Query	Remarks
· Generator Mode Setting	SIGO	0	SIGNAL ONLY
	NOIO	1	NOISE ONLY
	EBNO	2	Eb/No
· Data Source Setting	ZEROS	0	
	RANDOM	1	
	RANDERR	2	
	USER	3	
· Rate Setting	9600	0	
	4800	1	
	2400	2	
	1200	3	
	14400	4	
	7200	5	
	3600	6	
	1800	7	
· Ref. Clock Setting · CDMA TB Setting	C0	0	INTERNAL for CDMA TB Setting command only
	C1	1	
	C2	2	
	C3	3	
	C4	4	
	C5	5	
	C6	6	
	C7	7	
	C8	8	
	C9	9	
	INTERNAL	10	

4.1 GPIB Command Syntax (Description)

(19) AWGN calibration command



(20) Generator Mode Setting command

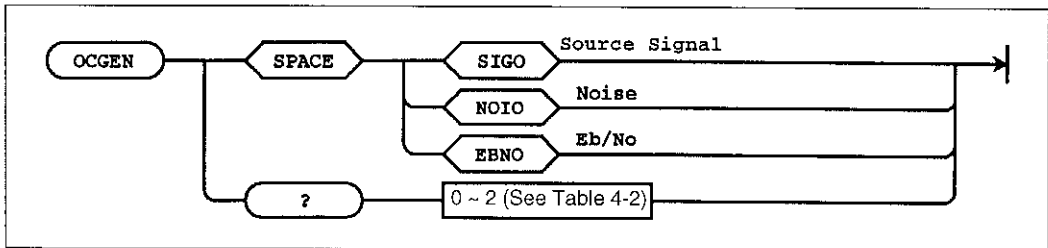

(21) Eb/No Setting command

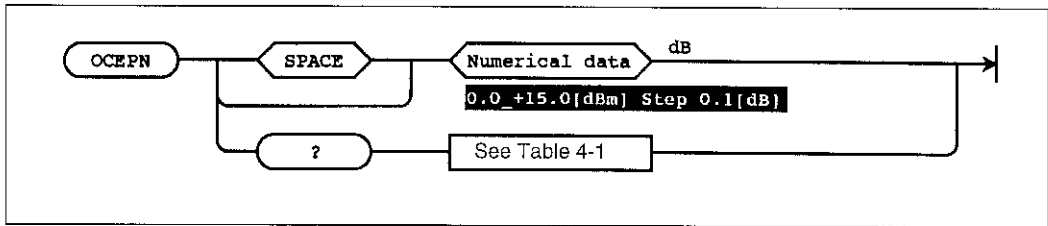

(22) Correction Data ON/OFF setting command

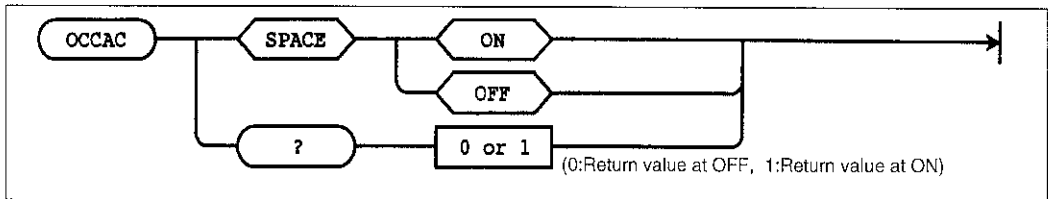

(23) Level Offset ON/OFF setting command

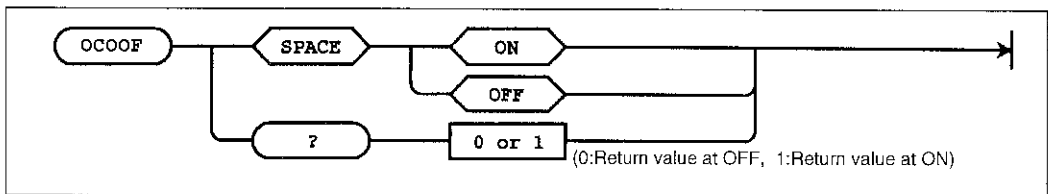

- (24) Level Offset Value Setting command

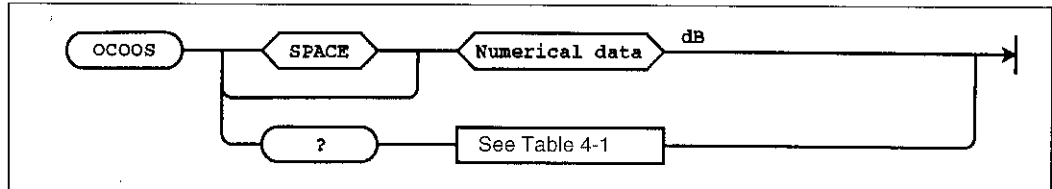

### 4.1.2 TG Control Command

- (1) TG Control Mode IN/OUT Setting command

To control the TG, Mode IN must be selected.  
When Mode Out is selected, control returns to R3267, R3463 or R3465.

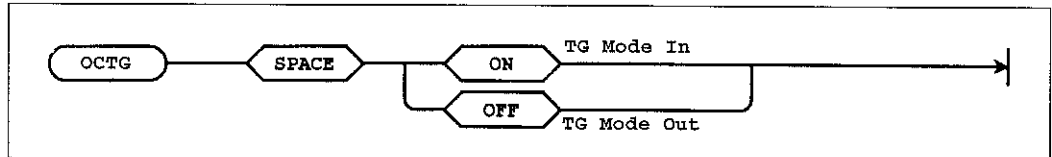

*Note: For the R3267, Mode In (ON) is available only in the SPA mode.*

- (2) TG Level setting command

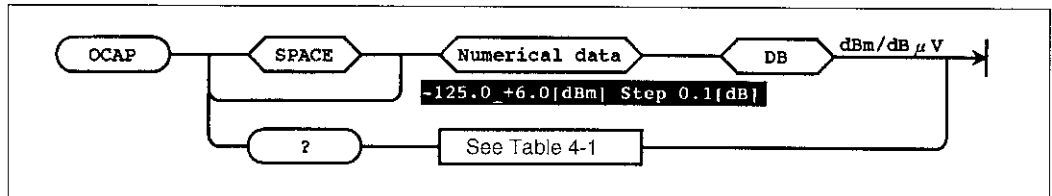

- (3) Normalization ON/OFF setting command

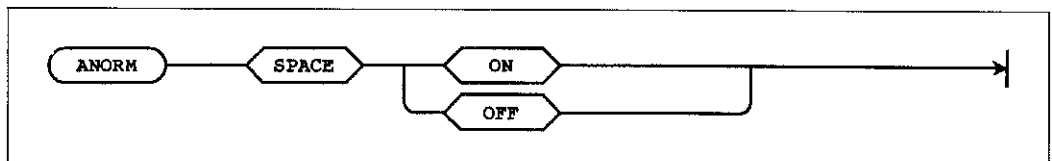

- (4) Correction Data storing command

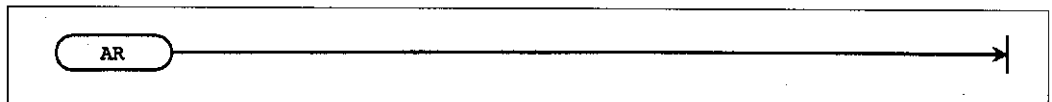

- (5) DISPLAY LINE positioning command

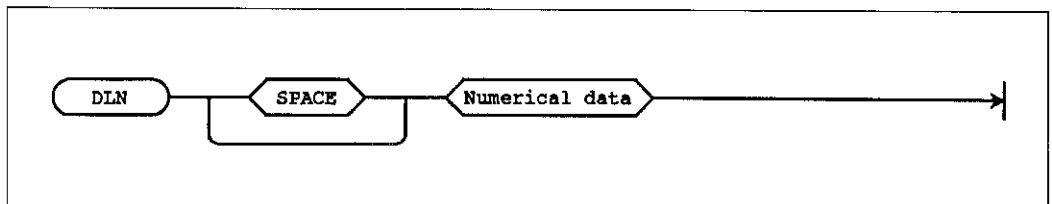

4.1 GPIB Command Syntax (Description)

- (6) Modulation ON/OFF setting command

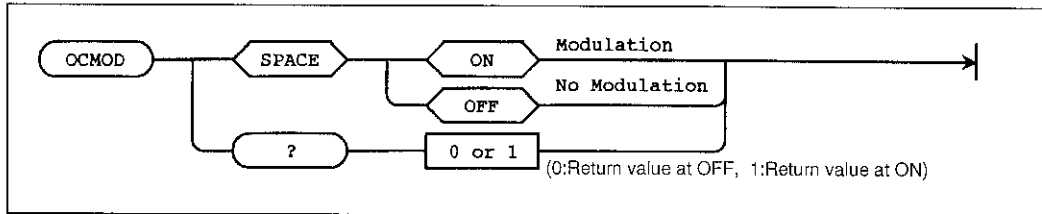

- (7) Output ON/OFF Setting command

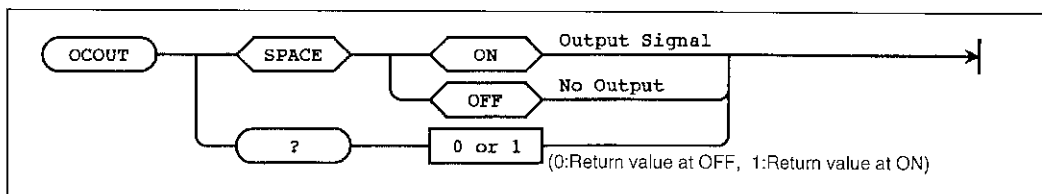

- (8) Preselector Operating Frequency switching command

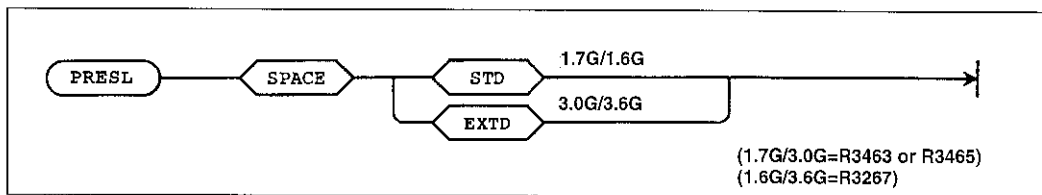

- (9) Trace A Quarrying command

The trace A data is quarried. For detail, see "R3267, R3463 or R3465 instruction manual".

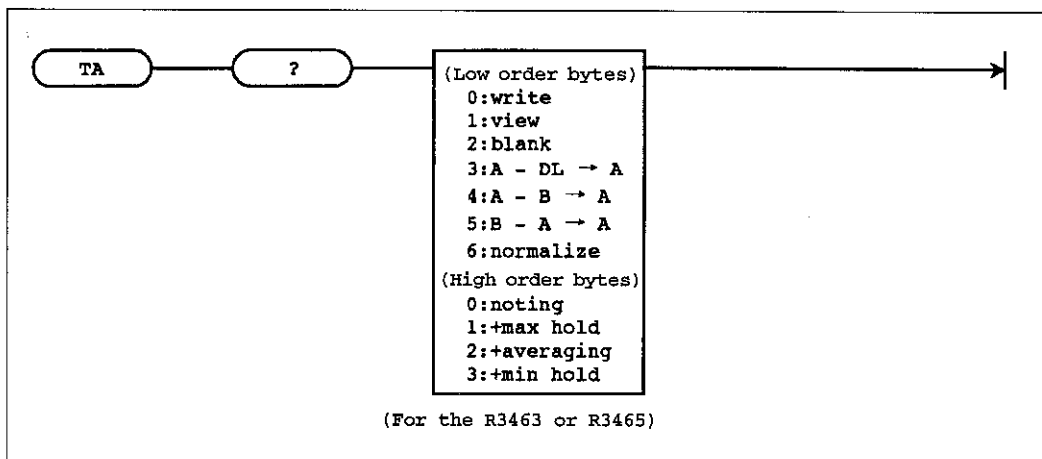

## 4.2 GPIB Sample Program

*Note1: The following sample programs are written in HP-BASIC.*

*Note2: These programs assume that a GPIB address of 8 is set for the R3267, R3463 or R3465.*

### Sample 1 Basic Setting

```

10 !*****
20 !           CDMA TEST SOURCE
30 !   === example program1 ===
40 !   output condition >>> frequency : 1.85GHz
50 !           RF LEVEL : -85dBm
60 !           LINK      : REVERSE LINK
70 !*****
80 !
90 INTEGER Spa
100 Spa=708           !GPIB address setting
110 CLEAR Spa        !GPIB interface initialization
120 !
130 OUTPUT Spa;"OCFUNC ON"      !Enters the R3561L control mode.
140 !
150 OUTPUT Spa;"OCIP"           !Initializes the R3561L.
160 OUTPUT Spa;"OCFR 1.5GZ"     !Sets the output frequency to 1.5GHz
170 OUTPUT Spa;"OCLINK REV"     !Sets Link to Reverse.
180 OUTPUT Spa;"OCMOD ON"       !Sets Modulation to ON.
190 OUTPUT Spa;"OCRATE 9600"    !Sets Rate to 9600 bits/sec.
200 OUTPUT Spa;"OCSOUR ZEROS"   !Sets Data Source to ZEROS.
210 OUTPUT Spa;"OCEVEN DISABLE" !Sets Even Second In to Disable.
220 OUTPUT Spa;"OCPNOF 0.0"    !Sets PN Offset to 0.00.
230 OUTPUT Spa;"OCEQFLT OFF"    !Sets Equalizing Filter to OFF.
240 OUTPUT Spa;"OCRSYN C7"     !Sets Reference Clock to 10MHz.
250 OUTPUT Spa;"OCDIG INTERNAL" !Sets CDMA TB to Internal.
260 OUTPUT Spa;"OCAP -75DB"    !Sets the output level to -75dBm.
270 !
280 OUTPUT Spa;"OCFUNC OFF"     !Exits from the R3561L control mode.
290 END

```

4.2 GPIB Sample Program

Sample 2 Optional frame patterns are written to frames 2 through 4 of the User Defined Buffer and data is repetitively output from those frames. The data transfer rate and frame error CRC are set to 1200bits/sec and ZERO, respectively.

```

10 !*****
20 !           CDMA TEST SOURCE
30 !   === example program2 ===
40 !*****
50 !
60 INTEGER Spa
70 Spa=708           ! GPIB address setting
80 CLEAR Spa        ! GPIB interface initialization
90 !
100 OUTPUT Spa;"OCFUNC ON"           ! Enters the R3561L control mode.
110 !
120 OUTPUT Spa;"OCIBL 2"             ! Specifies frame 2.
130 OUTPUT Spa;"OCIBD 838888"       ! Writes data to frame 2.
140 ! 8: Sets CRC to ZERO, 3: Sets data transfer rate = 1200bits/sec, 8888: Information bits
150 !
160 OUTPUT Spa;"OCIBL 3"             ! Specifies frame 3.
170 OUTPUT Spa;"OCIBD 837777"       ! Writes data to frame 3.
180 ! 8: Sets CRC to ZERO, 3: Sets data transfer rate = 1200bits/sec, 7777: Information bits
190 !
200 OUTPUT Spa;"OCIBL 4"             ! Specifies frame 4.
210 OUTPUT Spa;"OCIBD 836666"       ! Writes data to frame 4.
220 ! 8: Sets CRC to ZERO, 3: Sets data transfer rate = 1200bits/sec, 6666: Information bits
230 !
240 OUTPUT Spa;"OCSTF 2"             ! Sets the start frame to 2.
250 OUTPUT Spa;"OCNOF 3"            ! Sets the repetition frame count to 3.
260 OUTPUT Spa;"OCRATE 1200"        ! Sets Rate to 1200bits/sec.
270 OUTPUT Spa;"OCSOUR USER"        ! Sets Data Source to USER.
270 !
280 OUTPUT Spa;"OCFUNC OFF"         ! Exits from R3561L control mode
290 END
300 !

```



## 5 OPERATION PRINCIPLE

This chapter describes the operation principle and block diagram of the R3561L.

### 5.1 R3561L Operation Principle

The R3561L generates a digital modulated signal corresponding to the CDMA (TIA/EIA/IS-95).

(1) REFERENCE section

Consists of the RF-SYNSETHIZER REFERENCE which supplies the reference signal phase-synchronous with the rear panel SYNTH REFIN terminal signal to the RF circuit system and the CDMA-TIMEBASE which supplies the reference signal for modulation to the base band section. The CDMA-TIMEBASE is provided with the INTERNAL mode to synchronize with the RF circuit and the mode to synchronize with the front panel CDMA TIME BASE IN terminal signal.

(2) Base band section

Executes modulation pattern coding conforming to TIA/EIA/IS-95 based on the internal data source and supplies the I and Q signals to the MOD/CONV section via the Quadrature Spreader and FIR FILTER.

When Even Second In is set to ENABLE, the signal can be output at the following timing synchronous with the signal from the front panel.

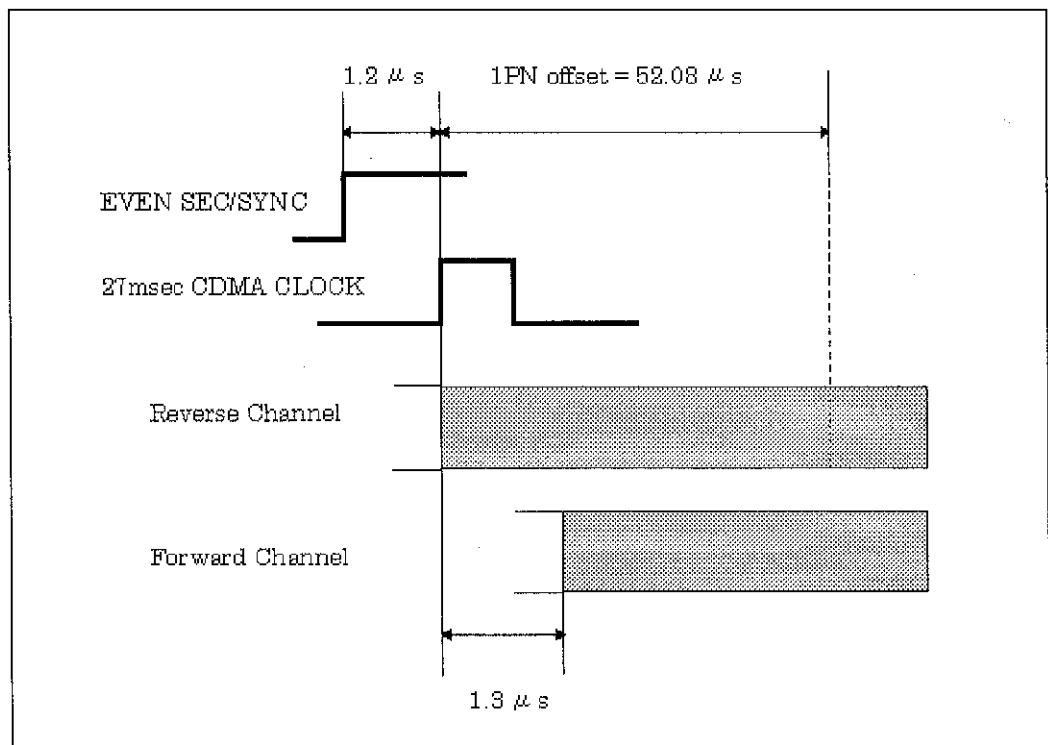

5.1 R3561L Operation Principle

(3) MOD/CONV section

First, executes direct modulation using the 420MHz band local signal and the I and Q signals from the base band section. Next, performs upward conversion with the 3.8GHz local signal. Then, implements downward conversion with the R3267, R3463 or R3465 local signal input from the rear panel, obtaining the final RF output frequency.

(4) RF AMP section

Consists of the RF signal amplifier and the high-precision level control circuit. The 0.1dB output level resolution is implemented in this section.

(5) ATT section

This is a programmable 125dB attenuator which is variable in 1dB steps. This accuracy and the RF AMP section's characteristics are stored on the CPU board, so that the precisely calibrated signal is output from the front panel RF OUT terminal.

(6) CPU section

Executes serial interface with the R3267, R3463 or R3465 and control of R3561L components.

5.2 Block Diagram

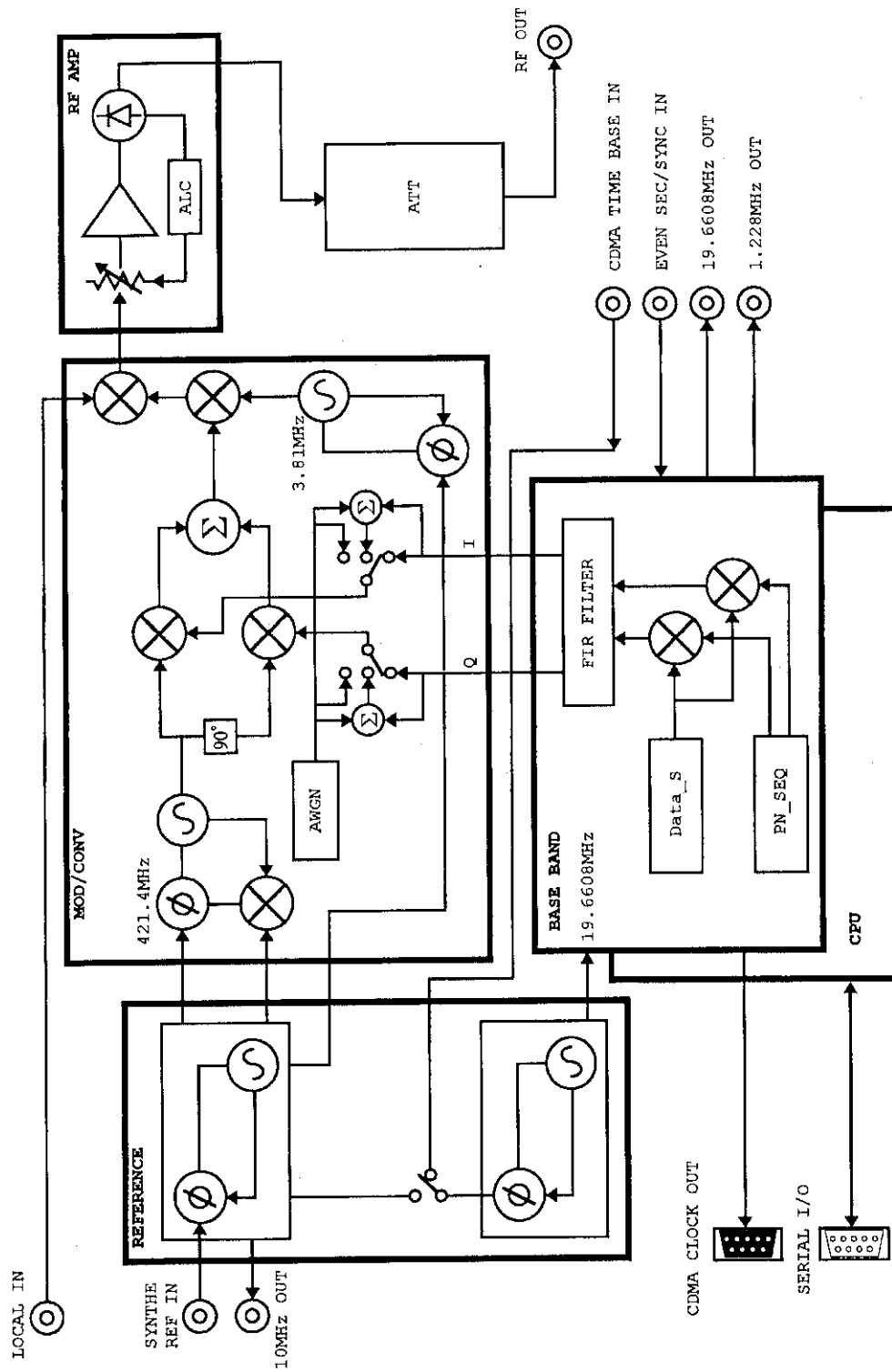

5.3 Simplified Operation Check

5.3 Simplified Operation Check

The simplified operation check of the R3561L can be implemented with the following procedure.

<Procedure for the R3267>

- ① Input the R3561L output signal to the R3267 using the connection shown in the following diagram.

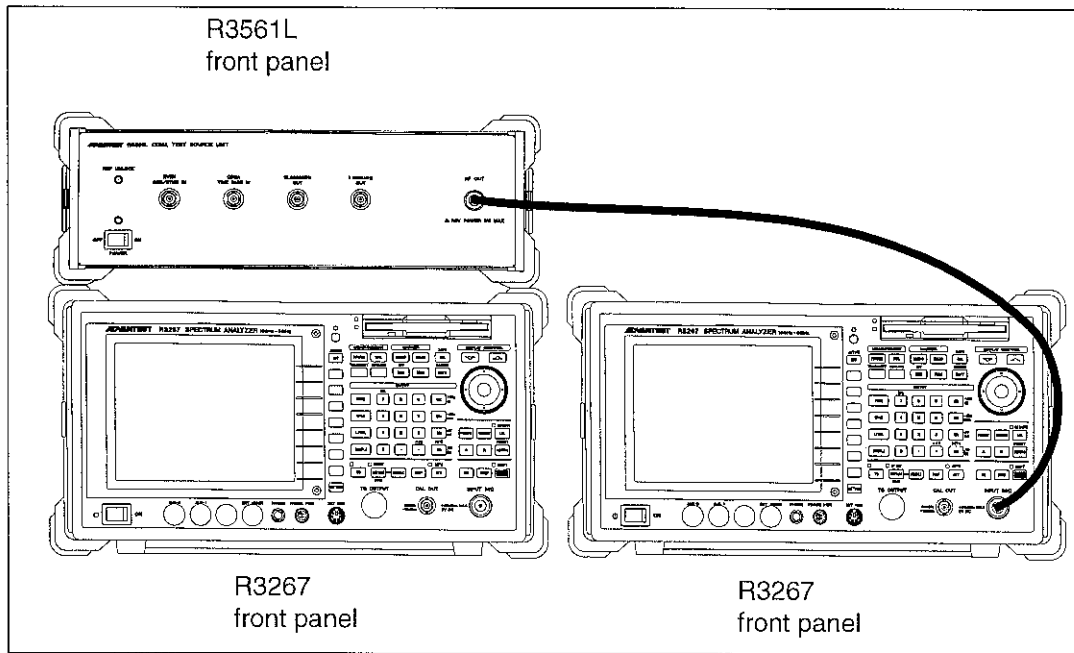

- ② Enter the control mode of the CDMA test source (*{CDMA Sig.}*), and set the frequency, level, and parameters as shown in the following example screen.

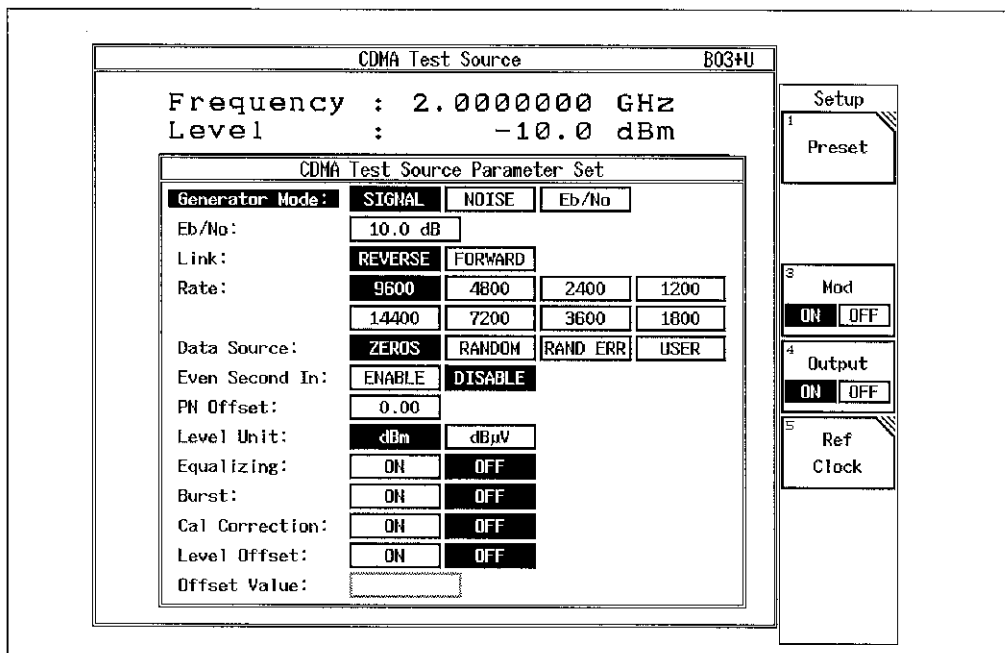

- ③ Measure the waveform quality and output level using the IS95 modulation analysis functions for the R3267 in order to confirm that the analyzer is operating correctly.

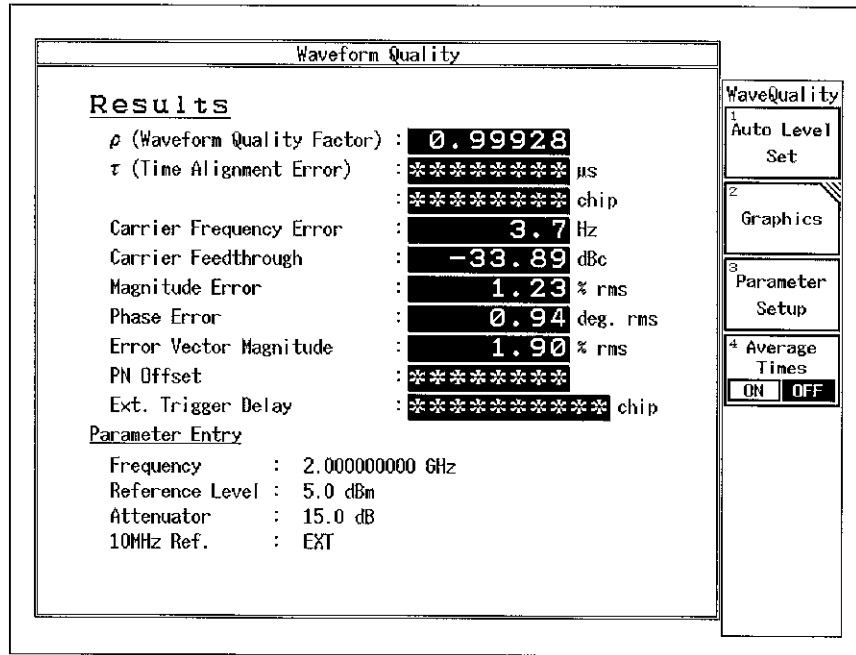

<Example Waveform Quality Check>

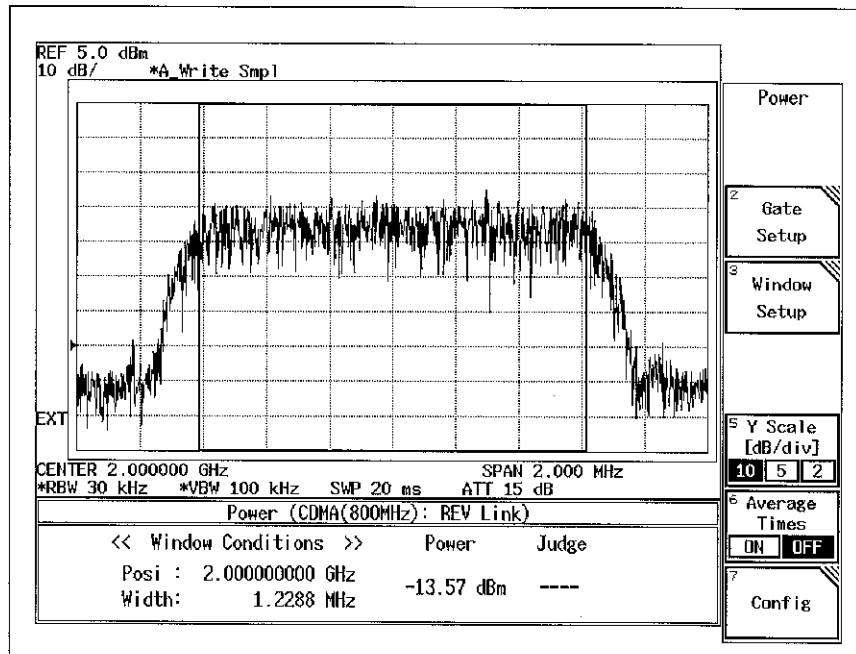

<Example Output Level Check>

5.3 Simplified Operation Check

<Procedure for the R3463 or R3465>

- ① Input the R3561L output signal to the R3463 or R3465 using the connection shown in the following diagram.

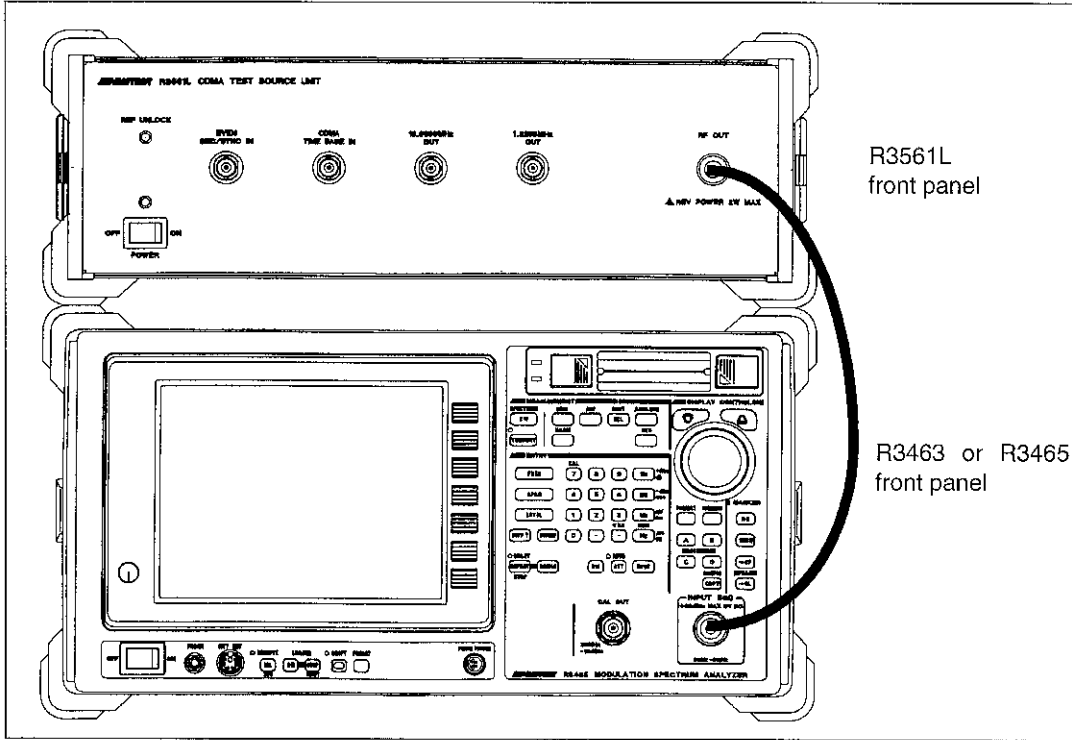

- ② Enter the control mode of the CDMA test source (*{CDMA Sig.}*), and set the frequency, level, and parameters as shown in the following example screen.

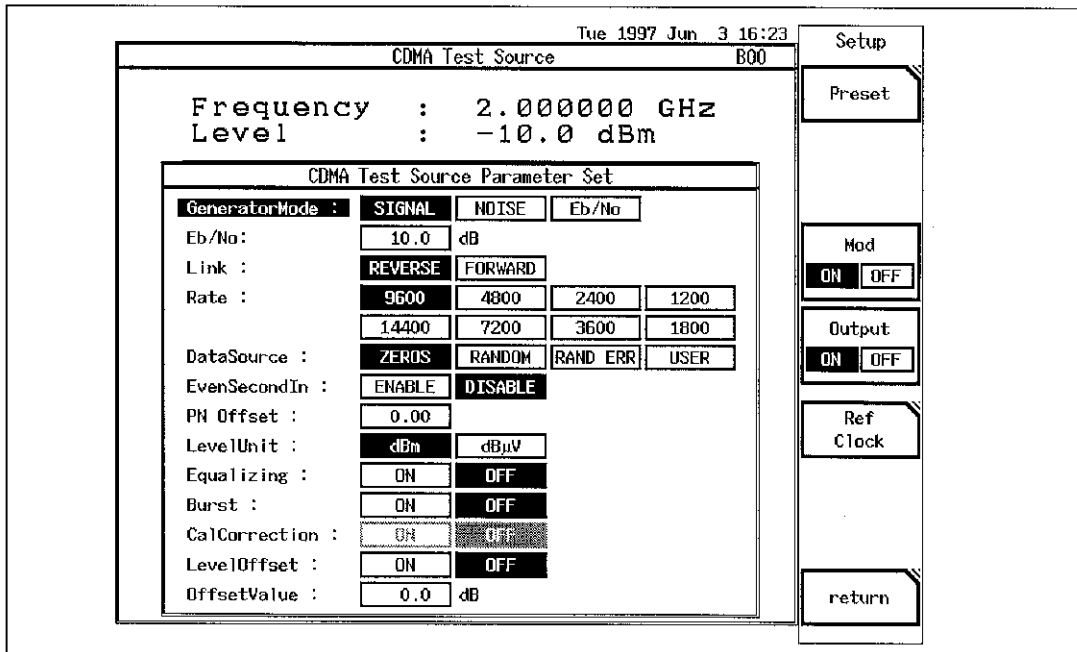

5.3 Simplified Operation Check

- ③ Measure the waveform quality and output level using the modulation analysis functions for the R3463 or R3465 in order to confirm that the analyzer is operating correctly.

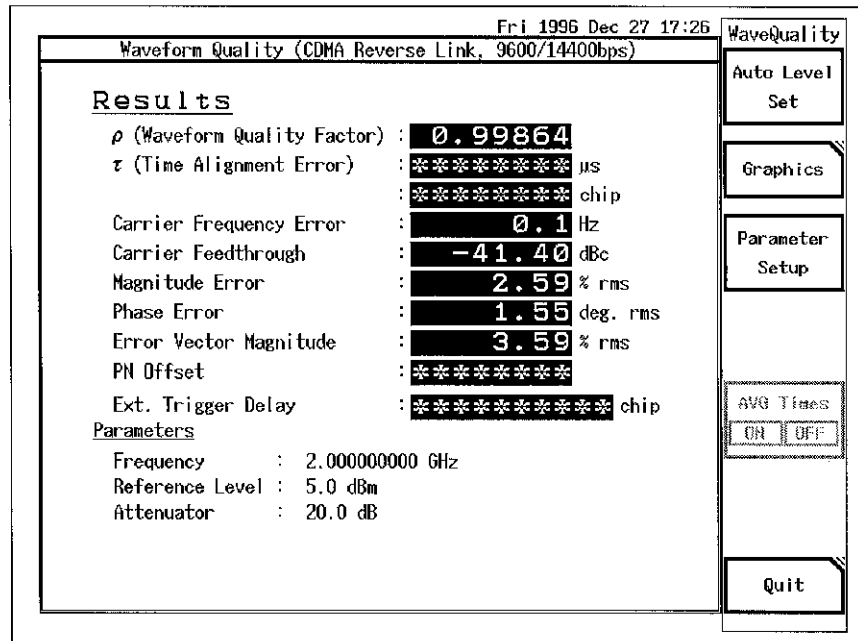

<Example Waveform Quality Check>

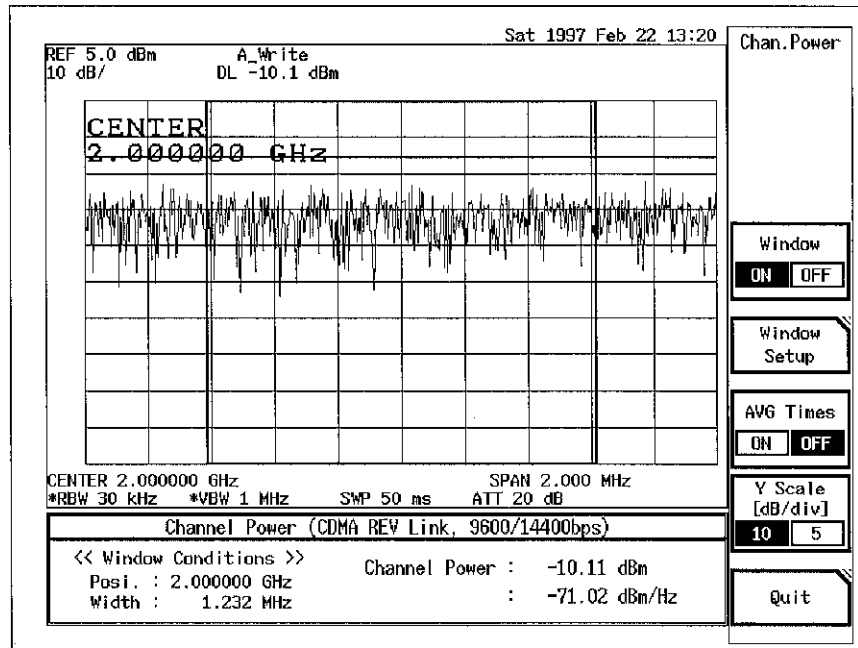

<Example Output Level Check>





## 6 PERFORMANCE SPECIFICATIONS

This chapter describes the performance and general specifications of the R3561L.

### 6.1 CDMA Test Source

#### 6.1.1 Output Frequency

Range : 50MHz to 2000MHz  
 Resolution : 1Hz  
 Accuracy : Based on the external reference source accuracy.

#### 6.1.2 Output Level

Range : -125dBm to 0dBm  
 Resolution : 0.1dB  
 Accuracy (with signal mode) :  $\leq \pm 1.5\text{dB}$  (output level: -120dBm to 0dBm,  
 Frequency  $\leq 1000\text{MHz}$ )  
 $\leq \pm 2.5\text{dB}$  (output level: -125dBm to 120.1dBm,  
 Frequency  $\leq 1000\text{MHz}$ )  
 $\leq \pm 1.5\text{dB}$  (output level: -110dBm to 0dBm,  
 Frequency  $> 1000\text{MHz}$ )  
 $\leq \pm 2.5\text{dB}$  (output level: -125dBm to -110.1dBm,  
 Frequency  $> 1000\text{MHz}$ )  
*Note: In the operating temperature range of  $25^{\circ}\text{C} \pm 10^{\circ}\text{C}$*

#### 6.1.3 Signal Purity

Harmonics :  $\leq -30\text{dBc}$  (output level 0dBm)  
 Non-harmonics :  $\leq -55\text{dBc}$  (frequency offset  $> 5\text{kHz}$ )  
 Adjacent channel noise :  $\leq -45\text{dBc}$  (band 30kHz, frequency offset 900kHz, output level 0dBm)

#### 6.1.4 Modulation

##### Reverse Link

Modulation method : OQPSK (TIA IS-95)  
 Channel : Traffic channel  
 Data transfer rate : 9600bps/4800bps/2400bps/1200bps  
 14400bps/7200bps/3600bps/1800bps  
 Data source : 600 frames (ZEROS/RANDOM/RANDERR)  
 600 frames (USER)

##### Forward Link

Modulation method : QPSK (TIA IS-95)  
 Channel : Pilot channel  
 Waveform quality factor :  $\rho \leq 0.96$   
 PN offset : 0 to 511 ( $\times 64$  chips)  
 Long code mask : 42 zeros  
 Burst ON/OFF Ratio :  $>20\text{dB}$

6 PERFORMANCE SPECIFICATIONS

**6.1.5 AWGN Source**

Bandwidth :  $\geq 2\text{MHz}$   
 Mode : Signal (AWGN OFF), NOISE, Eb/No  
 Eb/No Resolution : 0.1 dB  
 Eb/No Accuracy :  $\pm 1.0\text{ dB}$  (With AWGN calibrated.)  
 Absolute Level Accuracy:  $\pm 0.5\text{ dB}$  (With Signal mode)

**6.1.6 Reference Source**

Synthesizer reference input: 19.6608MHz, 15MHz, 10MHz, 9.8304MHz, 5MHz,  
 4.9152MHz, 2.4576MHz, 2MHz, 1.2288MHz, 1MHz  
 Level: 0dBm to +23dBm, Input impedance 50  $\Omega$  (BNC)

CDMA Time Base input : 19.6608MHz, 15MHz, 10MHz, 9.8304MHz, 5MHz,  
 4.9152MHz, 2.4576MHz, 2MHz, 1.2288MHz, 1MHz  
 Level: 0dBm to +23dBm, Input impedance 50  $\Omega$  (BNC)

Even Second Sync input : 2sec TTL (BNC)

10MHz reference output : 10MHz  $\geq 0\text{dBm}$  (BNC), Output impedance 50  $\Omega$  (BNC)

CDMA Clock output

1.2288MHz : TTL Output impedance 50  $\Omega$  (BNC)  
 19.6608MHz : TTL Output impedance 50  $\Omega$  (BNC)  
 20msec/26.67msec/80msec/Even second : TTL (D-sub 9-pin)

**6.2 Tracking Generator**

**6.2.1 Output Frequency**

Range : 50MHz to 2000MHz  
 Resolution : 1Hz  
 Accuracy : R3267/R3463/R3465

**6.2.2 Output Level**

Range : 0 dBm to -50 dBm  
 Resolution : 0.1 dB  
 Accuracy :  $\leq \pm 1.5\text{ dB}$  (Center Frequency 1GHz, ZERO SPAN)  
 \* Within 25°C  $\pm 10^\circ\text{C}$

**6.3 Others**

RF OUT : N-type connector (50  $\Omega$ ), max. reversed input power: 2W  
 SWR  $\leq 1:1.5$  (output level  $< -10\text{dBm}$ )

Serial I/O : R3267, R3463 or R3465 dedicated interface

REF UNLOCK : Turn on at RF-SYNTHESIZER/CDMA-TIMEBASE PLL UNLOCK

#### 6.4 General Specifications

Operating temperature/humidity range: 0°C to 50°C, RH85% or less (no condensation)

Storage temperature : -20°C to 60°C

Power supply : Automatic switching to 100 VAC or 200 VAC  
For 100 VAC; 100 to 120 VAC, 50 or 60Hz  
For 200 VAC; 220 to 240 VAC, 50 or 60 Hz  
150VA or less

Mass : 10kg or less

External dimensions : Approx. 110 (H) × 352 (W) × 424 (D) mm



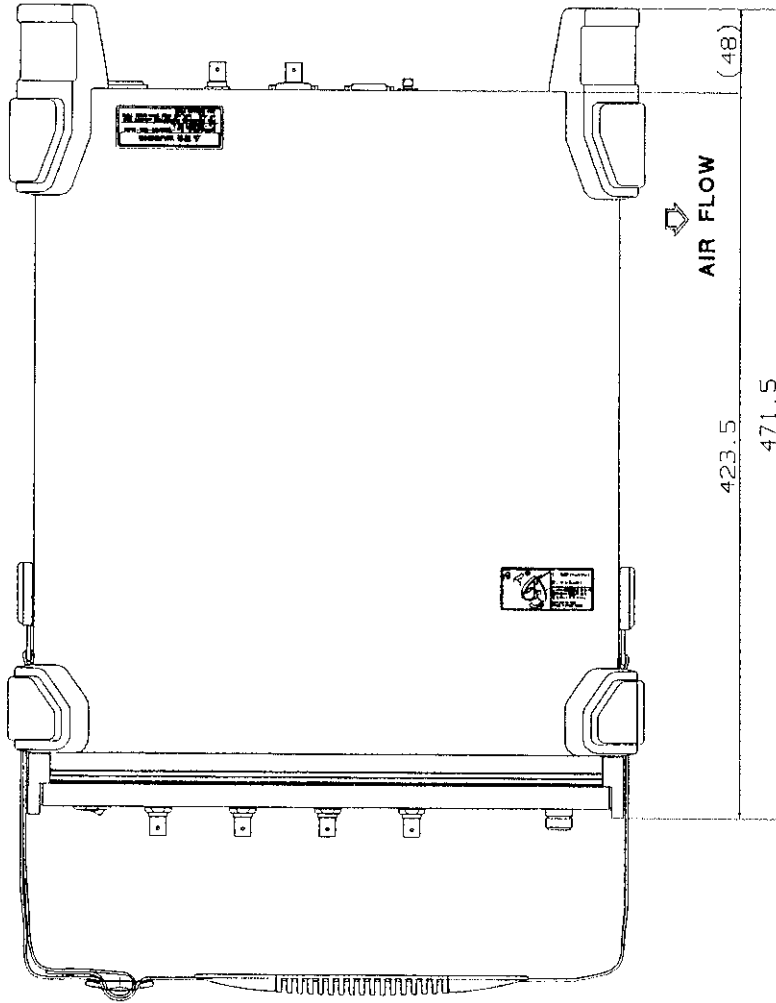
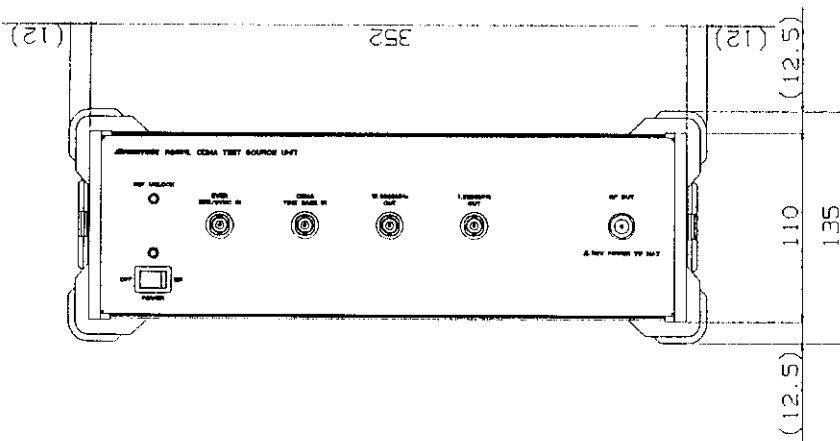

Unit: mm

**CAUTION**

This drawing shows external dimensions of this instrument. The difference in products and options used can cause a change in the appearance of the instrument.

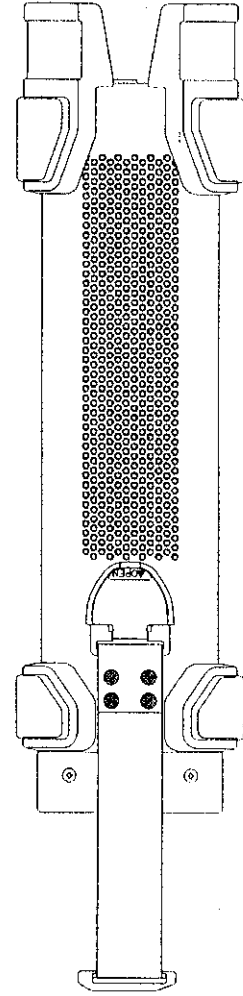

**DIMENSIONAL OUTLINE DRAWING**



## **IMPORTANT INFORMATION FOR ADVANTEST SOFTWARE**

PLEASE READ CAREFULLY: This is an important notice for the software defined herein. Computer programs including any additions, modifications and updates thereof, operation manuals, and related materials provided by Advantest (hereafter referred to as "SOFTWARE"), included in or used with hardware produced by Advantest (hereafter referred to as "PRODUCTS").

### **SOFTWARE License**

All rights in and to the SOFTWARE (including, but not limited to, copyright) shall be and remain vested in Advantest. Advantest hereby grants you a license to use the SOFTWARE only on or with Advantest PRODUCTS.

### **Restrictions**

- (1) You may not use the SOFTWARE for any purpose other than for the use of the PRODUCTS.
- (2) You may not copy, modify, or change, all or any part of, the SOFTWARE without permission from Advantest.
- (3) You may not reverse engineer, de-compile, or disassemble, all or any part of, the SOFTWARE.

### **Liability**

Advantest shall have no liability (1) for any PRODUCT failures, which may arise out of any misuse (misuse is deemed to be use of the SOFTWARE for purposes other than its intended use) of the SOFTWARE. (2) For any dispute between you and any third party for any reason whatsoever including, but not limited to, infringement of intellectual property rights.

## LIMITED WARRANTY

1. Unless otherwise specifically agreed by Seller and Purchaser in writing, Advantest will warrant to the Purchaser that during the Warranty Period this Product (other than consumables included in the Product) will be free from defects in material and workmanship and shall conform to the specifications set forth in this Operation Manual.
2. The warranty period for the Product (the "Warranty Period") will be a period of one year commencing on the delivery date of the Product.
3. If the Product is found to be defective during the Warranty Period, Advantest will, at its option and in its sole and absolute discretion, either (a) repair the defective Product or part or component thereof or (b) replace the defective Product or part or component thereof, in either case at Advantest's sole cost and expense.
4. This limited warranty will not apply to defects or damage to the Product or any part or component thereof resulting from any of the following:
  - (a) any modifications, maintenance or repairs other than modifications, maintenance or repairs (i) performed by Advantest or (ii) specifically recommended or authorized by Advantest and performed in accordance with Advantest's instructions;
  - (b) any improper or inadequate handling, carriage or storage of the Product by the Purchaser or any third party (other than Advantest or its agents);
  - (c) use of the Product under operating conditions or environments different than those specified in the Operation Manual or recommended by Advantest, including, without limitation, (i) instances where the Product has been subjected to physical stress or electrical voltage exceeding the permissible range and (ii) instances where the corrosion of electrical circuits or other deterioration was accelerated by exposure to corrosive gases or dusty environments;
  - (d) use of the Product in connection with software, interfaces, products or parts other than software, interfaces, products or parts supplied or recommended by Advantest;
  - (e) incorporation in the Product of any parts or components (i) provided by Purchaser or (ii) provided by a third party at the request or direction of Purchaser or due to specifications or designs supplied by Purchaser (including, without limitation, any degradation in performance of such parts or components);
  - (f) Advantest's incorporation or use of any specifications or designs supplied by Purchaser;
  - (g) the occurrence of an event of force majeure, including, without limitation, fire, explosion, geological change, storm, flood, earthquake, tidal wave, lightning or act of war; or
  - (h) any negligent act or omission of the Purchaser or any third party other than Advantest.
5. **EXCEPT TO THE EXTENT EXPRESSLY PROVIDED HEREIN, ADVANTEST HEREBY EXPRESSLY DISCLAIMS, AND THE PURCHASER HEREBY WAIVES, ALL WARRANTIES, WHETHER EXPRESS OR IMPLIED, STATUTORY OR OTHERWISE, INCLUDING, WITHOUT LIMITATION, (A) ANY WARRANTY OF MERCHANTABILITY OR FITNESS FOR A PARTICULAR PURPOSE AND (B) ANY WARRANTY OR REPRESENTATION AS TO THE VALIDITY, SCOPE, EFFECTIVENESS OR USEFULNESS OF ANY TECHNOLOGY OR ANY INVENTION.**
6. **THE REMEDY SET FORTH HEREIN SHALL BE THE SOLE AND EXCLUSIVE REMEDY OF THE PURCHASER FOR BREACH OF WARRANTY WITH RESPECT TO THE PRODUCT.**
7. **ADVANTEST WILL NOT HAVE ANY LIABILITY TO THE PURCHASER FOR ANY INDIRECT, INCIDENTAL, SPECIAL, CONSEQUENTIAL OR PUNITIVE DAMAGES, INCLUDING, WITHOUT LIMITATION, LOSS OF ANTICIPATED PROFITS OR REVENUES, IN ANY AND ALL CIRCUMSTANCES, EVEN IF ADVANTEST HAS BEEN ADVISED OF THE POSSIBILITY OF SUCH DAMAGES AND WHETHER ARISING OUT OF BREACH OF CONTRACT, WARRANTY, TORT (INCLUDING, WITHOUT LIMITATION, NEGLIGENCE), STRICT LIABILITY, INDEMNITY, CONTRIBUTION OR OTHERWISE. TORT (INCLUDING, WITHOUT LIMITATION, NEGLIGENCE), STRICT LIABILITY, INDEMNITY, CONTRIBUTION OR OTHERWISE.**
8. **OTHER THAN THE REMEDY FOR THE BREACH OF WARRANTY SET FORTH HEREIN, ADVANTEST SHALL NOT BE LIABLE FOR, AND HEREBY DISCLAIMS TO THE FULLEST EXTENT PERMITTED BY LAW ANY LIABILITY FOR, DAMAGES FOR PRODUCT FAILURE OR DEFECT, WHETHER ARISING OUT OF BREACH OF CONTRACT, TORT (INCLUDING, WITHOUT LIMITATION, NEGLIGENCE), STRICT LIABILITY, INDEMNITY, CONTRIBUTION OR OTHERWISE.**



## **CUSTOMER SERVICE DESCRIPTION**

In order to maintain safe and trouble-free operation of the Product and to prevent the incurrence of unnecessary costs and expenses, Advantest recommends a regular preventive maintenance program under its maintenance agreement.

Advantest's maintenance agreement provides the Purchaser on-site and off-site maintenance, parts, maintenance machinery, regular inspections, and telephone support and will last a maximum of ten years from the date the delivery of the Product. For specific details of the services provided under the maintenance agreement, please contact the nearest Advantest office listed at the end of this Operation Manual or Advantest's sales representatives.

Some of the components and parts of this Product have a limited operating life (such as, electrical and mechanical parts, fan motors, unit power supply, etc.). Accordingly, these components and parts will have to be replaced on a periodic basis. If the operating life of a component or part has expired and such component or part has not been replaced, there is a possibility that the Product will not perform properly. Additionally, if the operating life of a component or part has expired and continued use of such component or part damages the Product, the Product may not be repairable. Please contact the nearest Advantest office listed at the end of this Operation Manual or Advantest's sales representatives to determine the operating life of a specific component or part, as the operating life may vary depending on various factors such as operating condition and usage environment.

## SALES & SUPPORT OFFICES

Advantest Korea Co., Ltd.

22BF, Kyobo KangNam Tower,  
1303-22, Seocho-Dong, Seocho-Ku, Seoul #137-070, Korea  
Phone: +82-2-532-7071  
Fax: +82-2-532-7132

Advantest (Suzhou) Co., Ltd.

Shanghai Branch Office:  
Bldg. 6D, NO.1188 Gumei Road, Shanghai, China 201102 P.R.C.  
Phone: +86-21-6485-2725  
Fax: +86-21-6485-2726

Shanghai Branch Office:  
406/F, Ying Building, Quantum Plaza, No. 23 Zhi Chun Road,  
Hai Dian District, Beijing,  
China 100083  
Phone: +86-10-8235-3377  
Fax: +86-10-8235-6717

Advantest (Singapore) Pte. Ltd.

438A Alexandra Road, #08-03/06  
Alexandra Technopark Singapore 119967  
Phone: +65-6274-3100  
Fax: +65-6274-4055

Advantest America, Inc.

3201 Scott Boulevard, Suite, Santa Clara, CA 95054, U.S.A  
Phone: +1-408-988-7700  
Fax: +1-408-987-0691

ROHDE & SCHWARZ Europe GmbH

Mühldorfstraße 15 D-81671 München, Germany  
(P.O.B. 80 14 60 D-81614 München, Germany)  
Phone: +49-89-4129-13711  
Fax: +49-89-4129-13723

**ADVANTEST®**

<http://www.advantest.co.jp>