ADVANTEST®

ADVANTEST CORPORATION

R3765/67H Series

Network Analyzer

Operation Manual

MANUAL NUMBER FOE-8324182C00

Applicable models

***R3765AH
R3765BH
R3765CH
R3767AH
R3767BH
R3767CH***

Safety Summary

To ensure thorough understanding of all functions and to ensure efficient use of this instrument, please read the manual carefully before using. Note that Advantest bears absolutely no responsibility for the result of operations caused due to incorrect or inappropriate use of this instrument.

If the equipment is used in a manner not specified by Advantest, the protection provided by the equipment may be impaired.

- **Warning Labels**

Warning labels are applied to Advantest products in locations where specific dangers exist. Pay careful attention to these labels during handling. Do not remove or tear these labels. If you have any questions regarding warning labels, please ask your nearest Advantest dealer. Our address and phone number are listed at the end of this manual.

Symbols of those warning labels are shown below together with their meaning.

DANGER: Indicates an imminently hazardous situation which will result in death or serious personal injury.

WARNING: Indicates a potentially hazardous situation which will result in death or serious personal injury.

CAUTION: Indicates a potentially hazardous situation which will result in personal injury or a damage to property including the product.

- **Basic Precautions**

Please observe the following precautions to prevent fire, burn, electric shock, and personal injury.

- Use a power cable rated for the voltage in question. Be sure however to use a power cable conforming to safety standards of your nation when using a product overseas.
- When inserting the plug into the electrical outlet, first turn the power switch OFF and then insert the plug as far as it will go.
- When removing the plug from the electrical outlet, first turn the power switch OFF and then pull it out by gripping the plug. Do not pull on the power cable itself. Make sure your hands are dry at this time.
- Before turning on the power, be sure to check that the supply voltage matches the voltage requirements of the instrument.
- Connect the power cable to a power outlet that is connected to a protected ground terminal. Grounding will be defeated if you use an extension cord which does not include a protected ground terminal.
- Be sure to use fuses rated for the voltage in question.
- Do not use this instrument with the case open.
- Do not place anything on the product and do not apply excessive pressure to the product. Also, do not place flower pots or other containers containing liquid such as chemicals near this

product.

- When the product has ventilation outlets, do not stick or drop metal or easily flammable objects into the ventilation outlets.
- When using the product on a cart, fix it with belts to avoid its drop.
- When connecting the product to peripheral equipment, turn the power off.

- **Caution Symbols Used Within this Manual**

Symbols indicating items requiring caution which are used in this manual are shown below together with their meaning.

DANGER: Indicates an item where there is a danger of serious personal injury (death or serious injury).

WARNING: Indicates an item relating to personal safety or health.

CAUTION: Indicates an item relating to possible damage to the product or instrument or relating to a restriction on operation.

- **Safety Marks on the Product**

The following safety marks can be found on Advantest products.



: ATTENTION - Refer to manual.



: Protective ground (earth) terminal.



: DANGER - High voltage.



: CAUTION - Risk of electric shock.

- **Replacing Parts with Limited Life**

The following parts used in the instrument are main parts with limited life.

Replace the parts listed below before their expected lifespan has expired to maintain the performance and function of the instrument.

Note that the estimated lifespan for the parts listed below may be shortened by factors such as the environment where the instrument is stored or used, and how often the instrument is used.

The parts inside are not user-replaceable. For a part replacement, please contact the Advantest sales office for servicing.

Each product may use parts with limited life.

For more information, refer to the section in this document where the parts with limited life are described.

Main Parts with Limited Life

Part name	Life
Unit power supply	5 years
Fan motor	5 years
Electrolytic capacitor	5 years
LCD display	6 years
LCD backlight	2.5 years
Floppy disk drive	5 years
Memory backup battery	5 years

- **Hard Disk Mounted Products**

The operational warnings are listed below.

- Do not move, shock and vibrate the product while the power is turned on. Reading or writing data in the hard disk unit is performed with the memory disk turning at a high speed. It is a very delicate process.
- Store and operate the products under the following environmental conditions.
 - An area with no sudden temperature changes.
 - An area away from shock or vibrations.
 - An area free from moisture, dirt, or dust.
 - An area away from magnets or an instrument which generates a magnetic field.
- Make back-ups of important data. The data stored in the disk may become damaged if the product is mishandled. The hard disc has a limited life span which depends on the operational conditions. Note that there is no guarantee for any loss of data.

- **Precautions when Disposing of this Instrument**

When disposing of harmful substances, be sure dispose of them properly with abiding by the state-provided law.

Harmful substances: (1) PCB (polycarbon biphenyl)
 (2) Mercury
 (3) Ni-Cd (nickel cadmium)
 (4) Other
 Items possessing cyan, organic phosphorous and hexadic chromium and items which may leak cadmium or arsenic (excluding lead in solder).

Example: fluorescent tubes, batteries

Environmental Conditions

This instrument should be only be used in an area which satisfies the following conditions:

- An area free from corrosive gas
- An area away from direct sunlight
- A dust-free area
- An area free from vibrations
- Altitude of up to 2000 m

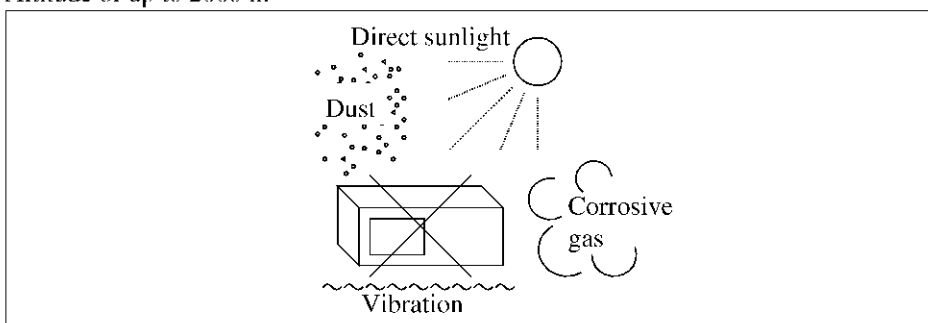

Figure-1 Environmental Conditions

- Operating position

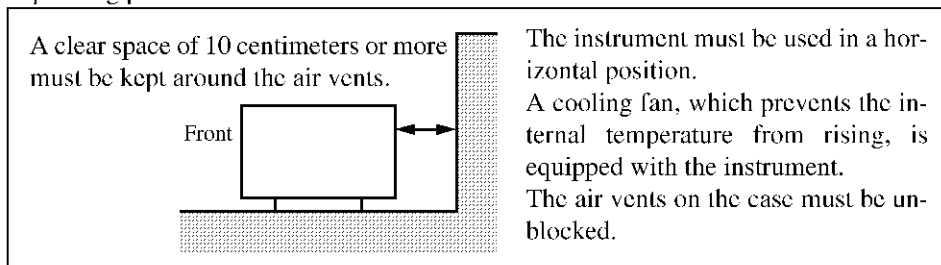

Figure-2 Operating Position

- Storage position

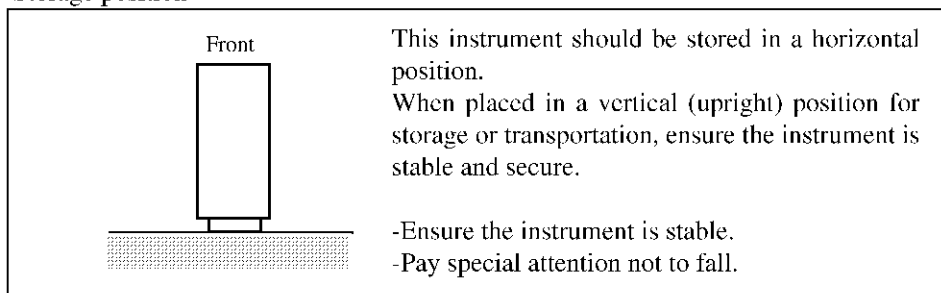

Figure-3 Storage Position

- The classification of the transient over-voltage, which exists typically in the main power supply, and the pollution degree is defined by IEC61010-1 and described below.

Impulse withstand voltage (over-voltage) category II defined by IEC60364-4-443

Pollution Degree 2

Types of Power Cable

Replace any references to the power cable type, according to the following table, with the appropriate power cable type for your country.



Plug configuration	Standards	Rating, color and length	Model number (Option number)
	PSE: Japan Electrical Appliance and Material Safety Law	125 V at 7 A Black 2 m (6 ft)	Straight: A01402 Angled: A01412
	UL: United States of America CSA: Canada	125 V at 7 A Black 2 m (6 ft)	Straight: A01403 (Option 95) Angled: A01413
	CEE: Europe DEMKO: Denmark NEMKO: Norway VDE: Germany KEMA: The Netherlands CEBEC: Belgium OVE: Austria FIMKO: Finland SEMKO: Sweden	250 V at 6 A Gray 2 m (6 ft)	Straight: A01404 (Option 96) Angled: A01414
	SEV: Switzerland	250 V at 6 A Gray 2 m (6 ft)	Straight: A01405 (Option 97) Angled: A01415
	SAA: Australia, New Zealand	250 V at 6 A Gray 2 m (6 ft)	Straight: A01406 (Option 98) Angled: -----
	BS: United Kingdom	250 V at 6 A Black 2 m (6 ft)	Straight: A01407 (Option 99) Angled: A01417
	CCC: China	250 V at 10 A Black 2 m (6 ft)	Straight: A114009 (Option 94) Angled: A114109

Table of Power Cable Options

There are six power cable options (refer to following table).

Order power cable options by Model number.

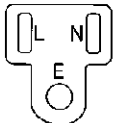
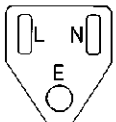
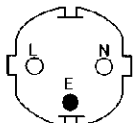
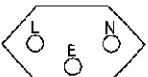
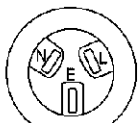
	Plug configuration	Standards	Rating, color and length	Model number (Option number)
1		JIS: Japan Law on Electrical Appliances	125 V at 7 A Black 2 m (6 ft)	Straight: A01402 Angled: A01412
2		UL: United States of America CSA: Canada	125 V at 7 A Black 2 m (6 ft)	Straight: A01403 (Option 95) Angled: A01413
3		CEE: Europe DEMKO: Denmark NEMKO: Norway VDE: Germany KEMA: The Netherlands CEBEC: Belgium OVE: Austria FIMKO: Finland SEMKO: Sweden	250 V at 6 A Gray 2 m (6 ft)	Straight: A01404 (Option 96) Angled: A01414
4		SEV: Switzerland	250 V at 6 A Gray 2 m (6 ft)	Straight: A01405 (Option 97) Angled: A01415
5		SAA: Australia, New Zealand	250 V at 6 A Gray 2 m (6 ft)	Straight: A01406 (Option 98) Angled: -----
6		BS: United Kingdom	250 V at 6 A Black 2 m (6 ft)	Straight: A01407 (Option 99) Angled: A01417

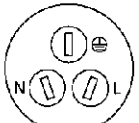
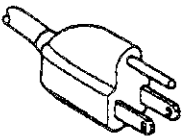
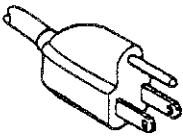
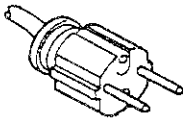
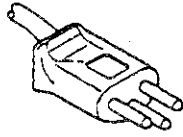
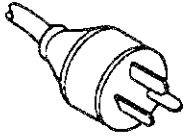
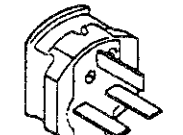
PREFACE

<In the Beginning>

This manual explains all processes from the acceptance to actual operation of network analyzer R3765/3767H series. The manual of three volumes related about the R3765/3767H series is shown in the following.

Manual name	Model	Strong points	Remarks
R3765/67H Series Network Analyzer Operation Manual (this manual)	R3765AH	S parameter can be connected.	3.8GHz model
	R3765BH	Bridge is built in.	
	R3765CH	S parameter is built in.	
	R3767AH	S parameter can be connected.	8.0GHz model
	R3767BH	Bridge is built in.	
	R3767CH	S parameter is built in.	
R3764/65/66/67H Series Network Analyzer Programming Manual (separate volume)	This manual is shared between all models of R3765/67H series.		
R3752/53/64/65/66/ 67H Series Network Analyzer Programming Guide (separate volume)	This manual is shared between all models of R3765/67H series.		

<Caution>

ADVANTEST reserves the right to change the content of this manual and other product information without notice.

Do not reproduce and do not reprint all of this manual or part without permission ADVANTEST Corporation.

The address and the telephone number of ADVANTEST Corporation are described in the end of this manual. Refer for the inquiry etc.

<How to Read this Manual>

- (1) Distinction of panel key and soft key in this manual.

Panel key : (Example) [CH 1] , [5]

Soft key : (Example) {POWER}, {LOG MAG}

- (2) Mark of caution level in this manual

DANGER!

Uses it for the case with the possibility of the body trouble and the death.

WARNING!

Uses for the remarks concerned with the safety of the body.

CAUTION!

Uses for the remarks of the damage or fire of the machine equipment, or for the restriction of use.

REFERENCE

Information helpful to you.

Note: *Uses to explain for the supplementation.*

- (3) Notation for last page

This manual has the page attaching the sign of (*) to the upper right of the page number.
The sign of (*) informs the final page of each chapter.

(4) Organization of this manual

Configuration	Contents	Remarks
Preface	For the first use. Confirmation of the products and the attachments.	Read before first use.
Contents	Table of Contents, Figures, Tables The configuration and the page of the description.	Use to find necessary information easily.
1.	GETTING STARTED From setting to setup, cautions, cleaning, transportation and storage.	Read before first use.
2.	Explanation of panel side and display screen Name of each device, function and operation. Description of display screen.	Usage of the R3765/3767H series can be understood by reading it through.
3.	Basic operating guidelines Actual example of operation. How to look at the display screen.	
4.	Basic operation Description of the basic items.	Chapters of practice.
5.	Measurement method example Concrete examples and operational procedures.	
6.	Record and output Saving to floppy disk and replaying.	
7.	Description of the functions Detailed explanation of each block.	Refer if necessary.
8.	In abnormal Diagnostics and error message.	
9.	Operating principles Basic operation and flow chart.	
10.	Performance test	
11.	Specifications Technical information and general information.	
Appendix	Relation of data between each function Initial setting. Soft key menu list. Other information.	
Index	Main words and the description page.	Use to find necessary information easily.
Others	External view	Use to find the outer dimensions.

<Confirmation of Product and Attachment>

When you open packing, confirms the following in the beginning.
 If any flaw, damage and shortage in the product or the attachment, etc., is found, contact the nearest dealer or the sales and support office.

- (1) Product main unit

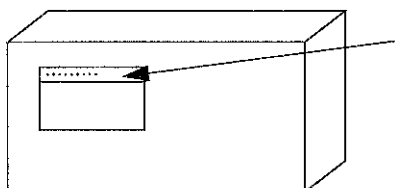

Type and name of product.

Confirm the product the same as the order from the name plate in the front panel.

- (2) Standard attachment lists.

Note: Order the addition of the attachment etc. with type name or stock No.

Name of articles	Type name	Parts code	Quantity	Remarks
Power cable	A01402	DCB-DD2428X01	1	3pins plug
AC adapter	-	JCD-AL003EX03	1 ^{*1}	3→2pin
Power fuse	-	DFT-AA6R3A	2	T6.3A/250V
R3765/67H SERIES Operating Manual	-	JR3765/67H SERIES	1 ^{*2}	Japanese
	-	ER3765/67H SERIES		English
Programming manual	-	JR3764H (PM)	1 ^{*2}	Japanese
	-	ER3764H (PM)		English
Programming guide	-	JR3752/64H (PG)	1 ^{*2}	Japanese
	-	ER3752/64H (PG)		English
Editor install disk	-	PR37670001-FK	1	HD 1.44M bytes
Sample program disk	-	PR37670003-FJ	1	DD 720k bytes

Note: ^{*1} : The AC adaptor is a standard attachment only to Japan-domestic.

^{*2} : Japanese or English is one volume.

<Option, Accessory and Recommended Kit (Extra-cost)>

(1) Option

Name	Type	Remarks
Output attenuator	Option 10	0 to 70dB
8GHz output amp	Option 11	R3767AH/BH/CH only

(2) Accessory

Name	Type	Remarks
S parameter test set	R3961B	300kHz to 3.6GHz
Duplexer test set	R3961T	
Rack-mount kit	A02713	JIS (Front handle attached)
	A02712	EIA (Front handle attached)
Slide rail set	A02642	

(3) Recommended kit

Name	Type	Remarks	
		Frequency range	Connector type
Calibration kit	Model 9617A3	DC to 18GHz	N type
Calibration kit	Model 9617F3	DC to 18GHz	3.5mm type
Calibration kit	Model 9617C3	DC to 4GHz	N type
Calibration kit	Model 9617H3	DC to 4GHz	3.5mm type

TABLE OF CONTENTS

1	GETTING STARTED	1-1
1.1	Product Description	1-1
1.2	Environmental Conditions	1-2
1.3	Supply Description	1-3
1.3.1	Power Supply Specifications.....	1-3
1.3.2	Replacing the Power Fuse.....	1-3
1.3.3	Connecting the Power Cable.....	1-4
1.4	FET Probe	1-5
1.5	System Setup Cautions	1-6
1.5.1	Notes on the use of Parallel I/O Ports.....	1-6
1.5.2	Notes on the use of Serial I/O ports.....	1-6
1.6	Measurement Time	1-6
1.7	Input Signal Level Overload Cautions	1-6
1.8	How to Replace the Protective Fuse for Bias Input	1-7
1.9	Cleaning, Storage and Transportation	1-8
1.10	Notes on Use	1-9
2	PANEL DESCRIPTION	2-1
2.1	Front Panel Descriptions	2-1
2.1.1	R3765AH/3767AH	2-1
2.1.2	R3765BH/3767BH	2-3
2.1.3	R3765CH/3767CH	2-5
2.2	Rear Panel Descriptions	2-7
2.2.1	R3765AH/3767AH	2-7
2.2.2	R3765BH/3767BH	2-9
2.2.3	R3765CH/3767CH	2-11
2.3	Screen Display Descriptions	2-13
3	BASIC OPERATING GUIDELINES	3-1
3.1	Initial Power-on	3-1
3.2	Operation Keys	3-3
3.2.1	Panel Keys and Soft Keys	3-3
3.3	How to Read the Display Screen	3-7
3.4	Basic Measuring Procedure	3-8
3.5	Measurement Samples of Simple Transmission Characteristics	3-9
3.5.1	Setup and Setting	3-9
3.5.2	Calibration (Normalize)	3-11
3.5.3	Magnitude measurement	3-11
3.5.4	Phase measurement.....	3-13
3.5.5	Group delay measurement	3-15
3.6	Measurement Samples of Simple Reflection Characteristics	3-17

Table of Contents

3.6.1	Setup.....	3-17
3.6.2	Calibration (1-port full calibration).....	3-20
3.6.3	Measurement by various formats.....	3-22
4	BASICS OPERATION	4-1
4.1	Basic Keys Operations	4-1
4.2	Basic Key Operation Examples	4-1
4.3	Soft Key Menu Configuration	4-2
4.4	Initial Setup	4-3
4.4.1	How to Initialize.....	4-3
4.4.2	Initial Setup Value	4-3
4.5	Setting Backup Memory (Factory Default Settings)	4-6
5	MEASUREMENT METHOD EXAMPLE	5-1
5.1	Measurement of Transmission Characteristic (2 Trace Display)	5-1
5.1.1	Overlap Display Mode (Two Traces per Screen Measurement).....	5-1
5.1.2	Split Display	5-5
5.2	Transmission Reflection Characteristic Measurement (Four Screen Display Mode)	5-8
5.2.1	Setup.....	5-8
5.2.2	Calibration (two port full calibration).....	5-9
5.2.3	Four Screen Display	5-15
5.3	Narrow Band/Wide Band Sweep Measurement	5-19
5.4	Multi-marker List Display	5-21
5.5	Ripple Measurement in the Bandwidth	5-23
5.6	Measurement of Electrical Length	5-26
5.7	High-speed Measurement Using the Program Sweep Function	5-29
5.8	GO/NG Measurement Using Limit Line Function	5-33
6	RECORD and OUTPUT	6-1
6.1	Output of Measured Data to the Plotter	6-1
6.2	Using the Save/Recall Register	6-4
6.3	Saving to the Floppy Disk	6-6
6.3.1	About the Measurement Data to Save.....	6-8
7	FUNCTION DESCRIPTIONS	7-1
7.1	ACTIVE CHANNEL Block	7-1
7.2	ENTRY Block	7-3
7.3	STIMULUS Block	7-5
7.3.1	Setting Signal Source	7-6
7.3.2	Interlocking between Channels.....	7-7
7.4	RESPONSE Block	7-9

7.4.1	Setting Input and Parameter Conversion	7-10
7.4.2	Display Data Format	7-12
7.4.3	Setting Display Coordinate Scale	7-13
7.4.4	Four Screen Display and Display Selection Information	7-14
7.4.5	Display Layout	7-15
7.4.6	Trace Data Selection	7-20
7.4.7	TRACE Operation	7-21
7.4.8	Label Input	7-22
7.4.9	Colors Settings.....	7-23
7.4.10	Averaging/Smoothing and Resolution Bandwidth.....	7-25
7.5	Calibration	7-27
7.5.1	Normalizing	7-27
7.5.2	Normalize & Isolation Calibration.....	7-28
7.5.3	1-Port Full Calibration	7-28
7.5.4	2-Port Full Calibration	7-29
7.5.5	Calibration Method.....	7-31
7.5.6	Interpolating Calibration Data	7-37
7.5.7	Calibration Kit Selection.....	7-38
7.5.8	Parameters Entry of an User-selected Calibration Kit	7-39
7.5.9	Extending Measurement Reference Plane	7-41
7.5.10	Calibration Data Clear.....	7-43
7.6	Marker Function	7-44
7.6.1	Setting Marker.....	7-45
7.6.2	Marker Coupling between Channels.....	7-46
7.6.3	Interpolation between Measurement Points.....	7-48
7.6.4	Displaying Marker Read out Value	7-48
7.6.5	Delta-Marker Function	7-49
7.6.6	Marker Menu during Impedance Measurement	7-52
7.6.7	Marker Analysis Function.....	7-53
7.7	Time Domain Function (Option 70)	7-64
7.7.1	Time Domain Transformation Function.....	7-64
7.7.2	Window Processing	7-65
7.7.3	Gate Function	7-66
7.8	CDMA IF Filter Analysis Function	7-67
7.9	Sweep	7-70
7.9.1	Setting Sweep Type.....	7-70
7.9.2	Editing Segment of User Frequency Sweep	7-71
7.9.3	Editing Segment of Program Sweep.....	7-72
7.10	INSTRUMENT STATE Block	7-74
7.10.1	System Menu	7-75
7.11	Limit Function	7-77
7.11.1	Limit Menu	7-77
7.12	GPIB Block	7-83
7.12.1	Controller Menu	7-84

Table of Contents

7.12.2 GPIB Menu	7-85
7.13 Save/Recall	7-86
7.13.1 Selection of Save Type	7-86
7.13.2 Executing Save Register.....	7-87
7.13.3 Executing Store File.....	7-89
7.13.4 Setting Register Name	7-90
7.13.5 Setting File Name	7-91
7.13.6 Clearing Saved Register.....	7-92
7.13.7 Purging Stored File	7-93
7.13.8 Executing Recall	7-93
7.14 Hard Copy	7-96
7.14.1 Setting Plot Scale.....	7-97
7.14.2 Selecting Plot Data	7-98
7.14.3 Specifying Pen	7-99
7.14.4 Plotter Setup	7-100
7.14.5 Printer Setup.....	7-102
7.15 Communication with Peripheral Devices	7-104
7.15.1 Parallel I/O Port.....	7-104
7.15.2 RS-232 Interface.....	7-113
8 IN ABNORMALITIES	8-1
8.1 Inspection and Simple Troubleshooting	8-1
8.2 Error Messages	8-2
8.2.1 Hardware Trouble	8-2
8.2.2 Notice of Hardware Information	8-3
8.2.3 Operating Error	8-4
8.2.4 Warning of Internal Set, Change, etc.....	8-9
8.2.5 Completed Operation Conditions Messages	8-12
9 THE PRINCIPLE	9-1
9.1 The Principle	9-1
9.2 Data Flow	9-2
9.3 Block Diagram	9-3
9.3.1 R3765AH/3767AH Diagrammatic Sketch of Block	9-3
9.3.2 R3765BH/3767BH Diagrammatic Sketch of Block	9-4
9.3.3 R3765CH/3767CH Diagrammatic Sketch of Block	9-5
10 PERFORMANCE TEST	10-1
10.1 Preparing for a Performance Test	10-1
10.1.1 Warm up	10-1
10.1.2 Preparing Measurement Instrument	10-1
10.1.3 General Note.....	10-2
10.2 Frequency Accuracy and Range	10-3

10.3 Output Level Accuracy and Flatness	10-4
10.3.1 Setup.....	10-4
10.3.2 Output Level Accuracy.....	10-4
10.3.3 Flatness	10-5
10.4 Output Level Linearity	10-5
10.5 Directivity	10-7
10.6 Load Match of Test Port	10-8
10.6.1 When R3765AH/3767AH	10-8
10.6.2 When R3765BH/3767BH	10-10
10.6.3 When R3765CH/3767CH.....	10-11
10.7 Noise Level	10-13
10.8 Crosstalk	10-14
10.8.1 When R3765AH/3767AH	10-14
10.8.2 When R3765BH/3767BH	10-16
10.8.3 When R3765CH/3767CH.....	10-17
 11 SPECIFICATIONS	 11-1
 APPENDIX	 A-1
A.1 The Relation of Data between each Function	A-1
A.1.1 The Relation of Data between each Channel and each Function.....	A-1
A.1.2 The Data Interlocking to each Item in MEAS Menu.	A-2
A.2 Measuring Time	A-3
A.3 Initial Setting	A-4
A.4 Soft Key Menu List	A-9
A.5 Other Information	A-22
A.5.1 Error Message	A-22
A.5.2 Setting of Backup Memory (at the factory-shipped).....	A-22
A.5.3 GPIB Command List for Panel Key/Soft Key	A-22
 DIMENSIONAL OUTLINE DRAWING	 EXT-1
 ALPHABETICAL INDEX	 I-1

LIST OF ILLUSTRATIONS

No.	Title	Page
1-1	Operating Environment	1-2
1-2	Power Cable and AC Adapter	1-4
1-3	Connecting FET Probe	1-5
1-4	Replacement of protective fuse for bias input	1-7
2-1	Front-Panel Descriptions (R3765AH/3767AH)	2-1
2-2	Front-Panel Descriptions (R3765BH/3767BH)	2-3
2-3	Front-Panel Descriptions (R3765CH/3767CH)	2-5
2-4	Rear Panel Descriptions (R3765AH/3767AH)	2-7
2-5	Rear Panel Descriptions (R3765BH/3767BH)	2-9
2-6	Rear Panel Descriptions (R3765CH/3767CH)	2-11
2-7	Screen Display Descriptions	2-13
3-1	Connecting the Power Cable	3-1
3-2	Power Switch	3-2
3-3	Setting Screen When Switch on or Preset (for R3767CH)	3-2
3-4	Panel Keys and Soft Keys	3-3
3-5	Displayed Active Area	3-5
3-6	How to Set Data	3-6
3-7	Annotation on the Screen (Annotation Character)	3-7
3-8	The Setup of Transmission Characteristic Measurement (AH Type)	3-9
3-9	The Setup of Transmission Characteristic Measurement (BH/CH Type)	3-9
3-10	Screen of Frequency Characteristic Normalize	3-11
3-11	Auto-scale of Magnitude Measurement	3-12
3-12	Filter Analyzing Function (3dB Bandwidth and Q Measurement)	3-12
3-13	Filter Analyzing Function (6dB Bandwidth and Q Measurement)	3-13
3-14	Auto-scale of Phase Measurement	3-14
3-15	Phase Extension Display	3-14
3-16	Auto-scale of Group Delay Measurement	3-15
3-17	Change of Group Delay Aperture	3-16
3-18	Setup (1) for AH Type Reflection Characteristics Measurement	3-17
3-19	Setup (2) for AH Type Reflection Characteristics Measurement	3-18
3-20	Setup for Reflection Characteristic Measurement	3-18
3-21	1-Port Full Calibration (Open)	3-20
3-22	1-Port Full Calibration (Short)	3-21
3-23	1-Port Full Calibration (Load)	3-21
3-24	Return Loss Measurement	3-22
3-25	Reflection Coefficient Measurement	3-23
3-26	Standing Wave Ratio (SWR) Measurement	3-24
3-27	S Parameter Measurement	3-25
3-28	Impedance Measurement	3-25
5-1	Auto-scale of the First trace of Magnitude/Phase Measurement (Overlap Display)	5-2
5-2	Auto-scale of the Second trace of Magnitude/Phase Measurement (Overlap Display)	5-3

NETWORK ANALYZER OPERATION MANUAL

List of Illustrations

No.	Title	Page
5-3	Logarithmic Magnitude/Group Delay Measurement (Overlap Display)	5-4
5-4	Linear Magnitude/Phase Measurement (Overlap Display)	5-4
5-5	Logarithmic Magnitude/Phase Measurement (Split Display)	5-6
5-6	Logarithmic Magnitude/Group Delay Measurement (Split Display)	5-7
5-7	Linear Magnitude/Phase Measurement (Split Display)	5-7
5-8	Setup of AH Type S Parameter Measurement	5-8
5-9	Setup of the Reflection Characteristic Measurement	5-9
5-10	Calibration of 2-Port Reflection (Test Port/Open)	5-10
5-11	Calibration of 2-Port Reflection (Test Port/Short)	5-10
5-12	Calibration of 2-Port Reflection (Test Port/Load)	5-11
5-13	Execution of 2-Port Reflection Characteristic Calibration	5-12
5-14	Calibration of 2-Port Transmission Characteristic (Forward Direction)	5-12
5-15	Execution of 2-Port Transmission Characteristic Calibration	5-13
5-16	Execution of the Isolation Calibration	5-14
5-17	Execution of 2-Port Full Calibration	5-14
5-18	4 Screen Display (Channel 1)	5-15
5-19	4 Screen Display (Overlap Display of Channel 1 and 3)	5-16
5-20	4 Screen Display (Split Display of Channel 1 and 3)	5-16
5-21	4 Screen Display (Channel 2)	5-17
5-22	4 Screen Display (Split Display of Channel 2 and 4)	5-18
5-23	The Finished 4 Screen Display	5-18
5-24	Two Channels Simultaneous Display (Overlap Display)	5-20
5-25	Two Channels Simultaneous Display (Split Display)	5-20
5-26	Multi-marker Display	5-22
5-27	Display of Multi-marker List	5-22
5-28	Specification of Delta Section (Partial Search)	5-24
5-29	Measurement of Maximum Value in the Delta section	5-24
5-30	Measurement of Minimum Value in the Delta Section	5-25
5-31	Measurement of Ripple in the Delta Section	5-25
5-32	Electrical Length of Cable	5-26
5-33	Electrical Length Correction Mode	5-27
5-34	Measurement of Electrical Length	5-28
5-35	Linear Sweeping	5-29
5-36	Setting of Program Sweeping	5-30
5-37	Execution of the Program Sweep	5-31
5-38	Change of the Program Sweep	5-32
5-39	Screen before Execution of Limit Line Measurement	5-33
5-40	Setting of the Limit Line	5-34
5-41	Limit Line Editing	5-34
5-42	Setting of Segment 0	5-35
5-43	Setting of Each Segment	5-36
5-44	Execution of Limit Test	5-37
5-45	Change of Limit Line	5-38
6-1	Setting of Plotter GPIB Address	6-1
6-2	Change of Plotter Initial Setup Value (Initial Value)	6-2
6-3	Output Data to the Plotter	6-3

No.	Title	Page
6-4	Output Result of the Plotter	6-3
6-5	Saving into the Save-Register	6-4
6-6	Recalling from the Recall-register	6-5
6-7	Saving to the Floppy Disk	6-7
6-8	Recall from Floppy Disk	6-8
7-1	Delta-Marker Function	7-49
7-2	Band Pass Filter Analysis/MAX Reference	7-59
7-3	Band Pass Filter Analysis/Active Marker Reference	7-60
7-4	Band Pass Filter Analysis/Reference Line Reference	7-60
7-5	Notch Filter Analysis/MAX Reference	7-61
7-6	Notch Filter Analysis/Active Marker Reference	7-61
7-7	Notch Filter Analysis/Reference Line Reference	7-62
7-8	Example of Filter Analysis Execution	7-62
7-9	The Screen before the Segment Edited	7-73
7-10	The Screen after the Segment Edited	7-73
7-11	File List Display	7-87
7-12	Label Window Display	7-90
7-13	Register List Display	7-90
7-14	Setting DIP Switches	7-100
7-15	Timing Chart of WRITE STROBE	7-104
7-16	Parallel I/O (36-pin) Connector Pin Assignment and Signal	7-106
7-17	Schematic Circuit Diagram of Parallel I/O Port	7-107
9-1	Data Flow	9-2
10-2	Frequency Accuracy and Range	10-3
10-3	Output Level Accuracy and Flatness	10-4
10-4	Output Level Linearity	10-6

LIST OF TABLES

No.	Title	Page
2-1	Front-Panel Descriptions (R3765AH/3767AH)	2-2
2-2	Front-Panel Descriptions (R3765BH/3767BH)	2-4
2-3	Front-Panel Descriptions (R3765CH/3767CH)	2-6
2-4	Rear Panel Descriptions (R3765AH/3767AH)	2-8
2-5	Rear Panel Descriptions (R3765BH/3767BH)	2-10
2-6	Rear Panel Descriptions (R3765CH/3767CH)	2-12
2-7	Screen Display Descriptions	2-14
4-1	Initial Setup Value (1 of 3)	4-3
4-2	Initial Setup Value (2 of 3)	4-5
4-3	Initial Setup Value (3 of 3)	4-6
4-4	Setting Backup Memory	4-6
7-1	Combination of InterpolaSweep Type (o; possible, x; impossible)	7-37
7-2	Status Display	7-37
7-3	DSW1 Function	7-101
7-4	DSW2 Function	7-101
10-1	Required Measurement Instrument for Performance Test (1 of 2)	10-1

1 GETTING STARTED

This chapter gives a brief explanation of product, its working environment and operational precautions. Read this chapter before you use the product.

1.1 Product Description

R3765/3767H series is the 3.8GHz/8GHz vector network analyzer, which has newly been designed based on a concept "an optimum tool for each application".

We have fully pursued high throughput such as 0.15ms/points high-speed measurement at a resolution bandwidth (RBW) of 10kHz, 100dB wide dynamic-range measurement, and two-device simultaneous measurement with four-channel/eight-trace display.

Also, we have added the program sweeping function that can freely change the resolution bandwidth (RBW) and output level during sweep operation for each segment.

With the built-in BASIC controller, a high-speed ATE system can be easily configured with no external controller for processes from adjustment to inspection.

<Features>

- (1) High throughput
 - In the case of C type, 4 S parameters can be displayed in a screen by 0.15ms/point high-speed frequency sweeping and four-channel/eight-trace (RBW 10kHz).
 - 0.15ms/point high-speed level sweeping.
- (2) Wide dynamic range
 - 100dB wide dynamic range.
- (3) Program sweeping function.
 - For each segment, allows setting of frequency, output level, RBW and settling time.
- (4) MS-DOS formatted disk
 - By using an MS-DOS personal computer, it is possible to easily create programs and analyze data because of the disk conformed to MS-DOS format standard.
 - Three modes of storage capacity available (DD 720KB, HD 1.2MB, HD 1.4MB).

1.2 Environmental Conditions

1.2 Environmental Conditions

• Operating Environment

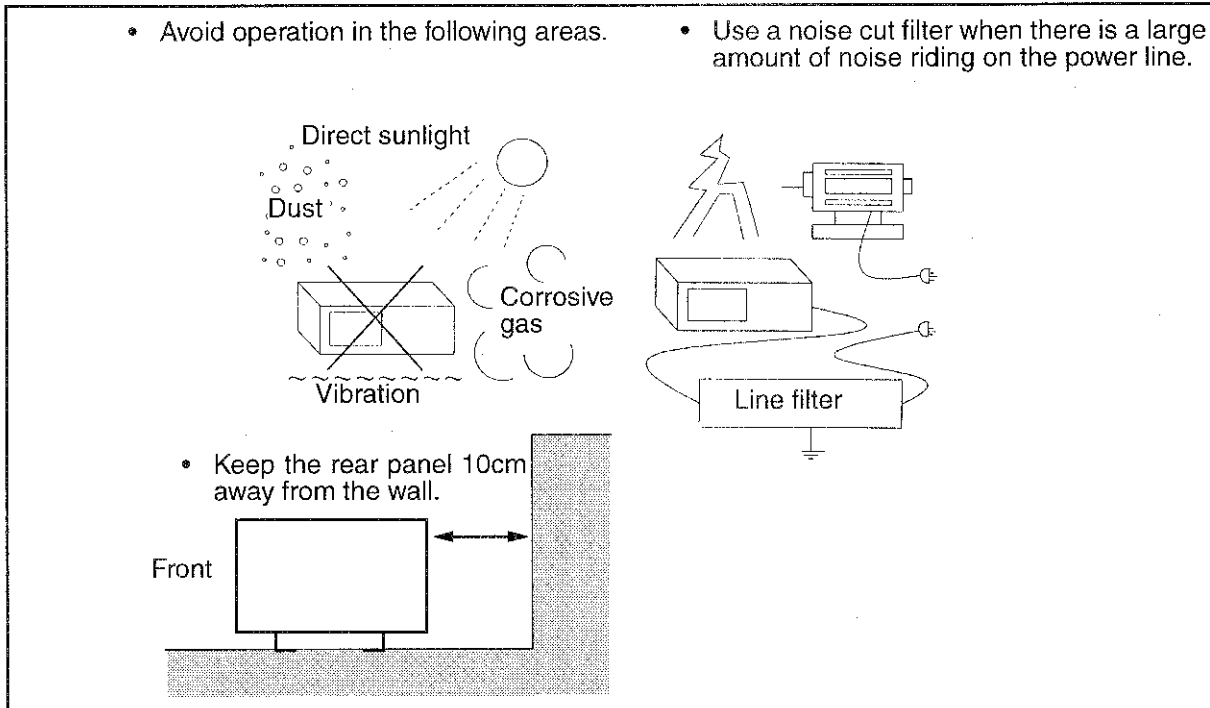

Figure 1-1 Operating Environment

The R3765/3767H series should be installed in an area which satisfies the following conditions:

- Ambient temperature : +5°C to +40°C (Operating temperature range: When FDD is used.)
0°C to +50°C (Operating temperature range: When FDD is not used.)
-20°C to +60°C (Storage temperature range)
- Relative humidity : PH80% or less (no condensation)
- An area free from corrosive gas
- An area away from direct sunlight
- A dust-free area
- An area free from vibrations
- A low noise area

Although the R3765/3767H series has been designed to withstand a certain amount of noise riding on the AC power line, it should be used in an area of low noise. Use a noise cut filter when ambient noise is unavoidable.

For highly accurate measurement, turn the power ON after the R3765/3767H series temperature has reached the room temperature level, and warm up the R3765/3767H series for 60 minutes.

• Installation position

The R3765/3767H series has an air outlet hole on its rear panel. Never block or plug the hole, as the resulting internal temperature rise will affect measurement accuracy.

1.3 Supply Description

1.3.1 Power Supply Specifications

WARNING!

Safety use the R3765/3767H series according to the power requirement.

The R3765/3767H series might be damaged in the case not following the power requirement.

The power requirement of the R3765/3767H series is shown in the following.

Use the power supply by which the power requirement of the R3765/3767H series is satisfied.

	100V _{AC} operation	220V _{AC} operation
Input voltage range	90V - 132V	198V - 250V
Frequency range	48Hz - 66Hz	
Power fuse	T6.3A/250V	
Power consumption	300VA or below	

*The supply voltage of the R3765/3767H series is automatically changed over (100/240V).

1.3.2 Replacing the Power Fuse

WARNING!

1. Before replacing the power fuse, be sure to turn the power switch OFF and remove the power cable from the outlet.
2. For continued protection against fire hazard, use a fuse of the type and rating which match the supply voltage.

Power fuse is located in the power connector on the rear panel.

To check or replace the power fuse as follows.

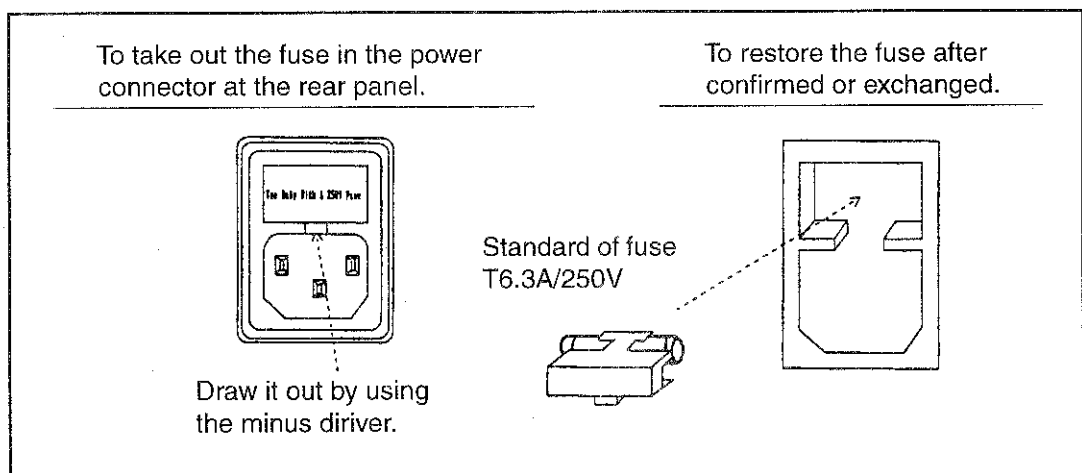

1.3 Supply Description

1.3.3 Connecting the Power Cable

WARNING!

1. Power cable

- Use power cable of the attachment for prevention electric shock and fire.
- Use power cable in accordance with the safety standard of the country for use excluding Japan.
- When you connect power cable with the outlet, turn off the power switch.
- When you pull out power cable from the outlet, have the plug.

2. Protective earth

- Connect the power plug cable with the power outlet which has the protective earth terminal.
- If the code for the extension without the protective earth terminal is used, the protective earth will become invalid.
- Case in which use of AC adapter (Three pins to two pins conversion adapter), connect the earth pin of the adapter to the earth of the outlet, or connect ground terminal of the rear panel with the earth of the outside, and ground it to the earth.

(1) Power plug and cable

Since 3-core power receptacles are rare in Japan, a 3-pin to 2-pin adapter (AC adapter) is attached to the R3765/3767H series. Be sure to connect the ground pin of the adapter to the ground line when connecting the power cable to a receptacle with this conversion adapter.

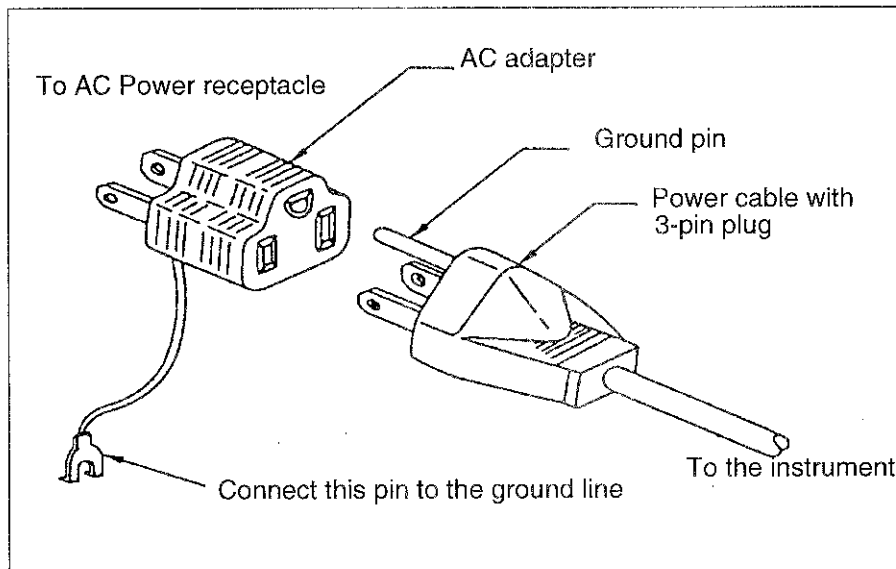

Figure 1-2 Power Cable and AC Adapter

(2) Power plug for overseas use

A separately-sold plug for overseas use is available. For more information, contact ADVANTEST's Service Department.

1.4 FET Probe

(1) Setup

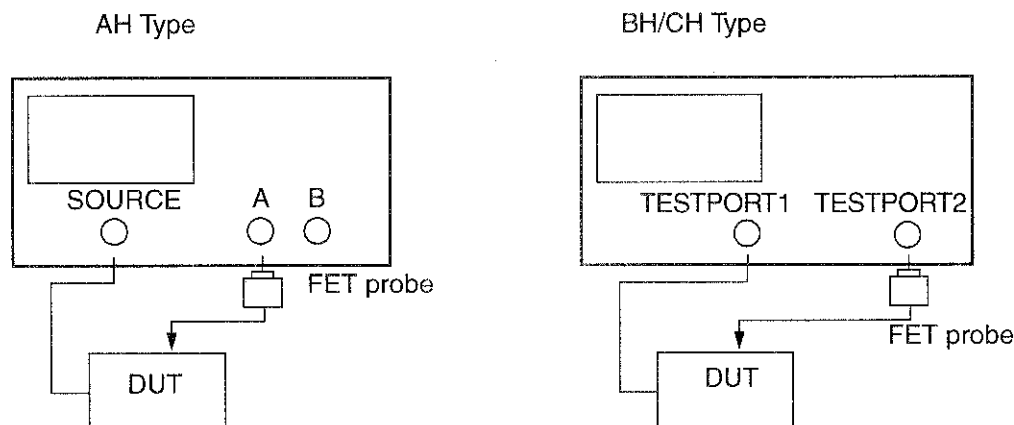

Figure 1-3 Connecting FET Probe

(2) Usage Precautions

The stability and repeatability of the measurement value are affected by the ground of FET probe tip. In high frequency, it is necessary to consider the effect of parallel capacitance. The input impedance of the FET probe is listed in the following Table.

Model name	Input impedance	Remarks
P6201 type	100kΩ ±1% parallel 3PF Attenuator head 1MΩ ±1%, 1.5PF in parallel.	DC to 900MHz Manufactured by SONY Tektronix
P6202A type	10MΩ ±2% Approx. 2PF Approx. 4PF with the optional coupling cap.	DC to 500MHz Manufactured by SONY Tektronix

(3) Calibration and Measurement Method

Operation procedure

- ① Connect the FET probe to the reference point of the device under test.
- ② Select the calibration menu of the R3765/3767H series to normalize the frequency characteristic probe.
- ③ Connect the FET probe to the point to be measured, then perform the measurement.

Note : When measuring the point in high frequency, note that the data repeatability will be changed by the ground condition of the FET probe tip.

1.5 System Setup Cautions

1.5 System Setup Cautions

1.5.1 Notes on the use of Parallel I/O Ports

- (1) In +5V power output from parallel I/O port, maximum current capacity is 100mA.
Use it within 100mA.
- (2) In +5V power output from parallel I/O port, there is a fuse.
The fuse fuses with the over current of 100mA or more.
In the case with which the fuse fuses, contact to the nearest dealer or the sales and support offices.
- (3) Use the shield cable for the cable for parallel I/O port. (To prevent malfunction by noise)
- (4) The standard of the cable for the radiation test of the R3765/3767H series is MO-27.
- (5) Do not bundle I/O cable and AC power line when wiring.

1.5.2 Notes on the use of Serial I/O ports

- (1) The length of the cable used for serial I/O port is 15m or less.
- (2) Use the shield cable for the cable for serial I/O port. (To prevent malfunction by noise)
- (3) The standard of the cable used for the radiation test of the R3765/3767H series is A01235.
- (4) Do not bundle I/O cable and AC power line when wiring.

1.6 Measurement Time

The sweeping time of the R3765/3767H series is determined by frequency set-up time and data acquiring time.

As the SWEEP TIME on the display screen shows the data acquiring time, the actual sweep time becomes longer than the displayed SWEEP TIME under the influence of frequency set-up time.

Refer to APPENDIX for details.

1.7 Input Signal Level Overload Cautions

The maximum level at the input part of R3765AH/3765BH and R3767AH/3767BH is 0dBm.

R3765CH/3767CH is +15dBm.

If more than about 5dB over the maximum level is input, "Overload" is displayed.

1.8 How to Replace the Protective Fuse for Bias Input

For R3765CH/3767CH type, the protective fuse for TEST PORT input bias is located in the fuse holder on the rear panel. (Refer to sub-section 2.2.3.)

Note: *When the protective fuse for bias input is replaced, turn OFF the POWER switch of the R3765/3767H series and remove the power cable from the receptacle beforehand.*

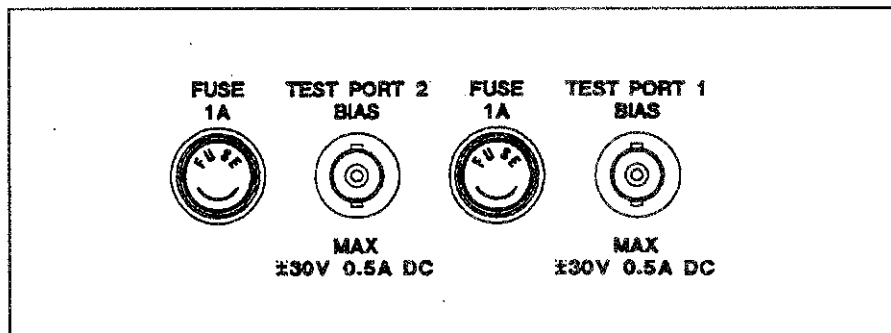

Figure 1-4 Replacement of protective fuse for bias input

Replacement procedure

- ① Turn the cap of fuse holder counterclockwise to remove.
 - ② Take out this turned part and replace the fuse.
 - ③ Install the turned part.
- Tighten clockwise.

Standard of protective fuse for bias input

Name of type: TMF51NR1(250)

Part code : DFN-AA1A-3

Rating : Fast blow, 250V, 1A

WARNING!

When the fuse is replaced, use the same type and the same rating of fuse to protect against the danger of fire.

1.9 Cleaning, Storage and Transportation

1.9 Cleaning, Storage and Transportation

(1) Cleaning

Wipe the dirt of the R3765/3767H series off with a soft cloth (or wet cloth). At this time, attend to the following points.

- Do not remain the fluff of the cloth and do not soak water into the internal of the R3765/3767H series.
- Do not use an organic solvent (for example, benzene and acetone, etc.) which changes plastics in quality.

(2) Storage

Storage temperature of the R3765/3767H series is from -20°C to +60°C. Do not store it out of this temperature range.

The cases in which the R3765/3767H series is not used for a long time, cover with the vinyl cover or put in the cardboard box and prevent dust. Keep it in a dry place where dust and direct sunshine are prevented.

(3) Transportation

When you transport the R3765/3767H series, pack it equally to the first packing material or any more.

Packing procedure

- ① Wrap the R3765/3767H series itself with cushion material and put in the cardboard box.
- ② After putting attachment, put cushion again.
- ③ Shut the lid of the cardboard box. Fix the outside with a string or tape.

1.10 Notes on Use

(1) Before starting the measurement

When turning on the power, don't connect DUT.

Before starting the measurement, check to see the output power level.

(2) Removing of case

Do not open the case to one except service man of our company.

The R3765/3767H series has a high temperature part and a high pressure part.

(3) When abnormality occurs

When smoke rises from the R3765/3767H series, smell nastily, or rear unusual sound feel, turn off the power switch. Pull out power cable from the outlet. And contact to our company.

The address and the telephone number of our company are in the end of this manual.

(4) Warm up

After the R3765/3767H series temperature has reached the room temperature level, turn the power switch ON and warm it up for 30 minutes.

(5) Electromagnetic interference.

High frequency noise of the small power is generated at the R3765/3767H series use.

Therefore, electromagnetic interference is generated to the television or the radio by an improper installation and use of the R3765/3767H series.

If the power of the R3765/3767H series is turned off, and the electromagnetic interference is reduced, then the R3765/3767H series is the cause it.

Prevent electromagnetic interference by the following procedure.

- Change the direction of antenna of the television or the radio.
- Place the R3765/3767H series the other side of the television or the radio.
- Place the R3765/3767H series away from the television or the radio.
- Use another line of power source for the television or the radio than the R3765/3767H series.

(6) Cautions when scrapping the R3765/3767H series

When the products are scrapped, be careful to treat them properly.

Call for the inquiry about how to scrap, etc. to the nearest our service station. The addresses and the telephone numbers are at the end of this manual.

Harmful substances :

- ① PCB (Polychlorinated biphenyl)
- ② Mercury
- ③ Ni-Cd (Nickel-cadmium)
- ④ Others

Substances that contain cyan, organic phosphorous, and hexadic chromium, and substances that might dissolve and flow out cadmium, lead or arsenic. (Except lead for soldering.)

1.10 Notes on Use

(7) Life time of parts

The following consumable parts are used in the R3765/3767H series.

Soft key switch	500,000 times operating life
LCD (liquid crystal display) back light	7000 hours operating life

2 PANEL DESCRIPTION

The names and the functions of each part on the front and rear panel side and the display screen are described.

2.1 Front Panel Descriptions

2.1.1 R3765AH/3767AH

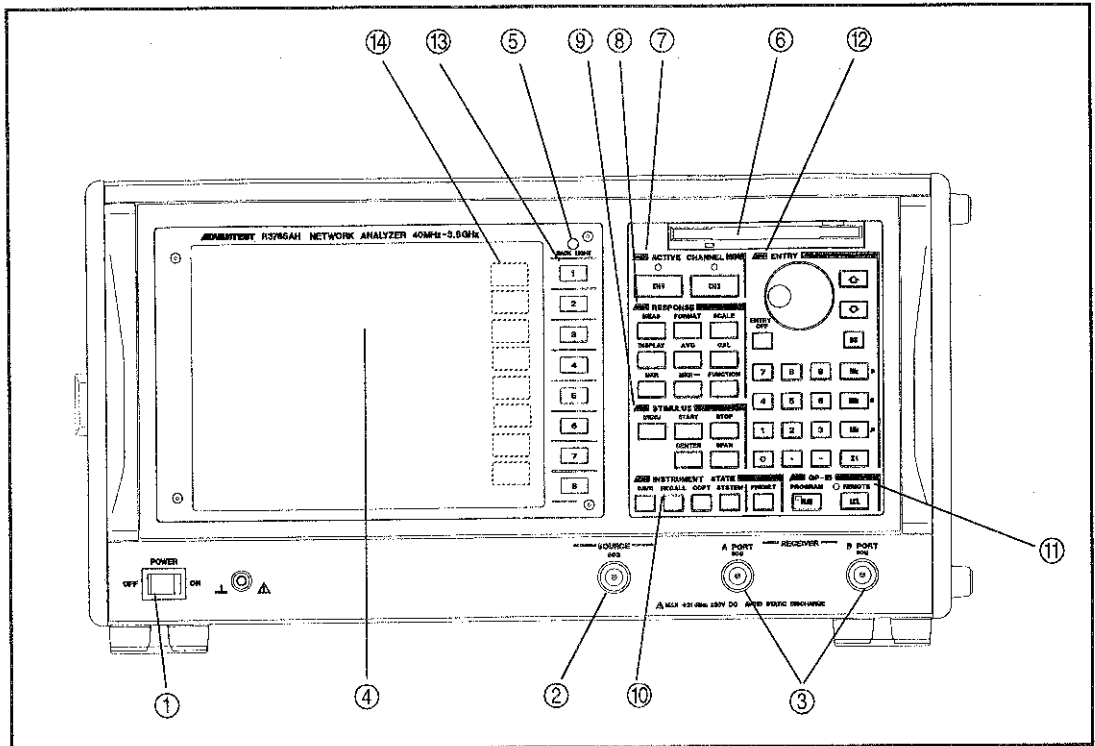

Figure 2-1 Front-Panel Descriptions (R3765AH/3767AH)

2.1 Front Panel Descriptions

Table 2-1 Front-Panel Descriptions (R3765AH/3767AH)

No.	Name	Description
①	POWER switch	Turns on or off the power supply of the R3765AH/3767AH.
②	SIGNAL SOURCE OUTPUT connector (SOURCE)	Power splitter output.
③	RECEIVER SECTION INPUT connector A PORT B PORT	The INPUT connector is used for measurement input.
④	LCD display	Displays measurement data, setting conditions and other informations.
⑤	BACK LIGHT	Selects the back light ON/OFF of LED display.
⑥	Floppy disk drive	Stores a program and measurement data. Three modes of storage capacity (DD: 720KB, HD: 1.2MB, HD: 1.44MB).
⑦	ACTIVE CHANNEL block	The ACTIVE CHANNEL block is used to select an active channel between independently two measurement channels. Each channel has a sub-measurement screen which can be selected by toggle. Sub-measurement screen of CH1 : CH3 Sub-measurement screen of CH2 : CH4 After selecting, functions to be operated are effective to the selected active channel.
⑧	RESPONSE block	The RESPONSE block is used to set measurement conditions of receiver section, data display and data analysis.
⑨	STIMULUS block	The STIMULUS block is used to set frequencies, level and sweep conditions of signal source.
⑩	INSTRUMENT STATE block	The INSTRUMENT STATE block is used set the system functions which have no concern with the measurement.
⑪	GPIB block	The GPIB block is used to set a GPIB and controller functions.
⑫	ENTRY block	The ENTRY block is used to input numeric data and to perform a marker movement.
⑬	Soft key	Selects the soft key menu described in ⑭ in each function block.
⑭	Soft key menu	Displays each function menu. To select a menu, use the soft key described in ⑬.

2.1.2 R3765BH/3767BH

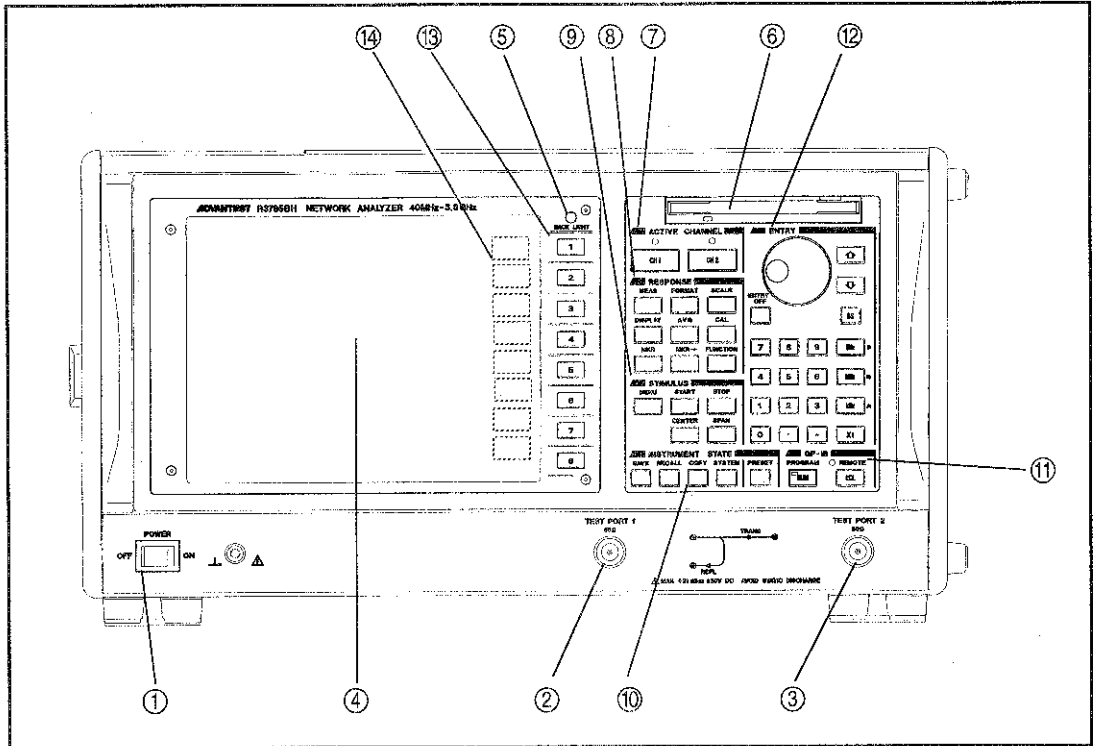

Figure 2-2 Front-Panel Descriptions (R3765BH/3767BH)

2.1 Front Panel Descriptions

Table 2-2 Front-Panel Descriptions (R3765BH/3767BH)

No.	Name	Description
①	POWER switch	Turns on or off the power supply of the R3765BH/3767BH.
②	Reflection characteristic connector TEST PORT 1	Reflection characteristic measurement port.
③	Transmission characteristic connector TEST PORT 2	Transmission characteristic measurement port.
④	LCD display	Displays measurement data, setting conditions and other informations.
⑤	BACK LIGHT	Selects the back light ON/OFF of LED display.
⑥	Floppy disk drive	Stores a program and measurement data. Three modes of storage capacity (DD: 720KB, HD: 1.2MB, HD: 1.44MB).
⑦	ACTIVE CHANNEL block	The ACTIVE CHANNEL block is used to select an active channel between independently two measurement channels. Each channel has a sub-measurement screen which can be selected by toggle. Sub-measurement screen of CH1 : CH3 Sub-measurement screen of CH2 : CH4 After selecting, functions to be operated are effective to the selected active channel.
⑧	RESPONSE block	The RESPONSE block is used to set measurement conditions of receiver section, data display and data analysis.
⑨	STIMULUS block	The STIMULUS block is used to set frequencies, level and sweep conditions of signal source.
⑩	INSTRUMENT STATE block	The INSTRUMENT STATE block is used set the system functions which have no concern with the measurement.
⑪	GPIB block	The GPIB block is used to set a GPIB and controller functions.
⑫	ENTRY block	The ENTRY block is used to input numeric data and to perform a marker movement.
⑬	Soft key	Selects the soft key menu described in ⑭ in each function block.
⑭	Soft key menu	Displays each function menu. To select a menu, use the soft key described in ⑬.

2.1.3 R3765CH/3767CH

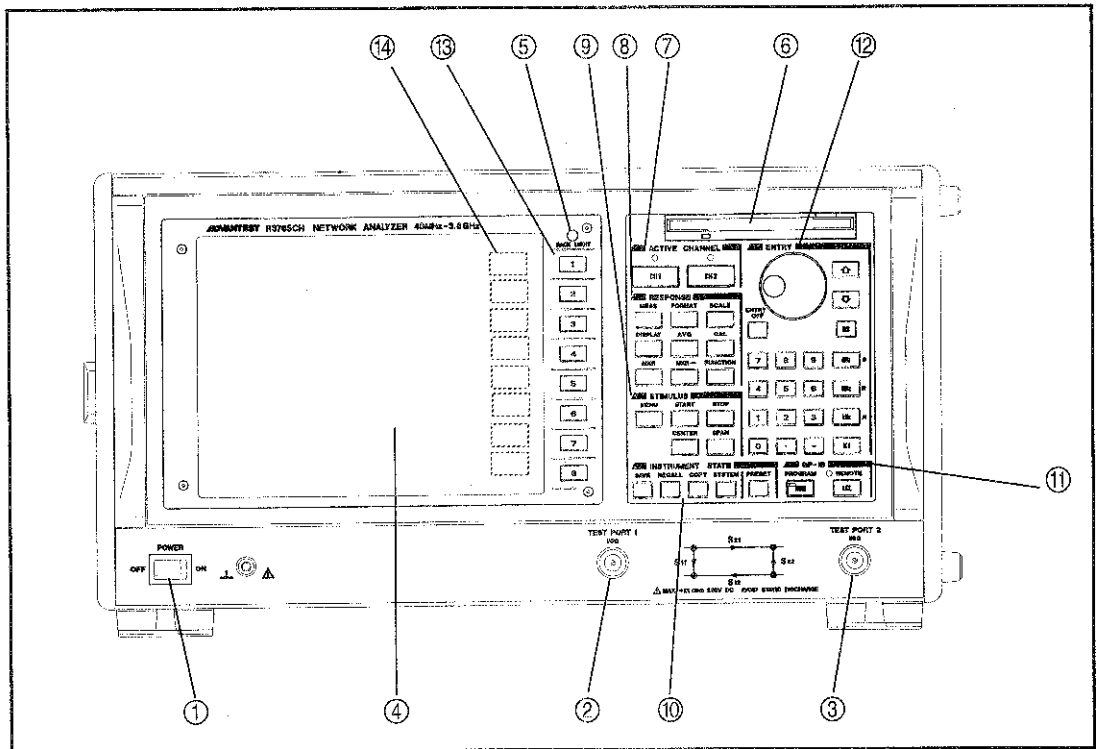

Figure 2-3 Front-Panel Descriptions (R3765CH/3767CH)

2.1 Front Panel Descriptions

Table 2-3 Front-Panel Descriptions (R3765CH/3767CH)

No.	Name	Description
①	POWER switch	Turns on or off the power supply of the R3765CH/R3767CH.
②	PORT 1 connector TEST PORT 1	Measurement of PORT 1.
③	PORT 1 connector TEST PORT 2	Measurement of PORT 2.
④	LCD display	Displays measurement data, setting conditions and other informations.
⑤	BACK LIGHT	Selects the back light ON/OFF of LED display.
⑥	Floppy disk drive	Stores a program and measurement data. Three modes of storage capacity (DD: 720KB, HD: 1.2MB, HD: 1.44MB).
⑦	ACTIVE CHANNEL block	The ACTIVE CHANNEL block is used to select an active channel between independently two measurement channels. Each channel has a sub-measurement screen which can be selected by toggle. Sub-measurement screen of CH1 : CH3 Sub-measurement screen of CH2 : CH4 After selecting, functions to be operated are effective to the selected active channel.
⑧	RESPONSE block	The RESPONSE block is used to set measurement conditions of receiver section, data display and data analysis.
⑨	STIMULUS block	The STIMULUS block is used to set frequencies, level and sweep conditions of signal source.
⑩	INSTRUMENT STATE block	The INSTRUMENT STATE block is used set the system functions which have no concern with the measurement.
⑪	GPIB block	The GPIB block is used to set a GPIB and controller functions.
⑫	ENTRY block	The ENTRY block is used to input numeric data and to perform a marker movement.
⑬	Soft key	Selects the soft key menu described in ⑭ in each function block.
⑭	Soft key menu	Displays each function menu. To select a menu, use the soft key described in ⑬.

2.2 Rear Panel Descriptions

2.2.1 R3765AH/3767AH

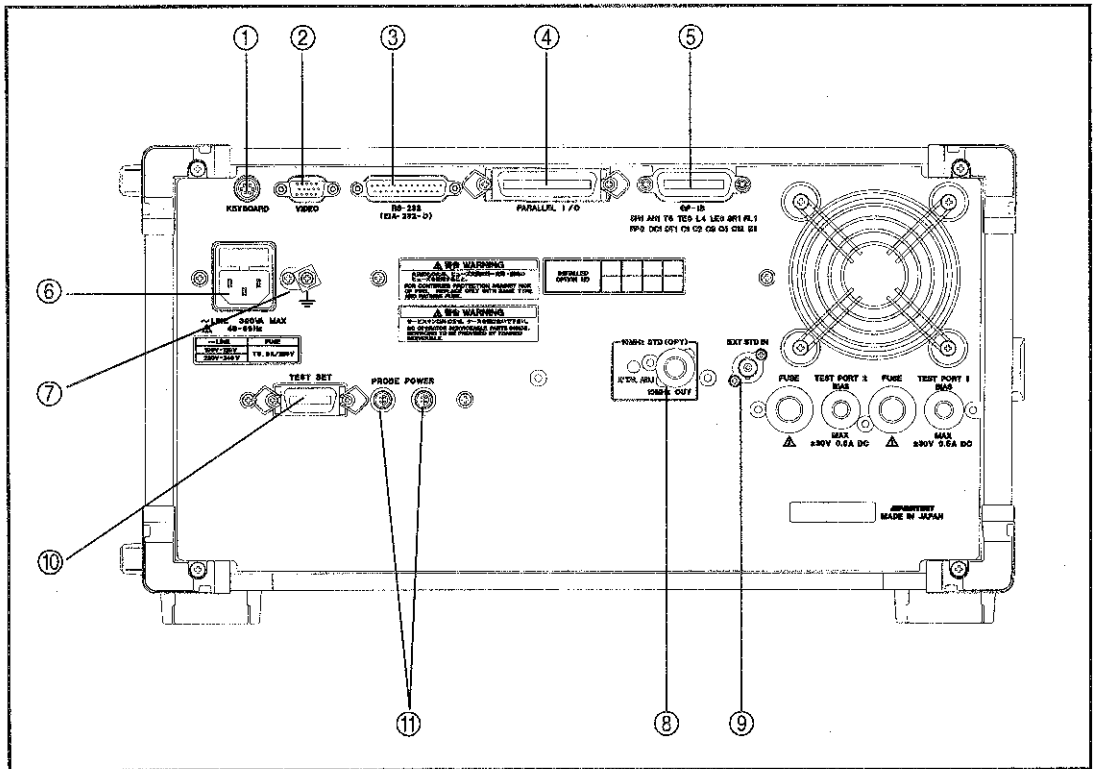

Figure 2-4 Rear Panel Descriptions (R3765AH/3767AH)

2.2 Rear Panel Descriptions

Table 2-4 Rear Panel Descriptions (R3765AH/3767AH)

No.	Name	Description
①	KEYBOARD INPUT connector	Connector to connect PS/2 type (6-pin small size DIN) key board. An external keyboard can be used to input a label name, a saving register name and a BASIC text.
②	VIDEO SIGNAL output	Video signal output correspondence to VGA. (15-pin)
③	SERIAL I/O	Input/output connector conformed to RS-232 standard. (D Sub 25-pin)
④	PARALLEL I/O connector	The I/O port connector is used to communicate peripheral devices such as an automatic machine and a foot switch. (Output: 8-bit 2 systems, Input/output: 4-bit 2 systems) EXT TRIGGER input. (Negative logic, pulse width: 1 μ s or more, 18-pin terminal) *Use shielded cables for connection (to prevent malfunction by noise).
⑤	GPIB connector	The GPIB connector is used to remotely control an external peripheral devices and to be remotely controlled by an external controller.
⑥	AC POWER connector	The AC POWER connector has three-pin structure includes an earth pin. To remove a power fuse, pull out the upper cover.
⑦	Ground terminal	The ground terminal is used to ground the R3765AH/3767AH only when three-pin connector or two-pin adapter for power cable cannot be used.
⑧	Connector for option	Spare connector for option.
⑨	External reference frequency input connector	This connector is used to input a reference frequency from an external device. Input frequency : 1, 2, 5, 10MHz, 0dBm or more Input frequency accuracy : Within ± 10 ppm
⑩	TEST SET connector	Connector for connecting S parameter test-set.
⑪	PROBE POWER connector	Connector for probe power. ± 15 V output

2.2.2 R3765BH/3767BH

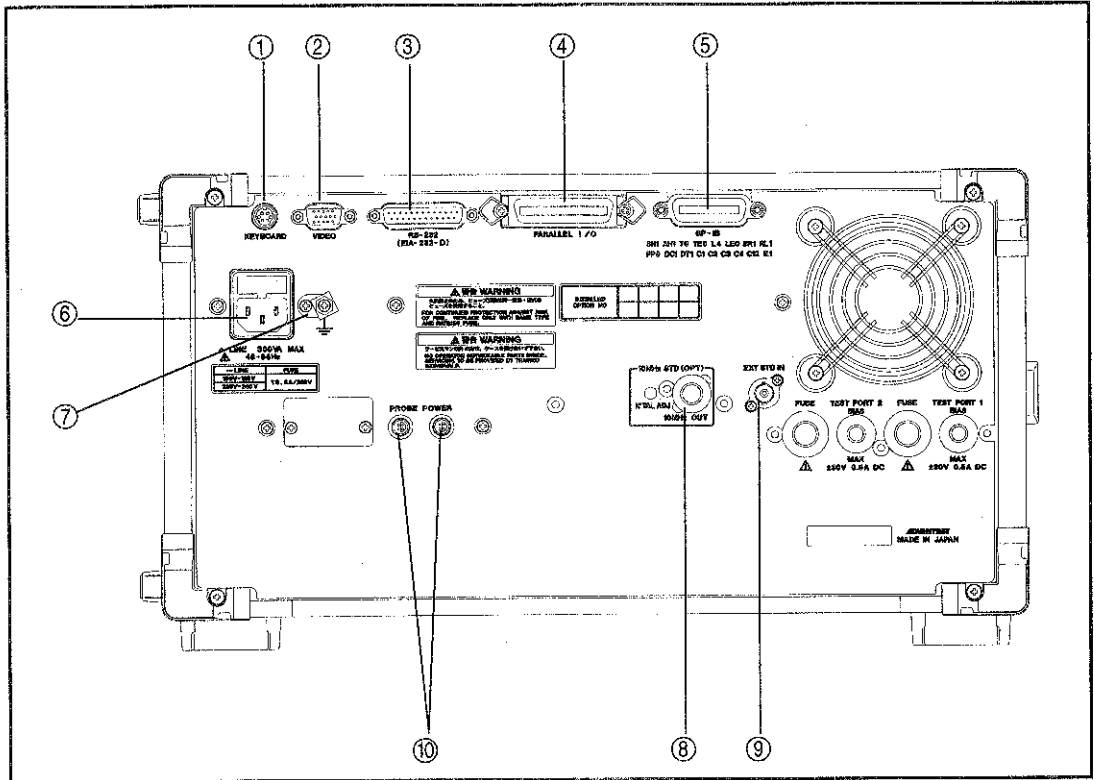

Figure 2-5 Rear Panel Descriptions (R3765BH/3767BH)

2.2 Rear Panel Descriptions

Table 2-5 Rear Panel Descriptions (R3765BH/3767BH)

No.	Name	Description
①	KEYBOARD INPUT connector	Connector to connect PS/2 type (6-pin small size DIN) key board. An external keyboard can be used to input a label name, a saving register name and a BASIC text.
②	VIDEO SIGNAL output	Video signal output correspondence to VGA. (15-pin)
③	SERIAL I/O	Input/output connector conformed to RS-232 standard. (D Sub 25-pin)
④	PARALLEL I/O connector	The I/O port connector is used to communicate peripheral devices such as an automatic machine and a foot switch. (Output: 8-bit 2 systems, Input/output: 4-bit 2 systems) EXT TRIGGER input. (Negative logic, pulse width: 1 μ s or more, 18-pin terminal) *Use shielded cables for connection (to prevent malfunction by noise).
⑤	GPIB connector	The GPIB connector is used to remotely control an external peripheral devices and to be remotely controlled by an external controller.
⑥	AC POWER connector	The AC POWER connector has three-pin structure includes an earth pin. To remove a power fuse, pull out the upper cover.
⑦	Ground terminal	The ground terminal is used to ground the R3765BH/3767BH only when three-pin connector or two-pin adapter for power cable cannot be used.
⑧	Connector for option	Spare connector for option.
⑨	External reference frequency input connector	This connector is used to input a reference frequency from an external device. Input frequency : 1, 2, 5, 10MHz, 0dBm or more Input frequency accuracy : Within ± 10 ppm
⑩	PROBE POWER connector	Connector for probe power. ± 15 V output

2.2.3 R3765CH/3767CH

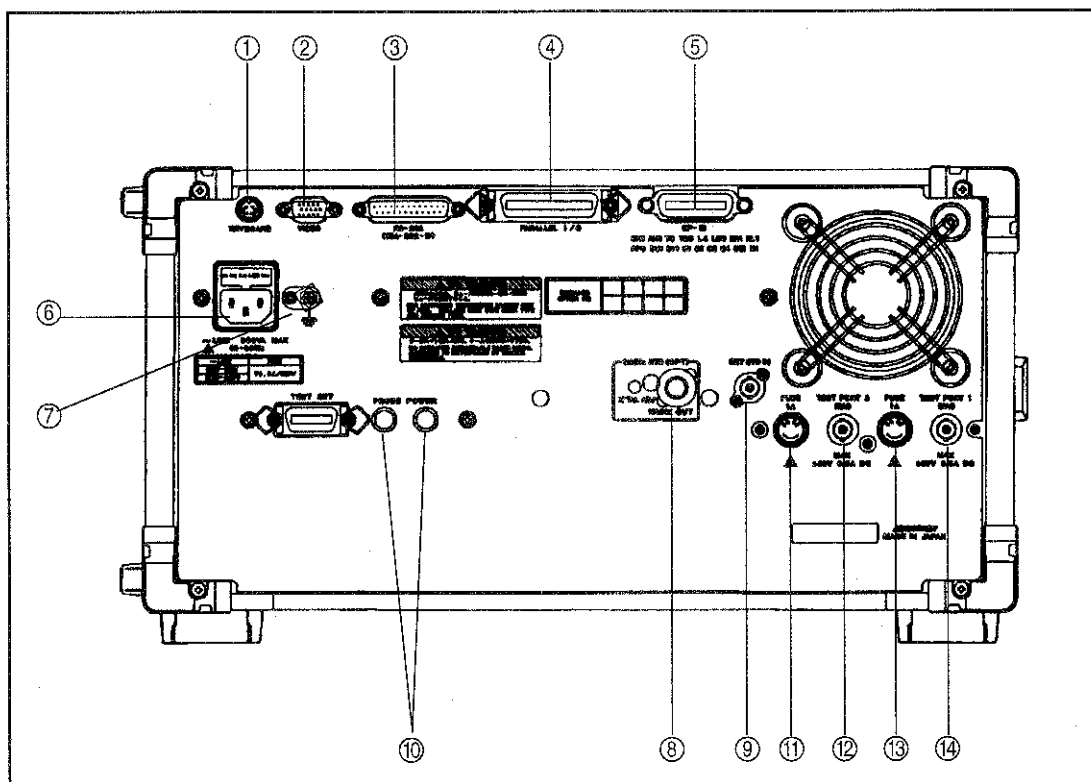

Figure 2-6 Rear Panel Descriptions (R3765CH/3767CH)

2.2 Rear Panel Descriptions

Table 2-6 Rear Panel Descriptions (R3765CH/3767CH)

No.	Name	Description
①	KEYBOARD INPUT connector	Connector to connect PS/2 type (6-pin small size DIN) key board. An external keyboard can be used to input a label name, a saving register name and a BASIC text.
②	VIDEO SIGNAL output	Video signal output correspondence to VGA. (15-pin)
③	SERIAL I/O	Input/output connector conformed to RS-232 standard. (D Sub 25-pin)
④	PARALLEL I/O connector	The I/O port connector is used to communicate peripheral devices such as an automatic machine and a foot switch. (Output: 8-bit 2 systems, Input/output: 4-bit 2 systems) EXT TRIGGER input. (Negative logic, pulse width: 1 μ s or more, 18-pin terminal) *Use shielded cables for connection (to prevent malfunction by noise).
⑤	GPIB connector	The GPIB connector is used to remotely control an external peripheral devices and to be remotely controlled by an external controller.
⑥	AC POWER connector	The AC POWER connector has three-pin structure includes an earth pin. To remove a power fuse, pull out the upper cover.
⑦	Ground terminal	The ground terminal is used to ground the R3765CH/3767CH only when three-pin connector or two-pin adapter for power cable cannot be used.
⑧	Connector for option	Spare connector for option.
⑨	External reference frequency input connector	This connector is used to input a reference frequency from an external device. Input frequency : 1, 2, 5, 10MHz, 0dBm or more Input frequency accuracy : Within \pm 10ppm
⑩	PROBE POWER connector	Connector for probe power \pm 15V output
⑪	Fuse holder *	Protective fuse (1A) for bias input to TEST PORT 2.
⑫	TEST PORT 2 BIAS	Connector (MAX. \pm 30V 0.5A DC) for bias input to TEST PORT 2.
⑬	Fuse holder *	Protective fuse (1A) for bias input to TEST PORT 1.
⑭	TEST PORT 1 BIAS	Connector (MAX. \pm 30V 0.5A DC) for bias input to TEST PORT 1.

* : Refer to section 1.8 for the replacement of protective fuse.

2.3 Screen Display Descriptions

The following shows R3767CH screen. Each part is described in the next page.

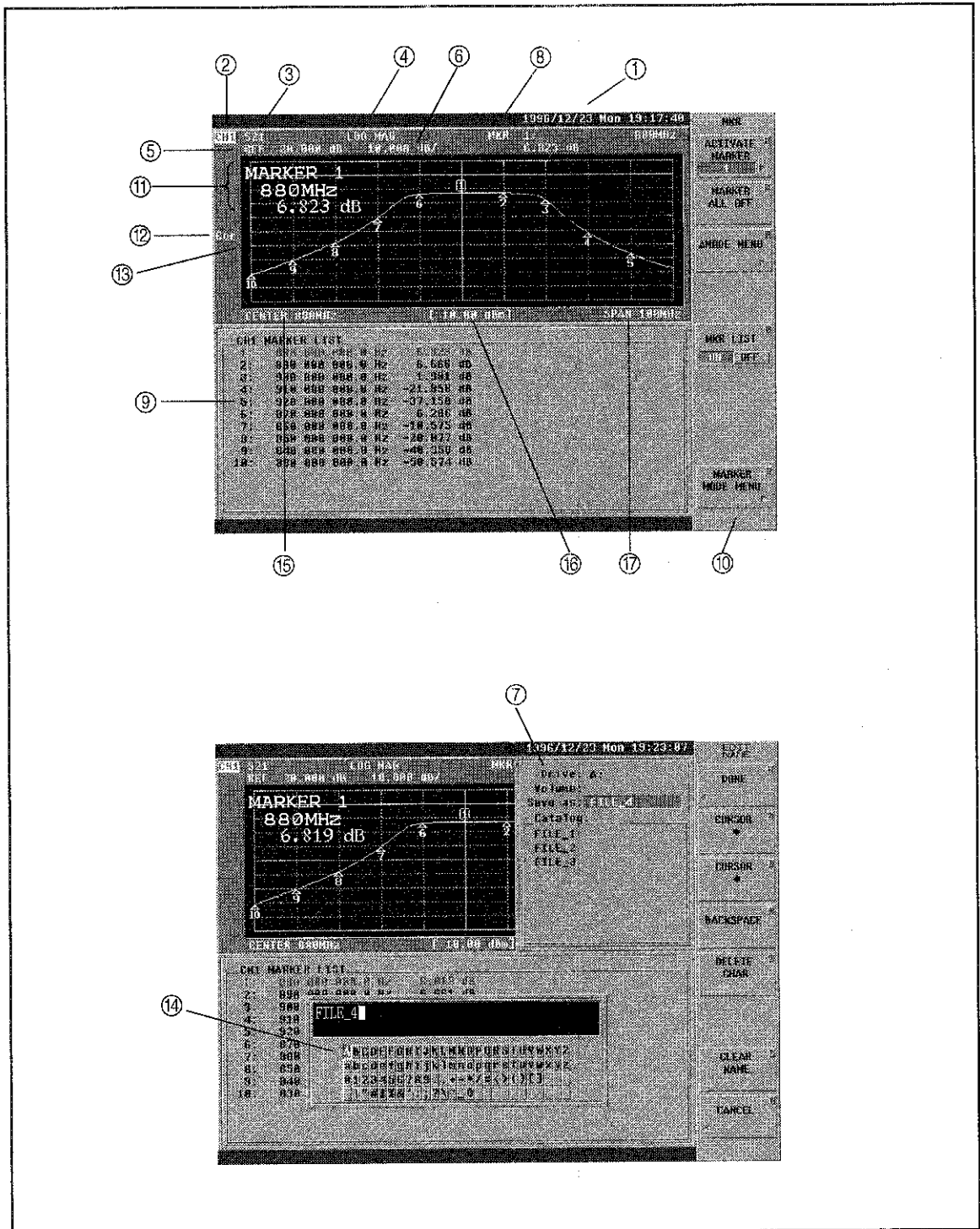

Figure 2-7 Screen Display Descriptions

2.3 Screen Display Descriptions

Table 2-7 Screen Display Descriptions

No.	Name	Description
①	Real time clock	Displays years, month, date and time.
②	Channel	Displays a channel number.
③	INPUT port	Displays an input port.
④	Format	Displays data format (format data).
⑤	Scale reference	Displays a reference value of display coordinate. The reference position is displayed by using →mark.
⑥	Scale/DIV	Displays one scale value of display coordinate.
⑦	Load menu	Displays files in this area when loading program from the disk drive.
⑧	Active marker	Displays an active marker value.
⑨	Marker list	Displays a marker list.
⑩	Soft key menu	Displays a soft key menu.
⑪	Active area	Displays items selected by panel keys or soft keys and those input values.
⑫	Status area	Displays status which shows an operating state of the R3765/3767H series.
⑬	Trace display area	Displays measurement data.
⑭	Label window	Displays character lists used for a label and a register name.
⑮	Start/Center	Displays the start/center of signal source.
⑯	Power/CW	Displays the power/CW of signal source.
⑰	Stop/Span	Displays the stop/span of signal source.

3 BASIC OPERATING GUIDELINES

This chapter explains the fundamental operation for those who use the R3765/3767H series for the first time.

3.1 Initial Power-on

(1) Connecting to AC Power Source

- ① With the R3765/3767H's power switch turned OFF, connect the attached power cable to the AC power connector on the rear panel.

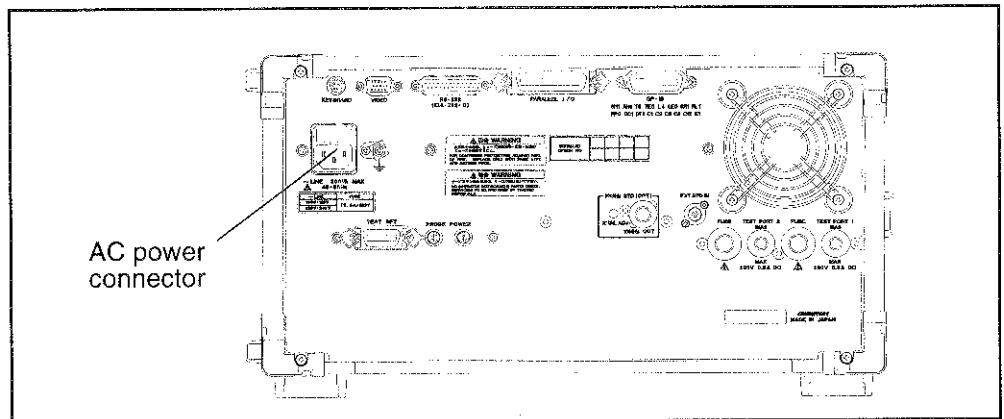

Figure 3-1 Connecting the Power Cable

- ② Connect another end of the power cable to an outlet. (Refer to sub-section 1.3.3.)

WARNING!

Connecting to an out-of spec power source may damage the R3765/3767H series. Power specification of the R3765/3767H series is as follows.

	Operation under 100V _{AC}	Operation under 220V _{AC}
Input voltage	90V - 132V	198V - 250V
Frequency	48Hz - 66Hz	48Hz - 66Hz

3.1 Initial Power-on

(2) Power-on

After connecting the power cable, turn ON the power switch on the front panel.

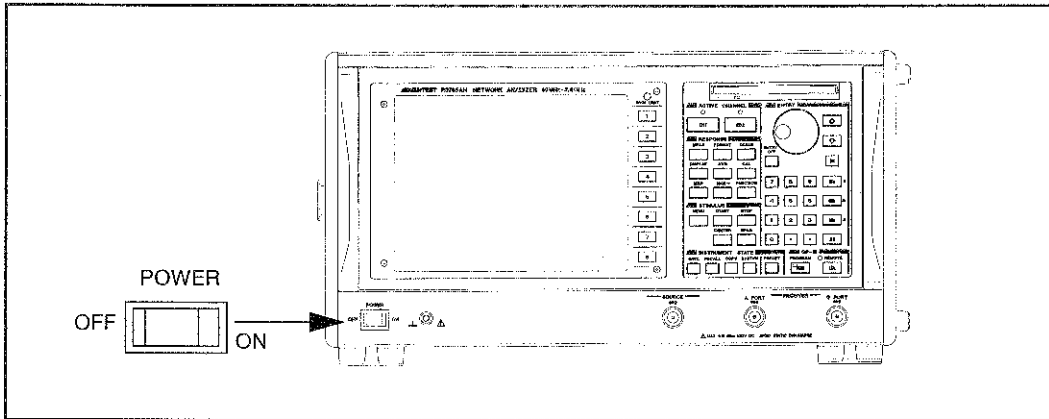

Figure 3-2 Power Switch

- Turn the power switch ON. Self-checking of the R3765/3767H series is executed. A few seconds later, the initial setting screen appears.

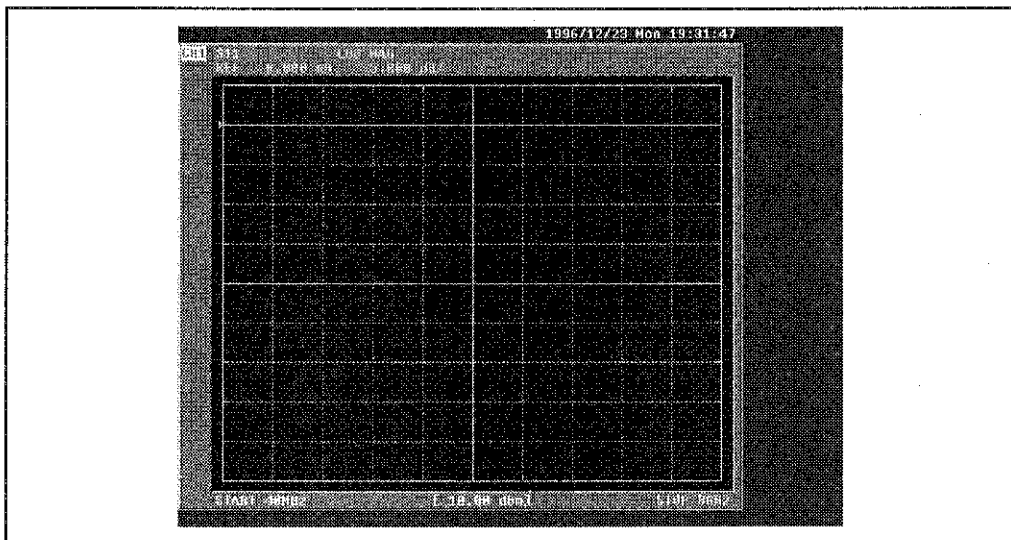

Figure 3-3 Setting Screen When Switch on or Preset (for R3767CH)

At power-on, the initial setting screen is displayed as shown above. When the initial setting screen is needed to display, press [PRESET] key.

3.2 Operation Keys

3.2.1 Panel Keys and Soft Keys

This R3765/3767H series is operated with **[panel keys]** and *{soft keys}*.

[] is panel keys. { } is soft keys.

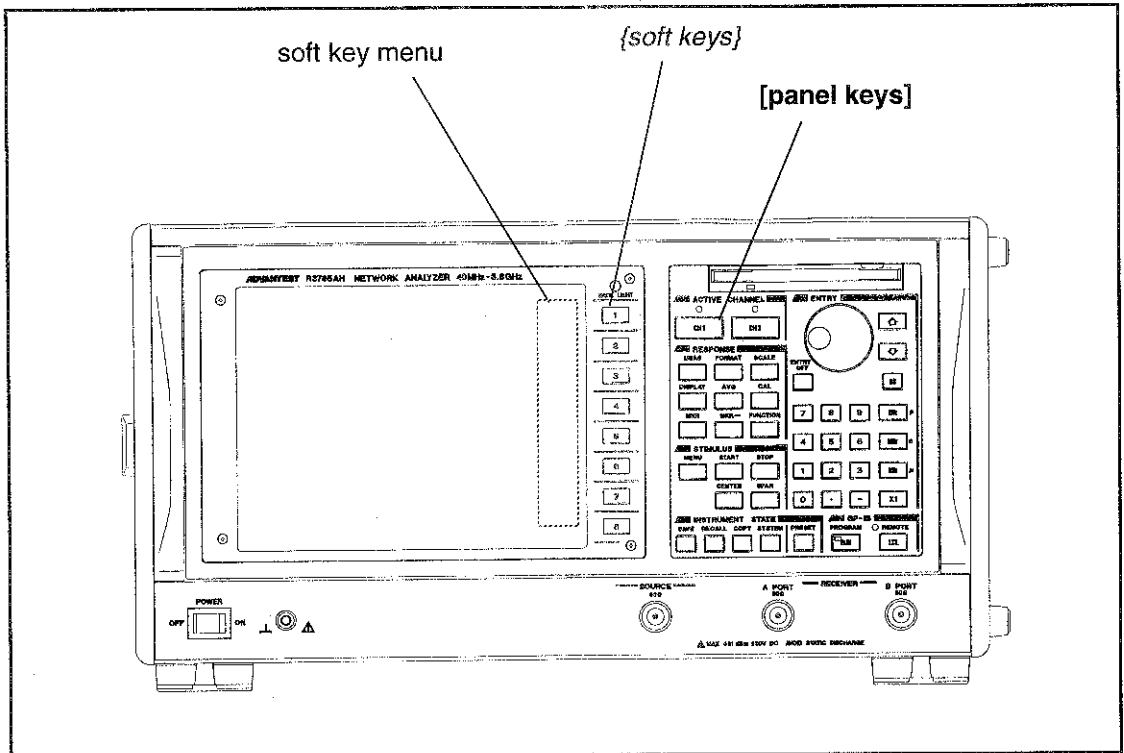

Figure 3-4 Panel Keys and Soft Keys

Pressing a **[panel key]** displays a soft key menu at right on the screen.

Press a *{soft key}* and the corresponding function in the soft key menu will be displayed.

3.2 Operation Keys

- (1) The panel keys are parted into 6 function blocks shown below.
 The operation is performed with the combination of these blocks.

	Block name	Function
①	ACTIVE CHANNEL	The R3765/3767H series has two measurement channels. Select an active channel which can be set and changed.
②	ENTRY	Input the numeric value for the selected function.
③	STIMULUS	Sets the conditions of signal source such as frequency range, power level, sweep type sweep time and sweep resolution.
④	RESPONSE	Sets measurement conditions of receiver part, measurement parameter, measurement format and display format marker for the active channel.
⑤	INSTRUMENT STATE	Sets the system such as save/recall or hard copy.
⑥	GPIB	Sets controller function and GPIB.

- (2) Press panel key **[CAL]** in RESPONSE block.

Calibration menu (1 of 2) appears on the screen. (Refer to section A.4 at the end of this manual.)

Soft menus shown below are displayed on the right portion of the display.

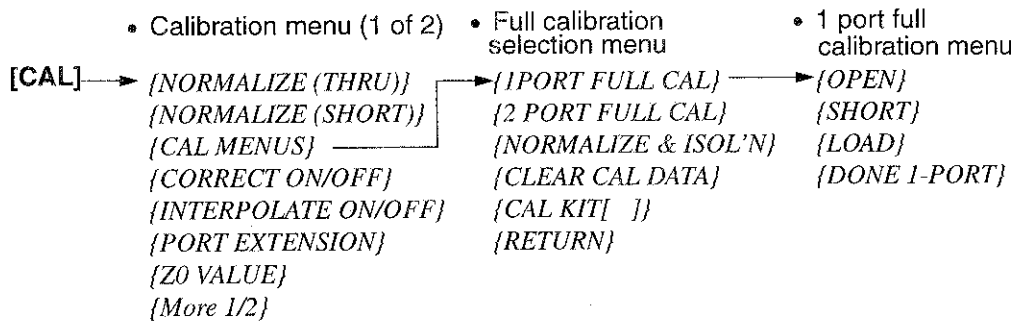

The soft key corresponding to the blank soft key menu is invalid.
Some soft key menu has more than one page, and some has hierarchy.

- When the soft key menu has more than one page
Pressing *{More 1/2}* moves the page to the next.
Pressing *{More 2/2}* returns the page to the previous.
- When the soft key menu has hierarchy
Pressing *{Return}* returns to the previous hierarchy menu.
- When the menu is of hierarchy of calibration data acquisition
In the case that more than one data acquisition is required for the calibration like 1 port full calibration.
Pressing *{DONE 1-PORT}* without acquiring each data can return to the previous hierarchy menu forcefully.

In order to move it to the top menu from the middle of a series of soft key menu, press **[CAL]** key if the menu is of CAL. Ditto for others.

For example, pressing **[MENU]** key to invoke soft key menu of MENU from the situation that the soft key menu of CAL is displayed, and continuously pressing **[CAL]** key redisplay the same CAL soft key menu as the one before **[MENU]** key pressed.

(3) Data setting

When a **[panel key]** and a *{soft key}* is pressed to set data, the function of the pressed key and the current set conditions are displayed at upper left on the screen.
This display area is called "active area". Set data, checking the values displayed in the active area.

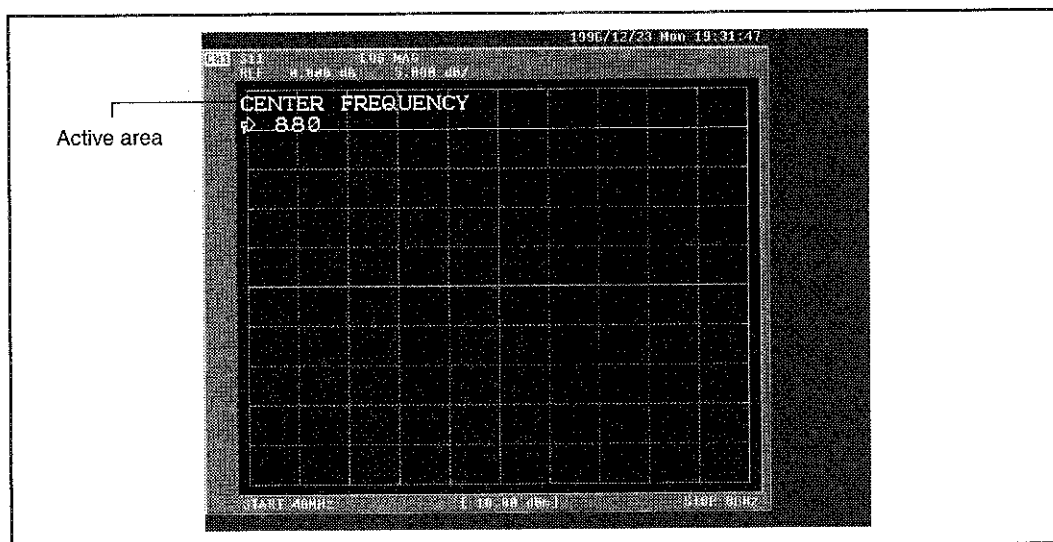

Figure 3-5 Displayed Active Area

3.2 Operation Keys

- ① There are 3 methods for setting data.

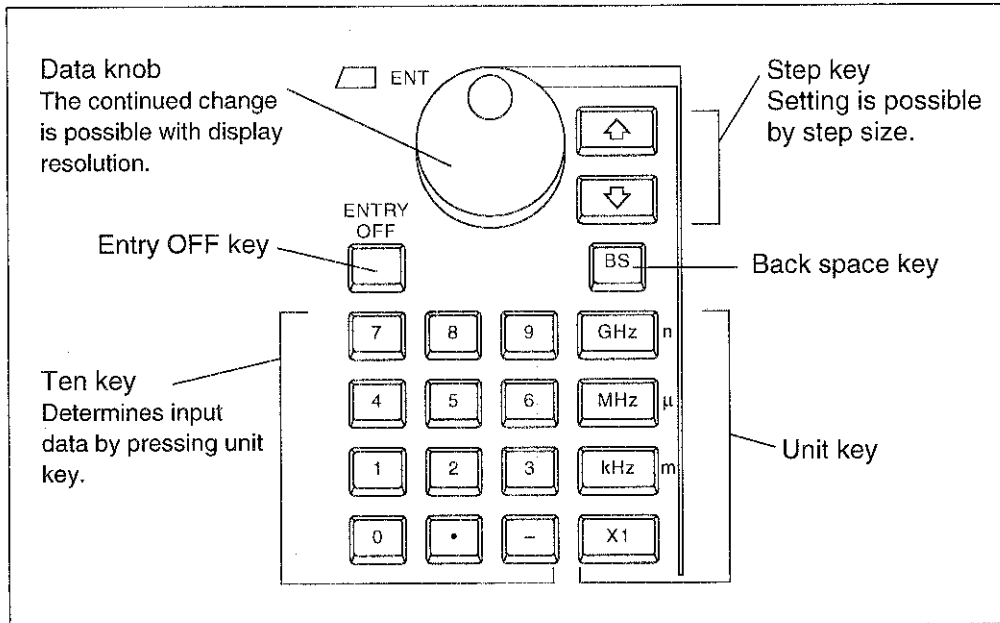

Figure 3-6 How to Set Data

(a) Ten-key and unit key

These keys are used to input numeric data.

Input a numeric value with ten-key, and press a unit key.

Pressing **[BS]** key deletes the rightmost digit of the numeric value which has been input with ten-key.

(b) Step key and data knob

Step key is used to set data by predefined step size.

Pressing **[↑]** key increments the data, while pressing **[↓]** key decrements the data.

Data knob is used to set data in units of predefined display resolution. It is very convenient for finely adjusting set data.

(c) Entry off key

Entry off key is operated by toggle.

Sets OFF the current entry data which is displayed in active area.

Press this key to avoid changing the entry data by actuating the knob by mistake. Then, the marker can be moved by data knob.

Pressing the entry off key again can switch the entry OFF to ON.

But when the preset key is pressed or when the R3765/3767H series is turned OFF automatically, the entry off key cannot be switched to ON again.

If this function is selected before plotting, the screen cleaned the active area can be plotted.

3.3 How to Read the Display Screen

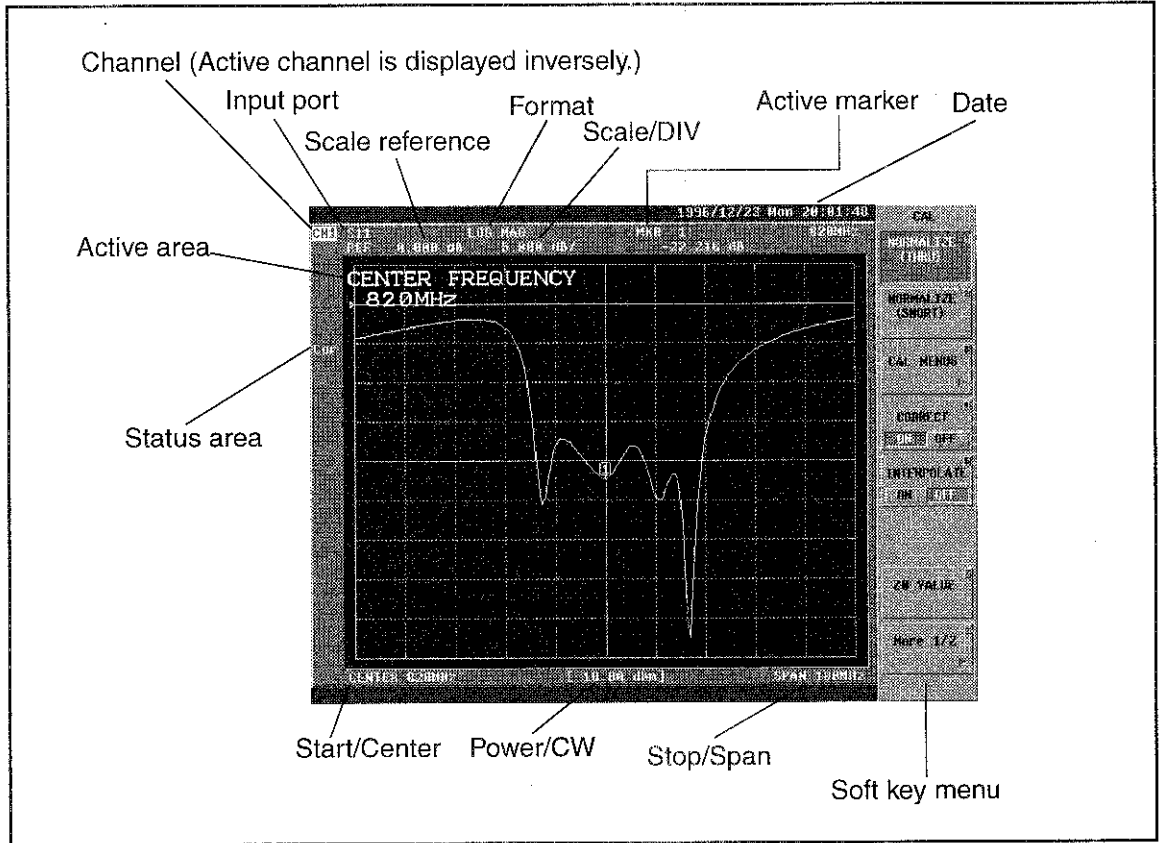

Figure 3-7 Annotation on the Screen (Annotation Character)

3.4 Basic Measuring Procedure

3.4 Basic Measuring Procedure

Shows basic measuring procedure of R3765/3767H series.

Measuring procedure

- ① Connection
Connect DUT (device under test) to the R3765/3767H series.
- ② Setting of the R3765/3767H series
Initialize the R3765/3767H series by pressing **[PRESET]** key.
Next, select the setting of the R3765/3767H series according to the measurement to perform.
(If necessary, connect DUT temporarily then.)
- ③ Calibration
Acquire the reference of magnitude and phase according to the measurement and eliminate measurement error.
- ④ Measurement
Connect DUT and execute the measurement.
Read the parameter to measure by using marker function, etc.
- ⑤ Measured result output
The measured results can be output to the printer or the plotter with GPIB interface.
Also they can be saved in floppy disk.

3.5 Measurement Samples of Simple Transmission Characteristics

3.5.1 Setup and Setting

The setup of the R3765/3767H series is performed as shown in Figure 3-8 or Figure 3-9 according to the type.

- (1) AH type

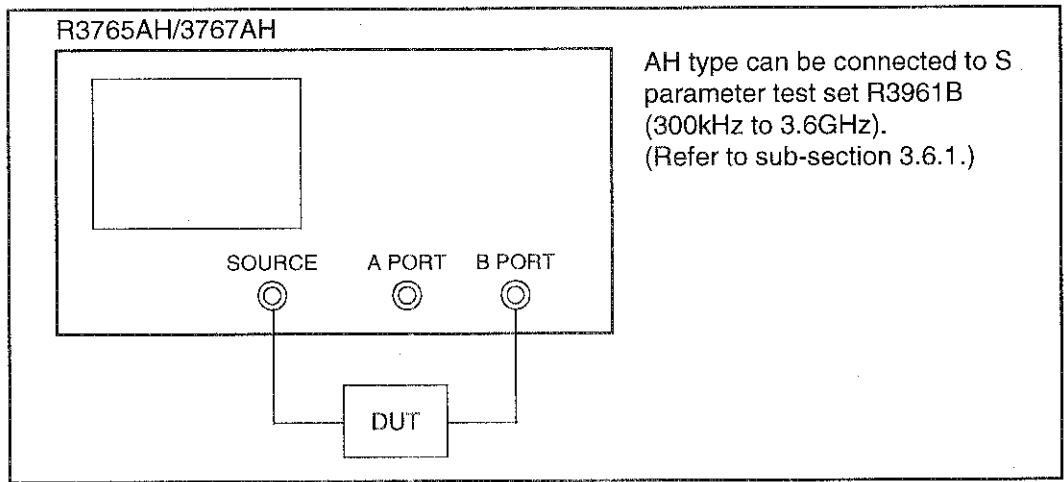

Figure 3-8 The Setup of Transmission Characteristic Measurement (AH Type)

- (2) BH/CH type

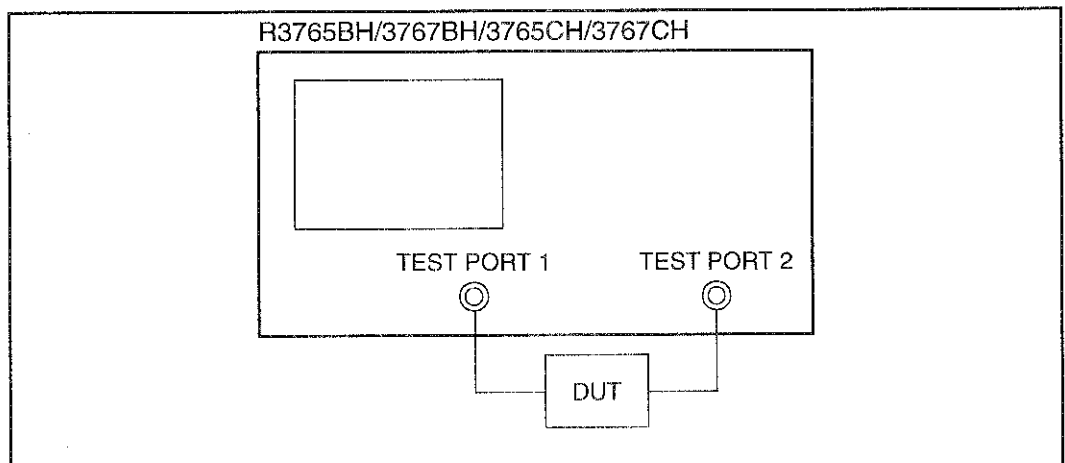

Figure 3-9 The Setup of Transmission Characteristic Measurement (BH/CH Type)

3.5 Measurement Samples of Simple Transmission Characteristics

- DUT to use for the measurement sample is the band-pass filter of center frequency 880MHz.
- All the screen displays used here are display samples of R3767CH.

The displayed contents of input port in the upper left portion of the screen are different depending on the model.

The display of each type is as follows. (Active channel: CH2).

AH type	AH type + S parameter	BH type	CH type
B/R	S21	TRN	S21

TRN : TRANSMISSION

(3) Setting

- ① Press [**PRESET**] to preset.
- ② Set the R3765/3767H series as follows.

Block name	Setting	Key operation
ACTIVE CHANNEL	Set the channel to 2.	[CH 2]
RESPONSE	Select the input port in the receiver part.	AH type : [MEAS] → {B/R} (Initial setup) BH type : [MEAS] → {TRANSMISSION} (Initial setup) CH type or A type + S parameter [MEAS] → {S21 TRANS FWD} (Initial setup)
	Set the measurement format to magnitude (log display).	[FORMAT] → {LOG MAG} (Initial setup)
STIMULUS	Center frequency 880MHz Span frequency 100MHz	[CENTER] → [8] → [8] → [0] → [MHz] [SPAN] → [1] → [0] → [0] → [MHz]

3.5.2 Calibration (Normalize)

Calibrate the frequency characteristics of the R3765/3767H series.

- ① Remove DUT and connect a through adapter instead.
- ② Press **[CAL]** → {*NORMALIZE (THRU)*}.
The display on the screen changes as follows.
CORRECT key is set to ON automatically.
- ③ Following the completion, return the connection the DUT (filter).

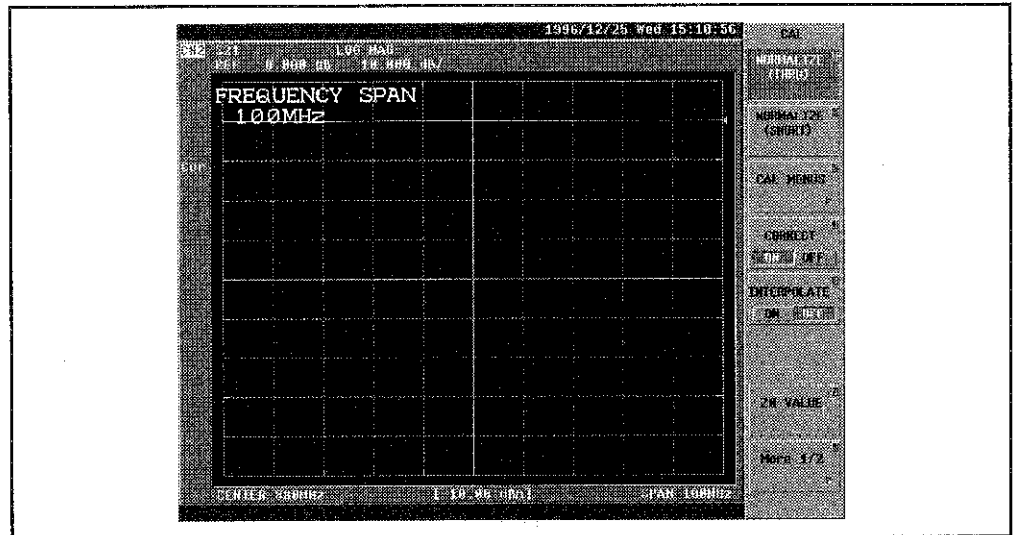

Figure 3-10 Screen of Frequency Characteristic Normalize

3.5.3 Magnitude measurement

- ① Adjust the scale to see the display trace easily.
[SCALE] → {*AUTO SCALE*}

3.5 Measurement Samples of Simple Transmission Characteristics

The display on the screen is as follows.

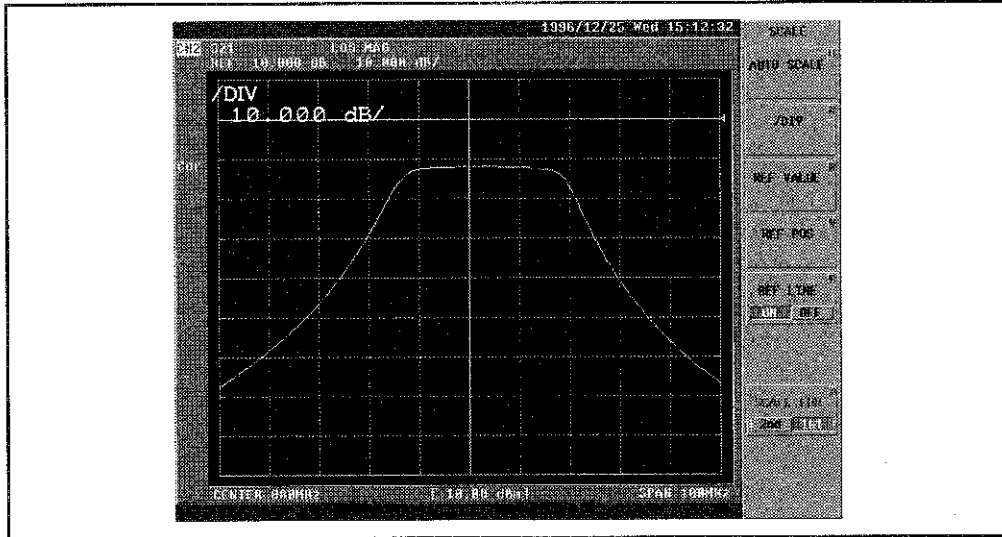

Figure 3-11 Auto-scale of Magnitude Measurement

- ② A measurement sample of 3dB bandwidth

Set the marker and activate the filter analysis function.

[MKR] → {MKR SEARCH []} → {FLTR ANAL} → {FLTR ANAL ON/OFF}

The display on the screen is as follows.

Bandwidth is displayed with arrow (↑) on the trace and the analyzed results are displayed.

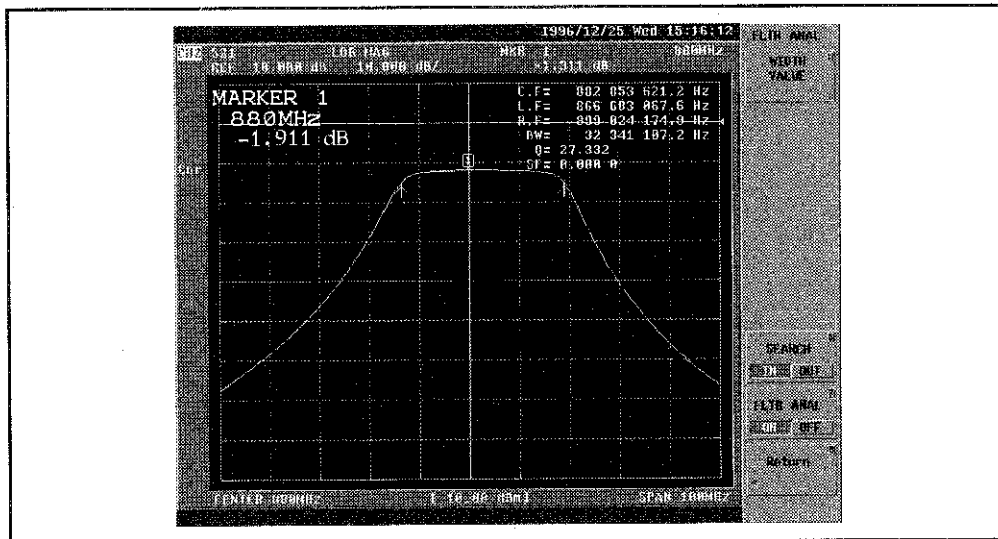

Figure 3-12 Filter Analyzing Function (3dB Bandwidth and Q Measurement)

3.5 Measurement Samples of Simple Transmission Characteristics

- ③ A measurement sample of 6dB bandwidth

Change WIDTH VALUE (bandwidth to search) from 3dB (initial value) to 6dB.

Press {WIDTH VALUE} → [6] → [X1]

The display on the screen is as follows.

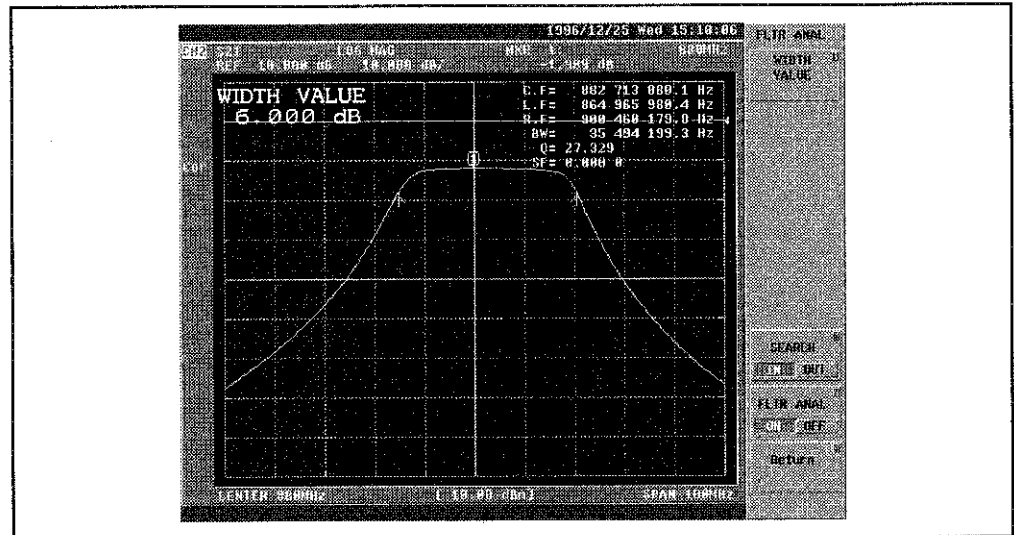

Figure 3-13 Filter Analyzing Function (6dB Bandwidth and Q Measurement)

3.5.4 Phase measurement

- ① Setup (refer to sub-section 3.5.1) and preset (refer to sub-section 4.4.1).

- ② Set the R3765/3767H series as follows.

The measurement here is performed with the span lessened and inside of the bandwidth extended.

Block name	Setting	Key operation
ACTIVE CHANNEL	Set the channel to 2.	[CH 2]
RESPONSE	Select the input port in the receiver part.	AH type : [MEAS] → {B/R} (Initial setup) BH type : [MEAS] → {TRANSMISSION} (Initial setup) CH type or AH type + S parameter [MEAS] → {S21 TRANS FWD} (Initial setup)
	Set the measurement format to phase display.	[FORMAT] → {PHASE} (Initial setup)
STIMULUS	Center frequency 880MHz Span frequency 50MHz	[CENTER] → [8] → [8] → [0] → [MHz] [SPAN] → [5] → [0] → [MHz]

3.5 Measurement Samples of Simple Transmission Characteristics

- ③ Calibrate (Normalize) frequency characteristics. (The same operation as sub-section 3.5.2.)
- ④ Adjust the scale to see the display trace easily.
Pressing [SCALE] → {AUTO SCALE} shows the following display on the screen.

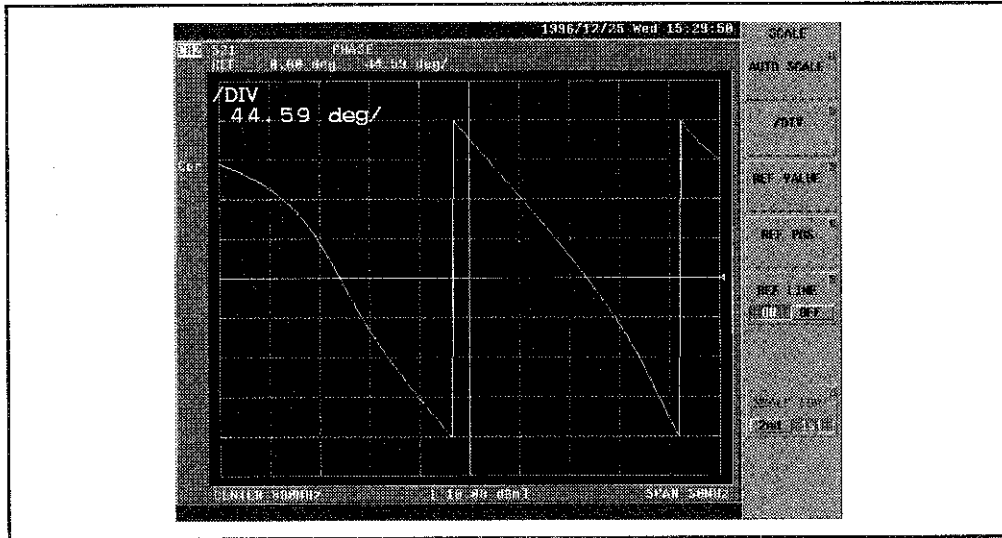

Figure 3-14 Auto-scale of Phase Measurement

- ⑤ Set the phase extension display.
[FORMAT] → {More 1/2} → {PHASE $-\infty$, $+\infty$ }
[SCALE] → {AUTO SCALE}

The display on the screen is as follows.

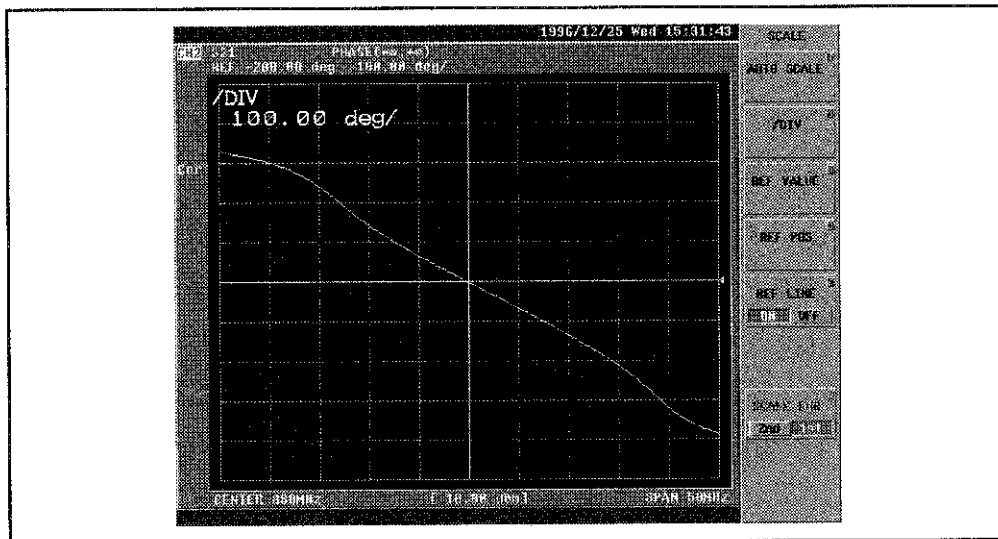

Figure 3-15 Phase Extension Display

3.5 Measurement Samples of Simple Transmission Characteristics

3.5.5 Group delay measurement

- ① Setup (refer to sub-section 3.5.1) and preset (refer to sub-section 4.4.1).
- ② Set the R3765/3767H series as follows.

The measurement here is performed with the span lessened and inside of the bandwidth extended.

Block name	Setting	Key operation
ACTIVE CHANNEL	Set the channel to 2.	[CH 2]
RESPONSE	Select the input port in the receiver part.	AH type : [MEAS] → {B/R} (Initial setup) BH type : [MEAS] → {TRANSMISSION} (Initial setup) CH type or AH type + S parameter [MEAS] → {S21 TRANS FWD} (Initial setup)
	Set the measurement format to group delay display.	[FORMAT] → {DELAY}
STIMULUS	Center frequency 880MHz Span frequency 50MHz	[CENTER] → [8] → [8] → [0] → [MHz] [SPAN] → [5] → [0] → [MHz]

- ③ Calibrate frequency characteristics. (The same operation as sub-section 3.5.2.)
- ④ Adjust the scale to see the display trace easily.

Pressing [SCALE] → {AUTO SCALE} shows the following display on the screen.

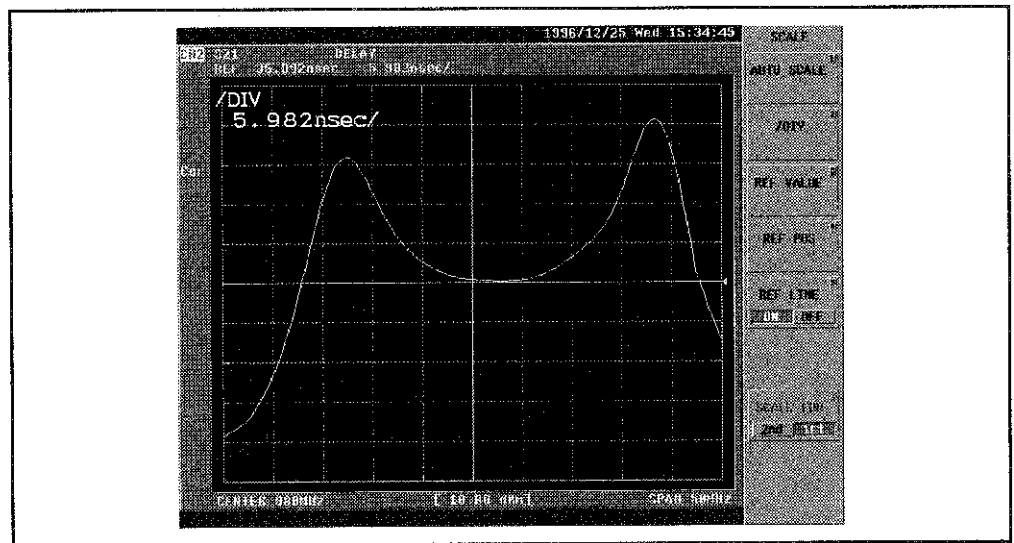

Figure 3-16 Auto-scale of Group Delay Measurement

3.5 Measurement Samples of Simple Transmission Characteristics

- ⑤ Change group delay aperture to 20%.

[AVG] → {GROUP DELAY APERTURE} → [2] → [0] → [X1]

The display on the screen is as follows.

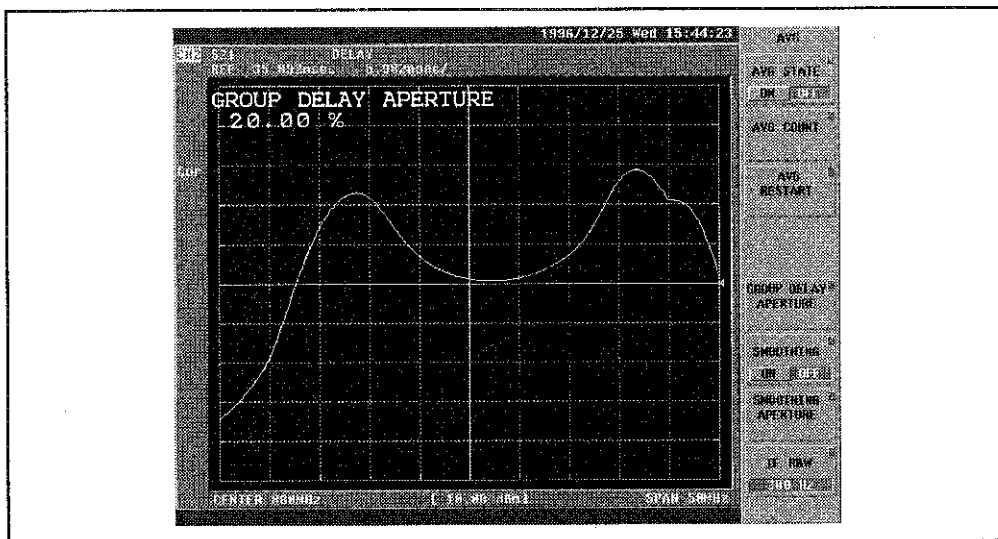

Figure 3-17 Change of Group Delay Aperture

3.6 Measurement Samples of Simple Reflection Characteristics

3.6.1 Setup

The R3765/3767H series is setup as shown in Figure 3-18, 3-19 or 3-20.

(1) AH type

- ① In order to measure the reflection characteristics with AH type, directive bridge to separate reflection wave and incident wave from DUT to measure are necessary.

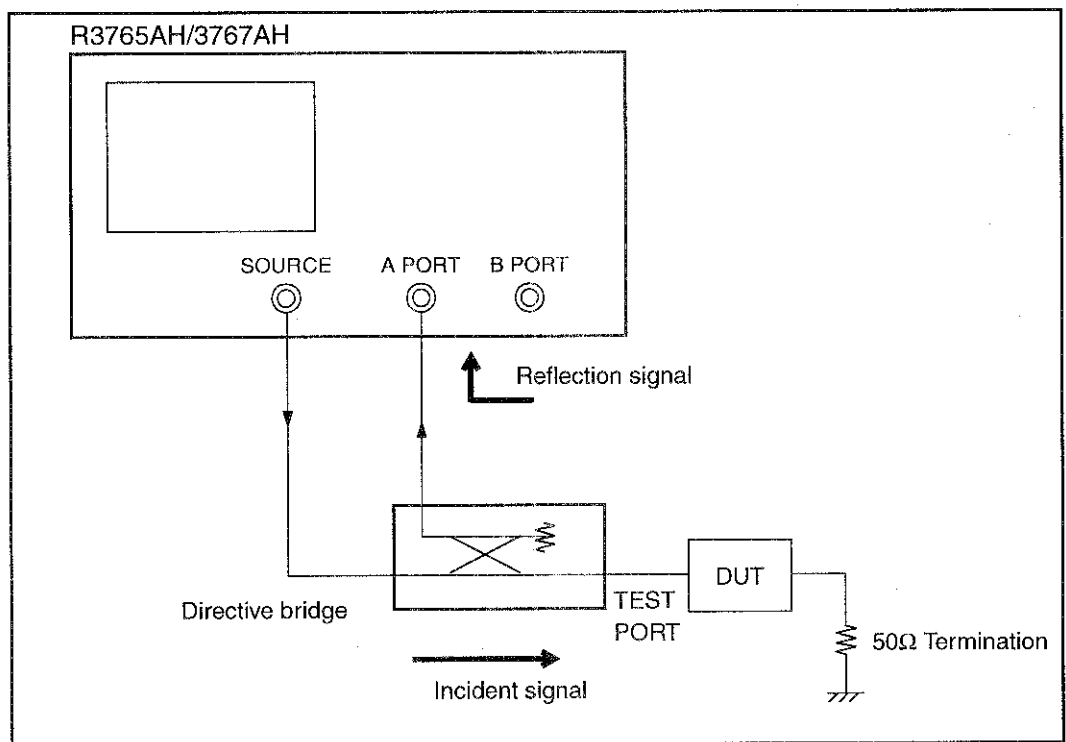

Figure 3-18 Setup (1) for AH Type Reflection Characteristics Measurement

3.6 Measurement Samples of Simple Reflection Characteristics

- ② By using S parameter test set R3961B(300kHz to 3.6GHz), transmission/reflection characteristics can be measured simply.

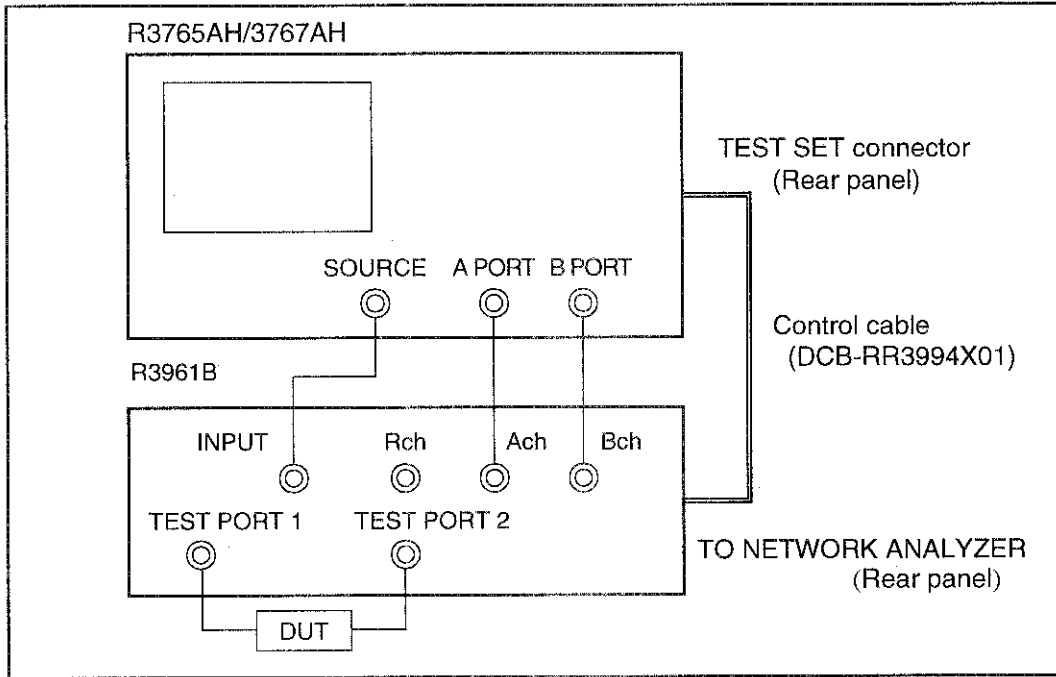

Figure 3-19 Setup (2) for AH Type Reflection Characteristics Measurement

Above measuring method using S parameter test set is the same as the case of CH type.

- (2) BH/CH type

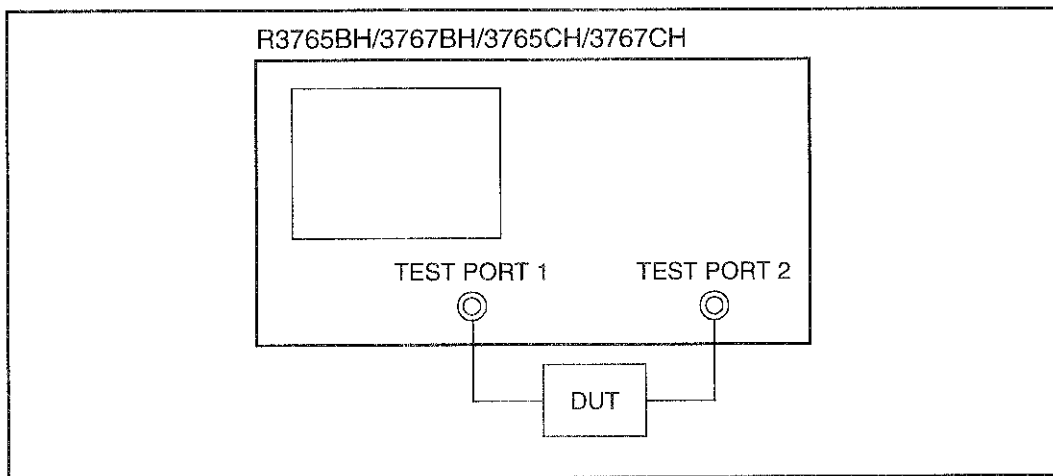

Figure 3-20 Setup for Reflection Characteristic Measurement

3.6 Measurement Samples of Simple Reflection Characteristics

- DUT of this measurement sample is a band pass filter of center frequency of 880MHz.
- All the displays used on the screen are display samples of R3767CH.

The displayed contents of input port in the upper left portion of the screen are different depending on the model.

The display of each type is as follows.

AH type	AH type + S parameter	BH type	CH type
A/R	S11	RFL	S11

RFL : REFLECTION

(3) Setting

- ① Press **[PRESET]** to preset.
- ② Setting of the R3765/3767H series is as follows.

Block name	Setting	Key operation
ACTIVE CHANNEL	Set the channel to 1.	[CH 1]
RESPONSE	Select the input port in the receiver part.	AH type : Bridge is used. [MEAS] → {A/R} (Initial setup) BH type : [MEAS] → {REFLECTION} (Initial setup) CH type or AH type + S parameter [MEAS] → {S11 REFL FWD} (Initial setup)
	Set the measurement format to magnitude (log display).	[FORMAT] → {LOG MAG} (Initial setup)
STIMULUS	Center frequency 880MHz Span frequency 100MHz	[CENTER] → [8] → [8] → [0] → [MHz] [SPAN] → [1] → [0] → [0] → [MHz]

3.6 Measurement Samples of Simple Reflection Characteristics

3.6.2 Calibration (1-port full calibration)

In the case of AH type, perform 1-port full calibration of bridge test port.

In the case of BH/CH type or AH type + S parameter test set, perform 1-port full calibration of test port 1.

CAUTION!

1. If the calibration has already been executed, switch OFF the calibration, clear the calibration data, and then start calibration.
2. When the message "Wait for Sweep" disappeared, each calibration completes.
3. During it's displayed the R3765/3767H series, the cable, the connector, etc. must not be moved.

- ① Invoke 1-port full calibration menu.

[CAL] → {CAL MENUS} → {1 PORT FULL CAL}

- ② Connect the open standard to the test port and acquire the calibration data.

{OPEN}

The display on the screen is as follows.

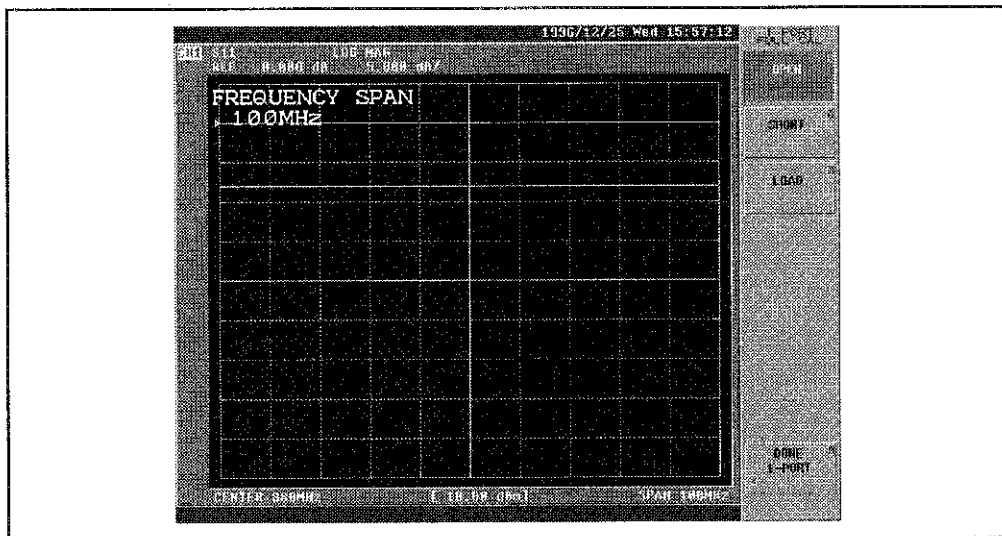

Figure 3-21 1-Port Full Calibration (Open)

3.6 Measurement Samples of Simple Reflection Characteristics

- ③ Connect the short standard to the test port and acquire the calibration data.

{SHORT}

The display on the screen is as follows.

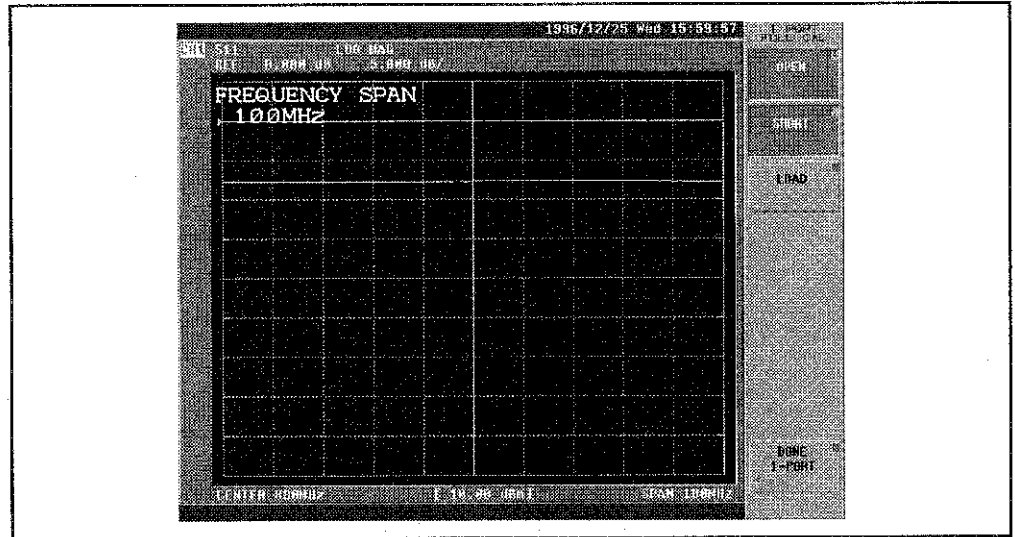

Figure 3-22 1-Port Full Calibration (Short)

- ④ Connect the load standard to the test port and acquire the calibration data.

{LOAD}

The display on the screen is as follows.

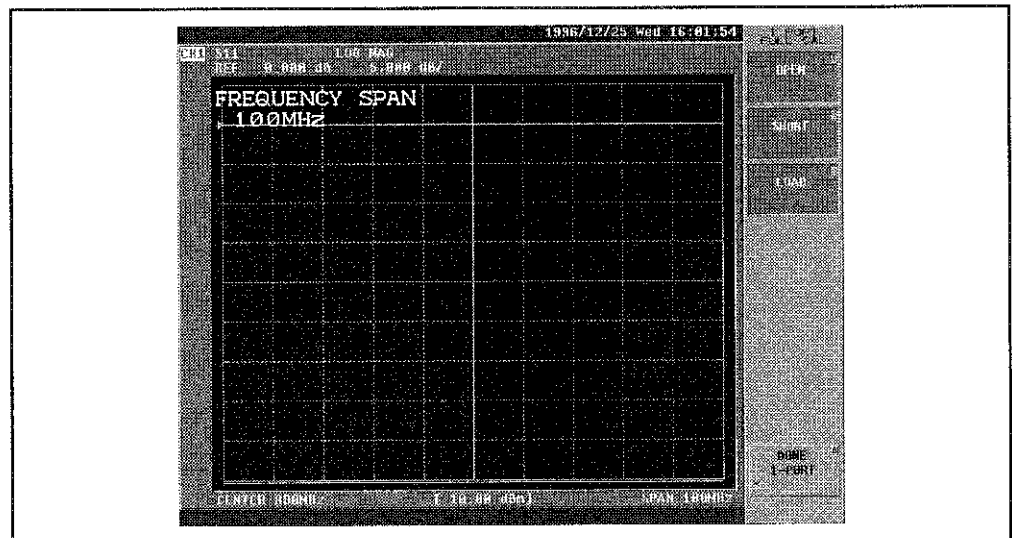

Figure 3-23 1-Port Full Calibration (Load)

3.6 Measurement Samples of Simple Reflection Characteristics

- ⑤ Execute the calibration and end.
 {DONE 1-PORT}
 The calibration data becomes effective automatically.
- ⑥ Following the completion, return the connection to DUT (an example: filter).

3.6.3 Measurement by various formats

Here describes about measurement methods by various formats of reflection measurement (return loss, reflection coefficient, standing wave ratio, S parameter and impedance).

- ① Return loss (LOG MAG format setting) measurement
 Adjust the scale to see the display trace (magnitude) easily.
[SCALE] → {AUTO SCALE}

Letting the reflective coefficient = ρ (= reflective signal/incident signal), the return loss is represented with the following equation.

$$\text{Return loss} = -20\log(\rho)$$

The display on the screen (return loss) is as follows.

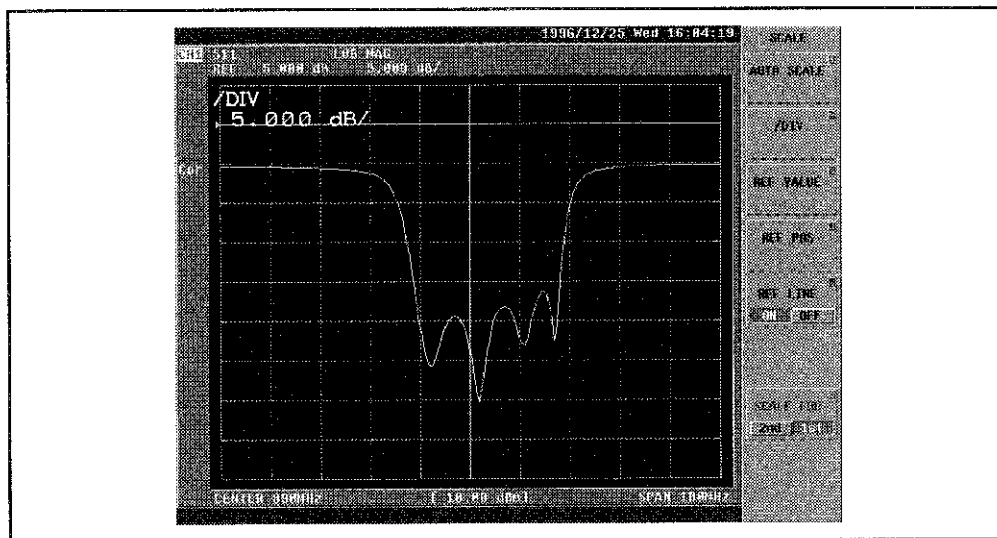

Figure 3-24 Return Loss Measurement

- ② Measurement of reflection coefficient (LIN MAG format setting)
 The following operation is performed to display the return loss converted into reflection coefficient.
[FORMAT] → {LIN MAG}
Note: If the format soft menu has already been displayed, it's not necessary to press **[FORMAT]**.

3.6 Measurement Samples of Simple Reflection Characteristics

The top of the screen corresponds to reflection coefficient 1 (full reflection), and the bottom corresponds to reflection coefficient 0. The display becomes linear scale.

[SCALE] → {AUTO SCALE}

The display on the screen is as follows.

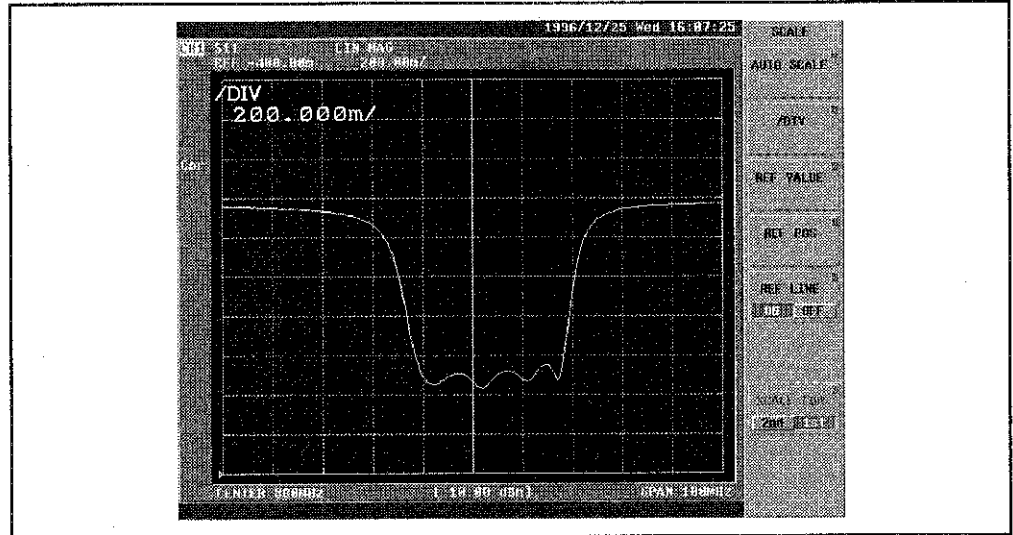

Figure 3-25 Reflection Coefficient Measurement

③ Standing wave ratio (SWR format setting) measurement

The following operation is performed to display the return loss as the standing wave ratio (SWR).

[FORMAT] → {More 1/2} → {SWR}

[SCALE] → {AUTO SCALE}

SWR=1 corresponds to the state of perfect matching.

The related expression between SWR and reflection coefficient ρ is as follows.

$$SWR = (1+\rho) / (1-\rho)$$

3.6 Measurement Samples of Simple Reflection Characteristics

The display on the screen is as follows.

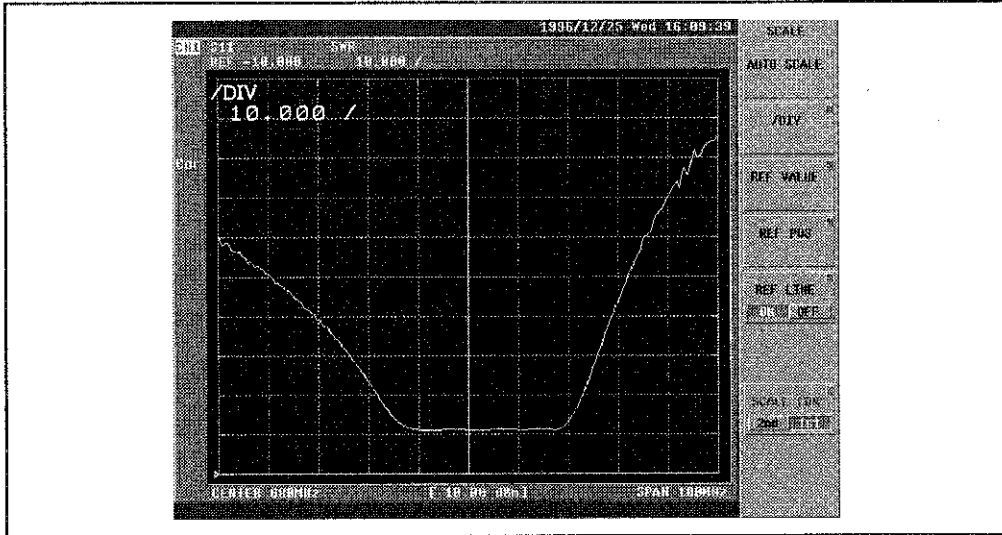

Figure 3-26 Standing Wave Ratio (SWR) Measurement

- ④ S parameter (POLAR format setting) measurement

The following operation is performed to display polar coordinates.

[FORMAT] → {POLAR}

The display on the screen is as follows.

Each coordinate shows the magnitude and the phase as follows.

- (a) The magnitude is displayed with line and the size of the magnitude is displayed with the radius of the circle.
The center of the circle : Reflection coefficient 0 (The state of perfect matching)
The most outer circumference of the circle :
Reflection coefficient 1 (Full reflection)
- (b) The phase is displayed with the angle from the plus direction of X axis.
It shows that the direction of 3 o'clock is phase angle 0° and the phases of the incident signal and the reflection signal are the same.

3.6 Measurement Samples of Simple Reflection Characteristics

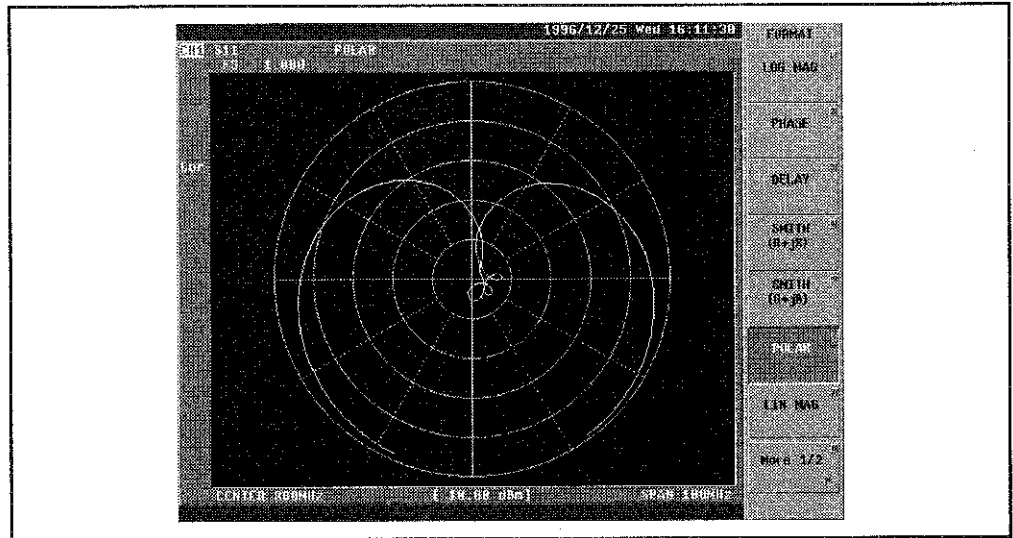

Figure 3-27 S Parameter Measurement

- ⑤ Impedance (Smith chart setting) measurement

The following operation is performed to make Smith chart.

[FORMAT] → **{SMITH (R+jX)}**

The display on the screen is as follows.

It shows that the impedance is inductive in the upper half circle of Smith chart and it is capacitive in the lower half circle.

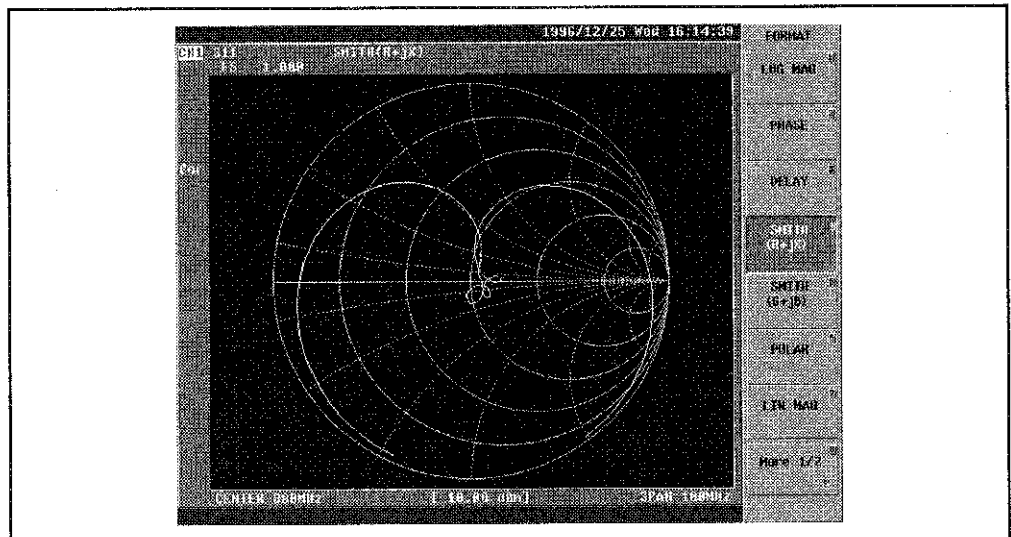

Figure 3-28 Impedance Measurement

- ⑥ The following operation is performed to convert to admittance chart.
Pressing **[FORMAT]** & **{SMITH (G+jB)}** displays the converted result.

4 BASICS OPERATION

This chapter describes about the keys and the soft menus of the R3765/3767H series basically.

4.1 Basic Keys Operations

Front panel keys are grouped under the following six function blocks. The operation is performed by the combination of these blocks.

- (1) ACTIVE CHANNEL block
The R3765/3767H series has 2 measurement channels. (Refer to section 7.1.)
Select an active channel which can be set and changed.
- (2) ENTRY block
Input numeric value to the selected function. (Refer to section 7.2.)
- (3) STIMULUS block
Make the setting for the signal resource. (Refer to section 7.3.)
- (4) RESPONSE block
Make setting of the receiver part and the information on the display screen. (Refer to section 7.4.)
- (5) INSTRUMENT STATE block
Make the system setting such as save/recall or hard copy, etc. (Refer to section 7.8.)
- (6) GPIB block
Make the setting of controller function and GPIB. (Refer to section 7.10.)

4.2 Basic Key Operation Examples

The key operation of the R3765/3767H series is performed in the following three ways.

- (1) The case that the numeric value data input is required.
[Panel key] → {Soft key} → [Panel key] in ENTRY block
[Panel key] → [Panel key] in ENTRY block
- (2) The case that the selection is made only by soft key menu.
[Panel key] → {Soft key}
Pressing a key for more than about 0.5 seconds can input the key continuously.
But if more than two keys are pressed at the same time, none of the keys can be input.

4.3 Soft Key Menu Configuration

Soft key menu has two types, having more than two pages and hierarchy.

Refer to "A.4 Soft Key Menu List", for details.

- (1) Soft key menu having more than two pages

Pressing *{More 1/2}* moves the page to the next, and pressing *{More 2/2}* returns the page to the previous.

- (2) Soft key menu of hierarchy

Pressing *{Return}* returns to the previous hierarchy menu.

- (3) Soft key menu of calibration data acquisition hierarchy

After executing *{DONE}*, returns to the previous hierarchy menu.

Some functions cannot be used because the models of the R3765/3767H series are different. The menu related to these operations is not displayed.

In the case of the R3765AH/3767AH, check the connecting state of S parameter test set at power-on.

When the test set is not connected, the menu related to S parameter is not displayed.

4.4 Initial Setup

4.4.1 How to Initialize

Operating Procedure

- Press [PRESET] key.
The contents of the setup is initialized to the following initial setup value.

4.4.2 Initial Setup Value

Table 4-1 Initial Setup Value (1 of 3)

Function	Initialize method	
	Power on or preset	*RST
Stimulus		
Sweep type	Linear frequency sweep	Linear frequency sweep
Continuous sweep	ON	OFF
Trigger source	Internal (FREE RUN)	Internal (FREE RUN)
Trigger delay	OFF (0sec)	OFF (0sec)
Sweep time	190.95msec (AUTO) (R3765AH/BH/CH)	240.2msec (AUTO) (R3765AH/BH/CH)
	402.0msec (AUTO) (R3767AH/BH/CH)	420.35msec (AUTO) (R3767AH/BH/CH)
Measurement point	201	1201
Start frequency	40MHz	40MHz
Stop frequency	3.8GHz (R3765AH/BH/CH)	3.8GHz (R3765AH/BH/CH)
	8.0GHz (R3767AH/BH/CH)	8.0GHz (R3767AH/BH/CH)
Center frequency	1.92GHz (R3765AH/BH/CH)	1.92GHz (R3765AH/BH/CH)
	4.02GHz (R3767AH/BH/CH)	4.02GHz (R3767AH/BH/CH)
Frequency span	3.76GHz (R3765AH/BH/CH)	3.76GHz (R3765AH/BH/CH)
	7.96GHz (R3767AH/BH/CH)	7.96GHz (R3767AH/BH/CH)
Frequency display	Start/Stop	Start/Stop
Fixed frequency of level sweep	1GHz	1GHz
Output level	* 1	* 1
Start level	* 2	* 2
Stop level	* 2	* 2
Two-channel interlocking	ON	ON
Program sweep segment	All clear	All clear
Response		
Dual channel	OFF	OFF
Active channel	CH1	CH1
Resolution bandwidth	10kHz	10kHz
Selection item of input port	* 3	* 3
Average	OFF (Number of times 16)	OFF (Number of times 16)
Trace operation	NONE	NONE
Conversion	NONE	NONE
Characteristic impedance Z_0	50 Ω	50 Ω
Measurement format	* 4	* 4
Group delay aperture	10%	0.01%
Smoothing	OFF (Aperture 10%)	OFF (Aperture 0.01%)
Display	Data	Data
Split/Overlap	Overlap	Overlap
Label	NONE	NONE

4.4 Initial Setup

* 1 : Output level

Type	Power on or preset	*RST
AH	0dBm	0dBm
BH	0dBm	0dBm
CH AH + S parameter	10dBm	10dBm

* 2 : Start/Stop level

Type	Power on or preset		*RST	
	Start	Stop	Start	Stop
AH	-13dBm	0dBm	-13dBm	22dBm
BH	-15dBm	0dBm	-15dBm	20dBm
CH AH + S parameter	-20dBm	0dBm	-20dBm	10dBm

* 3 : Selection item of input port

Type	Channel	CH1	CH2	CH3	CH4
AH		A/R	B/R	A/R	B/R
BH		REFLECTION	TRANSMISSION	REFLECTION	TRANSMISSION
CH AH + S parameter		S ₁₁	S ₂₁	S ₁₁	S ₂₁

* 4 : Measurement format

Type	Channel	CH1	CH2	CH3	CH4
AH		LOG MAG	LOG MAG	LOG MAG	LOG MAG
BH		LOG MAG	LOG MAG	POLAR	LOG MAG
CH AH + S parameter		LOG MAG	LOG MAG	POLAR	LOG MAG

Table 4-2 Initial Setup Value (2 of 3)

Function	Initialize method	
	Power on or preset	*RST
Reference value		
Logarithmic magnitude	0dB	0dB
Phase	0°	0°
Group delay	0sec	0sec
Smith chart	1	1
Polar coordinate	1	1
Linear magnitude	0	0
SWR	1	1
Real part	10	10
Imaginary part	10	10
Continuous phase	0°	0°
The value per division of Y-axis		
Logarithmic magnitude	* 5	* 5
Phase	45°	45°
Group delay	100nsec	100nsec
Smith chart	-	-
Polar coordinate	-	-
Linear magnitude	100m	100m
SWR	1	1
Rear part	1	1
Imaginary part	1	1
Continuous phase	360°	360°
Reference position		
Logarithmic magnitude	* 6	* 6
Phase	50%	50%
Group delay	50%	50%
Smith chart	-	-
Polar coordinate	-	-
Linear magnitude	0%	0%
SWR	0%	0%
Real part	100%	100%
Imaginary part	100%	100%
Continuous phase	50%	50%

* 5 : Logarithmic magnitude (the value per division of Y-axis)

Type \ Channel	CH1	CH2	CH3	CH4
AH	10dB	10dB	1dB	1dB
BH	5dB	10dB	1 UNIT	1dB
CH	5dB	10dB	1 UNIT	1dB
AH + S parameter				

* 6 : Logarithmic magnitude (reference position)

Type \ Channel	CH1	CH2	CH3	CH4
AH	90%	90%	90%	90%
BH	90%	90%	-	90%
CH	90%	90%	-	90%
AH + S parameter				

4.5 Setting Backup Memory (Factory Default Settings)

Table 4-3 Initial Setup Value (3 of 3)

Function	Initialize method	
	Power on or preset	*RST
Callibration		
Correct measurement	OFF	OFF
Calibration data	Clear	Clear
Electrical length correction	OFF (0sec)	OFF (0sec)
Phase offset	OFF (0 °)	OFF (0 °)
Measurement end extension correction	OFF	OFF
R input	0sec	0sec
A input	0sec	0sec
B input	0sec	0sec
Port 1	0sec	0sec
Port 2	0sec	0sec
Velocity factor	1	1

4.5 Setting Backup Memory (Factory Default Settings)

Table 4-4 Setting Backup Memory

Item	Initial value
GPIB address	11
System controller/Addressable	Addressable
Printer GPIB address	18
Plotter GPIB address	5
Save register	All clear

5 MEASUREMENT METHOD EXAMPLE

This chapter describes the operating method of the R3765/3767H series.
All the screen displays used here are display sample of R3767CH.

5.1 Measurement of Transmission Characteristic (2 Trace Display)

5.1.1 Overlap Display Mode (Two Traces per Screen Measurement)

Here explains magnitude and phase measurement method using simultaneous display of 2 traces.

- 880MHz band-pass filter is used as DUT.
 - ① Setup (refer to sub-section 3.5.1) and preset (refer to sub-section 4.4.1).
 - ② The setting of the R3765/3767H series is as follows.

Block name	Setting	Key operation
ACTIVE CHANNEL	Set the channel to 2.	[CH 2]
RESPONSE	Select the input port in the receiver part.	AH type : Bridge is used. [MEAS] → {B/R} (Initial setup) BH type : [MEAS] → {TRANSMISSION} (Initial setup) CH type or AH type + S parameter [MEAS] → {S21 TRANS FWD} (Initial setup)
	Set the measurement format to magnitude (log display) & phase.	[FORMAT] → {LOG MAG & PHASE}
STIMULUS	Center frequency 880MHz Span frequency 100MHz	[CENTER] → [8] → [8] → [0] → [MHz] [SPAN] → [1] → [0] → [0] → [MHz]

- ③ Calibrate the frequency characteristic
Remove DUT and connect the through adapter instead.
Normalize in this state.
[CAL] → {NORMALIZE (THRU)}
Following the completion, return the connection to DUT (filter).
- ④ Change the scale of displayed trace
When the format is 2 trace simultaneous display like this, select which trace is to be changed by "TRACE".
Adjust the scale for the first trace (magnitude).
[SCALE] → {AUTO SCALE}
The display on the screen is as follows.

5.1 Measurement of Transmission Characteristic (2 Trace Display)

The display contents of input port on upper left of the screen are different depending on the model.

The display of each type is as follows. (Active channel : CH2)

AH type	AH type + S parameter	BH type	CH type
B/R	S21	TRN	S21

TRN : TRANSMISSION

The display section of input port (Example S21 : CH type)

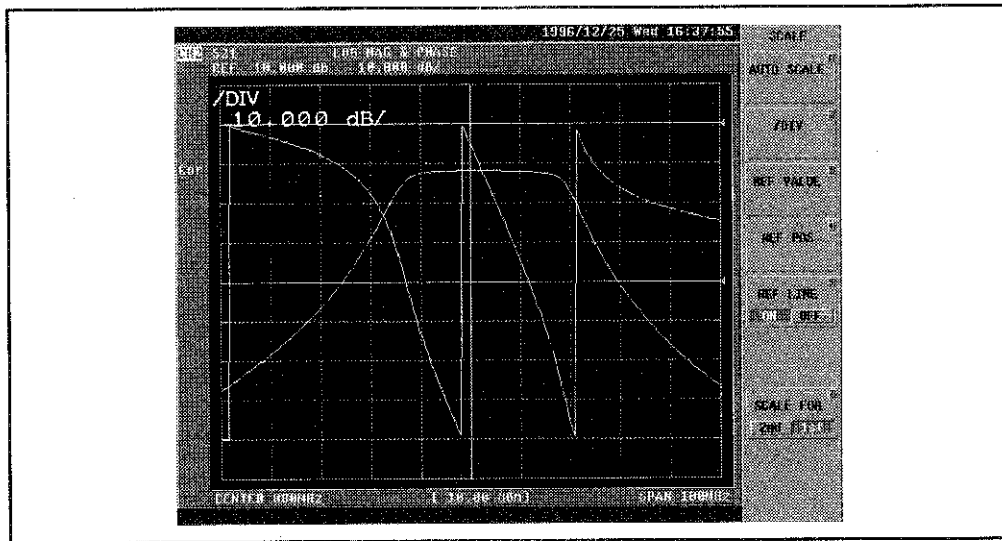

Figure 5-1 Auto-scale of the First Trace of Magnitude/Phase Measurement (Overlap Display)

- ⑤ In order to change the object of scale change to the second trace (phase), select 2nd by "TRACE".

The reference line is also switched to the second trace's.

Then the operation of marker also becomes effective to the second trace.

{TRACE 2nd/1st} → {AUTO SCALE}

5.1 Measurement of Transmission Characteristic (2 Trace Display)

The display on the screen is as follows.

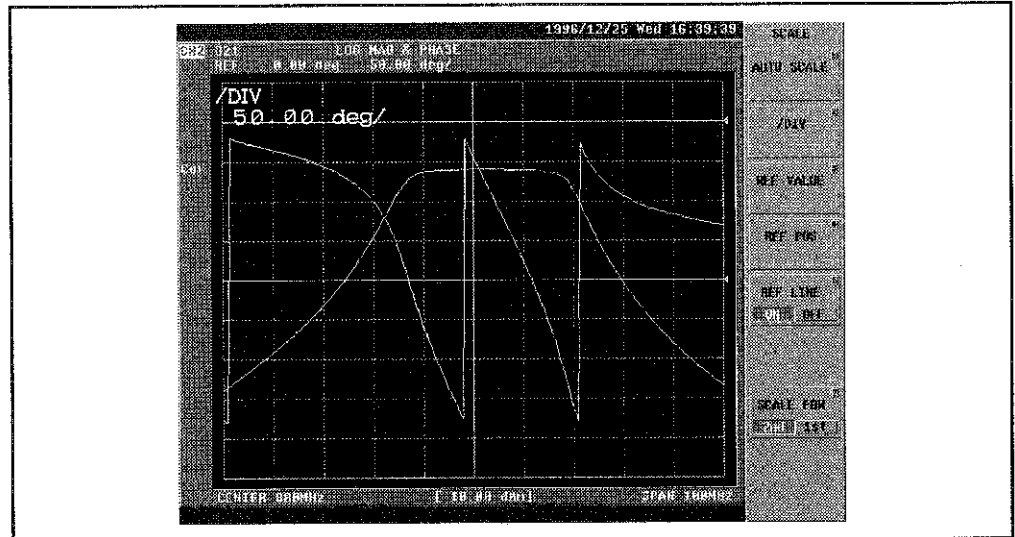

Figure 5-2 Auto-scale of the Second Trace of Magnitude/Phase Measurement (Overlap Display)

- By converting the format as follows, the measured results can be two-trace-overlap-displayed.
- ⑥ Logarithmic magnitude/group delay measurement
 Set the format to logarithmic magnitude (the first trace)/group delay (the second trace) measurement.
[FORMAT] → {More 1/2} → {LOG MAG & DELAY}
 The scale can be changed in the same way as ④ & ⑤.
[SCALE] → {AUTO SCALE}
 {TRACE 2nd/1st} → {AUTO SCALE}
 The display on the screen is as follows.

5.1 Measurement of Transmission Characteristic (2 Trace Display)

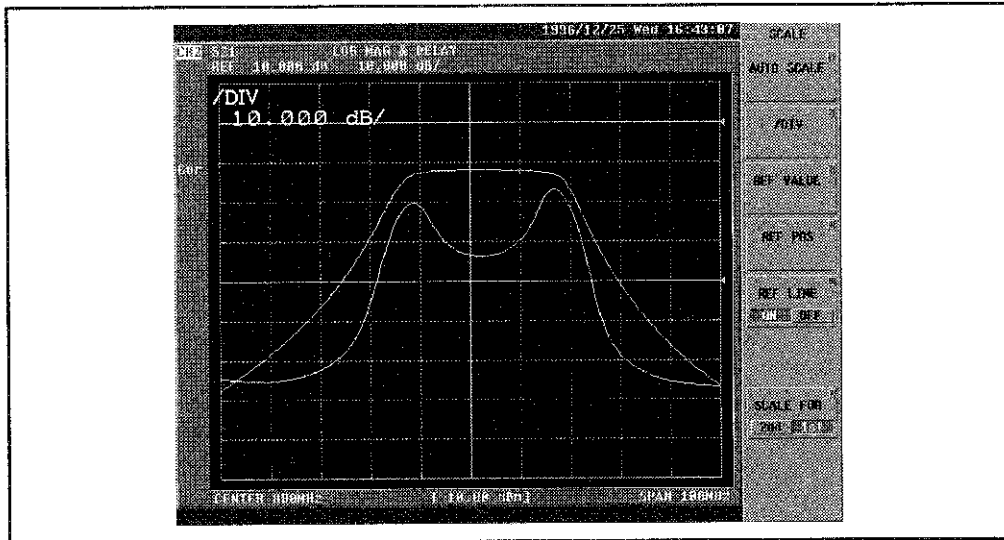

Figure 5-3 Logarithmic Magnitude/Group Delay Measurement (Overlap Display)

⑦ Linear magnitude/phase measurement

Set the format to linear magnitude (the first trace)/phase (the second trace) measurement.

[FORMAT] → {LIN MAG & PHASE}

The scale can be changed in the same way as ④ & ⑤.

[SCALE] → {AUTO SCALE}

{TRACE 2nd/1st} → {AUTO SCALE}

The display on the screen is as follows.

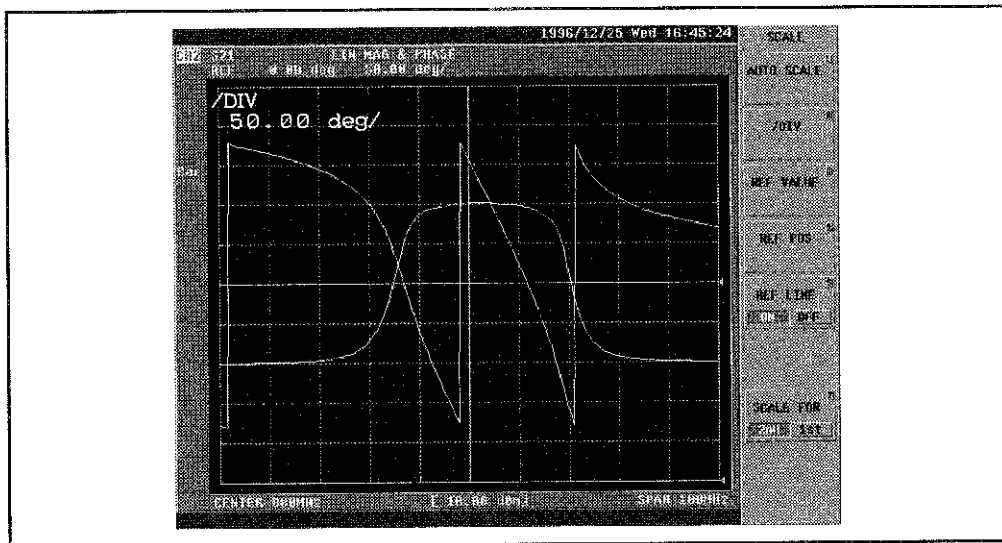

Figure 5-4 Linear Magnitude/Phase Measurement (Overlap Display)

5.1 Measurement of Transmission Characteristic (2 Trace Display)

5.1.2 Split Display

Here explains how to measure logarithmic magnitude and phase with simultaneous display of channel 1 and 2.

- 880MHz band-pass filter is used as DUT.

- ① Setup (refer to sub-section 3.5.1) and preset (refer to sub-section 3.5.1).
- ② The setting of the R3765/3767H series is as follows.

Block name	Setting	Key operation
ACTIVE CHANNEL	Set the channel to 2.	[CH 2]
RESPONSE	Select the input port in the receiver part.	AH type : [MEAS] → {B/R} (Initial setup) BH type : [MEAS] → {TRANSMISSION} (Initial setup) CH type or AH type + S parameter [MEAS] → {S21 TRANS FWD} (Initial setup)
	Set the measurement format to magnitude (log display).	[FORMAT] → {LOG MAG} (Initial setup)
STIMULUS	Center frequency 880MHz Span frequency 100MHz	[CENTER] → [8] → [8] → [0] → [MHz] [SPAN] → [1] → [0] → [0] → [MHz]

- ③ Change the input port of channel 1.

Block name	Setting	Key operation
ACTIVE CHANNEL	Set the channel to 1.	[CH 1]
RESPONSE	Select the input port in the receiver part.	AH type : Bridge is used. [MEAS] → {B/R} BH type : [MEAS] → {TRANSMISSION} CH type or AH type + S parameter [MEAS] → {S21 TRANS FWD}

- ④ Calibrate the frequency characteristic.
First, remove DUT and connect the through adapter instead.
Normalize in this state.
[CH 2] → [CAL] → {NORMALIZE (THRU)}
Following the completion, return the connection to DUT (filter).
- ⑤ Display two screens simultaneously.
[DISPLAY] → {DUAL CH ON/OFF} → {SPLIT CH ON/OFF}

5.1 Measurement of Transmission Characteristic (2 Trace Display)

- ⑥ In two screens display, the operation of format or scale, etc. is performed to the active channel independently. The display of active channel becomes inverted one and the frame of the screen display changes to white.

Set channel 2 to the phase display.

[FORMAT] → {PHASE}

This corresponds to the logarithmic magnitude/phase measurement (overlap display) of sub-section 5.1.1.

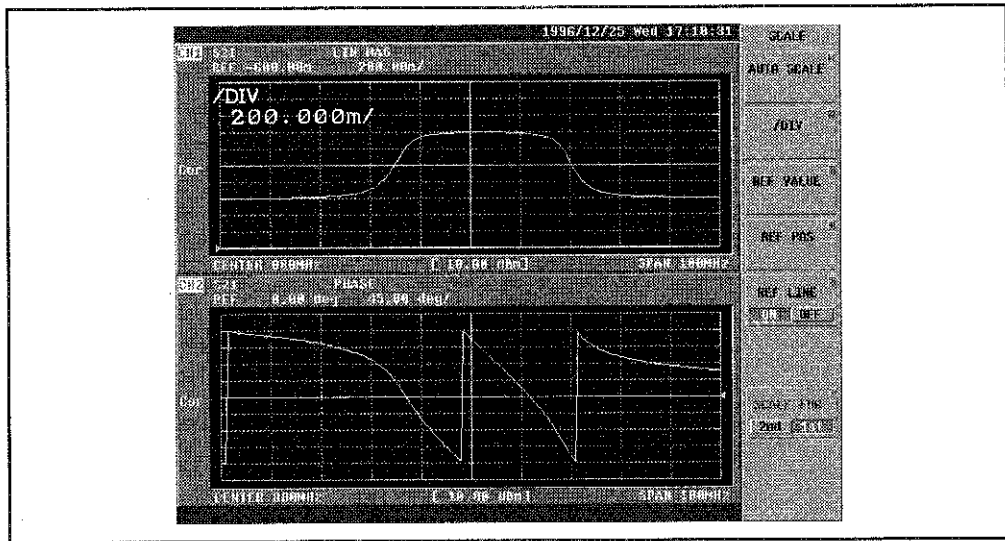

Figure 5-5 Logarithmic Magnitude/Phase Measurement (Split Display)

- ⑦ Set channel 2 to the group delay display.
 {DELAY} → [SCALE] → {AUTO SCALE}

The display on the screen is as follows.

This corresponds to the logarithmic magnitude/group delay measurement (overlap display) of sub-section 5.1.1.

5.1 Measurement of Transmission Characteristic (2 Trace Display)

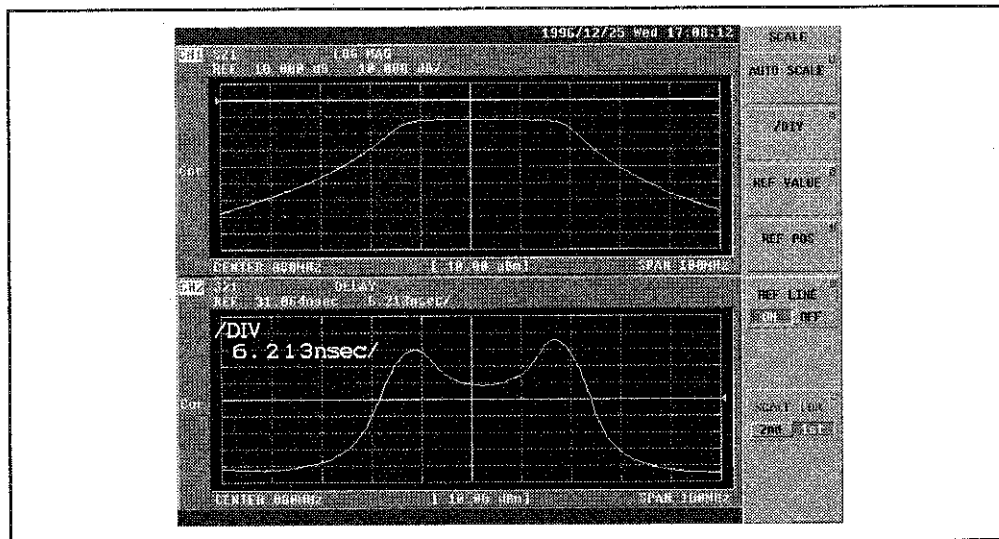

Figure 5-6 Logarithmic Magnitude/Group Delay Measurement (Split Display)

- ⑧ Set channel 2 to the phase and channel 1 to the linear magnitude.

[FORMAT] → {PHASE}

[CH 1] → {LIN MAG} → [SCALE] → {AUTO SCALE}

The display on the screen is as follows.

This corresponds to the linear magnitude/phase measurement (overlap display) of sub-section 5.1.1.

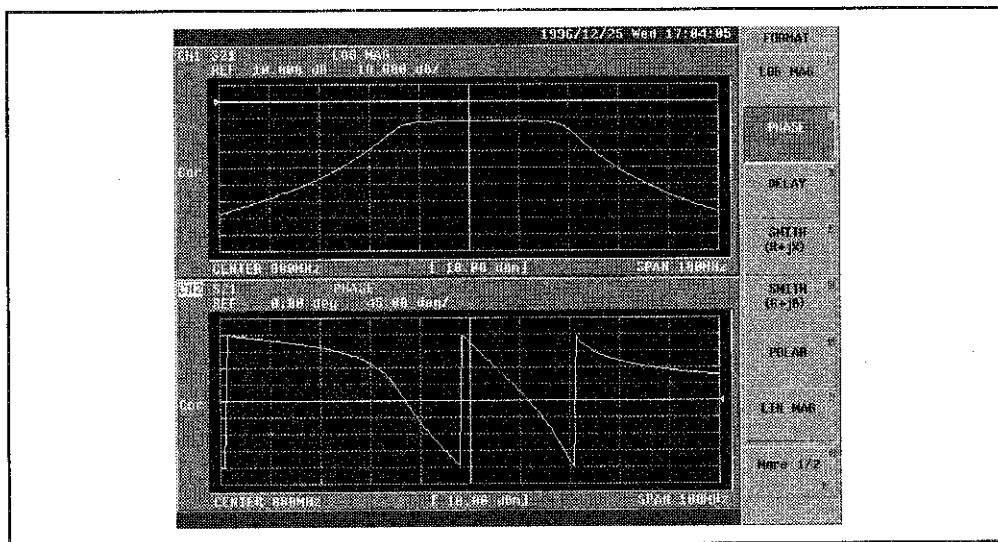

Figure 5-7 Linear Magnitude/Phase Measurement (Split Display)

5.2 Transmission/Reflection Characteristic Measurement (Four Screen Display Mode)

5.2 Transmission/Reflection Characteristic Measurement (Four Screen Display Mode)

5.2.1 Setup

Here explains how to measure all S parameters with four screen display.

S parameter measurement is possible only when AH type + S parameter test set or CH type is used.

Four screen display is possible for either AH type or BH type.

- 880MHz band-pass filter is used as DUT.

① Setup.

(a) In the case of AH type + R3961 (to 3.6GHz)

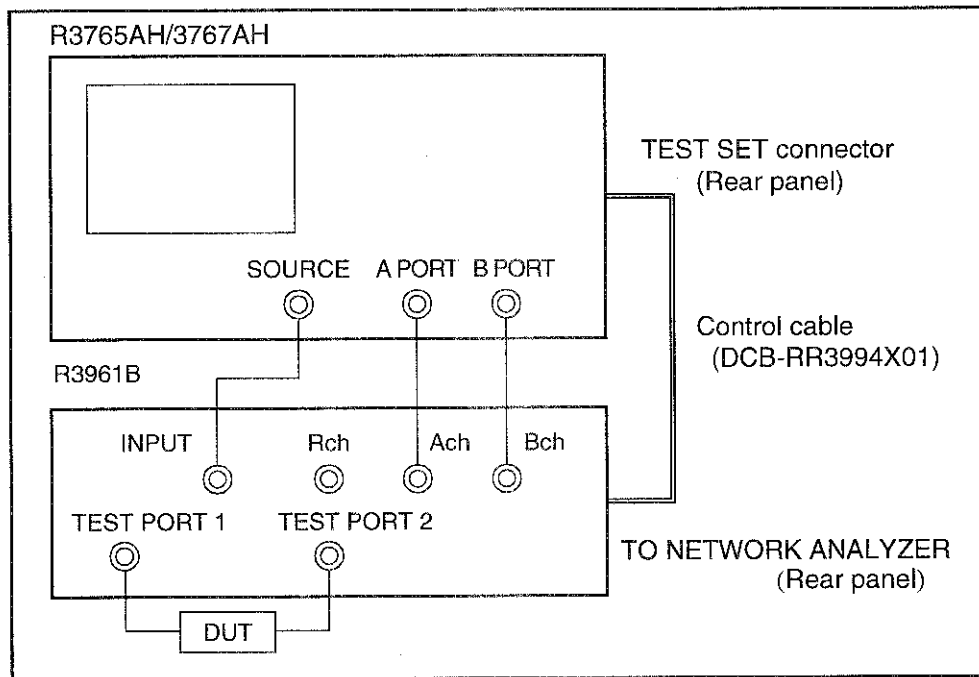

Figure 5-8 Setup of AH Type S Parameter Measurement

5.2 Transmission/Reflection Characteristic Measurement (Four Screen Display Mode)

(b) CH type

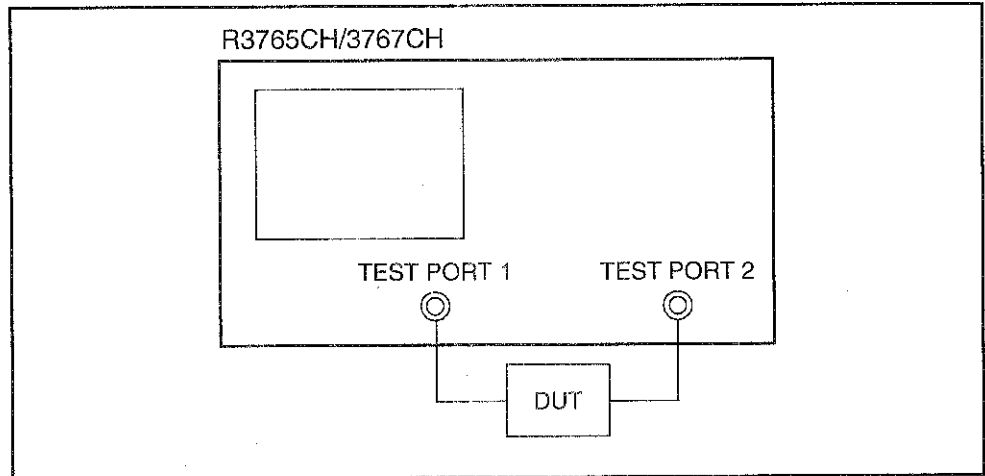

Figure 5-9 Setup of the Reflection Characteristic Measurement

② Setup the R3765/3767H series as follows.

First, preset by pressing **[PRESET]**.

Block name	Setting	Key operation
ACTIVE CHANNEL	Set the channel to 1.	[CH 1] (Initial setup)
RESPONSE	Select the input port in the receiver part.	CH type or AH type + S parameter [MEAS] → {S11 REFL FWD} (Initial setup)
	Set the measurement format to magnitude (log display).	[FORMAT] → {LOG MAG} (Initial setup)
STIMULUS	Center frequency 880MHz Span frequency 100MHz	[CENTER] → [8] → [8] → [0] → [MHz] [SPAN] → [1] → [0] → [0] → [MHz]

5.2.2 Calibration (two port full calibration)

Here explains about the calibration of the directivity of 2-port-device forward direction and inverse direction, the source match, the load match, the frequency tracking and the isolation.

By this calibration, all S parameters of 2-port-device can be measured at the highest accuracy.

This calibration is possible only in the case of AH type + S parameter test set or CH type.

CAUTION!

1. If the calibration has already been executed, switch OFF the calibration, clear the calibration data, and then start the calibration.
2. When the message "Wait for Sweep" disappeared, each calibration completes.
3. During it's displayed, the R3765/3767H series, the cable, the connector, etc. must not be moved.

5.2 Transmission/Reflection Characteristic Measurement (Four Screen Display Mode)

- ① Invoke 2-port full calibration menu.
[CAL] → {CAL MENUS} → {2PORT FULL CAL}
- ② Invoke the reflection menu of 2-port reflection calibration.
{REFLECT'N}
- ③ Connect the open-standard to the test port 1 and acquire calibration data.
Pressing {S11(PORT 1) FWD:OPEN}, the display on the screen becomes as follows.

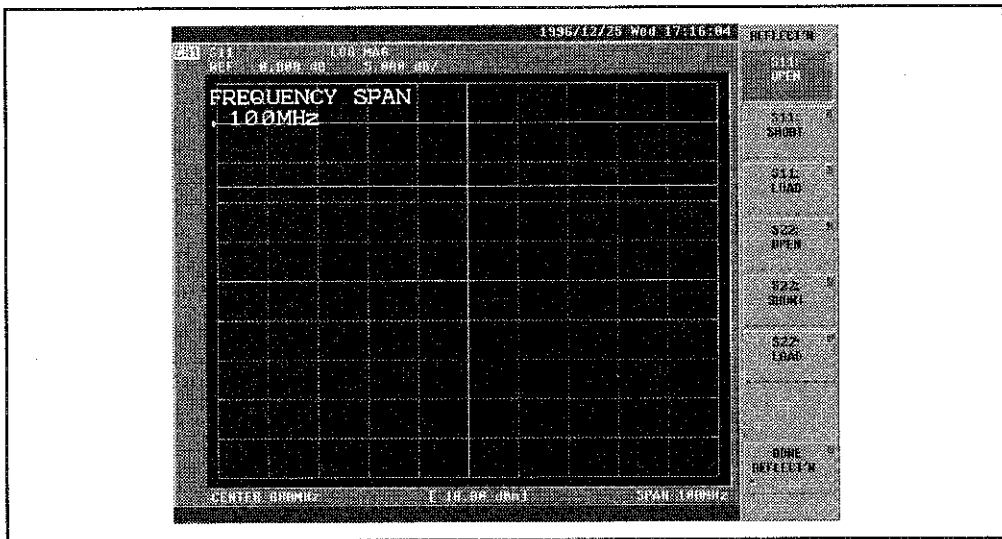

Figure 5-10 Calibration of 2-Port Reflection (Test Port/Open)

- ④ Connect the short-standard to the test port 1 and acquire calibration data.
{S11(PORT 1) FWD:SHORT}
- The display on the screen is as follows.

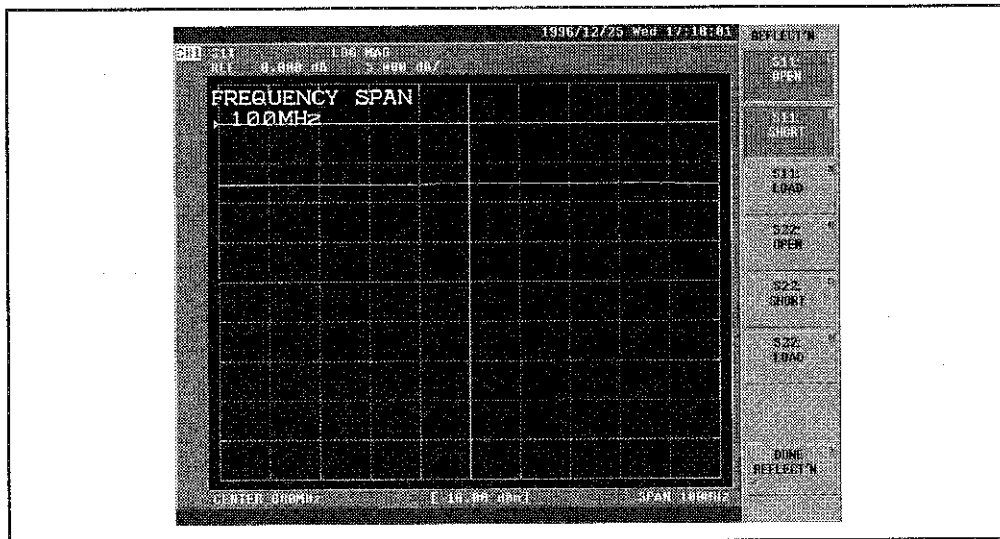

Figure 5-11 Calibration of 2-Port Reflection (Test Port/Short)

5.2 Transmission/Reflection Characteristic Measurement (Four Screen Display Mode)

- ⑤ Connect the load-standard to the test port 1 and acquire calibration data.

{S11(PORT 1) FWD:LOAD}

The display on the screen is as follows.

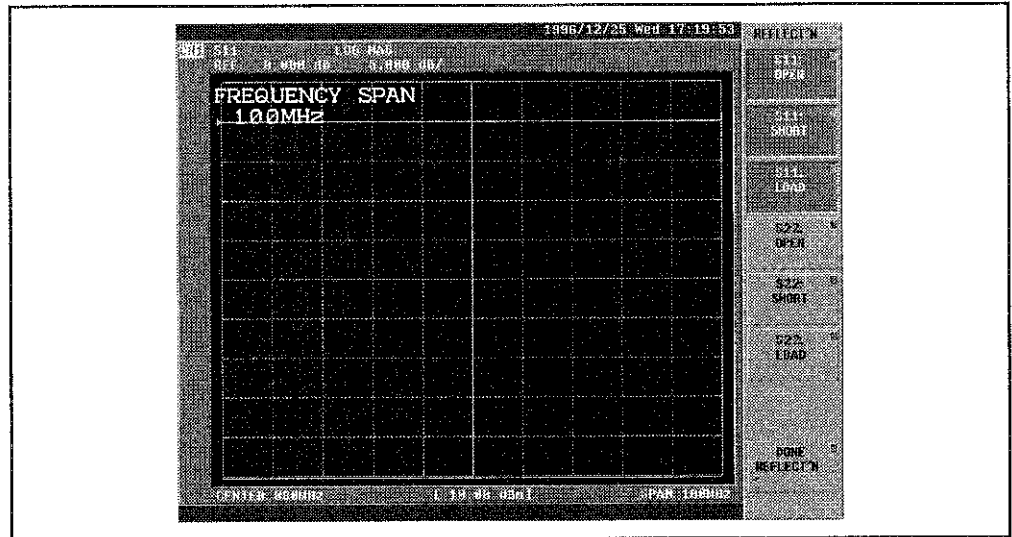

Figure 5-12 Calibration of 2-Port Reflection (Test Port/Load)

- ⑥ Calibrate the test port 2 in the same way as the test port 1.

Connect the open-standard to the test port 2 and acquire calibration data.

{S22(PORT 2) REV:OPEN}

- ⑦ Connect the short-standard to the test port 2 and acquire calibration data.

{S22(PORT 2) REV:SHORT}

- ⑧ Connect the load-standard to the test port 2 and acquire calibration data.

{S22(PORT 2) REV:LOAD}

- ⑨ Execute calibration of the reflection characteristic.

{DONE REFLECT'N}

Calibration data of each calibration standard can be acquired again before this key is pressed.

Following the completion of the reflection characteristic calibration, returns to 2-port full calibration menu.

5.2 Transmission/Reflection Characteristic Measurement (Four Screen Display Mode)

The display on the screen is as follows.

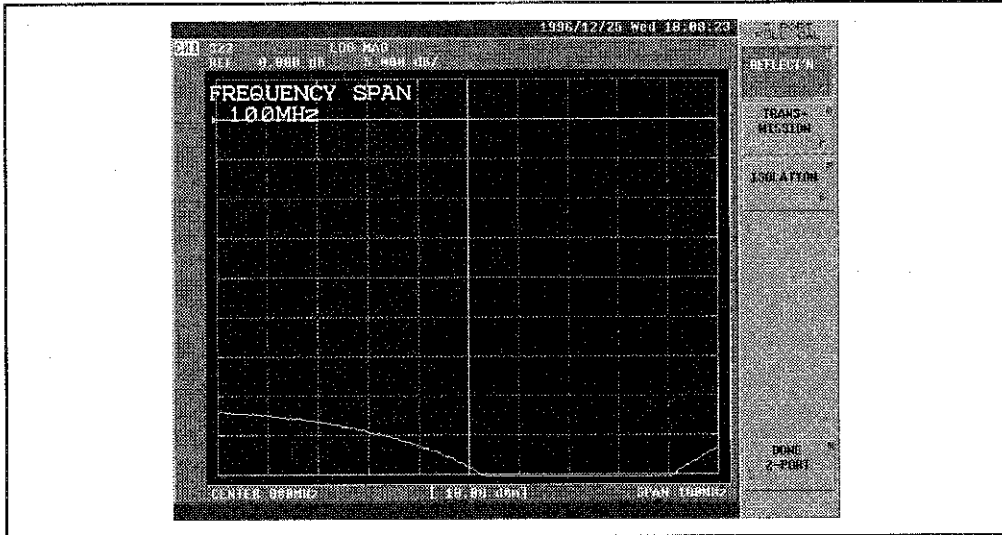

Figure 5-13 Execution of 2-Port Reflection Characteristic Calibration

- ⑩ Invoke transmission menu of 2-port transmission characteristic calibration.
{TRANSMISSION}
- ⑪ Connect the through-standard between test port 1 and test port 2.
{FWD. TRAN. THRU}

The display on the screen is as follows.

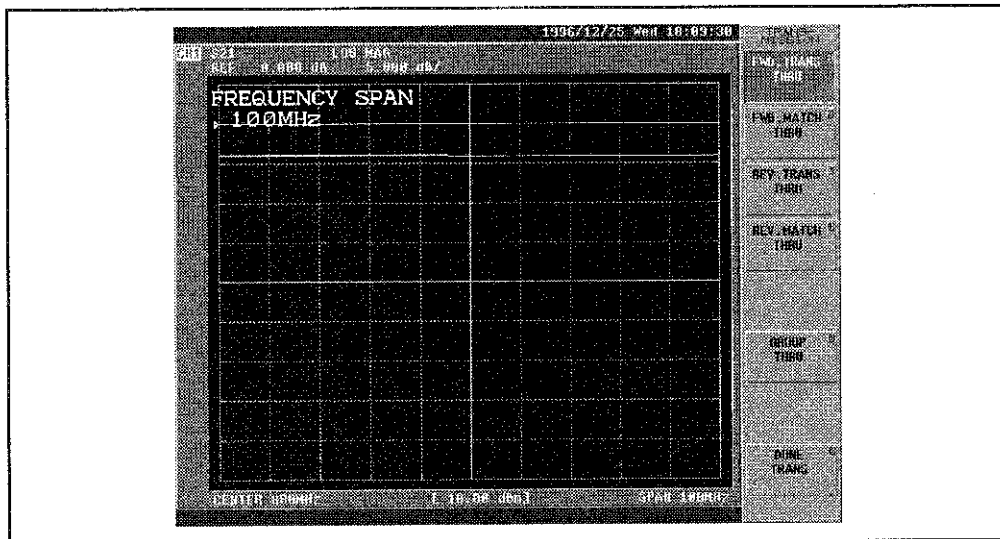

Figure 5-14 Calibration of 2-Port Transmission Characteristic (Forward Direction)

5.2 Transmission/Reflection Characteristic Measurement (Four Screen Display Mode)

- ⑫ Acquire the following each calibration data.

*{FWD.MATCH THRU} **

*{REV.TRANS THRU} **

*{REV.MATCH THRU} ** * : *{GROUP THRU}* can be substituted.

- ⑬ Execute calibration of the transmission calibration.

{DONE TRANS}

Calibration data of each calibration standard can be acquired again before this key is pressed.

Following the completion of transmission characteristic calibration, returns to 2-port full calibration menu.

The display on the screen is as follows.

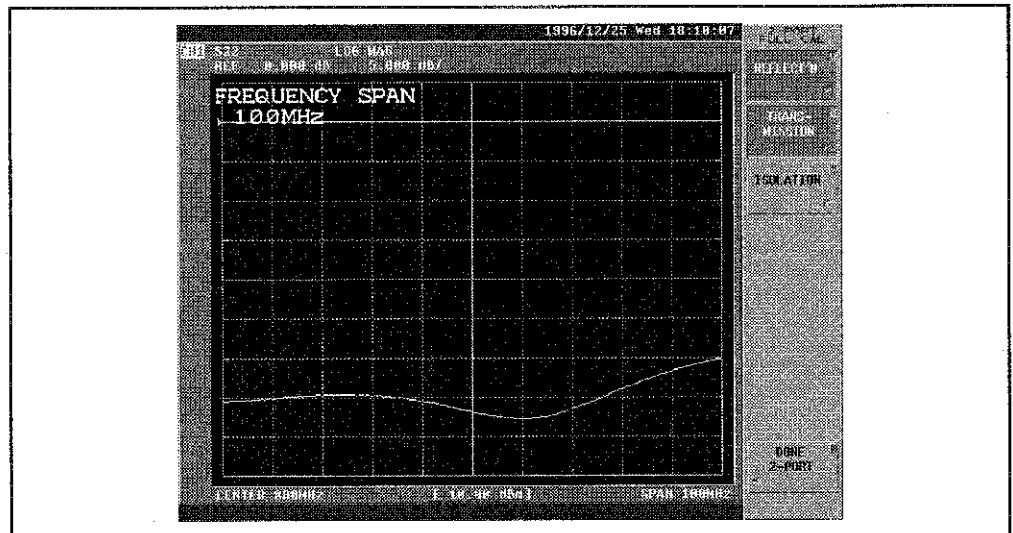

Figure 5-15 Execution of 2-Port Transmission Characteristic Calibration

- ⑭ Invoke 2-port isolation menu.

{ISOLATION}

- ⑮ When the isolation calibration is omitted,

{OMIT ISOLATION}

When the isolation calibration is performed,

Connect the load-standard to the test port 1 and the test port 2 to acquire calibration data.

{FMD ISOL'L}

{REV ISOL'L}

- ⑯ Executes the isolation calibration

{DONE ISOLATION}

5.2 Transmission/Reflection Characteristic Measurement (Four Screen Display Mode)

Following the completion of the isolation calibration, returns to 2-port full calibration menu.

The display on the screen is as follows.

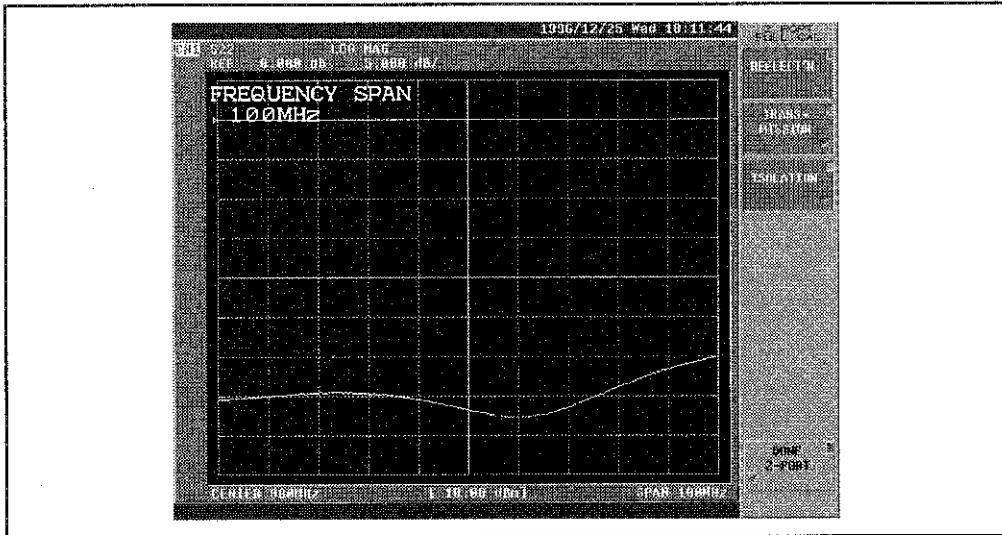

Figure 5-16 Execution of the Isolation Calibration

- ⑰ Executes 2-port full calibration
{*DONE 2-PORT*}

The display on the screen is as follows.

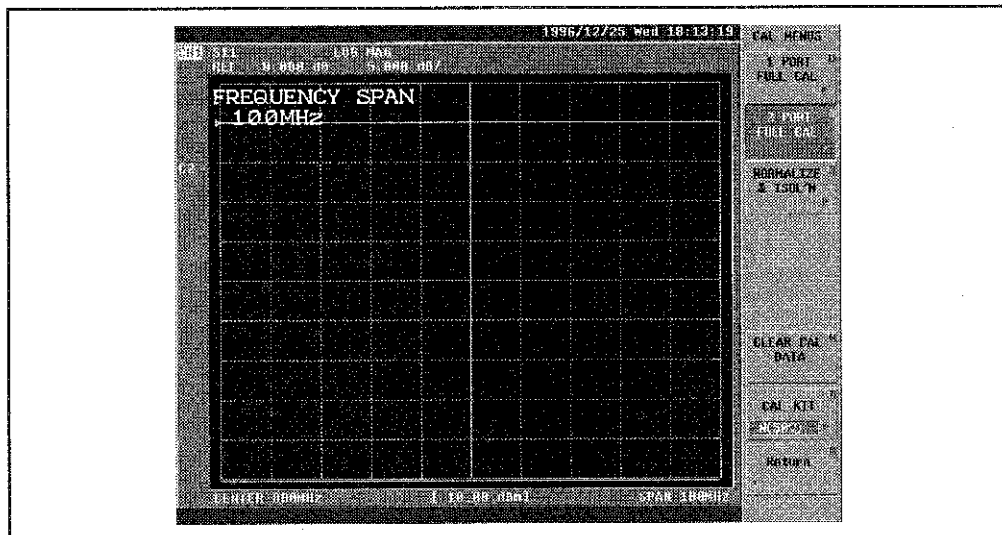

Figure 5-17 Execution of 2-Port Full Calibration

- ⑱ Connect DUT again and perform the measurement.

5.2 Transmission/Reflection Characteristic Measurement (Four Screen Display Mode)

5.2.3 Four Screen Display

Here explains how to operate 4 screen display of all S parameters.

The following is a sample of 4 screen display.

<p>[CH1] : S11 Smith chart [SMITH (R+jX)]</p>	<p>[CH2] : S12 Magnitude/Phase [LOG MAG & PHASE]</p>
<p>[CH3] : S22 Smith chart [SMITH (R+jX)]</p>	<p>[CH4] : S21 Magnitude/Group delay time [LOG MAG & DELAY]</p>

The position of channel 1 to 4 is fixed, but the measurement mode, the format and the scale, etc. can be set to active channel independently.

- ① Set S11 Smith chart to channel 1.

[FORMAT] → {SMITH (R+jX)}

The display on the screen is as follows.

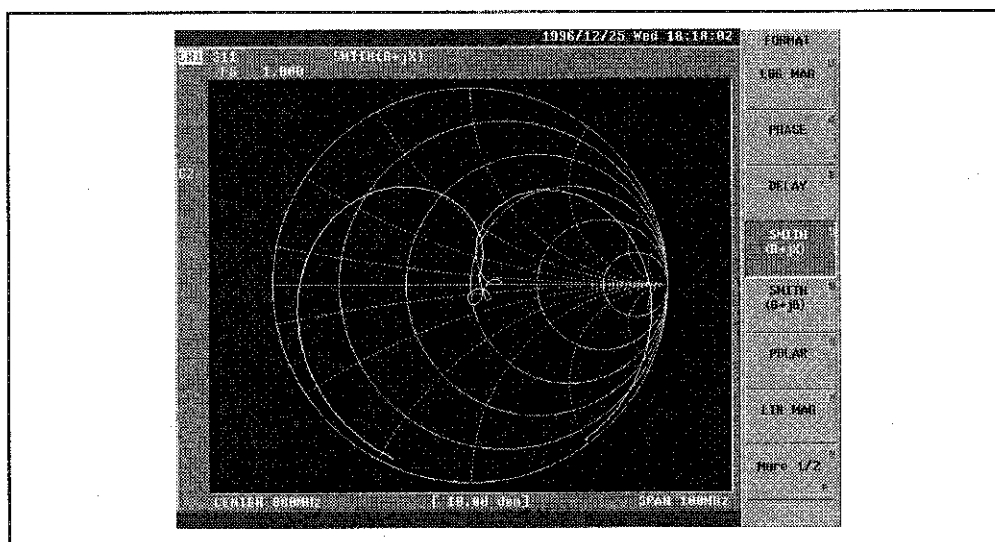

Figure 5-18 4 Screen Display (Channel 1)

- ② Select S22 for channel 3.

[MEAS] → {SUB MEAS ON/OFF} → {S22 REFL REV}

Switch ON.

The active channel is switched to 3 and the format is set with Smith chart.

5.2 Transmission/Reflection Characteristic Measurement (Four Screen Display Mode)

[FORMAT] → {SMITH (R+jX)}

Each time **[CH 1]** is pressed, the active channel is switched between channel 1 and channel 3.

The display on the screen is as follows.

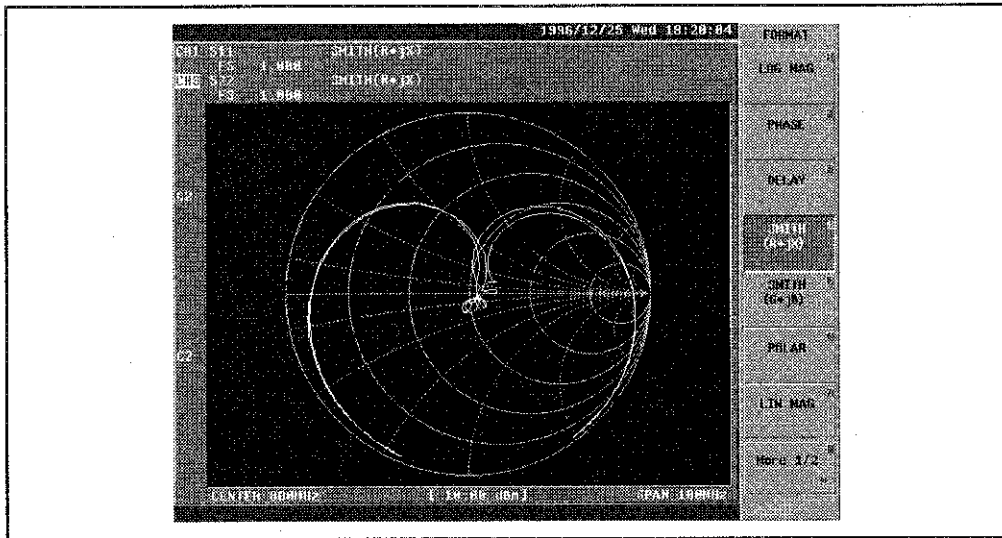

Figure 5-19 4 Screen Display (Overlap Display of Channel 1 and 3)

- ③ Split-displays channel 1 and 3.

[DISPLAY] → {SPLIT CH ON/OFF}

Each time **[CH 1]** is pressed, the active channel is switched between channel 1 and 3.

The display on the screen is as follows.

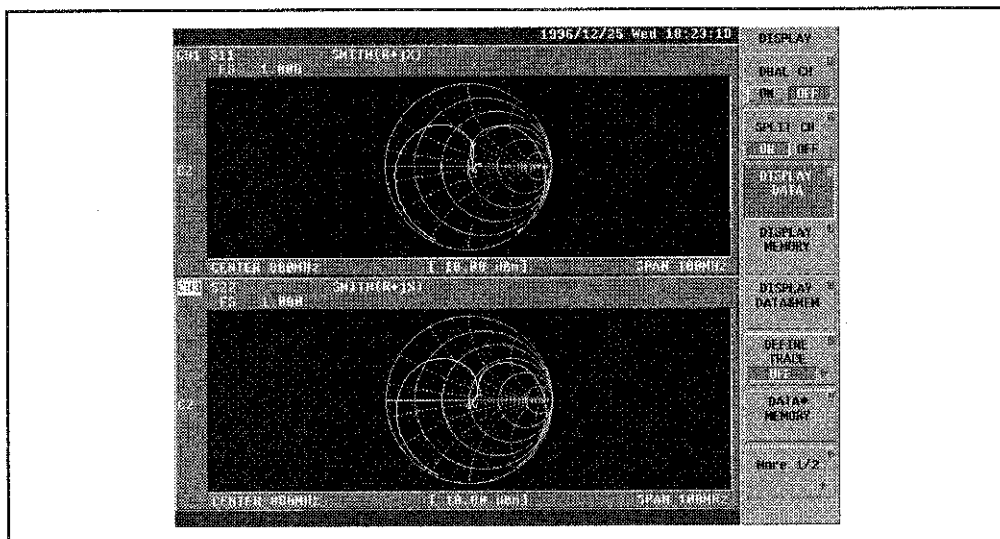

Figure 5-20 4 Screen Display (Split Display of Channel 1 and 3)

5.2 Transmission/Reflection Characteristic Measurement (Four Screen Display Mode)

- ④ Select S12 for channel 2.

[CH 2] → [MEAS] → {S12 TRANS REV}

Change the format to logarithmic magnitude and phase.

[FORMAT] → {LOGMAG & PHASE}

Adjust the scale.

[SCALE] → {AUTO SCALE} → {TRACE 2nd/1st} → {AUTO SCALE}

The display on the screen is as follows.

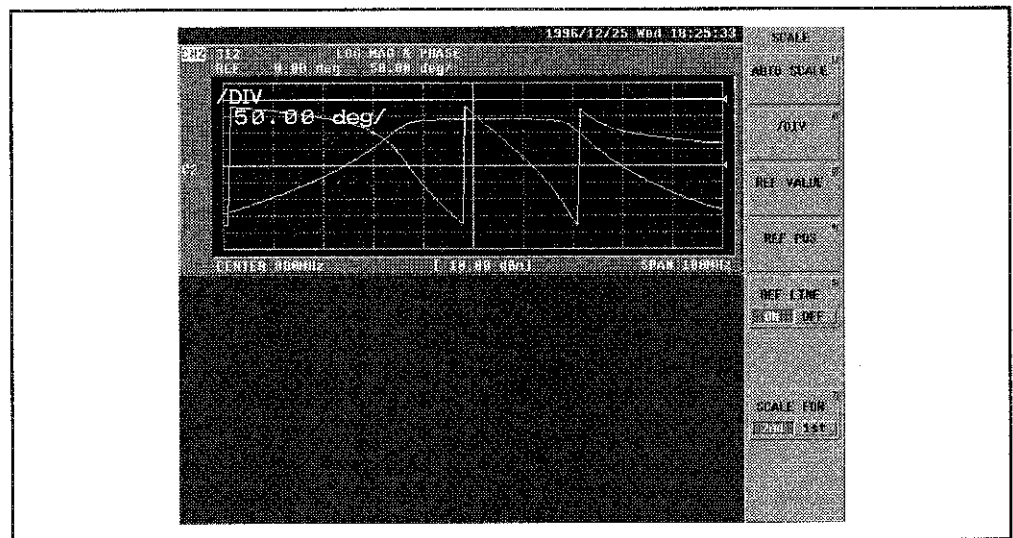

Figure 5-21 4 Screen Display (Channel 2)

- ⑤ Select S21 for channel 4.

[MEAS] → {SUB MEAS ON/OFF} → {S21 TRANS FWD}

Switch ON.

Active channel is switched to 4 and the format is set with logarithmic magnitude & group delay.

[FORMAT] → {More 1/2} → {LOG MAG & DELAY}

Each time [CH 2] is pressed, the active channel is switched between channel 2 and channel 4.

Adjust the scale.

[SCALE] → {AUTO SCALE} → {TRACE 2nd/1st} → {AUTO SCALE}

5.2 Transmission/Reflection Characteristic Measurement (Four Screen Display Mode)

The display on the screen is as follows.

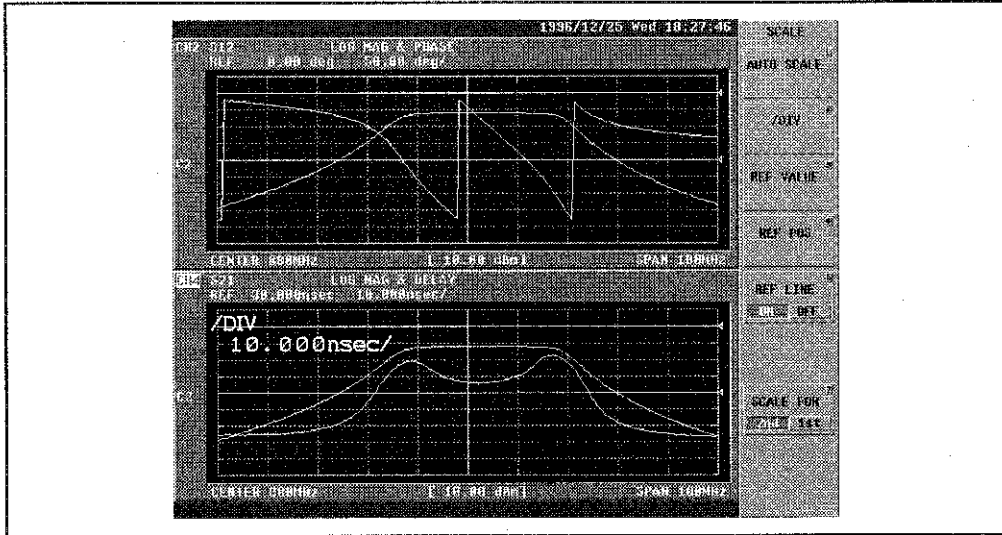

Figure 5-22 4 Screen Display (Split Display of Channel 2 and 4)

- ⑥ Dual-display channel 1 (channel 3) and channel 2 (channel 4).

[DISPLAY] → {DUAL CH ON/OFF}

Then the active channel becomes channel 4.

Each time [CH 2] is pressed, the channel is switched to 2.

When channel 1 or channel 3 is required to change to active channel, press [CH 1].

The display on the screen is as follows.

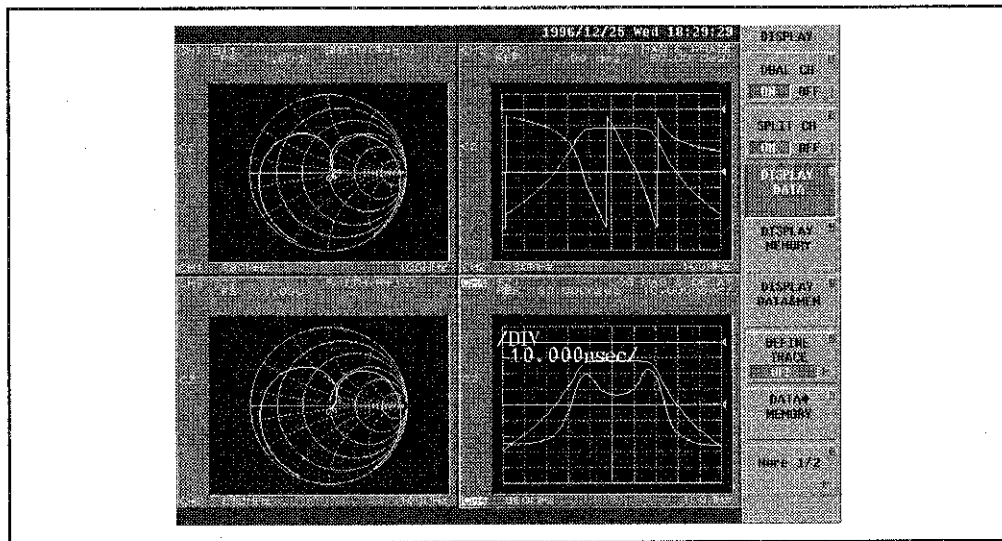

Figure 5-23 The Finished 4 Screen Display

5.3 Narrow Band/Wide Band Sweep Measurement

Here explains how to set different measurement conditions between channel 1 and 2.

- 880MHz band-pass filter is used as DUT.
 - ① Setup (filter connection) (refer to sub-section 3.5.1) and preset (refer to sub-section 4.4.1).
 - ② Set the measurement conditions of channel 1 and channel 2 independently.
[MEAS] → {*COUPLED CH ON/OFF*}
 - ③ Set the measurement mode, the bandwidth and the format of channel 1.
[MEAS]
 AH type : {*B/R*}
 BH type : {*TRANSMISSION*}
 CH type : {*S21 TRANS FWD*}
[CENTER] → [8] → [8] → [0] → [MHz]
[SPAN] → [1] → [0] → [0] → [MHz]
[FORMAT] → {*LOG MAG*}
 - ④ Set the format and the bandwidth of channel 2.
[CH 2]
[CENTER] → [8] → [8] → [0] → [MHz]
[SPAN] → [6] → [0] → [0] → [MHz]
[FORMAT] → {*LOG MAG*}
 - ⑤ Calibrate the frequency characteristic of channel 1.
 Remove DUT and connect the through adapter instead.
 Normalize in this state.
[CH 1] → [CAL] → {*NORMALIZE (THRU)*}
 - ⑥ Calibrate the frequency characteristic of channel 2 in the same way.
[CH 2] → {*NORMALIZE (THRU)*}
 Following the completion, return the connection to DUT (filter).

5.3 Narrow Band/Wide Band Sweep Measurement

- ⑦ Display two channels simultaneously.

[DISPLAY] → {DUAL CH ON/OFF}

The measurement screen is as follows.

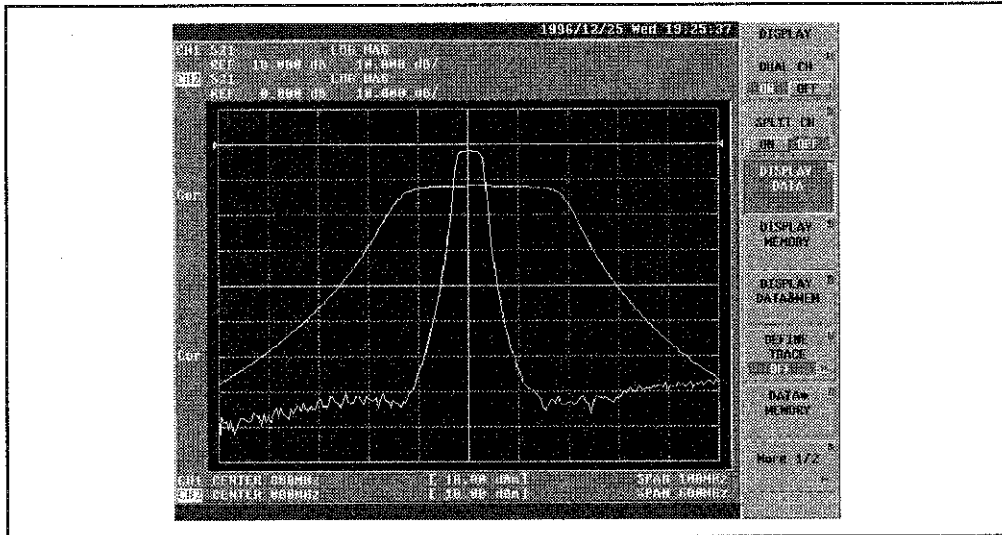

Figure 5-24 Two Channels Simultaneous Display (Overlap Display)

- ⑧ Display split into two parts, upper and lower. (Split display)

{SPLIT CH ON/OFF}

The measurement screen is as follows.

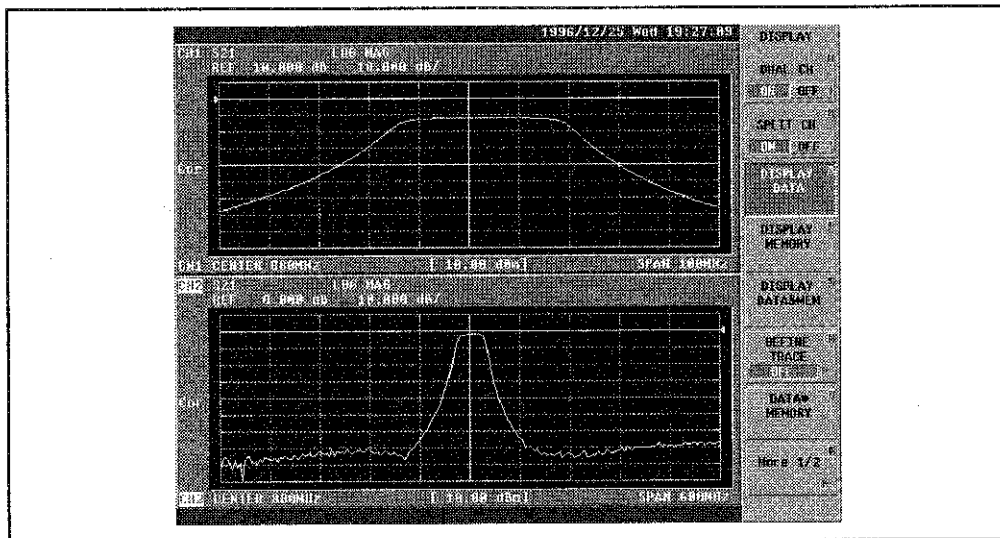

Figure 5-25 Two Channels Simultaneous Display (Split Display)

5.4 Multi-marker List Display

Here explains how to operate multi-marker.

- 880MHz band-pass filter is used as DUT.

- ① Setup (filter connection) (refer to sub-section 3.5.1) and preset (refer to sub-section 4.4.1).

Press **[CH 2]** to set the active channel to 2.

- ② Set the center frequency and the span.

[CENTER] → **[8]** → **[8]** → **[0]** → **[MHz]**

[SPAN] → **[2]** → **[0]** → **[0]** → **[MHz]**

- ③ Calibrate the frequency characteristic.

Remove DUT and connect the through adapter instead.

Normalize in this state.

Following **[CAL]** → *{NORMALIZE (THRU)}*, return the connection to DUT (filter).

- ④ Display multi-marker.

Maximum 10 markers are displayed in one channel.

A marker is displayed in each calibration marking of the horizontal axis.

[MAK]

{ACTIVATE MARKER[]} → *{MARKER 2}* → **[↑]**

{MARKER 3} → **[↑]** → **[↑]**

{MARKER 4} → **[↑]** → **[↑]** → **[↑]**

{MARKER 5} → **[↑]** → **[↑]** → **[↑]** → **[↑]**

{More 1/2} → *{MARKER 6}* → **[↓]**

{MARKER 7} → **[↓]** → **[↓]**

{MARKER 8} → **[↓]** → **[↓]** → **[↓]**

{MARKER 9} → **[↓]** → **[↓]** → **[↓]** → **[↓]**

{MARKER 10} → **[↓]** → **[↓]** → **[↓]** → **[↓]** → **[↓]**

5.4 Multi-marker List Display

By the operation in the previous page, the markers are displayed as follows.

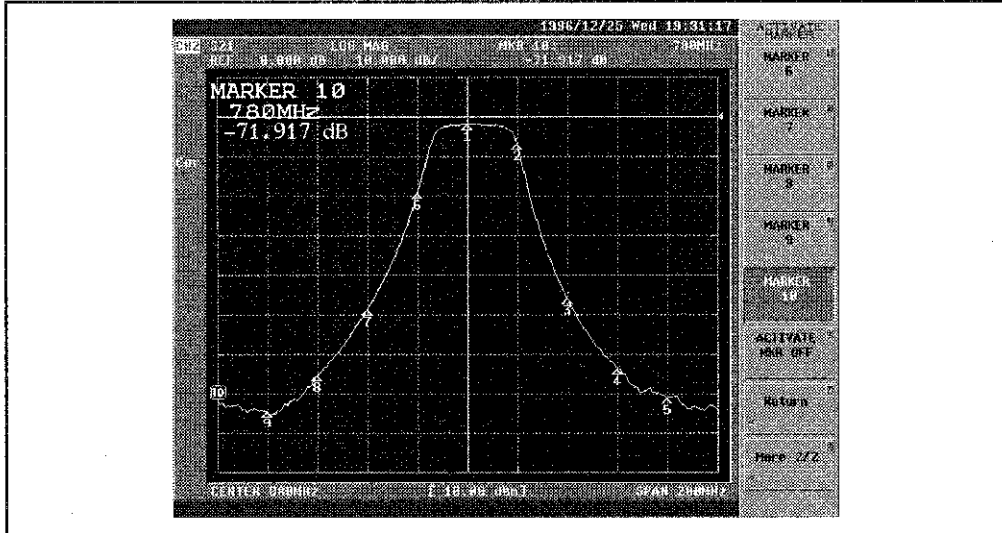

Figure 5-26 Multi-marker Display

- ⑤ Display marker list.

All the marker data are displayed.

{Return} → {MKR LIST ON/OFF}

By the operation above, the marker and the list are displayed as follows.

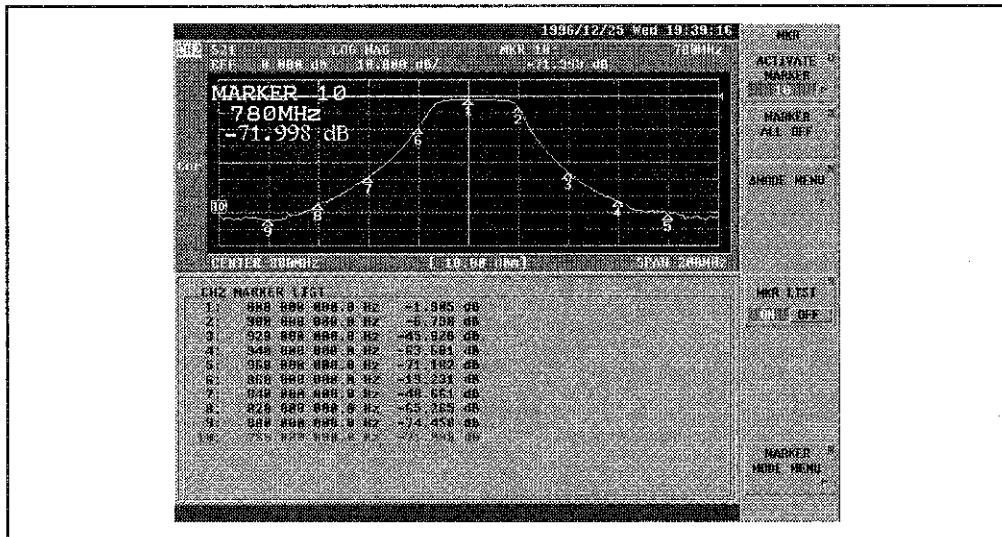

Figure 5-27 Display of Multi-marker List

5.5 Ripple Measurement in the Bandwidth

Here explains how to measure the ripple in the bandwidth.

- 385MHz band-pass filter is used as DUT.

- ① Setup (filter connection) (refer to sub-section 3.5.1) and preset (refer to sub-section 4.4.1).

Press **[CH 2]** to set the active channel to 2.

- ② Set the center frequency and the span.

[CENTER] → **[3]** → **[8]** → **[5]** → **[MHz]**

[SPAN] → **[5]** → **[0]** → **[MHz]**

- ③ Calibrate the frequency characteristic.

Remove DUT and connect the through adapter instead.

Normalize in this state.

[CAL] → **{NORMALIZE (THRU)}**

Following the completion, return the connection to DUT (filter).

- ④ Set the measurement format to magnitude (log display) and adjust the scale.

[SCALE] → **{AUTO SCALE}**

- ⑤ Specify a part (delta section).

Specify a delta section.

Move marker 1 with the data knob to one end of the specified section.

[MKR]

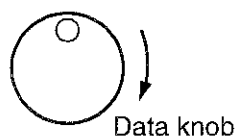

Set the reference marker to the position of marker 1.

{ΔMODE MENU} → **{ΔREF = ΔMKR}**

Move marker 1 with the data knob to the other end of the specified section.

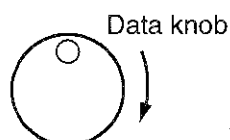

The area between the reference marker and marker 1 is the delta section.

Specify the delta section as the range of partial search.

[MKR→] → **{PART SRCH []}** → **{SET RANGE}**

Make the partial search effective.

{PART SRCH ON/OFF}

5.5 Ripple Measurement in the Bandwidth

The display on the screen is as follows.

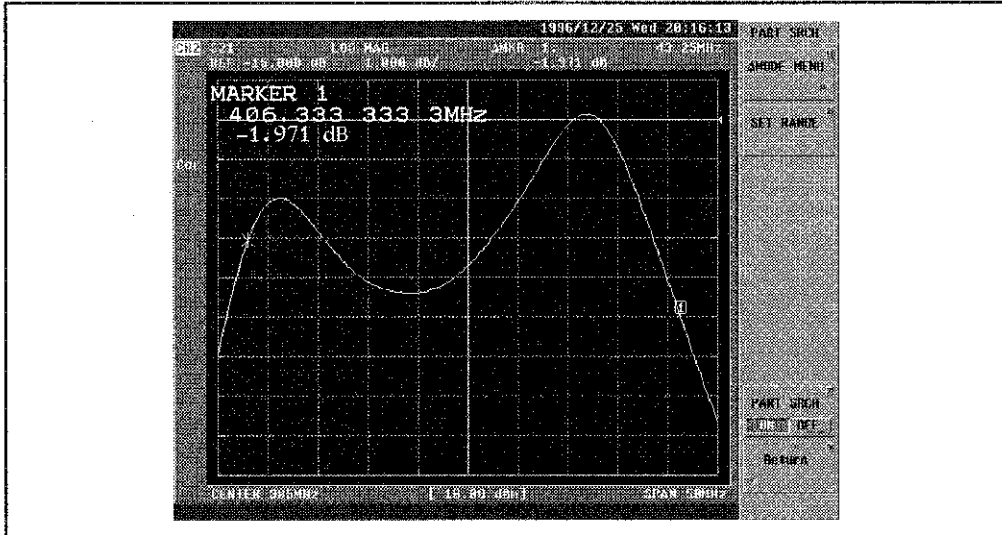

Figure 5-28 Specification of Delta Section (Partial Search)

- ⑥ Search the maximum value in the delta section.

[Return] → {MKR SRCH []} → {MAX}

The display on the screen is as follows.

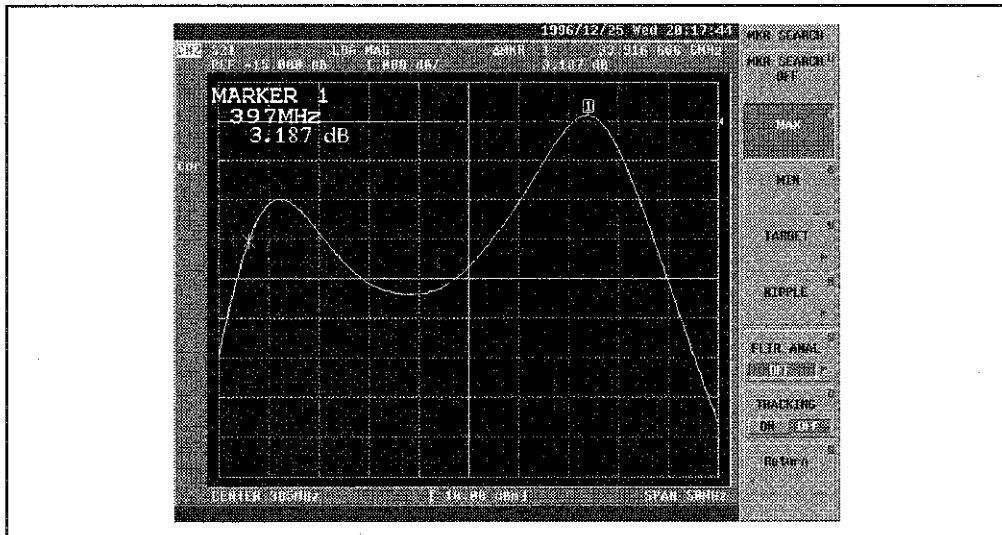

Figure 5-29 Measurement of Maximum Value in the Delta section

- ⑦ Search the minimum value in the delta section.

{MIN}

The display on the screen is as follows.

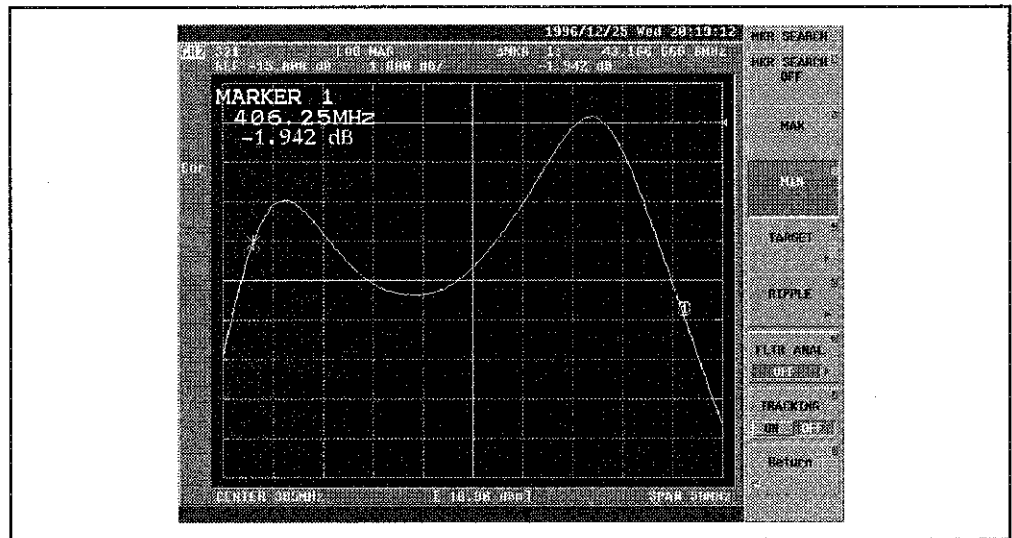

Figure 5-30 Measurement of Minimum Value in the Delta Section

- ⑧ Search ripple in the delta section.

{RIPPLE} → {ΔMAX0-MINU}

The reference marker moves to the most minimum point of the minimum points and the active marker moves to the most maximum point of the maximum points.

The display on the screen is as follows.

The difference of the both marker values is displayed in the active marker area.

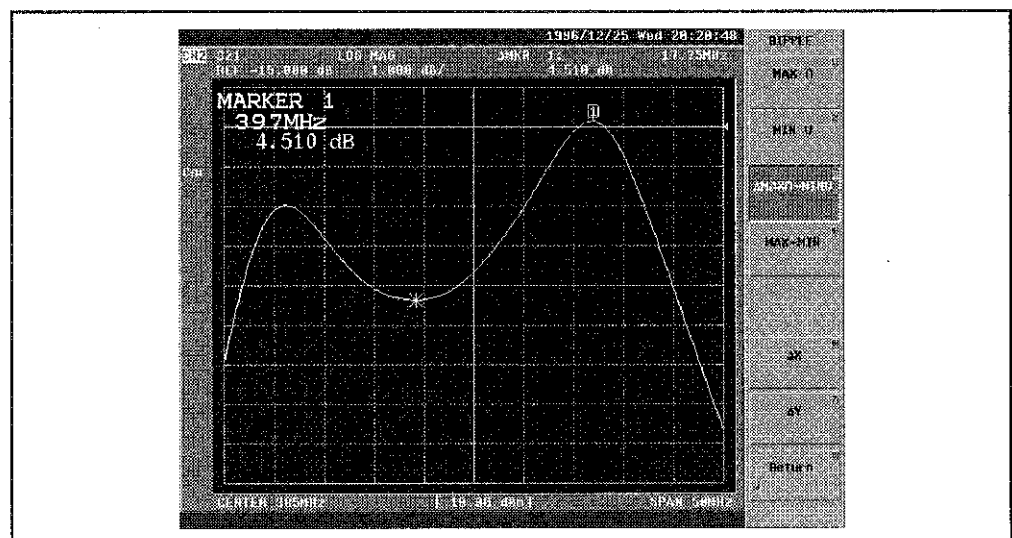

Figure 5-31 Measurement of Ripple in the Delta Section

5.6 Measurement of Electrical Length

5.6 Measurement of Electrical Length

Here explains about the measurement of electrical length using correction function of electrical length.

- Cable is used as DUT.
 - ① Setup (cable connection) (refer to sub-section 3.5.1) and preset (refer to sub-section 4.4.1).
Press [CH 2] to set the active channel to 2.
 - ② Set the start-frequency and the stop-frequency.
[START] → [4] → [0] → [MHz]
[STOP] → [1] → [GHz]
 - ③ Calibrate the frequency characteristic.
Remove DUT and connect the through adapter instead.
Normalize in this state.
[CAL] → {NORMALIZE (THRU)}
After the completion, return the connection to DUT (cable).
 - ④ Change the measurement format.

[FORMAT] → {PHASE}
The display on the screen is shown in the Figure 5-32.
Thus the phase characteristic shows that DUT has electrical length, by which the phase decreases linearly.
The electrical length of this DUT can be measured by correcting the electrical length.

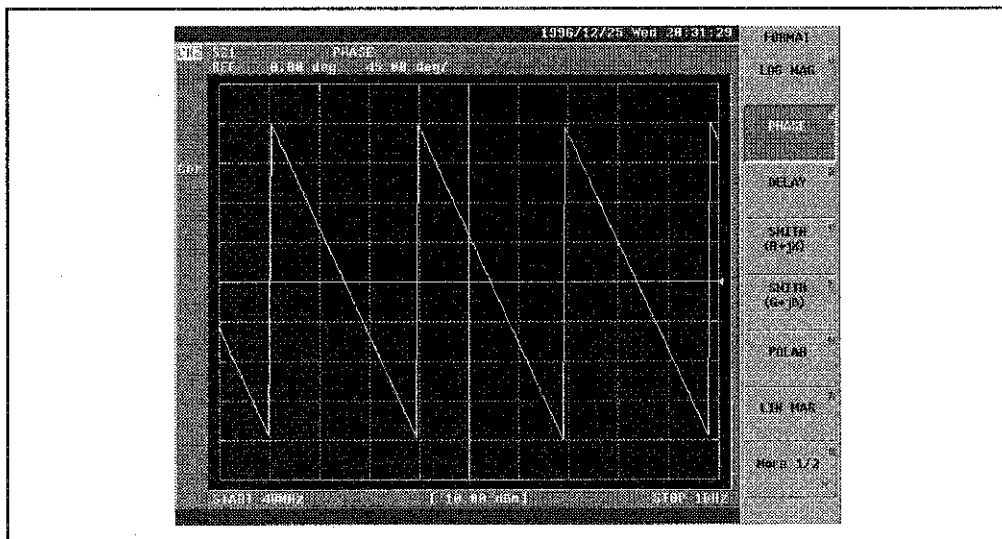

Figure 5-32 Electrical Length of Cable

- ⑤ Set to electrical length correction mode.

[CAL] → {More 1/2} → {ELEC DELAY ON/OFF} → {ELECTRICAL DELAY}

The display on the screen is as follows.

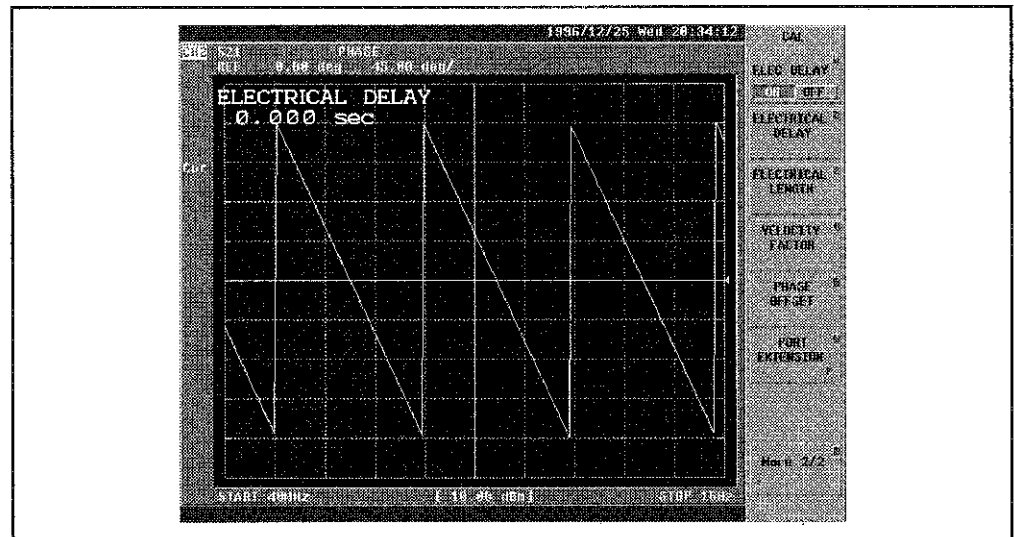
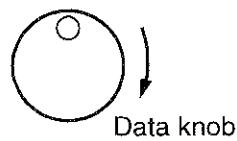

Figure 5-33 Electrical Length Correction Mode

- ⑥ Correct the electrical length by using the phase characteristic until the phase characteristic becomes flat.

(It may be necessary to turn the knob several times until the phase characteristic becomes flat.)

This correction value is the electrical length of DUT.



5.6 Measurement of Electrical Length

The display on the screen is as follows.

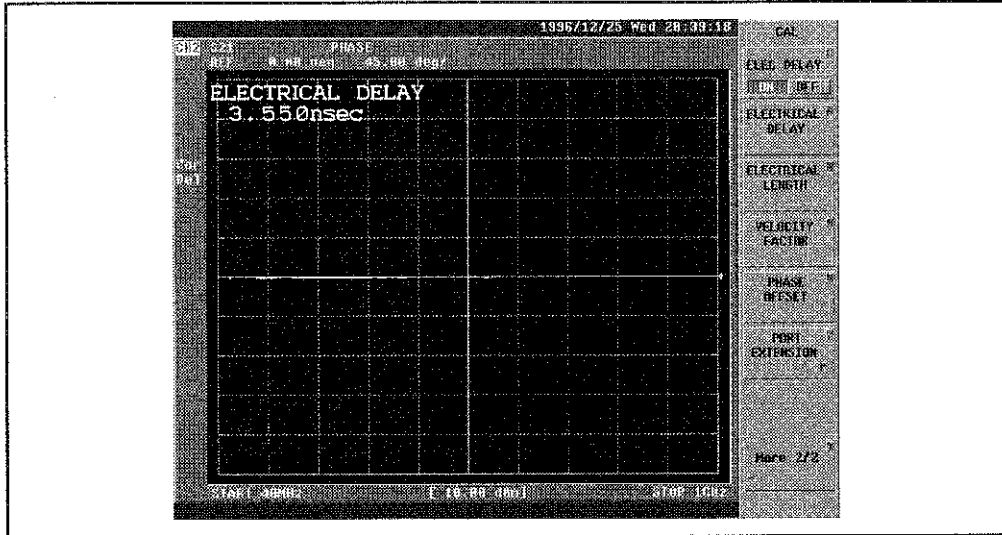

Figure 5-34 Measurement of Electrical Length

5.7 High-speed Measurement Using the Program Sweep Function

Here explains about the program sweeping function that can execute sweeping according to the list of already specified sweeping segment.

This function is useful to shorten measurement time or to improve dynamic range.

- 880MHz band-pass filter is used as DUT.
 - ① Setup (filter connection) (refer to sub-section 3.5.1) and preset (refer to sub-section 4.4.1).
Press **[CH 2]** to set the active channel to 2.
 - ② Set start-frequency and stop-frequency.
[CENTER] → **[8]** → **[8]** → **[0]** → **[MHz]**
[SPAN] → **[2]** → **[0]** → **[0]** → **[MHz]**
 - ③ Set the measurement format to magnitude (log display).
[FORMAT] → **{LOG MAG}**

Calibration is performed following the completion of program sweeping edition.
The display on the screen is as follows.

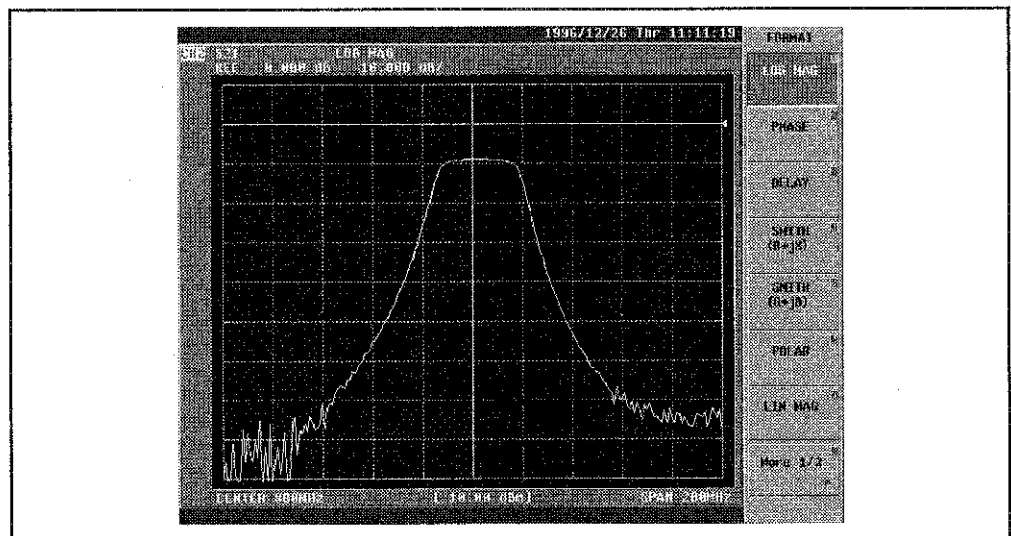

Figure 5-35 Linear Sweeping

- Next, enlarge and measure the specified bandwidth about this filter by using program sweep.

5.7 High-speed Measurement Using the Program Sweep Function

Here, divide the pass-band into the following three segments to enlarge and measure.

SEG.	START	STOP	POINT
0	800MHz	840MHz	50
1	865MHz	900MHz	50
2	920MHz	960MHz	50

Each sweep segment (SEG.) is independent so that different sweeping point number, power level value and IF bandwidth value can be setup.

Program sweep function allows to sweep up to all sweeping point 1201 at a time and connect up to 30 kinds of these segment sweep settings (SEG.NUMBER 0 to 29).

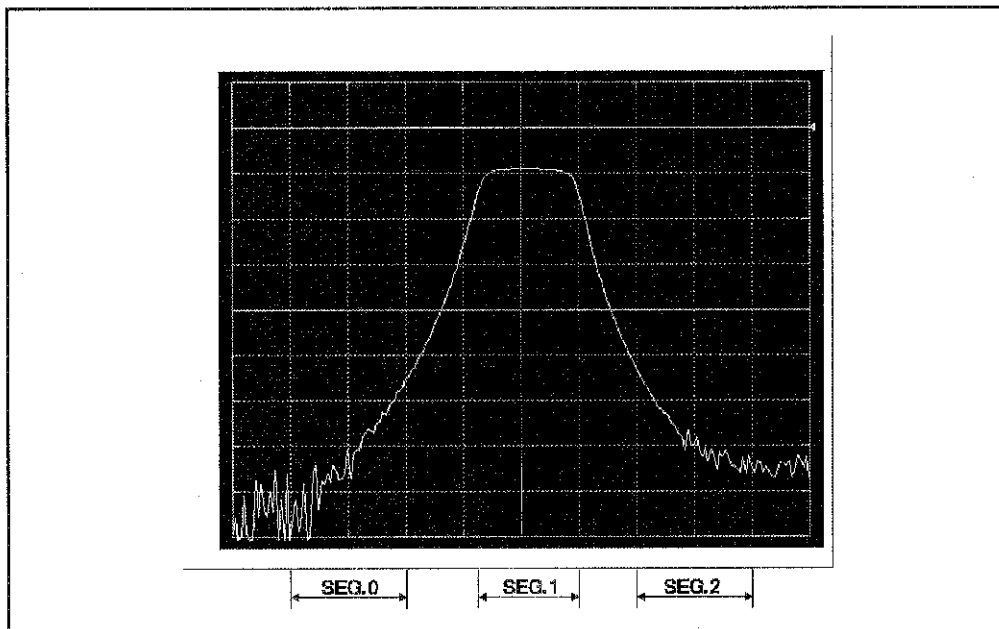

Figure 5-36 Setting of Program Sweeping

- ④ Edit each setup value of the program sweep.
For the divided three segments, setup the data in 0, 1 and 2 segments.

```
[MENU] → {SWEEP TYPE [ ]} → {EDIT PROG SWEEP}
      {SEGMENT NUMBER} → [0] → [X1]
      {START} → [8] → [0] → [0] → [MHz]
      {STOP} → [8] → [4] → [0] → [MHz]
      {POINT} → [5] → [0] → [X1]
```

5.7 High-speed Measurement Using the Program Sweep Function

{SEGMENT NUMBER} → [1] → [X1]
 {START} → [8] → [6] → [5] → [MHz]
 {STOP} → [9] → [0] → [0] → [MHz]
 {POINT} → [5] → [0] → [X1]

{SEGMENT NUMBER} → [2] → [X1]
 {START} → [9] → [0] → [2] → [MHz]
 {STOP} → [9] → [6] → [0] → [MHz]
 {POINT} → [5] → [0] → [X1]

- ⑤ Set the sweep type to the program sweep.
 Press {Return} → {PROGRAM SWEEP}.
- ⑥ Calibrate frequency characteristic.
 Remove DUT and connect the through adapter instead.
 Normalize in this state.
[CAL] → {NORMALIZE (THRU)}
 Following the completion, return the connection to DUT (filter).
 The display on the screen is as follows.

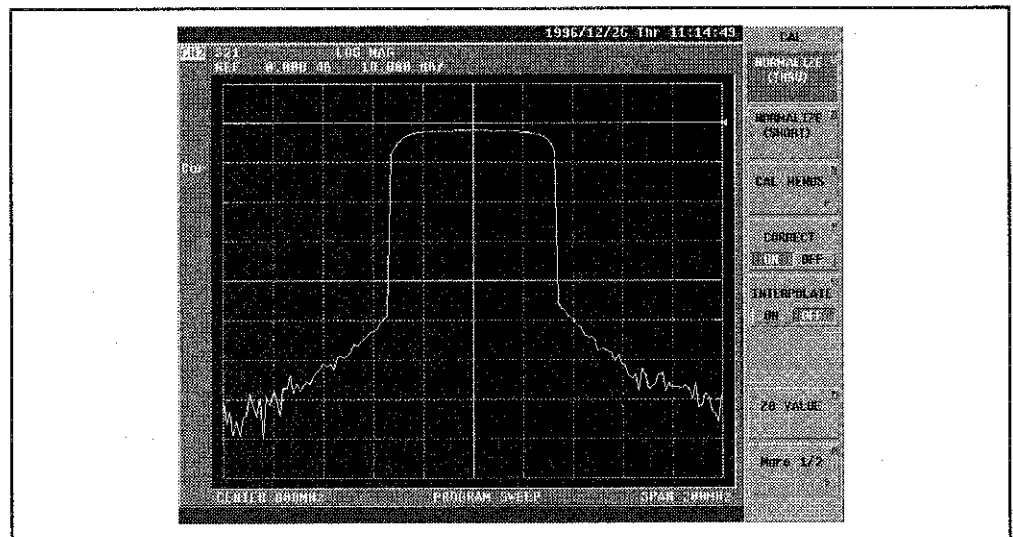

Figure 5-37 Execution of the Program Sweep

5.7 High-speed Measurement Using the Program Sweep Function

- ⑦ In the program sweep, the power level value and IF bandwidth value can be set in each segment.

Therefore the measurement is possible to improve the analyzer's dynamic range.

Set IF bandwidth of segment 0 to 1kHz and power level of segment 1 to +5.0dBm, here.

[MENU] → {SWEEP TYPE []} → {EDIT PROG SWEEP}

{SEGMENT NUMBER} → [0] → [X1]

{More 1/2}

{IF RBW} → [1] → [kHz]

{More 2/2}

{SEGMENT NUMBER} → [1] → [X1]

{More 1/2}

{SEGMENT POWER} → [5] → [.] → [0] → [X1]

{Return}

{PROGRAM SWEEP}

The display on the screen is as follows.

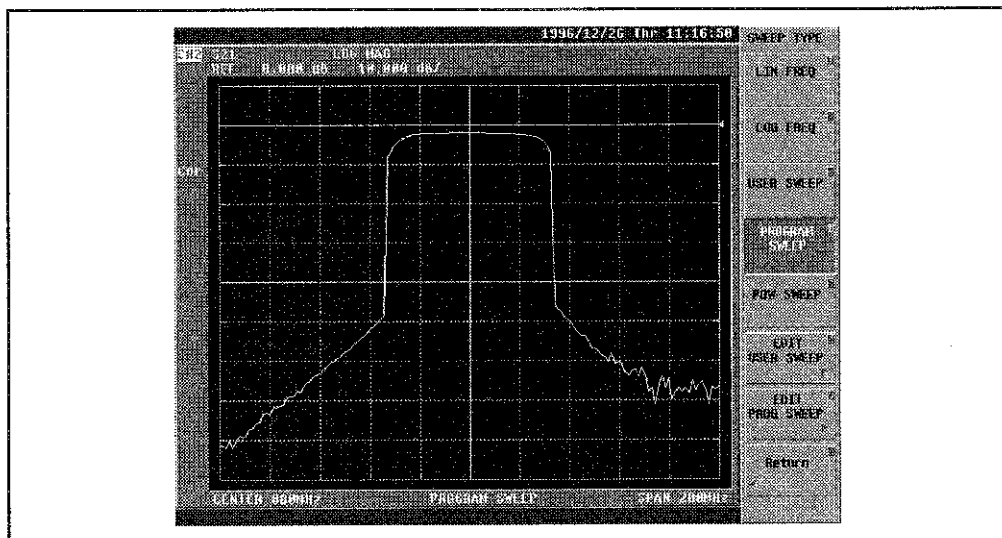

Figure 5-38 Change of the Program Sweep

5.8 GO/NG Measurement Using Limit Line Function

GO/NG of DUT can be judged by using the limit line function of the R3765/3767H series.

Besides the judgement of magnitude, GO/NG of Smith chart and Polar coordinates display can be judged.

- The following shows an example of how the limit line of 880MHz band-pass filter is generated.

Setting procedure

- Setup (filter connection) (refer to sub-section 3.5.1) and preset (refer to sub-section 4.4.1).

Press **[CH 2]** to set the active channel to 2.

- Setup start-frequency and stop-frequency.

[CENTER] → **[8]** → **[8]** → **[0]** → **[MHz]**

[SPAN] → **[1]** → **[0]** → **[0]** → **[MHz]**

- Calibrate the frequency characteristic.

Remove DUT and connect the through adapter instead.

Normalize in this state.

Following the completion of **[CAL]** → **{NORMALIZE (THRU)}**, return the connection to DUT.

- Set the measurement format to magnitude (log display).

The display on the screen is as follows.

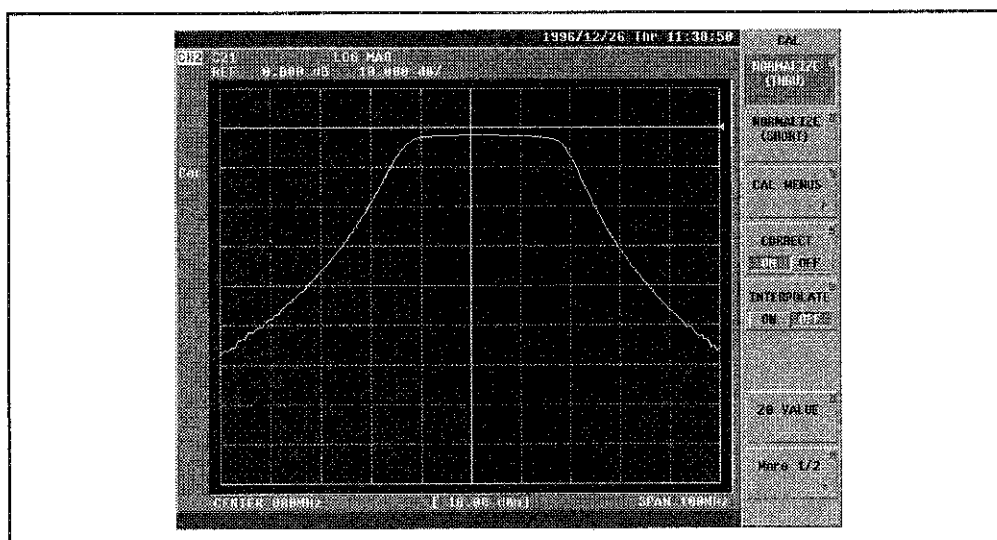

Figure 5-39 Screen before Execution of Limit Line Measurement

5.8 GO/NG Measurement Using Limit Line Function

⑤ Set limit line.

Limit line is set the upper limit value and the lower limit line for each segment. The segment can be setup to 31 pcs.(0 to 30)

Here generates the limit line of the following table.

SEGMENT No.	0	1	2	3	4
Stimulus value	830MHz	840MHz	865MHz	900MHz	920MHz
Upper limit value	-40dB	-40dB	0dB	0dB	-40dB
Lower limit value	-65dB	-65dB	-20dB	-20dB	-65dB

The following figure shows the limit line to set.

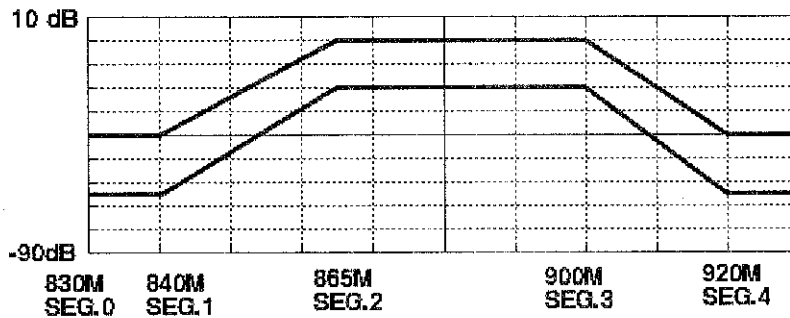

Figure 5-40 Setting of the Limit Line

- Establish the edit mode.

[SYSTEM] → {LIMIT MENU} → {EDIT LIMIT LINE}

The display on the screen is as follows.

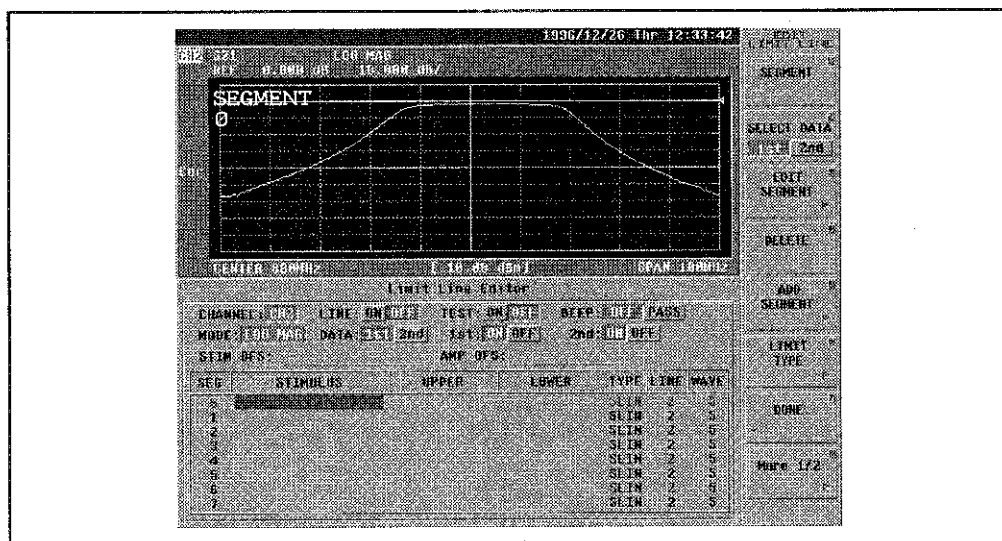

Figure 5-41 Limit Line Editing

- Set each segment.

Setting of segment 0.

SEGMENT 0 : {EDIT SEGMENT}
 {STIMULUS VALUE} → [8] → [3] → [0] → [MHz]
 {UPPER LIMIT} → [-] → [4] → [0] → [X1]
 {LOWER LIMIT} → [-] → [6] → [5] → [X1]
 {Return}

As the marker can be used with data knob, etc. now, it's useful to confirm the setting value of each segment.

The display on the screen is as follows.

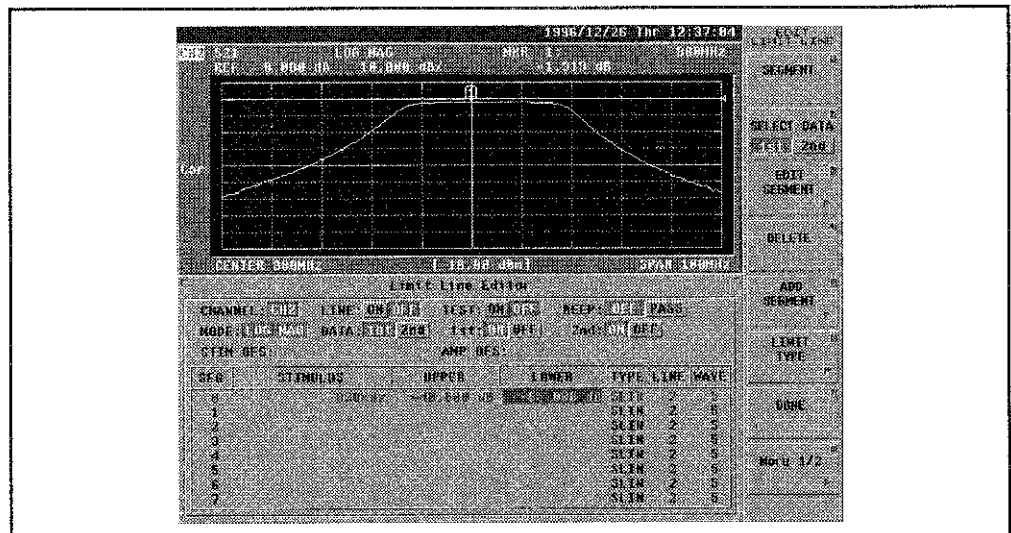

Figure 5-42 Setting of Segment 0

Set segment 1, segment 2, segment 3 and segment 4 in the same way.

SEGMENT 1 : {ADD SEGMENT}
 {STIMULUS VALUE} → [8] → [4] → [0] → [MHz]
 {UPPER LIMIT} → [-] → [4] → [0] → [X1]
 {LOWER LIMIT} → [-] → [6] → [5] → [X1]
 {Return}

SEGMENT 2 : {ADD SEGMENT}
 {STIMULUS VALUE} → [8] → [6] → [5] → [MHz]
 {UPPER LIMIT} → [0] → [X1]
 {LOWER LIMIT} → [-] → [2] → [0] → [X1]
 {Return}

5.8 GO/NG Measurement Using Limit Line Function

SEGMENT 3 : {ADD SEGMENT}
 {STIMULUS VALUE} → [9] → [0] → [0] → [MHz]
 {UPPER LIMIT} → [0] → [X1]
 {LOWER LIMIT} → [-] → [2] → [0] → [X1]
 {Return}

SEGMENT 4 : {ADD SEGMENT}
 {STIMULUS VALUE} → [9] → [2] → [0] → [MHz]
 {UPPER LIMIT} → [-] → [4] → [0] → [X1]
 {LOWER LIMIT} → [-] → [6] → [5] → [X1]
 {Return}

The display on the screen is as follows.

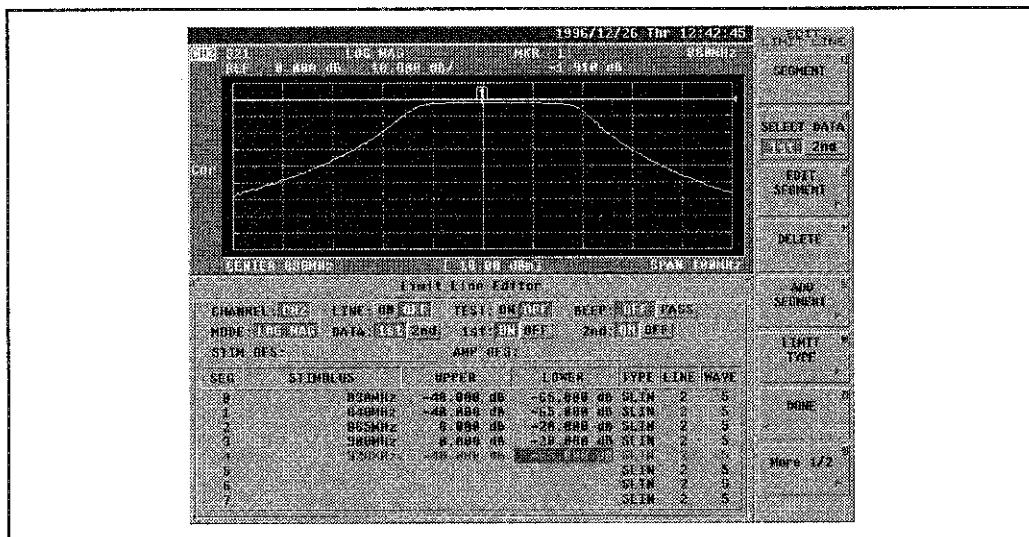

Figure 5-43 Setting of Each Segment

- Select a display type of limit line from the following 3 types for each segment.
 - [1] SLOPING LINE (SLIN) : Links to the next segment with a straight-line.
 - [2] FLAT LINE (FLIN) : Links to the next segment with horizontal lines.
 - [3] SINGLE POINT (SPO) : Shows each segment with a point.

In the above example, the type is not set as it's linked with SLOPING LINE of default.

For example, if you want to set FLAT LINE, operate as follows when the menu returned to the edit menu.

{LINE TYPE} → {FLAT LINE}

Returns to the edit menu of limit line.

{Return}

- ⑥ Define the setting of limit line and return to the edit menu.

{DONE}

- ⑦ Switch ON the GO/NG judgement.

{LIMIT TEST ON/OFF}

- ⑧ Switch ON the limit line.

{LIMIT LINE ON/OFF}

The display on the screen is as follows.

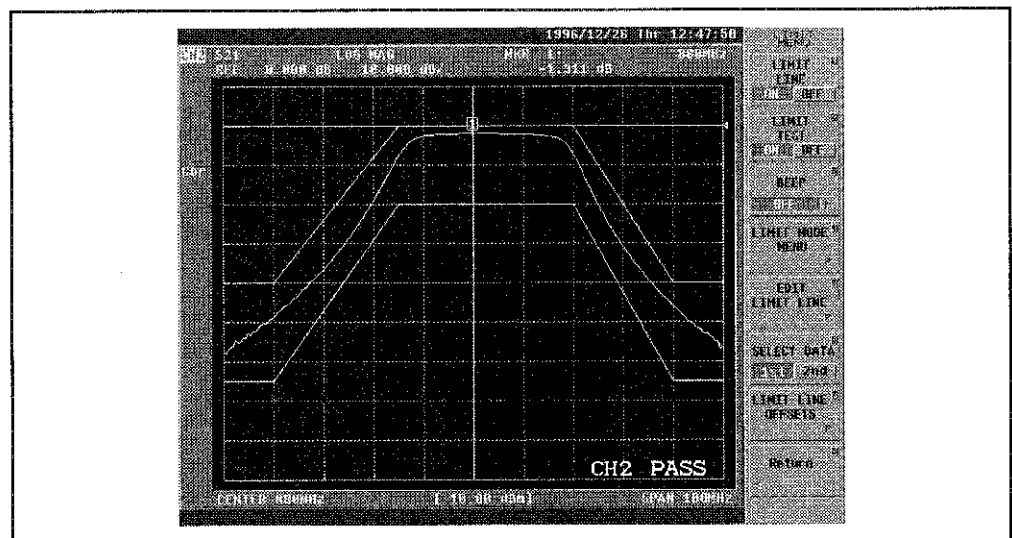

Figure 5-44 Execution of Limit Test

- ⑨ Change the lower limit values of segment 2 and segment 3 to -20dB.

{EDIT LIMIT LINE}

{SEGMENT} → [2] → [X1] → {EDIT SEGMENT}

{LOWER LIMIT} → [-] → [1] → [5] → [X1]

{Return}

{SEGMENT} → [3] → [X1] → {EDIT SEGMENT}

{LOWER LIMIT} → [-] → [1] → [5] → [X1]

{Return}

{DONE}

5.8 GO/NG Measurement Using Limit Line Function

The display on the screen is as follows.

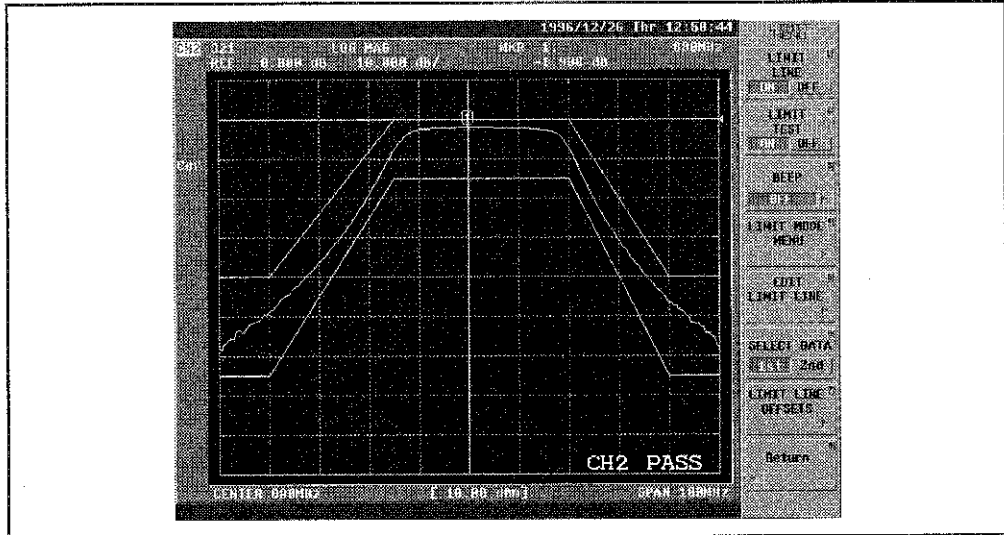

Figure 5-45 Change of Limit Line

6 RECORD and OUTPUT

This chapter describes how to output the measurement data to the plotter, how to save it into the floppy disk and how to recall it.

6.1 Output of Measured Data to the Plotter

Here explains how to output the measurement data to the plotter.

- It's assumed that the plotter is set in HP mode and the address is set to 5.
 - ① Display the markers, etc. and set the measurement screen to plot.
 - ② In order to use the plotter, set the R3765/3767H series to SYSTEM CONTROLLER.
[LCL] → {SYSTEM CONTROLLER}
 - ③ Set GPIB address of the plotter to the R3765/3767H series.
{SET ADDRESS} → {ADDRESS PLOTTER} → [5] → [X1]

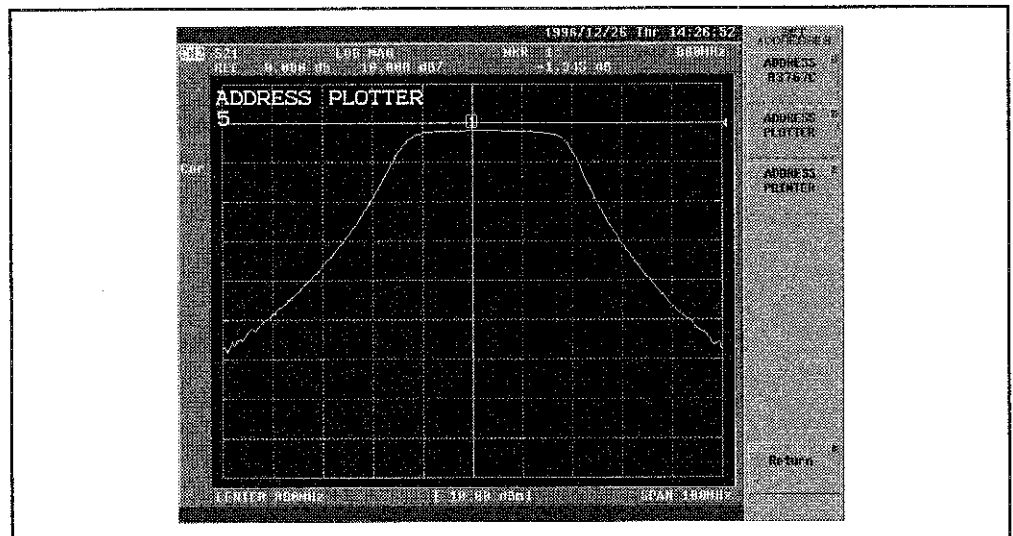

Figure 6-1 Setting of Plotter GPIB Address

- ④ Select the mode of the plotter.
The plotter is initial-set in HP mode.
Set the plotter of the R3765/3767H series to HP mode too.
[COPY] → {PRINT/PLOT SETUPS}
{DEFAULT SETUPS}
{PLOTTER HP/AT} Select HP.
{Return}

6.1 Output of Measured Data to the Plotter

- ⑤ Select the data to output to the plotter.

The following is set here.

- Output measurement data, coordinates data, text data, marker data, reference data.
- Memory data is not output.

All initial values are set to "ON" (output).

Only memory data is set to "OFF" (not output).

{DEFINE PLOT}

{PLOT MEMORY ON/OFF} Switch OFF.

Above operation displays the screen as shown in Figure 6-2.

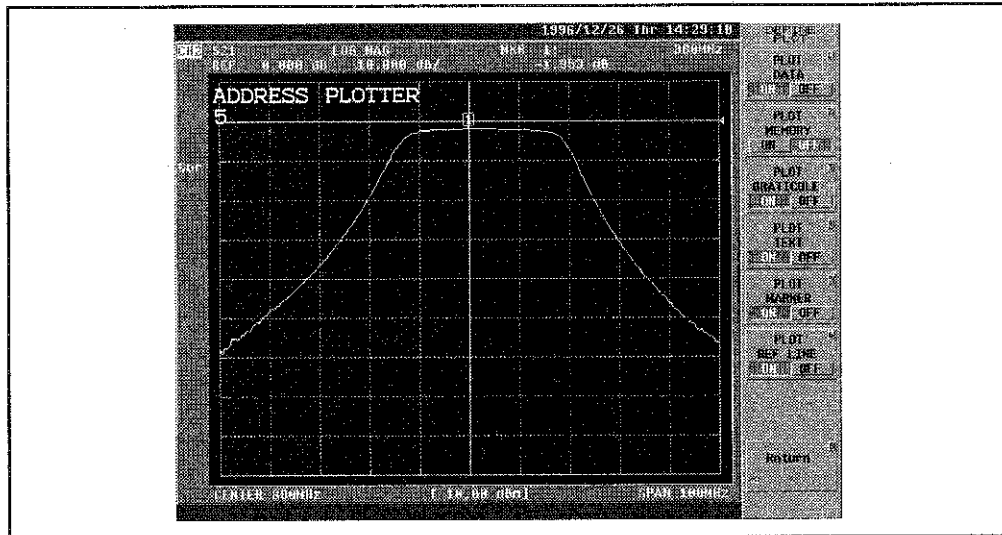

Figure 6-2 Change of Plotter Initial Setup Value (Initial Value)

- ⑥ Start the output to the plotter.

{Return} → {PLOT}

6.1 Output of Measured Data to the Plotter

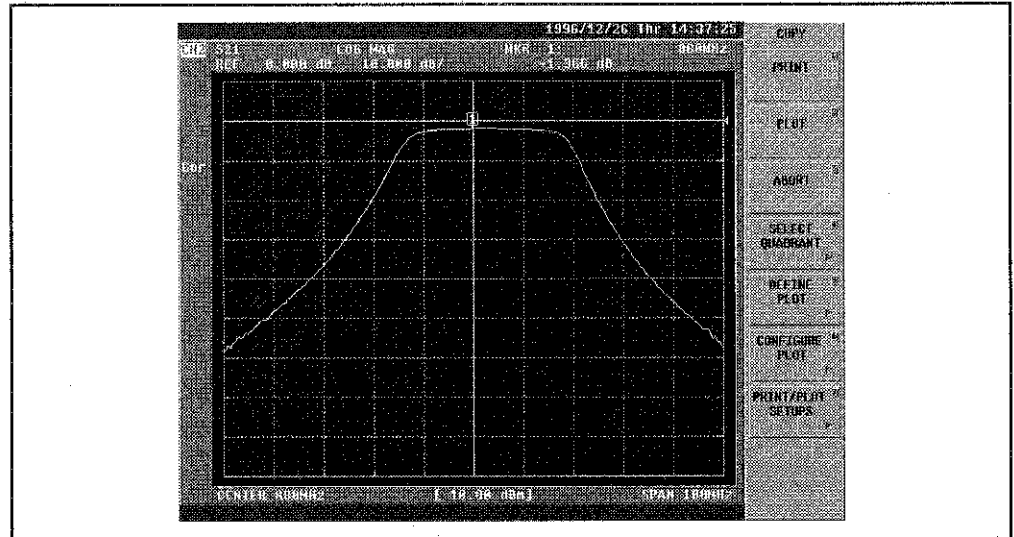

Figure 6-3 Output Data to the Plotter

⑦ The output result of the plotter is as follows.

Note : HP plotter sometimes makes error display such as the error lamp lights with normal plotting.

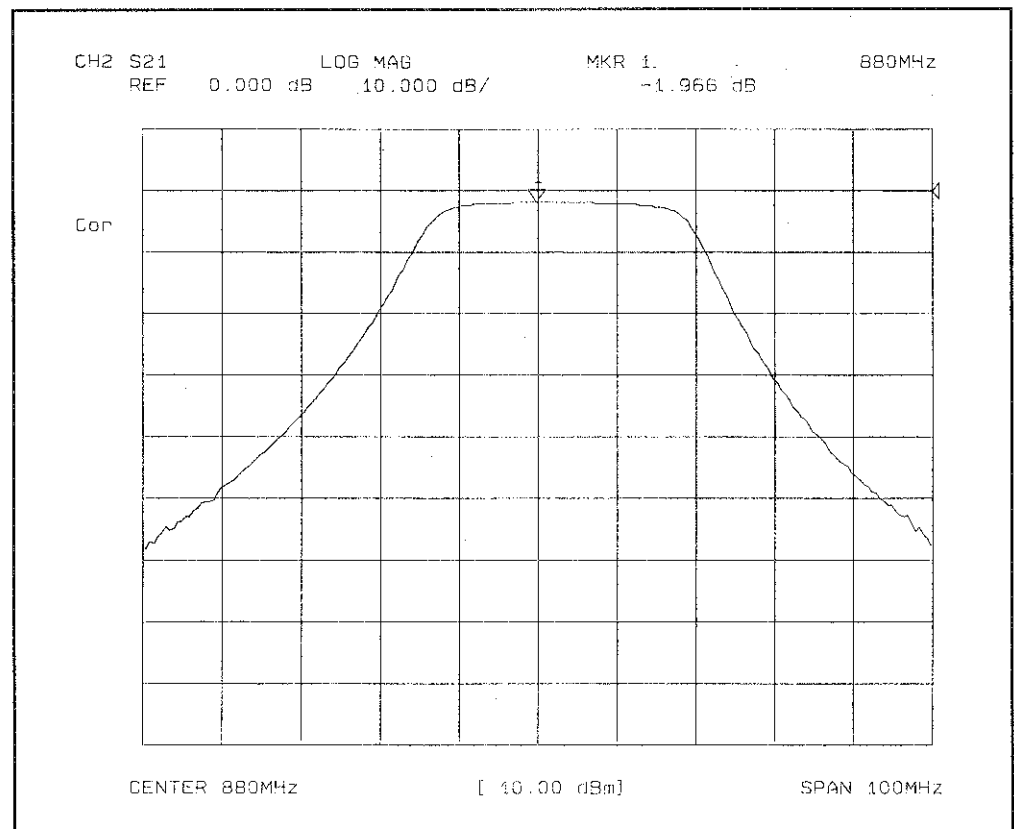

Figure 6-4 Output Result of the Plotter

6.2 Using the Save/Recall Register

6.2 Using the Save/Recall Register

Here describes how to save/recall the setting of the measurement to the save/recall-register.

(1) Saving into the save-register

- ① Set the measurement screen to save by displaying the markers, etc.
- ② Save the setting in the save-register.

[SAVE] → {SAVE REGISTER} → {SAVE REG-1}

By the above operation, the display on the screen changes as follows.

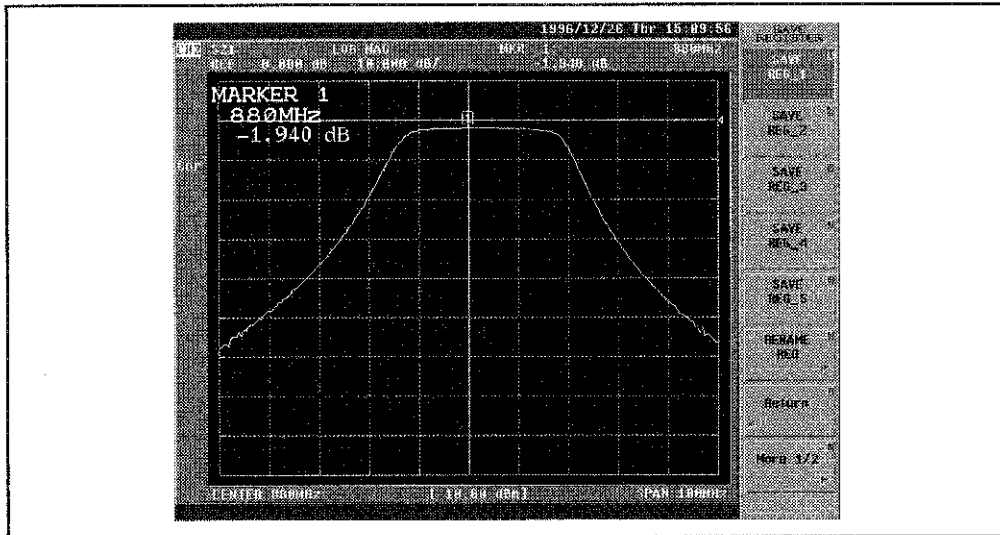

Figure 6-5 Saving into the Save-Register

(2) Recalling from the recall-register

- ① Execute the preset and initialize the setting of the R3765/3767H series.

[PRESET]

- ② Recall the setting by the recall-register.

[RECALL] → {RECALL REG-1}

By the above operation, the display on the screen changes as follows.

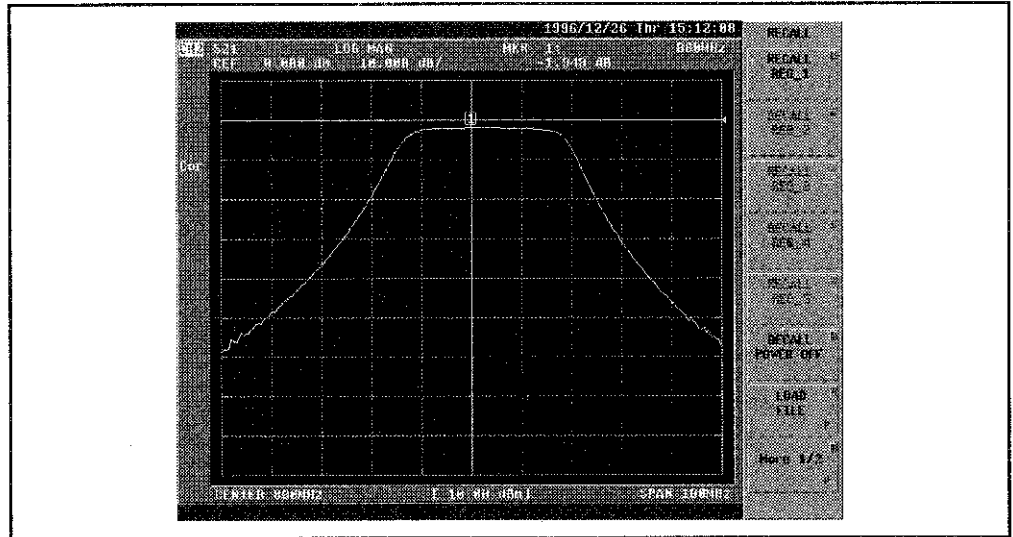

Figure 6-6 Recalling from the Recall-register

CAUTION!

1. When the saving is performed to the save-register, the setting and the calibration data are saved in C drive (RAM disk, with backed up), and the memory trace data is saved in B drive (RAM disk, without backed up).
Therefore, the memory trace data is cleared at power source OFF.
2. In order to save the memory trace data, use the store file function for saving to the floppy disk in the section 6.3. Refer to section 7.11 for details.

6.3 Saving to the Floppy Disk

6.3 Saving to the Floppy Disk

Here describes how to save/recall the setting of the measurement using the store/load-file. In the store/load-file, the data is stored in the floppy disk inserted in A drive.

CAUTION!

1. *Have a formatted floppy disk ready.*
2. *The usable disks are DD720KB, HD1.2MB, HD1.44MB.*

(1) Formatting procedure of floppy disk

- ① Insert floppy disk into floppy disk drive.

Format types in the initial state are ;

DD 720KB

HD 1.2MB (8 SECTORS)

- ② Format.

[SAVE] → {*FORMAT DISK*} → {*OK?*}

(2) Saving to the floppy disk

- ① Display markers, etc. and set the measurement screen to save.

- ② Insert the formatted floppy disk into A drive and select the store file menu.

After floppy disk inserted,

[SAVE] → {*STORE FILE*}

Now the file list window is displayed.

- ③ Select a data to store.

The setting conditions, raw data before formatted and calibration data are stored here.

{*DEFINE STORE*}

{*STATE ON/OFF*}

{*RAW ARRAY ON/OFF*}

{*CORR COEF ON/OFF*}

{*Return*}

Switch ON.

When the calibration was performed, switches ON automatically.

- ④ Set a name to a file before saving the data to retrieve easily.

If it's saved under the default file name, see step ⑤.

{*EDIT NAME*}

{*CLEAR NAME*}

- ⑤ The file name is saved as "TEST".
 - (a) Put the cursor on the "T" with the data knob or [↑] [↓], and press [X1].
 - (b) Put the cursor on the "E" with the data knob or [↑] [↓], and press [X1].
 - (c) Put the cursor on the "S" with the data knob or [↑] [↓], and press [X1].
 - (d) Put the cursor on the "T" with the data knob or [↑] [↓], and press [X1].

By the above operation, the display on the screen becomes as follows.

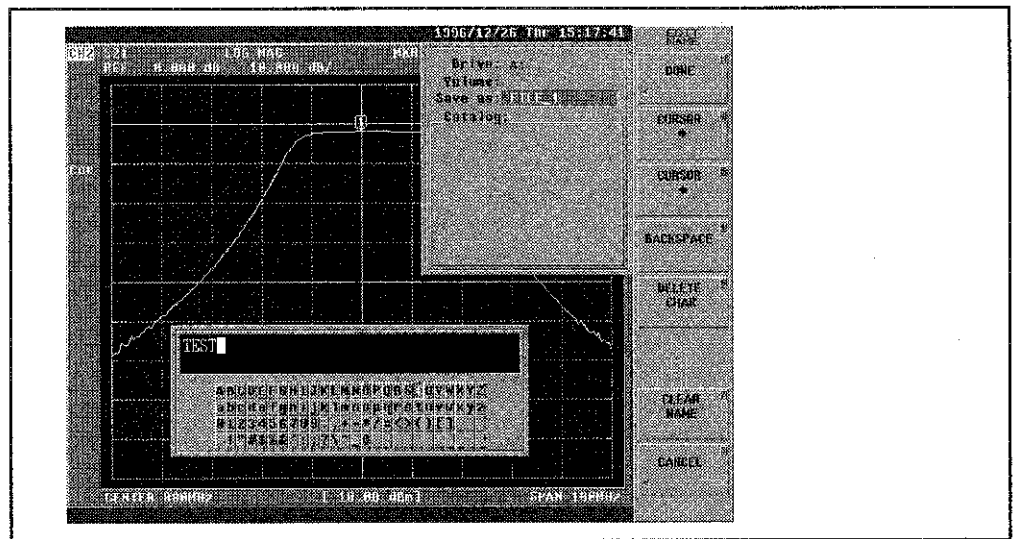

Figure 6-7 Saving to the Floppy Disk

File name is defined with {DONE}.

- ⑥ Save.

{STORE}

With the above operation, the data saving is completed.

- (3) Recall from floppy disk

- ① Execute the preset and initialize the setting of the R3765/3767H series.

[PRESET]

- ② Recall the saved data from the file.

[RECALL] → {LOAD FILE}

Now the file list window is displayed.

- ③ Select the file name to recall from the file list (refer to Figure 7-5), and execute the recall of data.

Put the cursor on the file to recall with {CURSOR↑} and {CURSOR↓}.

6.3 Saving to the Floppy Disk

By {LOAD} the display on the screen becomes as follows.

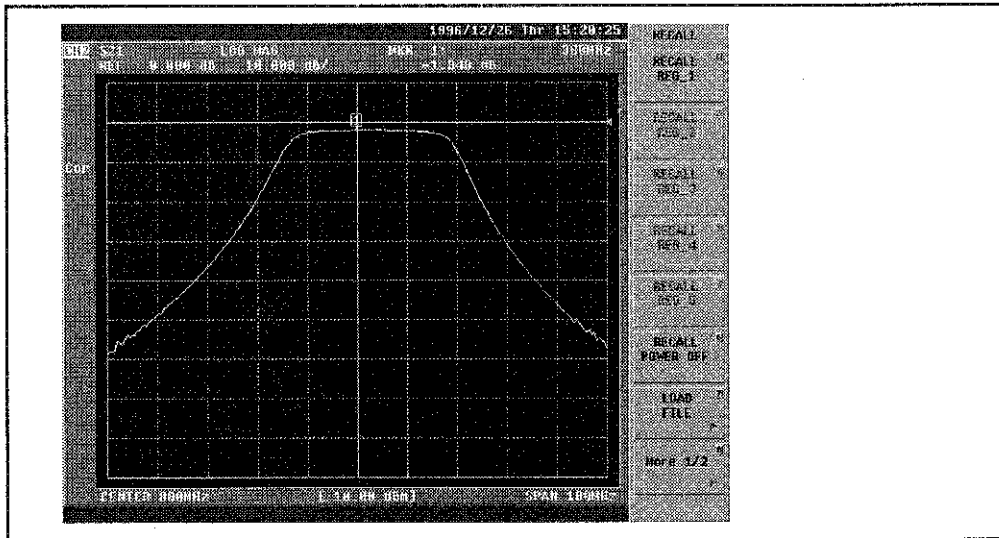

Figure 6-8 Recall from Floppy Disk

After the completion of the recall, the sweep is in the held state automatically.

6.3.1 About the Measurement Data to Save

There are three kinds in the measurement data to save.

- (1) RAW ARRAY (Raw data)
- (2) FORMAT ARRAY (Format data)
- (3) MEM ARRAY (Memory data)

Now (1) RAW ARRAY and (2) DATA ARRAY save the display data.

The difference between the two data is as follows.

- RAW ARRAY saves the data before the error correction, the trace computation, etc. processed.
- DATA ARRAY saves the displayed data itself.

For example, when the saved data is recalled by RAW ARRAY, the right value when saved can be displayed even if the measurement format is changed.

In DATA ARRAY, if the displayed format when saved is of LOG MAG setting, the right value is displayed only with LOG MAG format at the data recalling.

Refer to Figure 9-1 for the flow of three data.

7 FUNCTION DESCRIPTIONS

This chapter describes about the function of each section in details to promote better understanding.

Please make use of "A.4 Soft Key Menu List" at the end of this manual.

7.1 ACTIVE CHANNEL Block

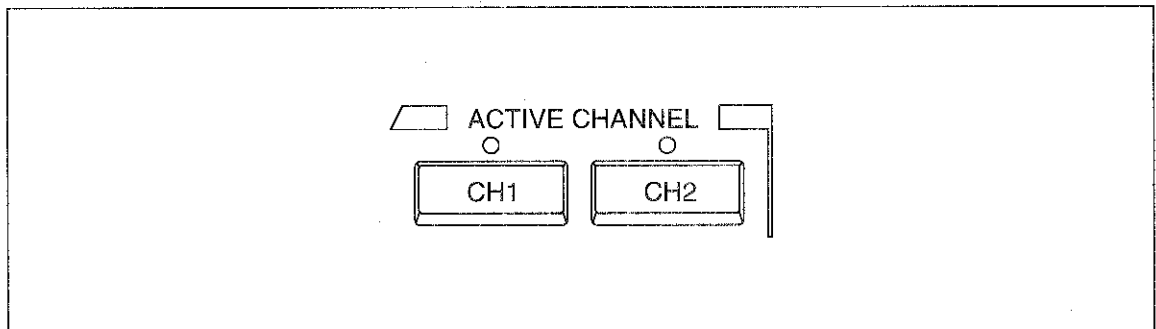

ACTIVE CHANNEL block is used to select which channel will be used for the active channel.

The R3765/3767H series has two measurement channels which can be independently used for measurement and data display.

The R3765/3767H series can perform the simultaneous measurement for reflection and transfer characteristics of DUT or the simultaneous measurement under different frequency conditions.

- (1) The active channel is the channel for which various conditions can be set such as measurement or data display.

That is, all the channel-dependent functions will apply to the active channel.
The channel with its LED lit up is the current active channel.

- (2) Each channel has the sub-measure screen.

The display on the sub-measure screen is displayed by setting input port under the conditions of the sub-measure ON in each channel. (Refer to sub-section 7.4.1 for sub-measure screen selection.)

- For example, when the current channel 1 is active, repressing channel 1 makes the sub-measure screen (channel 3) of channel 1 to active. Pressing channel 1 once more returns to channel 1.
- Channel 3 and channel 4 are only sub-measurement screens which are not independent. Therefore channel 1 is necessary for channel 3 display, and also channel 2 is necessary for channel 4 display.
- The sub-measure screen of channel 1 is channel 3, and the sub-measure screen of channel 2 is channel 4.

7.1 ACTIVE CHANNEL Block

- In order to make the sub-measure screen active, press the channel key again.

[CH 1] : Sets channel 1 or channel 3 to active.

[CH 2] : Sets channel 2 or channel 4 to active.

The setting of the signal source can be interlocked between the channels.

In the case, the conditions which has been set in the active channel will be also set in the other channel automatically. (Refer to sub-section 7.3.2.)

Note: *The expression of 2 channels or channels designates channel 1 and channel 2.
Also there are some cases that channel 3 and channel 4 are expressed as sub-measure screens.*

7.2 ENTRY Block

(2) Unit key

- The suffix for basic units of “Hz”, “deg” and “Ω” is commonly supported by the following unit keys.

[GHz] n : Giga (10^9)

[MHz] μ : Mega (10^6)

[kHz] m : Kilo (10^3)

[X1] : X1 (10^0)

- The suffix for basic units of “sec” and “m” or for real values without unit is commonly supported by the following unit keys.

[GHz] n : Nano (10^{-9})

[MHz] μ : Micro (10^{-6})

[kHz] m : Milli (10^{-3})

[X1] : X1 (10^0)

If a basic unit other than the above is used, its suffix is not supported.

(3) ENTRY OFF key

The ENTRY OFF key is a toggle switch. When data entry is displayed, if the ENTRY OFF key is pressed, the current data entry is canceled.

If the ENTRY OFF key is pressed again, the data entry is displayed.

Once the PRESET key is pressed or the data entry is canceled by the R3765/3767H series itself, the ENTRY OFF key can not make the data entry displayed again.

(4) Step key : [↑] & [↓]

Increases or decreases the setting value with the specific step size. After the step key operation, no unit setting is required.

(5) Data knob :

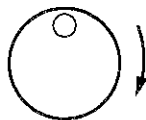

Continuously makes the setting value variable.

After the data knob operation, no unit setting is required.

7.3 STIMULUS Block

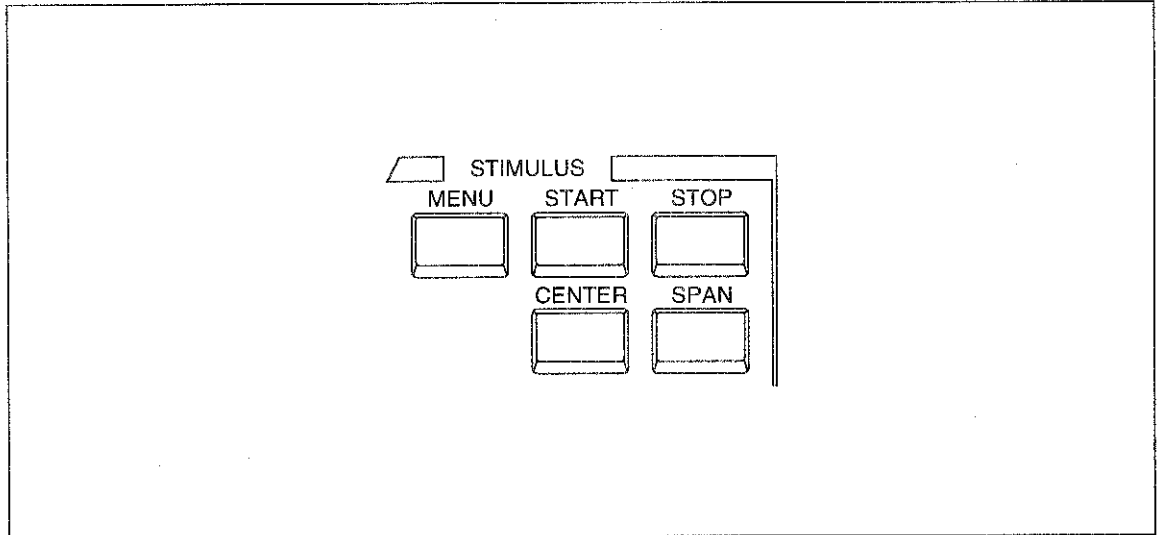

This block is used to set the conditions concerning the signal sources such as a frequency range, power level setting, sweep type, sweep time and sweep resolution.

- Setup key

- [MENU]** : Calls the signal source menu to be set such as an output level, sweep time, sweep type and sweep resolution. (Refer to sub-section 7.3.1.)
- [START]** : Specifies the sweep start.
Sets each start frequency or start power when the sweep type is a frequency type or power type.
The start position on the time axis is set, when the time domain display is ON.
- [STOP]** : Specifies sweep stop.
Sets each stop frequency or power when the sweep type is a frequency type or power type.
The stop position on the time axis is set, when the time domain display is ON.
- [CENTER]** : Specifies the center sweep.
Set center frequency when the sweep type is a frequency type.
The center position on the time axis is set, when the time domain display is ON.
- [SPAN]** : Specifies the sweep span.
Set frequency span when the sweep type is a frequency type.

- Set the sweep range by pressing the **[START]**, **[STOP]**, **[CENTER]** or **[SPAN]**.
- For the other settings, press the **[MENU]** to call the signal source menu, then perform the setting.

7.3.1 Setting Signal Source

The Setting and the Explanation

- ① Press the **[MENU]** to call the signal source menu. (Refer to section A4.)
- ② Signal source menu
 - {POWER}* : Calls the power menu used for selecting an output power and an output port. (See step ③.)
 - {SWEEP TIME}* : Sets the sweep time.
When a zero is set, AUTO is selected.
When AUTO is set, the minimum sweep time is set according to the sweep frequency range and receiver section resolution bandwidth.
 - {SWEEP TYPE []}* : Calls the sweep type menu for selecting a sweep type. (Refer to section 7.7.)
 - {TRIGGER []}* : Calls the trigger menu for selecting a sweep trigger condition. (See step ④.)
 - {POINTS}* : Sets the number of sweep point. The number of settable points are: 3, 6, 11, 21, 51, 101, 201, 301, 401, 601, 601, 801 or 1201 points.
 - {COUPLED CH ON/OFF}* : Selects whether the setting conditions concerning the channels 1 and 2 are same or not. (Refer to sub-section 7.3.2.)
 - {CW FREQ}* : Sets the frequency at power sweep.
 - {RESTART}* : Restarts the measurement from sweep start.
When this key is pressed, the sweep restarts from the start, even if the sweep is uncompleted.
- ③ Power menu
 - {POWER}* : Sets the output level during frequency sweep.
 - {ATTENUATOR PORT 1}* : Sets the PORT 1 attenuator value.
*Option 10 (Output attenuator)
 - {ATTENUATOR PORT 2}* : Sets the PORT 2 attenuator value.
*Option 10 (Output attenuator)

- ④ Trigger menu
- | | |
|------------------------|--|
| <i>{CONTINUOUS}</i> | : Continuously performs sweep. |
| <i>{SINGLE}</i> | : Performs sweep once.
If this key is pressed in the middle of a sweep, the measurement of the sweep is interrupted and a sweep is re-started. |
| <i>{HOLD}</i> | : Stops sweep measurement.
If this key is pressed in the middle of sweep, immediately sweep is interrupted. |
| <i>{INT TRIG}</i> | : Automatically starts sweep by an internal source. |
| <i>{EXT TRIG}</i> | : Starts sweep by an external synchronization signal.
The external synchronization signal is input through the parallel I/O connector 18-pin of the rear panel.
(Negative logic, pulse width ; 1 μ s or more.) |
| <i>{TRIGGER DELAY}</i> | : Sets delay time between receiving the trigger signal and the start of sweep. |

7.3.2 Interlocking between Channels

Selects whether the measurement condition concerning the signal source is set at the same condition or independently set in each channel when two-channel simultaneous measurement.

- (1) For interlock setting :

The conditions which has been set to the active channel will be automatically set to the other channel as same.

- (2) For independent setting :

Different measuring condition can be set to channel 1 and 2, respectively.

The setting conditions which can be interlocked between channels are show below:

- Sweep type
- Frequency
- Output level
- Sweep time
- Number of measurement point
- Resolution bandwidth

7.3 STIMULUS Block

The Setting and the Explanation

- ① Press the **[MENU]** to call the signal source menu. (Refer to section A.4.)
- ② Press the **{COUPLED CH ON/OFF}** to select whether the setting conditions concerning two measurements are set to the same or not.
 - ON : Measures channel 1 and channel 2 simultaneously.
 - OFF : Measures channel 1 and channel 2 alternately. (Performs the measurement of channel 1 and then channel 2.)
- When the sub-measure screen (channel 3 or channel 4) of channel 1 or channel 2 is selected, channel 3 always operates with channel 1 and channel 4 operates with channel 2.
On the display of the sub-measure screen, the input port can be set in the state of sub-measure ON.

7.4 RESPONSE Block

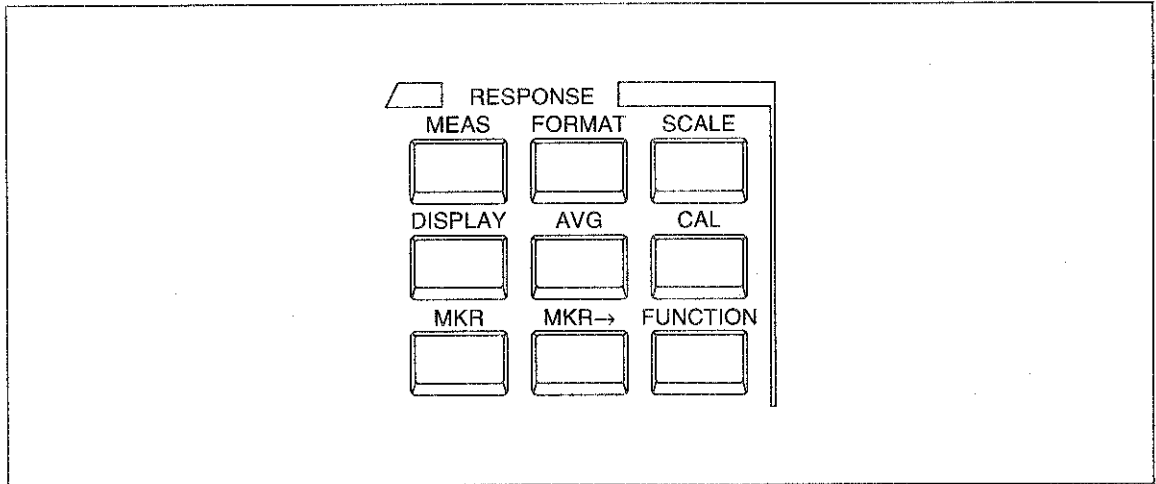

The RESPONSE block is used to set the measurement conditions of receiver section, measurement parameters, measurement format, display format and marker for an active channel.

- [MEAS]** : Calls the measurement menu for selecting an input port and measurement parameters. (Refer to sub-section 7.4.1.)
- [FORMAT]** : Calls the format menu for selecting the format of measurement data. (Refer to sub-section 7.4.2.)
- [SCALE]** : Calls the scale menu for setting the display coordinate axis. (Refer to sub-section 7.4.3.)
- [DISPLAY]** : Calls the display menu for executing 2-channel simultaneous display, trace operation function, and label input. (Refer to sub-section 7.4.4.)
- [AVG]** : Calls the average menu for executing data average, smoothing, resolution bandwidth setting. (Refer to sub-section 7.4.10.)
- [CAL]** : Calls the calibration menu for setting calibration function. (Refer to section 7.5.)
- [MKR]** : Calls the marker menu for setting a marker. (Refer to section 7.6.)
- [MKR →]** : Calls the marker search menu for setting analysis by using a marker. (Refer to sub-section 7.6.7.)
- [FUNCTION]** : Calls the Time domain function (Option 70) and CDMA IF filter analysis function (see sections 7.7 and 7.8).

7.4 RESPONSE Block

7.4.1 Setting Input and Parameter Conversion

Selects the receiver section input port.

With the sub-measure screen, the input port can be set in the condition of sub-measure ON.

The data which is measured in the selected input port is a "complex data". This data is also formatted such as the magnitude, phase, group delay. Data before formatting can be changed to impedance, admittance, reverse S parameter.

The Setting and the Explanation

- ① Press the **[MEAS]** to call the measurement menu. (Refer to section A.4.)
- ② Measurement menu
 - For R3765AH/3767AH+S parameter, R3765CH/3767CH
 - {S11 REFL FWD}* : Sets the input port to S₁₁ REFL FWD.
 - {S21 TRANS FWD}* : Sets the input port to S₂₁ TRANS FWD.
 - {S12 TRANS REV}* : Sets the input port to S₁₂ TRANS REV.
 - {S22 REFL REV}* : Sets the input port to S₂₂ REFL REV.
 - {S11&S21 FWD}* : Sets the input port to S₁₁&S₂₁ FWD.
 - {S22&S12 REV}* : Sets the input port to S₂₂&S₁₂ REV.
 - {SUB MEAS ON/OFF}*: Sets the ON/OFF of sub measurement.
 - {CONVERSION []}* : Calls the parameter menu for converting the measured data to an impedance, admittances or reverse S parameters. (See step ③.)
 - For R3765AH/3767AH
 - {A/R}* : Sets the input port to A/R.
 - {B/R}* : Sets the input port to B/R.
 - {SUB MEAS ON/OFF}* : Sets the sub-measure ON or OFF.
 - {CONVERSION []}* : Calls the parameter converting menu to convert the measured data to impedance or admittance. (See step ③.)
 - For R3765BH/3767BH
 - {REFLECTION}* : Sets the input port to REFLECTION.
 - {TRANSMISSION}* : Sets the input port to TRANSMISSION.
 - {REFL & TRANS}* : Sets the input port to REFL & TRANS.
 - {SUB MEAS ON/OFF}* : Sets the sub-measure ON or OFF.
 - {CONVERSION []}* : Calls the parameter converting menu to convert the measured data to impedance or admittance. (See step ③.)

③ Parameter conversion menu

{Z(REFL)} : Executes the impedance conversion by the reflection measurement.

$$\text{Conversion expression} = \frac{1 + \rho}{1 - \rho} \times Z_0$$

{Z(TRANS)} : Executes the impedance conversion by the transmission measurement.

$$\text{Conversion expression} = \frac{2(1-T)}{T} \times Z_0$$

{Y(REFL)} : Executes the admittance conversion by the reflection measurement.

$$\text{Conversion expression} = \frac{1 - \rho}{1 + \rho} \times \frac{1}{Z_0}$$

{Y(TRANS)} : Executes the admittance conversion by the transmission measurement.

$$\text{Conversion expression} = \frac{T}{2(1-T)} \times \frac{1}{Z_0}$$

{1/S} : Converts the S parameter to the reverse S parameter.

$$\text{Conversion expression} = \frac{1}{S}$$

{OFF} : Turns off the conversion function.

{Z0 VALUE} : Sets the characteristics impedance (Z_0).

Note: ρ : Reflection coefficient

T : Gain

S : Reflection coefficient or gain

Z_0 : Characteristics impedance

7.4 RESPONSE Block

7.4.2 Display Data Format

Formats the measurement data. Data is displayed as the type formatted.

The Setting and the Explanation

- ① Press the **[FORMAT]** to call the format menu. (Refer to section A.4.)
- ② Format menu
 - Format menu (1 of 2)
 - {LOG MAG}* : Sets to the logarithmic magnitude display.
 - {PHASE}* : Sets to the phase display.
The display is changed to the loop back display in $\pm 180^\circ$.
 - {DELAY}* : Sets to the group delay display.
 - {SMITH (R+jX)}* : Sets to the Smith chart.
 - {SMITH (G+jB)}* : Sets to the admittance chart.
 - {POLAR}* : Sets to the polar coordinates display.
 - {LIN MAG}* : Sets to the linear magnitude.
 - Format menu (2 of 2)
 - {SWR}* : Sets to the SWR (standing wave ratio) display.
 - {REAL}* : Sets to the measurement data real display.
 - {IMAG}* : Sets to the measurement data imaginary display.
 - {PHASE $-\infty, +\infty$ }* : Sets to the continuous phase display.
The phase is changed to the no loopback display in $\pm 180^\circ$ based on the one point data.
 - {LOG MAG & PHASE}* : Sets to the simultaneous display with logarithmic magnitude and phase.
 - {LOG MAG & DELAY}* : Sets to the simultaneous display with logarithmic magnitude and group delay.
 - {LIN MAG & PHASE}* : Sets to the simultaneous display with linear magnitude and phase.

7.4.3 Setting Display Coordinate Scale

The coordinate in accordance with selected format is displayed on the screen.

The coordinate scale is changed on the scale menu.

The Setting and the Explanation

- ① Press the **[SCALE]** to call the scale menu. (Refer to section A.4.)
- ② Scale menu

<i>{AUTO SCALE}</i>	: Automatically sets the display coordinate to be an optimize value for display trace.
<i>{/DIV}</i>	: For the rectangular coordinate display, sets the value of the vertical axis 1 scale.
<i>{REF VALUE}</i>	: Sets the reference position value of the display coordinate. * In the cases of Smith chart and Polar display, switches to <i>{FULL SCALE}</i> to setup a full scale value.
<i>{REF POS}</i>	: Specifies the reference position of the display coordinate.
<i>{REF LINE ON/OFF}</i>	: Selects ON/OFF of the reference position display.
<i>{FULL SCALE}</i>	: Sets a full scale value for a smith chart and polar coordinate display.
<i>{TRACE 2nd/1st}</i>	: Selects a preferred trace in displaying two traces simultaneously.

7.4.4 Four Screen Display and Display Selection Information

The 2 channels simultaneous display can be performed.

Each channel has a sub-measure screen display, so that four-screen-display in total can be performed.

Also the selection of the trace data, the coordinate display ON/OFF and the label input can be performed.

The Setting and the Explanation

- ① Press the **[DISPLAY]** to call the display menu. (Refer to section A.4.)
- ② Display menu
 - Display menu (1 of 2)
 - {DUAL CH ON/OFF}** : Selects ON/OFF of the two channels simultaneous display (overlap display). (Note)
 - {SPLIT CH ON/OFF}** : Selects ON/OFF of the display split in two, the upper part and the lower part (split display). (Note)
 - {DISPLAY []}** : Calls the trace data selection menu to select whether measurement data, memory data and both data is displayed. (Refer to sub-section 7.4.6.)
 - {DEFINE TRACE []}** : Calls the trace operation menu.
Four fundamental operations are executed for the measured data and the memory data. (Refer to sub-section 7.4.7.)
 - {DATA → MEMORY}** : Enters data into memory.
When two-trace display has been selected, data toggled by **{TRACE 2nd/1st}** is entered.
 - {CONVERSION []}** : Calls the parameter selection menu to convert the measured data into an impedance or an admittance. (Refer to ③ of sub-section 7.4.1.)
 - {TRACE 2nd/1st}** : Selects between the 1st trace and the 2nd trace.
 - Note : The screen display depends on the sub-measure selection and ON/OFF of SPLIT CH and DUAL CH. (Refer to sub-section 7.4.5.)**
 - Display menu (2 of 2)
 - {GRATICULE ON/OFF}** : Selects ON/OFF of the coordinate display.
 - {LABEL}** : Calls the label menu for entering the label. (Refer to sub-section 7.4.8.)
 - {COLOR}** : Specifies the color of the waveform and the marker. (Refer to sub-section 7.4.9.)
 - {DEFAULT COLOR}** : Sets all color setting to default.

7.4.5 Display Layout

(1) In the case that Channel 1 (CH 1) is in Active.

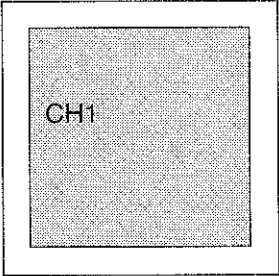
Setting conditions	Layout configuration
ACTIVE CH : CH1 DUAL CH : OFF SPLIT : OFF CH1: SUB MEAS : OFF CH2: SUB MEAS : OFF	

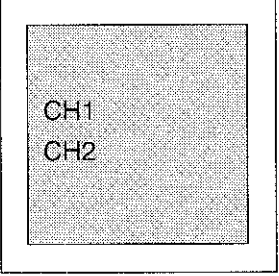
Setting conditions	Layout configuration
ACTIVE CH : CH1 DUAL CH : ON SPLIT : OFF CH1: SUB MEAS : OFF CH2: SUB MEAS : OFF	

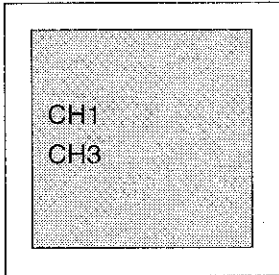
Setting conditions	Layout configuration
ACTIVE CH : CH1 DUAL CH : OFF SPLIT : OFF CH1: SUB MEAS : ON CH2: SUB MEAS : OFF	

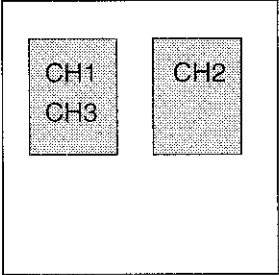
Setting conditions	Layout configuration
ACTIVE CH : CH1 DUAL CH : ON SPLIT : OFF CH1: SUB MEAS : ON CH2: SUB MEAS : OFF	

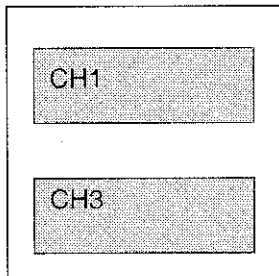
Setting conditions	Layout configuration
ACTIVE CH : CH1 DUAL CH : OFF SPLIT : ON CH1: SUB MEAS : ON CH2: SUB MEAS : OFF	

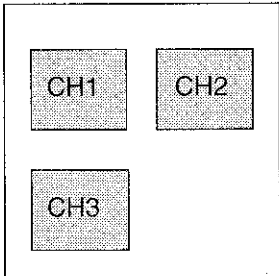
Setting conditions	Layout configuration
ACTIVE CH : CH1 DUAL CH : ON SPLIT : ON CH1: SUB MEAS : ON CH2: SUB MEAS : OFF	

7.4 RESPONSE Block

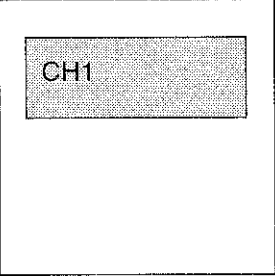
Setting conditions	Layout configuration
ACTIVE CH : CH1 DUAL CH : OFF SPLIT : ON CH1: SUB MEAS : OFF CH2: SUB MEAS : OFF	

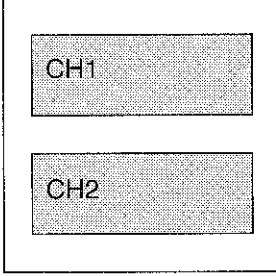
Setting conditions	Layout configuration
ACTIVE CH : CH1 DUAL CH : ON SPLIT : ON CH1: SUB MEAS : OFF CH2: SUB MEAS : OFF	

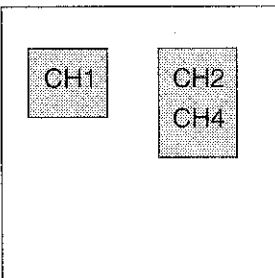
Setting conditions	Layout configuration
ACTIVE CH : CH1 DUAL CH : ON SPLIT : OFF CH1: SUB MEAS : OFF CH2: SUB MEAS : ON	

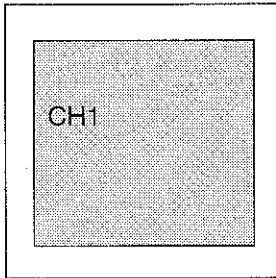
Setting conditions	Layout configuration
ACTIVE CH : CH1 DUAL CH : OFF SPLIT : OFF CH1: SUB MEAS : OFF CH2: SUB MEAS : ON	

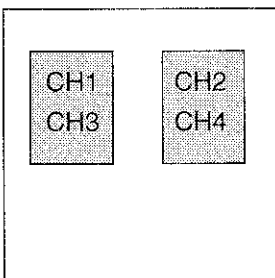
Setting conditions	Layout configuration
ACTIVE CH : CH1 DUAL CH : ON SPLIT : OFF CH1: SUB MEAS : ON CH2: SUB MEAS : ON	

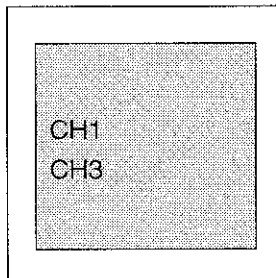
Setting conditions	Layout configuration
ACTIVE CH : CH1 DUAL CH : OFF SPLIT : OFF CH1: SUB MEAS : ON CH2: SUB MEAS : ON	

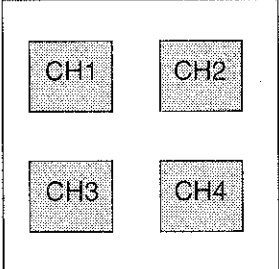
Setting conditions	Layout configuration
ACTIVE CH : CH1 DUAL CH : ON SPLIT : ON CH1: SUB MEAS : ON CH2: SUB MEAS : ON	

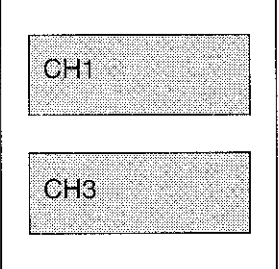
Setting conditions	Layout configuration
ACTIVE CH : CH1 DUAL CH : OFF SPLIT : ON CH1: SUB MEAS : ON CH2: SUB MEAS : ON	

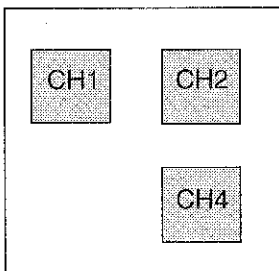
Setting conditions	Layout configuration
ACTIVE CH : CH1 DUAL CH : ON SPLIT : ON CH1: SUB MEAS : OFF CH2: SUB MEAS : ON	

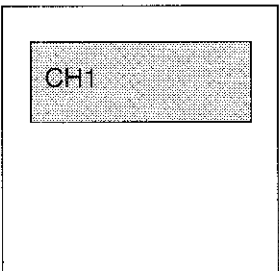
Setting conditions	Layout configuration
ACTIVE CH : CH1 DUAL CH : OFF SPLIT : ON CH1: SUB MEAS : OFF CH2: SUB MEAS : ON	

7.4 RESPONSE Block

(2) In the case that Channel 2 (CH 2) is in Active.

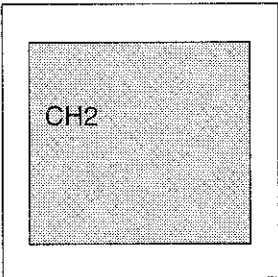
Setting conditions	Layout configuration
ACTIVE CH : CH2 DUAL CH : OFF SPLIT : OFF CH1: SUB MEAS : OFF CH2: SUB MEAS : OFF	

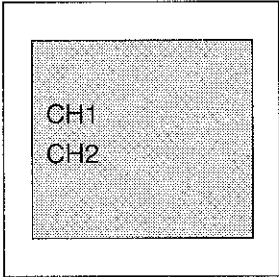
Setting conditions	Layout configuration
ACTIVE CH : CH2 DUAL CH : ON SPLIT : OFF CH1: SUB MEAS : OFF CH2: SUB MEAS : OFF	

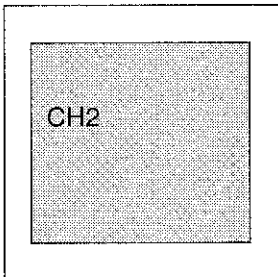
Setting conditions	Layout configuration
ACTIVE CH : CH2 DUAL CH : OFF SPLIT : OFF CH1: SUB MEAS : ON CH2: SUB MEAS : OFF	

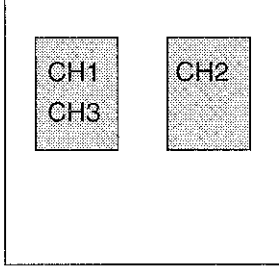
Setting conditions	Layout configuration
ACTIVE CH : CH2 DUAL CH : ON SPLIT : OFF CH1: SUB MEAS : ON CH2: SUB MEAS : OFF	

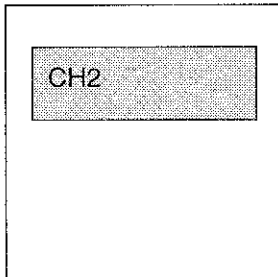
Setting conditions	Layout configuration
ACTIVE CH : CH2 DUAL CH : OFF SPLIT : ON CH1: SUB MEAS : ON CH2: SUB MEAS : OFF	

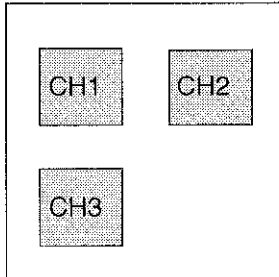
Setting conditions	Layout configuration
ACTIVE CH : CH2 DUAL CH : ON SPLIT : ON CH1: SUB MEAS : ON CH2: SUB MEAS : OFF	

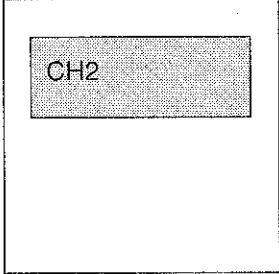
Setting conditions	Layout configuration
ACTIVE CH : CH2 DUAL CH : OFF SPLIT : ON CH1: SUB MEAS : OFF CH2: SUB MEAS : OFF	

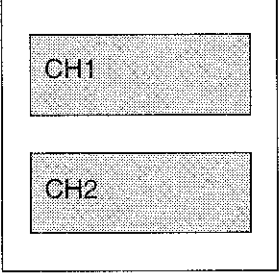
Setting conditions	Layout configuration
ACTIVE CH : CH2 DUAL CH : ON SPLIT : ON CH1: SUB MEAS : OFF CH2: SUB MEAS : OFF	

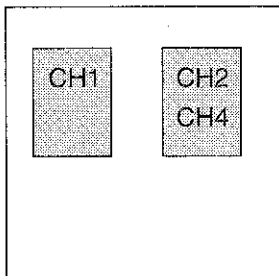
Setting conditions	Layout configuration
ACTIVE CH : CH2 DUAL CH : ON SPLIT : OFF CH1: SUB MEAS : OFF CH2: SUB MEAS : ON	

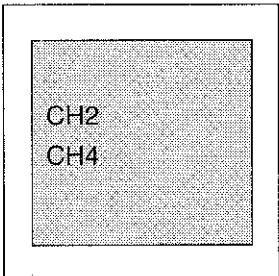
Setting conditions	Layout configuration
ACTIVE CH : CH2 DUAL CH : OFF SPLIT : OFF CH1: SUB MEAS : OFF CH2: SUB MEAS : ON	

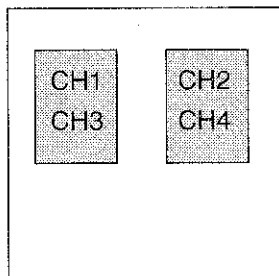
Setting conditions	Layout configuration
ACTIVE CH : CH2 DUAL CH : ON SPLIT : OFF CH1: SUB MEAS : ON CH2: SUB MEAS : ON	

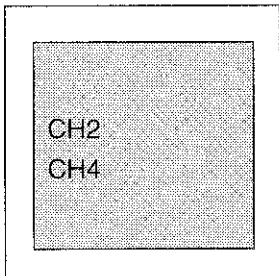
Setting conditions	Layout configuration
ACTIVE CH : CH2 DUAL CH : OFF SPLIT : OFF CH1: SUB MEAS : ON CH2: SUB MEAS : ON	

7.4 RESPONSE Block

Setting conditions	Layout configuration
ACTIVE CH : CH2 DUAL CH : ON SPLIT : ON CH1: SUB MEAS : ON CH2: SUB MEAS : ON	

Setting conditions	Layout configuration
ACTIVE CH : CH2 DUAL CH : OFF SPLIT : ON CH1: SUB MEAS : ON CH2: SUB MEAS : ON	

Setting conditions	Layout configuration
ACTIVE CH : CH2 DUAL CH : ON SPLIT : ON CH1: SUB MEAS : OFF CH2: SUB MEAS : ON	

Setting conditions	Layout configuration
ACTIVE CH : CH2 DUAL CH : OFF SPLIT : ON CH1: SUB MEAS : OFF CH2: SUB MEAS : ON	

7.4.6 Trace Data Selection

The trace data selection menu allows you to select the measured data, the memory data or both data.

The Setting and Explanation

- ① Press the **[DISPLAY]** to call the display menu. (Refer to section A.4.)
- ② Press the **{DISPLAY[]}** to call the trace data selection menu.
- ③ Trace data selection menu
 - {DISPLAY DATA}** : Displays the measured data only.
 - {DISPLAY MEMORY}** : Displays the memory data only.
 - {DISPLAY DATA & MEM}** : Displays both the measured data and the memory data.

7.4.7 TRACE Operation

The trace operation is used to execute fundamental arithmetic operation between the measurement data and memory data.

The Setting and the Explanation

- ① Press the **[DISPLAY]** to call the display menu. (Refer to section A4.)
- ② Press the *{DEFINE TRACE[]}* to call the trace operation.
- ③ Trace operation menu
 - {DATA/MEM}* : Executes the division of measurement data and memory data, then displays the result as the measurement data.
 - {DATA-MEM}* : Executes the subtraction of measurement data and memory data, then displays the result as the measurement data.
 - {DATA*MEM}* : Executes the of multiplication of measurement data and memory data, then displays the result as the measurement data.
 - {DATA+MEM}* : Executes the addition of measurement data and memory data, then displays the result as the measurement data.
 - {OFF}* : Cancels the operation (calculation).

7.4 RESPONSE Block

7.4.8 Label Input

An annotation of measurement data and so on is input as a label. Maximum 64 characters can be input.

The Setting and the Explanation

- ① Press the **[DISPLAY]** to call the display menu. (Refer to section A.4.)
- ② Press the *{More 1/2}*.
- ③ Press the *{LABEL}* to call the label window and label menu.
- ④ Label menu
 (Select the character of label menu by using the data knob, and press the **[X1]**.)
 - {DONE}* : Completes the label input.
 - {CURSOR →}* : Shifts the cursor indicating the label input position to the right.
 - {CURSOR ←}* : Shifts the cursor indicating the label input position to the left.
 - {BACK SPACE}* : Backspaces.
 - {DELETE CHAR}* : Deletes one character.
 - {CLEAR LINE}* : Deletes all characters.
 - {CANCEL}* : Cancels the edit.

Label Window Display

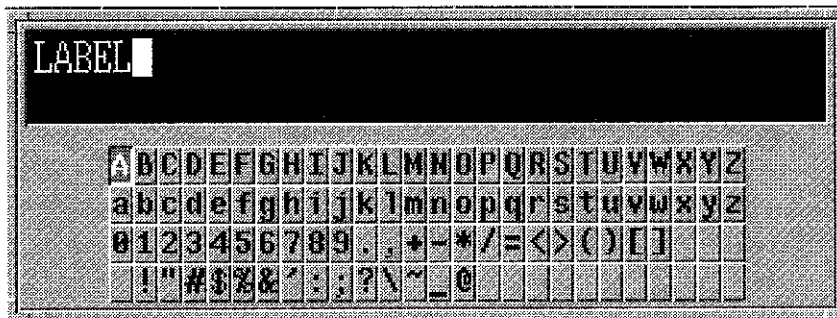

7.4.9 Colors Settings

The following explains how to set the colors of traces and markers for each channel.

Operation procedure

- ① Press the **[DISPLAY]** to call the display menu.

Press the *{More 1/2}*.

Press the *{COLOR}* to call the color menu.

{DEFAULT COLOR} : Changes all color settings to their default values.

- ② Color menu

- Color menu (1 of 3)

{1ST TRACE} : Sets the color of the first trace for the active channel.
When this function is selected, the RGB menu is displayed.

{2ND TRACE} : Sets the color of the second trace for the active channel.
When this function is selected, the RGB menu is displayed.

{1ST MARKER} : Sets the color of the normal marker on the first trace for the active channel.
When this function is selected, the RGB menu is displayed.

{2ND MARKER} : Sets the color of the normal marker on the second trace for the active channel.
When this function is selected, the RGB menu is displayed.

{REF LINE} : Sets the color of the reference line for the active channel.
When this function is selected, the RGB menu is displayed.

{ACTIVE MARKER} : Sets the color of the active marker for the active channel.
When this function is selected, the RGB menu is displayed.

- Color menu (2 of 3)

{SCREEN} : Sets the screen color.
When this function is selected, the RGB menu is displayed.

{GRID FD} : Sets the color of the grid of coordinates display.
When this function is selected, the RGB menu is displayed.

{GRID BG} : Sets the background color of the trace display area.
When this function is selected, the RGB menu is displayed.

{WINDOW BG} : Sets the box color of the trace display window.
When this function is selected, the RGB menu is displayed.

{SWEEP MARKER} : Displays the color of the sweep indicator.
When this function is selected, the RGB menu is displayed.

7.4 RESPONSE Block

- Color menu (3 of 3)
 - {ANNOTATION}* : Sets the color of the channel name being displayed on the box of the trace display window and the color of the annotation such as stimulus data.
When this function is selected, the RGB menu is displayed.
 - {CLOCK}* : Sets the color of the date and clock display at the top right-hand corner of the screen.
When this function is selected, the RGB menu is displayed.
 - {LABEL}* : Sets the color of the label display.
When this function is selected, the RGB menu is displayed.
 - {OVERLAY TEXT}* : Sets the color of the overlay text displayed in the active area.
When this function is selected, the RGB menu is displayed.
 - {BASIC TEXT}* : Sets the color of the BASIC TEXT.
When this function is selected, the RGB menu is displayed.

③ RGB menu

Determines the color of each item by the proportions of R(Red), G(Green) and B(Blue). Each value of RGB can be set in the range 0 to 255. A setting of 0 for each value is displayed as black while a setting of 255 for each value is displayed as white.

- {RED}* : Performs the setting of RED.
- {GREEN}* : Performs the setting of GREEN.
- {BLUE}* : Performs the setting of BLUE.

The changed value is stored in the environmental file of the system. It is valid in turning on the power next time.

7.4.10 Averaging/Smoothing and Resolution Bandwidth

Averaging [time average] and smoothing [moving average] are provided as the function which statistically reduces random errors that cannot be reproduced. (Refer to (1) and (2).)

Narrow resolution bandwidth will reduce noise component, thus decreasing random errors. However, the case will increase the sweeping time.

The Setting and the Explanation

- ① Press the **[AVG]** to call the average menu. (Refer to section A.4.)
- ② Average menu
 - {AVG STATE ON/OFF}* : Selects ON/OFF of averaging.
 - {AVG COUNT}* : Sets the number of times for averaging.
 - {AVG RESTART}* : Resets the averaging and restarts at the average time 1.
 - {GROUP DELAY APERTURE}*: Sets the aperture for group delay measurement. The aperture should be considered in the same manner as the smoothing aperture.
 - {SMOOTHING ON/OFF}* : Selects ON/OFF of smoothing.
 - {SMOOTHING APERTURE}* : Sets the smoothing aperture.
 - {TRACE 2ND/1ST}* : Selects between the 1st trace and the 2nd trace.
 - {IF RBW []}* : Sets the resolution bandwidth.

Resolution bandwidth	Maximum sweeping per point
10kHz	0.15msec/POINT
3kHz	0.40msec/POINT
1kHz	1.0msec/POINT
300Hz	3.4msec/POINT
100Hz	0msec/POINT
30Hz	131msec/POINT
10Hz	384msec/POINT
3Hz	1222msec/POINT

7.4 RESPONSE Block

The following describes about averaging and smoothing.

(1) Averaging

In the averaging function, the measured data are averaged with time weight before formatting it. Since vector quantity is averaged, there also is an effect that reduces the noise level.

- Averaging process

$$\bar{Y}(n) = \frac{n-1}{n} \times \bar{Y}(n-1) + \frac{1}{n} \times Y(n) \quad (n \leq N)$$

$$\bar{Y}(n) = \frac{N-1}{N} \times \bar{Y}(n-1) + \frac{1}{N} \times Y(n) \quad (n > N)$$

- $\bar{Y}(n)$: nth averaged data
- $Y(n)$: nth data not averaged yet
- N : Number of times for averaging

(2) Smoothing

The smoothing obtains the moving average between adjacent pieces of formatted data. Since scaler quantity is averaged, the noise width is reduced but the noise level will not be reduced.

- Smoothing process

$$\bar{D}(n) = \frac{D(n-m) + \dots + D(n) + \dots + D(n+m)}{2m+1}$$

- $\bar{D}(n)$: nth format data already smoothed
- $D(n)$: nth format data not smoothed yet
- $2m$: Smoothing aperture

The aperture for the setting value is obtained using the following equation:

$$\text{Aperture} \langle 2m \rangle = \frac{(\text{measurement points}) - 1}{100} \times \langle \text{value} \rangle$$

That equation means that the aperture is set by the percentage for the number of the measurement points. Even if the number of the measurement points has been changed, the setting value of the aperture will be maintained and the aperture $\langle 2m \rangle$ will be calculated again by the number of the measurement points after the change.

(Example)

Number of measurement points : 101(Point)

$$\text{Aperture} : 2(\%) \rightarrow \text{Aperture} \langle 2m \rangle = \frac{101-1}{100} \times 2 = 2$$

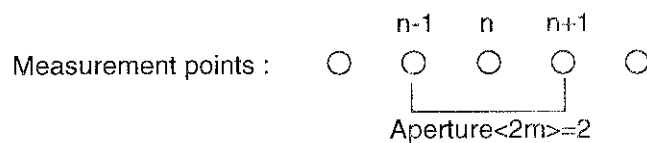

7.5 Calibration

There are six types of calibration methods to reduce the system errors, as follows:

- Normalizing..... ① (Refer to sub-section 7.5.1 and (1), (2) of sub-section 7.5.5.)
- Normalizing & Isolation calibration ② (Refer to sub-section 7.5.2 and (3) of sub-section 7.5.5.)
- 1-port full calibration ③ (Refer to sub-section 7.5.3 and (4) of sub-section 7.5.5.)
- 2-port full calibration ④ (Refer to sub-section 7.5.4 and (5) of sub-section 7.5.5.)
- Averaging..... ⑤ (Refer to sub-section 7.4.10.)
- Smoothing..... ⑥ (Refer to sub-section 7.4.10.)

The methods of ①, ②, ③ and ④ are used to remove error factors which can be reproduced. These methods measure the standard whose real value has been known. The result is used to obtain the real value of the measurement according to the error model.

The methods of ⑤ and ⑥ are used to statistically reduce random errors by obtaining the time average and moving average respectively.

Note: *The calibration methods of ①, ②, ③ and ④ can not be performed simultaneously. Since the methods of ⑤ and ⑥ can be independently operated, they can be performed simultaneously.*

7.5.1 Normalizing

Calibrates the frequency characteristics of the magnitude and phase. This method can be easily performed but cannot obtain a high accuracy.

(1) For measuring transmission

Calibrates the frequency characteristics including that of the connection cable and connector by connecting the through standard with the condition where any sample is removed.

(2) For measuring reflection

An open standard or a short standard can be selected for the calibration standard. The frequency characteristics is calibrated in the reflection measurement by connecting the calibration standard.

Both the open standard and short standard are full reflection and the phase for the short standard is shifted by 180°.

For the open standard, make sure that the reflection measurement port is actually made open.

For example, the calibration can be made when the measurement port is open (unloading condition) without the open standard for a calibrated N type connector.

However, if the open capacity is uncertain or if the open condition cannot be obtained because the measurement port is the line on the base board, the short standard should be used or the calibration should be made with the line made short.

7.5 Calibration

7.5.2 Normalize & Isolation Calibration

In the measurement of the transmission characteristic, calibrate the frequency characteristics and the isolation.

The crosstalk from the signal source of the R3765/3767H series to the receiver section and the change for the worse of isolation caused by the jig connected between the test ports can be calibrated easily to enlarge the dynamic range.

- The frequency characteristic containing the cable and the connector is calibrated by connecting the through standards.
- The crosstalk characteristic is calibrated by connecting the load standard to the test port for the isolation characteristic.
Also the isolation of the jig for measurement can be calibrated as well.

7.5.3 1-Port Full Calibration

Calibrates the directivity, source match, and frequency tracking in the reflection measurement. This method highly accurately measures the reflection of a one port device or a two port device whose one end is terminated.

- (1) Three kinds of calibration standards are required as follows:
 - Open standard
 - Short standard
 - Load standard
- (2) The signal flow graph below shows the error model.

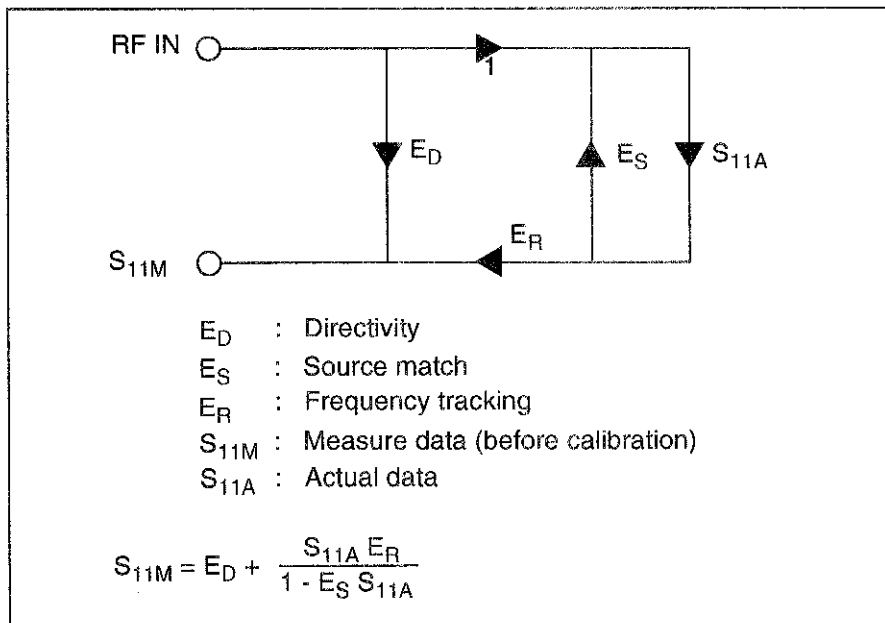

- Directivity : The directivity connector/bridge which is used for the reflection measurement detects the reflection signal from the sample device. However, it actually detects not only the reflection signal but also few incidence signals. The limitation where the reflection signal and the incidence signal can be separated is called a "directivity".
- Source match : The reflection signal from the sample device reflects at the signal source and is injected in the sample to make errors. The reflection coefficient at that signal source is called a "source match".
- Frequency tracking : Is the frequency characteristics of the measurement system including the cable and connector.

7.5.4 2-Port Full Calibration

Calibrates the directivity of two port device forward and inverse direction, source match, load match, frequency tracking and isolation.

All S parameters of 2-port device can be measured with the highest accuracy.

This calibration method can be performed only with R3765AH/3767AH + S parameter test set and R3765CH/3767CH.

- (1) The following four kinds of standard are needed for the calibration.
- Open standard
 - Short standard
 - Load standard
 - * 2 pcs. are needed for the calibration of isolation.
 - Through standard

As the characteristics of both directions, forward and inverse, are needed for the execution of calibration, if the characteristic of one of the directions are to be measured, the characteristics of both directions are measured.

Therefore, for S₂₁ measurement, the sweeping is performed twice for the measurement of the forward direction and the inverse direction at the execution of 2-port full calibration.

7.5 Calibration

(2) The following signal flow graph shows an error model.

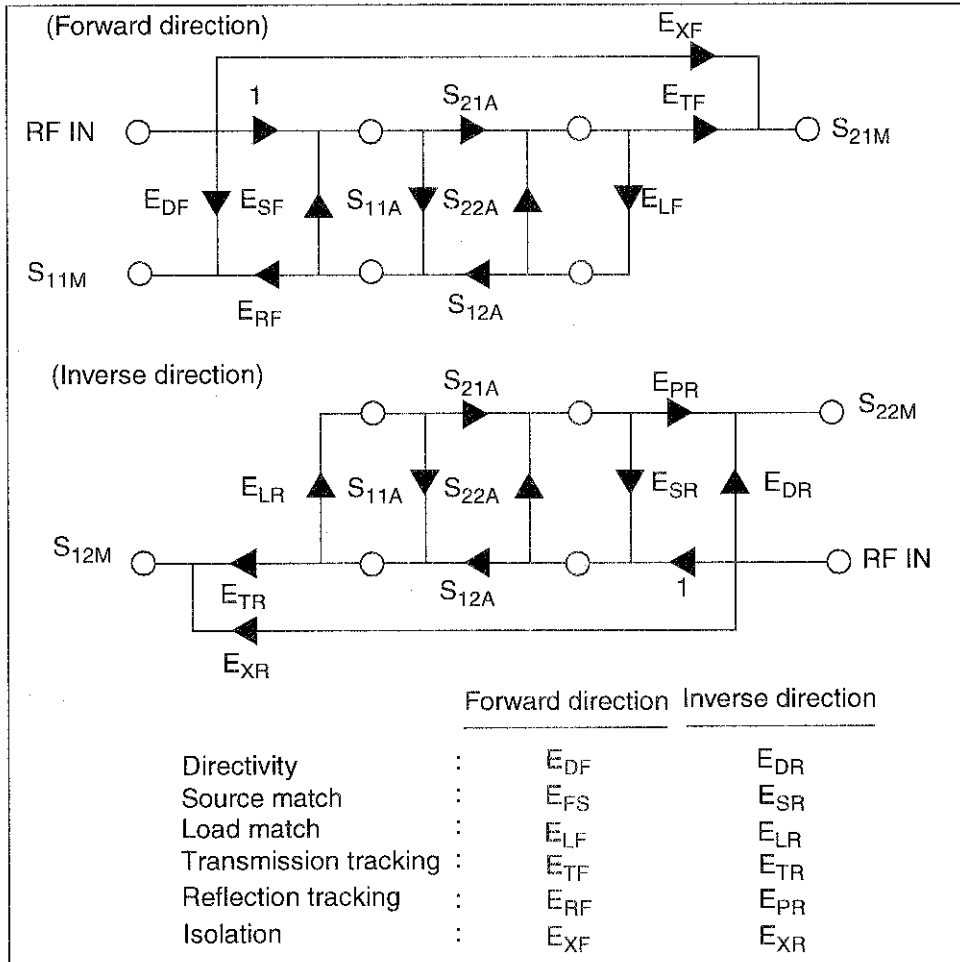

- Directivity : The directional coupler/bridge for measurement of reflection detects a reflection signal from DUT. But actually it detects not only reflection signal but a little incident signal. The limitation that can separate this reflection signal from the incident signal is called "directivity".
- Source match : The error is produced by the reflection signal from DUT which was reflected again from the signal source and then entered into DUT. The reflection coefficient in this signal source is called "source match".
- Load match : The signal passed through DUT is input into the receiver section, where the signal is reflected according to the reflection coefficient of the receiver section. This reflected signal passes DUT again and returns to the signal source. Then produces an error. This reflection coefficient in the receiver section is called "load match".
- Transmission tracking: It's the measurement frequency characteristics of transmission direction.
- Reflection tracking : It's the measurement frequency characteristics of reflection direction.

7.5.5 Calibration Method

(1) Normalizing (transmission)

The Setting and the Explanation

- ① Setup the R3765/3767H series to the transmission measurement.
- ② Connect a through standard between the measurement ports.
- ③ Press the **[CAL]** to call the calibration menu (1 of 2). (Refer to section A.4.)
- ④ Press the *{NORMALIZE (THRU)}*.

The message "Wait for Sweep" is displayed and the calibration data are obtained. The calibration is completed when the message disappears. (Note)

- ⑤ Connects a sample to perform the measurement.

(2) Normalizing (reflection)

The Setting and the Explanation

- ① Setup the R3765/3767H series to the reflection measurement.
- ② Connect a open standard or a short standard to the measurement port.
- ③ Press the **[CAL]** to call the calibration menu (1 of 2). (Refer to section A.4.)
- ④ When the open standard is used, press the *{NORMALIZE (THRU)}*.

When the short standard is used, press the *{NORMALIZE (SHORT)}*.

The message "Wait for Sweep" is displayed and the calibration data are obtained. The calibration ends when the message disappears. (Note)

- ⑤ Connects a sample to perform the measurement.

Note: *Do not move the R3765/3767H series, the cable, the connector, the standard, and the others during the message "Wait for Sweep" is displayed. When the set condition is changed during the message is displayed, the message "Calibration aborted" is displayed and the current calibration data cannot be acquired.*

7.5 Calibration

(3) Normalize & isolation calibration

The Setting and the Explanation

- ① Setup the R3765/3767H series to the transmission measurement.
- ② Press [**CAL**] to call the calibration menu (1 of 2).
- ③ Press {*CAL MENUS*} to call the full calibration selection menu.
- ④ Press {*NORMALIZE & ISOL'N*} to call the normalize & isolation calibration menu.
- ⑤ Connect the through standard between the test ports and press {*THRU*}.
The message "Wait for Sweep" is displayed and the calibration data is obtained. The calibration is completed when the message disappears. (Note)
- ⑥ Connect the load standard to each test port and press {*ISOLATION*}.
The message "Wait for Sweep" is displayed and the calibration data is obtained. The calibration is completed when the message disappears. (Note)
- ⑦ Press {*DONE NORM & ISO*} to complete the calibration of the normalize & isolation calibration.
- ⑧ Connect DUT to perform the measurement.

Note: *Do not move the R3765/3767H series, the cable, the connector, the standard, and the others when the message "Wait for Sweep" is displayed. When the set condition is changed during the message is displayed, the message "Calibration aborted" is displayed and the current calibration data cannot be acquired.*

(4) 1-port full calibration

The Setting and the Explanation

- ① Setup the R3765/3767H series to the reflection measurement.
- ② Press the **[CAL]** to call the calibration menu (1 of 2). (Refer to section A.4.)
- ③ Press the **{CAL MENUS}** to call the full calibration selection menu.
- ④ Press the **{1PORT FULL CAL}** to select the 1-port full calibration selection menu and call the 1-port full calibration menu.
- ⑤ Connect the open standard to the measurement port and press the **{OPEN}**.
The message "Wait for Sweep" is displayed and the calibration data are obtained. The calibration is completed when the message disappears. (Note)
- ⑥ Connect the short standard to the measurement port and press the **{SHORT}**.
The message "Wait for Sweep" is displayed and the calibration data are obtained. The calibration is completed when the message disappears. (Note)
- ⑦ Connect the load standard to the measurement port and press the **{LOAD}**.
The message "Wait for Sweep" is displayed and the calibration data are obtained. The calibration is completed when the message disappears. (Note)
- ⑧ Press the **{DONE 1-PORT}** to complete the 1-port full calibration.
- ⑨ Connect a sample to perform the measurement.

CAUTION!

1. *When calibration data has already been obtained, set the calibration setting to OFF and clear the data, then restart the calibration. The full calibration operation cannot be performed to prevent the calibration data loss by miss operation during the calibration or if the data existed. (Refer to sub-section 7.5.10.)*
2. *Each calibration data can be obtained again before pressing the {DONE 1-PORT}.*
3. *When the sweep condition is changed before {DONE 1-PORT} pressed, the message "Calibration canceled" is displayed and the calibration data is cleared.*

Note: *Do not move the R3765/3767H series, the cable, the connector, the standard, and the others when the message "Wait for Sweep" is displayed. When the set condition is changed during the message is displayed, the message "Calibration aborted" is displayed and the current calibration data cannot be acquired.*

7.5 Calibration

(5) 2-port full calibration

* It can be performed only with R3765AH/3767AH + S parameter test set and R3765CH/3767CH.

The Setting and the Explanation

- ① Press **[CAL]** to call the calibration menu (1 of 2). (Refer to section A.4.)
- ② Press **{CAL MENUS}** to call the full calibration selection menu.
- ③ Pressing **{2 PORT FULL CAL}** selects the 2-port calibration to call the 2-port full calibration menu.

CAUTION!

1. *When calibration data has already been obtained, set the calibration setting to OFF and clear the measurement data, then restart the calibration. During the calibration or if the data exists, the full calibration operation cannot be performed the measurement operation to prevent the calibration data loss by miss operation. (Refer to sub-section 7.5.10.)*

2. *When the sweep condition is changed before {DONE 2-PORT} pressed, the message "Calibration canceled" is displayed and the calibration data is cleared.*

- ④ Press **{REFLECT'N}** to call the 2-port reflection menu.
- ⑤ Connect the open standard to port 1 (forward direction reflection measurement port) and press **{S11 (PORT1) FWD:OPEN}**.

The message "Wait for Sweep" is displayed and the calibration data is obtained. The calibration is completed when the message disappears. (Note)

- ⑥ Connect the short standard to port 1 (forward direction reflection measurement port) and press **{S11 (PORT1) FWD:SHORT}**.

The message "Wait for Sweep" is displayed and the calibration data is obtained. The calibration is completed when the message disappears. (Note)

- ⑦ Connect the load standard to port 1 (forward direction reflection measurement port) and press **{S11 (PORT1) FWD:LOAD}**.

The message "Wait for Sweep" is displayed and the calibration data is obtained. The calibration is completed when the message disappears. (Note)

- ⑧ Connect the open standard to port 2 (inverse direction reflection measurement port) and press **{S22 (PORT2) REV:OPEN}**.

The message "Wait for Sweep" is displayed and the calibration data is obtained. The calibration is completed when the message disappears. (Note)

Note: *Do not move the R3765/3767H series, the cable, the connector, the standard, and the others during the message "Wait for Sweep" is displayed. When the set condition is changed during the message is displayed, the message "Calibration aborted" is displayed and the current calibration data cannot be acquired.*

- ⑨ Connect the short standard to port 2 (inverse direction reflection measurement port) and press *{S22 (PORT2) REV:SHORT}*.
The message "Wait for Sweep" is displayed and the calibration data is obtained. The calibration is completed when the message disappears. (Note)
- ⑩ Connect the load standard to port 2 (inverse direction reflection measurement port) and press *{S22 (PORT2) REV:LOAD}*.
The message "Wait for Sweep" is displayed and the calibration data is obtained. The calibration is completed when the message disappears. (Note)
- ⑪ Pressing *{DONE REFLECT'N}* executes the reflection calibration.
When the reflection calibration is completed, returns to the 2-port full calibration menu.
- CAUTION!**
The calibration data of each calibration standard can be acquired again before {DONE REFLECT'N} pressed.
- ⑫ Press *{TRANSMISSION}* to call the 2-port transmission menu.
- ⑬ Connect the through standard between port 1 and port 2.
- ⑭ Press *{GROUP THRU}*.
The message "Wait for Sweep" is displayed and the calibration data is obtained. The calibration is completed when the message disappears. (Note)
When this operation is performed, the following operation of step ⑮ to ⑰ is not necessary.
- ⑮ Press *{FWD.TRANS THRU}*.
The message "Wait for Sweep" is displayed and the calibration data is obtained. The calibration is completed when the message disappears. (Note)
- ⑯ Press *{FWD.MATCH THRU}*.
The message "Wait for Sweep" is displayed and the calibration data is obtained. The calibration is completed when the message disappears. (Note)
- ⑰ Press *{REV.TRANS THRU}*.
The message "Wait for Sweep" is displayed and the calibration data is obtained. The calibration is completed when the message disappears. (Note)

Note: *Do not move the R3765/3767H series, the cable, the connector, the standard, and the others during the message "Wait for Sweep" is displayed.
When the set condition is changed during the message is displayed, the message "Calibration aborted" is displayed and the current calibration data cannot be acquired.*

7.5 Calibration

- ⑮ Press {REV.MATCH THRU}.
The message "Wait for Sweep" is displayed and the calibration data is obtained. The calibration is completed when the message disappears. (Note)

- ⑯ Pressing {DONE TRANS} executes transmission calibration.
Returns to 2-port calibration menu when the transmission calibration is completed.

CAUTION!

The calibration data of each calibration standard can be acquired again before {DONE TRANS} pressed.

- ⑰ Press {ISOLATION} to call the 2-port isolation menu.

- ⑱ In case the isolation omitted.
Press {OMIT ISOLATION} and then {DONE ISOLATION}.

Isolation calibration

- (a) Connect the load standard to port 1 and port 2.

- (b) Press {FMD ISOL'N}.

The message "Wait for Sweep" is displayed and the calibration data is obtained.
The calibration is completed when the message disappears. (Note)

- (c) Press {REV ISOL'N}.

The message "Wait for Sweep" is displayed and the calibration data is obtained.
The calibration is completed when the message disappears. (Note)

- ⑳ Press {DONE ISOLATION}.
Executes the isolation calibration and returns to the 2-port full calibration menu.

CAUTION!

The calibration data of each calibration standard can be acquired again before {DONE ISOLATION} pressed.

- ㉑ Press {DONE 2-PORT}.
Executes 2-port full calibration.

Note: *Do not move the R3765/3767H series, the cable, the connector, the standard, and the others during the message "Wait for Sweep" is displayed.
When the set condition is changed during the message is displayed, the message "Calibration aborted" is displayed and the current calibration data cannot be acquired.*

7.5.6 Interpolating Calibration Data

When {*INTERPOLATE ON/OFF*} is set to ON, the calibration data is performed the interpolation error correction measurement even if the stimulus setting shown below is changed during error correction measurement (during calibration).

- Change of the sweep range (within the calibration range)
- Change of the sweep type (within the constraints)
- Change of the sweep point number

Table 7-1 Combination of Interpolatable Sweep Type (o; possible, x; impossible)

Sweep type under calibration The sweep type at the present	Linear Sweep	Log Sweep	User Sweep	Program Sweep	Power Sweep
Linear Sweep	○	×	×	×	×
Log Sweep	○	○	×	×	×
User Sweep	○	×	×	×	×
Program Sweep	○	×	×	×	×
Power Sweep	○ *1	×	×	×	○ *2

*1: Obtain the calibration data (1 point) corresponding to CW frequency from the linear sweep frequency range at the calibration and make all the points to the same calibration data.
 *2: Compensate with the output level only when CW frequency is the same.

The status display beside the scale showing the calibration status shows the following meaning.

Table 7-2 Status Display

	Normalize	Normalize & Isolation	1-port Cal.	2-port Cal.
Normal correction	"Cor"	"Cor"	"Cor"	"C2"
Interpolative correction	"C?"	"C?"	"C?"	"C2?"
Abnormal correction	"C!"	"C!"	"C!"	"C2!"

7.5 Calibration

- Normal correction : When all the setting conditions are the same as of the calibration data acquired.
- Interpolative correction : When the interpolation is possible and it is performed though the setting conditions are different.
- Abnormal correction : When the setting conditions are different and the calibration data which is acquired with interpolation of impossible is used as it is.

CAUTION!

When the interpolation is impossible, the sweep range is out of the calibration, or the setting is INTERPOLATE OFF, "CI" is displayed and the acquired calibration data is used as it is. But when the following setting is made, the calibration (CORRECT) is switched to OFF, and it becomes impossible to switch ON the calibration (CORRECT) again.

- (1) *When the number of points are changed and furthermore the sweep range is out of the calibration range.*
- (2) *When the setting is made as shown by × in Table 7-1 of the previous page.*
- (3) *When the setting of CW frequency is out of the calibration range in the setting of *1 in Table 7-1.*

7.5.7 Calibration Kit Selection

Select CAL KIT when the calibration is performed.

The Setting and the Explanation

- ① Press **[CAL]** to call the calibration menu (1 of 2). (Refer to section A.4.)
- ② Press {CAL MENUS} to call the selection menu of full calibration.
- ③ Press {CAL KIT} to call the cal kit menu. (See step ④.)
- ④ Cal kit menu
 - {N (50Ω)} : Compensate the error of N type 50Ω connector open capacity and electrical length. Calls FEMAL/MAL selection menu. (See step ⑤.)
 - {N (75Ω)} : Compensate the error of N type 75Ω connector open capacity and electrical length. Calls FEMAL/MAL selection menu. (See step ⑤.)
 - {3.5mm} : Compensate the error of 3.5mm connector open capacity and electrical length. Calls FEMAL/MAL selection menu. (See step ⑤.)
 - {7mm} : Compensate the error of 7mm connector open capacity and electrical length. The 7mm connector does not have distinction of FEMAL and MAL.
 - {USER DEFINE} : Corrects an error of the open capacitance and the electric length specified by users. Use {DEFINE STANDARD} to specify parameters and call the user specification menu. (Refer to sub-section 7.5.8.)

- {DON'T CARE} : It is used when error correction is not performed with the connector.
- {DEFINE STANDARD} : Calls the user specification menu.
When using an user selected calibration kit, its parameters should be entered. (Refer to sub-section 7.5.8.)

⑤ FEMAL/MAL selection menu

- {PORT 1 FEMAL/MAL} : Sets FEMAL/MAL of the port 1 connector.
- {PORT 2 FEMAL/MAL} : Sets FEMAL/MAL of the port 2 connector.

CAUTION!

The setting of the cal kit is effective in 1 port and 2 port full calibration.

As the correction data is calculated by using this set parameter when {DONE} is pressed at each calibration, if the setting of cal kit is changed after the {DONE} pressed, it has no effect on the calibration.

7.5.8 Parameters Entry of an User-selected Calibration Kit

This function sets the parameters of an user-selected calibration kit.

(1) Open standard

The electric length between the calibration part and the opening part, and the open capacitance can be entered.

The open capacitance is determined with C_0 , C_1 , C_2 and C_3 shown in the following equation.

$$\text{Open capacitance} = C_0 + C_1f + C_2f^2 + C_3f^3 \quad (f: \text{frequency})$$

The open capacitance is a frequency function and can be extended as the equation shown above.

(2) Short standard

The electric length between the calibration part and the short part can be entered.

(3) Through standard

Electric length, loss and impedance can be entered. Loss should be entered the resistance per unit length of the through standard.

The units of the parameters are expressed as follows:

Electric length	(OFFSET DELAY)	[sec]
Loss	(OFFSET LOSS)	[Ω /sec]
Impedance	(OFFSET Z_0)	[Ω]
Open capacitance	(OPEN C_0)	[10^{-5} F]
	(OPEN C_1)	[10^{-27} F/Hz]
	(OPEN C_2)	[10^{-36} F/Hz ²]
	(OPEN C_3)	[10^{-45} F/Hz ³]

The unit, [sec] is converted to the unit [m], multiplied by the speed of light.

7.5 Calibration

The Setting and the Explanation

- ① Press the **[CAL]** to call the calibration menu (1 of 2).
- ② Press *{CAL MENUS}* to call the full calibration selection Menu.
- ③ Press *{CAL KIT}* to call the calibration kit menu.
- ④ Press *{DEFINE STANDARD}* to call the user selection menu.
- ⑤ User specifying menu
 - {PORT1 REFL.STD}* : Enters the parameter of the open standard to be connected to Port 1.
calls the open standard entry menu. (See step ⑥.)
 - {PORT2 REFL.STD}* : Enters the parameter of the open standard to be connected to Port 2.
Calls the open Standard entry menu. (See step ⑥.)
 - {P1 ~ P2 THRU.STD}* : Enters the parameters of the through standard to be connected between Port 1 to Port 2.
Calls the offset entry menu. (See step ⑦.)
 - {SAVE TO USER DEFINE}*: Saves the parameters entered.
calls the saving menu. (See step ⑧.)
- ⑥ Open standard entry menu
 - {OPEN C0}* : Enters the open capacitance, C_0 .
 - {OPEN C1}* : Enters the open capacitance, C_1 .
 - {OPEN C2}* : Enters the open capacitance, C_2 .
 - {OPEN C3}* : Enters the open capacitance, C_3 .
 - {OPEN OFFSET}* : Enters the electric length of the open standard.
Calls the offset entry menu. (See step ⑦.)
 - {SHORT OFFSET}* : Enters the electric length of the short standard.
Calls the offset entry menu. (See step ⑦.)
- ⑦ Offset entry menu
 - {OFFSET DELAY}* : Enters the electric length of the open/short/through standard.
 - {OFFSET LOSS}* : Enters the loss of the through standard.
 - {OFFSET Z0}* : Enters the impedance of the through standard.
- ⑧ Saving menu
 - {YES}* : Saves the parameters of the calibration kit.
 - {NO}* : Does not save the parameters of the calibration kit.

7.5.9 Extending Measurement Reference Plane

Is the function which moves the calibration plane to the end of the cable when the extension cable is connected to the test port after calibration. The function calibrates the addition of the electrical length, assuming that the cable having no loss completely has been added. That is, it obtains the phase characteristics only for a sample by calibrating the phase shift for the addition.

- **Electrical length correction**
Corrects the electrical length which has been set to the measurement data. The measurement port type is not identified. It can be used not only for correction but also measuring the electrical length of the cable. Also, it can be used to measure flatness of the phase by removing phase change due to the electrical length of the actual sample.
- **Port extension**
Measurement is made, assuming that the extension cable with the electrical length already set is connected to the measurement port. That is, the electrical length already set is automatically corrected according to the change of the measurement port. For example, if a correction value 10ns is set to the port 1 and a value 20ns is set to the port 2 when S parameter test-set is used, the correction is automatically made as follows:

For S_{11} measurement: (PORT 1) \times 2=20ns

For S_{21} measurement: (PORT 1)+(PORT 2)=30ns

- **Phase offset**
This function does not correct the electrical length. It adds a constant phase value as an offset regardless of the frequency.
- **Phase slope**
This function corrects and displays slope of the data measured by phase measurement. The phase of the stop frequency is corrected by an input value with reference to the phase of the start frequency.
- **Velocity factor (V_f)**
Sets the transfer constant value to be used to calculate the electrical length. The initial setting is $V_f=1$.

$$V_f = \frac{1}{(\epsilon_R)^{1/2}}$$

- **Phase offset value/correction value**

$$\begin{aligned} \Phi(\text{deg}) &= \frac{L}{c} \times \frac{1}{V_f} \times f \times 360 \\ &= S \times f \times 360 \end{aligned}$$

V_f	:	Velocity factor
L	:	Electrical length (distance)
c	:	Light speed
S	:	Electrical length (time)
f	:	Frequency
ϵ_R	:	Relative permittivity

7.5 Calibration

The Setting and the Explanation

- Calibration menu (1 of 2 and 2 of 2) includes the menu with which the reference plane is extended.
- ① Press the **[CAL]** to call the calibration menu (1 of 2). (Refer to section A.4.)
 - {PORT EXTENSION}* : Calls the port extension menu. (See step ④.)
- ② Press the *{More 1/2}* to call the calibration menu (2 of 2).
- ③ Calibration menu (2 of 2)
 - {ELEC DELAY ON/OFF}* : Selects ON/OFF of the electrical length correction.
 - {ELECTRICAL DELAY}* : Sets the correction value for the electrical length in a unit of time.
 - {ELECTRICAL LENGTH}* : Sets the correction value for the electrical length in a unit of distance.
 - {VELOCITY FACTOR}* : Sets the velocity factor value.
 - {PHASE OFFSET VALUE}* : Sets the phase offset value.
 - {PHASE SLOPE}* : Sets the phase slope value.
- ④ Port extension menu
 - For R3765AH/3767AH+S parameter, R3765BH/3767BH, R3765CH/3767CH
 - {EXTENSION ON/OFF}* : Selects ON/OFF of the port extension.
 - {EXTENSION INPUT R}* : Sets the value of the input port R extension by time.
 - {EXTENSION INPUT A}* : Sets the value of the input port A extension by time.
 - {EXTENSION INPUT B}* : Sets the value of the B input port B extension by time.
 - {EXTENSION PORT 1}* : Sets the value of the S parameter test-set port 1 extension by time.
 - {EXTENSION PORT 2}* : Sets the value of the S parameter test-set port 2 extension by time.
 - For R3765AH/3767AH
 - {EXTENSION ON/OFF}* : Selects ON/OFF of the port extension.
 - {EXTENSION INPUT R}* : Sets the value of the input port R extension by time.
 - {EXTENSION INPUT A}* : Sets the value of the input port A extension by time.
 - {EXTENSION INPUT B}* : Sets the value of the B input port B extension by time.

7.5.10 Calibration Data Clear

Once the calibration operation is executed, the {CORRECT ON/OFF} which indicates the calibration being executed is set to ON. For re-calibration, the calibration data must be cleared.

Note: *Re-calibration operations differ between the case of normalize and the case of normalize & isolation calibration and full calibration.*

- (1) For normalize

Whether calibrated or not, the data is re-calibrated by pressing the {NORMALIZE}.

Note: *The normalize calibration data is overwritten by the re-calibration operation so that the function for clearing the calibration data is not provided.*

- (2) The case of normalize & isolation calibration and full calibration

If the calibration data of the normalize & isolation calibration and full calibration has already been existed, in either case the calibration ON or OFF, the re-calibration cannot be executed. To re-calibrate the data, the data must be cleared.

The calibration data cannot be cleared during the calibration operation in order to prevent miss operation. But if the sweeping condition is changed during the calibration, the data can be cleared forcefully because the sweeping condition of each acquired calibration data is changed.

The Setting and the Explanation

- ① Press the [CAL] to call the calibration menu (1 of 2). (Refer to section A.4.)
- ② Sets the {CORRECT ON/OFF} to OFF.
- ③ Press the {CAL MENUS} to call the full-calibration selection menu.
- ④ Press the {CLEAR CAL DATA} to call the clearing menu.
- ⑤ Press the {YES} to clear the calibration data.
- ⑥ Select any one of 1-port/2-port full calibration and enter the calibration operation.

CAUTION!

If the {CORRECT ON/OFF} is set to OFF, unless the calibration data is not cleared, the calibration can be set to ON again.

7.6 Marker Function

7.6 Marker Function

The value of the data displayed can be read out with the marker. Also, the marker can find out the maximum or minimum value and change the settings of the signal source and the display.

Up to ten markers can be set for the sub measure screen of each channel.

One of the ten markers per channel is set to the active marker. The change of the marker setting is made to the active marker.

The values on active marker is always displayed in the specified position on the screen.

Also, the marker list function can display all the values of other markers and the active marker at the same time.

[MKR] : Calls a marker menu to set a marker.

[MKR →] : Calls a marker search menu for a marker analysis.

An active marker and a normal marker are shown in the following.

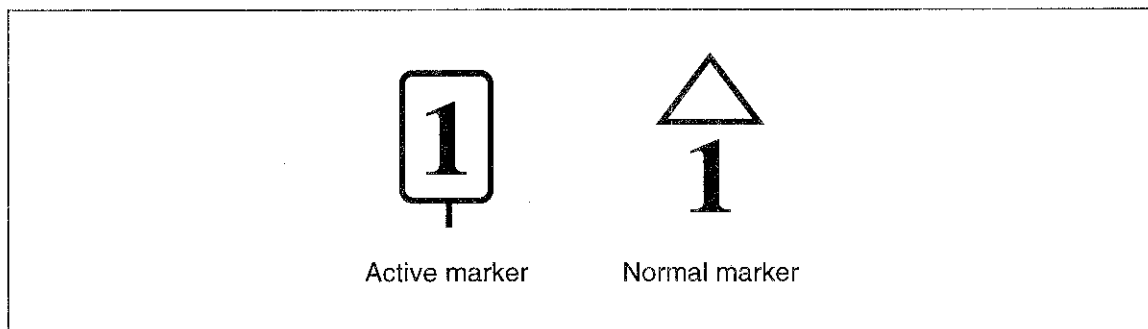

7.6.1 Setting Marker

Up to ten markers can be set for each channel and the marker which is displayed at the marker area on the screen is called an "active marker".

This function sets the active marker or changes the marker already set.

The Setting and the Explanation

- ① Press the **[MKR]** to call the marker menu. (Refer to section A.4.)
- ② Press the **{ACTIVATE MARKER []}** to call the active marker menu.
- ③ Active marker menu
 - Active marker menu (1 of 2)
 - {MARKER 1}** : Sets the marker 1 for the active marker.
 - {MARKER 2}** : Sets the marker 2 for the active marker.
 - {MARKER 3}** : Sets the marker 3 for the active marker.
 - {MARKER 4}** : Sets the marker 4 for the active marker.
 - {MARKER 5}** : Sets the marker 5 for the active marker.
 - {ACTIVATE MKR OFF}** : Sets off only the active marker.
If several markers are set, the marker of the smallest number becomes the active marker.

Only when a marker frequency is displayed in the active area, its marker is controlled with the ten-key and the step key.

- Active marker menu (2 of 2)
 - {MARKER 6}** : Sets the marker 6 for the active marker.
 - {MARKER 7}** : Sets the marker 7 for the active marker.
 - {MARKER 8}** : Sets the marker 8 for the active marker.
 - {MARKER 9}** : Sets the marker 9 for the active marker.
 - {MARKER 10}** : Sets the marker 10 for the active marker.
 - {ACTIVATE MKR OFF}** : Sets off only the active marker.

7.6 Marker Function

7.6.2 Marker Coupling between Channels

The R3765/3767H series has two channels. The function is used to select if the markers are interlocked between the channels or not.

“Marker interlock between channels” means that the marker which has been set for the active channel is automatically set for the non-active channel regardless of ON/OFF of the dual channel display. “Non-interlock” means that the markers are made to independently operate for each channel.

The Setting and the Explanation

- ① Press the [MKR] to call the marker menu. (Refer to section A.4.)
- ② Press the {MARKER MODE MENU} to call the marker mode menu.
- ③ Press the {MKR CPL/UNCPL} to select the marker coupling between the channels.
 - CPL : Coupling ON (interlock between channels)
 - UNCPL : Coupling OFF (non interlock between channels)

If sweep type satisfies the following conditions, even if the MKR CPL is specified, a marker is not coupled.

- When the sweep type of either of CH1 or CH2 is set to the USER SWEEP or the PROGRAM SWEEP.
- When both a frequency sweep and a level sweep are set simultaneously.
- When CH 1/2 is set to the zero span mode.

<For MKR UNCPL>

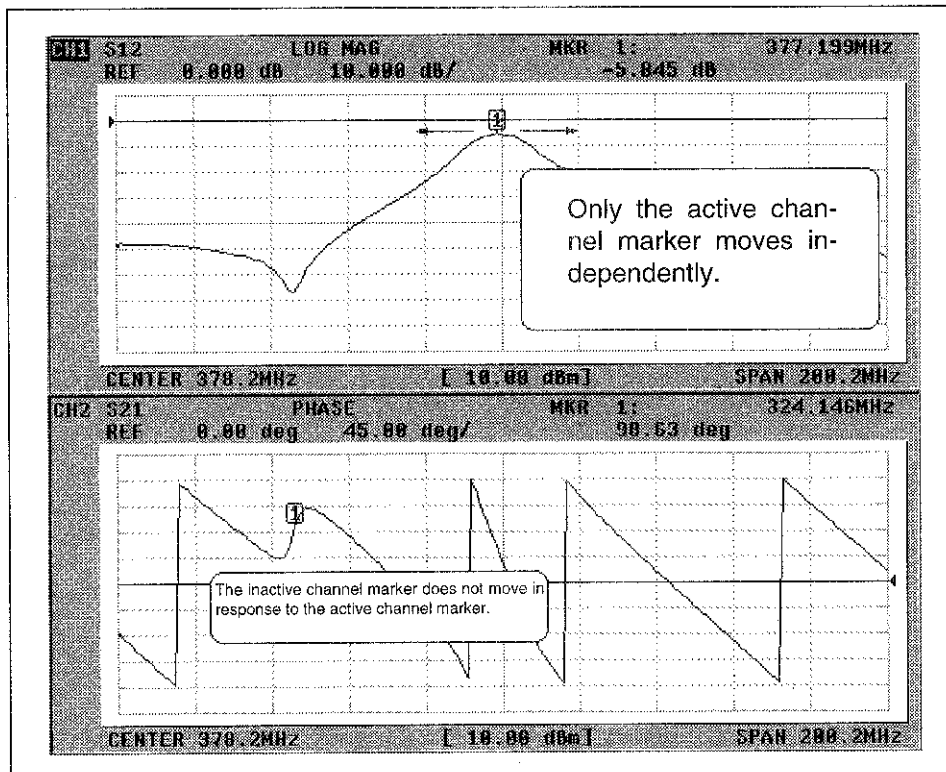

<For MKR CPL>

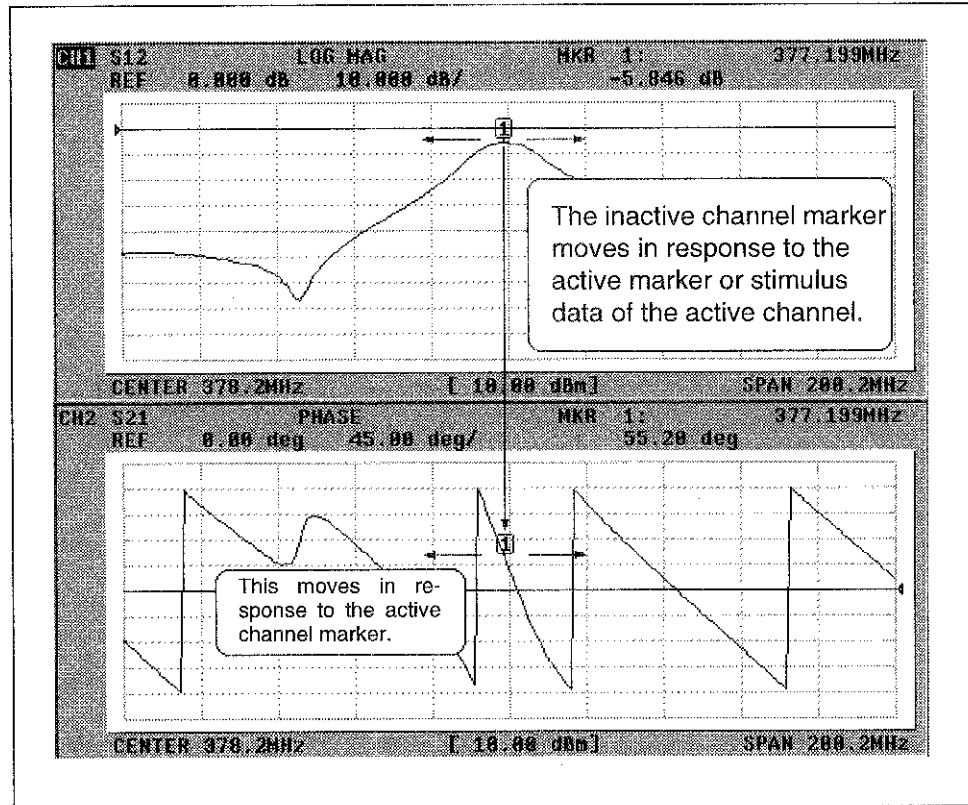

7.6 Marker Function

7.6.3 Interpolation between Measurement Points

The marker can be assigned to either one mode that sets markers and reads data of each marker by interpolating linearly between measurement points and another mode that sets markers to only actual measurement points.

The Setting and the Explanation

- ① Press the **[MKR]** to call the marker menu. (Refer to section A.4.)
- ② Press the *{MARKER MODE MENU}* to call the marker mode menu.
- ③ Interpolation between measurement points is selected by *{MKR CMP/UNCMP}*.

CMP : Interpolation (compensation) ON

UNCMP : Interpolation (compensation) OFF

When the sweep type is set to USER SWEEP/PROG SWEEP, even if CMP is selected, the interpolation possibly don't work depending on the number of set points.

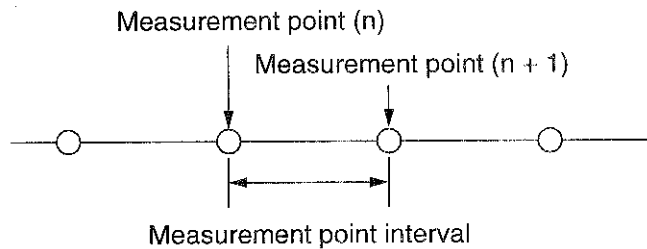

7.6.4 Displaying Marker Read out Value

The marker value displayed on the screen always indicates the active marker. To display more than that marker, use the marker list function to list all set markers at a time.

The Setting and the Explanation

- ① Press the **[MKR]** to call the marker menu. (Refer to section A.4.)
- ② Press the *{MKR LIST ON/OFF}* to select ON/OFF of the marker list display.

7.6.5 Delta-Marker Function

The delta-marker function is used to find out the difference between the active marker and the specified marker. Three kinds of modes are available depending on the marker to be specified, as follows:

(1) Δ MKR mode

Obtains the difference between the child marker and the active marker by setting the child marker to the position of the active marker. The difference between the current position and the previous position (child marker) can be obtained by moving the active marker.

(2) ACT MKR mode

Obtains the difference between the active marker and the other marker.

(3) FIXED MKR mode

Obtains the difference between the active marker and the fixed marker by freely setting the fixed marker regardless of the trace data. The fixed marker is set with the stimulus and response values.

That is, the fixed marker is always fixed to the position of specified stimulus and response values regardless of the trace data.

The response values for the other markers including the child marker are on the trace data.

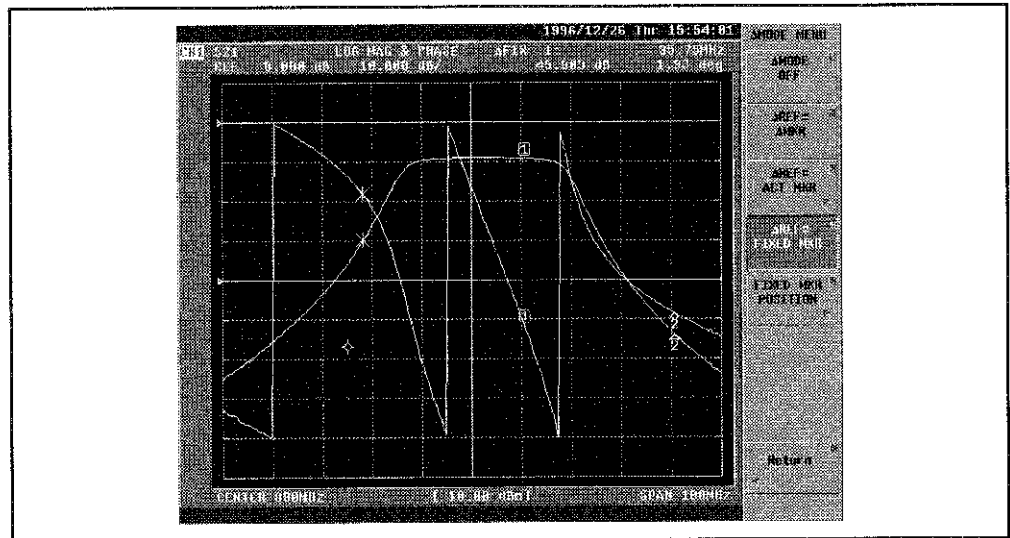

Figure 7-1 Delta-Marker Function

7.6 Marker Function

- Δ REF= Δ MKR : The delta value of active marker ① and the child marker ③ is measured.
- Δ REF=ACT MKR : The delta values of active marker ① and compare marker ② is measured.
- Δ REF=FIXED MKR : The delta value of active marker ① and the Fixed marker ④ is measured.

The Setting and the Explanation

- ① Press the **[MKR]** to call the marker menu. (Refer to section A.4.)
- ② Press the **{ Δ MODE MENU}** to call the delta-mode menu.
- ③ Delta mode menu
 - { Δ MODE OFF}** : Sets OFF the delta mode.
 - { Δ REF= Δ MKR}** : Selects the Δ MKR mode. (See step ④.)
 - { Δ REF=ACT MKR}** : Selects the ACT MKR mode to call the ACT MKR menu. (See step ⑤.)
 - { Δ REF=FIXED MKR}** : Selects the FIXED MKR mode.
 - {FIXED MKR POSITION}** : Calls the FIXED MKR setting menu. (See step ⑥.)
- ④ For Δ MKR mode

Pressing the **{ Δ REF= Δ MKR}** in step ③ causes the child marker (*) to be displayed on the active marker position and the result to be displayed at the active area on the screen.

Since the active marker setting can be changed, obtain the data by moving the active marker using the data knob.
- ⑤ For ACT MKR mode

Pressing the **{ Δ REF=ACT MKR}** in step ③ calls the ACT MKR menu. Set the marker for comparison. Since the menu has also the software menu to change the active marker, it is possible to change the active marker without returning to the **[MKR]**.

 - ACT MKR menu(1 of 2)
 - {COMPARE MARKER 1}** : Changes the marker for comparison to the marker 1.
 - {COMPARE MARKER 2}** : Changes the marker for comparison to the marker 2.
 - {COMPARE MARKER 3}** : Changes the marker for comparison to the marker 3.
 - {COMPARE MARKER 4}** : Changes the marker for comparison to the marker 4.
 - {COMPARE MARKER 5}** : Changes the marker for comparison to the marker 5.
 - {ACTIVATE MARKER []}** : Calls the active marker menu. (Refer to sub-section 7.6.1.)

- ACT MKR menu (2 of 2)
 - {COMPARE MARKER 6}* : Changes the marker for comparison to the marker 6.
 - {COMPARE MARKER 7}* : Changes the marker for comparison to the marker 7.
 - {COMPARE MARKER 8}* : Changes the marker for comparison to the marker 8.
 - {COMPARE MARKER 9}* : Changes the marker for comparison to the marker 9.
 - {COMPARE MARKER 10}* : Changes the marker for comparison to the marker 10.
 - {ACTIVATE MARKER []}* : Calls the active marker menu. (Refer to sub-section 7.6.1.)

⑥ For FIXED MKR mode

Pressing the *{Δ REF=FIXED MKR}* in step ③ displays the difference between the active MKR and the FIXED MKR (◇) on the active area of the screen.

To set the FIXED MKR position, press the *{FIXED MKR POSITION}* on the same menu to call the FIXED MKR setting menu.

- FIXED MKR setting menu
 - {FIXED MKR STIMULUS}*: Sets the FIXED MKR stimulus value.
 - {FIXED MKR VALUE}* : For the Smith chart and polar display, sets the FIXED MKR response value (real part).
 - {FIXED MKR AUX VALUE}*: For the Smith chart and polar display, sets the FIXED MKR response value (imaginary part).
 - {FIXED MKR → ACTIVE MKR}*:
Sets the FIXED MKR to the active marker position.

If changing the stimulus reference value or others cause the fixed marker to move outside the screen, the fixed marker is not displayed.

The fixed marker can be displayed and set even if the delta mode is off.

If a parameter other than "1/S" has been set to CONVERSION ON in the parameter conversion menu, the fixed marker can not be set nor displayed.

Note: *FIXED MKR STIMULUS/VALUE/AUX VALUE can be set only with the ten-key.*

7.6.6 Marker Menu during Impedance Measurement

To read the impedance directly by the marker during parameter conversion or impedance measurement, the marker menu can be selected from three modes (parameter conversion, Smith chart display, or polar display).

The Setting and the Explanation

- ① Press the **[MKR]** to call the marker menu. (Refer to section A.4.)
- ② Press the **{MARKER MODE MENU}** to call the marker mode menu.
- ③ Marker mode menu
 - {CONVERSION MKR MENU []}**:
Calls the conversion marker menu which sets the marker data display mode during the parameter conversion. (See step ④.)
 - {SMITH MKR MENU []}** :
Calls the Smith marker menu which sets the marker data display mode during the Smith chart display. (See step ⑤.)
 - {POLAR MKR MENU []}** :
Calls the menu which sets the marker data display mode during the polar display. (See step ⑥.)
- ④ Conversion marker menu
 - {DEFAULT}** : Displays the value corresponding to the data format.
 - {LIN MKR}** : Displays the linear magnitude value and the phase value.
When a format is selected except SMITH and POLAR in the format menu, if SMOOTHING is set to ON, a correct value cannot be obtained.
 - {Re/Im MKR}** : Displays the complex data.
When a format is selected except SMITH and POLAR in the format menu, if SMOOTHING is set to ON, a correct value cannot be obtained.
- ⑤ Smith marker menu
 - {LIN MKR}** : Displays the linear magnitude value and the phase value.
 - {LOG MKR}** : Displays the logarithmic magnitude value and the phase value.
 - {Re/Im MKR}** : Displays the complex data.
 - {R+jX MKR}** : Displays the complex impedance.
 - {G+jB MKR}** : Displays the complex admittance.
 - {Z0 VALUE}** : Sets the characteristic impedance.

- ⑥ Polar marker menu
- | | |
|-------------|---|
| {LIN MKR} | : Displays the linear magnitude value and the phase value. |
| {LOG MKR} | : Displays the logarithmic magnitude value and the phase value. |
| {Re/Im MKR} | : Displays the complex data. |
| {ZO VALUE} | : Sets the characteristic impedance. |

7.6.7 Marker Analysis Function

The marker analysis function has search functions for obtaining the values such as maximum value and minimum value.

This function also provide the functions to change the signal source setting and the display scale setting by the marker value.

The following items are provided for search functions:

- Maximum value
- Minimum value
- Phase : 0°
- Phase : $\pm 180^\circ$
- Specified response value (magnitude, phase)
- Filter analysis (bandwidth, Q, shaping factor)

To perform the analysis operation, two modes are provided. Select any one of the mode for only one execution, or the mode for repeating every sweeping. The analysis area is selected the all measurement area, or the part search mode performing within the area specified by the marker delta mode.

CAUTION!

Searching is basically performed to the displayed data, but

- *The case that phase 0° or phase $\pm 180^\circ$ was selected when the phase data was not displayed.*
- *The SMITH/POLAR case*

In the above cases, the displayed data is not searched but the internal data.

7.6 Marker Function

The Setting and the Explanation

- ① Press the [MKR→] to call the marker search menu. (Refer to section A.4.)
- ② Marker search menu
(This menu is used to change the signal source or the display scale.)
 - {MARKER→START} : Changes the sweep-start value of the signal source to the active marker position.
 - {MARKER→STOP} : Changes the sweep-stop value of the signal source to the active marker position.
 - {MARKER→CENTER} : Changes the sweep-center value of the signal source to the active marker position.
 - {ΔMARKER→SPAN} : Changes the span of the signal source to the area specified by the ΔMARKER.
 - {MARKER→REF.VALUE} : Changes the reference value of the display scale to the response value of the active marker.
 - {PART SRCH []} : Calls the part search menu. (See step ⑦.)
 - {MKR SEARCH[]} : Calls the search menu. (See step ③.)
- ③ Search menu
 - {MKR SEARCH OFF} : The search function is released.
 - {MAX} : Moves the active marker to the position of maximum value. If the FORMAT is SMITH/POLAR, the active marker moves to the maximum value position of the internal LOG-MAG data.
 - {MIN} : Moves the active marker to the position of minimum value. If the FORMAT is SMITH/POLAR, the active marker moves to the minimum value position of the internal LOG-MAG data.
 - {TARGET} : Calls the target menu which searches the specified value. (See step ④.)
 - {RIPPLE} : Calls the ripple menu which searches the ripple. (See step ⑤.)
 - {FLTR ANAL} : Calls the filter analysis menu. (See step ⑥.)
 - {TRACKING ON/OFF} : Selects the function for searching every sweep.
 OFF: Searches one time.
 ON: Searches every sweep. When ON is selected, the search is performed on the search menu, and the search is repeated/executed every sweep.

CAUTION!

If MAX search and MIN search is performed when FORMAT is SMITH/POLAR, the searched position may not be the same as the display when SMOOTHING is ON. Because the SMOOTHING is performed to the display data but not to the internal LOGMAG data.

④ Target menu

- {TARGET VALUE}** : Searches the specified value (response value).
If SMITH or POLAR is set in the format menu, LOG MAG type of data is searched as TARGET VALUE.
However, if SMOOTHING is set to ON, the active marker does not move to a correct data.
- {0°}** : Searches the phase 0°.
The phase data is surely searched without regard to any format.
If SMOOTHING is set to ON, the active marker does not move to a correct data.
- {±180°}** : Searches the phase 180°.
The phase data is surely searched without regard to any format.
If SMOOTHING is set to ON, the active marker does not move to a correct data.
- {LEFT SEARCH}** : Searches specified value of left side from current marker position.
- {RIGHT SEARCH}** : Searches specified value of right side from current marker position.

CAUTION!

1. *When the internal data is searched, the searched position may not be the same as the display because the smoothing is performed to the internal data when SMOOTHING is ON.*
2. *TARGET VALUE can be specified only with the ten-key.*

⑤ Ripple menu

- {MAX ∩}** : Searches for the maximum of local maximum peak values.
When FORMAT is SMITH/POLAR, the internal LOG-MAG data is searched.
- {MIN ∪}** : Searches for the minimum of local minimum peak values.
When FORMAT is SMITH/POLAR, the internal LOG-MAG data is searched.

7.6 Marker Function

- $\{\Delta MAX \cap -MIN U\}$: Calculates the difference between the maximum of local maximum peak values and the minimum of local minimum peak values.
 Moves the active marker to the position of the maximum of local maximum peak values and moves the delta marker (other than FIXED MKR) to the position of the minimum of local minimum peak values.
 When FORMAT is SMITH/POLAR, the internal LOG-MAG data is searched.

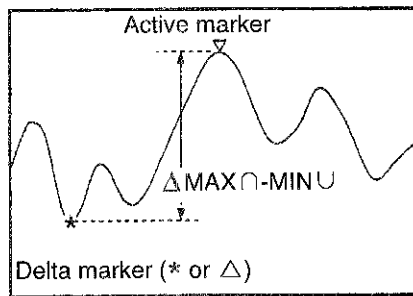

- $\{MAX - MIN\}$: Searches for the difference between the maximum and the minimum.
- $\{\Delta X\}$: Specifies the detecting sensitivity for the ripple search. The differential coefficient ΔX is specified here. Specify a ratio, regarding the full scale of the horizontal axis as 100%. ΔX is specified only with the ten-key.
- $\{\Delta Y\}$: Specifies the detecting sensitivity for the ripple search. The differential coefficient ΔY is specified here. ΔY are specified only with the ten-key.

How to obtain ripple (local maximum peak value)

To obtain ripple value under the detecting sensitivity $\Delta Y/\Delta X$, search for a point (a) where the gradient (Y/X) of the trace is larger than $\Delta Y/\Delta X$.

Next, search a point (d) where the reverse gradient (Y/X) of the trace is larger than $\Delta Y/\Delta X$. Then the maximum value between (a) and (d) is obtained as a local maximum peak value.

A local minimum peak value can be obtained by reversing the polarity of $\Delta Y/\Delta X$ in the above procedure.

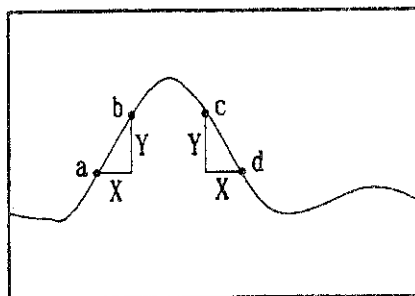

CAUTION!

1. When the internal data is searched, the searched position may not be the same as the display because the smoothing is performed to the internal data when **SMOOTHING** is ON.
2. ΔX and ΔY setting are possible only with ten keys.

⑥ Filter analysis menu

- {WIDTH VALUE}** : Specifies the maximum loss when determining the pass band. Specifies the loss (X dB) from the level reference point.
- {FILTER TYPE BAND/NOTC}** : Selects the filter type.
BAND : Analyzes a band pass filter.
NOTC : Analyzes a notch filter.
- {SEARCH FROM []}** : To the search reference menu.
- {DISPLAY MODE ABS/REL}** : Selects the way in which the bandwidth is displayed.
ABS : Displays the bandwidth using two absolute values (i.e., the lower and higher frequencies).
REL : Displays the bandwidth relative to the center frequency.
- {SEARCH IN/OUT}** : Selects the direction to be searched on the stimulus axis.
IN : Searches outward from the search reference point.
OUT : Searches inward to the reference point.
- {FILTER ANAL ON/OFF}** : Turns the measurement and its result display ON or OFF. When ON, this function starts the measurement and displays the result.
C.F : Displays the center frequency of the bandwidth specified by the loss (X dB) from the level reference point.
L.F : In ABS mode, this displays the left frequency of the bandwidth (the low frequency pointed by the ↓ marker).
 In REL mode, this displays the difference between the left frequency of the bandwidth and the center frequency.
R.F : In ABS mode, this displays the right frequency of the bandwidth (the high frequency pointed by the ↑ marker).
 In REL mode, this displays the difference between the right frequency of the bandwidth and the center frequency.
BW : Bandwidth
Q : Q factor
SF : Shaping factor

Note: When the format type is set except **LOG MAG**, **MAG&PHASE/LOG**, and **MAG&DELAY**, if **SMOOTHING** is set to **ON**, a correct data cannot be searched.

7.6 Marker Function

⑦ Search reference menu

Selects the reference point when analyzing filters (Note 1).

{ACTIVE MARKER} : Makes the active marker the level reference point.

{MAXIMUM VALUE} : Makes the minimum loss point the level reference point.

{REFERENCE LINE} : Makes the reference line the level reference point (Note 2).

Note 1: Each search reference (which is composed of the stimulus axis and the level axis) specified by the search reference menu is as follows:

	MAX reference		Active marker reference		Reference line reference	
	Stimulus axis	Level axis	Stimulus axis	Level axis	Stimulus axis	Level axis
Band pass filter analysis	Active Mkr	MAX	Active Mkr	Active Mkr	Active Mkr	Ref Line
Notch filter analysis	Active Mkr	MAX	MIN	Active Mkr	Active Mkr	Ref Line

MAX : Minimum loss point/MIN : Maximum loss point/Active Mkr : Active marker/
Ref Line : Reference line

For example, when MAX reference has been selected for a band pass filter analysis, the search reference point on the stimulus axis is the Active marker; the search reference point on the level axis is the MAX (the minimum loss point).

Note 2: The Reference Line reference can be selected only when the FORMAT is specified as LOG MAG, LOG MAG&PHASE or LOG MAG&DELAY.

<Examples of the result of filter analysis>

Q factor is calculated from a bandwidth B.W' where data is 3dB off a minimum loss value of the measured data, and the center frequency C.F' in the bandwidth B.W'.

$$Q = \frac{C.F'}{B.W'}$$

Shaping factor is calculated from a bandwidth B.W' where data is 3dB off minimum loss value of the measured data, and a bandwidth B.W'' where data is 60dB off the minimum loss value.

$$S.F = \frac{B.W''}{B.W'}$$

The stimulus and level reference points used to calculate the Q and Shaping factors are unaffected regardless of the level reference points which are set by the {SEARCH FROM []} key.

	Stimulus reference	Level reference
Band pass filter analysis	MAX	MAX
Notch filter analysis	MIN	MAX

Analysis methods for each setting are described as follows:

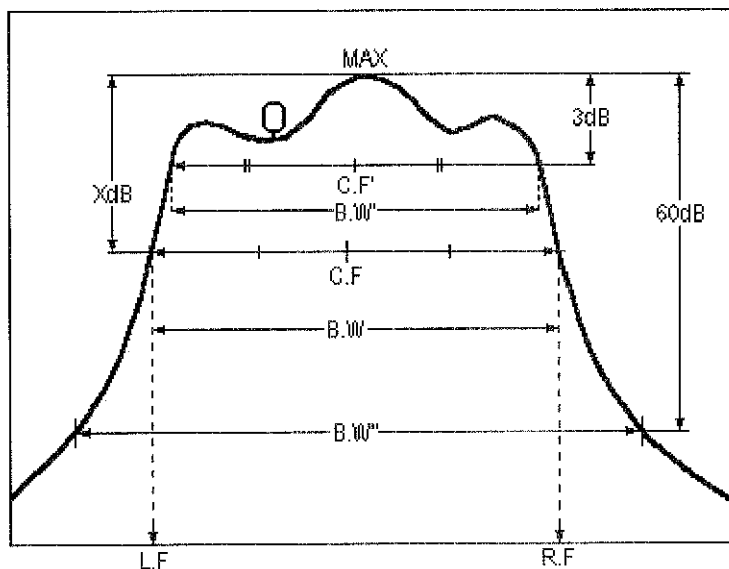

Figure 7-2 Band Pass Filter Analysis/MAX Reference

7.6 Marker Function

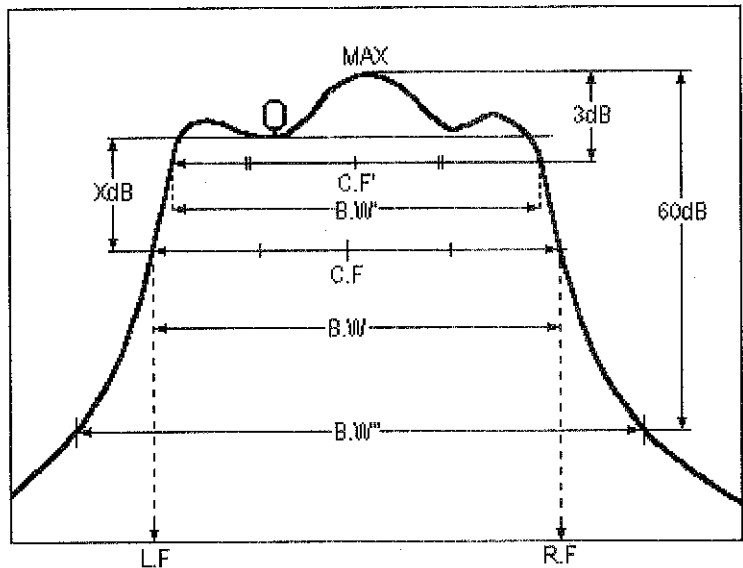

Figure 7-3 Band Pass Filter Analysis/Active Marker Reference

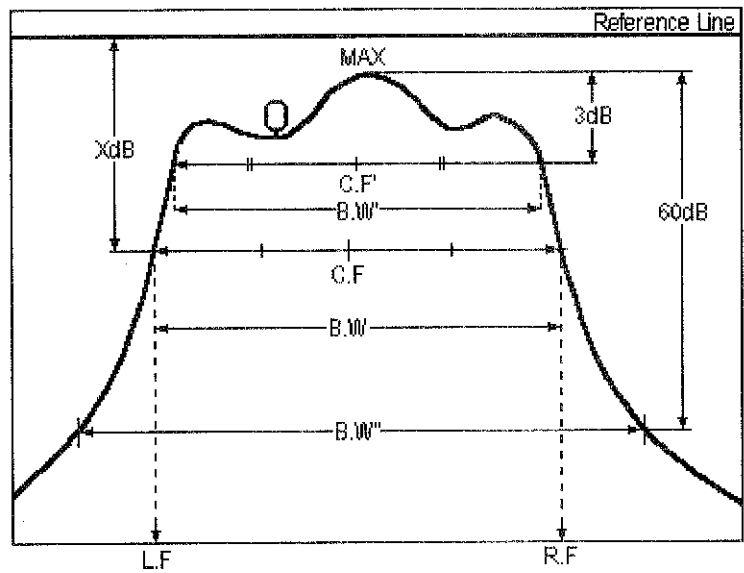

Figure 7-4 Band Pass Filter Analysis/Reference Line Reference

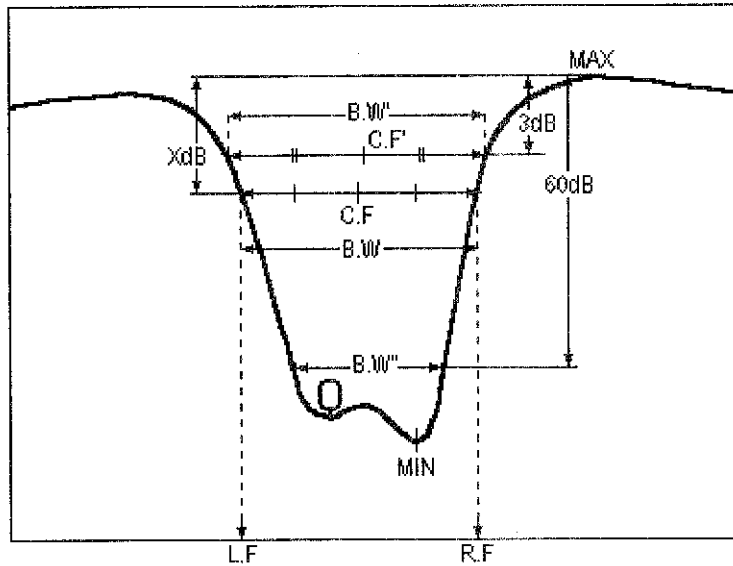

Figure 7-5 Notch Filter Analysis/MAX Reference

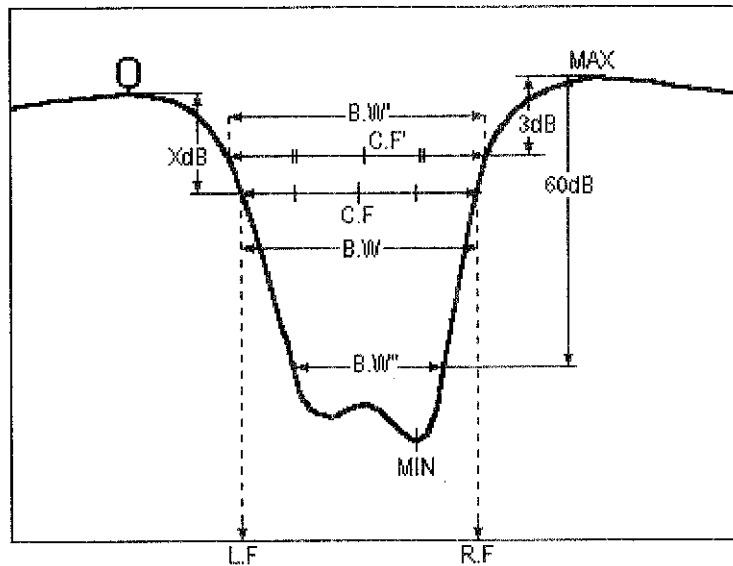

Figure 7-6 Notch Filter Analysis/Active Marker Reference

7.6 Marker Function

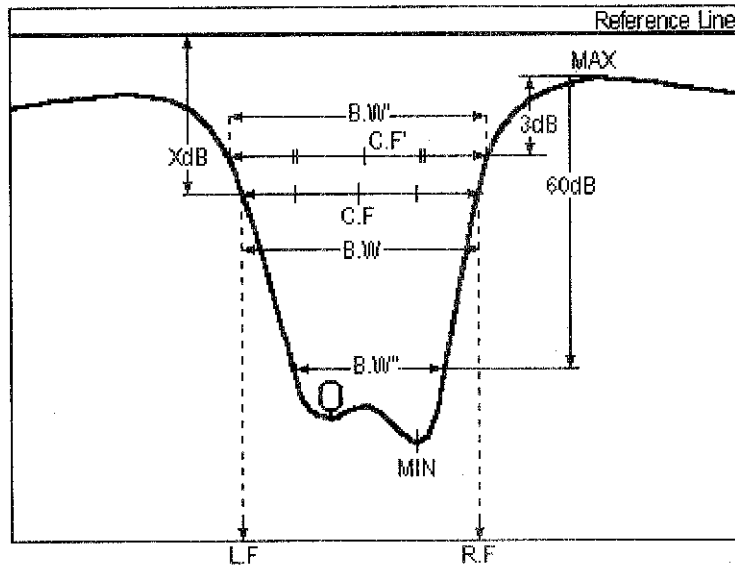

Figure 7-7 Notch Filter Analysis/Reference Line Reference

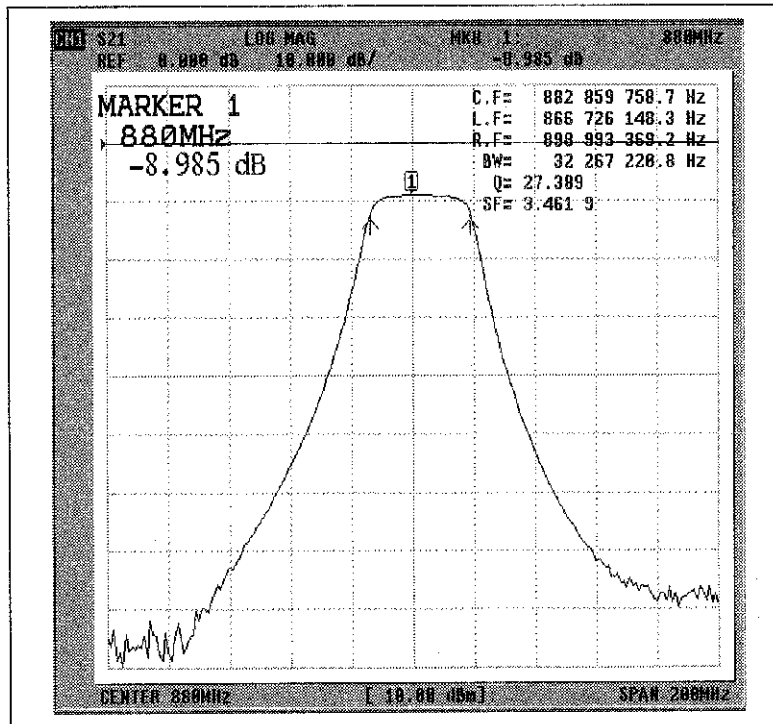

Figure 7-8 Example of Filter Analysis Execution

⑧ Part search menu

This menu is used to search specified area instead of the whole measurement area for the analysis to obtain the maximum value, minimum value and so on.

{ Δ MODE MENU} : Calls the Δ marker mode menu. (See step ②.)

{SET RANGE} : Sets partially search range which was set at Δ marker mode.

{STATISTICS ON/OFF} : Sets the statistical analysis function.
 The statistical analysis function calculates the average, standard deviation and peak to peak for the range specified by the part search (for the entire measurement range when the part search is turned OFF). The measurement result will be displayed on the right of the measurement screen.

{PART SRCH ON/OFF} : Selects ON/OFF of the part search.
 ON ; Part search
 OFF ; All search

<Measurement example by MAX search>

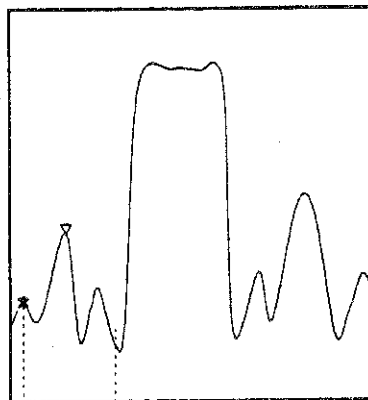

A range specified with Δ marker.

At OFF :
 Searches a maximum response value within measurement frequency.

At ON :
 Set a range specified with Δ marker as a partial search range with SET RANGE. Then set PART SRCH to ON and a marker begins to search the maximum value in the set range.

7.7 Time Domain Function (Option 70)

7.7 Time Domain Function (Option 70)

(The Time domain function is optional. This function is not available if this option has not been installed.)

7.7.1 Time Domain Transformation Function

A measurement result in the frequency domain can be transformed into the corresponding response in the time domain by using the Time domain transformation function. The result in the time domain will be represented as an impulse response or step response of the DUT.

The relationship between a frequency domain response and the corresponding time domain response of this analyzer is defined by the Fourier transform.

The time domain result can be obtained by calculating a frequency domain measurement result with the inverse Fourier transform.

(1) Transformation Mode

The bandpass and low pass modes are available for transforming the frequency domain data into time domain data.

The bandpass mode is a general purpose mode which allows the user to set the frequency range freely. This mode is used to measure a DUT impulse response with its limited bands.

Using the low pass mode, the user can obtain information about points of discontinuity. In the low pass mode, the impulse mode and the step mode are available. The former is used to obtain the response by an impulse input to a DUT ; and the latter, to obtain the response by a step input to DUT.

In the low pass mode, however, frequency range settings are restricted. Frequency data must be spaced equally in the range from the virtual DC point to the stop frequency:

$$(\text{Start frequency}) \times (\text{number of measuring points}) = (\text{stop frequency})$$

It is necessary that the above relation must be maintained.

The user can easily set frequency ranges to meet the condition above using {*SET FREQ LOW PASS*} function.

(2) Measuring Range in the Time Domain

The measuring range in the time domain (span) is determined by the measuring range in the frequency domain and the number of measuring points:

$$\begin{aligned} \text{Measuring range in the time domain} &= \frac{\text{Number of measuring points}}{\text{Frequency span}} \\ &= \frac{\text{Number of measuring points}}{\text{Stop frequency} - \text{Start frequency}} \end{aligned}$$

The measuring range can be expanded by either increasing the number of measuring points or narrowing the frequency span.

Operating procedure:

- ① Press **[FUNCTION]** to call the function menu.

Press **{TRANSFORM}** to call the time domain transformation menu.

Note: When Option 70 is not installed, **[TRANSFORM]** will not be displayed.

- ② Time domain transformation menu

Each channel can be set individually.

{TRANSFORM ON/OFF} : Toggles the time domain display ON or OFF.

ON: Displays the time domain.

OFF: Displays the frequency domain.

{SET FREQ LOW PASS} : Sets a frequency range which conforms to the low pass mode restrictions.

{LOW PASS IMPULSE} : Selects the low pass impulse transformation mode.

{LOW PASS STEP} : Selects the low pass step transformation mode.

{BANDPASS} : Selects the bandpass transformation mode.

{WINDOW []} : Calls the window menu to select a window (see section 7.7.2).

{GATE []} : Calls the gate menu to select a gate (see section 7.7.3).

7.7.2 Window Processing

Leakage phenomenon in Fourier transform occurs due to data discontinuity in the frequency domain, or data truncation in the start and stop frequencies. This leakage phenomenon consequently causes the ripples called ringing. Window processing is required to reduce this, so that the window is applied to the frequency domain data to reduce ripples in the time domain.

Three types of windows are available: **{MAXIMUM}** provides the maximum effect to reduce the ringing, but the rise time (impulse width) is longer. On the other hand, **{MINIMUM}** does not suppress the ringing, but sharp rising characteristics can be obtained.

Operating procedure:

- ① Press **[FUNCTION]** to call the function menu.

Press **{TRANSFORM}** to call the time domain transformation menu.

Press **{WINDOW []}** to call the window menu.

Note: When Option 70 is not installed, **[TRANSFORM]** will not be displayed.

- ② Window menu

Each channel can be set individually.

{MAXIMUM} : Specifies the 4-term Blackman-Harris type. The maximum reduction can be obtained.

{NORMAL} : Specifies the 2-term Hamming type.

{MINIMUM} : Specifies the rectangular type. Window processing is not performed.

7.7 Time Domain Function (Option 70)

7.7.3 Gate Function

The necessary components can be extracted from a result of the time domain response using this function. Peculiar frequency components can be either extracted or removed using a type of filter in the time domain response.

The results can be seen in both the frequency and time domains.

When the gate span is positive, the specified range is extracted; when negative, the specified range is removed.

There are four types of gate functions: for *{MAXIMUM}*, the attenuation at the cutoff region can be obtained to the maximum and the ripple at the pass region can be minimized. The cutoff time characteristics are degraded however.

For *{MINIMUM}*, very sharp cutoff characteristics can be obtained, but the attenuation at the cut-off region is reduced.

Operating procedure:

- ① Press *{FUNCTION}* to call the function menu.

Press *{TRANSFORM}* to call the time domain transformation menu.

Press *{GATE []}* to call the gate menu.

Note: When Option 70 is not installed, *[TRANSFORM]* will not be displayed.

- ② Gate menu

Each channel can be set individually.

{GATE ON/OFF} : Toggles the gate function ON or OFF. This cannot be used at the same time as the CDMA IF gate function.

{GATE START []} : Sets the gate start time.

{GATE STOP []} : Sets the gate stop time.

{GATE CENTER []} : Sets the gate center time.

{GATE SPAN []} : Sets the gate's time span.

{VELOCITY FACTOR} : Sets the velocity factor.

{GATE SHAPE []} : Calls the gate shape menu to set a type of gates (see ③).

- ③ Gate shape menu

Each channel can be set individually.

{MAXIMUM} : Specifies the 4-term Blackman-Harris type. The maximum attenuation can be obtained in the cutoff region.

{WIDE} : Specifies the 3-term Blackman-Harris type.

{NORMAL} : Specifies the 2-term Hamming type.

{MINIMUM} : Specifies the rectangular type.

7.8 CDMA IF Filter Analysis Function

This function is suitable for measuring the characteristics of CDMA IF filter.

- (1) Gate function of the CDMA IF filter
Obtains the frequency characteristics specifying the defined range of the filter delay time.
- (2) Magnitude analysis function of the CDMA IF filter
The items to be analyzed are as follows:
 - Center frequency: The center frequency between the two frequencies from which each magnitude is attenuated by the specified value from the peak value.
 - Pass bandwidth: The frequency band between the two frequencies from which each magnitude is attenuated by the specified value from the peak value.
 - Insertion loss: The peak value
 - Ripple within the pass band: The difference between the peak and lowest local minimum values.
 - Guaranteed attenuation: Lower value between the left and right values obtained by calculating the difference between the insertion loss and the value whose frequency is obtained either by adding the specified frequency to the center frequency (right side) or by subtracting the specified frequency from the center frequency (left side).
- (3) Phase analysis function of the CDMA IF filter
Calculates the phase linearity of the IF filter.

Operation procedure:

- ① Press the *{FUNCTION}* to call the function menu.
Press the *{CDMA IF FILTER}* to call the CDMA IF filter analysis menu.
- ② CDMA IF filter analysis menu
Each channel can be set individually.
 - {CDMA IF GATE []}* : Calls the CDMA IF filter analysis menu (see ③).
 - {CDMA FILTER ANALYSIS []}* : Calls the CDMA IF filter magnitude analysis menu (see ⑤).
 - {CDMA PHASE LINEARITY []}* : Turns the CDMA phase linearity analysis ON or OFF. This function calculates phase linearity in compliance with the standards of the CDMA IF filter. The CDMA phase linearity analysis cannot be performed at the same time as the phase linearity analysis.
 - {PHASE LINEARITY []}* : Calls the Phase linearity analysis menu (see ⑥).
- ③ CDMA IF filter gate menu
Each channel can be set individually.
 - {CDMA IF GATE ON/OFF}*: Toggles the CDMA IF filter gate function ON or OFF. The CDMA IF GATE cannot be ON together with the gate function of the time domain transformation function.

7.8 CDMA IF Filter Analysis Function

- {CDMA GATE START []}: Sets the start time of the CDMA IF filter gate.
- {CDMA GATE STOP []} : Sets the stop time of the CDMA IF filter gate.
- {GATE SHAPE []} : Calls the CDMA IF filter gate shape menu (see ④).

④ CDMA IF filter gate shape menu

Each channel can be set individually.

- {MAXIMUM} : Specifies the 4-term Blackman-Harris type. The maximum attenuation can be obtained.
- {WIDE} : Specifies the 3-term Blackman-Harris type.
- {NORMAL} : Specifies the 2-term Hamming type.
- {MINIMUM} : Specifies the rectangular type.
- {CDMA IF} : Specifies a type which is optimized for the CDMA IF filter.

⑤ CDMA IF filter magnitude menu

- {CDMA FILTER ANALYSIS []}: Turns the magnitude analysis function ON or OFF. When this function is turned ON, the following analysis results are displayed:

Note: *This function cannot be used with the filter analysis of marker analysis function or the statistical analysis function.*

- C. F : Displays the center frequency between the pass bandwidth specified by the loss from the peak value.
- B. W : Displays the pass bandwidth.
- I. L : Displays the insertion loss (the peak value).
- RPL : The difference between the peak and lowest local minimum values.
- ATTN1 : Displays the guaranteed attenuation. The range calculated by comparing the points where the addition to and the subtraction from the CF of ATTN FREQ1 intersects the trace. These points are then used to calculate range between them and the I.L. The shorter of these two ranges is designated as ATTN1.
- ATTN2 : Displays the guaranteed attenuation. The range calculated by comparing the points where the addition to and the subtraction from the CF of ATTN FREQ2 intersects the trace. These points are then used to calculate range between them and the I.L. The shorter of these two ranges is designated as ATTN2.
- P. L : When the phase analysis function (CDMA IF filter analysis) is ON, the phase linearity is calculated and the result is displayed.
- {WIDTH VALUE} : Specifies the bandwidth to be searched using the loss (X dB) from the peak value.
- {ATTN FREQ1} : Specifies the first frequency for the guaranteed attenuation measurement. The guaranteed attenuation is not measured when this frequency is set to 0 (zero) (as the guaranteed attenuation measurement

is set to OFF).

{ATTN FREQ2} : Specifies the second frequency for the guaranteed attenuation measurement. The guaranteed attenuation is not measured when this frequency is set to 0 (zero) (as the guaranteed attenuation measurement is set to OFF).

⑥ Phase linearity analysis menu

{PHASE LINEARITY ON/OFF}: Turns the Phase linearity analysis ON or OFF.

Note: *The phase linearity analysis cannot be performed at the same time as the CDMA phase linearity analysis.*

{PARTIAL ON/OFF} : Turns the partial definition analysis ON or OFF. When this function is set to ON, the phase linearity is analyzed for the section specified by the {SET RANGE} (which is in the partial menu under the marker search menu). When set to OFF, the phase linearity is analyzed for the full measurement range.

<Example of CDMA IF Filter Analysis>

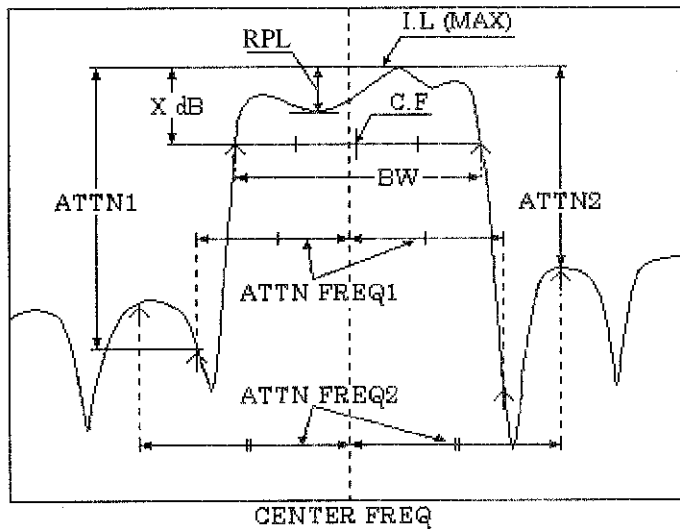

An example of CDMA IF Filter Analysis is shown above. The C.F, B.W, I.L and RPL are obtained using the loss (X dB) specified by {WIDTH VALUE}. When one of these has been calculated, the pass band is displayed with the ↑ marker.

In addition, the ATTN1 and 2 values are obtained as follows: After setting the C.F the user sets the ATTN FREQ1. The analyzer then subtracts the ATTN FREQ1 from the CF and calculates the point where this range intersects the trace. It then calculates the point where the addition of the ATTN FREQ1 to the CF intersects the trace, then calculates the range from these points to the I.L. Finally, these two points are compared, and the shorter one is designated as ATTN1. ATTN2 is calculated in the same way and both are indicated by ↑ markers on the display.

7.9 Sweep

7.9 Sweep

The following five types are provided for sweeping the signal source.

- Linear frequency sweep : The frequency sweep between measurement points is performed in equal steps linearly.
- Log (logarithmic) frequency sweep : The frequency sweep between measurement points is performed in logarithmic step.
- User frequency sweep : By the user frequency sweep, measurement points are divided into maximum 30 segments, and frequency range is set to each segment.
For example, if the segments are set in the stop band, pass band, twofold pass band of a band pass filter, then high data throughput can be obtained because of no sweeping in unnecessary area.
- Program sweep : By the program sweep is used to perform in every segment by dividing the measurement points into maximum 30 segments. Other than frequency, the output level, receiver section resolution bandwidth, and settling time can be set in every segment. The optimum sweep condition can be set, including throughput and dynamic range.
- Power sweep : The power sweep is used for level characteristic measurement.

7.9.1 Setting Sweep Type

The Setting and the Explanation

- ① Press the **[MENU]** to call the signal source menu. (Refer to section A.4.)
- ② Press the **{SWEEP TYPE []}** to call the sweep type menu.
- ③ Sweep type menu
 - {LIN FREQ}** : Sets to the linear frequency sweep.
 - {LOG FREQ}** : Sets to the log (logarithmic) frequency sweep.
 - {USER SWEEP}** : Sets to the user frequency sweep.
 - {PROGRAM SWEEP}** : Sets to the program sweep.
 - {POW SWEEP}** : Sets to the power sweep.
 - {EDIT USER SWEEP}** : Calls the segment editing menu of the user frequency sweep. (Refer to sub-section 7.9.2.)
 - {EDIT PROG SWEEP}** : Calls the segment editing menu of the program sweep. (Refer to sub-section 7.9.3.)

Setting sweep area

- Sweep area settings for the linear frequency sweep log frequency sweep and power sweep are performed with **[START]**, **[STOP]** or **[CENTER]**, **[SPAN]**.
- For the user frequency sweep and program sweep, set the sweep area on each segment editing menu.

CAUTION!

*If USER SWEEP or PROGRAM SWEEP is set, input segments are detected and arranged internally in increasing order of frequency.
If STOP frequency of a segment is higher than START frequency of the next segment in the arranged segments, an error occurs.*

7.9.2 Editing Segment of User Frequency Sweep

The Setting and the Explanation

- ① Press the **[MENU]** to call the signal source menu. (Refer to section A.4.)
- ② Press the **{SWEEP TYPE []}** to call the sweep type menu.
- ③ Press the **{EDIT USER SWEEP}** to call the user frequency sweep segment editing menu.
- ④ User frequency sweep segment editing menu

{SEGMENT: NUMBER}	: Specifies the segment number in the range of 0 to 29.
{START}	: Sets the start frequency of the specified segment.
{STOP}	: Sets the stop frequency of the specified segment.
{FREQ}	: Sets the frequency of the specified point when the number of points of the specified segment is set to 1. Reversely, if this frequency is set, then the number of points automatically becomes 1.
{POINT}	: Sets the number of points of the specified segment.
{CLEAR SEG}	: Clears the specified segment.
{CLEAR ALL SEG}	: Clears all segments.

CAUTION!

1. *If the same segment number is edited on the segment editing menu of the program sweep, then the user frequency segment is also changed. (Segment holds the program sweep in common.)*
2. *The total number of points of each segment by user frequency sweep cannot exceed 1201 points. (The maximum number of measurement points is 1201 points.)*

7.9.3 Editing Segment of Program Sweep

The Setting and the Explanation

- ① Press the **[MENU]** to call the signal source menu. (Refer to section A.4.)
- ② Press the **{SWEEP TYPE[]}** to call the sweep type menu.
- ③ Press the **{EDIT PROG SWEEP}** to call the program sweep segment editing menu.
- ④ Program sweep segment editing menu
 - Program sweep segment editing menu (1 of 2)
 - {SEGMENT: NUMBER}** : Specifies the segment number in the range of 0 to 29.
 - {START}** : Sets the start frequency of the specified segment.
 - {STOP}** : Sets the stop frequency of the specified segment.
 - {POINT}** : Sets the point number of the specified segment.
 - {CLEAR SEG}** : Clears the specified segment.
 - {CLEAR ALL SEG}** : Clears all segments.
 - Program sweep segment editing menu (2 of 2)
 - {SEGMENT: POWER}** : Sets the output level of the specified segment.
 - {IF RBW}** : Sets the receiver section resolution bandwidth of the specified segment.
 - {SETTLING TIME}** : Sets the settling time of the specified segment.

CAUTION!

1. *If the same segment number is edited on the segment editing menu of the program sweep, then the user frequency segment is also changed. (Segment holds the program sweep in common.)*
2. *The total number of points of each segment by program sweep cannot exceed 1201 points. (The maximum number of measurement points is 1201 points.)*

<Example of program sweep execution>

Here is an example how the program sweep is applied to the trace on the screen.

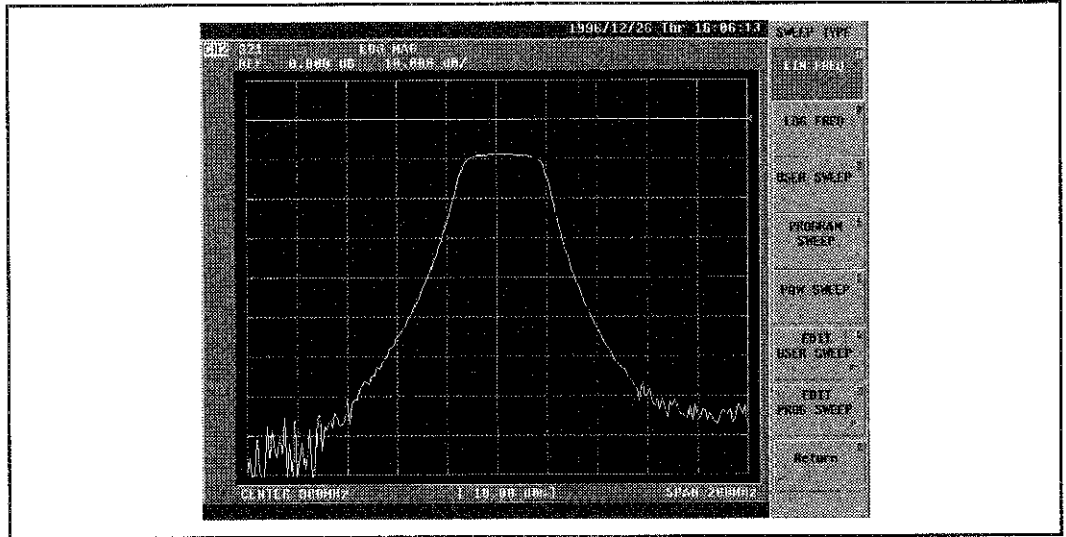

Figure 7-9 The Screen before the Segment Edited

SEG.	START	STOP	POWER	IF RBW	POINT
0	80MHz	860MHz	10.0dBm	1kHz	50
1	860MHz	900MHz	5.0dBm	10kHz	50
2	900MHz	1680MHz	10.0dBm	10kHz	50

Each segment is edited as shown like the above-mentioned.

The result of execution is shown in the following.

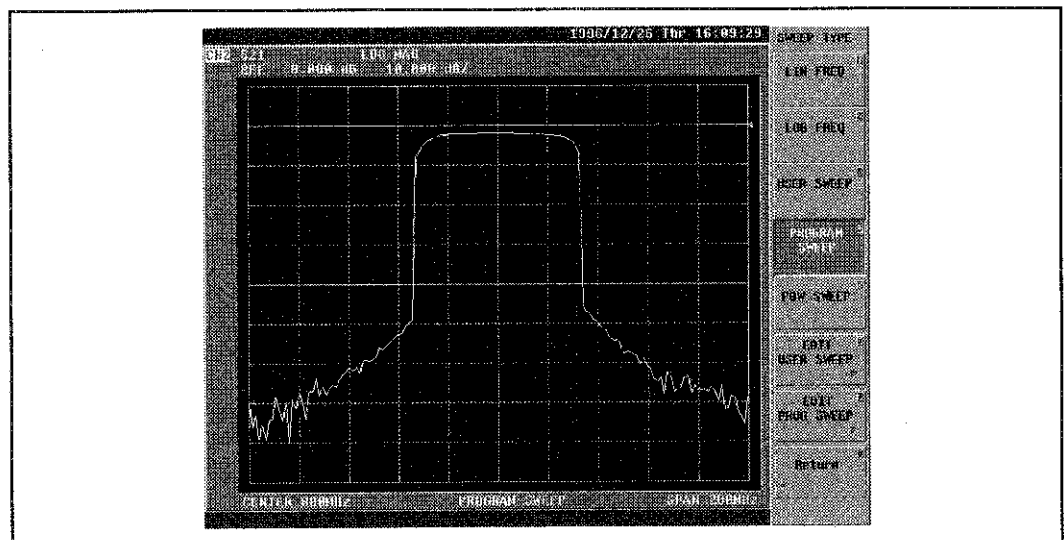
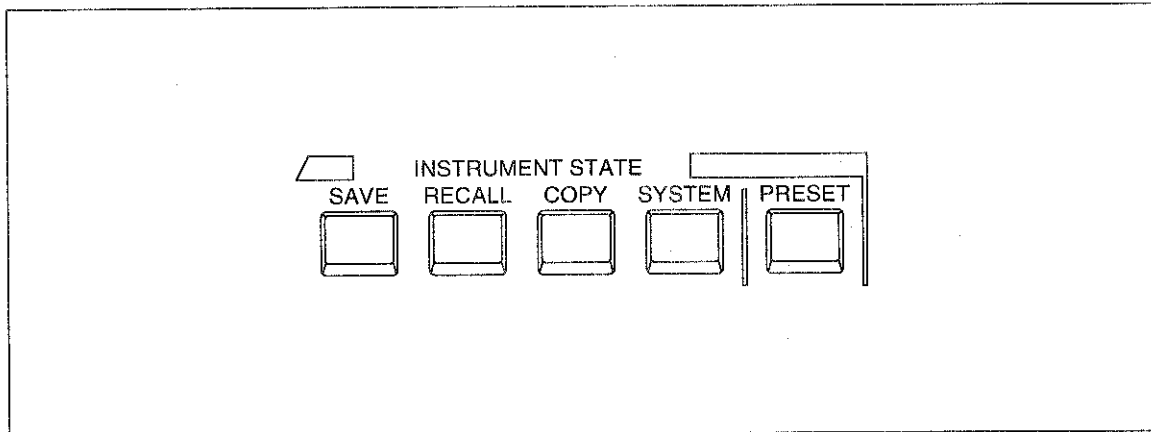

Figure 7-10 The Screen after the Segment Edited

7.10 INSTRUMENT STATE Block



The INSTRUMENT STATE block is used to set the system control functions which have no concern with the measurement. The functions are provided such as a time/date set, limit-line test, save/recall, and hard copy.

- [SAVE]** : Calls the save menu to save such as a setting data and calibration data of the R3765/3767H series. (Refer to sub-section 7.13.1.)
- [RECALL]** : Calls the recall menu to recall such as a setting data and calibration data of the R3765/3767H series. (Refer to sub-section 7.13.8.)
- [COPY]** : Calls the copy menu to execute the hard copy of screen for a plotter/printer. (Refer to section 7.14.)
- [SYSTEM]** : Calls the system menu to set such as an internal disk, date/time display and limit line. (Refer to sub-section 7.10.1.)
- [PRESET]** : Initializes the settings of the R3765/3767H series. (Refer to section 4.4.)

7.10.1 System Menu

The Setting and the Explanation

- ① Press the **[SYSTEM]** to call the system menu. (Refer to section A.4.)
- ② System menu
 - {SYSTEM DRIVE}* : Calls the system for selecting a drive to be used and format type of the disk. (See step ③.)
 - {SET CLOCK}* : Calls the real-time clock menu for setting a date/time. (See step ⑥.)
 - {LIMIT MENU}* : Calls the limit menu. (Refer to sub-section 7.11.1)
 - {MEAS SUB MENU}* : Calls the measure sub menu. (See step ⑦.)
 - {SERVICE MENU}* : Calls the service menu. (See step ⑧.)
- ③ System drive menu
 - {DEFAULT DRIVE}* : Calls the default drive menu.(See step ④.)
A drive selected on this menu is set as a current drive when power is turned on.
 - {FORMAT TYPE}* : Calls the disk format menu for selecting an initialize format type. (See step ⑤.)
- ④ Default drive menu
 - {A:}* : Selects the drive A.
Floppy disk drive
 - {B:}* : Selects the drive B.
RAM disk drive (Without backup)
 - {C:}* : Selects the drive C.
RAM disk drive (With backup)
 - {D:}* : Selects the drive D.
ROM disk drive (Read only)

7.10 INSTRUMENT STATE Block

- ⑤ Disk format menu
 - {1.2MB 8 SECTORS}* : Specifies the 1.2Mbyte 8 sectors per track when initializing a 2HD floppy disk. (Same as NEC PC9801 series, 2HD floppy disk format.)
 - {1.2MB 15 SECTORS}* : Specifies the 1.2Mbyte 15 sectors per track when initializing a 2HD floppy disk. (Same as TOSHIBA J3100 series, 2HD floppy disk format.)
 - {1.44MB 18 SECTORS}* : Specifies the 1.44Mbyte 18 sectors per track when initializing a 2HD floppy disk. (Same as IBM PC series, 2HD floppy disk format.)

- ⑥ Real-time clock menu
 - {YEAR}* : Sets a year.
 - {MONTH}* : Sets a month.
 - {DAY}* : Sets a day.
 - {HOUR}* : Sets an hour.
 - {MINUTE}* : Sets a minute.
 - {SECOND}* : Sets a second.

- ⑦ Measure sub menu
 - {A/R}* : Sets the input port to A/R.
 - {B/R}* : Sets the input port to B/R.
 - {A/B}* : Sets the input port to A/B.
 - {R}* : Sets the input port to R.
 - {A}* : Sets the input port to A.
 - {B}* : Sets the input port to B.

- ⑧ Service menu
 - {SERVICE MODES}* : Calls the service mode menu. (See step ⑨.)
 - {SET KEYBOARD 101/106}* : Selects the keyboard type.
101 is English keyboard and 106 is Japanese keyboard.
 - {FIRMWARE REVISION}* : Displays the firmware revision.

- ⑨ Service mode menu
 - {SOURCE CORR ON/OFF}* : Selects whether the frequency characteristic of signal source will be corrected or not.
 - {INPUT CORR ON/OFF}* : Selects whether the frequency characteristic of receiver block will be corrected or not.
 - {SOURCE PLL ON/OFF}* : It's used only for the performance test of the R3765/3767H series. (Refer to chapter 10.)

7.11 Limit Function

This function defines the segment for the measurement data, sets the upper limit and the lower limit for the segment, and judges pass/fail comparing with the data.

The limit can be set in each channel (CH1 and CH2) and in each sub-measure screen (CH3 and CH4) independently.

How to output the pass/fail judgement is as follows.

- PASS or FAIL is displayed on the screen.
- The beep can be set. When the limit test passes or fails, the beep sounds.
- Displays the trace in the Fail section with red.
- In the case of fail, sets Limit Fail Summary-Bit of Questionable Status Register.
- In the case of fail, set LOW Status on the parallel I/O port of the rear panel.

7.11.1 Limit Menu

The setting and the explanation

① Press **[SYSTEM]** to call the system menu. (Refer to section A.4.)

② Press **{LIMIT MENU}** to call the limit menu. (See step ③.)

③ Limit menu

- {LIMIT LINE ON/OFF}** : Selects ON or OFF in the display of limit line.
 When the limit line is set and this is in the state of ON, the limit line is displayed to compare the measurement data on the scale.
 The displays of the limit line are different depending on DISPLAY FORMAT and LIMIT TYPE of the segment.
 In the format of rectangular coordinate, ^ and v marks or lines (straight lines or horizontal lines) are put between break points of each segment.
 In the polar coordinates, circle or straight line showing the angle is drawn.
- {LIMIT TEST ON/OFF}** : Selects ON/OFF of the limit test.
 Under the limit test ON, the limit values and the data setting at each measurement point are compared.
 The limit test is performed when the data was updated during sweeping or after swept, or when the limit test was set to ON for the first time.
- {BEEP []}** : Calls the beep mode menu and sets the beep for the limit test. (See step ④.)

7.11 Limit Function

- {LIMIT MODE MENU}* : Calls the limit mode menu to control the limit test mode and select the limit type of polar coordinate format. (See step ⑤.)
 - {EDIT LIMIT LINE}* : Calls the edit limit menu (1 of 2) to display the list (Limit Table Window) of limit line segment in the lower half of the display to change the limit setting. (See step ⑥.)
 - {SELECT DATA 1ST/2ND}*: Switches the judgement parameter to operate. 2 parameters per channel can be specified for the judgement parameter.
In the display format of the rectangular coordinates, they corresponds to the first trace and the second trace.
In the display format of polar coordinates, they corresponds to the judgement parameters selected in LIMIT MODE MENU.
 - {LIMIT LINE OFFSETS}* : Calls the offset limit menu to adjust the stimulus value and the response value of the limit. (See step ⑩.)
- ④ Beep mode menu
- {OFF}* : Turns the beep off for the limit test.
 - {FAIL}* : Sounds the beep when the limit test detects fail.
 - {PASS}* : Sounds the beep when the limit test detects pass.
 - {BEEP TONE}* : Selects the beep tone from 0 to 7.
Zero indicates the lowest tone and the beep tone is proportional to the numeric value of 0 to 7.
- ⑤ Limit mode menu
- {1ST DATA ON/OFF}* : Sets the first parameter ON/OFF.
Judgement of the first parameter limit is performed when the LIMIT TEST is set to ON and also the 1ST DATA is set to ON.
 - {2ND DATA ON/OFF}* : Sets the second parameter ON/OFF.
Judgement of the second parameter limit is performed when the LIMIT TEST is set to ON and also the 2ND DATA is set to ON.
But the judgement is not performed if effective 2nd trace data does not exist in the display format of polar coordinates selected.
 - {MAG DATA LIN/LOG}* : The limit test of Smith chart and polar display is judged with MAG and PHASE.
Select whether this judgement is performed with LIN (linear scale) or LOG (logarithmic scale) of MAG DATA. (Default setting is LOG.)
This soft menu is effective only when the format (refer to sub-section 7.4.2) is of Smith chart or polar display.

⑥ Edit limit menu (1 of 2)

- {SEGMENT}* : Selects a segment number to edit.
Up to 31 segments can be set with starting number 0.
Up to 7 segments can be displayed at a time and scroll-
displayed on the Limit Table Window.
When no segment was set, 0 is displayed on the active
area, and in other cases, the next number to the last
specified segment is displayed.
But soon after the edit limit menu is called, the largest
number of the set segments is displayed.
Also the segment number is not updated after the last
segment was set.
- {SELECT DATA 1ST/2ND}*: Switches the judgement parameter to operate.
2 parameters per channel can be specified for the judge-
ment parameter.
In the display format of the rectangular coordinates, they
corresponds to the first trace and the second trace.
In the display format of the polar coordinates, they cor-
responds to the judgement parameters selected in LIM-
IT MODE MENU.
- {EDIT SEGMENT}* : Calls the edit segment menu to set and change the stimulus
value and upper/lower limit value of the specified segment.
(See step ③.)
If the Limit Table is empty, the segment with initial set-
ting is displayed.
Also, if an empty segment exists between the largest
current set segment and the specified segment, the
specified segment number is ignored.
In this case, the operation is the same as ADD SEG-
MENT soft key operation.
- {DELETE}* : Deletes the segment shown with a cursor >.
But if the specified segment is empty, this operation is
ignored.
- {ADD SEGMENT}* : Calls the edit segment menu to add a new segment at
the end of the Limit Table. In the new segment, initial
value is inputted. The initial value is the setting of
segment which was selected at SEGMENT and shown
with cursor.
- {LIMIT TYPE}* : Calls the limit type menu to select current segment type
selected with >. (See step ⑩.)
- {DONE}* : Sorts the input segments in ascending stimulus order
and returns to the limit menu.
The updated limit becomes effective by pressing DONE
soft key.
- {More 1/2}* : Calls the edit limit menu (2 of 2). (See step ⑦.)

7.11 Limit Function

⑦ Edit limit menu (2 of 2)

- {LIMIT LINE ON/OFF}* : Selects ON or OFF of the limit line display.
 When the limit line is set and this is in the state of ON, the limit line is displayed to compare the measurement data on the scale.
 The displays of the limit line are different depending on DISPLAY FORMAT and LIMIT TYPE of the segment.
 In the format of rectangular coordinates, \wedge and \vee marks or lines (straight lines or horizontal lines) are put between the break points of each segment.
 In polar coordinate, circle or straight line showing the angle is drawn.
- {LIMIT TEST ON/OFF}* : Selects ON/OFF of the limit test.
 Under the limit line ON, the limit values and the data are compared at each measurement point.
 The limit test is performed when the data was updated during sweeping or after swept, or when the limit test was set to ON for the first time.
- {BEEP []}* : Calls the beep mode to set the beep for the limit test. (See step ④.)
- {MAG DATA LIN/LOG}* : The limit test of Smith chart and polar display is judged with MAG and PHASE.
 Select whether this judgement is performed with LIN (linear scale) or LOG (logarithmic scale). (Default setting is LOG of MAG DATA.)
 This soft menu is effective only when the format (refer to sub-section 7.4.2.) is of Smith chart or polar display.
- {LIMIT MODE MENU}* : Calls the limit mode menu to control the limit test mode and selects the limit type of polar coordinates format. (See step ⑤.)
- {LIMIT LINE OFFSETS}* : Calls the offset limit menu to adjust the stimulus value and the response value of the limit. (See step ⑩.)
- {CLEAR LIST}* : Calls the clear limit menu to clear all the segments in the limit table. (See step ⑨.)

- ⑧ Edit segment menu
- {STIMULUS VALUE}* : Sets stimulus value of the segment with ENTRY block.
- {MARKER TO STIMULUS}*: Sets stimulus value of the segment with active marker. Turning the data knob moves the active marker right and left.
- {UPPER LIMIT}* : Sets the upper limit value of the segment.
It is necessary to set both values, upper limit and lower limit.
If the upper limit value is not required, set an extreme large value for the upper limit value.
Pressing *{UPPER LIMIT}* or *{LOWER LIMIT}* key changes limit values displayed on the screen into upper/lower expression, even if they are set with middle/delta values.
If a value smaller than the lower limit is input for the upper limit value or the reverse, the same values are set for both the limit values.
- {LOWER LIMIT}* : Sets the lower limit value of the segment.
It is necessary to set both values, upper limit and lower limit.
If the lower limit value is not required, set an extreme small value for the lower limit value.
- {DELTA LIMIT}* : Sets the limit width of the segment.
The limit width is expressed with the center value set by *{MIDDLE VALUE}*.
For example, to set the pass area within $-5\text{dB} \pm 3\text{dB}$, enter -5dB as the center value and 6dB as the delta value.
Pressing *{MIDDLE LIMIT}* or *{DELTA LIMIT}* key changes limit values displayed on the screen into upper/lower expression, even if they are set with DELTA/MIDDLE values.
- {MIDDLE VALUE}* : Sets the middle value of DELTA LIMIT.
- {MARKER TO MIDDLE}* : Sets the middle value to the active marker position.
- ⑨ Clear limit menu
- {CLEAR LIST YES}* : Clears the Limit Table and returns to the edit limit menu.
- {CLEAR LIST NO}* : Returns to the edit limit menu without clearing the Limit Table.

7.11 Limit Function

⑩ Limit type menu

- {SLOPING LINE}* : Connects to the limit value of the next segment break point with a sloped line.
For the final segment, horizontal lines are drawn to the largest point of stimulus.
For the display format of polar coordinates, the limit value is fixed up to the next segment break point.
In this case, the result is the same as flat line.
The slope line segment is displayed with SLIN in the Limit Table.
- {FLAT LINE}* : Horizontal lines are drawn up to the next segment break point.
The limit value is fixed up to the next segment if the next segment has different limit value.
For the final segment, horizontal lines are drawn to the largest point of stimulus.
Flat line segment is displayed with FLIN in the Limit Table.
- {SINGLE POINT}* : The judgement is performed at a single stimulus point.
The upper limit is displayed with V on the display, and the lower limit is displayed with ^.
The single point segment can be used for the terminal of flat line or sloping line.
Single point segment is displayed with SPO in the Limit Table.
- {LIMIT COLOR}* : Sets line color.
Color-to-setup number relationship is as follows.
2 ; Red
3 ; Purple
4 ; Green
5 ; Blue
6 ; Yellow
7 ; White
- {WAVE COLOR}* : Sets trace data color in Fail section.
The relationship of color-to-setup number is the same as above *{LIMIT COLOR}*.

⑪ Offset limit menu

- {STIMULUS OFFSET}* : Adds/subtracts offset value to/from stimulus value of all segments.
Input offset value by using ENTRY block.
- {AMPLITUDE OFFSET}* : Adds/subtracts offset value to/from amplitude value of all segments.
Input offset value by using ENTRY block.
- {MARKER TO AMP. OFS}* : Sets offset value of magnitude value by using the active marker.

7.12 GPIB Block

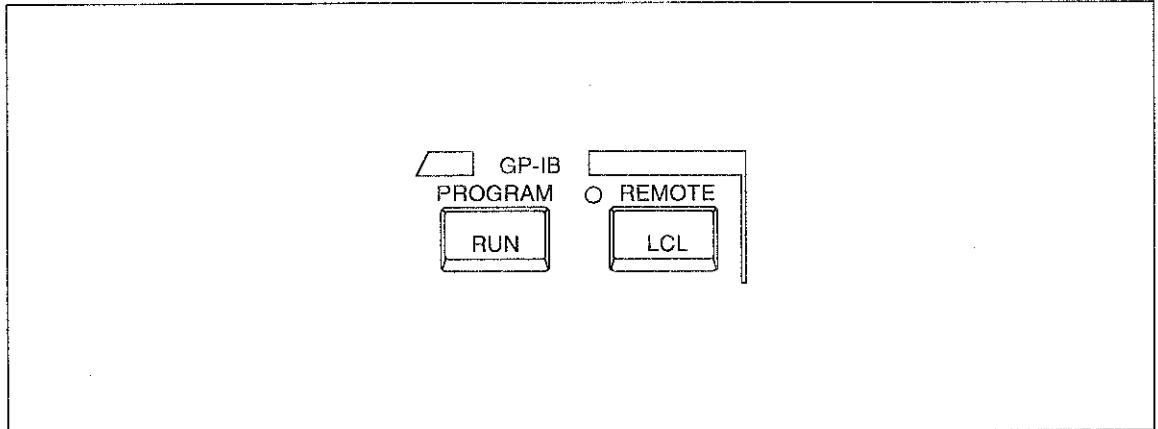

The GPIB block is used to set the controller function, GPIB bus and GPIB address. For procedure how to create a program, refer to the "programming manual" of the separate volume.

PROGRAM

[RUN] : Call the BASIC controller menu. (Refer to sub-section 7.12.1.)

REMOTE

[LCL] : Calls the GPIB menu. (Refer to sub-section 7.12.2.)

Moreover, when the R3765/3767H series is in the remote state by GPIB, it return back to the local state by pressing the key.

Note: *The operation key of all the panel key becomes disable in the remote state except this key.*

7.12 GPIB Block

7.12.1 Controller Menu

The setting and the explanation

- ① Press the **[RUN]** to call the controller menu. (Refer to section A.4.)
- ② Controller menu
 - {RUN}* : Starts a program.
 - {LOAD MENU}* : Displays a file list and calls the load menu. (See step ③.)
 - {LIST}* : Displays a program list.
 - {CLS}* : Clears the text display on the screen.
 - {CONT}* : Restarts a program from the next line immediately after program pauses.
 - {STOP}* : Stops a program.
- ③ Load menu
 - {LOAD}* : Loads the file specified by the cursor. Following the completion of load, returns to the controller menu. (See step ②.)
 - {CURSOR ↑}* : Shifts up the cursor used for specifying a file.
 - {CURSOR ↓}* : Shifts down the cursor used for specifying a file.
 - {DRIVE CHANGE}* : Calls the drive menu to change the current drive. (See step ④.)
- ④ Drive menu
 - {A:}* : Selects the drive A.
Floppy disk drive
 - {B:}* : Selects the drive B.
RAM disk drive (without backup)
 - {C:}* : Selects the drive C.
RAM disk drive (with backup)
 - {D:}* : Selects the drive D.
ROM disk drive (Read only)

7.12.2 GPIB Menu

The setting and the explanation

- ① Press the **[LCL]** to call the GPIB menu. (Refer to section A.4.)
- ② GPIB menu
 - {SYSTEM CONTROLLER}*: Sets the R3765/3767H series to the system controller.
 - {TALKER LISTENER}* : Sets the R3765/3767H series to the talker/listener.
 - {SET ADDRESSES}* : Calls the address menu used for setting the GPIB address. (See step ③.)
- ③ Address menu
 - {ADDRESS R3765H}* : Sets the GPIB address of the R3765/3767H series. (Note)
 - {ADDRESS PLOTTER}* : Sets the GPIB address of the plotter.
 - {ADDRESS PRINTER}* : Sets the GPIB address of the printer.

Note: *R3767H is displayed for R3767H series.*

7.13 Save/Recall

7.13 Save/Recall

By using an internal disk, the R3765/3767H series setting and the data saving/recalling (store/read) can be performed.

The following two methods for saving data are provided in accordance with informations to be saved and an internal disk.

- Save register : Saves the R3765/3767H series setting and calibration data into RAM disk (Drive C).
- Store file : Store the R3765/3767H series setting, calibration data and measurement data on a floppy disk.
All informations ; Drive A (floppy disk)

7.13.1 Selection of Save Type

The setting and the explanation

- ① Press the **[SAVE]** to call the save menu. (Refer to selection A.4.)
- ② Save menu
 - {SAVE REGISTER}* : Calls the save register menu. (Refer to sub-section 7.13.2.)
 - {CLEAR REGISTER}* : Calls the clear register menu used for clearing the stored save register. (Refer to sub-section 7.13.6.)
 - {STORE FILE}* : Calls the store file menu used for storing files or setting file names. (Refer to sub-section 7.13.3.)
The file list (Figure 7-5) will be displayed on the screen.
 - {PURGE FILE}* : Calls the purge file menu used for clearing the stored file. (Refer to sub-section 7.13.7.)
The file list (Figure 7-5) will be displayed on the screen.
 - {FORMAT DISK}* : Initializes a floppy disk inserted in drive A.

Note: Before *STORE FILE* or *PURGE FILE* is executed, be sure to insert a formatted floppy disk to the drive.

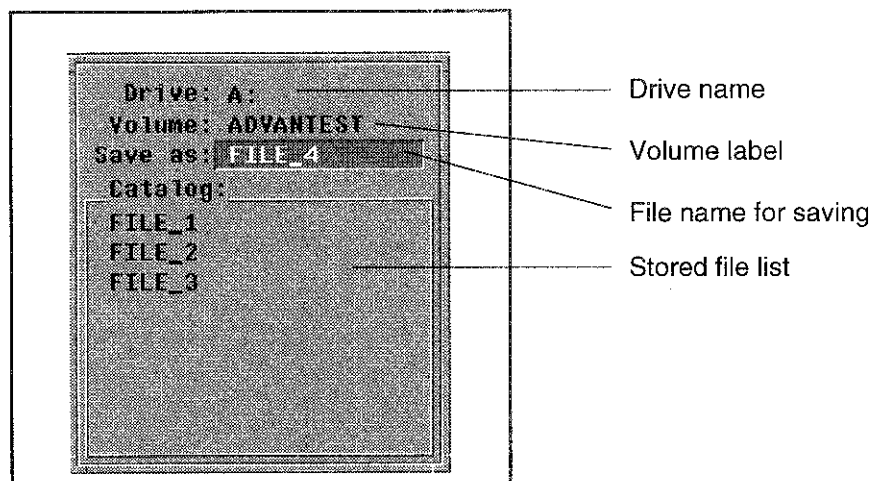

Figure 7-11 File List Display

7.13.2 Executing Save Register

Using the save register function, a maximum of 20 sets of measurement conditions and measurement data can be saved in the built-in memory in this network analyzer (each save register function saves a set of measurement conditions and measurement data).

The data is saved as a file in the built-in memory whose capacity is 1880 kB. Therefore, the total data cannot exceed this limit (this memory is shared with the C drive). If the total data exceeds its capacity, the data will not be saved (even if there is a register whose data has not yet been saved). In this case, the user must first erase the data already saved, then try to save them again.

Note: *When storing data into the save register, execute the save register operation after erasing data on the clear register menu. (Refer to sub-section 7.13.6.)*

The setting and the explanation

- ① Press the **[SAVE]** to call the save menu. (Refer to section A.4.)
- ② Press the **{SAVE REGISTER}** to call the save register menu.
- ③ Save register menu
 - Save register menu (1 of 4)

{SAVE REG-1}	: Saves the settings, calibration data and memory trace data into the register 1.
{SAVE REG-2}	: Saves the settings, calibration data and memory trace data into the register 2.
{SAVE REG-3}	: Saves the settings, calibration data and memory trace data into the register 3.
{SAVE REG-4}	: Saves the settings, calibration data and memory trace data into the register 4.
{SAVE REG-5}	: Saves the settings, calibration data and memory trace data into the register 5.

7.13 Save/Recall

- {RENAME REG}* : Calls the name editing menu used to define a register name. (Refer to sub-section 7.13.4.)
- Save register menu (2 of 4)
 - {SAVE REG-6}* : Saves the settings, calibration data and memory trace data into the register 6.
 - {SAVE REG-7}* : Saves the settings, calibration data and memory trace data into the register 7.
 - {SAVE REG-8}* : Saves the settings, calibration data and memory trace data into the register 8.
 - {SAVE REG-9}* : Saves the settings, calibration data and memory trace data into the register 9.
 - {SAVE REG-10}* : Saves the settings, calibration data and memory trace data into the register 10.
 - {RENAME REG}* : Calls the name editing menu used to define a register name. (Refer to sub-section 7.13.4.)
- Save register menu (3 of 4)
 - {SAVE REG-11}* : Saves the settings, calibration data and memory trace data into the register 11.
 - {SAVE REG-12}* : Saves the settings, calibration data and memory trace data into the register 12.
 - {SAVE REG-13}* : Saves the settings, calibration data and memory trace data into the register 13.
 - {SAVE REG-14}* : Saves the settings, calibration data and memory trace data into the register 14.
 - {SAVE REG-15}* : Saves the settings, calibration data and memory trace data into the register 15.
 - {RENAME REG}* : Calls the name editing menu used to define a register name. (See sub-section 7.13.4.)
- Save register menu (4 of 4)
 - {SAVE REG-16}* : Saves the settings, calibration data and memory trace data into the register 16.
 - {SAVE REG-17}* : Saves the settings, calibration data and memory trace data into the register 17.
 - {SAVE REG-18}* : Saves the settings, calibration data and memory trace data into the register 18.
 - {SAVE REG-19}* : Saves the settings, calibration data and memory trace data into the register 19.
 - {SAVE REG-20}* : Saves the settings, calibration data and memory trace data into the register 20.
 - {RENAME REG}* : Calls the name editing menu used to define a register name. (See sub-section 7.13.4.)

7.13.3 Executing Store File

The setting and the explanation

- ① Press the **[SAVE]** to call the save menu.
- ② Press the **{STORE FILE}** to call the store file menu.
- ③ Store file menu

{STORE}	:	Stores the setting data and calibration data as a file name for storing.
{ROLL ↑}	:] Shifts the cursor up/down of the saved file list.
{ROLL ↓}	:	
{DEFINE STORE}	:	Calls the file data menu used to select informations to be stored. (See step ④.)
{EDIT NAME}	:	Calls the character editing menu to define the file name for storing.
{NAME ↑}	:] Shifts the cursor up/down of the file name for storing.
{NAME ↓}	:	
{CANCEL}	:	Cancels the file store.
- ④ File data menu

When ON is selected, the data is stored. (Refer to Figure 9-1.)

{STATE ON/OFF}	:	Selects ON/OFF of setting conditions data storing.
{RAW ARRAY ON/OFF}	:	Selects ON/OFF of the raw data storing before formatting.
{CORR COEF ON/OFF}	:	Selects ON/OFF of the calibration data storing. When the calibration is performed, ON is automatically selected.
{DATA ARRAY ON/OFF}	:	Selects ON/OFF of the formatted data storing.
{MEM ARRAY ON/OFF}	:	Selects ON/OFF of the memory data storing.

7.13.4 Setting Register Name

The register name is used so that it can be searched easily. When recalling, the register is called as the named register set.

The setting and the explanation

- ① Press the **[SAVE]** to call the save menu. (Refer to senction A.4.)
- ② Press the **{SAVE REGISTER}** to call the save register menu.
- ③ Press the **{RENAME REG}** to display the label window and calls the name editing menu.
- ④ Name editing menu
 - {EDIT NAME}** : Displays the label window (Figure 7-12) and calls the character editing menu. (See step ⑤.)
 - {CURSOR ↑}** :] Shifts the cursor up/down of the register list (Figure 7-13)
 - {CURSOR ↓}** :] The register name of the cursor position can be edited.
- ⑤ Character editing menu
 - {DONE}** : Completes editing.
 - {CURSOR →}** : Shifts the label cursor right.
 - {CURSOR ←}** : Shifts the label cursor left.
 - {BACKSPACE}** : Executes the back space operation.
 - {DELETE CHAR}** : Deletes the character of the cursor position.
 - {CLEAR NAME}** : Clears all the characters (names).
 - {CANCEL}** : Cancels editing.

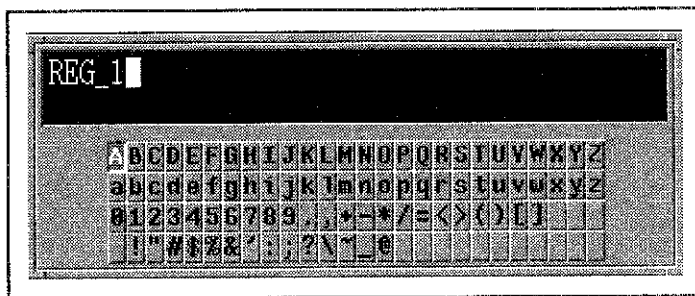

Figure 7-12 Label Window Display

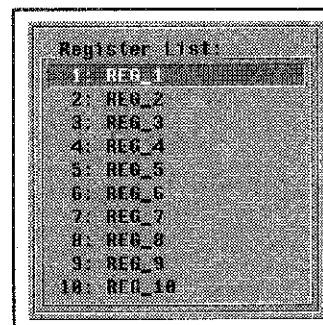

Figure 7-13 Register List Display

CAUTION!

The setting of register name is effective only for the saved register. If the name is set to the unsaved register and the power source is switched off without executing the saving, the set register name is not saved.

7.13.5 Setting File Name

The file name is used for searching so that it can be searched easily. When recalling, the file is called as the named file set.

The setting and the explanation

- ① Press the **[SAVE]** to call the save menu. (Refer to section A.4.)
- ② Press the **{STORE FILE}** to call the store file menu.
- ③ Press the **{NAME↑}**, **{NAME↓}** to select a desired file name.
- ④ Press the **{EDIT NAME}** to display the label window (Figure 7-12) and calls the character editing menu.
- ⑤ Character menu
 - {DONE}** : Completes editing.
 - {CURSOR →}** : Shifts the label cursor right.
 - {CURSOR ←}** : Shifts the label cursor left.
 - {BACKSPACE}** : Executes the back space operation.
 - {DELETE CHAR}** : Deletes the character of the cursor position.
 - {CLEAR NAME}** : Clears all the characters (names).
 - {CANCEL}** : Cancels editing.

CAUTION!

The setting of file name is effective only for the stored file.

If the name is set to the unstored file and the power source is switched off without executing the store, the set file name is not stored.

7.13.6 Clearing Saved Register

Clears registers.

When the register name is defined, the defined register name is displayed on the menu.

The setting and the explanation

- ① Press the **[SAVE]** to call the save menu. (Refer to section A.4.)
- ② Press the **{CLEAR REGISTER}** to call the clear register menu.
- ③ Clear register menu
 - Clear register menu (1 of 4)
 - {CLEAR REG-1}** : Clears the register 1.
 - {CLEAR REG-2}** : Clears the register 2.
 - {CLEAR REG-3}** : Clears the register 3.
 - {CLEAR REG-4}** : Clears the register 4.
 - {CLEAR REG-5}** : Clears the register 5.
 - Clear register menu (2 of 4)
 - {CLEAR REG-6}** : Clears the register 6.
 - {CLEAR REG-7}** : Clears the register 7.
 - {CLEAR REG-8}** : Clears the register 8.
 - {CLEAR REG-9}** : Clears the register 9.
 - {CLEAR REG-10}** : Clears the register 10.
 - Clear register menu (3 of 4)
 - {CLEAR REG-11}** : Clears the register 11.
 - {CLEAR REG-12}** : Clears the register 12.
 - {CLEAR REG-13}** : Clears the register 13.
 - {CLEAR REG-14}** : Clears the register 14.
 - {CLEAR REG-15}** : Clears the register 15.
 - Clear register menu (4 of 4)
 - {CLEAR REG-16}** : Clears the register 16.
 - {CLEAR REG-17}** : Clears the register 17.
 - {CLEAR REG-18}** : Clears the register 18.
 - {CLEAR REG-19}** : Clears the register 19.
 - {CLEAR REG-20}** : Clears the register 20.

7.13.7 Purging Stored File

Purges files.

When the file name is defined, the defined file name is displayed on the menu.

The setting and the explanation

① Press the **[SAVE]** to call the save menu. (Refer to section A.4.)

② Press the **{PURGE FILE}** to call the purge file menu.

③ Purges files menu

{PURGE} : Purges the file.

{CURSOR ↑} :] Shifts the cursor up/down of file list.
{CURSOR ↓} :]

* The file of the cursor position can be purged.

7.13.8 Executing Recall

Recalls register or file.

When the register/file name is defined, the defined name is displayed on the menu.

The setting and the explanation

① Press the **[RECALL]** to call the recall menu. (Refer to section A.4.)

② Recall menu

• Recall menu (1 of 4)

{RECALL REG-1} : Recalls the setting data, calibration data and memory trace data saved in the register 1.

{RECALL REG-2} : Recalls the setting data, calibration data and memory trace data saved in the register 2.

{RECALL REG-3} : Recalls the setting data, calibration data and memory trace data saved in the register 3.

{RECALL REG-4} : Recalls the setting data, calibration data and memory trace data saved in the register 4.

{RECALL REG-5} : Recalls the setting data, calibration data and memory trace data saved in the register 5.

{RECALL POWER OFF} : The settings are stored automatically when the power of the R3765/67H series is turned off. When the power is turned on again, the data is set to the initial state. By pressing this key, the stored data is read again.

{LOAD FILE} : Calls the load file menu used to load the all informations stored in the file. (See step ③ and Figure 7-11.)

Note: Before **LOAD FILE** is executed, be sure to insert a formatted floppy disk to the drive.

7.13 Save/Recall

- Recall menu (2 of 4)
 - {RECALL REG-6}* : Recalls the setting data, calibration data and memory trace data saved in the register 6.
 - {RECALL REG-7}* : Recalls the setting data, calibration data and memory trace data saved in the register 7.
 - {RECALL REG-8}* : Recalls the setting data, calibration data and memory trace data saved in the register 8.
 - {RECALL REG-9}* : Recalls the setting data, calibration data and memory trace data saved in the register 9.
 - {RECALL REG-10}* : Recalls the setting data, calibration data and memory trace data saved in the register 10.
 - {RECALL POWER OFF}* : The settings are stored automatically when the power is turned off. When the power is turned on again, the data is set to the initial state. By pressing this key, the stored data is read again.
 - {LOAD FILE}* : Calls the load file menu used to load the all informations stored in the file. (See step ③ and Figure 7-11.)

- Recall menu (3 of 4)
 - {RECALL REG-11}* : Recalls the setting data, calibration data and memory trace data saved in the register 11.
 - {RECALL REG-12}* : Recalls the setting data, calibration data and memory trace data saved in the register 12.
 - {RECALL REG-13}* : Recalls the setting data, calibration data and memory trace data saved in the register 13.
 - {RECALL REG-14}* : Recalls the setting data, calibration data and memory trace data saved in the register 14.
 - {RECALL REG-15}* : Recalls the setting data, calibration data and memory trace data saved in the register 15.
 - {RECALL POWER OFF}* : The settings are stored automatically when the power is turned off. When the power is turned on again, the data is set to the initial state. By pressing this key, the stored data is read again.
 - {LOAD FILE}* : Calls the load file menu used to load the all informations stored in the file. (See step ③ or Figure 7-11.)

- Recall menu (4 of 4)

{RECALL REG-16} : Recalls the setting data, calibration data and memory trace data saved in the register 16.

{RECALL REG-17} : Recalls the setting data, calibration data and memory trace data saved in the register 17.

{RECALL REG-18} : Recalls the setting data, calibration data and memory trace data saved in the register 18.

{RECALL REG-19} : Recalls the setting data, calibration data and memory trace data saved in the register 19.

{RECALL REG-20} : Recalls the setting data, calibration data and memory trace data saved in the register 20.

{RECALL POWER OFF} : The settings are stored automatically when the power is turned off. When the power is turned on again, the data is set to the initial state. By pressing this key, the stored data is read again.

{LOAD FILE} : Calls the load file menu used to load the all informations stored in the file. (See step ③ or Figure 7-11.)

③ Load file menu

{LOAD} : Loads all informations stored in the file.

{CURSOR ↑}
{CURSOR ↓} :  Shifts the cursor up/down of file list.

Note: *The file of the cursor position can be recalled.*

{Return} : Makes the control return to the recall menu.

Note: *If a file stored with RAW ARRAY or DATA ARRAY ON is loaded, the sweep becomes HOLD without reservation.*

7.14 Hard Copy

7.14 Hard Copy

Hard copy of the screen data can be output to a plotter and a graphic printer. The plotter outputs from GPIB and the printer outputs from GPIB or RS-232. The bitmap file can be output to the floppy disk.

When GPIB is to be used, set the R3765/3767H series to the system controller in the GPIB block, furthermore, specify GPIB address of the printer and the plotter. (Refer to sub-section 7.12.2.)

The setting and the explanation

- ① Press the **[COPY]** to call the copy menu. (Refer to section A.4.)
- ② Copy menu
 - {PRINT}** : Executes hard copy to the printer.
 - {PLOT}** : Executes hard copy to the plotter. (Note)
 - {ABORT}** : Aborts the hard copy operation. Continued operation cannot be performed.
 - {SELECT QUADRANT}** : Calls the plot scale menu used to select the size and location of the hard copy. (See step ③ of sub-section 7.14.1.)
 - {DEFINE PLOT}** : Calls the plot data menu used to define the items for hard copy operation. (See step ③ of sub-section 7.14.2.)
 - {CONFIGURE PLOT}** : Calls the plotter pen menu used to select pen number and data-line type to be used. (See step ③ of sub-section 7.14.3.)
 - {PRINT/PLOT SETUP}** : Calls the setup menu used to set up the setting of printer or plotter. (See step ③ of sub-section 7.14.4.)

Note: *In using the plotter of HP company, the indication of the error such as error lamp lighting will be occasionally done.*

7.14.1 Setting Plot Scale

Specifies the output position and the size for plotting on A4 size paper.

The setting and the explanation

- ① Press the **[COPY]** to call the copy menu. (Refer to section A.4.)
- ② Press the **{SELECT QUADRANT}** to call the plot scale menu.
- ③ Plot scale menu
 - {FULL PAGE}** : Selects the plot scale to output one data on A4 size paper with full page.
 - {LEFT}** : Selects the plot scale to output data to the left position by dividing A4 size paper into two blocks.
 - {RIGHT}** : Selects the plot scale to output data to the right position by dividing A4 size paper into two blocks.
 - {LEFT UPPER}** : Selects the plot scale to output data to upper left position by dividing A4 size paper into four blocks.
 - {LEFT LOWER}** : Selects the plot scale to output data to lower left position by dividing A4 size paper into four blocks.
 - {RIGHT UPPER}** : Selects the plot scale to output data to upper right position by dividing A4 size paper into four blocks.
 - {RIGHT LOWER}** : Selects the plot scale to output data to lower right position by dividing A4 size paper into four blocks.

(Hard copy example)

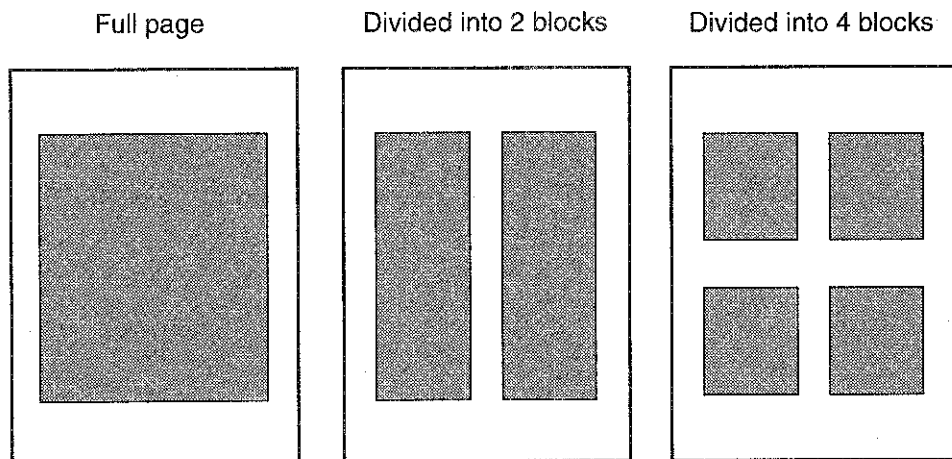

7.14 Hard Copy

7.14.2 Selecting Plot Data

Selects items to be hard-copied.

Since the items to be set in this menu are independent to the channels, they are set to the active channel only.

The setting and the explanation

- ① Press the **[COPY]** to call the copy menu. (Refer to section A.4.)
- ② Press the *{DEFINE PLOT}* to call the plot data menu.
- ③ Plot data menu
 - {PLOT DATA ON/OFF}* : Sets ON/OFF of the measurement data output.
 - {PLOT MEMORY ON/OFF}* : Sets ON/OFF of the memory data output.
 - {PLOT GRATICULE ON/OFF}*: Sets ON/OFF of the coordinate output.
 - {PLOT TEXT ON/OFF}* : Sets ON/OFF of the text data output.
 - {PLOT MARKER ON/OFF}* : Sets ON/OFF of the marker data output.
 - {PLOT REF LINE ON/OFF}* : Sets ON/OFF of the reference line output.

Note: *When both the text data output and the marker data output are set to ON, the output of the marker list and filter analysis result is also set.*

7.14.3 Specifying Pen

Selects the pen number and line type to be used.

The setting and the explanation

- ① Press the **[COPY]** to call the copy menu. (Refer to section A.4.)
- ② Press the *{CONFIGURE PLOT}* to call the plotter pen menu.
- ③ Plotter pen menu
 - {PEN NUM DATA}* : Specifies the pen number of the measurement data.
 - {PEN NUM MEMORY}* : Specifies the pen number of the memory data.
 - {PEN NUM GRATICULE}* : Specifies the pen number of the coordinate data.
 - {PEN NUM TEXT}* : Specifies the pen number of the text data.
 - {PEN NUM MARKER}* : Specifies the pen number of the marker data.
 - {LINE TYPE DATA}* : Selects the line type of the measurement data.
 - {LINE TYPE MEMORY}* : Selects the line type of the memory data.
 - The selection of the line type is as follows.
 - 0 ; Solid line
 - 1 ; Dotted line
 - 2 ; Dashed line
 - 3 ; Chain line

7.14.4 Plotter Setup

The setting and the explanation

- ① Press the [COPY] to call the copy menu. (Refer to section A.4.)
- ② Press the {PRINT/PLOT SETUPS} to call the setup menu.
- ③ Setup menu
 - {PRINTER} : Calls the printer setting menu. (Refer to sub-section 7.14.5.)
 - {PRINT SPEED FAST/SLOW} : Selects FAST/SLOW of printer speed. (Refer to sub-section 7.14.5.)
 - {PLOT LABEL ON/OFF} : Selects ON/OFF of the label and real-time clock output.
 - {PLOT P.TXT ON/OFF} : Sets ON/OFF of output of the characters which have been written on the screen using the controller function.
 - {DEFAULT SETUPS} : Returns all the copy menu to the initial settings.
 - {PLOTTER HP/AT} : Selects the HP or AT plotter.

Note: In using the plotter of HP company, the indication of the error such as error lamp lighting will be occasionally done.

- ④ Setting R9833 DIP switches

The DIP switches should be set to the standard values as shown in Figure 7-14. These switched are used to set the initial conditions at powering on and the interface conditions.

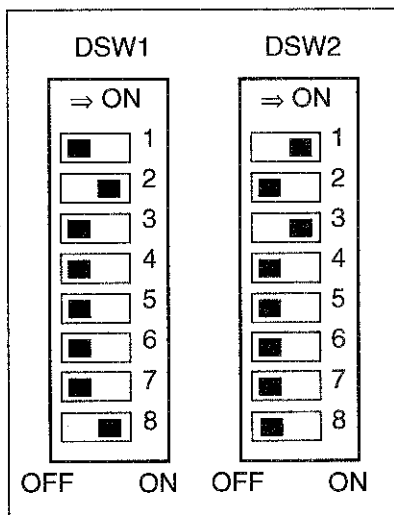

- DSW1 :
 - HP mode when SW No.8 is ON.
 - FP-GL mode when SW No.8 is OFF.
 - In AT mode, it is required to set OFF SW No.8 and ON SW No.4. (Refer to Table 7-3.)
- DSW2 :
 - Sets the plotter address to 5. (Refer to Table 7-4.)

Figure 7-14 Setting DIP Switches

Table 7-3 DSW1 Function

SW No.	Functions (ON = 1)	Standards																		
1 to 3	Paper size setting (SW3 = 0) (SW3 = 1)	SW1 = 0 SW2 = 1 SW3 = 0 A4 long side way																		
	<table border="1"> <thead> <tr> <th>SW1</th> <th>SW2</th> <th>ISO/JIS</th> <th>ANSI</th> </tr> </thead> <tbody> <tr> <td>0</td> <td>0</td> <td>A3 maximum width and depth</td> <td>B maximum width and depth</td> </tr> <tr> <td>1</td> <td>0</td> <td>A3 long vertical way direction filling up</td> <td>B long vertical way direction filling up</td> </tr> <tr> <td>0</td> <td>1</td> <td>A4 long side way direction filling up</td> <td>A long side way direction filling up</td> </tr> <tr> <td>1</td> <td>1</td> <td>A4 long vertical way direction filling up</td> <td>A long vertical way direction filling up</td> </tr> </tbody> </table>		SW1	SW2	ISO/JIS	ANSI	0	0	A3 maximum width and depth	B maximum width and depth	1	0	A3 long vertical way direction filling up	B long vertical way direction filling up	0	1	A4 long side way direction filling up	A long side way direction filling up	1	1
SW1	SW2	ISO/JIS	ANSI																	
0	0	A3 maximum width and depth	B maximum width and depth																	
1	0	A3 long vertical way direction filling up	B long vertical way direction filling up																	
0	1	A4 long side way direction filling up	A long side way direction filling up																	
1	1	A4 long vertical way direction filling up	A long vertical way direction filling up																	
4	Setting rotational coordinates 1 : rotational coordinates ON	0																		
5	Selection of unit length for step number 0 : normal 1 : switch	0																		
6	Paper detection disable 0 : with paper detection function 1 : not with paper detection function	0																		
7	Switching input buffer capacity 1 : maximum (12KB) 0 : 1KB	0																		
8	FP-GL-I/FP-GL-II select 1 : FP-GL-I 0 : FP-GL-II	1																		

Table 7-4 DSW2 Function

SW No.	Functions (ON = 1)	Standards			
1 to 5	Plotter addresssetup: Defines the device address with all bits.	SW1 = 1 SW2 = 1 SW3 = 1 SW4 = 1 SW5 = 1			
	Bit structure <table border="1" style="margin-left: 40px;"> <tr> <td>SW5</td> <td>SW4</td> <td>SW3</td> <td>SW2</td> <td>SW1</td> </tr> </table> Address 31 is for listen only mode.		SW5	SW4	SW3
SW5	SW4	SW3	SW2	SW1	
6	Selection of EOI signal control 0 : EOI disabled 1 : EOI enabled However, available only when using FP-GL-II. Not defined for FP-GL-I.	0			
7	Not defined	0			
8	Selection of reduced drawing mode (only when using FP-GL-II). 1 : Selects reduced drawing mode (0.9 time)	0			

7.14 Hard Copy

If EOI signal is set to ON (enable) and EOI terminal receives "L" when using FP-GL-II, the plotter operates in the same manner as the terminator.
 When the plotter sends data, EOI terminal is set to "L" at the same time as it outputs the last "LF" code of sending data.
 If the reduced drawing mode is selected when using FP-GL-II, the plotter outputs the drawing being reduced to 0.9 time, based on the global origin.
 Then, the actual size of the valid drawing range is not changed and the range to be specified by the program is extended.

7.14.5 Printer Setup

The setting and the explanation

- ① Press the **[COPY]** to call the copy menu. (Refer to section A.4.)
- ② Press the *{PRINT/PLOT SETUPS}* to call the setup menu.
- ③ Setup menu
 - {PRINTER}* : Selects the printer. (see step ④.)
 - {PRINT SPEED FAST/SLOW}* : Switches print speeds.
In the printer of EPSON makes the screen smaller.
 - {PLOT LABEL ON/OFF}* : Selects ON/OFF of the label and real-time clock output.
 - {PLOT P.TXT ON/OFF}* : Sets ON/OFF of output of the characters which have been written on the screen using the controller function.
 - {DEFAULT SETUPS}* : Returns all the copy menu to the initial setting.
 - {PLOTTER HP/AT}* : Selects the HP or AT plotter.
- ④ Printer setup menu
 - {HP ThinkJet}* : Selects Think Jet the printer of HP company.
 - {EPSON ESC/P}* : Selects a printer which supports the printer control code EPSON ESC/P J83 or J84 of the Seiko-Epson's 24-dot printer.
If the printer supports both the RS-232 and GPIB interfaces, the printer can be connected using either the RS-232 or GPIB cable (Note1).
 - {PCL}* : Selects a printer which supports the Hewlett Packard printer control code PCL . Color printing, however, is not available since this code does not support color ink.
If the printer supports both the RS-232 and GPIB interfaces, the printer can be connected using either the RS-232 or GPIB cable (Note2).
 - {BITMAP FILE}* : Screen data can be saved to a floppy disk after converting it into Window 3.1 bitmap format files.
The bitmap files are saved one by one to the floppy disk, after each file has been given its filename (such as PRINT000.BMP, PRINT001.BMP, etc.). Each file is 300 kB, and up to four files can be stored on a floppy disk.

{PRINTER PORT GPIB} : Outputs the screen data via the GPIB.

{PRINTER PORT RS-232} : Outputs the screen data via the RS-232

Note1: *Do not connect a Centronix-made printer to the parallel port on the R3765/67H series network analyzer because the power supply pin arrangement is different from that of the Centronix-made printer.*

Note2: *Verify that the CTS control is available when a serial-interface printer is used. In addition, neither the XON nor XOFF control are supported by the network analyzer. When using the XON or XOFF control, there is a possibility that satisfactory print quality will not result due to its transfer speed.*

- **INPUT 1**
By entering a negative pulse on the INPUT 1, the OUTPUT 1 and 2 are set to LOW. The pulse width of the input signal to be entered in the INPUT 1 should be more than 1 μ s.
- **OUTPUT 1 and 2**
These two signal lines are the latch output terminals set to LOW when a negative pulse is entered on the INPUT 1. It can be set to LOW or HIGH with the BASIC command (OUTPUT).
- **PASS/FAIL output**
Generates LOW when the result of the limit test is PASS and HIGH when the result is FAIL. This function is available only when the limit test function is ON.
- **Write strobe output for PASS/FAIL output**
When the limit test result is output to the PASS/FAIL output line, generates a negative pulse.
- **SWEEP END**
When the R3765/3767H series finishes the sweeping, generates a negative pulse with a width of 10 μ s.
- **+5V output**
+5V output is provided for the external device. The maximum current to be supplied is 100mA. This line has a fuse which will be blown when overcurrent flows for circuit protection. The blown fuse needs to be replaced.
- **EXT TRIG input**
By entering a negative pulse on this line, it is possible to trigger the sweep of measurement. The pulse width should be at least 1 μ s. The sweeping starts at the trailing edge of the pulse. When this signal line is used, the trigger mode should be set to external source.

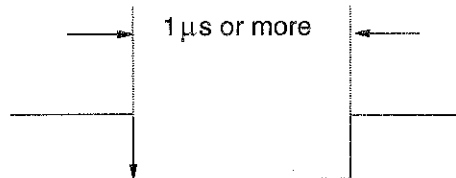

7.15 Communication with Peripheral Devices

(2) Parallel I/O connector pin assignment and signal standard

Pin No.	Signal name	Function
1	GND	Ground
2	INPUT 1	Negative logic pulse input of TTL level (width:1 μs or more)
3	OUTPUT 1	Negative logic latch output of TTL level
4	OUTPUT 2	Negative logic latch output of TTL level
5	Output port A0	Negative logic latch output of TTL level
6	Output port A1	Negative logic latch output of TTL level
7	Output port A2	Negative logic latch output of TTL level
8	Output port A3	Negative logic latch output of TTL level
9	Output port A4	Negative logic latch output of TTL level
10	Output port A5	Negative logic latch output of TTL level
11	Output port A6	Negative logic latch output of TTL level
12	Output port A7	Negative logic latch output of TTL level
13	Output port B0	Negative logic latch output of TTL level
14	Output port B1	Negative logic latch output of TTL level
15	Output port B2	Negative logic latch output of TTL level
16	Output port B3	Negative logic latch output of TTL level
17	Output port B4	Negative logic latch output of TTL level
18	EXT TRIG	EXTERNAL TRIGGER input (width : 1 μs or more), negative logic
19	Output port B5	Negative logic latch output of TTL level
20	Output port B6	Negative logic latch output of TTL level
21	Output port B7	Negative logic latch output of TTL level
22	Input/output port C0	Negative logic state input/latch output of TTL level
23	Input/output port C1	Negative logic state input/latch output of TTL level
24	Input/output port C2	Negative logic state input/latch output of TTL level
25	Input/output port C3	Negative logic state input/latch output of TTL level
26	Input/output port D0	Negative logic state input/latch output of TTL level
27	Input/output port D1	Negative logic state input/latch output of TTL level
28	Input/output port D2	Negative logic state input/latch output of TTL level
29	Input/output port D3	Negative logic state input/latch output of TTL level
30	Port C status	TTL level, Input mode: LOW, Output mode: HIGH
31	Port D status	TTL level, Input mode: LOW, Output mode: HIGH
32	Write strobe signal	TTL level, Negative logic, Pulse output
33	PASS/FAIL signal	TTL level, PASS: LOW, FAIL: HIGH, latch output
34	SWEEP END signal	TTL level , Negative logic, Pulse output (width:10 μs or more)
35	+5V	+5V ± 10%, 100mA MAX
36	Write strobe signal (PASS/FAIL)	TTL level, Negative logic, Pulse output

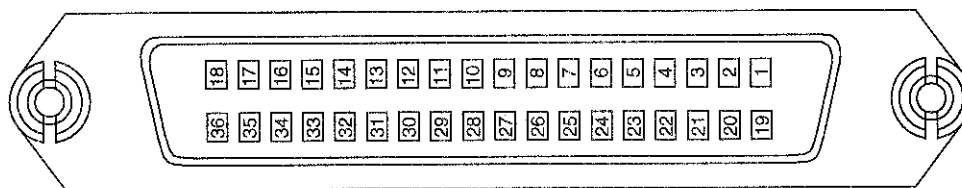

When there's no connection, except for GND, they have high impedance.

Figure 7-16 Parallel I/O (36-pin) Connector Pin Assignment and Signal

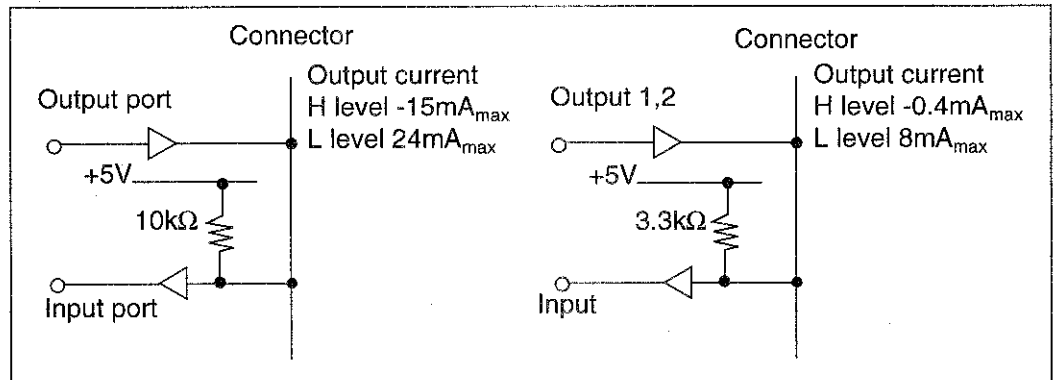

Figure 7-17 Schematic Circuit Diagram of Parallel I/O Port

(3) Mode setting of port

Command	Output port	Input port
OUTPUT 36 ; 16	A, B, C, D	
OUTPUT 36 ; 17	A, B, D	C
OUTPUT 36 ; 18	A, B, C	D
OUTPUT 36 ; 19	A, B	CD

To use a parallel I/O port, first set the mode setting of port. The combination of the setting command and the Input/Output port is referred the above table.

(Example)

```
10 OUTPUT 36;19
20 OUTPUT 33;255
30 ENTER 37;A
```

Set the output port for port A and port B, and the input port for port CD.

(4) Each port operation method

Describes the operation method by built-in BASIC.

OUTPUT statement (for output) and ENTER statement (for input) are used for data input/output.

In the BASIC command (OUTPUT and ENTER statements), each port is distinguished by the address used in the statement.

(a) BASIC format

```
OUTPUT (address) ; (output data)
ENTER (address) ; [variable]
                    (Input data are assigned to specified variable.)
```

7.15 Communication with Peripheral Devices

(b) Address and data range

Address	Port to be used
33	Port A (Output only: OUTPUT statement only)
34	Port B (Output only: OUTPUT statement only)
35	Port C (Input/output : ENTER, OUTPUT)
36	Port D (Input/output : ENTER, OUTPUT)
37	Port CD (Input/output : ENTER, OUTPUT)

- OUTPUT 33, 34, 37
OUTPUT x x ; 0 to 255 (8-bit)
- OUTPUT 35, 36
OUTPUT x x ; 0 to 15 (4-bit)
* The OUTPUT 35 concerns with the Set/Reset of Flip Flop.
- ENTER 35, 36
ENTER x x ; numeric variable (4-bit) (Data from 0 to 15 are assigned.)
- ENTER 37
ENTER 37 ; numeric variable (8-bit) (Data from 0 to 255 are assigned.)

(5) INPUT 1, OUTPUT 1 and OUTPUT 2 Terminals

By combining with the signal lines of INPUT 1, OUTPUT 1 and OUTPUT 2, convenient functions are provided to easily control external devices.

The functions are; function which sets two latch outputs of OUTPUTs 1 and 2 to LOW by pulse input to INPUT 1, and function which detects the state of OUTPUT 1 by INPUT 1.

Also, the state of OUTPUTs 1 and 2 can be controlled by OUTPUT command.

(a) Setting and Resetting of OUTPUT 1 and OUTPUT 2

The following four types are provided for set/reset as follows:

- Setting OUTPUT 1 : OUTPUT 35 ; 16
- Setting OUTPUT 2 : OUTPUT 35 ; 48
- Resetting OUTPUT 1 : OUTPUT 35 ; 80
- Resetting OUTPUT 2 : OUTPUT 35 ; 112

(b) INPUT 1 (external input)

The state of OUTPUT 1 can be observed by INPUT 1 using ENTER statement.

ENTER 34; (numeric variable)

If 1 is assigned to the numeric variable, OUTPUT 1 is ON (Low level: negative logic), if 0, OUTPUT 1 is OFF (High level).

```
Example : 10 OUTPUT 36 ; 16
          20 ENTER 34 ; A
          30 IF A<> 1 THEN GOTO 20
          40 OUTPUT 33 ; 1
```

By observing the state of OUTPUT 1, if OUTPUT 1 is set to ON, then 1 is output to the port A.

7.15 Communication with Peripheral Devices

① Examples of INPUT 1, OUTPUT 1 and OUTPUT 2

< When program is executed by trigger switch >

- Circuit example

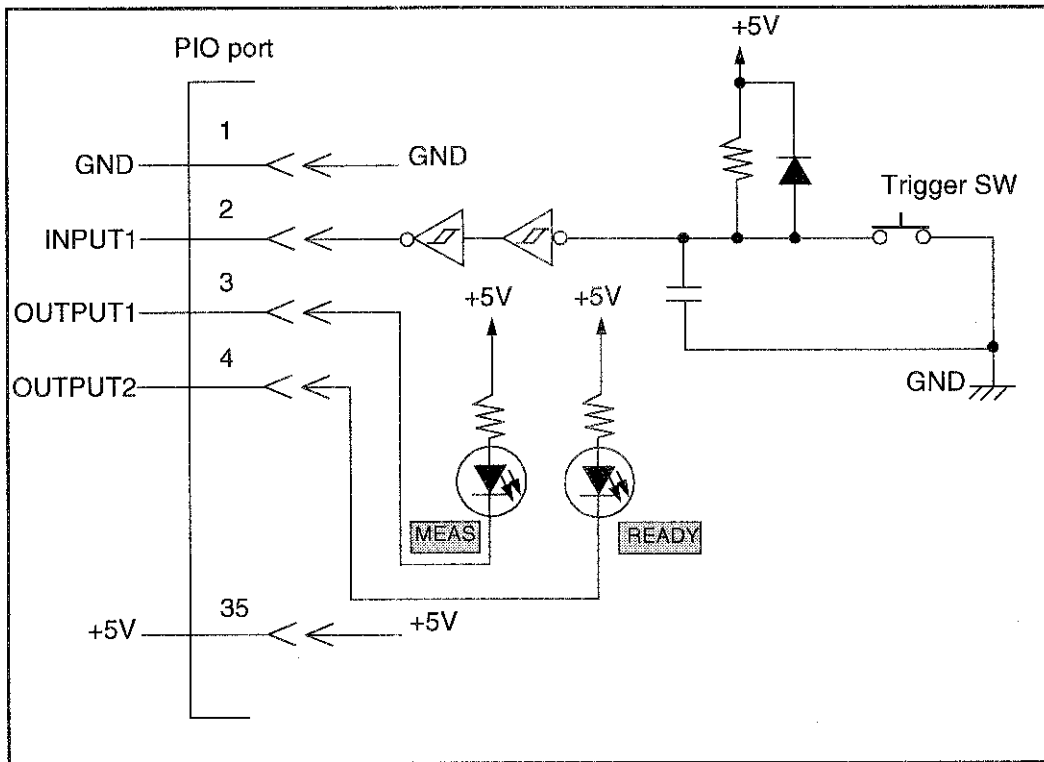

- Program example

```

10  OUTPUT 35 ; 80 )
20  OUTPUT 35 ; 112 )
  ⋮
  ⋮
100 OUTPUT 35 ; 48
110 ENTER 34 ; A
120 IF A <> 1 THEN GOTO 110 )
130 OUTPUT 35 ; 112
  ⋮
  ⋮
500 OUTPUT 35 ; 80
510 GOTO 100
520 STOP
    
```

Waiting time for measurement: Represents [READY].

During measurement operation: Represents [MEAS].

[READY], [MEAS] turns OFF.

Network analyzer initial setup
[READY] turns ON.

Recognition of Trigger SW
[READY] turns OFF.

Measurement routine
[MEAS] turns OFF.

When repeating the measurement

② Usage example of output ports A and B

< When LED is used for selecting devices (when port A is used) >

• Circuit example

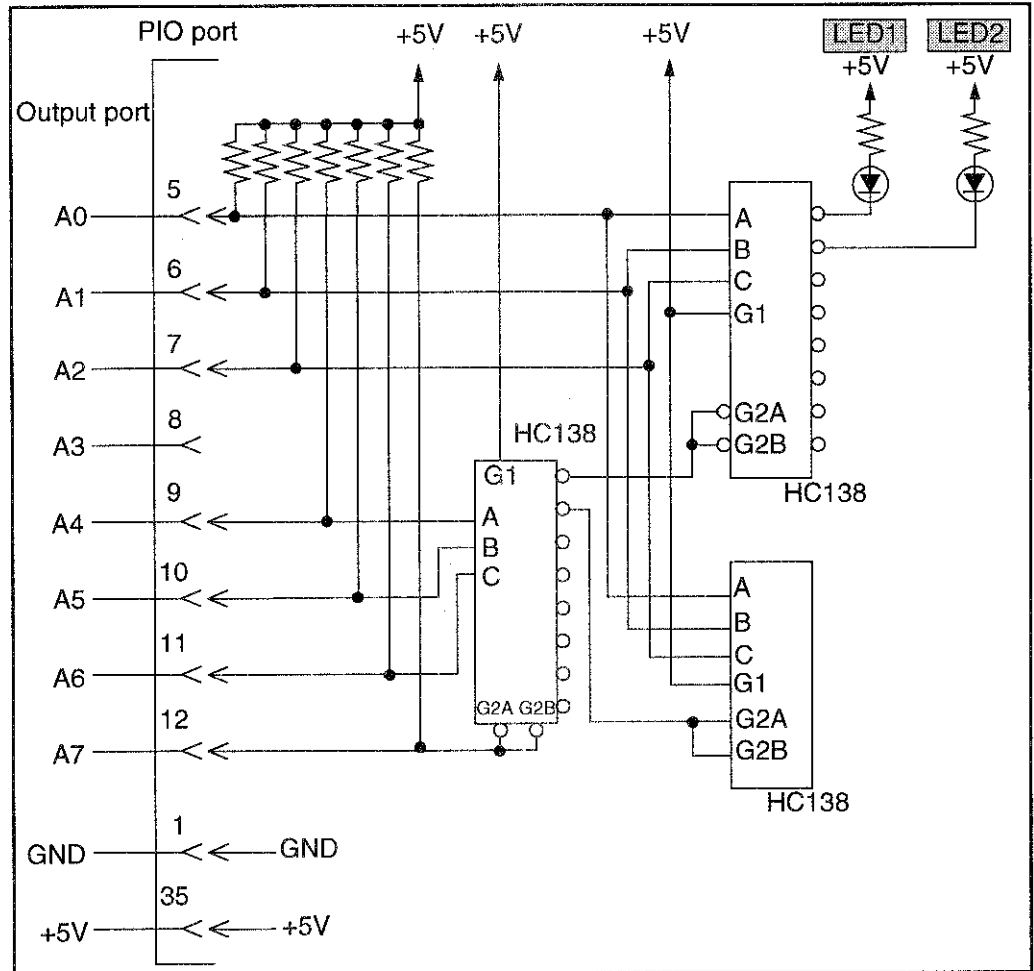

• Program example

```

10  OUTPUT 36 ; 16      Defines ports A, B, C and D as output port.
20  OUTPUT 33 ; 0      Initializes LED.
30
:
:      Measurement and judgment <measurement variable: A>
:      (Judgment range: JED0 to JED1, JED1 to JED2...)
500 IF A>=JED0 AND A<JED1 THEN OUTPUT 33 ; 0xFF
:      (When JED0 to JED1, lights up LED 1.)
510 F A>=JED1 AND A<JED2 THEN OUTPUT 33 ; 0xFE
:      (When JED1 to JED2, lights up LED 2.)
:
:
800 GOTO 30
810 STOP
    
```

7.15 Communication with Peripheral Devices

③ Usage example of input/output ports C and D

< Example to change routine whether bit-0 of I/O port C is 0 or 1 >

- Circuit example

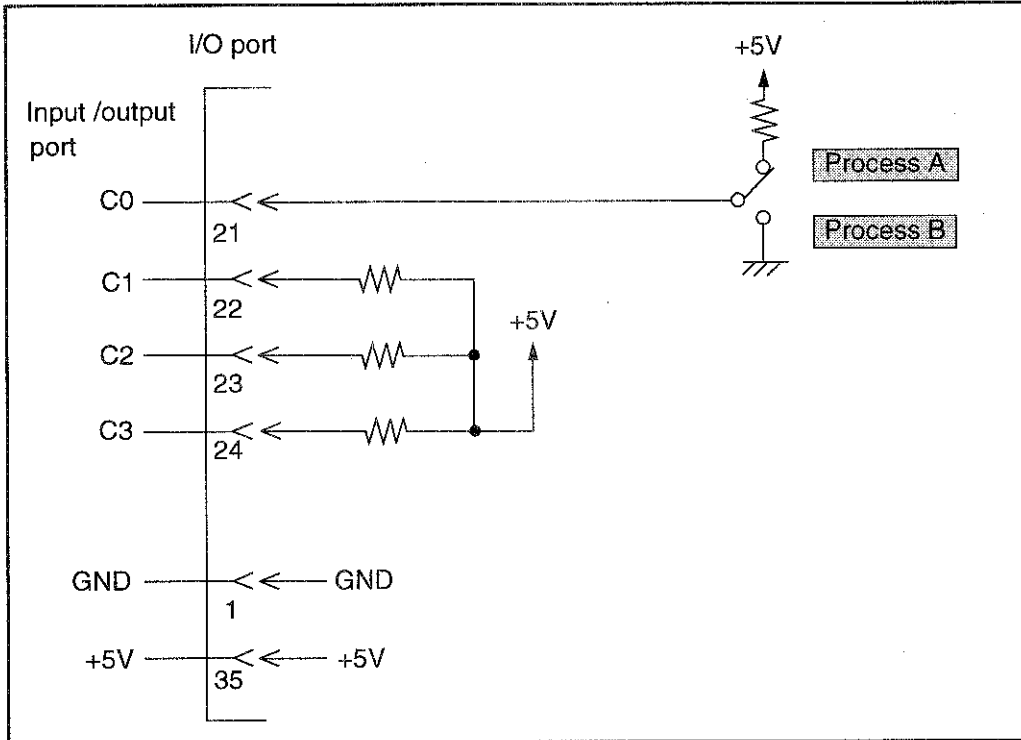

- Program example (Check the port C by pressing "Trigger SW" in example ①.)

```

10  OUTPUT 36 ; 19           Defines ports A and B as output port.
20  OUTPUT 35 ; 80         Defines ports C and D as input port.
30  OUTPUT 35 ; 112
   :
100 *TRIG
110 ENTER 34 ; A
120 IF A <> 1 THEN GOTO *TRIG
130 ENTER 35 ; B           Obtains value of port C.
140 IF B = 1 THEN GOTO *ROUT_B
150 *ROUT_A
   :                       Process A
490 GOTO *TRIG
500 *ROUT_B
   :                       Process B
900 GOTO *TRIG
910 STOP
    
```

7.15.2 RS-232 Interface

The R3765/3767H series is equipped with an RS-232 interface as a standard. Therefore, data such as measurement and analysis data can be output to an RS-232 printer.

The RS-232 interface defines mechanical and electrical characteristics of interface for connecting between data terminal and data communication device standardized by Electronic Industries Association (EIA).

Refer to "Regulation" for details.

(1) Connection connector and signal table

Connection connector : 25-pin D-sub connector (male type)

Signal table

Pin No.	Signal name	Description
1	FG	Frame Ground
2	TxD	Transmit Data
3	RxD	Receive Data
4	RTS	Request To Send
5	CTS	Clear To Send
6	DSR	Data Set Ready
7	SG	Signal Ground
20	DTR	Data Terminal Ready

(2) Printer output method

The LLIST or LPRINT command is used to output to the RS-232 printer by the R3765/3767H series. The setting such as a baud rate is defined by the CONTROL command.

Refer to "Programming manual" for details.

LLIST : Outputs BASIC program to the printer.

LPRINT : Outputs the contents of character strings, numeric values and variables.

CONTROL : Sets the values such as a baud rate, character length and others.

The setup value on power-up is as follows.

Baud rate : 9600 baud

Character length : 8-bit

Parity : None

Stop bit : 1-bit

8 IN ABNORMALITIES

Read this chapter when the R3765/3767H series becomes abnormal.

8.1 Inspection and Simple Troubleshooting

If the R3765/3767H series becomes abnormal, check the following items before asking for repair. When the trouble cannot be resolved by the following countermeasures, contact a nearby ADVANTEST Sales Office. The addresses and the phone numbers are mentioned at the end of this manual.

The fare will be charged on the user even for a repair as shown in the table below.

Symptom	Assumed cause	Remedy
The power cannot be turned on.	Power cable is not surely inserted in the connector.	Turn the power switch OFF, and re-connect the power cable.
	Power fuse is blown.	Replace power fuse.
No trace appears on the screen.	BACK LIGHT is set to OFF.	Press the BACK LIGHT to switch ON.
	Input cable or connector is loose.	Re-connect the input cable or connector.
Does not sweep.	Setting of the trigger is SINGLE.	Set to CONTINUOUS.
The measured result is incorrect.	The calibration was not performed correctly.	Execute the calibration meeting the measurement.
Key does not work.	In GPIB remote control mode.	When a program is being executed, stop it and press LCL key.
Data cannot be read (recalled) from floppy disk.	Floppy disk defect.	Check operation with other floppy disk.
	FDD (Floppy disk drive) defect.	Ask ADVANTEST for repair.
	Not set to A:drive.	Set it to A:drive
Data cannot be recorded (saved) in floppy disk.	The floppy disk is not initialized.	Initialize the floppy disk.
	The write protect is enabled.	Release the write protect.
	Not set to A:drive.	Set it to A:drive.

8.2 Error Messages

8.2 Error Messages

This chapter explains the error messages displayed on the screen.

(1) Types of error message

- ① Hardware trouble (Refer to sub-section 8.2.1.)
- ② Notice of hardware information (Refer to sub-section 8.2.2.)
- ③ Operating error (Refer to sub-section 8.2.3.)
- ④ Warning of the change of internal setting and the like (Refer to sub-section 8.2.4.)
- ⑤ Notice of the completion of an operation, the operating state and the like (Refer to sub-section 8.2.5.)

(2) Error message display

- The message is displayed on the fixed position of the liquid crystal display. Therefore the message is overwritten and only the last message is displayed.
- The message does not disappear until some panel key is pressed. However, the messages in ① and ② disappear when the R3765/3767H series is returned from the state.
- The messages of ④, ⑤ and ⑥ are not displayed during GPIB command operation (including BASIC).

(3) Error message, the cause and the solving method

Explains in the following error message table.

8.2.1 Hardware Trouble

<p><u>Cooling Fan Stop.</u> <u>Please Power OFF.</u></p>	<p>Cooling fan stopped. Please power OFF. <How to handle> Contact ADVANTEST sales office.</p>
--	---

8.2.2 Notice of Hardware Information

<p><u>Ach Overload</u> <u>Bch Overload</u></p>	<p>Overlevel is input into A channel. Overlevel is input into B channel. <How to handle> Check the input signal level.</p>
<p><u>External Standard In.</u> <u>External Trigger Ignored.</u></p>	<p>An external reference signal has been input. An input external trigger was ignored. (That does not mean a prohibiting state.) <How to handle> An external trigger (PIO-18pin) has been input in a state of not waiting for the external trigger. The state of waiting for the external trigger is the state of waiting for sweep in the external trigger mode (that is, in a state that TRIGGER[CONT] or TRIGGER[SINGLE] on the panel). If next trigger pulse is input during a sweep in using an external trigger source, the above error occurs. Check the trigger setting and the specification of an external trigger signal.</p>

8.2 Error Messages

8.2.3 Operating Error

<p><u>Already Memorized.</u></p>	<p>Memorizing calibration data which {<i>DONE</i>} operation was already executed was attempted. <How to handle> Clear the already-memorized calibration data with CLEAR CAL DATA. (Refer to sub-section 7.5.10.)</p>
<p><u>Calibration aborted.</u></p>	<p>Memorizing calibration data was aborted. <How to handle> While calibration data is being memorized, if the setting is changed, the calibration is aborted. Do not change the setting until the calibration is finished. (Refer to sub-section 7.5.5 and 7.5.6.)</p>
<p><u>Calibration canceled.</u></p>	<p>The acquired calibration data was cleared because the sweeping conditions were changed during calibration operated. <How to handle> The sweeping conditions must not be changed to acquire more than two calibration data. Execute the calibration data acquisition from the first. (Refer to sub-section 7.5.5.)</p>
<p><u>Calibration data not found.</u></p>	<p>CORRECT ON was executed without memorized calibration data. <How to handle> Memorize the calibration data. (Refer to sub-section 7.5.5.)</p>
<p><u>Can't ... When CORRECT ON.</u></p>	<p>To memorize calibration data or to execute CLEAR CAL DATA was attempted in the state of CORRECT ON. <How to handle> Choose CORRECT OFF. (Refer to sub-section 7.5.10.)</p>
<p><u>Can't ... When PROG-SWEEP.</u></p>	<p>To set the number of points or to clear segments was attempted in the state of PROGRAM SWEEP. <How to handle> Specify a sweep type other than PROGRAM SWEEP and USER SWEEP. (Refer to section 7.9.)</p>
<p><u>Can't ... When USER-SWEEP.</u></p>	<p>To set the number of points or to clear segments was attempted in the state of USER SWEEP. <How to handle> Specify a sweep type other than PROGRAM SWEEP and USER SWEEP. (Refer to section 7.9.)</p>

Operating Error

<p><u>Can't find plotter !!!</u></p>	<p>A plotter was not found in a plot output. <How to handle> The plotter is not connected or GPIB address of the plotter is not correct. (Refer to sub-section 7.12.2.)</p>
<p><u>Data and Coef not matched.</u></p>	<p>CORRECT ON was to be executed under a condition differing from the measurement condition under which the correction data was acquired. <How to handle> Specify the same measurement condition as the one under which the correction data was acquired. (Refer to sub-section 7.5.5 and 7.5.6.)</p>
<p><u>Data and Memory not matched.</u></p>	<p>Trace operation (DATA/MEM, etc.) or memory trace display (DISPLAY MEMORY, DISPLAY DATA/MEM) were to be executed under a condition differing from the measurement condition under which the memory trace was acquired. <How to handle> Specify the same measurement condition as the one under which the memory trace was acquired. (Refer to sub-section 7.4.4 and 7.4.6.)</p>
<p><u>Disk not found.</u></p>	<p>A floppy disk could not be found in one of the operations LOAD MENU, STORE FILE or DATA FILE of the R3765/3767H series. <How to handle> ① The floppy disk has some scratches. ② It's not formatted. ③ It's not inserted in the drive. Check the floppy disk. (Refer to section 6.3, sub-section 7.10.1, 7.12.1, 7.13.3 and 7.13.8.)</p>
<p><u>Duplicate name.</u></p>	<p>The same name that has already been edited or a reserved name is input with the [SAVE] → {STORE FILE} → {EDIT NAME} key in the R3765/3767H series. <How to handle> Input a different name. (Refer to sub-section 7.13.1, 7.13.3, 7.13.4 and 7.13.5.)</p>

8.2 Error Messages

Operating Error

<p><u>File load error.</u></p>	<p>An error occurred in a <i>{LOAD FILE}</i> execution. <How to handle> Something is wrong with the floppy disk, or a file other than files stored in the R3765/3767H series was specified. Check the floppy disk. (Refer to sub-section 7.13.8.)</p>
<p><u>File store error.</u></p>	<p>An error occurred in a <i>{STORE FILE}</i> execution. <How to handle> ① The floppy disk has no available space. ② It's not formatted. ③ It's in the state of write protection. Check the floppy disk. (Refer to sub-section 7.13.3.)</p>
<p><u>Formatting Failure.</u></p>	<p>Something was wrong in the formatting operation. <How to handle> ① The floppy disk has some scratched. ② It's in the state of write protection. Check the floppy disk. (Refer to section 7.13.)</p>
<p><u>Illegal PROG-SWEEP points.</u></p>	<p>With the number of total points of all segments being less than 3 or more than 1201, the program sweep was specified. <How to handle> Specify the number of the segment point again. (Refer to sub-section 7.9.2.)</p>
<p><u>Illegal USER-SWEEP points.</u></p>	<p>With the number of total points of all segments being less than 3 or more than 1201, the user frequency sweep was specified. <How to handle> Specify the number of the segment point again. (Refer to sub-section 7.9.2.)</p>

Operating Error

<p><u>Memory not found.</u></p>	<p>A trace operation (DATA/MEM, etc.) or a memory trace display (DISPLAY MEMORY, DISPLAY DATA&MEM) was specified, with a memory trace not stored. <How to handle> Obtain the memory trace. (Refer to sub-section 7.4.4 and 7.4.7.)</p>
<p><u>None Controller.</u></p>	<p>A plot output was specified not in system controller mode. <How to handle> Set to the system controller mode. (Refer to sub-section 7.12.2.)</p>
<p><u>Now plotting !!!</u></p>	<p>Another plot output was specified in the course of executing a plot output. <How to handle> Until the current plot output is completed, the following plot can not be executed. Wait until the current plot output is completed. (Refer to section 7.14.)</p>
<p><u>Please set 1-trace FORMAT.</u></p>	<p>With the measurement format two traces (LOGMAG&PHASE, LOGMAG&DELAY, LOGMAG&PHASE), the memory trace display (DISPLAY MEMORY, DISPLAY DATA&MEM) was specified. <How to handle> The memory trace display is invalid with the measurement format two traces. Set the measurement format to one trace (other than LOGMAG&PHASE, LOGMAG&DELAY or LOGMAG&PHASE). (Refer to sub-section 7.4.2 and 7.4.4.)</p>
<p><u>Register recall error.</u></p>	<p>An error occurred in recalling a register. <How to handle> ① An unsaved register was specified. ② The register was damaged. Clear the register with CLEAR REG and save it again. (Refer to sub-section 7.13.8.)</p>

8.2 Error Messages

Operating Error

<p><u>Register save error.</u></p>	<p>An error occurred in saving a register. <How to handle> Available space is not in C: drive. Delete unnecessary files. (Refer to section 7.13.)</p>
<p><u>Segment #x error.</u></p>	<p>The PROGRAM SWEEP or USER SWEEP was specified in a state that STOP FREQ of the Xth segment is higher than START FREQ of the following segment. <How to handle> Specify the frequency of the Xth segment again. (Refer to sub-section 7.9.2 and 7.9.3.)</p>
<p><u>Segment not entered.</u></p>	<p>The PROGRAM SWEEP or USER SWEEP was specified without setting any segment. <How to handle> Specify the segment. (Refer to sub-section 7.9.2 and 7.9.3.)</p>
<p><u>Some STD not memorized.</u></p>	<p>To execute the DONE operation was attempted without obtaining all related calibration data. <How to handle> Obtain all calibration data (OPEN, SHORT, LOAD). (Refer to sub-section 7.5.5.)</p>
<p><u>Can't ... When Sub Trace ON.</u></p>	<p>The measurement format was to be set to two traces (LOGMAG & PHASE, LOGMAG & DELAY or LINMAG & PHASE) in the state that the InputMeas setting was S_{11} & S_{21} or S_{22} & S_{12}. <How to handle> When the InputMeas setting is S_{11} & S_{21} or S_{22} & S_{12}, the measurement format cannot be set to two traces (LOGMAG & PHASE, LOGMAG & DELAY or LINMAG & PHASE). Change the InputMeas. (Refer to sub-section 7.4.1 and 7.4.4.)</p>

8.2.4 Warning of Internal Set, Change, etc.

<p><u>STIMULUS changed.</u></p>	<p>By the CORRECT ON setting, STIMULUS set value was changed internally to the one at the time the calibration acquired. However, only when INTERPORATE OFF setting. (Refer to section 7.3)</p>
<p><u>CORRECT turned off.</u></p>	<p>The CORRECT setting was internally altered to OFF. <How to handle> The measuring condition in which the correction data was obtained must be the same as the current measuring condition in the correcting measurement (CORRECT ON). Therefore, when the number of points or a sweep type is altered in a state of CORRECT ON, this message is displayed and CORRECT OFF is set. (Refer to sub-section 7.5.5.)</p>
<p><u>CORR or MEM can't be saved.</u></p>	<p>Correction data and memory trace data could not be saved by the save register operation. <How to handle> In the save register, the correction data is saved in C:drive and the memory trace data is saved in B:drive. If available space is not in the drive, this message is displayed. (However, the setting condition in this case is saved.) Clear unnecessary register. (Refer to section 7.13.)</p>
<p><u>Data file can't be stored.</u></p>	<p>The trace data (RAW, COEF, MEM, DATA) was not able to be saved with STORE FILE. <How to handle> Available space is not in A:drive (floppy disk). (However, the setting condition of the R3765/3767H series is saved.) Clear unnecessary files or use another floppy disk. (Refer to sub-section 7.13.3.)</p>

8.2 Error Messages

Warning of Internal Set, Change, etc.

<p><u>Display Mode changed.</u></p>	<p>The display mode setting was internally altered to DISPLAY DATA. <How to handle> In the memory trace display (DISPLAY MEMORY, DISPLAY DATA&MEM), the measuring condition under which the memory trace was acquired must be the same as the current measuring condition and the measuring format must be set to one trace. Therefore, when the number of points or the sweep type is altered in a state that the memory trace is displayed, or when the measuring format is set to two traces (LOGMAG&PHASE, LOGMAG&DELAY or LINMAG&PHASE), this message is displayed and the display mode is altered to DISPLAY DATA internally. (Refer to sub-section 7.4.4.)</p>
<p><u>Sweep time increased.</u></p>	<p>The setting of the sweep time was internally altered and the sweep time was increased. <How to handle> The minimum setting value of the sweep time is decided according to the RBW setting, etc. When the sweep time is set to AUTO, this message is not displayed. Therefore, when the sweep time is not set to AUTO, if this message is displayed by altering the setting of the RBW or and the sweep time is increased. Afterward, even if the RBW setting is set to the previous setting, the sweep time setting do not be set back to the previous setting. (Refer to sub-section 7.9.3.)</p>
<p><u>Trace-Math turned off.</u></p>	<p>The setting of the trace operation (DATA+MEM and others) was internally altered to OFF. <How to handle> The measuring condition in which the memory trace was obtained must be the same as the current measuring condition in the trace operation. Therefore, when the number of points or the sweep type was altered with the trace operation executed, this message is displayed and the trace operation is set to OFF. (Refer to sub-section 7.4.7.)</p>

Warning of Internal Set, Change, etc.

<p><u>FORMAT changed.</u></p>	<p>Setting of the measurement format is changed internally (to LOGMAG). <How to handle> When the setting of InputMeas is S_{11}&S_{21} or S_{22}&S_{12}, the measurement format cannot be set to 2 traces (LOGMAG& PHASE, LOGMAG&DELAY or LINMAG&PHASE). Therefore, when the measurement format is in the state of 2 traces and furthermore InputMeas is set to S_{11}&S_{21} or S_{22}&S_{12}, this message is displayed and the measuring format is changed to LOGMAG internally. (Refer to sub-section 7.4.1 and 7.4.4.)</p>
<p>Z0 VALUE changed.</p>	<p>Setting of Z_0 VALUE is changed internally. <How to handle> Changing the setting of CAL KIT is interlocked to the setting of Z_0 VALUE. For N (50Ω) or 3.5mm, 50Ω For N (75Ω), 75Ω. (Refer to sub-section 7.5.7 and section A.4.)</p>

8.2 Error Messages

8.2.5 Completed Operation Conditions Messages

<u>Abort PLOT !!!</u>	The plot output was interrupted by pushing the { <i>ABORT</i> } key, [PRESET] key or [STOP] key.
<u>Clear Completed.</u>	The memorized calibration data was cleared with CLEAR CAL DATA.
<u>Formatting now ...</u>	The floppy disk is now under formatting.
<u>Formatting completed.</u>	Formatting the floppy disk was correctly complete.
<u>Store completed.</u>	A trace data was copied into a memory trace with { <i>DATA → MEMORY</i> }.
<u>Wait for sweep.</u>	A sweep is being executed to obtain the calibration data.
<u>Please wait, STORING FILE ...</u>	STORE FILE is in execution.
<u>Please wait, LOADING FILE ...</u>	LOAD FILE is in execution.
<u>Please wait, PURGING FILE ...</u>	PURGE FILE is in execution.
<u>STORE FILE completed !</u>	STORE FILE completed normally.
<u>LOAD FILE completed !</u>	LOAD FILE completed normally.
<u>PURGE FILE completed !</u>	PURGE FILE completed normally.

9 PRINCIPLE

This chapter explains about the basic operation of the R3765/3767H series in flow charts.

9.1 Principle

(1) Signal source block

R3765H series output the total output signal of 40MHz to 3.8GHz from 4.44GHz to 8.2GHz synthesizer and 4.4GHz fixed- signal generator.

R3767H series output the total output signal of 40MHz to 3.8GHz from 4.44GHz to 8.2GHz synthesizer and 4.4GHz fixed-signal generator, and the output signal of 3.8GHz to 8.0GHz from the synthesizer directly.

The range of output level is decided according to AH, BH, and CH type as follows.
Also the range of output level can be changed by adding option 10 (output attenuator) 0dB to 70dB ATT.

The leveling of 3.8GHz to 8.0GHz is not performed.
The leveling can be done by option 11 (8GHz output AMP).

Type		40MHz to 3.8GHz	3.8GHz to 8.0GHz
R3765	AH	+17dBm to - 8dBm	—
	BH	+ 7dBm to -18dBm	—
	CH	+10dBm to -15dBm	—
R3767	AH	+17dBm to -8dBm	Fixed value of over 0dBm *
	BH	+15dBm to -10dBm	Fixed value of over 0dBm *
	CH	+10dBm to -15dBm	Fixed value of over -10dBm *
R3767 (with option 11)	AH	+17dBm to - 8dBm	+17dBm to - 8dBm
	BH	+15dBm to -10dBm	+ 7dBm to -18dBm
	CH	+10dBm to -15dBm	+10dBm to -15dBm

* : The leveling is not performed.

(2) Receiver block

- ① The input signal of 40MHz to 3.8GHz (for R3767H series, to 8.0GHz) is converted to 820kHz IF signal with the Sampler and input into the Mixer.
- ② 1st IF signal is converted to 20kHz 2nd IF signal with the Mixer and output to A/D circuit.
- ③ A/D processed data is performed high speed arithmetic processing with digital signal processor (DSP) and displayed in the display section.

9.2 Data Flow

The signal input into the receiver section is processed according to the following flow.

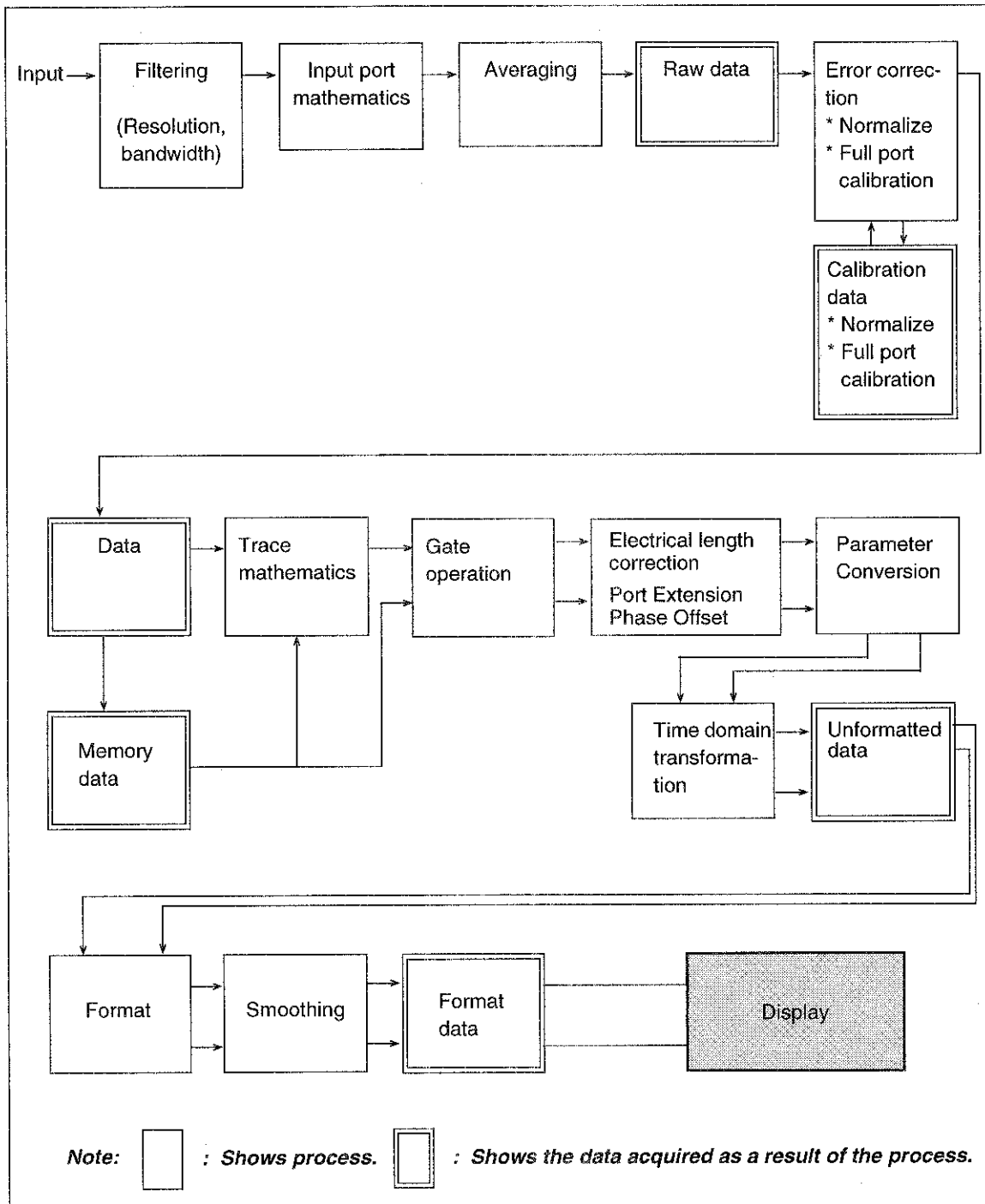
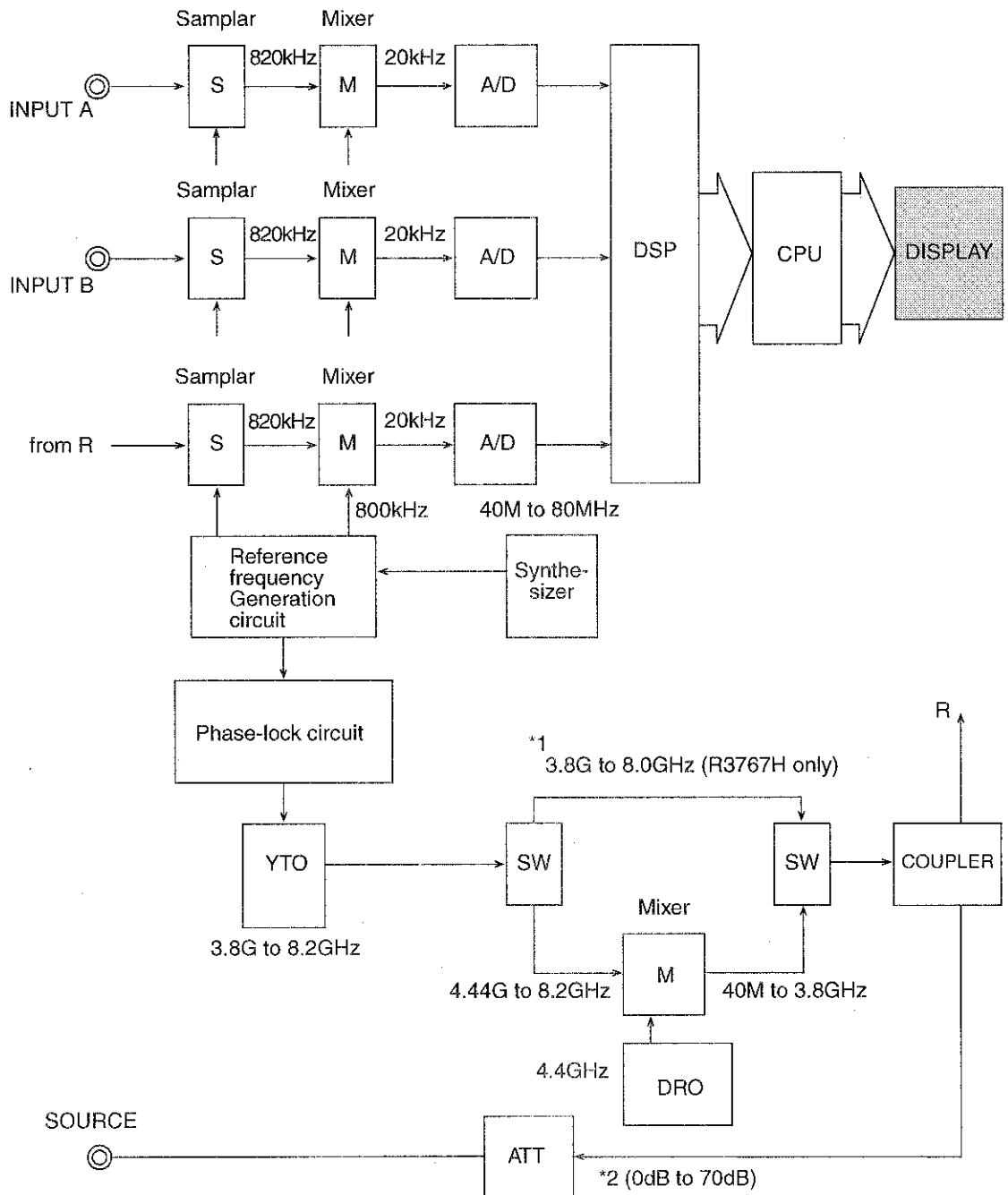

Figure 9-1 Data Flow

9.3 Block Diagram

Shows block diagram for each type, AH type, BH type and CH type.

9.3.1 R3765AH/3767AH Diagrammatic Sketch of Block



*1 : Leveling is possible with option 11 (8G output AMP).

*2 : Option 10 (output attenuator)

9.3 Block Diagram

9.3.2 R3765BH/3767BH Diagrammatic Sketch of Block

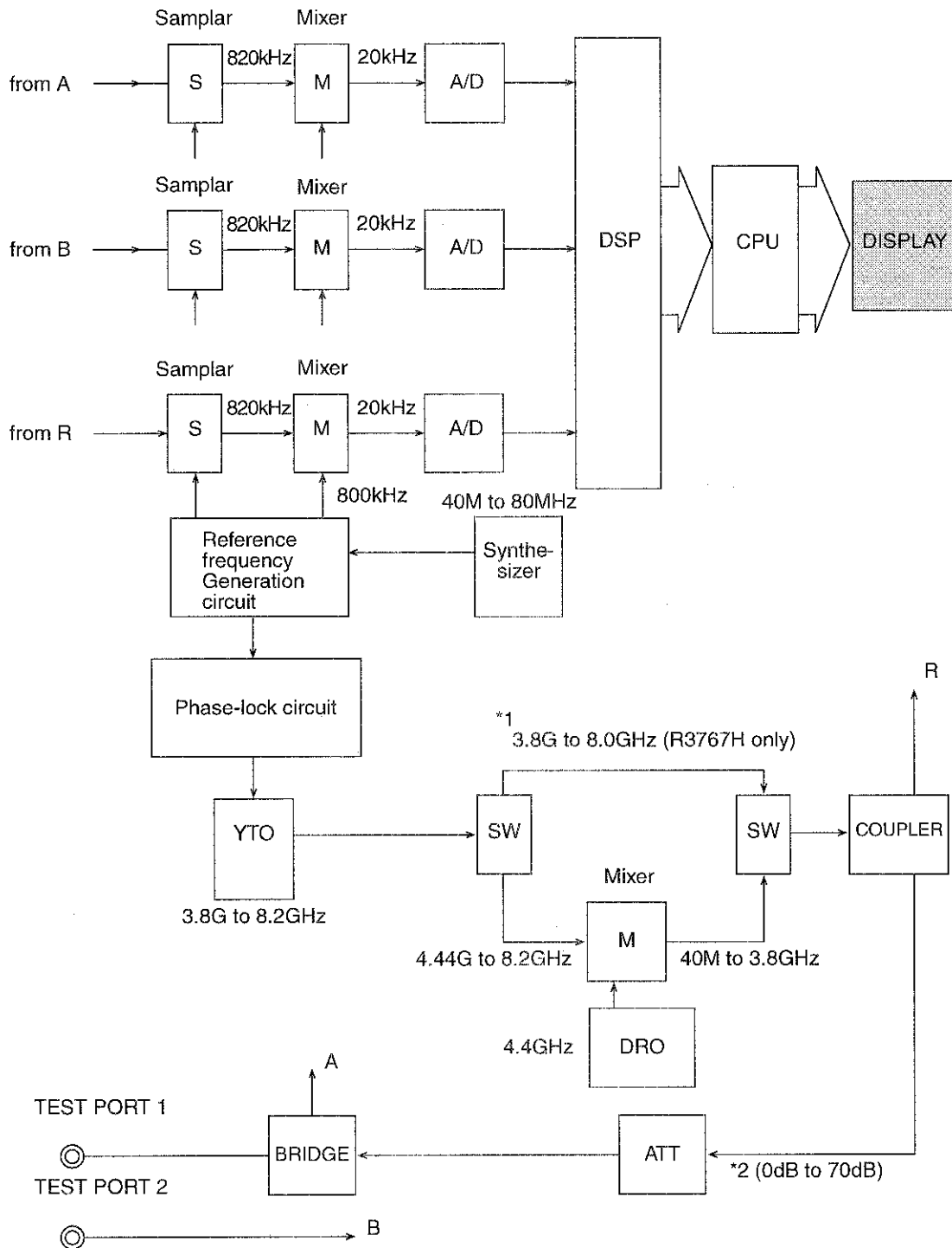

*1 : Leveling is possible with option 11 (8G output AMP).

*2 : Option 10 (output attenuator)

9.3.3 R3765CH/3767CH Diagrammatic Sketch of Block

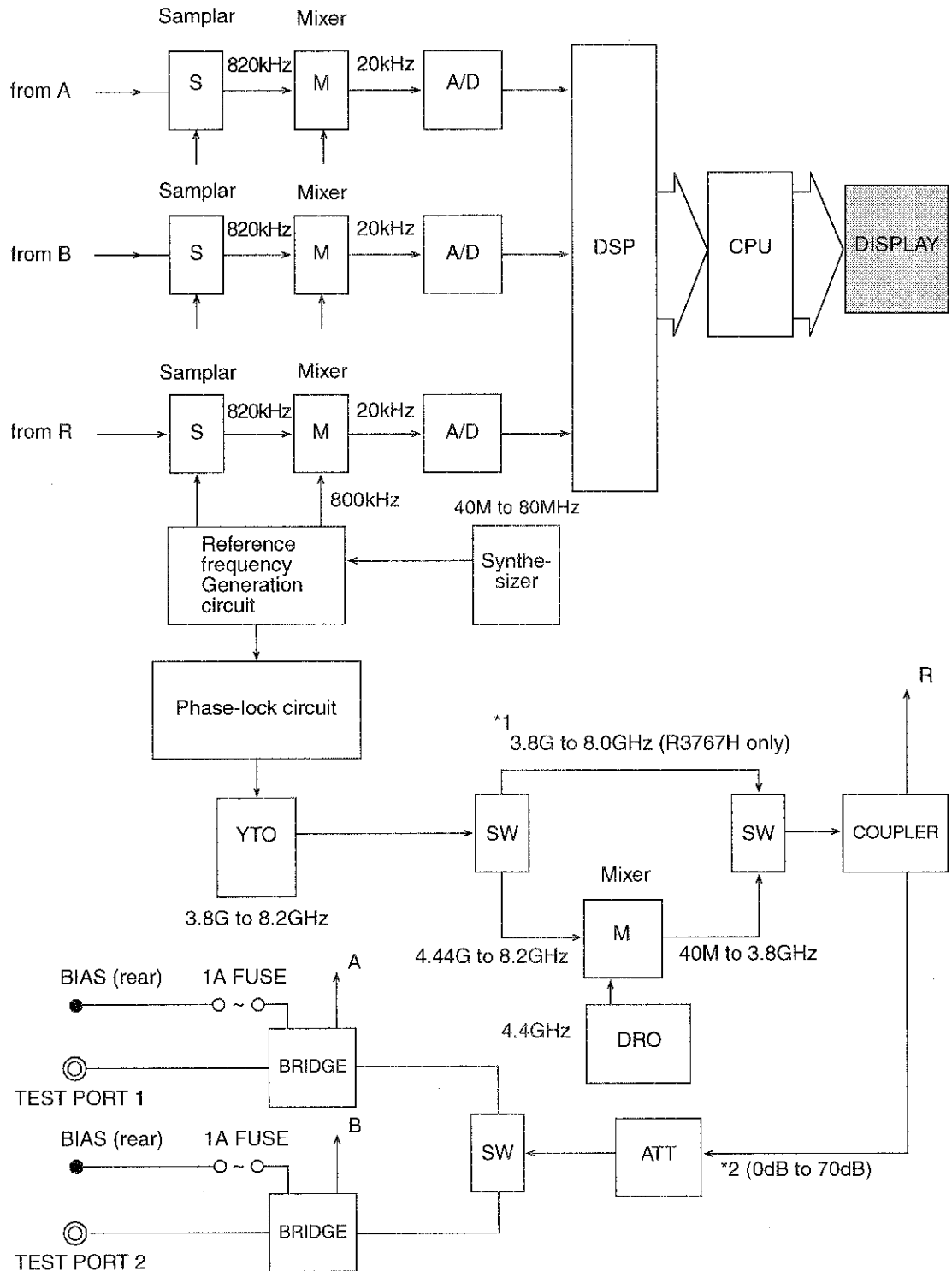

*1 : Leveling is possible with option 11 (8G output AMP).

*2 : Option 10 (output attenuator)

10 PERFORMANCE TEST

This chapter describes the test method to keep the performance of the R3765/3767H series.

Contact ADVANTEST for other test methods than the items described in this chapter.

10.1 Preparing for a Performance Test

10.1.1 Warm up

Warm up the R3765/3767H series for at least 30 minutes (pre-heating). Also, warm up each calibration standards as well.

10.1.2 Preparing Measurement Instrument

The following measurement instruments are required referring to the test items listed in Table 10-1.

Table 10-1 Required Measurement Instrument for Performance Test (1 of 2)

Test items	Measurement Instrument		Remarks
Frequency accuracy and range	<ul style="list-style-type: none"> • Counter Frequency : 40MHz to 3.8GHz (R3765H) 40MHz to 8.0GHz (R3767H) Display : 7 digits or more Accuracy : 0.1ppm or less 	R5372 (to 18GHz) or R5373 (to 26GHz) (Manufactured by ADVANTEST)	Refer to section 10.2
	<ul style="list-style-type: none"> • RF cable BNC-BNC, N-N Type 		
Output/input level and flatness	<ul style="list-style-type: none"> • Power meter Frequency : 40MHz to 3.8GHz Power range : -15dBm to +17dBm 	HP436A/HP437B (HP438A) (Calibrated under the national standard)	Refer to section 10.3
	<ul style="list-style-type: none"> • Power sensor Frequency : 40MHz to 3.8GHz Power range : -15dBm to +17dBm 	HP8482A (100kHz to 4.2GHz)	
Output level linearity	<ul style="list-style-type: none"> • Power meter Frequency : 40MHz to 3.8GHz (R3765H) Power range : -15dBm to +17dBm 	HP436A/HP437B (HP438A) (Calibrated under the national standard)	Refer to section 10.4
	<ul style="list-style-type: none"> • Power sensor Frequency : 40MHz to 3.8GHz Power range : -15dBm to +17dBm 	HP8482A (100kHz to 4.2GHz)	
Directivity	<ul style="list-style-type: none"> • Calibration kit 	Model 9617A3 (DC to 18GHz, N type connector)	Refer to section 10.5

10.1 Preparing for a Performance Test

Table 10-1 Required Measurement Instrument for Performance Test (2 of 2)

Test items	Measurement Instrument		Remarks
Test port load match	• Calibration kit	Model 9617A3 (DC to 18GHz, N type connector)	Refer to section 10.6
	• Directivity bridge	ZRB2VAR-52 (5MHz to 3GHz)	
Crosstalk	• Calibration kit	Model 9617A3 (DC to 18GHz, N type connector)	Refer to section 10.8

10.1.3 General Note

- Use an AC power source having a voltage of 90V to 250V and a frequency of 48Hz to 66Hz.
- When connecting the power supply cable, turn OFF the POWER switch.
- The R3765/3767H series must be tested under the following conditions:
 Temperature : +25°C to ±5°C
 Relative humidity : 80% RH or less
 Free from dust, vibration and noise.

10.2 Frequency Accuracy and Range

Testing procedure

- ① Setup the R3765/3767H series as follows:
For AH type, connect to "SOURCE" terminal. For BH/CH type, to "TEST PORT 1".

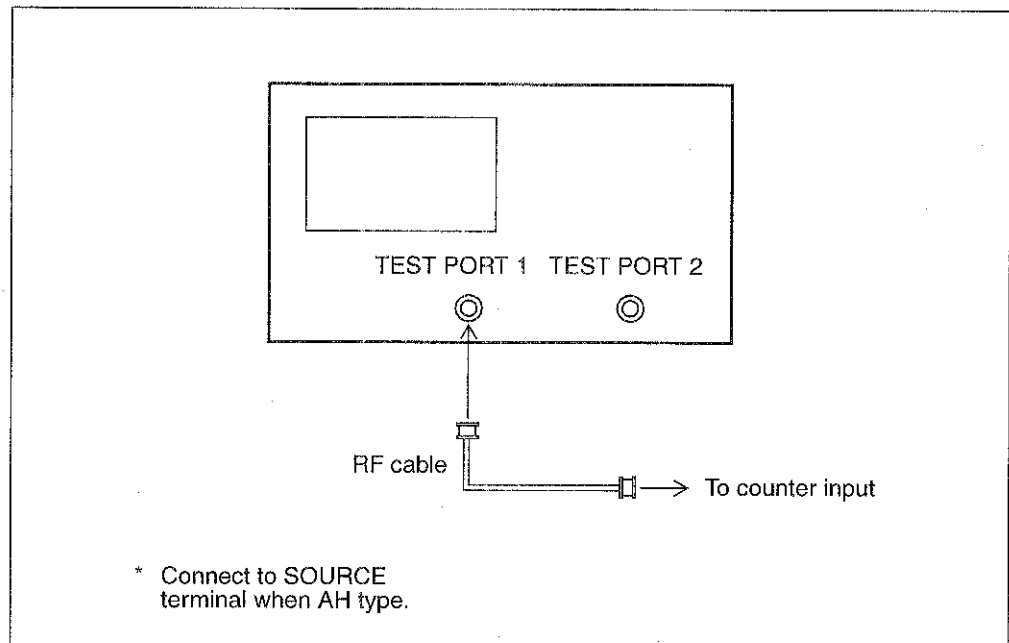

Figure 10-1 Frequency Accuracy and Range

- ② Set the R3765/3767H series as follows:
Span : 0Hz
Trigger mode : HOLD
- ③ Change any center frequency in the range of 40MHz to 3.8GHz (R3767H Series; to 8.0GHz).
- ④ <Check> : Counter read frequency < center frequency \pm center frequency $\times 20 \times 10^{-6}$
(Example)
When the center frequency is 100MHz : 100MHz \pm 2kHz
That is, 99,998,000Hz to 100,002,000Hz is enable.

10.3 Output Level Accuracy and Flatness

10.3 Output Level Accuracy and Flatness

10.3.1 Setup

Setup the R3765/3767H series as follows:

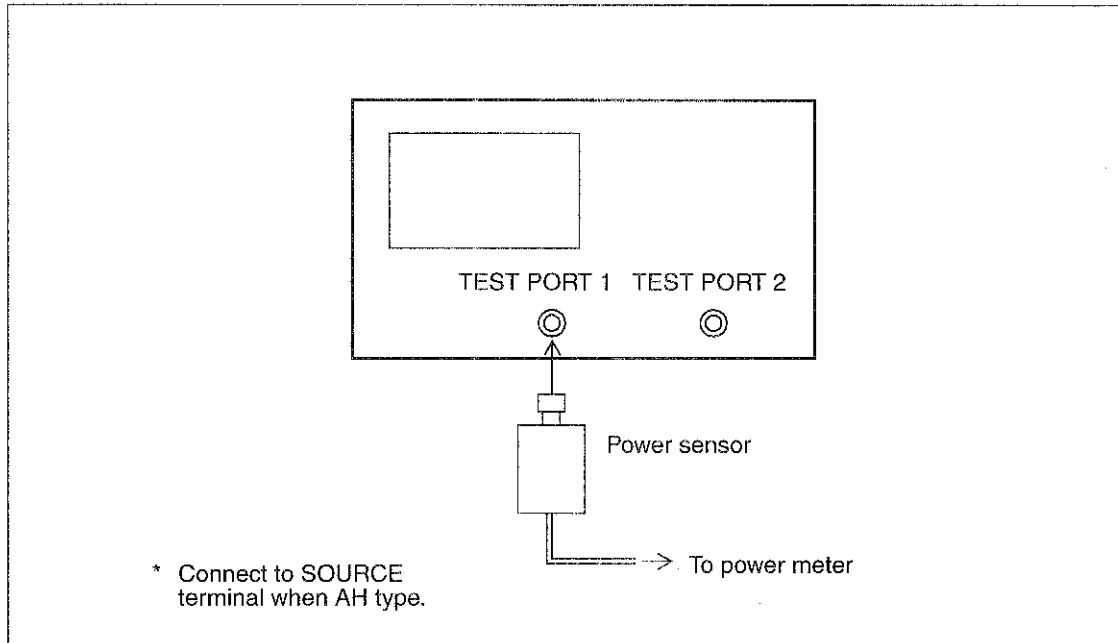

Figure 10-2 Output Level Accuracy and Flatness

10.3.2 Output Level Accuracy

Testing procedure

- ① Calibrate the power meter to zero.
- ② Set the R3765/3767H series as follows.
 - Center frequency : 50MHz
 - Span : 0Hz
 - Output level : 0dBm
 - Sweep mode : HOLD
- ③ Connect the power sensor to the output terminal and perform the measurement.
 Connect to "SOURCE" terminal for AH type and to "TEST PORT 1" for BH/CH type.
Note: The calibration factor is set to 50MHz.
- ④ <Check> : Output level accuracy (at 0dBm and 50MHz) $\pm 0.5\text{dB}$

10.3.3 Flatness

Testing procedure

- ① Calibrate the power meter to zero.
- ② Set the R3765/3767H series as follows.
Center frequency : 50MHz
Span : 0Hz
Output level : 0dBm
Sweep mode : HOLD
- ③ Press the **[REL]** of the power meter and set to 0dB (ratio test mode).
- ④ The span and output level are fixed. Change the center frequency and obtain data from the power meter.

Note: Use the calibration factor at the center frequency.

- ⑤ <Check> : Flatness (at 0dBm) 40MHz to 3.8GHz ± 2.0 dB

Note: In the case of R3767H series, leveling is not performed for over 3.8GHz.

10.4 Output Level Linearity

Testing procedure

- ① Calibrate the power meter to zero.
- ② Set the R3765/3767H series as follows.
Center frequency : 50MHz
Span : 0Hz
Output level : 0dBm
Sweep mode : HOLD
- ③ Connect the power sensor to the output terminal and perform the measurement. (Refer to Figure 10-3.)
Connect to "SOURCE" terminal for AH type and to "TEST PORT 1" for BH/CH type.

10.4 Output Level Linearity

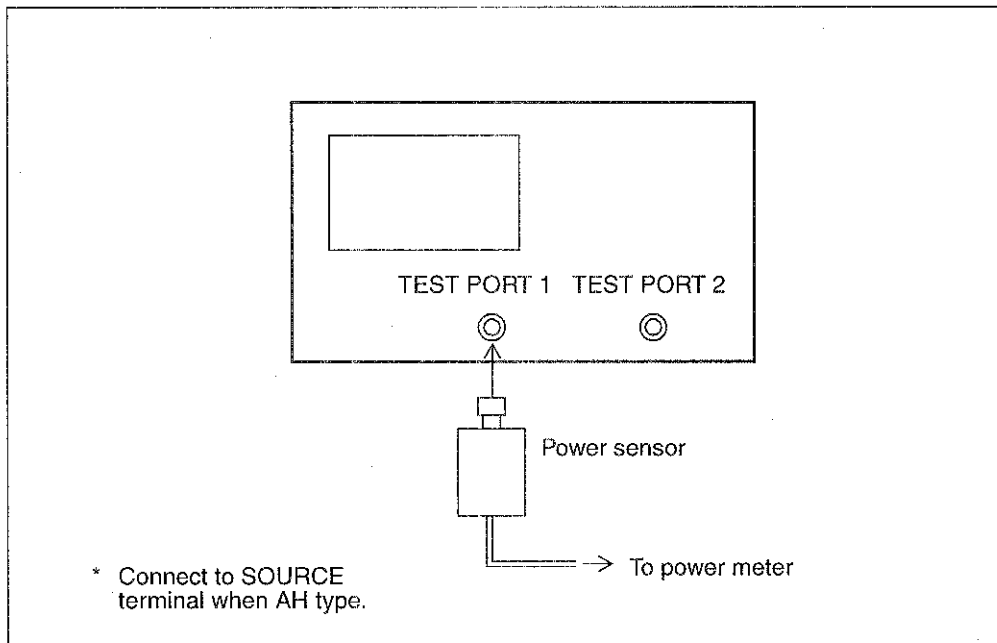

Figure 10-3 Output Level Linearity

- ④ Press the [REL] and set to 0dB (ratio test mode).
- ⑤ When changing the output level, obtain linearity data.

Note: The calibration factor is set to 50MHz.

- ⑥ <Check> :
 - For R3765AH/3767AH (Reference +7dBm)
 - ±0.4dB (+12dBm to -3dBm)
 - ±0.7dB (+17dBm to -8dBm)
 - For R3765BH/3767BH (Reference -3dBm)
 - ±0.4dB (+10dBm to -5dBm)
 - ±0.7dB (+15dBm to -10dBm)
 - For R3765CH/3767CH (Reference 0dBm)
 - ±0.4dB (+5dBm to -10dBm)
 - ±0.7dB (+10dBm to -15dBm)

10.5 Directivity

Testing procedure

- ① Setup the R3765/3767H series as follows.

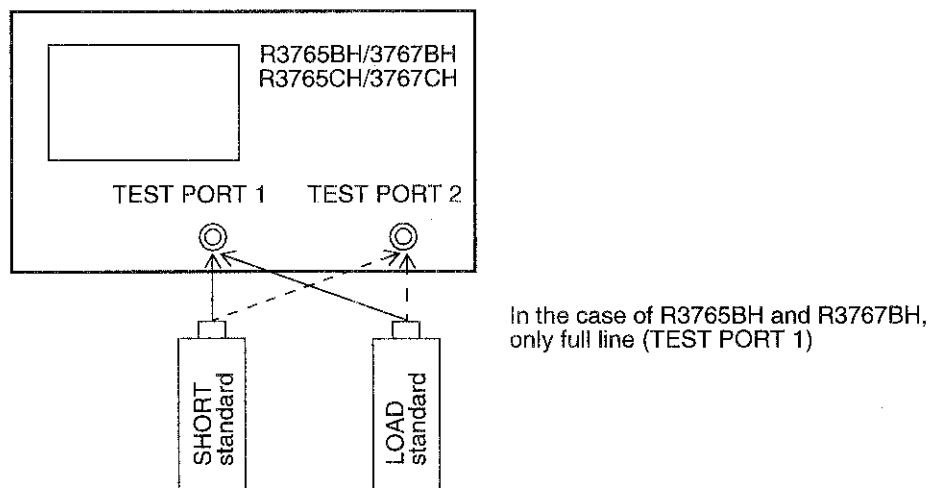

- ② Perform the normalize (SHORT) of TEST PORT 1.
- (a) **[MEAS]** → {*S11 REFL FWD*} or **[MEAS]** → {*REFLECTION*}.
 - (b) Connect the short standard to TEST PORT 1.
 - (c) **[CAL]** → {*NORMALIZE (SHORT)*}.
- ③ Connect the load standard to TEST PORT 1 and read the value of directivity from trace data with the marker.
- ④ <Check> : The directivity of TEST PORT 1 (in $25^{\circ}\text{C} \pm 5^{\circ}\text{C}$)
- | | |
|------------------|---------------------------------------|
| 40MHz to 2.6GHz | : -30dB or less |
| 2.6GHz to 3.8GHz | : -26dB or less |
| 3.8GHz to 8.0GHz | : -22dB or less (R3767BH/3767CH only) |
- The following operating procedure is only for R3765CH/3767CH.
- ⑤ Perform the normalize (SHORT) of TEST PORT 2.
- (a) **[MEAS]** → {*S22 REFL REV*}.
 - (b) Connect the short standard to TEST PORT 2.
 - (c) **[CAL]** → {*NORMALIZE (SHORT)*}.
 - (d) Remove the short standard.
- ⑥ Connect the load standard to TEST PORT 2 and read the value of directivity from trace data with the marker.
- ⑦ <Check> : The directivity of TEST PORT 2 (in $25^{\circ}\text{C} \pm 5^{\circ}\text{C}$)
- | | |
|------------------|--------------------------------|
| 40MHz to 2.6GHz | : -30dB or less |
| 2.6GHz to 3.8GHz | : -26dB or less |
| 3.8GHz to 8.0GHz | : -22dB or less (R3767CH only) |

10.6 Load Match of Test Port

10.6 Load Match of Test Port

10.6.1 When R3765AH/3767AH

- (1) Load match measurement of A PORT

Testing procedure

- ① Setup the R3765AH/3767AH as follows.

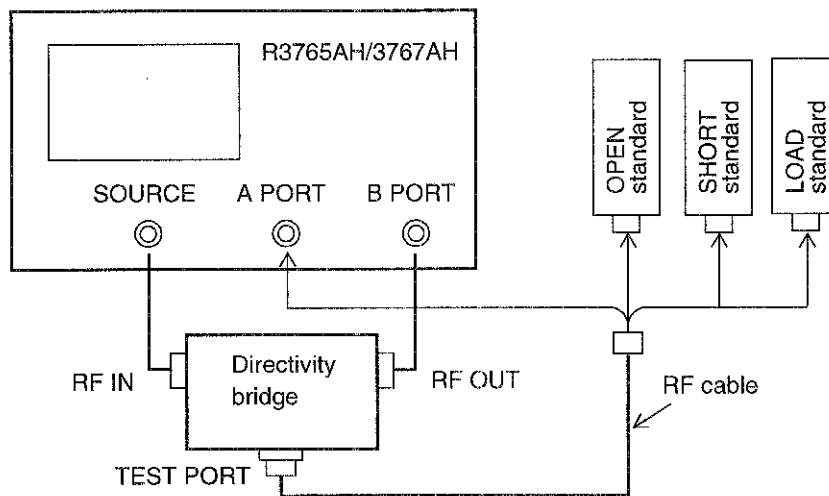

- ② Perform 1 port full calibration
 - (a) **[MEAS]** → {B/R}.
 - (b) **[CAL]** → {CAL MENUS} → {1 PORT FULL CAL}.
 - (c) Connect the open standard to the tip of RF cable and press {OPEN}.
 - (d) Connect the short standard to the tip of RF cable and press {SHORT}.
 - (e) Connect the load standard to the tip of RF cable and press {LOAD}.
 - (f) Press {DONE 1 PORT}.
- ③ Connect A PORT of the R3765AH/3767AH and the tip of RF cable.
- ④ Read the load match of A PORT from trace data with the marker.
- ⑤ <Check> : A PORT load match (in 25°C ± 5°C)
 - 40MHz to 2.6GHz : -18dB or less
 - 2.6GHz to 3.8GHz : -16dB or less
 - 3.8GHz to 8.0GHz : -14dB or less (R3767AH only)

(2) Load match measurement of B PORT

Testing procedure

- ① Setup the R3765AH/3767AH as follows.

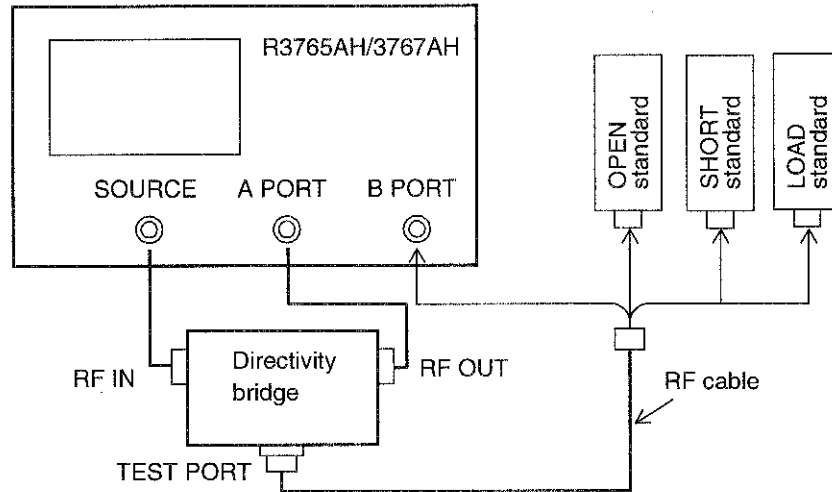

- ② Perform 1 port full calibration.

- (a) **[MEAS]** → {A/R}.
- (b) **[CAL]** → {CAL MENUS} → {1 PORT FULL CAL}.
- (c) Connect the open standard to the tip of RF cable and press {OPEN}.
- (d) Connect the short standard to the tip of RF cable and press {SHORT}.
- (e) Connect the load standard to the tip of RF cable and press {LOAD}.
- (f) Press {DONE 1 PORT}.

- ③ Connect A PORT of the R3765AH/3767AH and the tip of RF cable.

- ④ Read the load match of B PORT from trace data with the marker.

- ⑤ <Check> : B PORT load match (in 25°C ± 5°C)

40MHz to 2.6GHz : -18dB or less

2.6GHz to 3.8GHz : -16dB or less

3.8GHz to 8.0GHz : -14dB or less (R3767AH only)

10.6 Load Match of Test Port

10.6.2 When R3765BH/3767BH

Testing procedure

- ① Setup the R3765BH/3767BH as follows.

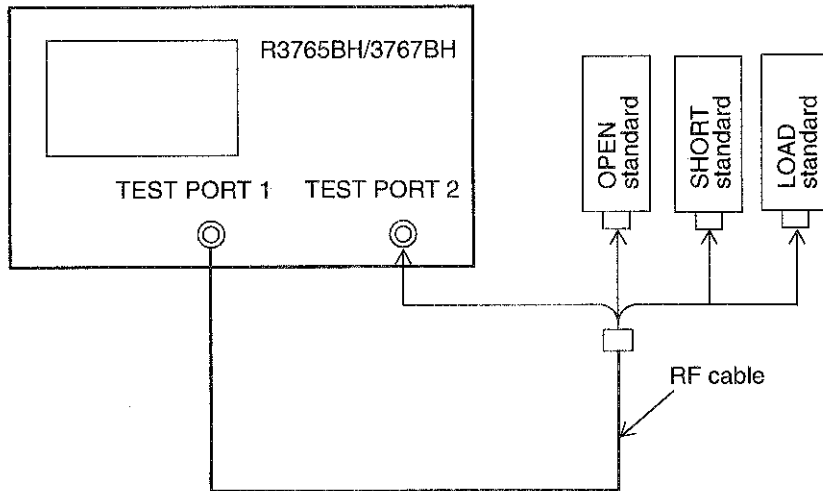

- ② Perform 1 port full calibration
 - (a) **[MEAS]** → {REFLECTION}.
 - (b) **[CAL]** → {CAL MENUS} → {1 PORT FULL CAL}.
 - (c) Connect the open standard to the tip of RF cable and press {OPEN}.
 - (d) Connect the short standard to the tip of RF cable and press {SHORT}.
 - (e) Connect the load standard to the tip of RF cable and press {LOAD}.
 - (f) Press {DONE 1 PORT}.
- ③ Connect TEST PORT 2 of the R3765BH/3767BH and the tip of RF cable.
- ④ Read the load match of TEST PORT 2 from trace data with the marker.
- ⑤ <Check> : TEST PORT 2 load match (in 25°C ± 5°C)
 - 40MHz to 2.6GHz : -18dB or less
 - 2.6GHz to 3.8GHz : -16dB or less
 - 3.8GHz to 8.0GHz : -14dB or less (R3767BH only)

10.6.3 When R3765CH/3767CH

(1) Load match measurement of TEST PORT 1

Testing procedure

- ① Setup the R3765CH/3767CH as follows.

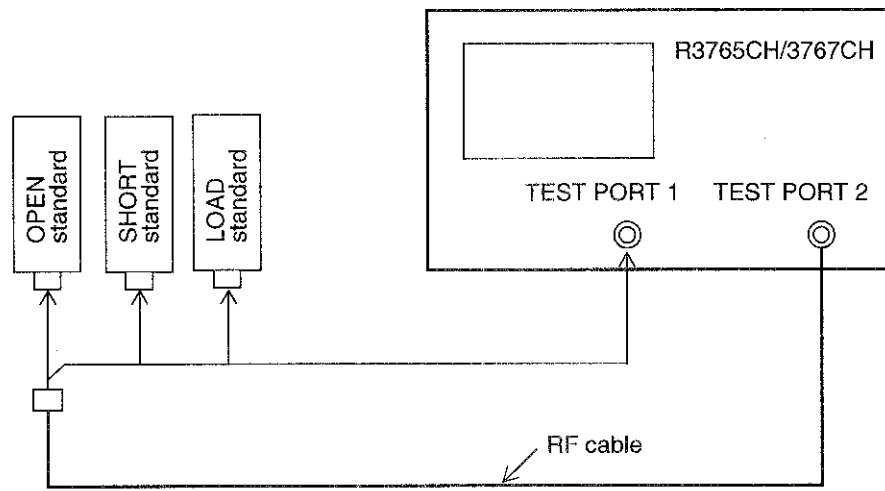

- ② Perform 1 port full calibration

- (a) **[MEAS]** → {S22 REFL REV}.
- (b) **[CAL]** → {CAL MENUS} → {1 PORT FULL CAL}.
- (c) Connect the open standard to the tip of RF cable and press {OPEN}.
- (d) Connect the short standard to the tip of RF cable and press {SHORT}.
- (e) Connect the load standard to the tip of RF cable and press {LOAD}.
- (f) Press {DONE 1 PORT}.

- ③ Connect TEST PORT 1 of the R3765CH/3767CH and the tip of RF cable.

- ④ Read the load match of TEST PORT 1 from trace data with the marker.

- ⑤ <Check> : TEST PORT 1 load match (in 25°C ± 5°C)

40MHz to 2.6GHz : -18dB or less

2.6GHz to 3.8GHz : -16dB or less

3.8GHz to 8.0GHz : -14dB or less (R3767CH only)

10.6 Load Match of Test Port

(2) Load match measurement of TEST PORT 2

Testing procedure

- ① Setup the R3765CH/3767CH as follows.

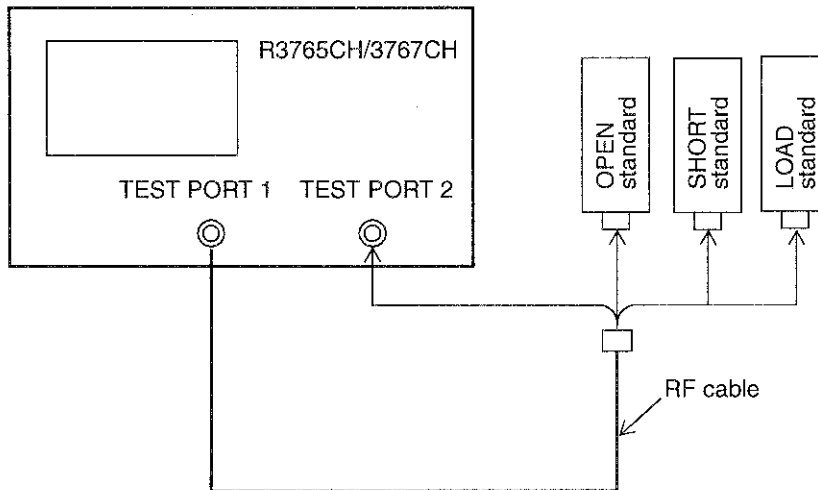

- ② Perform 1 port full calibration
- [MEAS]** → {S11 REFL FWD}.
 - [CAL]** → {CAL MENUS} → {1 PORT FULL CAL}.
 - Connect the open standard to the tip of RF cable and press {OPEN}.
 - Connect the short standard to the tip of RF cable and press {SHORT}.
 - Connect the load standard to the tip of RF cable and press {LOAD}.
 - Press {DONE 1 PORT}.
- ③ Connect TEST PORT 2 of the R3765CH/3767CH and the tip of RF cable.
- ④ Read the load match of TEST PORT 2 from waveform data with the marker.
- ⑤ <Check> : TEST PORT 2 load match (in 25°C ± 5°C)
- 40MHz to 2.6GHz : -18dB or less
 - 2.6GHz to 3.8GHz : -16dB or less
 - 3.8GHz to 8.0GHz : -14dB or less (R3767CH only)

10.7 Noise Level

Testing procedure

- ① Set the R3765/3767H series as follows.
 - (a) **[SCALE]** → {/DIV} → [1] → [0] → [x1].
 - (b) **[AVG]** → {SMOOTHING ON} → {SMOOTHING APERTURE} → [2] → [0] → [x1].
 - (c) **[SYSTEM]** → {SERVICE MENU} → {SERVICE MODES} → {SOURCE PLL OFF}.
 - For R3765AH/3767AH, see step ②.
 - For R3765BH/3767BH, see step ③.
 - For R3765CH/3767CH, see step ④.

CAUTION!

1. *The phase lock of the signal source is set to OFF by this operation, so that the receiver section is not affected by the leakage from the signal source, by which only the noise level in the receiver section can be measured.*
2. *The input port must not be connected with anything.*

- ② When R3765AH/3767AH
 - Measure the noise level of A input and B input according to the following procedure.
 - (a) Press **[MEAS]** & {A} to display the noise level of A input.
 - (b) Read the noise level value by the marker.
 - (c) Press **[MEAS]** & {B} to display the noise level of B input.
 - (d) Read the noise level value by the marker.

<Check> : Noise level under -90dB (3kHz bandwidth)
- ③ When R3765BH/3767BH
 - (a) Press **[SYSTEM]**, {MEAS SUB MENU} & {B} to display the noise level of B input.
 - (b) Read the noise level value by the marker.

<Check> : Noise level under -90dB (3kHz bandwidth)
- ④ When R3765CH/3767CH
 - Measure the noise level of B input.
 - (a) **[MEAS]** → {S21 TRANS FWD}.
 - (b) Press **[SYSTEM]**, {MEAS SUB MENU} & {B} to display the noise level of B input.
 - (c) Read the noise level value by the marker.
 - Measure the noise level of A input.
 - (a) **[MEAS]** → {S12 TRANS REV}.
 - (b) Press **[SYSTEM]**, {MEAS SUB MENU} & {A} to display the noise level of A input.
 - (c) Read the noise level value by the marker.

<Check> : Noise level under -75dB (3kHz bandwidth)

10.8 Crosstalk

10.8 Crosstalk

10.8.1 When R3765AH/3767AH

- (1) Crosstalk measurement of A PORT

Testing procedure

- ① Setup the R3765AH/3767AH as follows.

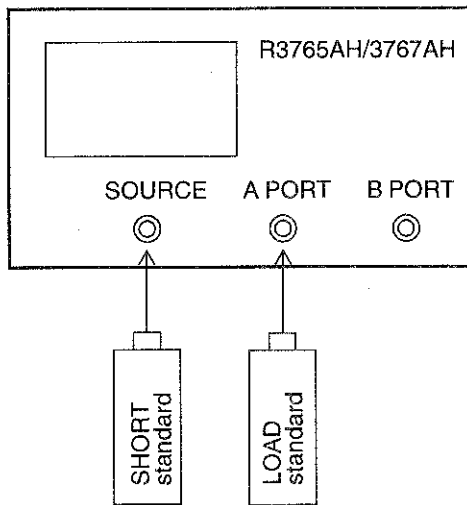

- ② Setup the R3765AH/3767AH.

MEAS : A/R
 RBW : 100Hz
 Average : 16 times

- ③ Connect the short standard to the SOURCE terminal.
- ④ Connect the load standard to A PORT.
- ⑤ Read the crosstalk value of A PORT from the trace data.
- ⑥ <Check> : Crosstalk of A PORT

40MHz to 3.8GHz : -90dB or less
 3.8GHz to 5.0GHz : -80dB or less (R3767AH only)
 5.0GHz to 8.0GHz : -70dB or less (R3767AH only)

(2) Crosstalk measurement of B PORT

Testing procedure

- ① Setup the R3765AH/3767AH as follows.

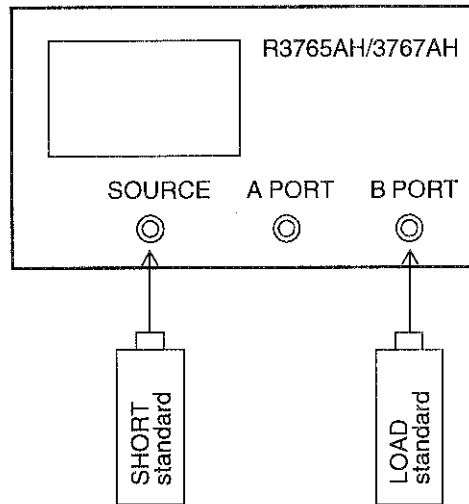

- ② Setup the R3765AH/3767AH.
MEAS : B/R
RBW : 100Hz
Average : 16 times
- ③ Connect the short standard to the SOURCE terminal.
- ④ Connect the load standard to B PORT.
- ⑤ Read the crosstalk value of B PORT from the trace data.
- ⑥ <Check> : Crosstalk of B PORT
40MHz to 3.8GHz : -90dB or less
3.8GHz to 5.0GHz : -80dB or less (R3767AH only)
5.0GHz to 8.0GHz : -70dB or less (R3767AH only)

10.8.2 When R3765BH/3767BH

Testing procedure

- ① Setup the R3765BH/3767BH as follows.

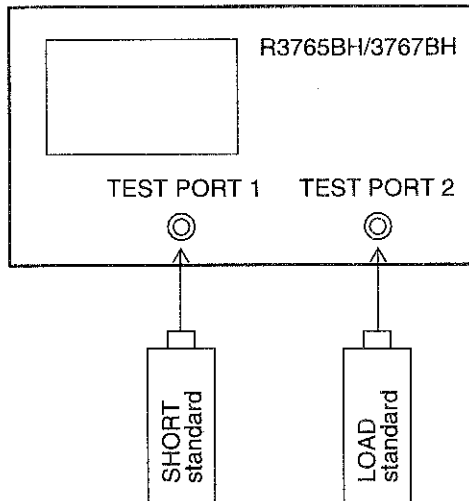

- ② Setup the R3765BH/3767BH.
 MEAS : TRANSMISSION
 RBW : 100Hz
 Average : 16 times
- ③ Connect the short standard to TEST PORT 1.
- ④ Connect the load standard to TEST PORT 2.
- ⑤ Read the crosstalk value from the trace data.
- ⑥ <Check> : Crosstalk (only about TEST PORT 2)
 - 40MHz to 3.8GHz : -90dB or less
 - 3.8GHz to 5.0GHz : -80dB or less (R3767BH only)
 - 5.0GHz to 8.0GHz : -70dB or less (R3767BH only)

10.8.3 When R3765CH/3767CH

(1) Crosstalk of TEST PORT 1

Testing procedure

- ① Setup the R3765CH/3767CH as follows.

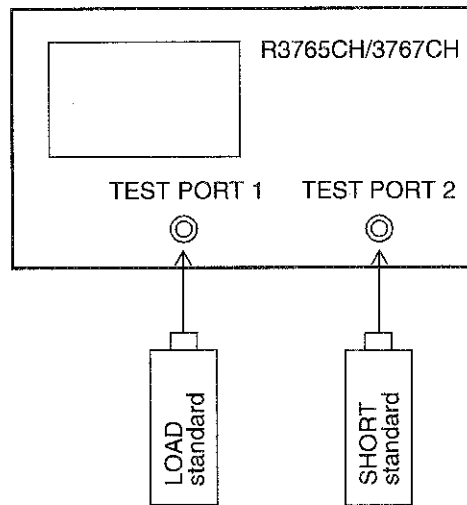

- ② Setup the R3765CH/3767CH.

MEAS : S12
 RBW : 100Hz
 Average : 16 times

- ③ Connect the short standard to TEST PORT 2.
- ④ Connect the load standard to TEST PORT 1.
- ⑤ Read the crosstalk value of TEST PORT 1 from the trace data.
- ⑥ <Check> : Crosstalk of TEST PORT 1
- | | |
|------------------|--------------------------------|
| 40MHz to 2.6GHz | : -90dB or less |
| 2.6GHz to 3.8GHz | : -85dB or less |
| 3.8GHz to 5.0GHz | : -70dB or less (R3767CH only) |
| 5.0GHz to 8.0GHz | : -60dB or less (R3767CH only) |

10.8 Crosstalk

(2) Crosstalk of TEST PORT 2

Testing procedure

- ① Setup the R3765CH/3767CH as follows.

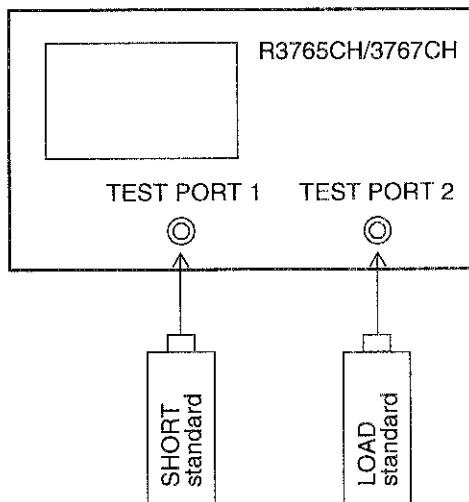

- ② Setup the R3765CH/3767CH.

MEAS : S21
 RBW : 100Hz
 Average : 16 times

- ③ Connect the short standard to TEST PORT 1.
- ④ Connect the load standard to TEST PORT 2.
- ⑤ Read the crosstalk value of TEST PORT 2 from the trace data.

- ⑥ <Check> : Crosstalk of TEST PORT 2

40MHz to 2.6GHz : -90dB or less
 2.6GHz to 3.8GHz : -85dB or less
 3.8GHz to 5.0GHz : -70dB or less (R3767CH only)
 5.0GHz to 8.0GHz : -60dB or less (R3767CH only)

11 SPECIFICATIONS

This chapter describes about the function of the R3765/3767H series and the performance/specification together.

(1) Measurement Function

Sweep channel	2 channels (CH1, CH2)
Display channel	4 channels (CH1, CH2, CH3, CH4)
Trace	2 traces/channels
Display parameter	A/R/, B/R, A, B, R (R3765AH/3767AH) TRANSMISSION, REFLECTION, TRANS&REFL (R3765BH/3767BH) S11, S21, S22, S12, S11&S21, S22&S12 (R3765CH/3767CH)
Parameter conversion	Z, Y, 1/S (All type)
Format	
Rectangular display	The real part and the imaginary part of logarithmic/linear magnitude, phase, group-delay or complex number. Z , R, X (when impedance-conversion measurement) Y , G, B (when admittance-conversion measurement) Phase-delay display function
Smith chart	Reading with marker is for logarithmic/linear magnitude & phase, real part + imaginary part, R + jX, G + jB.
Polar coordinates display	Reading with marker is for logarithmic/linear magnitude & phase, real part + imaginary part.

11 SPECIFICATIONS

(2) Signal Source Section

Measurement frequency	
Range	40MHz to 3.8GHz (R3765AH/BH/CH) 40MHz to 8.0GHz (R3767AH/BH/CH)
Setting resolution	1Hz
Measurement resolution	$\pm 0.005\text{ppm}$
Accuracy	$\pm 20\text{ppm}$ ($25^\circ\text{C} \pm 5^\circ\text{C}$)
Output level (40MHz to 3.8GHz)	
Range	+17dBm to -8dBm (R3765AH/3767AH) +7dBm to -18dBm (R3765BH/3767BH) +10dBm to -15dBm (R3765CH/3767CH)
Resolution	0.01dB
Accuracy	$\pm 0.5\text{dB}$ (50MHz, 0dB, $25^\circ\text{C} \pm 5^\circ\text{C}$) (at Test Port 1 when R3765CH/3767CH)
Output level linearity	$25^\circ\text{C} \pm 5^\circ\text{C}$ <ul style="list-style-type: none"> • +7dBm reference when R3765AH/3767AH $\pm 0.4\text{dB}$ (+12dBm to -3dBm) $\pm 0.7\text{dB}$ (+17dBm to -8dBm) • -3dBm reference when R3765BH/3767BH $\pm 0.4\text{dB}$ (+10dBm to -5dBm) $\pm 0.7\text{dB}$ (+15dBm to -10dBm) • 0dBm reference when R3765CH/3767CH $\pm 0.4\text{dB}$ (+5dBm to -10dBm) $\pm 0.7\text{dB}$ (+10dBm to -15dBm)
Flatness	2.0dBp-p ($25^\circ\text{C} \pm 5^\circ\text{C}$) (at Test Port 1 when R3765CH/R3767CH)
Output level (3.8GHz to 8.0GHz)	Output level fixed -3dBm or more (R3767AH) -16dBm or more (R3767BH) -13dBm or more (R3767CH)
Output impedance	50 Ω

Signal Source Section

Signal purity	
Harmonic distortion	≤-20dBc (40MHz to 3.8GHz, 25°C ± 5°C when maximum output)
Non harmonic spurious	≤-25dBc (40MHz to 3.8GHz, 25°C ± 5°C when maximum output)
Phase noise	10kHz offset, 1kHz bandwidth, -85dBc+20log (f/40MHz) when maximum output
Sweep function	
Sweep parameter	Frequency, signal level
Maximum sweep range	
Frequency	40MHz to 3.8GHz (R3765AH/BH/CH) 40MHz to 8.0GHz (R3767AH/BH/CH)
Signal level (40MHz to 3.8GHz)	+17dBm to -8dBm (R3765AH, R3767AH) +7dBm to -18dBm (R3765BH, R3767BH) +10dBm to -15dBm (R3765CH, R3767CH) Start/Stop or Center/Span
Sweep type	Linear/log frequency sweep, sweep by partial and arbitrary frequency, level sweep and CW (single frequency) sweep
Sweep time	0.15ms/1 point (when the normalize cal. used) 0.25ms/1 point (when the 2 port full cal. used) However, the minimum sweeping time is different depending on the measuring format, the type of error correction, the sweeping width per point, the number of measurement points and the measuring IF bandwidth.
Measurement point	3, 6, 11, 21, 51, 101, 201, 301, 401, 601, 801, 1201 point
Sweep trigger	Sets with either 'sequence, hold, single sweep' or 'external trigger'.
Sweep mode	
Dual sweep	Sweeps 2 channels in the same frequency range.
Alternate sweep	2 channels (CH1 and CH2) can be measured with different sweep types and in different frequency ranges.

11 SPECIFICATIONS

(3) Characteristic of the Receiver Part

Resolution bandwidth	10kHz to 10Hz (changeable at 1 and 3 steps)
Magnitude characteristic	
Magnitude resolution	0.001dB
Dynamic accuracy	Reference, -20dB from the test port maximum input level * When isolation correction 0dB to -10dB : $\pm 0.3\text{dB}$ ($40\text{MHz} \leq f \leq 3.8\text{GHz}$) $\pm 0.8\text{dB}$ ($3.8\text{GHz} \leq f \leq 8.0\text{GHz}$) -10dB to -20dB : $\pm 0.05\text{dB}$ ($40\text{MHz} \leq f \leq 3.8\text{GHz}$) $\pm 0.2\text{dB}$ ($3.8\text{GHz} \leq f \leq 8.0\text{GHz}$) -20dB to -50dB : $\pm 0.05\text{dB}$ -50dB to -60dB : $\pm 0.10\text{dB}$ -60dB to -70dB : $\pm 0.40\text{dB}$ -70dB to -90dB : $\pm 1.00\text{dB}$
Ratio measurement accuracy	$\pm 1.00\text{dB}$ ($25^\circ\text{C} \pm 5^\circ\text{C}$)
Phase characteristic	
Measurement range	$\pm 180^\circ\text{C}$ (More than $\pm 180^\circ\text{C}$ can be displayed depending on the display extension function.)
Phase resolution	0.01°
Frequency characteristic	$\pm 5^\circ$ (10dB, $25^\circ\text{C} \pm 5^\circ\text{C}$)
Dynamic accuracy	Reference, -20dB from the test port maximum input level * When isolation correction 0dB to -10dB : $\pm 5.0^\circ$ -10dB to -20dB : $\pm 0.3^\circ$ ($40\text{MHz} \leq f \leq 3.8\text{GHz}$) $\pm 0.8^\circ$ ($3.8\text{GHz} \leq f \leq 8.0\text{GHz}$) -20dB to -50dB : $\pm 0.3^\circ$ -50dB to -60dB : $\pm 0.4^\circ$ ($40\text{MHz} \leq f \leq 3.8\text{GHz}$) $\pm 0.8^\circ$ ($3.8\text{GHz} \leq f \leq 8.0\text{GHz}$) -60dB to -70dB : $\pm 1.5^\circ$ -70dB to -80dB : $\pm 4.0^\circ$ -80dB to -90dB : $\pm 8.0^\circ$

Characteristic of the Receiver Part

Group delay characteristic	
Range	<p>Can be obtained by the following equation.</p> $\tau = \frac{\Delta\phi}{360 \times \Delta f}$ <p>$\Delta\phi$: Phase Δf : Aperture frequency (Hz)</p>
Measurement range	1ps to 250s
Group delay resolution	1ps
Aperture frequency	<p>equals Δf and can be set optionally up to 100% from</p> $\frac{100}{\text{measurement point-1}} \times 2\%$ <p>of the frequency span in the resolution of $\frac{100}{\text{measurement point-1}} \times 2\%$.</p>
Accuracy	$\frac{\text{phase accuracy}}{360 \times \text{aperture frequency (Hz)}}$

11 SPECIFICATIONS

(4) Test Port Characteristic

Test port load match	* 25°C ± 5°C 18dB (40MHz to 2.6GHz) 16dB (2.6GHz to 3.8GHz) 14dB (3.8GHz to 8.0GHz) *R3767AH/BH/CH only
Directivity	* 25°C ± 5°C 30dB (40MHz to 2.6GHz) 26dB (2.6GHz to 3.8GHz) 22dB (3.8GHz to 8.0GHz) *R3767BH/CH only
Crosstalk	<ul style="list-style-type: none"> • When R3765AH/BH 90dB (40MHz to 3.8GHz) • When R3767AH/BH 90dB (40MHz to 3.8GHz) 80dB (3.8GHz to 5.0GHz) 70dB (5.0GHz to 8.0GHz) • When R3765CH 90dB (40MHz to 2.6GHz) 85dB (2.6GHz to 3.8GHz) • When R3765CH/3767CH 90dB (40MHz to 2.6GHz) 85dB (2.6GHz to 3.8GHz) 70dB (3.8GHz to 5.0GHz) 60dB (5.0GHz to 8.0GHz)
Connector	N type (f), 50Ω
Noise level	From the test port maximum input level -90dB (3kHz bandwidth) -100dB (10Hz bandwidth)
Maximum input level	0dBm (R3765AH/BH, R3767AH/BH) +12dBm (R3765CH, R3767CH)
Maximum port-biased	±30V _{DC} , 0.5A (R3765CH, R3767CH)
Input head damage level	+21dBm, ±30V _{DC}

(5) Error Correction Function

Normalize	Frequency response (both magnitude and phase) in transmission measurement and reflection measurement is corrected.
Normalize & isolation	Frequency response and isolation in transmission measurement are corrected.
1 port calibration	The error caused by bridge directivity, frequency response and source match in reflection measurement is corrected. For the error correction, the short, the open and the load are required.
2 ports calibration	The error caused by directivity, source match, load match, frequency response and isolation in transmission measurement and reflection measurement is corrected. (R3765CH/3767CH only)
Data averaging	Average of each sweep data (vector value) The average factor can be set between 2 to 999.
Data smoothing	Average of moving between adjacent measurement points.
Electrical length correction	Add equivalent electrical length or delay-time to the measured phase and the group delay-time.
Phase offset correction	Add phase offset to the measured phase constantly.
Calibration by frequency interpolation	In the calibration by frequency interpolation mode, the error count is performed the difference calculation even when the frequency and the horizontal axis point number are changed. Change of the frequency range (start/stop) is applied within the frequency range of the first calibration.

11 SPECIFICATIONS

(6) Display Section

Displaying device	8.4 inch TFT color liquid crystal display
Resolution	640 × 480 dot
Display mode	Rectangular log/linear coordinates, polar coordinates, smith chart (impedance/admittance display)
Display format	Single channel 2 channels (overlap-display, separate-display) 4 channels (separate-display)
Measuring conditions display	Start/Stop Center/Span Scale/DIV Reference level Marker value Soft key function Warning message
Position of the reference line	The top (100%) to the bottom (0%) of the vertical axis memory
Auto-scale	The reference and the scale are set to display the trace under measurement in the best form.
Brightness	ON/OFF of backlight is possible.

(7) Other Functions

Marker function	
Marker display	Marker reading can be converted to the display value corresponding to each measurement format.
Multi-marker	Independent 10 markers can be set to each channel.
Delta-marker	All the ten markers can be specified to the reference marker to measure the delta value between the moved markers.
Marker couple	Each channel marker can be set with both coupled or with separated.
Analysis for any specified section	Marker search can be done in the marker-specified section.
MKR search	MAX search, MIN search
Marker tracking	Searches at every sweep
Target search	Frequency value of XdB down point bandwidth, middle frequency, calculation of Q, etc. and phase 0°.
MKR →	MKR → Reference value, MKR → START, MKR → STOP, MKR → CENTER
Limit line function	

(8) Program Function

BASIC controller function	The controller function with standard function can control the R3765/3767H series itself and other instruments equipped with GPIB interface.
Built-in function	The measured data can be analyzed at a high speed with the built-in function.
FDD function	Based on MS-DOS format. For 3 modes (DD 720KB, HD 1.2MB/1.4MB)

11 SPECIFICATIONS

(9) Connection to External Devices

Signal for external display	15 pins, D-SUB connector (VGA)
GPIB data output & remote control	IEEE488 applicable
Parallel I/O output	TLL level, 8-bit output (2-ports) 4-bit input/output (2 ports)
Serial port	Based on RS-232
Keyboard	Based on IBM PC-AT
External reference frequency input	Inputable range 1MHz, 2MHz, 5MHz, 10MHz \pm 10ppm More than 0dBm (50 Ω)
Power source for probing	\pm 15V \pm 0.5V, 300mA

(10) General Specification

Operating environment	
When FDD used.	Temperature range +5 to +40°C Relative humidity under 80% (non-condensing)
When FDD unused.	Temperature range 0 to +50°C Relative humidity under 80% (non-condensing)
Storing environment	-20 to +60°C
Power source	AC100V to 120V, 50Hz/60Hz AC220V to 240V, 50Hz/60Hz * Auto-switch between 100VAC and 200VAC type
Outer dimensions	About 424mm (width) \times 220mm (height) \times 400mm (depth)
Mass	16kg or less
Power draw	300VA or less

APPENDIX

Information for reference useful in operating is described in the APPENDIX.

A.1 The Relation of Data between each Function

Describes about the relation of data between each function.

A.1.1 The Relation of Data between each Channel and each Function

Describes about the relation between the data of each function and each channel.

The sub-channel of channel 1 is channel 3, and the sub-channel of channel 2 is channel 4.

(1) In the case of COUPLE CH ON

Function	Channel			
	CH1	CH3	CH2	CH4
MEAS	○	×	○	×
SUB MEAS	×	○	×	○
STIMULUS/RBW	Common			
Averaging	Common		Common	
Smoothing	Common		Common	
Trace operation	Independent	Independent	Independent	Independent
Parameter conversion	Independent	Independent	Independent	Independent
FORMAT	Independent	Independent	Independent	Independent
Scale	Independent	Independent	Independent	Independent
Marker	Independent	Independent	Independent	Independent
Limit line	Independent	Independent	Independent	Independent

Mark ○ shows that it can be set.

Mark × shows that it cannot be set.

A.1 The Relation of Data between each Function

(2) In the case of COUPLE CH OFF

Function	Channel			
	CH1	CH3	CH2	CH4
MEAS	○	×	○	×
SUB MEAS	×	○	×	○
STIMULUS/RBW	Common		Common	
Averaging	Common		Common	
Smoothing	Common		Common	
Trace operation	Independent	Independent	Independent	Independent
Parameter conversion	Independent	Independent	Independent	Independent
FORMAT	Independent	Independent	Independent	Independent
Scale	Independent	Independent	Independent	Independent
Marker	Independent	Independent	Independent	Independent
Limit line	Independent	Independent	Independent	Independent

Mark ○ shows that it can be set.
 Mark × shows that it cannot be set.

A.1.2 The Data Interlocking to each Item in MEAS Menu.

The data of the following functions are interlocked for each selected input port in the R3765/3767H series.

Also the data of the scale function are interlocked for each FORMAT as well.

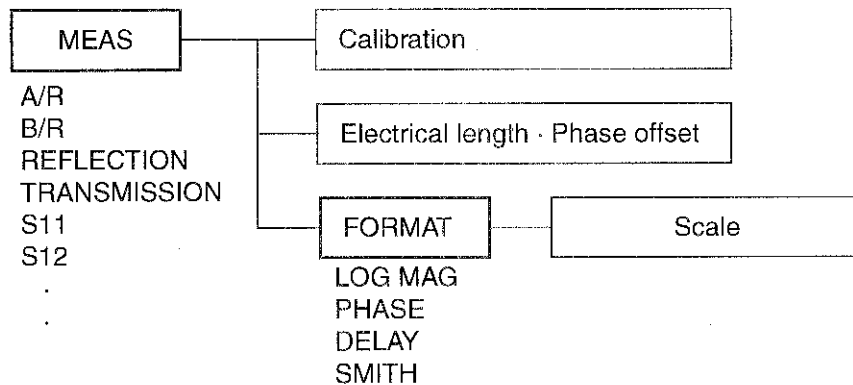

A.2 Measuring Time

The measurement time is the time to acquire the data plus the frequency setup time.

Data acquiring time is set up as SWEEP TIME.

Frequency setup time is different depending on the frequency setup.

The following shows the typical values.

(Example)

Start frequency 1GHz
 Stop frequency 2GHz
 Measuring point number 101 points

- ① Frequency between measuring points: 10MHz → Setup time, 100μsec/point
 Total setup time is (100μsec/point) × 100 points = 10msec.
 - When the frequency between the measuring points is more than 5MHz, the setup time is 100μsec per about 5MHz.
- ② Band switching time: About 8msec
 - The R3765/3767H series is composed by the following frequency bands.
 Each time the band is switched, the setup time is about 8msec.

Band	Frequency range
1	40MHz to 80MHz
2	80MHz to 160MHz
3	160MHz to 320MHz
4	320MHz to 560MHz
5	560MHz to 1120MHz
6	1120MHz to 2160MHz
7	2160MHz to 3800MHz
8	3800MHz to 6000MHz
9	6000MHz to 8000MHz

- ③ The setup time is the total of ① and ②, that is 18msec. Therefore, the measurement time is SWEEP TIME plus 18msec.

A.3 Initial Setting

A.3 Initial Setting

(1 of 4)

Function	Initialize method	
	Power on or preset	*RST
Stimulus Sweep type Continuous sweep Trigger source Trigger delay Sweep time Measurement point Start frequency Stop frequency Center frequency Frequency span Frequency display Fixed frequency of level sweep Output level Start level Stop level Two-channel interlocking Program sweep segment	Linear frequency sweep ON Internal (FREE RUN) OFF (0sec) 190.95msec (AUTO) (R3765AH/BH/CH) 402.0msec (AUTO) (R3767AH/BH/CH) 201 40MHz 3.8GHz (R3765AH/BH/CH) 8.0GHz (R3767AH/BH/CH) 1.92GHz (R3765AH/BH/CH) 4.02GHz (R3767AH/BH/CH) 3.76GHz (R3765AH/BH/CH) 7.96GHz (R3767AH/BH/CH) Start/Stop 1GHz * 1 * 2 * 2 ON All clear	Linear frequency sweep OFF Internal (FREE RUN) OFF (0sec) 240.2msec (AUTO) (R3765AH/BH/CH) 420.35msec (AUTO) (R3767AH/BH/CH) 1201 40MHz 3.8GHz (R3765AH/BH/CH) 8.0GHz (R3767AH/BH/CH) 1.92GHz (R3765AH/BH/CH) 4.02GHz (R3767AH/BH/CH) 3.76GHz (R3765AH/BH/CH) 7.96GHz (R3767AH/BH/CH) Start/Stop 1GHz * 1 * 2 * 2 ON All clear
Response Dual channel Active channel Resolution bandwidth Selection item of input port Average Trace operation Conversion Characteristic impedance Measurement format Group delay aperture Smoothing Display Split/Overlap Label	OFF CH1 10kHz * 3 OFF (Number of times 16) NONE NONE 50Ω * 4 10% OFF (Aperture 10%) Data Overlap NONE	OFF CH1 10kHz * 3 OFF (Number of times 16) NONE NONE 50Ω * 4 0.01% OFF (Aperture 0.01%) Data Overlap NONE

* 1: Output level

Type	Power on or preset	*RST
AH	0dBm	0dBm
BH	0dBm	0dBm
CH AH + S parameter	10dBm	10dBm

* 2: Start/Stop level

Type	Power on or preset		*RST	
	Start	Stop	Start	Stop
AH	-13dBm	0dBm	-13dBm	22dBm
BH	-15dBm	0dBm	-15dBm	20dBm
CH AH + S parameter	-20dBm	0dBm	-20dBm	10dBm

* 3: Selection item of input port

Type	Channel	CH1	CH2	CH3	CH4
AH		A/R	B/R	A/R	B/R
BH		REFLECTION	TRANSMISSION	REFLECTION	TRANSMISSION
CH AH + S parameter		S ₁₁	S ₂₁	S ₁₁	S ₂₁

* 4: Measurement format

Type	Channel	CH1	CH2	CH3	CH4
AH		LOG MAG	LOG MAG	LOG MAG	LOG MAG
BH		LOG MAG	LOG MAG	POLAR	LOG MAG
CH AH + S parameter		LOG MAG	LOG MAG	POLAR	LOG MAG

NETWORK ANALYZER OPERATION MANUAL

A.3 Initial Setting

(2 of 4)

Function	Initialize method	
	Power on or preset	*RST
Reference value		
Logarithmic magnitude	0dB	0dB
Phase	0°	0°
Group delay	0sec	0sec
Smith chart	1	1
Polar coordinate	1	1
Linear amplitude	0	0
SWR	1	1
Real part	10	10
Imaginary part	10	10
Continuous phase	0°	0°
The value per division of Y-axis		
Logarithmic magnitude	* 5	* 5
Phase	45°	45°
Group delay	100nsec	100nsec
Smith chart	—	—
Polar coordinate	—	—
Linear amplitude	100m	100m
SWR	1	1
Real part	1	1
Imaginary part	1	1
Continuous phase	360°	360°
Reference position		
Logarithmic magnitude	* 6	* 6
Phase	50%	50%
Group delay	50%	50%
Smith chart	—	—
Polar coordinate	—	—
Linear amplitude	0%	0%
SWR	0%	0%
Real part	100%	100%
Imaginary part	100%	100%
Continuous phase	50%	50%

* 5: Logarithmic magnitude (the value per division of Y-axis)

Type \ Channel	CH1	CH2	CH3	CH4
AH	10dB	10dB	1dB	1dB
BH	5dB	10dB	1 UNIT	1dB
CH AH + S parameter	5dB	10dB	1 UNIT	1dB

* 6: Logarithmic magnitude (reference position)

Type \ Channel	CH1	CH2	CH3	CH4
AH	90%	90%	90%	90%
BH	90%	90%	-	90%
CH AH + S parameter	90%	90%	-	90%

(3 of 4)

Function	Initialize method	
	Power on or preset	*RST
Calibration		
Correct measurement	OFF	OFF
Calibration data	Clear	Clear
Electrical length correction	OFF (0sec)	OFF (0sec)
Phase offset	OFF (0°)	OFF (0°)
Measurement end extension correction	OFF	OFF
R input	0 sec	0 sec
A input	0 sec	0 sec
B input	0 sec	0 sec
Port 1	0 sec	0 sec
Port 2	0 sec	0 sec
Velocity factor	1	1

A.3 Initial Setting

(4 of 4)

Function	Initialize method	
	Power on or preset	*RST
Time domain (Option 70) Time domain Start time Stop time Conversion Mode Window Gate (Option 70) Gate function Gate start time Gate stop time Gate shape	OFF 0sec - BAND PASS NORMAL OFF 0sec 10nsec NORMAL	OFF 0sec - BAND PASS NORMAL OFF 0sec 10nsec NORMAL
CDMA IF filter analysis CDMA IF filter gate function CDMA IF filter gate start time CDMA IF filter gate stop time CDMA IF filter gate shape CDMA IF filter magnitude analysis Search attenuation Guaranteed attenuation measurement First frequency Second frequency Phase linearity analysis	OFF 0sec 6μsec CDMA IF OFF 6dB 900kHz 1.2MHz OFF	OFF 0sec 6μsec CDMA IF OFF 6dB 900kHz 1.2MHz OFF

A.4 Soft Key Menu List

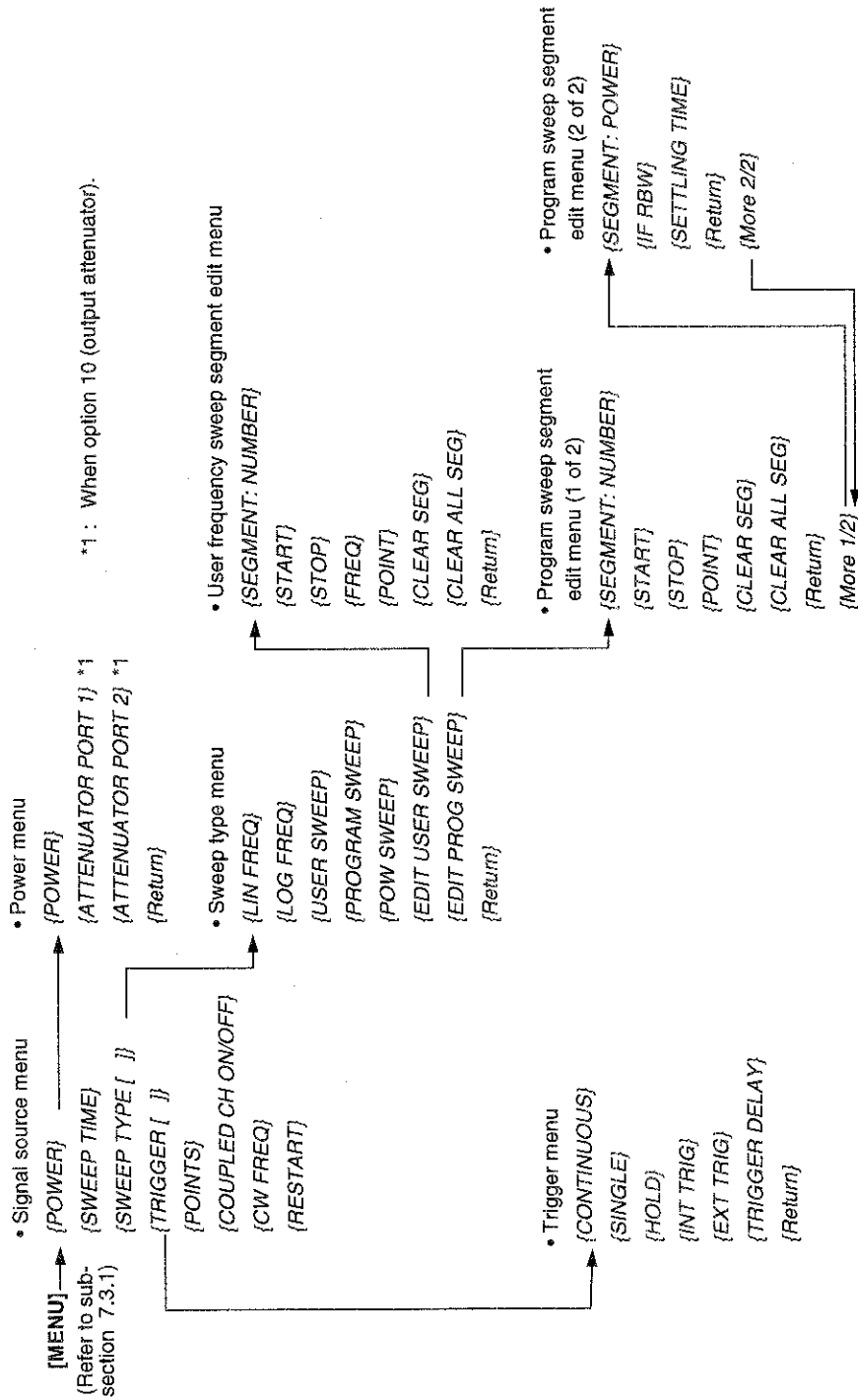

A.4 Soft Key Menu List

*2: When R3765AH/3767AH +S parameter and R3765CH/3767CH.

*3: When R3765AH/67AH.

*4: When R3765BH/67BH.

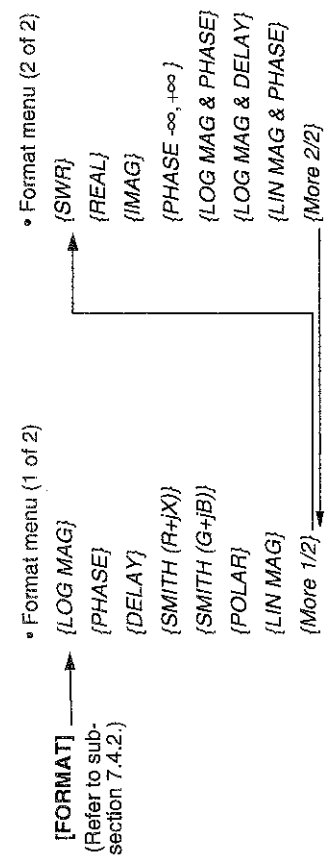
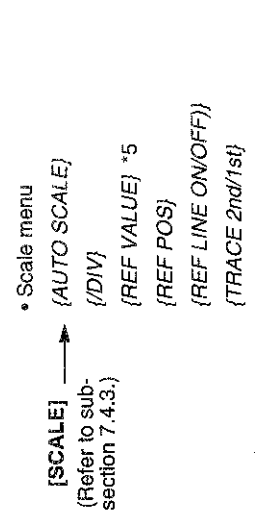
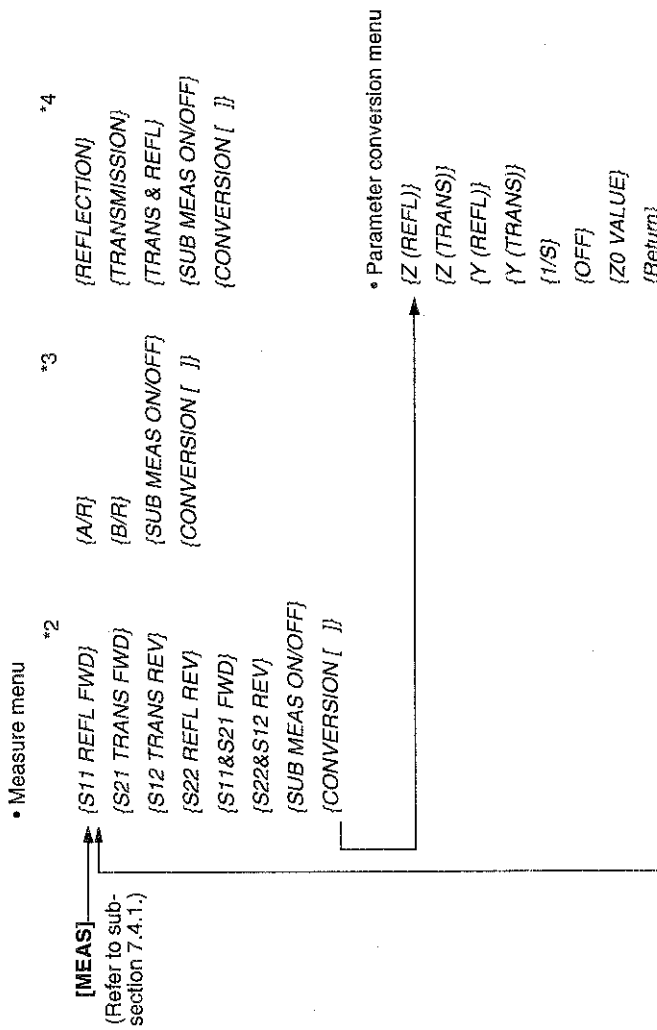

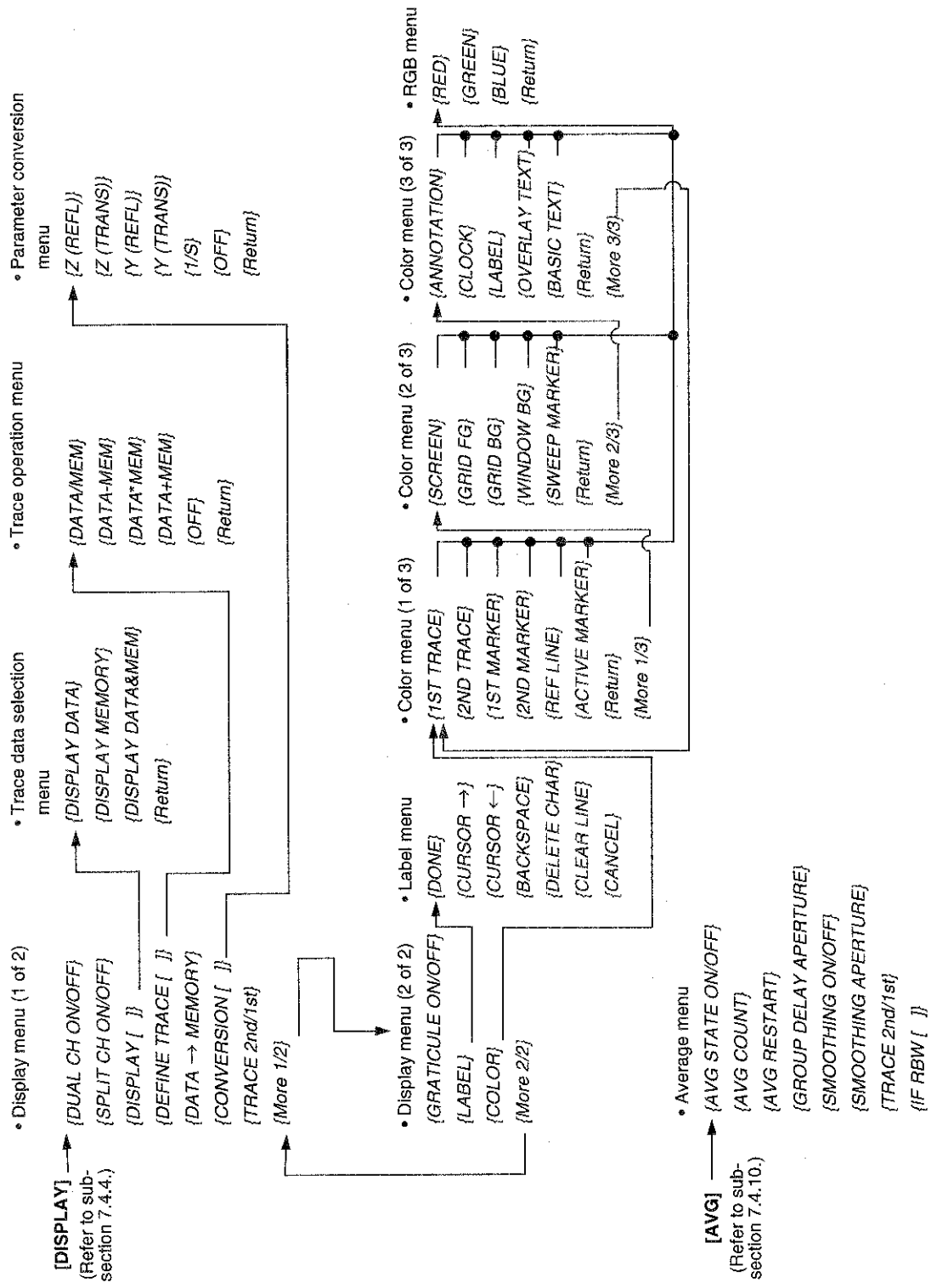

A.4 Soft Key Menu List

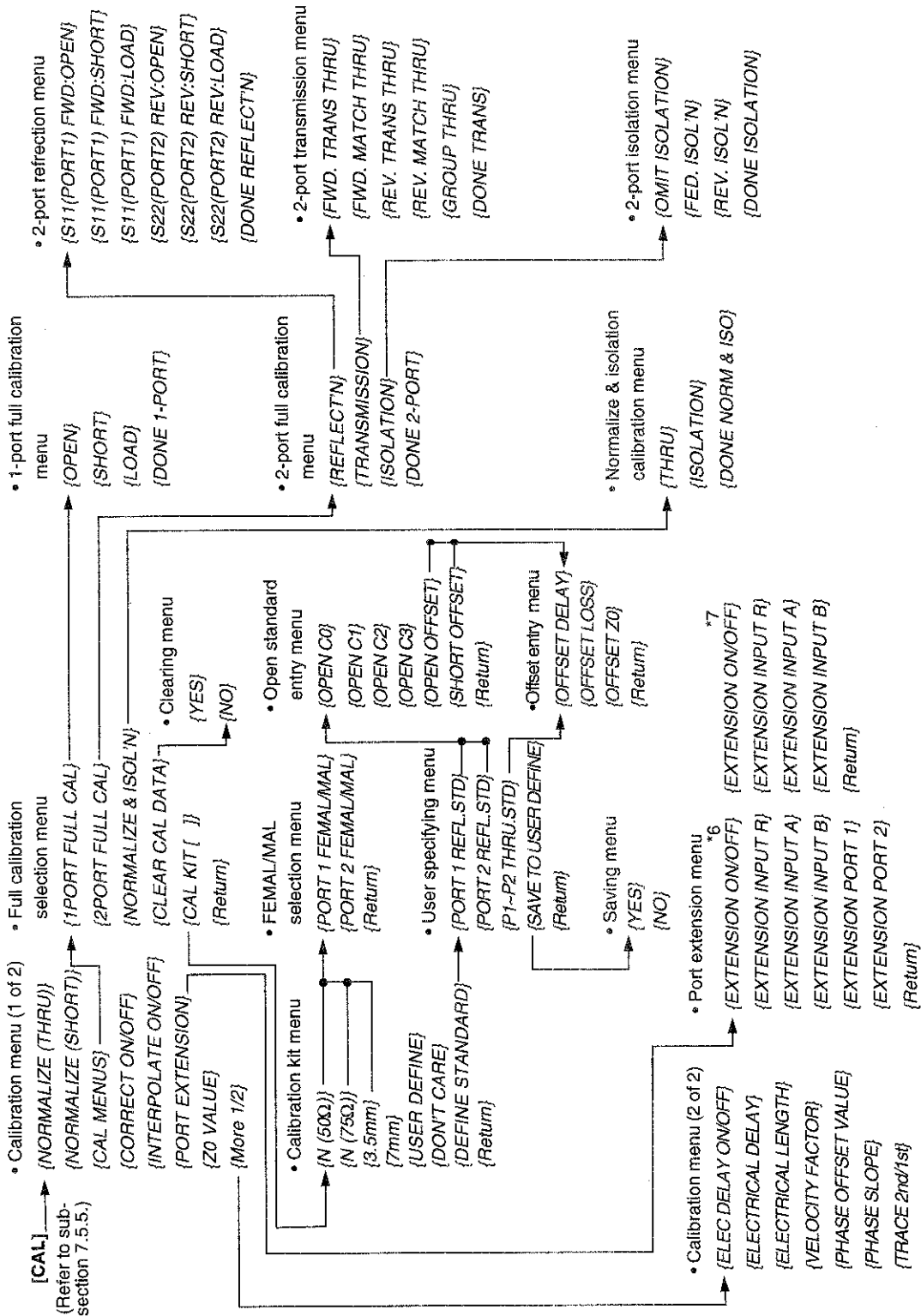

*6: When R3765AH/3767AH +S parameter, R3765BH/3767BH and R3765CH/3767CH.

*7: When R3765AH/3767AH.

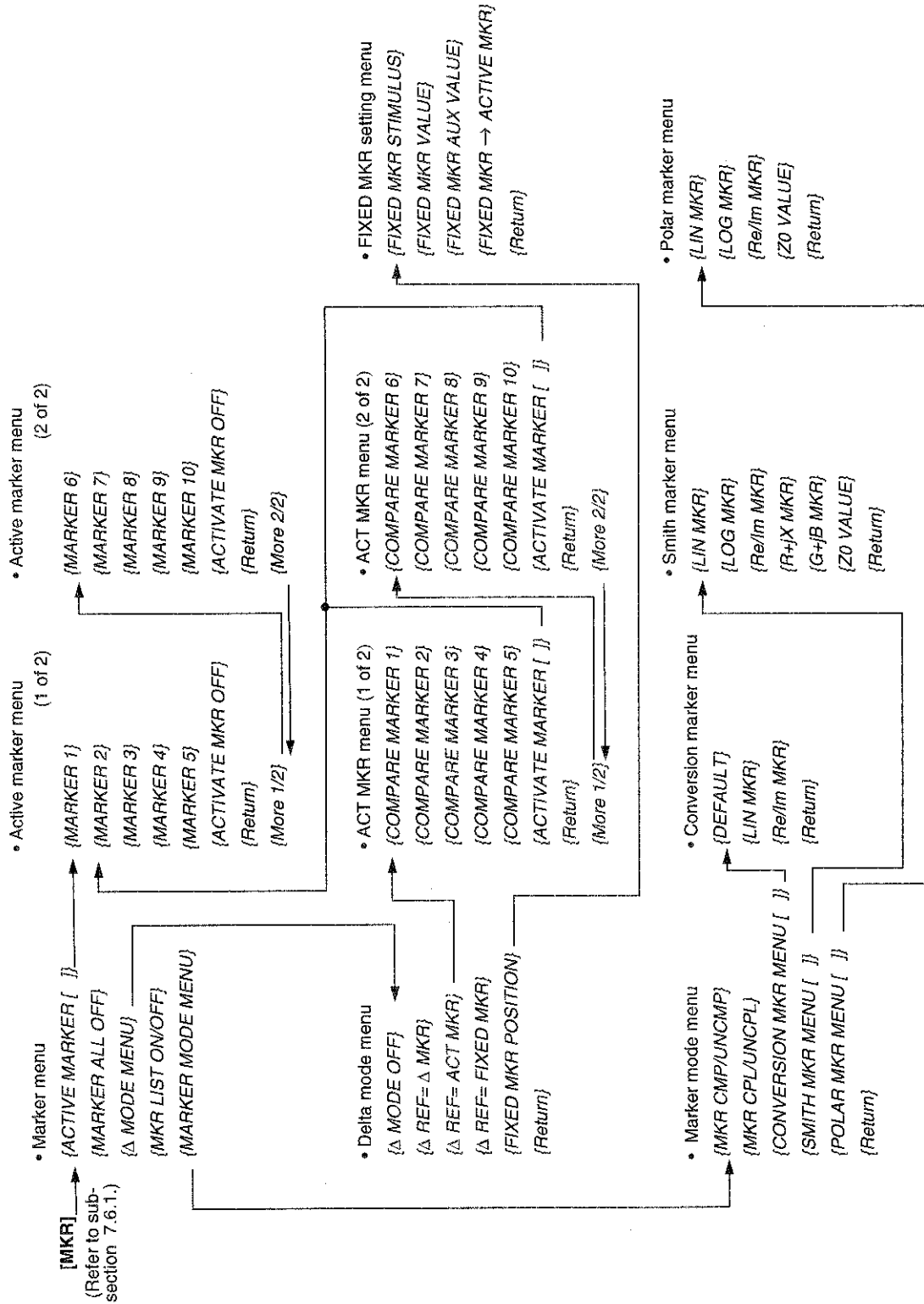

A.4 Soft Key Menu List

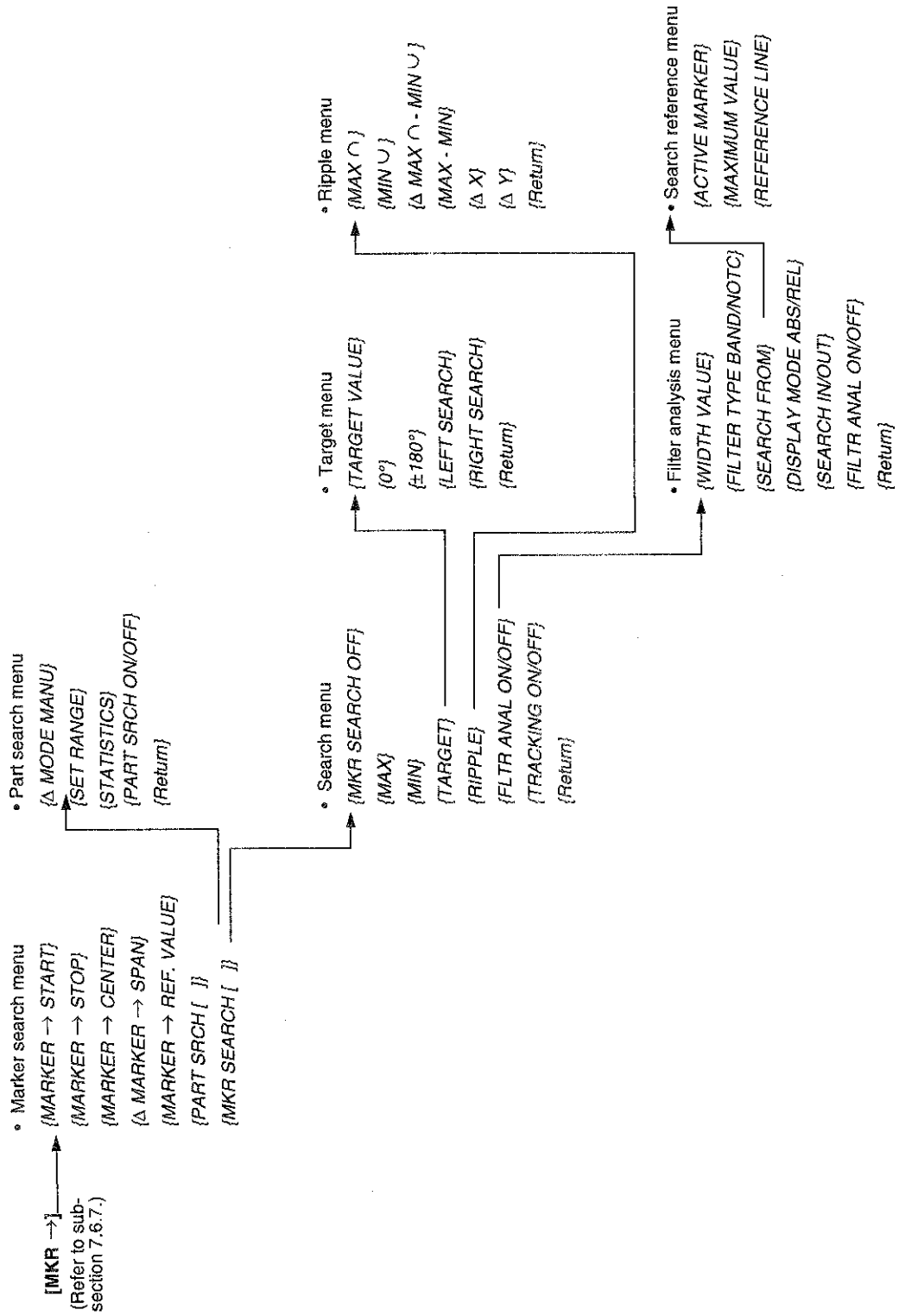

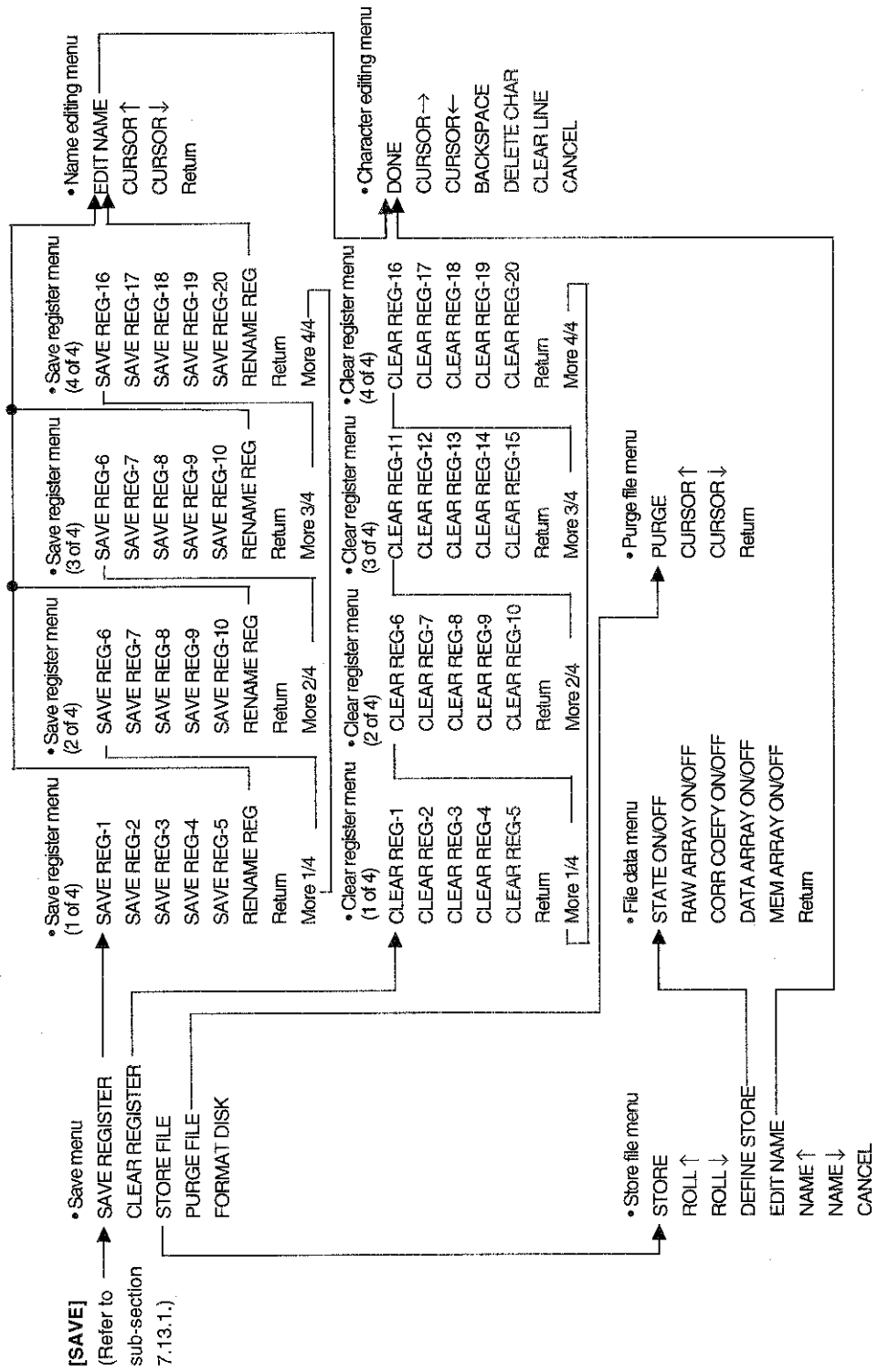

A.4 Soft Key Menu List

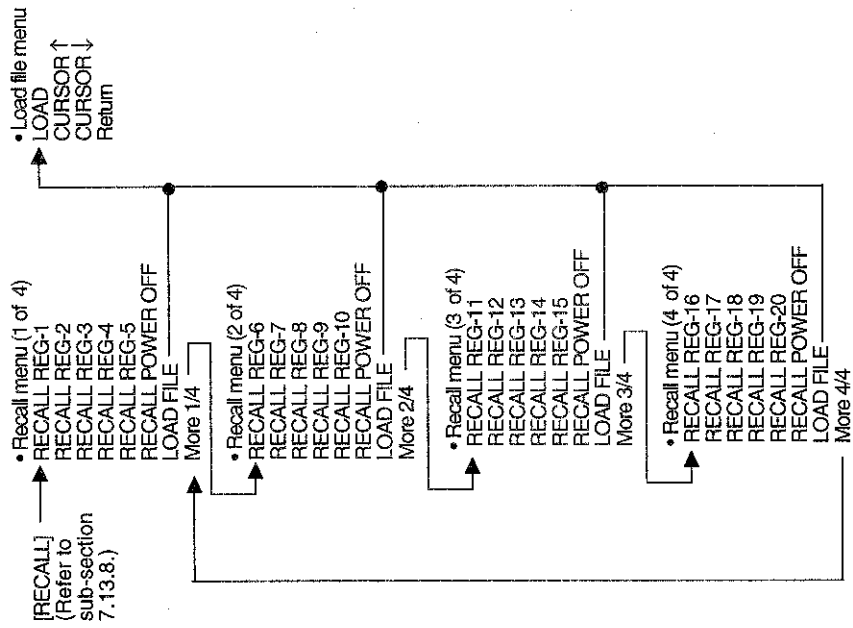

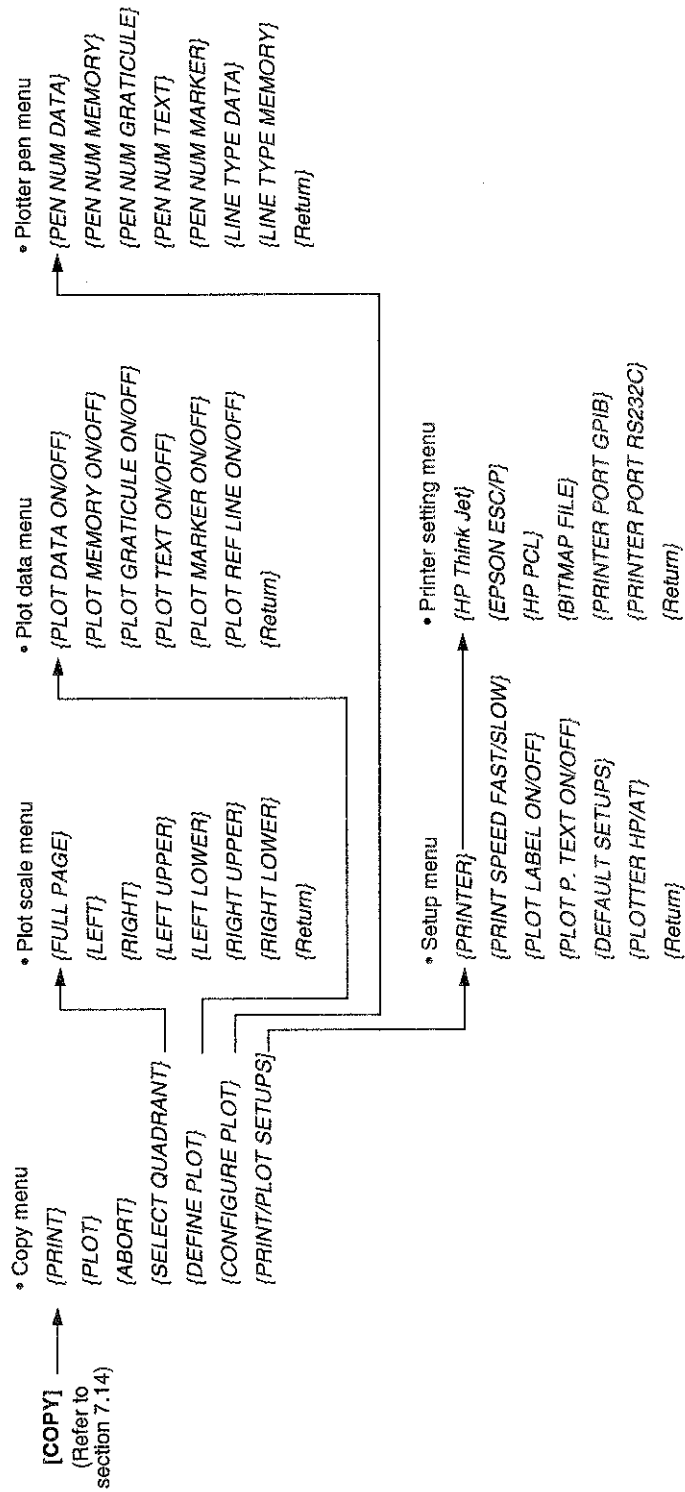

A.4 Soft Key Menu List

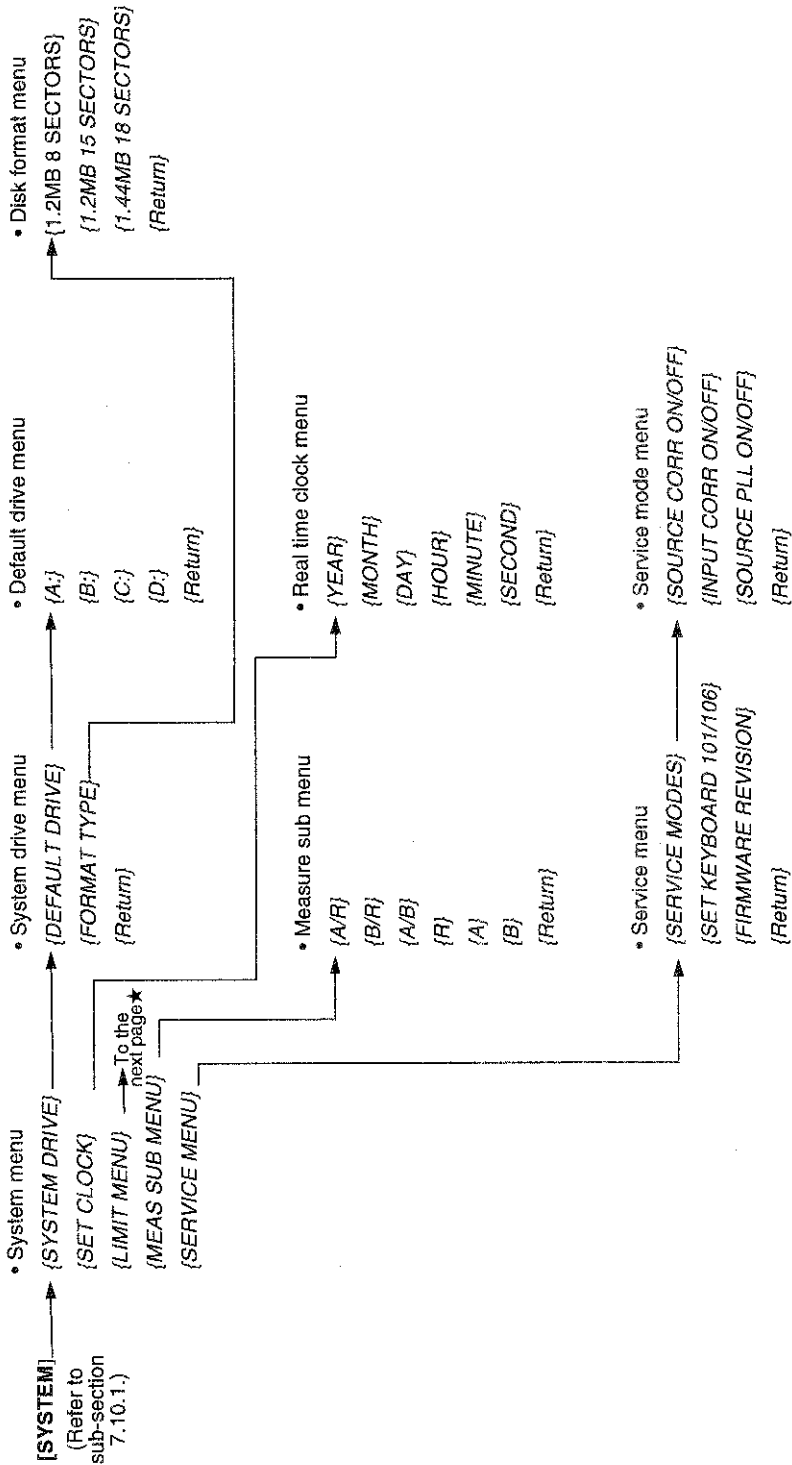

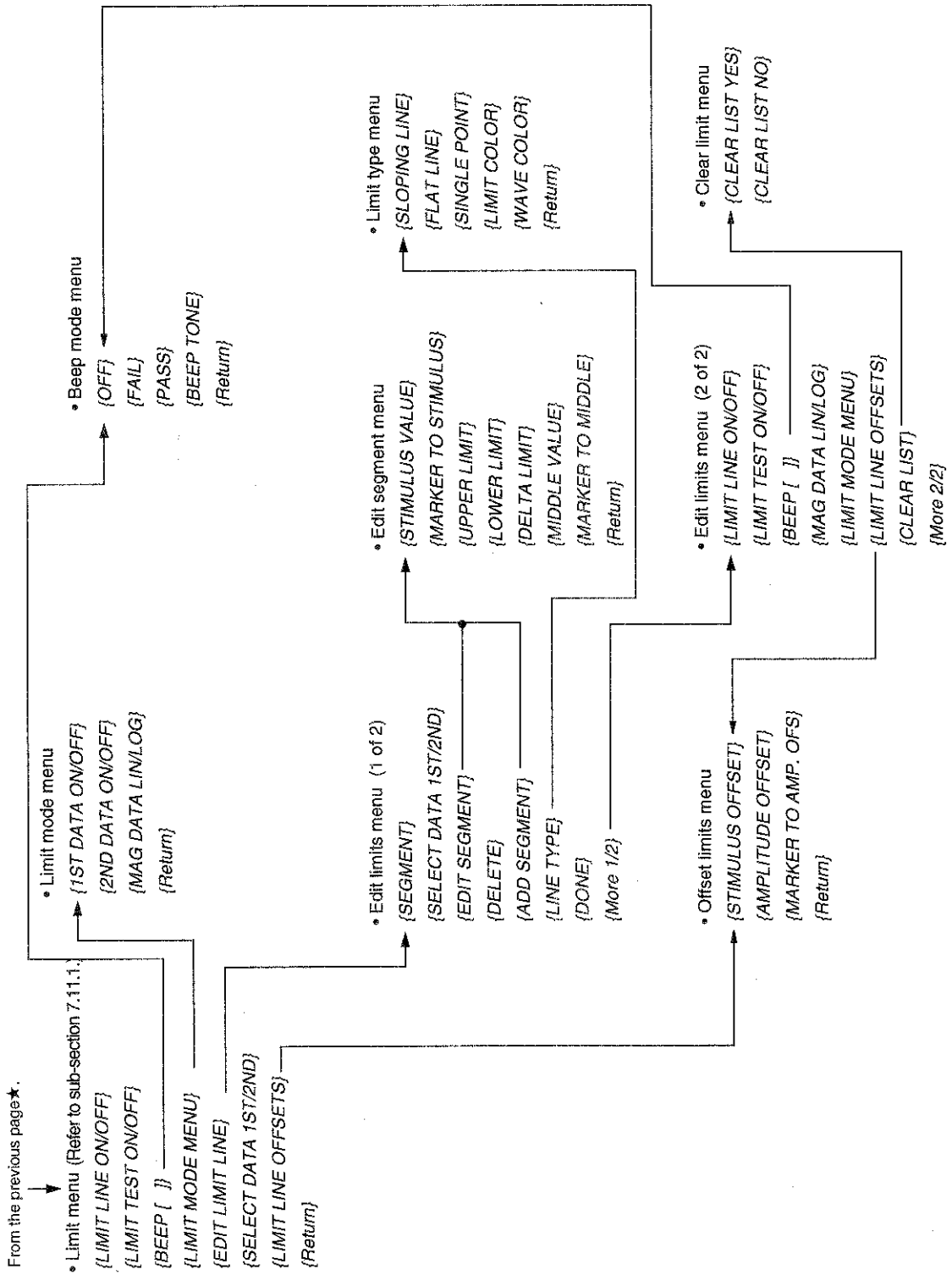

A.4 Soft Key Menu List

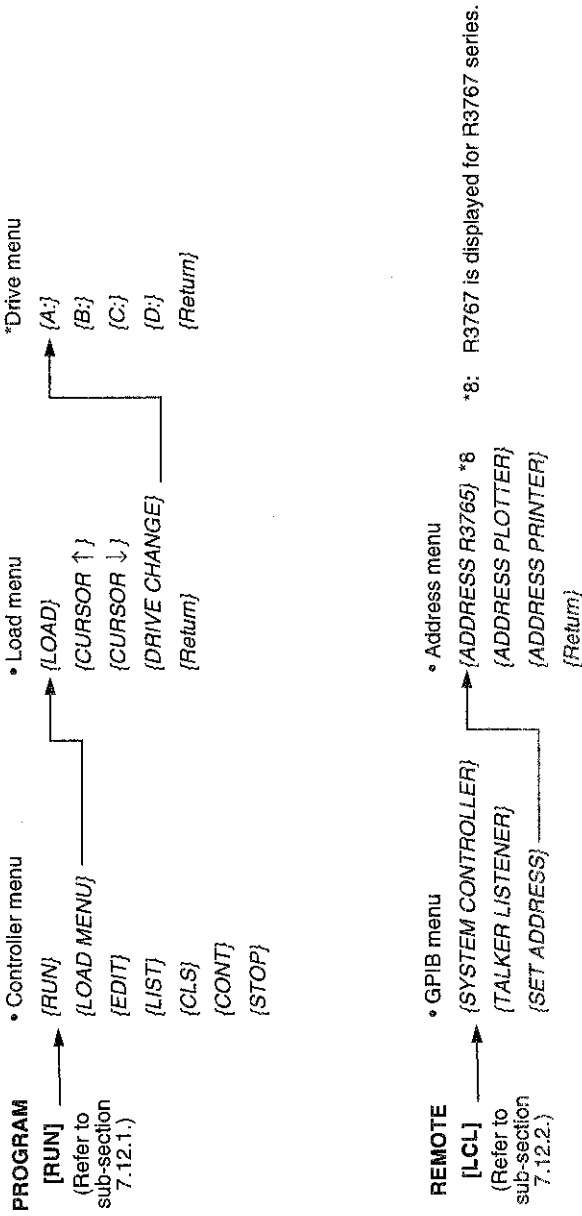

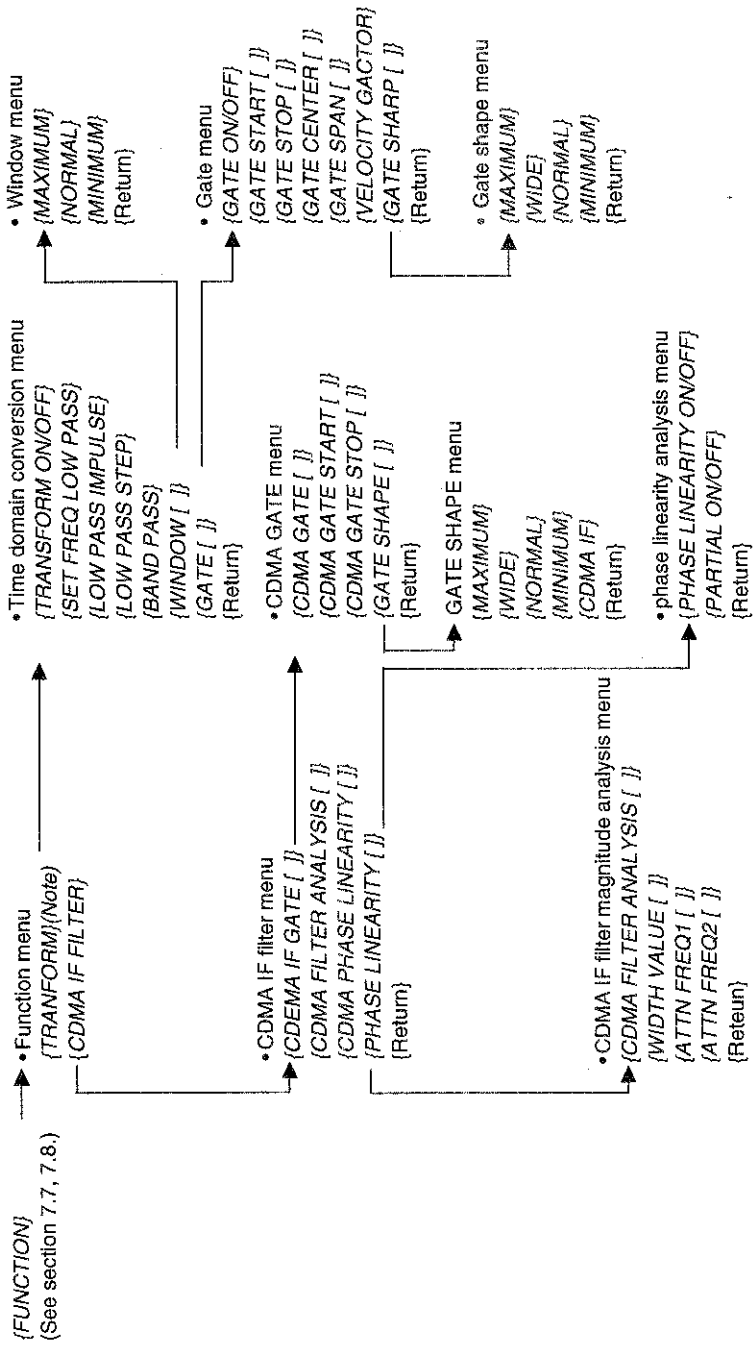

Note: The Time domain function is optional (Option 70).
This function is not available if this option has not been installed.)

A.5 Other Information

A.5 Other Information

A.5.1 Error Message

It's described in chapter "8 IN ABNORMALITIES" of this manual.

- Hardware Trouble Refer to sub-section 8.2.1.
- Notice of Hardware Information Refer to sub-section 8.2.2.
- Operating Error Refer to sub-section 8.2.3.
- Warning of internal set, change, etc. Refer to sub-section 8.2.4.
- Notice of the Completion and the State of Operation. Refer to sub-section 8.2.5.

A.5.2 Setting of Backup Memory (at the factory-shipped)

Item	Initial value
GPIB address	11
System controller/Addressable	Addressable
Printer GPIB address	18
Plotter GPIB address	5
Save register	All clear

A.5.3 GPIB Command List for Panel Key/Soft Key

It's described in a separate-volume "Programming manual" part 2/Appendix A2.

Refer to the following pages.

- A2. GPIB command list for panel key/soft key A2-1
- A2.1 ACTIVE CHANNEL block. A2-2
- A2.2 STIMULUS block A2-2
- A2.3 RESPONSE block A2-7
- A2.4 INSTRUMENT STATE block A2-37
- A2.5 GPIB block A2-52

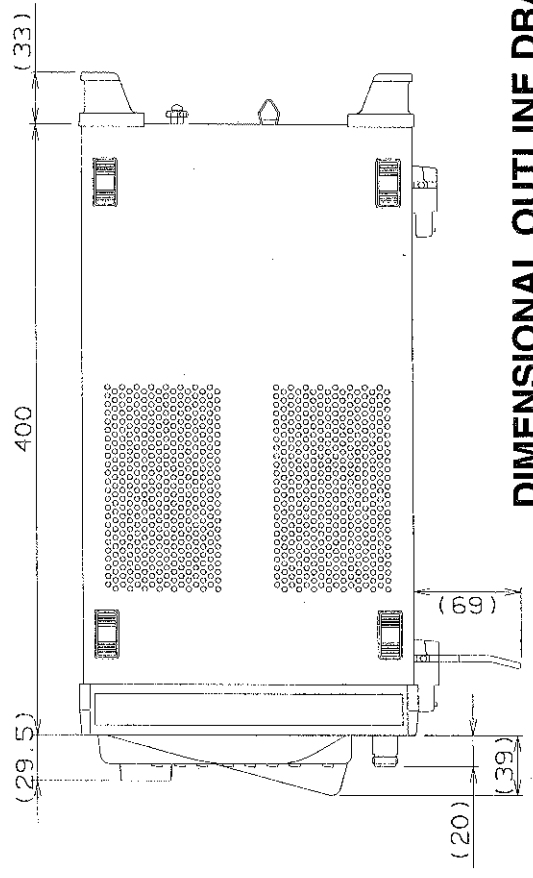
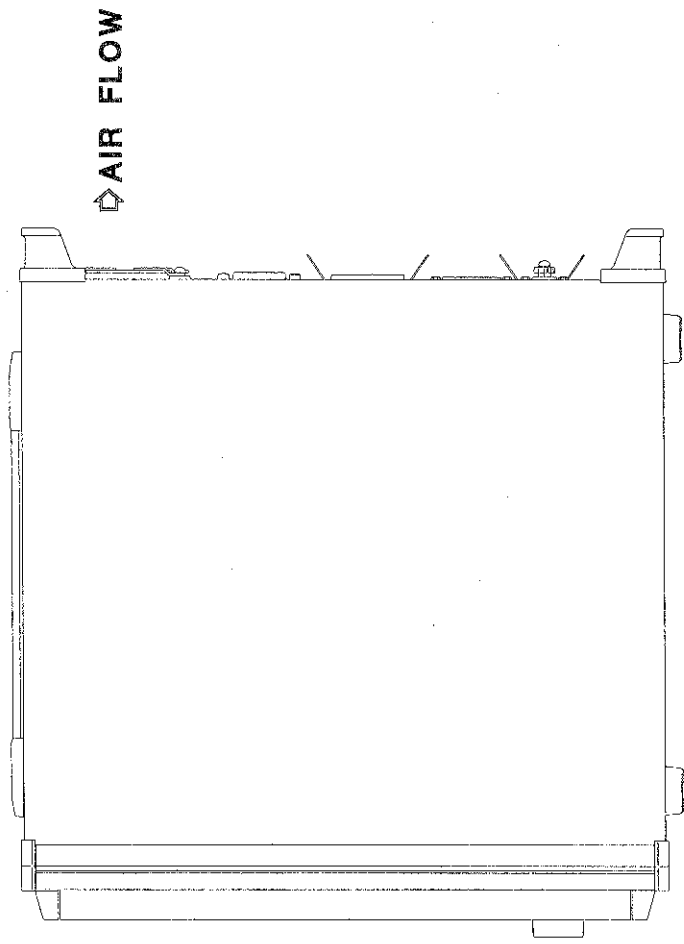
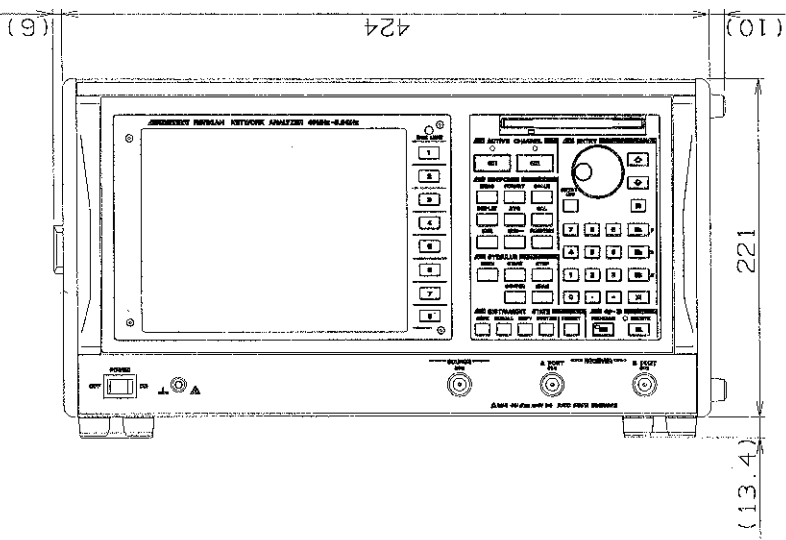

DIMENSIONAL OUTLINE DRAWING

Unit : mm

CAUTION

This drawing shows external dimensions of this instrument.
The difference in products and options used can cause a change in the appearance of the instrument.

ALPHABETICAL INDEX

[Panel keys]		A measurement sample of 6dB bandwidth . 3-13
[0 to 9]	7-3	ACT MKR menu
[-]	7-3	ACT MKR mode
[.]	7-3	ACTIVE CHANNEL Block
[↑]	7-4	Active marker menu
[↓]	7-4	Address menu
[AVG]	7-9	Annotation on the Screen
[BS]	7-3	(Annotation Character)
[CAL]	7-9	Average menu
[CENTER]	7-5	Averaging
[CH 1]	7-2	Averaging process
[CH 2]	7-2	Averaging/Smoothing and Resolution
[COPY]	7-74	Bandwidth
[DISPLAY]	7-9	AVG
[ENTRY OFF]	7-3	
[FORMAT]	7-9	[B]
[FUNCTION]	7-9	Basic Key Operation Examples
[MEAS]	7-9	Basic Measuring Procedure
[MENU]	7-5	BASICS OPERATION
[MKR→]	7-9	BEEP
[MRK]	7-9	Beep mode menu
[PRESET]	7-74	Block Diagram
[RECALL]	7-74	
[SAVE]	7-74	[C]
[SCALE]	7-9	CAL
[SPAN]	7-5	Cal kit menu
[START]	7-5	Calibration
[STOP]	7-5	Calibration (1- port full calibration)
[SYSTEM]	7-74	Calibration (Normalize)
		Calibration (two port full calibration)
		Calibration Data Clear
		Calibration kit menu
		Calibration Kit Selection
		Calibration menu
		Calibration Method
		CDMA IF Filter Analysis Function
		Character edit menu
		Character editing menu
		Character menu
		Cleaning
		Clear limit menu
		Clear register menu
		Clearing menu
		Clearing Saved Register
		Color menu
		Colors Settings
		Communication with Peripheral Devices ..
		Completed Operation Conditions
		Messages
[Δ]		
Δ MKR mode	7-49	
Δ REF=Δ MKR	7-50	
Δ REF=ACT MKR	7-50	
Δ REF=FIXED MKR	7-50	
[Numeric]		
1- port full calibration menu	A-12	
1-Port Full Calibration	7-28	
1-port full calibration	7-33	
2- port refraction menu	A-12	
2- port transmission menu	A-12	
2-Port Full Calibration	7-29	
2-port full calibration	7-34	
2-port full calibration menu	A-12	
2-port isolation menu	A-12	
[A]		
A measurement sample of 3dB bandwidth .	3-12	

Alphabetical Index

Confirmation of Product and AccessoriesPreface-4
 Connecting the Power Cable 1-4
 Controller Menu 7-84
 Controller menuA-20
 Conversion marker menu 7-52, A-13
 Transformation Mode 7-64
 COPYA-17
 Copy menu 7-96, A-17
 Crosstalk 10-14

[D]

Data Flow 9-2
 Default drive menu 7-75, A-18
 Delta mode menu 7-50, A-13
 Delta-Marker Function 7-49
 DIP switches 7-100
 Directivity 10-7
 Disk format menu 7-76, A-18
 DISPLAYA-11
 Display Data Format 7-12
 Display Layout 7-15
 Display menu 7-14, A-11
 Displaying Marker Read out Value 7-48
 Drive menu 7-84, A-20

[E]

Edit limit menu 7-79
 Edit limits menuA-19
 Edit segment menu 7-81, A-19
 Editing Segment of Program Sweep 7-72
 Editing Segment of User Frequency Sweep 7-71
 ENTRY Block 7-3
 ENTRY OFF key 7-4
 Entry off key 3-6
 Error Messages 8-2
 Executing Recall 7-93
 Executing Save Register 7-87
 Executing Store File 7-89
 Extending Measurement Reference Plane 7-41

[F]

FEMAL/MAL selection menu 7-39, A-12
 FET Probe 1-5
 File data menu 7-89, A-15
 File List Display 7-87
 Filter analysis menu 7-57, A-14
 FIXED MKR mode 7-49
 FIXED MKR setting menu A-13
 FORMATA-10
 FORMAT ARRAY 6-8

Format menu7-12, A-10
 Four Screen Display 5-15
 Four Screen Display and Display Selection Information 7-14
 Frequency Accuracy and Range 10-3
 Front-Panel Descriptions (R3765AH/3767AH) 2-1, 2-2
 Front-Panel Descriptions (R3765BH/3767BH) 2-3, 2-4
 Front-Panel Descriptions (R3765CH/3767CH) 2-5, 2-6
 Full calibration selection menu A-12

[G]

Gate Function 7-66
 Gate function 7-67
 GETTING STARTED 1-1
 GO/NG Measurement Using Limit Line Function 5-33
 GPIB Block 7-83
 GPIB Menu 7-85
 GPIB menu A-20
 Group delay measurement 3-15

[H]

Hard Copy 7-96
 Hardware Trouble 8-2
 High-speed Measurement Using the Program Sweep Function 5-29
 How to Initialize 4-3
 How to Read the Display Screen 3-7

[I]

Impedance Measurement 3-25
 IN ABNORMALITIES 8-1
 Initial Power-on 3-1
 Initial Setting A-4
 Initial Setup 4-3
 Initial Setup Value 4-3
 Input Signal Level Overload Cautions 1-6
 Inspection and Simple Troubleshooting 8-1
 INSTRUMENT STATE Block 7-74
 Interlocking between Channels 7-7
 Interpolating Calibration Data 7-37
 Interpolation between Measurement 7-48

[L]

Label Input 7-22
 Label menu 7-22, A-11
 Label Window Display 7-22, 7-90
 LCL A-20

Limit Function 7-77
 Limit Menu 7-77
 Limit menu A-19
 Limit mode menu 7-78, A-19
 Limit type menu 7-82, A-19
 Linear Magnitude/Phase Measurement 5-7
 Linear magnitude/phase measurement 5-4
 Load file menu 7-95, A-16
 Load Match 10-8
 Load menu 7-84, A-20
 Logarithmic Magnitude/Group Delay
 Measurement 5-7
 Logarithmic magnitude/group delay
 measurement 5-3
 Logarithmic Magnitude/Phase Measurement 5-6

[M]

Magnitude analysis function 7-67
 Magnitude measurement 3-11
 Magnitude/Phase Measurement 5-2, 5-3
 Marker Analysis Function 7-53
 Marker Coupling between Channels 7-46
 Marker Function 7-44
 Marker menu A-13
 Marker Menu during Impedance
 Measurement 7-52
 Marker mode menu 7-52, A-13
 Marker search menu 7-54, A-14
 MEAS A-10
 Measure menu A-10
 Measure sub menu 7-76, A-18
 Measurement menu 7-10
 MEASUREMENT METHOD EXAMPLE 5-1
 Measurement of Electrical Length 5-26
 Measurement of Transmission
 Characteristic (2 Trace Display) 5-1
 Measurement Samples of Simple
 Reflection Characteristics 3-17
 Measurement Samples of Simple
 Transmission Characteristics 3-9
 Measurement Time 1-6
 Measuring Time A-3
 MEM ARRAY 6-8
 MENU A-9
 MKR A-13
 MKR→ A-14
 Multi-marker List Display 5-21

[N]

Name edit menu A-15
 Name editing menu 7-90, A-15

Narrow Band/Wide Band Sweep
 Measurement 5-19
 Noise Level 10-13
 Normalize & Isolation Calibration 7-28
 Normalize & isolation calibration 7-32
 Normalize & isolation calibration menu A-12
 Normalizing 7-27
 Normalizing (reflection) 7-31
 Normalizing (transfer) 7-31
 Notes on the use of Parallel I/O Ports 1-6
 Notes on the use of Serial I/O ports 1-6
 Notes on Use 1-9
 Notice of Hardware Information 8-3
 Numeric keys 7-3

[O]

Offset Entry menu 7-40
 Offset entry menu A-12
 Offset limit menu 7-82
 Offset limits menu A-19
 OPEN Standard Entry Menu 7-40
 Open standard entry menu A-12
 Operating Environment 1-2
 Operating Error 8-4
 Option 70 7-64
 Output Level Accuracy and Flatness 10-4
 Output Level Linearity 10-5
 Output of Measured Data to the Plotter 6-1
 Overlap Display Mode (Two Traces
 per Screen Measurement) 5-1

[P]

PANEL DESCRIPTION 2-1
 Panel Keys 3-3
 Parallel I/O Port 7-104
 Parameter conversion menu ... 7-11, A-10, A-11
 Parameters Entry of an User-selected
 Calibration Kit 7-39
 Part search menu 7-63, A-14
 PERFORMANCE TEST 10-1
 Phase analysis function 7-67
 Phase measurement 3-13
 Plot data menu 7-98, A-17
 Plot scale menu 7-97, A-17
 Plotter pen menu 7-99, A-17
 Plotter Setup 7-100
 Polar marker menu 7-53, A-13
 Port extension menu 7-42, A-12
 Power menu 7-6, A-9
 Power Supply Specifications 1-3
 Preparing for a Performance Test 10-1

Alphabetical Index

Printer setting menuA-17
 Printer Setup7-102
 Printer setup menu7-102
 Product Description1-1
 Program sweep segment edit menuA-9
 Program sweep segment editing menu7-72
 Purge file menuA-15
 Purges files menu7-93
 Purging Stored File7-93

[R]

RAW ARRAY6-8
 Real time clock menuA-18
 Real-time clock menu7-76
 Rear Panel Descriptions (R3765A/3767A) ...2-7
 Rear Panel Descriptions (R3765AH/3767AH) 2-8
 Rear Panel Descriptions (R3765B/3767B) .2-10
 Rear Panel Descriptions (R3765BH/3767BH) 2-9
 Rear Panel Descriptions
 (R3765CH/3767CH)2-11, 2-12
 RECALLA-16
 Recall menu7-93, A-16
 RECORD and OUTPUT6-1
 Reflection Coefficient Measurement3-23
 Register List Display7-90
 Replace the Protective Fuse for Bias Input ..1-7
 Replacing the Power Fuse1-3
 Required Measurement Instrument
 for Performance Test10-1
 RESPONSE Block7-9
 Return Loss Measurement3-22
 RGB menuA-11
 Ripple Measurement in the Bandwidth5-23
 Ripple menu7-55, A-14
 RS-232 Interface7-113
 RUNA-21

[S]

S Parameter Measurement3-25
 SAVEA-15
 Save menu7-86, A-15
 Save register7-86
 Save register menu7-87, A-15
 Save/Recall7-86
 Saving Menu7-40
 Saving menuA-12
 Saving to the Floppy Disk6-6
 Scale menu7-13, A-10
 Screen Display Descriptions2-13
 Search menu7-54, A-14
 Selecting Plot Data7-98

Selection of Save Type7-86
 Service menu7-76, A-18
 Service mode menu7-76, A-18
 Setting Backup Memory4-6
 Setting Display Coordinate Scale7-13
 Setting File Name7-91
 Setting Input and Parameter Conversion ...7-10
 Setting Marker7-45
 Setting Plot Scale7-97
 Setting Register Name7-90
 Setting Signal Source7-6
 Setting Sweep Type7-70
 Setup menu7-100, A-17
 Signal source menu7-6, A-9
 Smith marker menu7-52, A-13
 Smoothing7-26
 Smoothing process7-26
 Soft Key Menu Configuration4-2
 Soft Key Menu ListA-9
 Soft Keys3-3
 SPECIFICATIONS11-1
 Specifying Pen7-99
 Split Display5-5
 Standard attachmentPreface-4
 Standing Wave Ratio (SWR) Measurement 3-24
 statistical analysis function7-63
 Status Display7-37
 Step key7-4
 STIMULUS Block7-5
 Storage1-8
 Store file7-86
 Store file menu7-89, A-15
 Supply Description1-3
 Sweep7-70
 Sweep type menu7-70, A-9
 SYSTEMA-18
 System drive menu7-75, A-18
 System Menu7-75
 System menuA-18
 System Setup Cautions1-6

[T]

Target menu7-55, A-14
 THE BASICS3-1
 THE PRINCIPLE9-1
 The Relation of Data between each Function A-1
 Time Domain Function7-64
 Trace Data Selection7-20
 Trace data selection menu7-20, A-11
 TRACE Operation7-21
 Trace operation menu7-21, A-11

Transmission Reflection Characteristic
 Measurement (Four Screen Display Mode) ..5-8
 Transportation 1-8
 Trigger menu 7-7, A-9
 Two Channels Simultaneous Display 5-20

[U]

Unit key7-4
 User frequency sweep segment edit menu ..A-9
 User frequency sweep segment
 editing menu7-71
 User specifying menu 7-40, A-12
 Using the Save/Recall Register 6-4

[W]

Warning of Internal Set, Change, etc. 8-9
 Window Processing7-65

IMPORTANT INFORMATION FOR ADVANTEST SOFTWARE

PLEASE READ CAREFULLY: This is an important notice for the software defined herein. Computer programs including any additions, modifications and updates thereof, operation manuals, and related materials provided by Advantest (hereafter referred to as "SOFTWARE"), included in or used with hardware produced by Advantest (hereafter referred to as "PRODUCTS").

SOFTWARE License

All rights in and to the SOFTWARE (including, but not limited to, copyright) shall be and remain vested in Advantest. Advantest hereby grants you a license to use the SOFTWARE only on or with Advantest PRODUCTS.

Restrictions

- (1) You may not use the SOFTWARE for any purpose other than for the use of the PRODUCTS.
- (2) You may not copy, modify, or change, all or any part of, the SOFTWARE without permission from Advantest.
- (3) You may not reverse engineer, de-compile, or disassemble, all or any part of, the SOFTWARE.

Liability

Advantest shall have no liability (1) for any PRODUCT failures, which may arise out of any misuse (misuse is deemed to be use of the SOFTWARE for purposes other than its intended use) of the SOFTWARE. (2) For any dispute between you and any third party for any reason whatsoever including, but not limited to, infringement of intellectual property rights.

LIMITED WARRANTY

1. Unless otherwise specifically agreed by Seller and Purchaser in writing, Advantest will warrant to the Purchaser that during the Warranty Period this Product (other than consumables included in the Product) will be free from defects in material and workmanship and shall conform to the specifications set forth in this Operation Manual.
2. The warranty period for the Product (the "Warranty Period") will be a period of one year commencing on the delivery date of the Product.
3. If the Product is found to be defective during the Warranty Period, Advantest will, at its option and in its sole and absolute discretion, either (a) repair the defective Product or part or component thereof or (b) replace the defective Product or part or component thereof, in either case at Advantest's sole cost and expense.
4. This limited warranty will not apply to defects or damage to the Product or any part or component thereof resulting from any of the following:
 - (a) any modifications, maintenance or repairs other than modifications, maintenance or repairs (i) performed by Advantest or (ii) specifically recommended or authorized by Advantest and performed in accordance with Advantest's instructions;
 - (b) any improper or inadequate handling, carriage or storage of the Product by the Purchaser or any third party (other than Advantest or its agents);
 - (c) use of the Product under operating conditions or environments different than those specified in the Operation Manual or recommended by Advantest, including, without limitation, (i) instances where the Product has been subjected to physical stress or electrical voltage exceeding the permissible range and (ii) instances where the corrosion of electrical circuits or other deterioration was accelerated by exposure to corrosive gases or dusty environments;
 - (d) use of the Product in connection with software, interfaces, products or parts other than software, interfaces, products or parts supplied or recommended by Advantest;
 - (e) incorporation in the Product of any parts or components (i) provided by Purchaser or (ii) provided by a third party at the request or direction of Purchaser or due to specifications or designs supplied by Purchaser (including, without limitation, any degradation in performance of such parts or components);
 - (f) Advantest's incorporation or use of any specifications or designs supplied by Purchaser;
 - (g) the occurrence of an event of force majeure, including, without limitation, fire, explosion, geological change, storm, flood, earthquake, tidal wave, lightning or act of war; or
 - (h) any negligent act or omission of the Purchaser or any third party other than Advantest.
5. **EXCEPT TO THE EXTENT EXPRESSLY PROVIDED HEREIN, ADVANTEST HEREBY EXPRESSLY DISCLAIMS, AND THE PURCHASER HEREBY WAIVES, ALL WARRANTIES, WHETHER EXPRESS OR IMPLIED, STATUTORY OR OTHERWISE, INCLUDING, WITHOUT LIMITATION, (A) ANY WARRANTY OF MERCHANTABILITY OR FITNESS FOR A PARTICULAR PURPOSE AND (B) ANY WARRANTY OR REPRESENTATION AS TO THE VALIDITY, SCOPE, EFFECTIVENESS OR USEFULNESS OF ANY TECHNOLOGY OR ANY INVENTION.**
6. **THE REMEDY SET FORTH HEREIN SHALL BE THE SOLE AND EXCLUSIVE REMEDY OF THE PURCHASER FOR BREACH OF WARRANTY WITH RESPECT TO THE PRODUCT.**
7. **ADVANTEST WILL NOT HAVE ANY LIABILITY TO THE PURCHASER FOR ANY INDIRECT, INCIDENTAL, SPECIAL, CONSEQUENTIAL OR PUNITIVE DAMAGES, INCLUDING, WITHOUT LIMITATION, LOSS OF ANTICIPATED PROFITS OR REVENUES, IN ANY AND ALL CIRCUMSTANCES, EVEN IF ADVANTEST HAS BEEN ADVISED OF THE POSSIBILITY OF SUCH DAMAGES AND WHETHER ARISING OUT OF BREACH OF CONTRACT, WARRANTY, TORT (INCLUDING, WITHOUT LIMITATION, NEGLIGENCE), STRICT LIABILITY, INDEMNITY, CONTRIBUTION OR OTHERWISE. TORT (INCLUDING, WITHOUT LIMITATION, NEGLIGENCE), STRICT LIABILITY, INDEMNITY, CONTRIBUTION OR OTHERWISE.**
8. **OTHER THAN THE REMEDY FOR THE BREACH OF WARRANTY SET FORTH HEREIN, ADVANTEST SHALL NOT BE LIABLE FOR, AND HEREBY DISCLAIMS TO THE FULLEST EXTENT PERMITTED BY LAW ANY LIABILITY FOR, DAMAGES FOR PRODUCT FAILURE OR DEFECT, WHETHER ARISING OUT OF BREACH OF CONTRACT, TORT (INCLUDING, WITHOUT LIMITATION, NEGLIGENCE), STRICT LIABILITY, INDEMNITY, CONTRIBUTION OR OTHERWISE.**

CUSTOMER SERVICE DESCRIPTION

In order to maintain safe and trouble-free operation of the Product and to prevent the incurrence of unnecessary costs and expenses, Advantest recommends a regular preventive maintenance program under its maintenance agreement.

Advantest's maintenance agreement provides the Purchaser on-site and off-site maintenance, parts, maintenance machinery, regular inspections, and telephone support and will last a maximum of ten years from the date the delivery of the Product. For specific details of the services provided under the maintenance agreement, please contact the nearest Advantest office listed at the end of this Operation Manual or Advantest's sales representatives.

Some of the components and parts of this Product have a limited operating life (such as, electrical and mechanical parts, fan motors, unit power supply, etc.). Accordingly, these components and parts will have to be replaced on a periodic basis. If the operating life of a component or part has expired and such component or part has not been replaced, there is a possibility that the Product will not perform properly. Additionally, if the operating life of a component or part has expired and continued use of such component or part damages the Product, the Product may not be repairable. Please contact the nearest Advantest office listed at the end of this Operation Manual or Advantest's sales representatives to determine the operating life of a specific component or part, as the operating life may vary depending on various factors such as operating condition and usage environment.

SALES & SUPPORT OFFICES

Advantest Korea Co., Ltd.

22BF, Kyobo KangNam Tower,
1303-22, Seocho-Dong, Seocho-Ku, Seoul #137-070, Korea
Phone: +82-2-532-7071
Fax: +82-2-532-7132

Advantest (Suzhou) Co., Ltd.

Shanghai Branch Office:
Bldg. 6D, NO.1188 Gumei Road, Shanghai, China 201102 P.R.C.
Phone: +86-21-6485-2725
Fax: +86-21-6485-2726

Shanghai Branch Office:
406/F, Ying Building, Quantum Plaza, No. 23 Zhi Chun Road,
Hai Dian District, Beijing,
China 100083
Phone: +86-10-8235-3377
Fax: +86-10-8235-6717

Advantest (Singapore) Pte. Ltd.

438A Alexandra Road, #08-03/06
Alexandra Technopark Singapore 119967
Phone: +65-6274-3100
Fax: +65-6274-4055

Advantest America, Inc.

3201 Scott Boulevard, Suite, Santa Clara, CA 95054, U.S.A
Phone: +1-408-988-7700
Fax: +1-408-987-0691

ROHDE & SCHWARZ Europe GmbH

Mühlendorfstraße 15 D-81671 München, Germany
(P.O.B. 80 14 60 D-81614 München, Germany)
Phone: +49-89-4129-13711
Fax: +49-89-4129-13723

ADVANTEST[®]

<http://www.advantest.co.jp>