

---

---

**ADVANTEST®**  
ADVANTEST CORPORATION

---

**R3765/3767 SERIES**  
**NETWORK ANALYZER**  
**OPERATION MANUAL**

MANUAL NUMBER OEA00 9509

---





*Applicable Instruments*

<b>R3765A</b>	<b>R3767A</b>
<b>R3765B</b>	<b>R3767B</b>
<b>R3765C</b>	<b>R3767C</b>

Before reselling to other corporations  
or re-exporting to other countries, you  
are required to obtain permission from  
both the Japanese Government under its  
Export Control Act.

# NOTICE

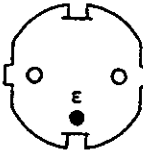
ADVANTEST provides the following power cables for each country.  
If there was any inconvenience on your use, please contact our subsidiaries or ADVANTEST representatives.

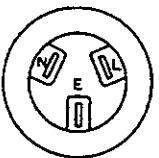
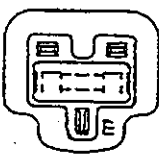
	Plugs	Standards/Countries	Ratings/Color/ Length	Accessory Codes
1		JIS : JAPAN	Rating :125V 7A Color :Black Length :2m	A01402 A01412
2		UL : USA CSA : CANADA	Rating :125V 7A Color :Black Length :2m	A01403 (Opt.95) A01413
3		CEE : EUROPE VDE : FRG OVE : AUSTRIA SEMKO : SWEDEN DEMKO : DENMARK KEMA : NETHERLANDS FIMKO : FINLAND NEMKO : NORWAY CEBEC : BELGIUM	Rating :250V 6A Color :Gray Length :2m	A01404 (Opt.96) A01414
4		SEV : SWITZERLAND	Rating :250V 6A Color :Gray Length :2m	A01405 (Opt.97) A01415
5		SAA : AUSTRALIA NEWZELAND	Rating :250V 6A Color :Gray Length :2m	A01406 (Opt.98)
6		BS : UK	Rating :250V 6A Color :Black Length :2m	A01407 (Opt.99) A01417

Note : "E" shows earth (ground).

# PREFACE

## ■ In the Beginning

This book explains all processes from the acceptance to actually operation of network analyzer R3765/3767 series. The manual of two volumes related about the R3765/3767 series is shown in the following.

Manual name	Model	Strong points	Remarks
R3765/3767 seires Network Analyzer Operating Manual (This book)	R3765A	S parameter can be connected.	3.8GHz model
	R3765B	Bridge is built in.	
	R3765C	S parameter is built in.	
	R3767A	S parameter can be connected.	8.0GHz model
	R3767B	Bridge is built in.	
R3767C	S parameter is built in.		
Network Analyzer Programming Manual (Separate volume)	This manual is shared between all models of R3765/3767 series.		

### CAUTION!

ADVANTEST reserves the right to change the content of this book and other product information without notice.

Do not reproduce and do not reprint all of this book or part without permission ADVANTEST Corporation.

The address and the telephone number of ADVANTEST Corporation are described in the end of this book. Refer for the inquiry etc.

## ■ To be Going to Use it Safely

Fulfill undermentioned caution to use R3765/3767 correctly and safely. ADVANTEST Corporation cannot owe responsibility and the guarantee of the trouble caused by use in contradiction to this caution.

- The following marks are attached to the product to use R3765/3767 safely.



: This is a mark of the meaning of caution.

The thing to have to refer to Operating Manual is shown to protect human body and instrument.



: It is an earth symbol.

The field wiring terminal for which the earth is necessary is shown before instrument is used to prevent the electric shock.

- Do the following caution to prevent the danger to the human body such as the electric shock accidents.

- Power supply voltage:

Confirm the power supply voltage of R3765/3767 is corresponding to the supply voltage before power-on.

- Fuse:

Use the fuse of the standard that conforms power supply voltage.

- Power cable:

- To prevent electric shock and fire, be sure to use the attached power cable.

In foreign countries, use a power cable which conforms to the safety standard of the corresponding country.

- Turn the power switch OFF before connecting the power cable to an outlet.

- When you connect power cable with the outlet, turn off the power switch.

Have the plug when power cable is inserted and pull out from outlet.

- Protective earth:

- Connect power cable to the power outlet that has the protective earth terminal.

When the code for the extension by which the protective earth terminal is not had is used, the protection earth can not be done.

- Case in which use of conversion adapter made two pins from three pins, ground the earth pin of the adapter to the earth of the outlet. Connect ground terminal of the rear panel with the earth of the outside. Moreover, attend to the contact between the adapter and the earth pin.

- Removing of case:

Do not open the case to one except service man of our company.

The analyzer has a high temperature part and a high pressure part.



## ■ How to Read this Manual

### ● Distinction of panel key and software key in this book.

Panel key : Shows with the key of the [ ] .

〈Example〉 [CH1] , [5]

Software key : Shows with the key of the 【 】 .

〈Example〉 【POWER】 , 【LOG MAG】

### ● Mark of caution level in this enclosing

---

**D A N G E R ! :**

Uses it for the case with the possibility of the body trouble and the death.

---

---

**W A R N I N G ! :**

Uses for the remarks of safety and the health of the body.

---

---

**C A U T I O N ! :**

Uses for the remarks of the damage of the machine equipment, fire and for the restriction of use.

---

---

**R E F E R E N C E → :**

Information helpful to you. Point to a page number where it is explained.

---

**N O T E : :**

Uses to explain for the supplementation.

### ● Notation for last page

This book has the page attaching the sign of (\*) to the upper right of the page number.

The sign of (\*) informs the final page of each chapter.

● Organization of this manual

Configuration	Contents	Remarks
Preface	For the first use Confirmation of the products and the attachments. Safety instructions.	Read before first use.
Contents	Table of Contents, Figures, Tables The configuration and the page of the description.	Use to find necessary information easily.
1.	Necessary information before starting the measurement From setting to setup, cautions, cleaning, transportation, and storage.	Read before first use.
2.	Explanation of panel side and display screen Name of each device, function, and operation. Description of display screen.	Usage of the analyzer can be understood by reading it through.
3.	Easy usage Actual example of operation. How to look at the display screen.	
4.	Basic operation Description of the basic items.	Chapters of practice.
5.	Measurement examples Concrete examples and operational procedures.	
6.	Records and output Saving to floppy disk and replaying.	
7.	Description of the functions Detailed explanation of each block.	
8.	In difficulty Diagnostics and error message.	Refer if necessary.
9.	Operating principles Basic operation and flow chart.	
10.	Calibration of the analyzer Performance test.	
11.	Performance specifications Technical information and general information.	
Appendix	Relation of data between each function Initial setting. Software key menu list. Other information.	
Index	Main words and the description page.	Use to find necessary information easily.
Others	External figures.	Use to find the outer dimensions.

## ■ Confirmation of Product and Attachment

When you open packing, confirms the following in the beginning.

If any flaw, damage, and shortage in the product or the attachment, etc., is found, contact the nearest dealer or the sales and support office.

### ● Product main unit

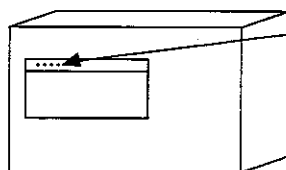

Confirmation position of type and name of product.

Confirm the product the same as the order from the name plate in the front panel.

### ● Standard attachment lists.

**NOTE :** Order the addition of the attachment etc. with type name or stock No.

Name of articles.	Type name	Parts code	Quantity	Remarks
Power cable	A01402	DCB-DD2428X01	1	3pins plug
AC adapter	—	JCD-AL003EX03	1 *1	3→2pin
Power fuse	—	DFT-AA6R3A	2	T6.3A/250V
R3765/3767SERIES	—	JR3765/3767SERIES	1 *2	Japanese
Operating Manual	—	ER3765/3767SERIES		English
Programming manual	—	JR3764/65/66/67(PM)	1 *2	Japanese
	—	ER3764/65/66/67(PM)		English

**NOTE :** \*1: The AC adapter is a standard attachment only to Japan-domestic.

\*2: Japanese or English is one volume.

## ■ Option, Accessory, and Recommended Kit (Extra-cost)

### ● Option

Name	Type	Remarks
Output attenuator	Option 10	0 to 70dB
8GHz output amp	Option 11	R3767A/B/C only

### ● Accessory

Name	Type	Remarks
S Parameter test set	R3961B	300kHz to 3.6GHz
Duplexer test set	R3961T	
Rack-mount kit	A02713	JIS (Front handle attached)
	A02712	EIA (Front handle attached)
Slide rail set	A02642	

### ○ Recommended kit

Name	Type	Remarks	
		Frequency range	Connector type
Calibration kit	Model 9617A3	DC to 18 GHz	N type
Calibration kit	Model 9617F3	DC to 18 GHz	3.5mm type
Calibration kit	Model 9617C3	DC to 4 GHz	N type
Calibration kit	Model 9617H3	DC to 4 GHz	3.5mm type

# TABLE OF CONTENTS

## PREFACE

In the Beginning .....	Preface-1
To be Going to Use it Safely .....	Preface-2
How to Read this Manual .....	Preface-3
Confirmation of Product and Attachment .....	Preface-5
Option, Accessory, and Recommended Kit (Extra-cost) .....	Preface-6

## Chapter 1 BEFORE USE THE PRODUCT

1. Outline of Product .....	1-2
2. Operating Conditions .....	1-3
3. Power source .....	1-5
Checking Power Requirements .....	1-5
Replacing the Power Fuse .....	1-5
Connecting the Power Cable .....	1-6
4. FET Probe .....	1-8
5. Caution of System-up .....	1-9
6. Measurement Time .....	1-9
7. Cautions on the Overload to the Input Part .....	1-9
8. How to Replace the Protective Fuse for Bias Input .....	1-10
9. Cleaning, Storage and Transportation .....	1-11
10. Notes on Use .....	1-12

## Chapter 2 PANEL DESCRIPTION

1. Front Panel Descriptions .....	2-2
R3765A/3767A .....	2-2
R3765B/3767B .....	2-4
R3765C/3767C .....	2-6
2. Rear Panel Descriptions .....	2-8
R3765A/3767A .....	2-8
R3765B/3767B .....	2-10
R3765C/3767C .....	2-12
3. Screen Display Descriptions .....	2-14

## Chapter 3 GETTING STARTED

1. Initial Power-on ..... 3-2
2. Operation Keys ..... 3-4
  - Panel Keys and Soft Keys ..... 3-4
3. How to Read the Display Screen ..... 3-9
4. Basic Measuring Procedure ..... 3-10
5. Measurement Samples of Simple Transmission ..... 3-11
  - Characteristics ..... 3-11
  - Setup and Setting ..... 3-11
  - Calibration (Normalize) ..... 3-13
  - Magnitude measurement ..... 3-14
  - Phase measurement ..... 3-17
  - Group delay time measurement ..... 3-19
6. Measurement Samples of Simple Reflection Characteristics ..... 3-21
  - Setup ..... 3-21
  - Calibration (1 port full calibration) ..... 3-24
  - Measurement by various formats ..... 3-27

## Chapter 4 OPERATION BASICS

1. Keys Necessary for Basic Operation ..... 4-2
2. Samples of Basic Key Operation ..... 4-2
3. Soft Menu Configuration ..... 4-3
4. Initial Setup ..... 4-4
  - How to Initialize ..... 4-4
  - Initial Setup Value ..... 4-4
5. Setting Backup Memory (Factory Default Settings) ..... 4-7

## Chapter 5 MEASUREMENT SAMPLE

1. Measurement of Transmission Characteristic (2 Trace Display) ..... 5-2
  - Overlap Display Mode ..... 5-2
  - Split Display Mode ..... 5-7
2. Measurement of Transmission and Reflection Characteristic ..... 5-11
  - Set-up ..... 5-11
  - Calibration (2 Port Full Calibration) ..... 5-13
  - 4 Screen Display ..... 5-21
3. Measurement of Narrow Bandwidth/Wide Bandwidth ..... 5-27
4. Multi-marker List Display ..... 5-30
5. Measurement of Ripple in Bandwidth ..... 5-33

6. Measurement of Electrical Length .....	5-38
7. High Speed Measurement by Program Sweeping Function .....	5-42
8. GO/NG Measurement by Limit Line Function .....	5-47

## Chapter 6 RECORD and OUTPUT

1. Outputting to the Potter .....	6-2
2. Saving/Recalling into the Save/Recall-register .....	6-6
3. Saving into the Floppy Disk and Recalling .....	6-8
About the Measurement Data to Save .....	6-12

## Chapter 7 FUNCTION DESCRIPTIONS

1. ACTIVE CHANNEL Block .....	7-2
2. ENTRY Block .....	7-4
3. STIMULUS Block .....	7-6
Setting Signal Source .....	7-7
Interlocking between Channels .....	7-9
4. RESPONSE Block .....	7-10
Setting Input and Parameter Conversion .....	7-11
Display Data Format .....	7-14
Setting Display Coordinate Scale .....	7-15
Selection of Four Screens Display and Display Information .....	7-16
Display Layout .....	7-17
TRACE Operation .....	7-23
Label Input .....	7-24
Averaging/Smoothing and Resolution Bandwidth .....	7-25
5. Calibration .....	7-28
Normalizing .....	7-28
Normalize & Isolation Calibration .....	7-29
1-Port Full Calibration .....	7-29
2-Port Full Calibration .....	7-30
Calibration Method .....	7-32
Interpolation of Calibration Data (Calibration Interpolate) .....	7-41
Calibration Kit Selection .....	7-42
Extending Measurement Reference Surface .....	7-44
Calibration Data Clear .....	7-47

6. Marker Function	7-48
Setting Marker	7-49
Marker Coupling between Channels	7-50
Interpolation between Measurement	7-51
Display Marker Read out Value	7-52
Delta-Marker Function	7-52
Marker Menu during Impedance Measurement	7-56
Marker Analysis Function	7-58
7. Sweep	7-65
Setting Sweep Type	7-66
Editing Segment of User Frequency Sweep	7-67
Editing Segment of Program Sweep	7-68
8. INSTRUMENT STATE Block	7-71
System Menu	7-72
9. Limit Function	7-75
Limit Menu	7-75
10. GPIB Block	7-84
Controller Menu	7-85
GPIB Menu	7-86
11. Save/Recall	7-87
Selection of Save Type	7-87
Executing Save Register	7-89
Executing Store File	7-90
Setting Register Name	7-91
Setting File Name	7-93
Clearing Saved Register	7-94
Purging Stored File	7-95
Executing Recall	9-96
12. Hard Copy	7-98
Setting Plot Scale	7-99
Selecting Plot Data	7-100
Specifying Pen	7-101
Plotter Setup	7-102
Printer Setup	7-104
13. Communication with Peripheral Devices	7-105
Parallel I/O Port	7-105
RS-232	7-114



## Chapter 8 IN ABNORMALITIES

1. Inspection and Simple Troubleshooting .....	8-2
2. Error Messages .....	8-3
Hardware Trouble .....	8-3
Notice of Hardware Information .....	8-4
Operating Error .....	8-5
Warning of Internal Set, Change, etc. ....	8-10
Notice of the Completion and the State of Operation .....	8-13

## Chapter 9 THE PRINCIPLE

1. The Principle .....	9-2
2. Data Flow .....	9-3
3. Block Chart .....	9-4
R3765A/3767A Diagrammatic Sketch of Block .....	9-4
R3765B/3767B Diagrammatic Sketch of Block .....	9-5
R3765C/3767C Diagrammatic Sketch of Block .....	9-6

## Chapter 10 CALIBRATION (PERFORMANCE TEST)

1. Preparing for Performance Test .....	10-2
Warm up .....	10-2
Preparing Measurement Instrument .....	10-2
General Note .....	10-2
2. Frequency Accuracy and Range .....	10-3
3. Output Level Accuracy and Flatness .....	10-4
Setup .....	10-4
Output Level Accuracy .....	10-4
Flatness .....	10-5
4. Output Level Linearity .....	10-6
5. Directivity .....	10-7
6. Load Match of Test Port .....	10-9
7. Noise Level .....	10-15
8. Crosstalk .....	10-18

## Chapter 11 SPECIFICATION

Measurement Function .....	11-2
Signal Source Section .....	11-3
Characteristic of the Receiver Part .....	11-5
Test Port Characteristic .....	11-7
Error Compensation Function .....	11-8
Display Section .....	11-9
Other Functions .....	11-10
Program Function .....	11-10
Connection to External Devices .....	11-11
General Specification .....	11-11

## APPENDIX

1. The Relation of Data between each Function .....	A-2
The Relation of Data between each Channel and each Function .....	A-2
The Data Interlocking to each Item in MEAS Menu .....	A-3
2. Measuring Time .....	A-4
3. Initial Setting Value .....	A-5
4. Soft Key Menu List .....	A-9
MENU .....	A-9
MEAS .....	A-10
FORMAT .....	A-10
SCALE .....	A-10
DISPLAY .....	A-11
AVG .....	A-11
CAL .....	A-12
MKR .....	A-13
MKR→ .....	A-14
SAVE .....	A-15
RECALL .....	A-16
COPY .....	A-17
SYSTEM .....	A-18
RUN .....	A-20
LCL .....	A-20
5. Other Information .....	A-21
Error Message .....	A-21
Setting of Backup Memory (at the factory-shipped) .....	A-21
GPIB Command List for Panel Key/Soft Key .....	A-21

## EXTERNAL VIEW

R3765A/3767A EXTERNAL VIEW .....	E-1
R3765B/3767B EXTERNAL VIEW .....	E-2
R3765C/3767C EXTERNAL VIEW .....	E-3
R3765A/3767A FRONT VIEW .....	E-4
R3765B/3767B FRONT VIEW .....	E-5
R3765C/3767C FRONT VIEW .....	E-6
R3765A/3767A REAR VIEW .....	E-7
R3765B/3767B REAR VIEW .....	E-8
R3765C/3767C REAR VIEW .....	E-9



## LIST OF ILLUSTRATIONS

NO.	Title	Page
1-1	Operating Conditions .....	1-3
1-2	Environmental Conditions .....	1-4
1-3	Connecting FET Probe .....	1-8
1-4	Replacement of protective fuse for bias input .....	1-10
2-1	Front-Panel Descriptions (R3765A/3767A) .....	2-2
2-2	Front-Panel Descriptions (R3765B/3767B) .....	2-4
2-3	Front-Panel Descriptions (R3765C/3767C) .....	2-6
2-4	Rear Panel Descriptions (R3765A/3767A) .....	2-8
2-5	Rear Panel Descriptions (R3765B/3767B) .....	2-10
2-6	Rear Panel Descriptions (R3765C/3767C) .....	2-12
2-7	Screen Display Descriptions .....	2-14
3-1	Connecting the Power Cable .....	3-2
3-2	Power Switch .....	3-3
3-3	Setting Screen When Switch on or Preset .....	3-3
3-4	Panel Keys and Soft Keys .....	3-4
3-5	Displayed Active Area .....	3-7
3-6	How to Set Data .....	3-7
3-7	Annotation on the Screen (Annotation Character) .....	3-9
3-8	The Setup of Transmission Characteristic Measurement (A Type) .....	3-11
3-9	The Setup of Transmission Characteristic Measurement (B/C Type) .....	3-11
3-10	Screen of Frequency Characteristic Normalize .....	3-13
3-11	Auto-scale of Magnitude Measurement .....	3-14
3-12	Filter Analyzing Function (3dB Bandwidth and Q Measurement) .....	3-15
3-13	Filter Analyzing Function (6dB Bandwidth and Q Measurement) .....	3-16
3-14	Auto-scale of Phase Measurement .....	3-17
3-15	Phase Extension Display .....	3-18
3-16	Auto-scale of Group Delay Time Measurement .....	3-19
3-17	Change of Group Delay Aperture .....	3-20
3-18	Setup I for A Type Reflection Characteristics Measurement .....	3-21
3-19	Setup II for A Type Reflection Characteristics Measurement .....	3-22
3-20	Setup for Reflection Characteristic Measurement .....	3-22
3-21	1 Port Full Calibration (Open) .....	3-24
3-22	1 Port Full Calibration (Short) .....	3-25
3-23	1 Port Full Calibration (Load) .....	3-26
3-24	Return Loss Measurement .....	3-27
3-25	Reflection Coefficient Measurement .....	3-28

NO.	Title	Page
3-26	Standing Wave Ratio (SWR) Measurement	3-29
3-27	S Parameter Measurement	3-30
3-28	Impedance Measurement	3-31
5-1	Auto-scale of the First Waveform of Magnitude/Phase Measurement (Overlap Display)	5-3
5-2	Auto-Scale of the Second Waveform of Magnitude/Phase Measurement (Overlap Display)	5-4
5-3	Magnitude/Group Delay time Measurement (Overlap Display)	5-5
5-4	Linear Scale Measurement of Magnitude/Phase (Overlap Display)	5-6
5-5	Magnitude/Phase Measurement (Split Display)	5-8
5-6	Magnitude/Group Delay Time Measurement (Split Display)	5-9
5-7	Linear Magnitude/Phase Measurement (Split Display)	5-10
5-8	Setup of A Type S Parameter Measurement	5-11
5-9	Setup of the Reflection Characteristic Measurement	5-12
5-10	Calibration of 2-Port Reflection (Test Port/Open)	5-13
5-11	Calibration of 2-Port Reflection (Test Port/Short)	5-14
5-12	Calibration of 2-Port Reflection (Test Port/Load)	5-15
5-13	Execution of 2 Port Reflection Characteristic Calibration	5-16
5-14	Calibration of 2-Port Transmission Characteristic (Forward Direction)	5-17
5-15	Execution of 2-Port Transmission Characteristic Calibration	5-18
5-16	Execution of the Isolation Calibration	5-19
5-17	Execution of 2-Port Full Calibration	5-20
5-18	4 Screen Display (Channel 1)	5-21
5-19	4 Screen Display (Overlap Display of Channel 1 and 3)	5-22
5-20	4 Screen Display (Split Display of Channel 1 and 3)	5-23
5-21	4 Screen Display (Channel 2)	5-24
5-22	4 Screen Display (Split Display of Channel 2 and 4)	5-25
5-23	The Finished 4 Screen Display	5-26
5-24	Two Channels Simultaneous Display (Overlap Display)	5-28
5-25	Two Channels Simultaneous Display (Split Display)	5-29
5-26	Multi-marker Display	5-31
5-27	Display of Multi-marker List	5-32
5-28	Specification of Delta Section (Partial Search)	5-34
5-29	Measurement of Maximum Value in the Delta section	5-35
5-30	Measurement of Minimum Value in the Delta Section	5-36

NO.	Title	Page
5-31	Measurement of Ripple in the Delta Section	5-37
5-32	Electrical Length of Cable	5-39
5-33	Electrical Length Compensation Mode	5-40
5-34	Measurement of Electrical Length	5-41
5-35	Linear Sweeping	5-42
5-36	Setting of Program Sweeping	5-43
5-37	Execution of the Program Sweep	5-45
5-38	Change of the Program Sweep	5-46
5-39	Screen before Execution of Limit Line Measurement	5-47
5-40	Setting of the Limit Line	5-48
5-41	Limit Line Editing	5-48
5-42	Setting of Segment 0	5-49
5-43	Setting of Each Segment	5-51
5-44	Execution of Limit Test	5-52
5-45	Change of Limit Line	5-53
6-1	Setting of Plotter GPIB Address	6-2
6-2	Change of Plotter Initial Setup Value (Initial Value)	6-4
6-3	Output Data to the Plotter	6-4
6-4	Output Result of the Plotter	6-5
6-5	Saving into the Save-Register	6-6
6-6	Recalling from the Recall-register	6-7
6-7	Saving to Floppy Disk	6-10
6-8	Recall from Floppy Disk	6-11
7-1	Delta-Marker Function	7-53
7-2	Example of Filter Analysis Execution	7-63
7-3	The Screen before the Segment Edited	7-69
7-4	The Screen after the Segment Edited	7-70
7-5	File List Display	7-88
7-6	Label Window Display	7-91
7-7	Register List Display	7-92
7-8	Setting DIP Switches	7-102
7-9	Timing Chart of WRITE STORE	7-106
7-10	Parallel I/O (36-pin) Connector Pin Assignment and Signal	7-107
7-11	Schematic Circuit Diagram of Parallel I/O Port	7-108

NO.	Title	Page
9-1	Data Flow .....	9-3
	R3765A/3767A Diagrammatic Sketch of Block .....	9-4
	R3765B/3767B Diagrammatic Sketch of Block .....	9-5
	R3765C/3767C Diagrammatic Sketch of Block .....	9-6
10-1	Frequency Accuracy and Range .....	10-3
10-2	Output Level Accuracy and Flatness .....	10-4
10-3	Output Level Linearity .....	10-6



## LIST OF TABLES

NO.	Title	Page
2-1	Front-Panel Descriptions (R3765A/3767A) .....	2-3
2-2	Front-Panel Descriptions (R3765B/3767B) .....	2-5
2-3	Front-Panel Descriptions (R3765C/3767C) .....	2-7
2-4	Rear Panel Descriptions (R3765A/3767A) .....	2-9
2-5	Rear Panel Descriptions (R3765B/3767B) .....	2-11
2-6	Rear Panel Descriptions (R3765C/3767C) .....	2-13
2-7	Screen Display Descriptions .....	2-15
4-1	Initial Setup Value (1 of 3) .....	4-4
4-2	Initial Setup Value (2 of 3) .....	4-6
4-3	Initial Setup Value (3 of 3) .....	4-7
4-4	Setting Backup Memory .....	4-7
7-1	Combination of Interpolatable Sweep Type (o; possible, x; impossible) .....	7-41
7-2	Status Display .....	7-41
7-3	DSW1 Function .....	7-103
7-4	DSW2 Function .....	7-103
10-1	Required Measurement Instrument for Calibration .....	10-2



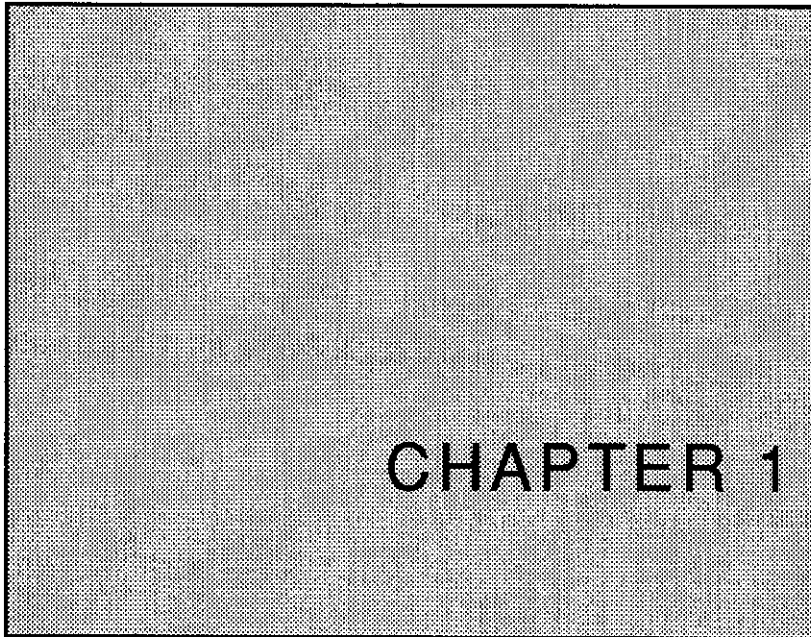

## BEFORE USE THE PRODUCT

This chapter gives a brief explanation of product, its working environment and operational precautions. Read this chapter before you use the product.

---

### CONTENTS

---

1. Outline of Product .....	1-2
2. Operating Conditions .....	1-3
3. Power source .....	1-5
Checking Power Requirements .....	1-5
Replacing the Power Fuse .....	1-5
Connecting the Power Cable .....	1-6
4. FET Probe .....	1-8
5. Caution of System-up .....	1-9
6. Measurement Time .....	1-9
7. Cautions on the Overload to the Input Part .....	1-9
8. How to Replace the Protective Fuse for Bias Input .....	1-10
9. Cleaning, Storage and Transportation .....	1-11
10. Notes on Use .....	1-12

---

# 1. Outline of Product

R3765/3767 series is the 3.8GHz/8GHz vector network analyzer, which has newly been designed based on a concept "an optimum tool for each application".

We have fully pursued high throughput such as 0.15ms/points high-speed measurement at a resolution bandwidth (RBW) of 10kHz, 100dB wide dynamic-range measurement, and two-device simultaneous measurement with four-channel/eight-trace display.

Also, we have added the program sweeping function that can freely change the resolution bandwidth (RBW) and output level during sweep operation for each segment.

With the built-in BASIC controller, a high-speed ATE system can be easily configured with no external controller for processes from adjustment to inspection.

## 《Features》

### ● High throughput

- In the case of C type, 4 S parameters can be displayed in a screen by 0.15ms/point high-speed frequency sweeping and four-channel/eight-trace (RBW 10kHz).
- 0.15ms/point high-speed level sweeping.

### ● Wide dynamic range

- 100dB wide dynamic range.

### ● Program sweeping function.

- For each segment, allows setting of frequency, output level, RBW, and settling time.

### ● MS-DOS formatted disk

- By using an MS-DOS personal computer, it is possible to easily create programs and analyze data.
- Three modes of storage capacity available (DD 720KB, HD 1.2MB, HD 1.4MB).

## 2. Operating Conditions

### ■ Operating environmental Conditions

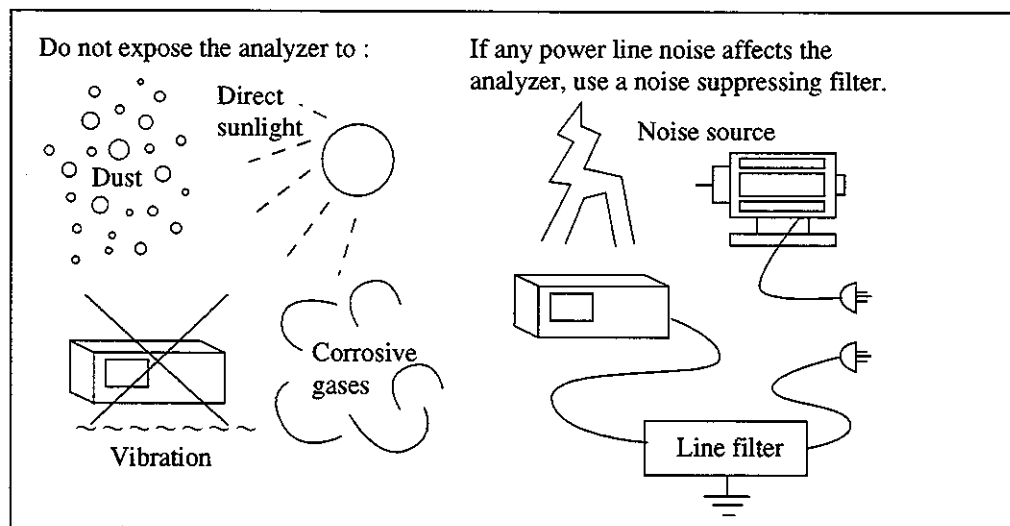

Figure 1-1 Operating Conditions

● Environmental temperature:

+5°C to +40°C (Operating temperature range: When FDD is used.)

0°C to +50°C (Operating temperature range: When FDD is not used.)

-20°C to +60°C (Storage temperature range)

● Relative humidity: PH80% or less (Non-condensing)

● Place without corroded gas

● Place without exposed to direct sunshine

● Place without dust

● Place without vibration

● Place where there is minimum noise

The analyzer is designed to resist noise from AC power lines. However, you should still take steps to minimize power line noise. If necessary, install a noise suppressing filter in the analyzer's power supply.

For highly accurate measurement, turn the power ON after the device temperature has reached the room temperature level, and warm up the device for 60 minutes.

2. Operating Conditions

■ Installation Posture

Air cooling fan of the exhaust type is built in the rear panel. Do not close this outlet.

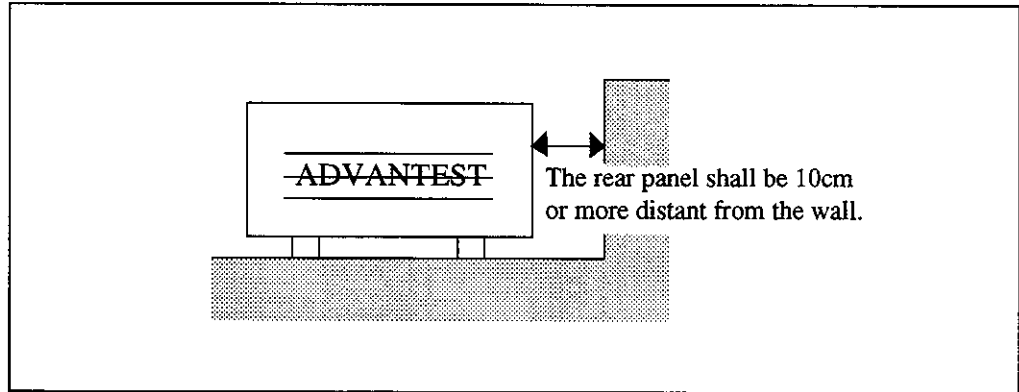

Figure 1-2 Environmental Conditions

### 3. Power Source

#### ■ Checking Power Requirements

##### WARNING !

Safety use R3765/3767 according to the power requirement.  
R3765/3767 might be damaged to the case not following the power requirement.

The power requirement of R3765/3767 is shown in the following.

The supply voltage of this device is automatically changed over (100/240V).

	100V <sub>AC</sub> operation	220V <sub>AC</sub> operation
Input voltage range	90V to 132V	198V to 250V
Frequency range	48Hz to 66Hz	
Power fuse	T6.3A/250V	
Power consumption	300VA or below	

Use the power supply by which the power requirement of R3765/3767 is satisfied.

#### ■ Replacing the Power Fuse

##### WARNING !

1. Before replacing the power fuse, be sure to turn the power switch OFF and remove the power cable from the outlet.
2. For continued protection against fire hazard, use a fuse of the type and rating which match the supply voltage.

Power fuse is accommodated in the FUSE holder on the rear panel.

To check or replace the power fuse, observe the following procedure.

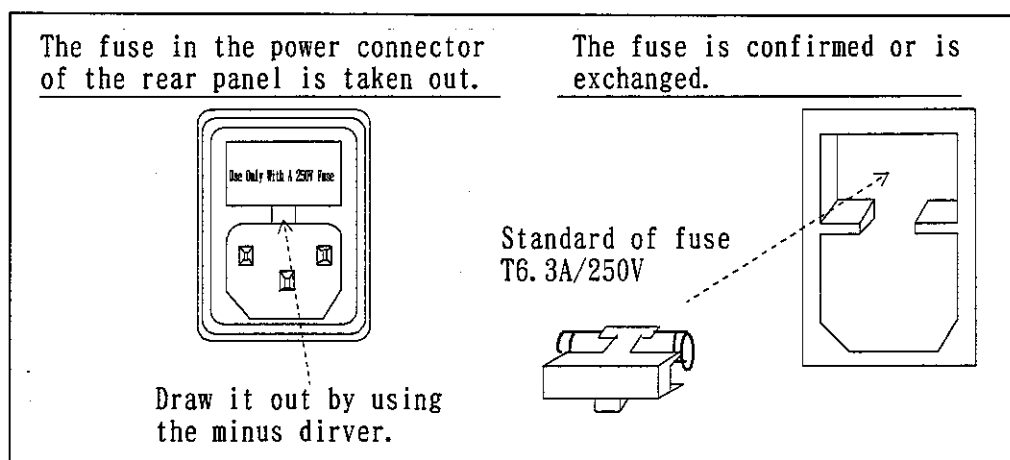

## ■ Connecting the Power Cable

### WARNING!

#### 1. Power cable

- Use power cable of the attachment for the electric shock and the fire prevention.
- Use power cable in accordance with the safety standard of the country for use excluding Japan.
- When you connect power cable with the outlet, turn off the power switch.
- When you pull out power cable from the outlet, have the plug.

#### 2. Protective earth

- Connect the power plug cable with the power outlet which has the protective earth terminal.
- If the code for the extension without the protective earth terminal is used, the protective earth will become invalid.
- Case in which use of AC adapter (Three pins to two pins conversion adapter), the earth pin of the adapter is grounded to the earth of the outlet, or connect ground terminal of the rear panel with the earth of the outside, and ground it to the earth.

- (1) In Japan-domestic, the electric power connector of three pins is few.

Therefore the AC adapter is attached.

The width between electrodes of the 2 line is different. After confirming the direction of the plug and the outlet, connect the adapter when inserting it in the outlet.

Use another adapter (KPR-13) for the case which cannot be connected with the outlet of the adapter.

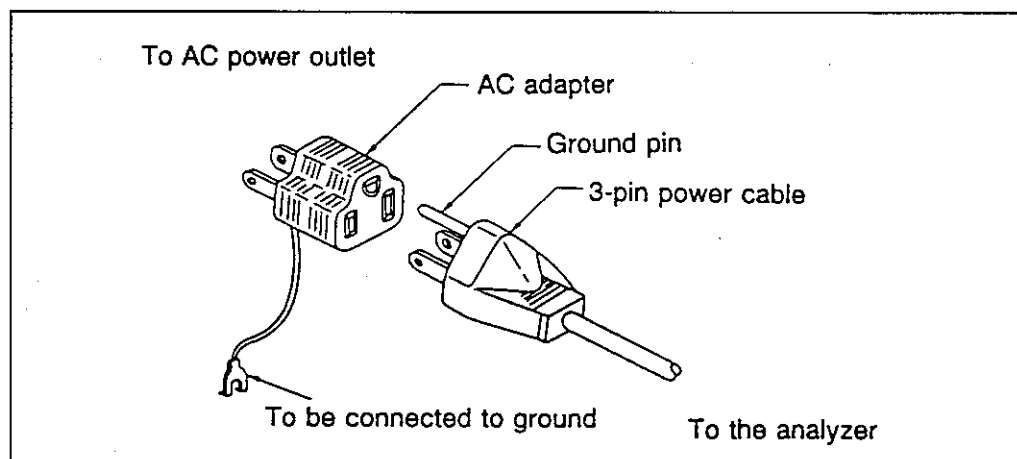

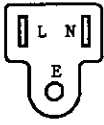
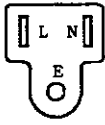
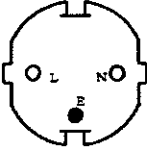
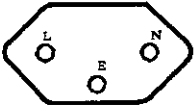
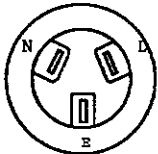
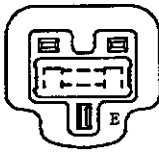

●The power plug in the below is sold as an option. Separately consult excluding the following.

Type name	Straight type	A01402 (Standard)	A01403 (Opt.95)	A01404 (Opt.96)
	Angle type	A01412	A01413	A01414
Applicable standard		JIS: Japan Law on Electrical Appliances	UL: US CSA: Canada	*
Ratings and colors		125V/7A, Black, 2m	125V/7A, Black, 2m	250V/6A, Grey, 2m
Plug				
Type name	Straight type	A01405 (Opt.97)	A01406 (Opt.98)	A01407
	Angle type	A01415		A01407
Applicable standard		SEV: Switzerland	SAA: Australia New Zealand	BS: Uk
Ratings and colors		250V/6A, Grey, 2m	250V/6A, Grey, 2m	250V/6A, Black, 2m
Plug				

\*  
CEE: Europe  
DEMKO: Denmark  
NEMKO: Norway  
VED: Old West Germany  
KEMA: Netherlands  
CEBEC: Belgium  
OVE: Austria  
FIMKO: Finland  
SEMKO: Sweden

## 4. FET Probe

### ■ Setup

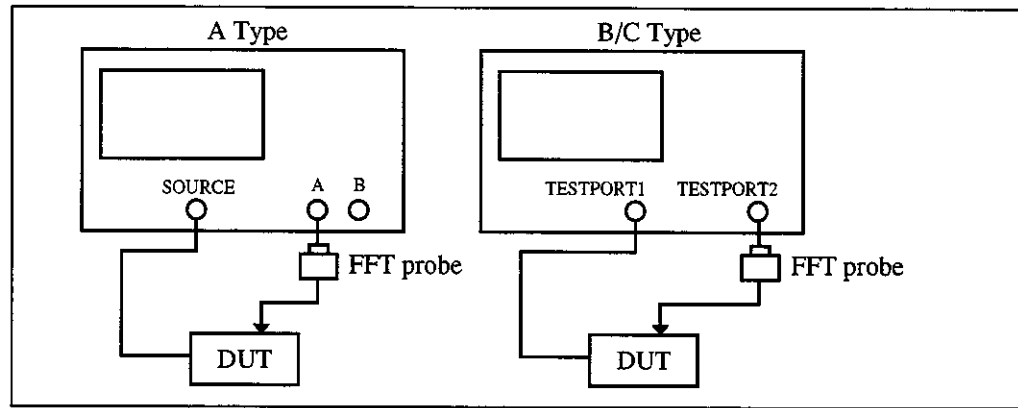

Figure 1-3 Connecting FET Probe

### ■ Usage Precautions

The stability and repeatability of the measurement value are affected by the ground of FET probe tip. In high frequency, it is necessary to consider the effect of parallel capacity.

The input impedance of the FET probe is listed in the following Table.

Model name	Input impedance	Remarks
P6201 type	100k $\Omega$ $\pm$ 1% parallel 3PF Attenuator head 1M $\Omega$ $\pm$ 1%, 1.5PF in parallel.	DC to 900MHz Manufactured by SONY Tektronix
P6202A type	10M $\Omega$ $\pm$ 2% Approx. 2PF Approx. 4PF with the optional coupling cap.	DC to 500MHz Manufactured by SONY Tektronix

### ■ Calibration and Measurement Method

#### Operation procedure

1. Connect the FET probe to the reference point of the device under test.
2. Select the calibration menu of the analyzer to normalize the frequency characteristic probe.
3. Connect the FET probe to the point to be measured, then perform the measurement.

**NOTE:** When measuring the point in high frequency, note that the data repeatability will be changed by the ground condition of the FET probe tip.

## 5. Caution of System-up

### ■ Notes on use of Parallel I/O Port

- In +5 V power output from parallel I/O port, maximum current capacity is 100 mA.  
Use it within 100 mA.
- In +5 V power output from parallel I/O port, there is a fuse.  
The fuse fuses with the over current of 100 mA or more.  
In the case with which the fuse fuses, contact to the nearest dealer or the sales and support offices.
- Use the shield cable for the cable for parallel I/O port. (malfunction prevention by noise)
- The standard of the cable for the radiation test of R3765/3767 is MO-27.
- Do not bundle I/O cable and AC power line when wiring.

### ■ Notes on use of Serial I/O ports

- Adjust the length of the cable used for serial I/O port to 15m or less.
- Use the shield cable for the cable for serial I/O port. (Malfunction prevention by noise)
- The standard of the cable used for the radiation test of R3765/3767 is A01235.
- Do not bundle I/O cable and AC power line when wiring.

## 6. Measurement Time

The sweeping time of the analyzer is determined by frequency set-up time and data acquiring time.

As the SWEEP TIME on the display screen shows the data acquiring time, the actual sweep time becomes longer than the displayed SWEEP TIME under the influence of frequency set-up time.

Refer to APPENDIX for details.

## 7. Cautions on the Overload to the Input Part

The maximum level at the input part of R3765A/3765B and R3767A/3767B is 0dBm.

R3765C/3767C is +15dBm.

If more than about 5dB over the maximum level is input, "overload" is displayed.

## 8. How to Replace the Protective Fuse for Bias Input

For R3765C/3767C type, the protective fuse for TEST PORT input bias is located in the fuse holder on the rear panel. (Refer to page 2-12, 2-13).

**NOTE:** When the protective fuse for bias input is replaced, turn OFF the POWER switch of the analyzer and remove the power cable from the receptacle beforehand.

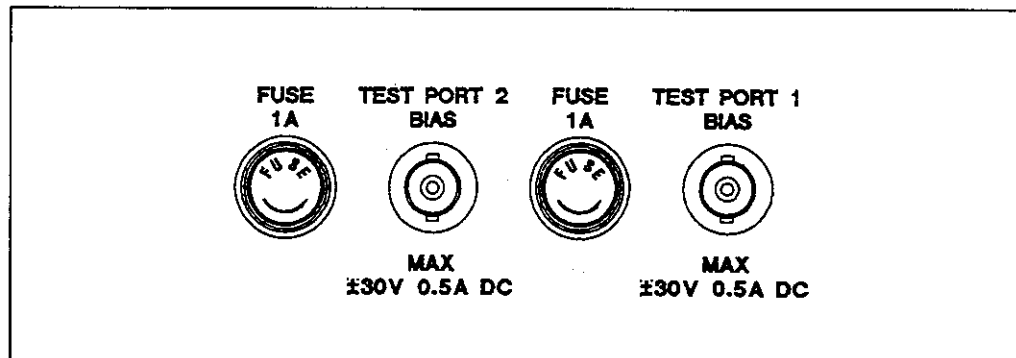

Figure 1-4 Replacement of protective fuse for bias input

### Replacement procedure

1. Turn the cap of fuse holder counterclockwise to remove.
2. Take out this turned part and replace the fuse.
3. Install the turned part.

● Tighten clockwise.

Standard of protective fuse for bias input

Name of type : TMF51NR1(250)

Part code : DFN-AA1A-3

---

### WARNING!

When the fuse is replaced, use the same type and the same rating of fuse to protect against the danger of fire.

---

## 9. Cleaning, Storage and Transportation

### ■Cleaning

Wipe the dirt of R3765/3767 off with a soft cloth (or cloth that gets damp). At this time, attend to the following points.

- Do not remain the fluff of the cloth and do not soak water into the internal of R3765/3767.
- Do not use an organic solvent (for example, benzene and acetone, etc.) which changes plastics in quality.

### ■Storage

Storage temperature of this device is from -20 to +60 degrees C. Do not store it out of this temperature range.

The cases in which R3765/3767 is not used for a long time, cover with the vinyl cover or put in the cardboard box and prevent dust. Keep it in a dry place where dust and direct sunshine were prevented.

### ■Transportation

When you transport R3765/3767, pack it equally to the first packing material or any more.

#### Packing procedure

1. Wrap R3765/3767 itself with cushion material and put in the cardboard box.
2. After putting attachment, put cushion again.
3. Shut the lid of the cardboard box. Fix the outside with the string or tape.

## 10. Notes on Use

### ■ Case that abnormality occurs

When smoke rises from R3765/3767 or the nasty smell and the allophone feel, turn off the power switch. Pull out from the outlet. And contact to our company.

The address and the telephone number of our company are in the end of this book.

### ■ Warm up

After the device temperature has reached the room temperature level, turn the power switch ON and warm it up for 60 minutes.

### ■ Electromagnetic interference.

High frequency noise of the small power is generated at R3765/3767 use.

Therefore, the television and the radio are generated electromagnetic interference by an improper installation and use of R3765/3767.

If R3765/3767 is a cause of the electromagnetic interference when the power of R3765/3767 is turned off, it will not be generated.

Prevent electromagnetic interference by the following procedure.

The power of R3765/3767 and the power of the television and the radio use the outlet of another power.

- R3765/3767 is set up to the other side of the television and the radio.
- R3765/3767 is set up to a place away from the television and the radio.
- The power of R3765/3767 and the power of the television and the radio use the outlet of another power.

### ■ Cautions when scrapping the analyzer

When the products are scrapped, be careful to treat them properly.

Call for the inquiry about how to scrap, etc. to the nearest our service station. The addresses and the telephone numbers are at the end of this document.

- Harmful substances :
- (1) PCB (Polychlorinated biphenyl)
  - (2) Mercury
  - (3) Ni-Cd (Nickel-cadmium)
  - (4) Others

Substances that contain cyan, organic phosphorous, and hexadic chromium, and substances that might dissolve and flow out cadmium, lead or arsenic. (Except lead for soldering)

## ■ Life time of parts

The following consumable parts are used in the analyzer.

Soft key switch	500,000 times operating life
LCD (liquid crystal display) back light	7000 hours operating life

*MEMO* 

---



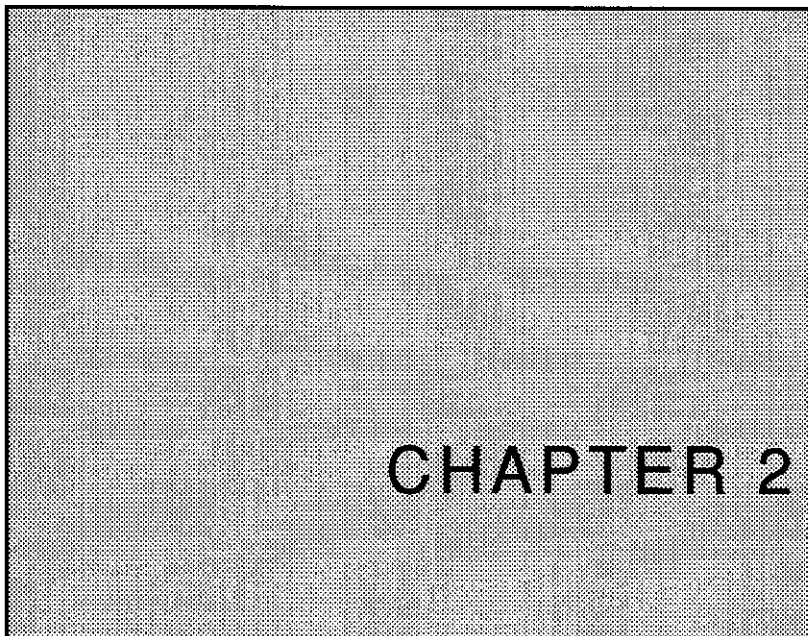

## PANEL DESCRIPTION

The names and the functions of each part on the front and rear panel side and the display screen are described.

---

### CONTENTS

---

1. Front Panel Descriptions .....	2-2
R3765A/3767A .....	2-2
R3765B/3767B .....	2-4
R3765C/3767C .....	2-6
2. Rear Panel Descriptions .....	2-8
R3765A/3767A .....	2-8
R3765B/3767B .....	2-10
R3765C/3767C .....	2-12
3. Screen Display Descriptions .....	2-14

---

# 1. Front Panel Descriptions

## ■ R3765A/3767A

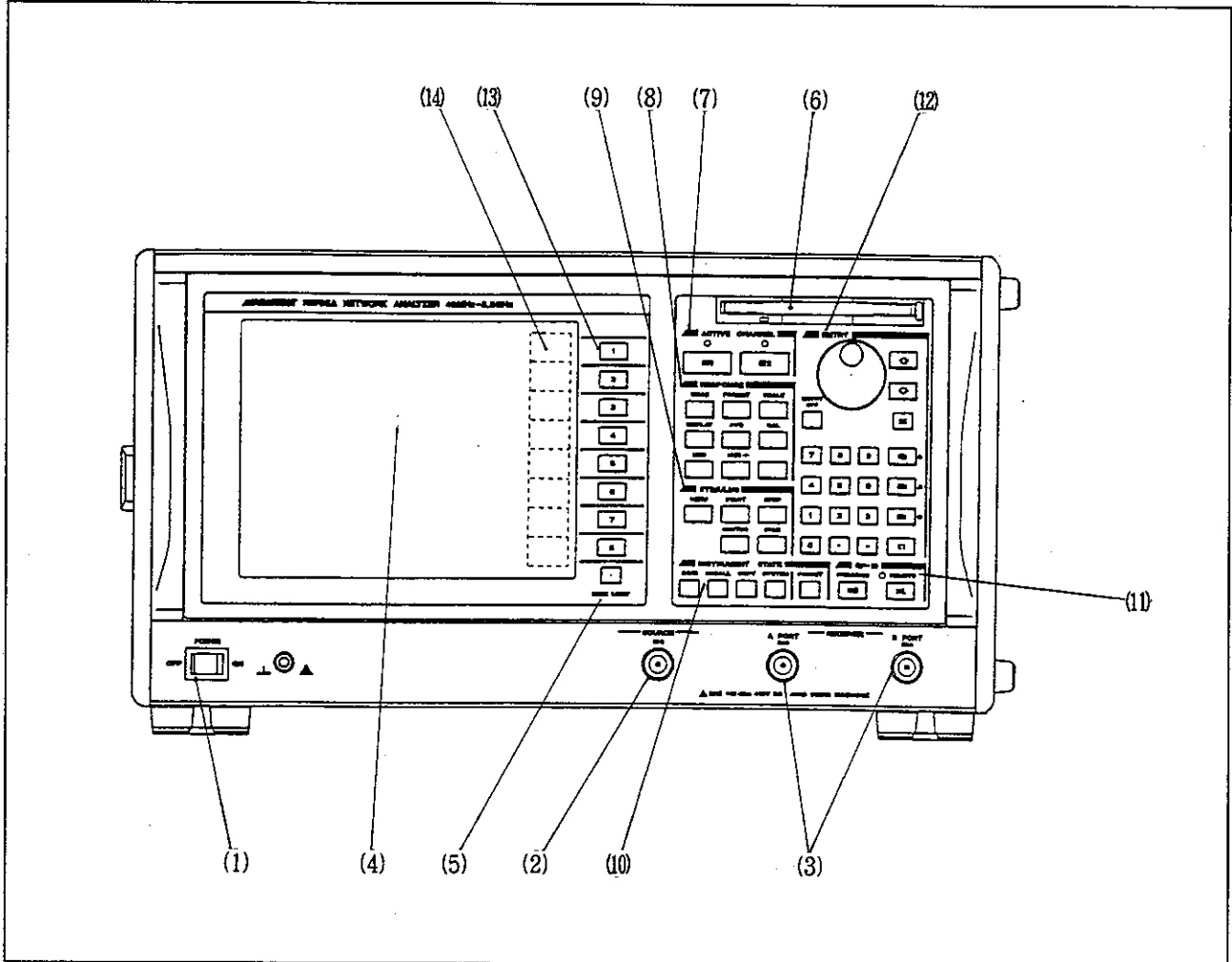

Figure 2-1 Front-Panel Descriptions (R3765A/3767A)

Table 2-1 Front-Panel Descriptions (R3765A/3767A)

No.	Name	Description
(1)	POWER switch	Turns on or off the power supply of the analyzer.
(2)	SIGNAL SOURCE OUTPUT connector (SOURCE)	Power splitter output.
(3)	RECEIVER SECTION INPUT connector A PORT B PORT	The INPUT connector is used for measurement input.
(4)	LED display	Displays measurement data, setting conditions, and other informations.
(5)	BACK LIGHT	Selects the back light ON/OFF of LED display.
(6)	Floppy disk drive	Stores a program and measurement data. Storage capacity corresponds to three modes (DD: 720KB, HD: 1.2MB, HD: 1.44MB).
(7)	ACTIVE CHANNEL block	The ACTIVE CHANNEL block is used to select an active channel between independently two measurement channels. Each channel has a sub-measurement screen which can be selected by toggle. Sub-measurement screen of CH1 : CH3 Sub-measurement screen of CH2 : CH4 After selecting, functions to be operated are provided for the selected active channel only.
(8)	RESPONSE block	The RESPONSE block is used to set measurement conditions of receiver section, data display, and data analysis.
(9)	STIMULUS block	The STIMULUS block is used to set signal source frequencies and level sweep conditions.
(10)	INSTRUMENT STATE block	The INSTRUMENT STATE block is used set the system functions which have no concern with the measurement.
(11)	GPIB block	The GPIB block is used to set a GPIB and controller functions.
(12)	ENTRY block	The ENTRY block is used to input numeric data and to perform a marker movement.
(13)	Soft key	Selects the soft key menu described in (14) in each function block.
(14)	Soft key menu	Displays each function menu. To select a menu, use the soft key described in (13).

1. Front Panel Descriptions

■ R3765B/3767B

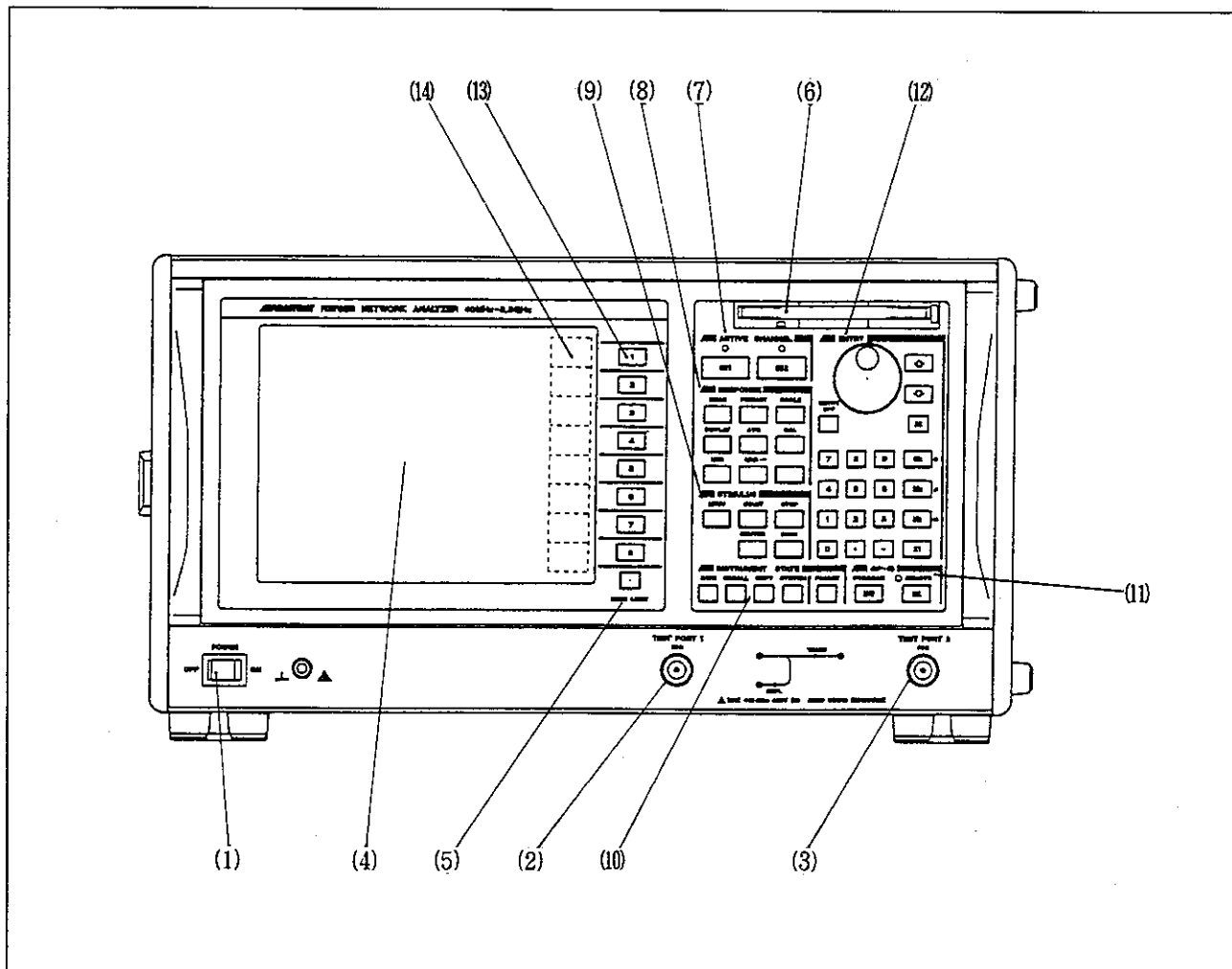

Figure 2-2 Front-Panel Descriptions (R3765B/3767B)

Table 2-2 Front-Panel Descriptions (R3765B/3767B)

No.	Name	Description
(1)	POWER switch	Turns on or off the power supply of the analyzer.
(2)	Reflection characteristic connector TEST PORT 1	Reflection characteristic measurement port.
(3)	Transmission characteristic connector TEST PORT 2	Transmission characteristic measurement port.
(4)	LED display	Displays measurement data, setting conditions, and other informations.
(5)	BACK LIGHT	Selects the back light ON/OFF of LED display.
(6)	Floppy disk drive	Stores a program and measurement data. Storage capacity corresponds to three modes (DD: 720KB, HD: 1.2MB, HD: 1.44MB).
(7)	ACTIVE CHANNEL block	The ACTIVE CHANNEL block is used to select an active channel between independently two measurement channels. Each channel has a sub-measurement screen which can be selected by toggle. Sub-measurement screen of CH1 : CH3 Sub-measurement screen of CH2 : CH4 After selecting, functions to be operated are provided for the selected active channel only.
(8)	RESPONSE block	The RESPONSE block is used to set measurement conditions of receiver section, data display, and data analysis.
(9)	STIMULUS block	The STIMULUS block is used to set signal source frequencies and level sweep conditions.
(10)	INSTRUMENT STATE block	The INSTRUMENT STATE block is used set the system functions which have no concern with the measurement.
(11)	GPIB block	The GPIB block is used to set a GPIB and controller functions.
(12)	ENTRY block	The ENTRY block is used to input numeric data and to perform a marker movement.
(13)	Soft key	Selects the soft key menu described in (14) in each function block.
(14)	Soft key menu	Displays each function menu. To select a menu, use the soft key described in (13).

1. Front Panel Descriptions

■ R3765C/3767C

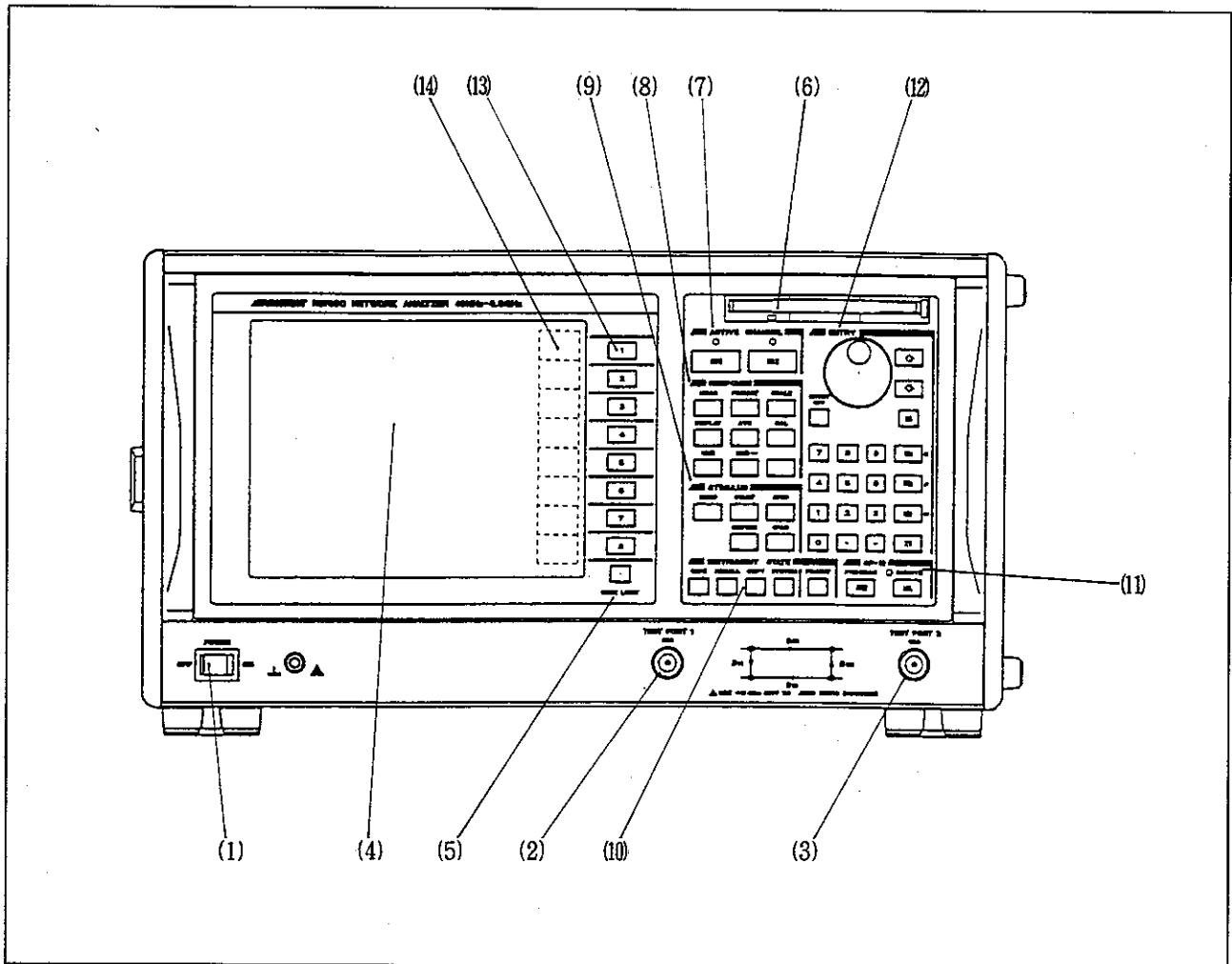

Figure 2-3 Front-Panel Descriptions (R3765C/3767C)

Table 2-3 Front-Panel Descriptions (R3765C/3767C)

No.	Name	Description
(1)	POWER switch	Turns on or off the power supply of the analyzer.
(2)	PORT 1 connector TEST PORT 1	Measurement of PORT 1.
(3)	PORT 1 connector TEST PORT 2	Measurement of PORT 2.
(4)	LED display	Displays measurement data, setting conditions, and other informations.
(5)	BACK LIGHT	Selects the back light ON/OFF of LED display.
(6)	Floppy disk drive	Stores a program and measurement data. Storage capacity corresponds to three modes (DD: 720KB, HD: 1.2MB, HD: 1.44MB).
(7)	ACTIVE CHANNEL block	The ACTIVE CHANNEL block is used to select an active channel between independently two measurement channels. Each channel has a sub-measurement screen which can be selected by toggle. Sub-measurement screen of CH1 : CH3 Sub-measurement screen of CH2 : CH4 After selecting, functions to be operated are provided for the selected active channel only.
(8)	RESPONSE block	The RESPONSE block is used to set measurement conditions of receiver section, data display, and data analysis.
(9)	STIMULUS block	The STIMULUS block is used to set signal source frequencies and level sweep conditions.
(10)	INSTRUMENT STATE block	The INSTRUMENT STATE block is used set the system functions which have no concern with the measurement.
(11)	GPIB block	The GPIB block is used to set a GPIB and controller functions.
(12)	ENTRY block	The ENTRY block is used to input numeric data and to perform a marker movement.
(13)	Soft key	Selects the soft key menu described in (14) in each function block.
(14)	Soft key menu	Displays each function menu. To select a menu, use the soft key described in (13).

## 2. Rear Panel Descriptions

### ■ R3765A/3767A

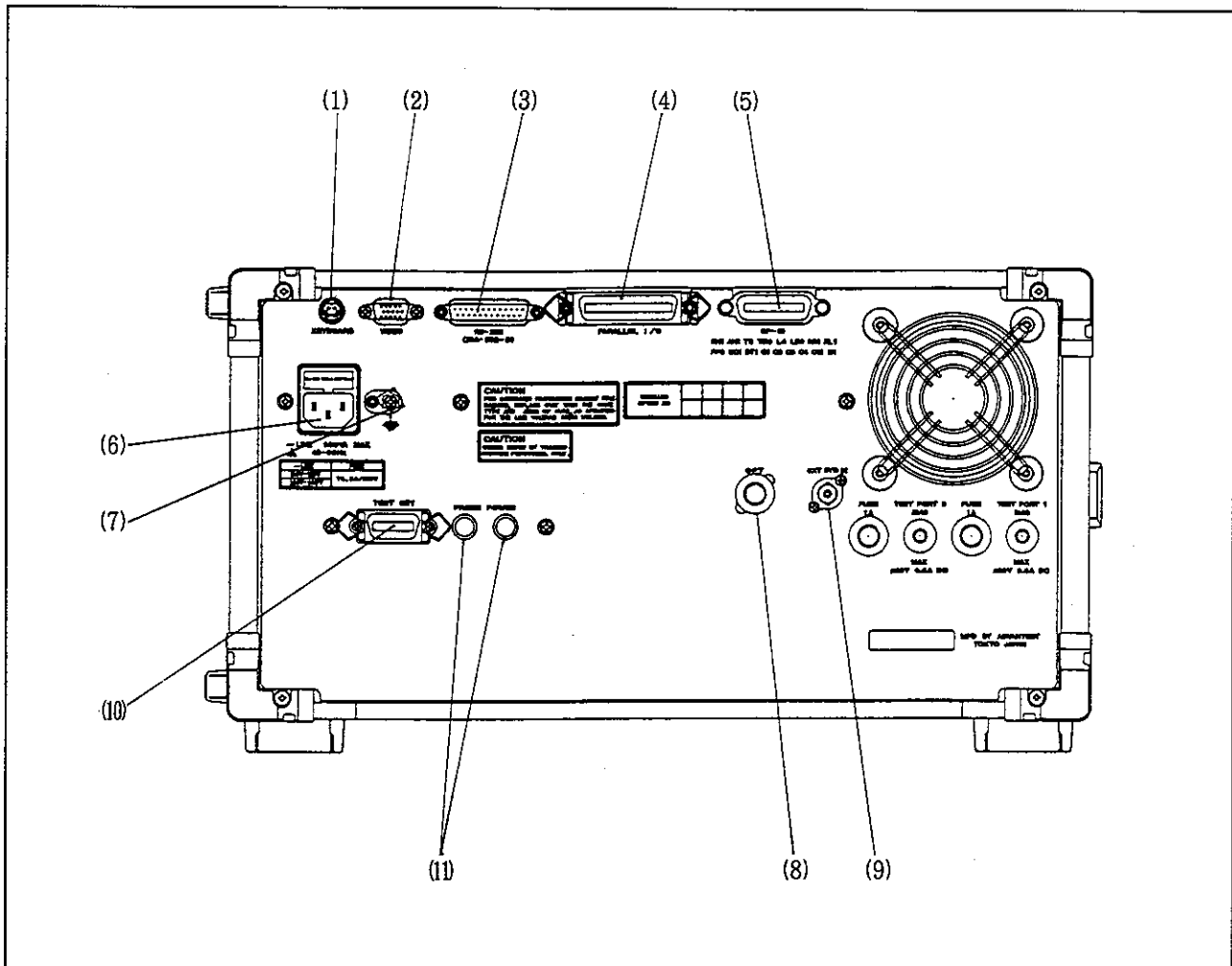

Figure 2-4 Rear Panel Descriptions (R3765A/3767A)



Table 2-4 Rear Panel Descriptions (R3765A/3767A)

No.	Name	Description
(1)	KEYBOARD INPUT connector	Connector to connect PS/2 type (6 pin small size DIN) key board. An external keyboard can be used to input a label name, a saving register name and a BASIC text.
(2)	VIDEO SIGNAL output	Video signal output correspondence to VGA. (15-pin)
(3)	SERIAL I/O	Input/output connector complied with RS-232 standard. (D Sub 25-pin)
(4)	PARALLEL I/O connector	The I/O port connector is used to communicate peripheral devices such as an automatic machine and a foot switch. (Output: 8-bit 2 systems, Input/output: 4-bit 2 systems) EXT TRIGGER input. (Negative logic, pulse width: 1 $\mu$ s or more, 18-pin terminal) ※Use shielded cables for connection (to prevent malfunction by noise).
(5)	GPIB connector	The GPIB connector is used to remotely control an external peripheral devices and to be remotely controlled by an external controller.
(6)	AC POWER connector	The AC POWER connector has three-pin structure and an earth terminal. To remove a power fuse, pull out the upper cover.
(7)	Ground terminal	The ground terminal is used to ground from the analyzer only when three-pin connector or two-pin adapter for power cable cannot be used.
(8)	Connector for option	Spare connector for option.
(9)	External reference frequency input connector	This connector is used to only input a reference frequency from an external device.
(10)	TEST SET connector	Connector for connecting S parameter test-set.
(11)	PROBE POWER connector	Connector for probe power. $\pm 15V$ output

2. Rear Panel Descriptions

■ R3765B/3767B

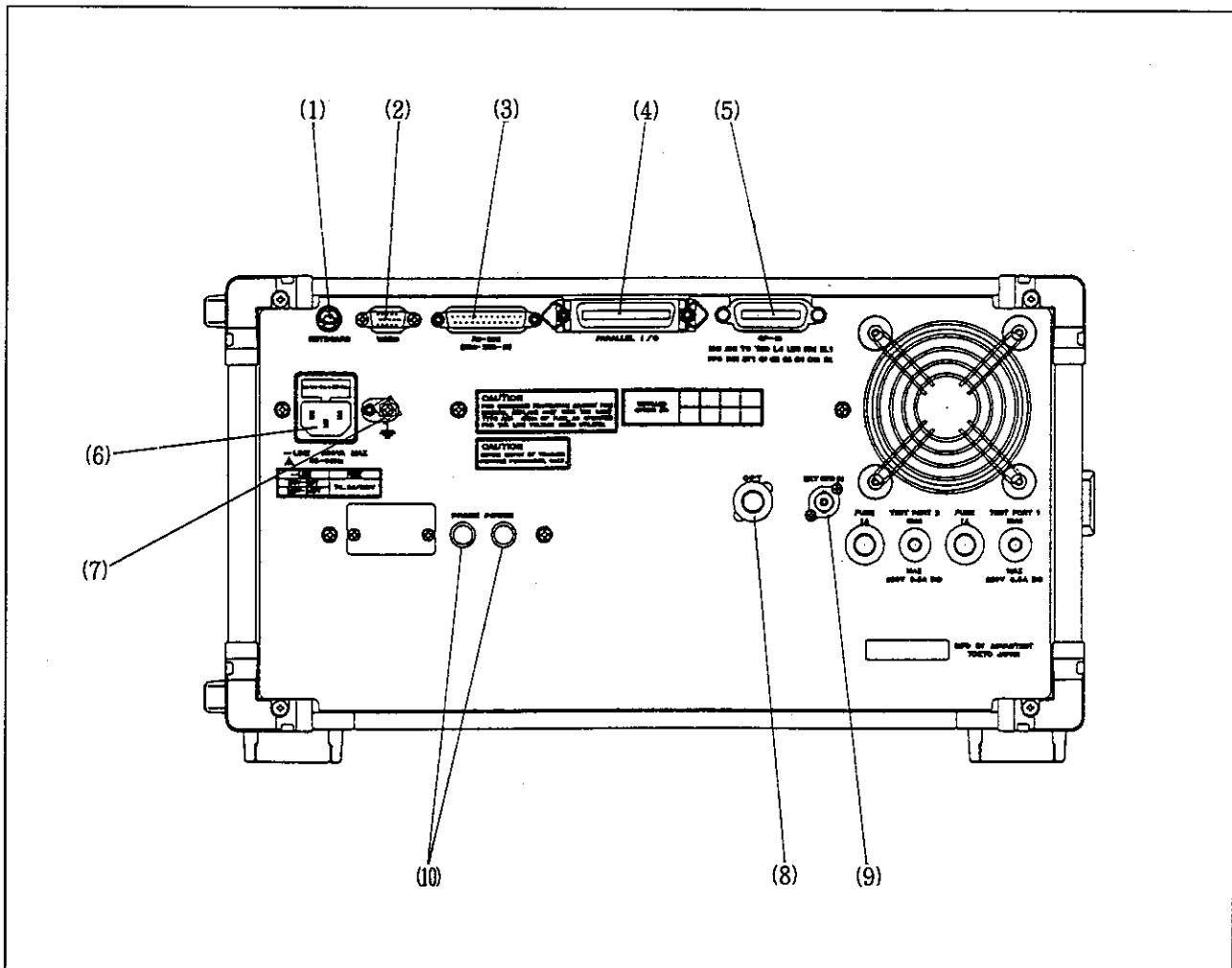

Figure 2-5 Rear Panel Descriptions (R3765B/3767B)

Table 2-5 Rear Panel Descriptions (R3765B/3767B)

No.	Name	Description
(1)	KEYBOARD INPUT connector	Connector to connect PS/2 type (6 pin small size DIN) key board. An external keyboard can be used to input a label name, a saving register name and a BASIC text.
(2)	VIDEO SIGNAL output	Video signal output correspondence to VGA. (15-pin)
(3)	SERIAL I/O	Input/output connector complied with RS-232 standard. (D Sub 25-pin)
(4)	PARALLEL I/O connector	The I/O port connector is used to communicate peripheral devices such as an automatic machine and a foot switch. (Output: 8-bit 2 systems, Input/output: 4-bit 2 systems) EXT TRIGGER input. (Negative logic, pulse width: 1 $\mu$ s or more, 18-pin terminal) ※Use shielded cables for connection (to prevent malfunction by noise).
(5)	GPIB connector	The GPIB connector is used to remotely control an external peripheral devices and to be remotely controlled by an external controller.
(6)	AC POWER connector	The AC POWER connector has three-pin structure and an earth terminal. To remove a power fuse, pull out the upper cover.
(7)	Ground terminal	The ground terminal is used to ground from the analyzer only when three-pin connector or two-pin adapter for power cable cannot be used.
(8)	Connector for option	Spare connector for option.
(9)	External reference frequency input connector	This connector is used to only input a reference frequency from an external device.
(10)	PROBE POWER connector	Connector for probe power. $\pm 15V$ output

2. Rear Panel Descriptions

■ R3765C/3767C

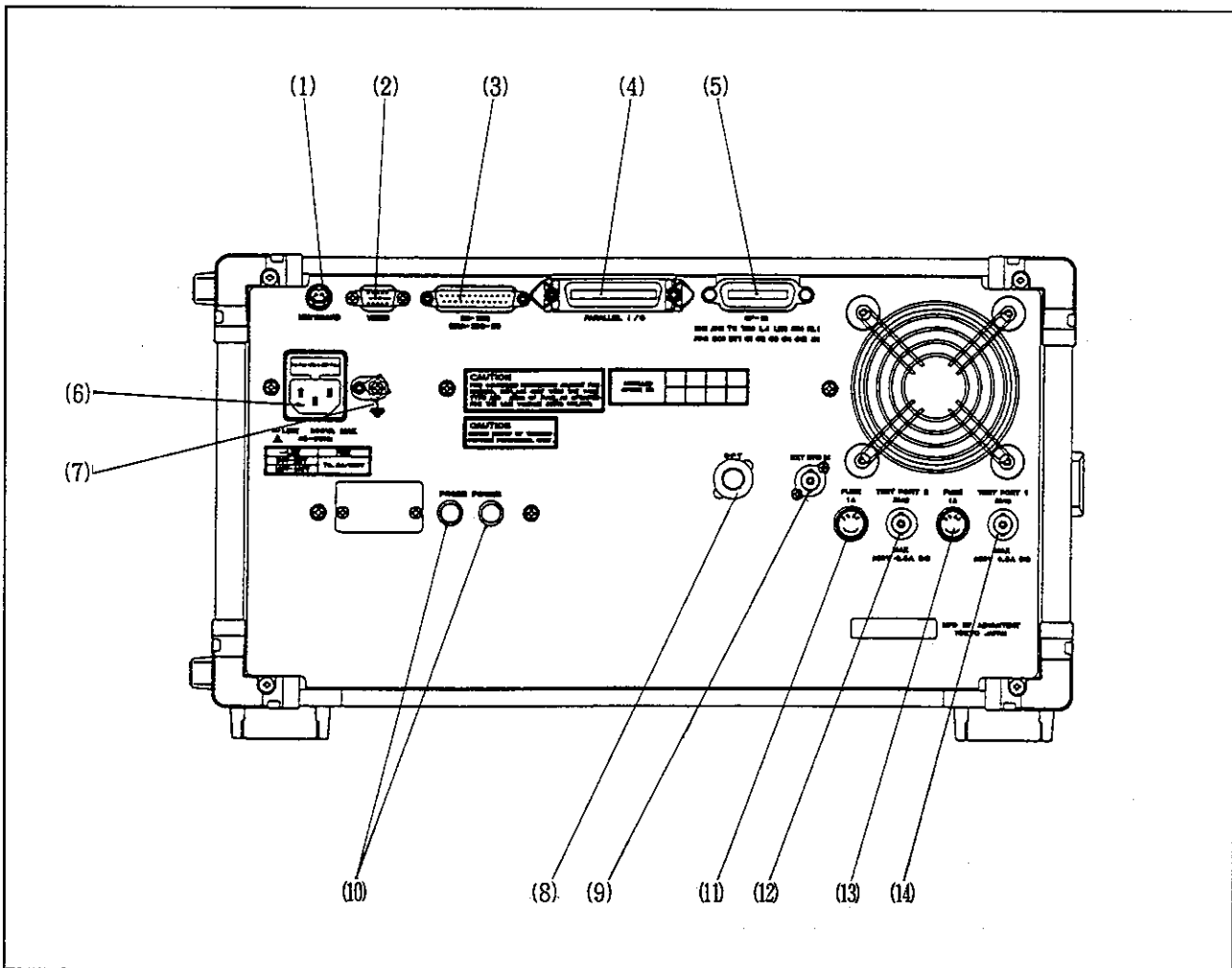

Figure 2-6 Rear Panel Descriptions (R3765C/3767C)

Table 2-6 Rear Panel Descriptions (R3765C/3767C)

No.	Name	Description
(1)	KEYBOARD INPUT connector	Connector to connect PS/2 type (6 pin small size DIN) key board. An external keyboard can be used to input a label name, a saving register name and a BASIC text.
(2)	VIDEO SIGNAL output	Video signal output correspondence to VGA. (15-pin)
(3)	SERIAL I/O	Input/output connector complied with RS-232 standard. (D Sub 25-pin)
(4)	PARALLEL I/O connector	The I/O port connector is used to communicate peripheral devices such as an automatic machine and a foot switch. (Output: 8-bit 2 systems, Input/output: 4-bit 2 systems) EXT TRIGGER input. (Negative logic, pulse width: 1 $\mu$ s or more, 18-pin terminal) ※Use shielded cables for connection (to prevent malfunction by noise).
(5)	GPIB connector	The GPIB connector is used to remotely control an external peripheral devices and to be remotely controlled by an external controller.
(6)	AC POWER connector	The AC POWER connector has three-pin structure and an earth terminal. To remove a power fuse, pull out the upper cover.
(7)	Ground terminal	The ground terminal is used to ground from the analyzer only when three-pin connector or two-pin adapter for power cable cannot be used.
(8)	Connector for option	Spare connector for option.
(9)	External reference frequency input connector	This connector is used to only input a reference frequency from an external device.
(10)	PROBE POWER connector	Connector for probe power. $\pm 15V$ output
(11)	Fuse holder ※	Protective fuse (1A) for bias input to TEST PORT 2.
(12)	TEST PORT 2 BIAS	Connector (MAX. $\pm 30V$ 0.5A DC) for bias input to TEST PORT 2.
(13)	Fuse holder ※	Protective fuse (1A) for bias input to TEST PORT 1.
(14)	TEST PORT 1 BIAS	Connector (MAX. $\pm 30V$ 0.5A DC) for bias input to TEST PORT 1.

※ : Refer to page 1-10, Section 8 for the replacement of protective fuse.

### 3. Screen Display Descriptions

The following shows R3767C screen. Each part is described in the next page.

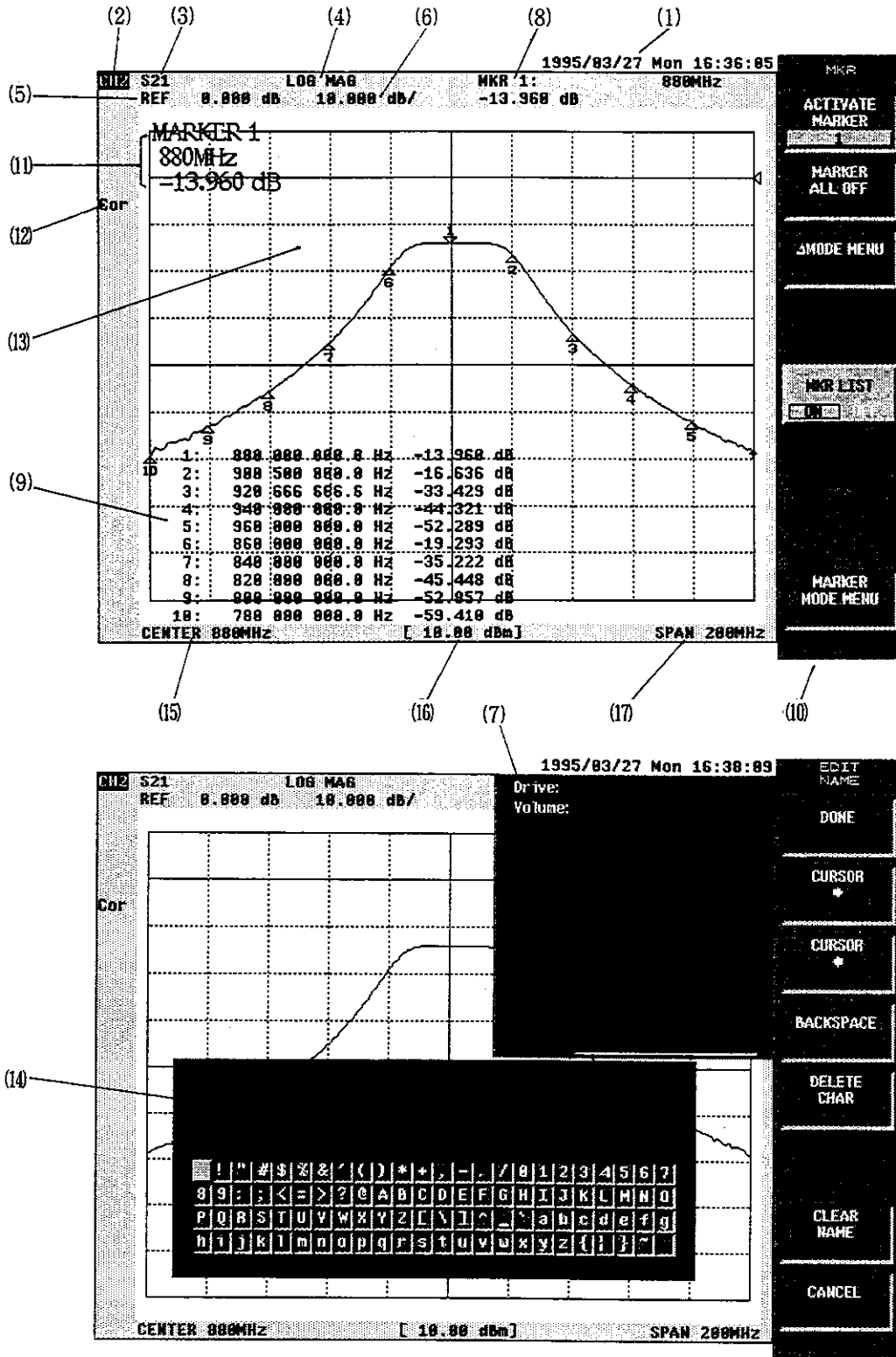

Figure 2-7 Screen Display Descriptions

Table 2-7 Screen Display Descriptions

No.	Name	Description
(1)	Real time clock	Displays year, month, date, and time.
(2)	Channel	Displays a channel number.
(3)	INPUT port	Displays an input port.
(4)	Format	Displays data format (format data).
(5)	Scale reference	Displays a reference value of display coordinate. The reference position is displayed by using → mark.
(6)	Scale/DIV	Displays one scale value of display coordinate.
(7)	Load menu	Displays files in this area when loading program from an internal disk.
(8)	Active marker	Displays an active marker value.
(9)	Marker list	Displays a marker list.
(10)	Soft key menu	Displays a soft key menu.
(11)	Active area	Displays items selected by panel keys or soft keys and those input values.
(12)	Status area	Displays status which shows an operating state of the analyzer.
(13)	Trace display area	Displays measurement data.
(14)	Label window	Displays character lists used for a label and a register name.
(15)	Start/Center	Displays the start/center of signal source.
(16)	Power/CW	Displays the power/CW of signal source.
(17)	Stop/Span	Displays the stop/span of signal source.

*MEMO* 

---



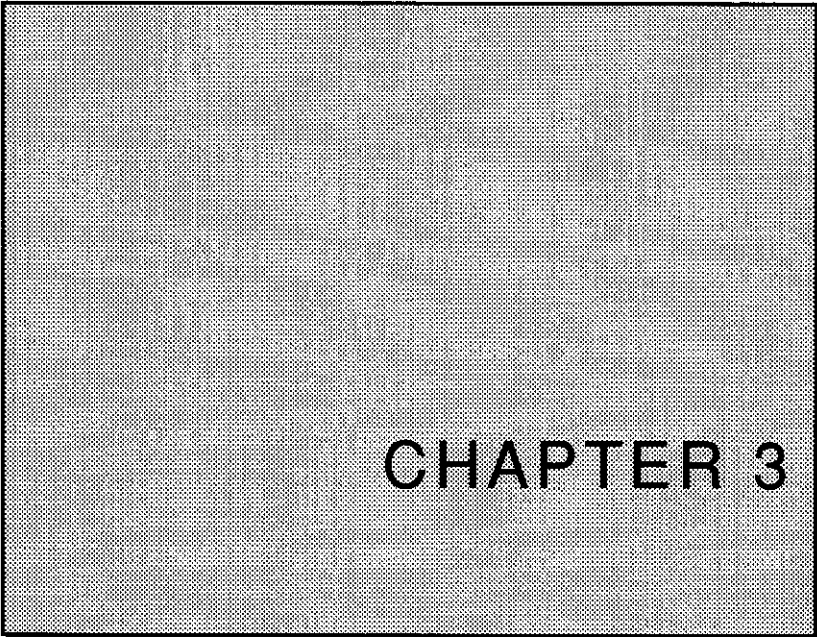

# GETTING STARTED

This chapter explains the fundamental operation for those who use this device for the first time.

---

## CONTENTS

---

- 1. Initial Power-on ..... 3-2
- 2. Operation Keys ..... 3-4
  - Panel Keys and Soft Keys ..... 3-4
- 3. How to Read the Display Screen ..... 3-9
- 4. Basic Measuring Procedure ..... 3-10
- 5. Measurement Samples of Simple Transmission
  - Characteristics ..... 3-11
  - Setup and Setting ..... 3-11
  - Calibration (Normalize) ..... 3-13
  - Magnitude measurement ..... 3-14
  - Phase measurement ..... 3-17
  - Group delay time measurement ..... 3-19
- 6. Measurement Samples of Simple Reflection Characteristics .. 3-21
  - Setup ..... 3-21
  - Calibration (1 port full calibration) ..... 3-24
  - Measurement by various formats ..... 3-27

---

# 1. Initial Power-on

## ■ Connecting to AC Power Source

1. With the device's power switch turned OFF, connect the attached power cable to the AC power connector on the rear panel.

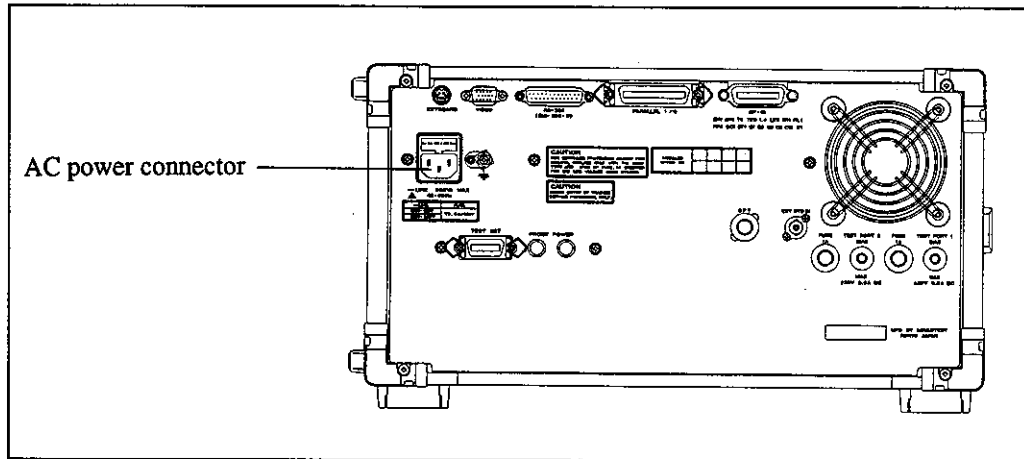

Figure 3-1 Connecting the Power Cable

2. Connect another end of the power cable to an outlet. (Refer to page 1-6.)

**WARNING !**

Connecting to an out-of spec power source may damage this device. Power specification of this device is as follows.

	Operation under 100V <sub>AC</sub>	Operation under 220V <sub>AC</sub>
Input voltage	90V to 132V	198V to 250V
Frequency	48Hz to 66Hz	48Hz to 66Hz

## ■ Power-on

After connecting the power cable, turn ON the power switch on the front panel.

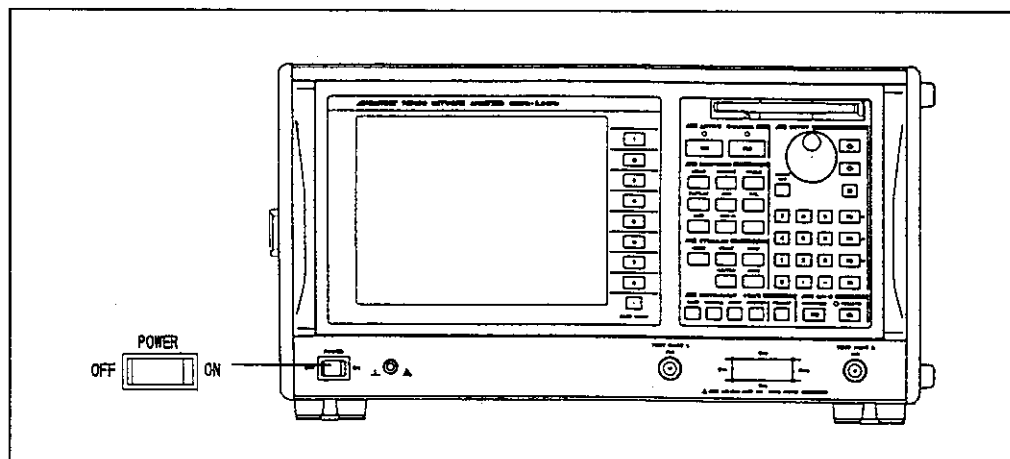

Figure 3-2 Power Switch

1. Turn the power switch ON.  
Self-checking of the analyzer is executed. A few seconds later, the initial setting screen appears.

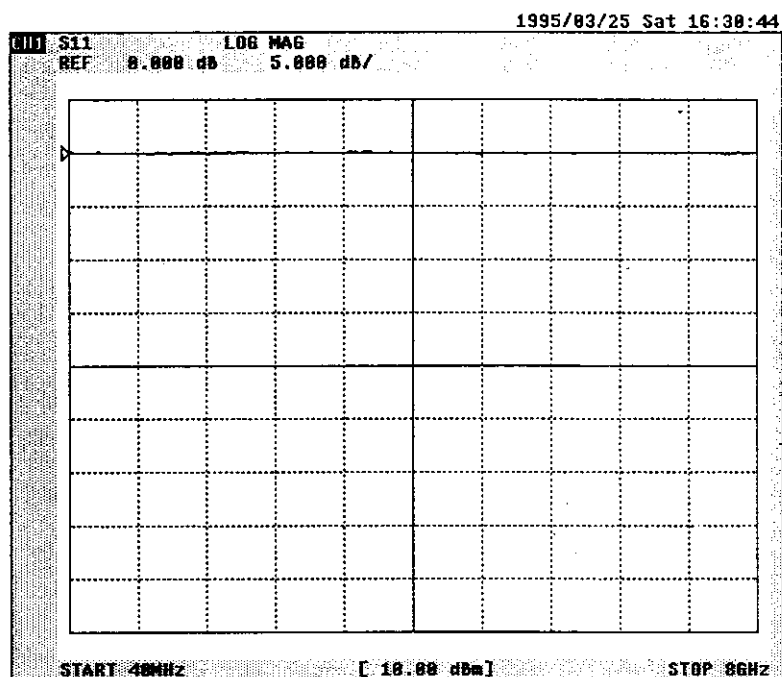

Figure 3-3 Setting Screen When Switch on or Preset

At power-on, the initial setting screen is displayed as shown above.

The screen is R3767C's.

When the initial setting screen is needed to display, press [PRESET] key.

## 2. Operation Keys

### ■ Panel Keys and Soft Keys

This device is operated with [panel keys] and [soft keys].  
 [ ] is panel keys. [ ] is soft keys.

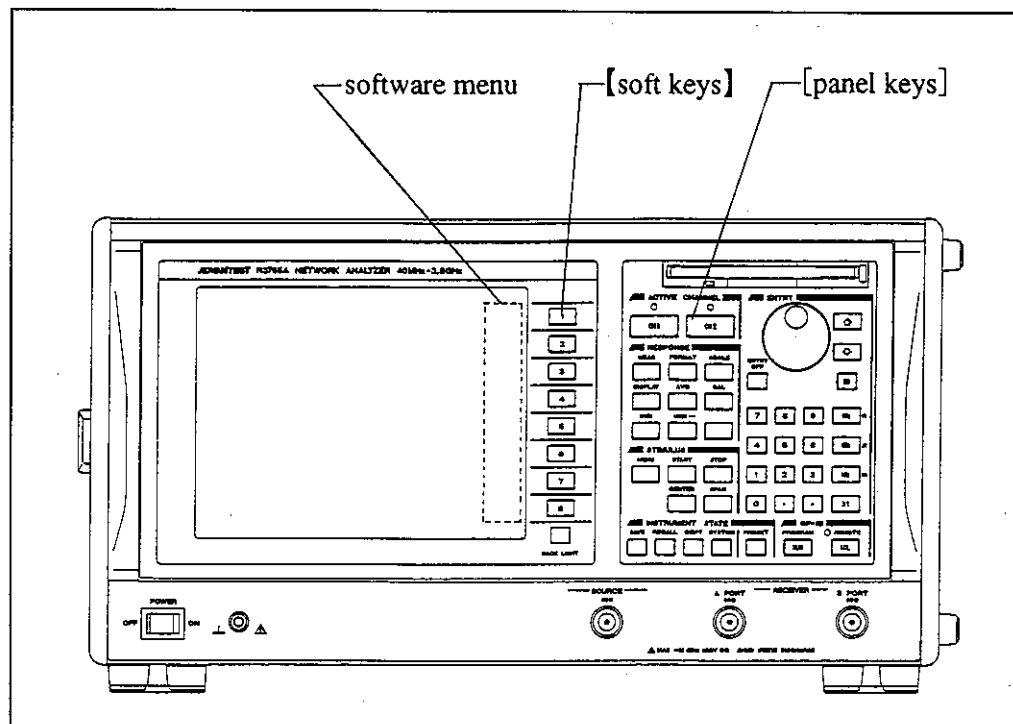

Figure 3-4 Panel Keys and Soft Keys

Pressing a [panel key] displays a software menu at right on the screen.  
 Press a [soft key] and the corresponding function in the software menu will be displayed.

- The panel keys are parted into 6 function blocks shown below.  
The operation is performed with the combination of these blocks.

Block name	Function
(1) ACTIVE CHANNEL	The analyzer has two measurement channels. Select an active channel which can be set and changed.
(2) ENTRY	Input the numeric value for the selected function.
(3) STIMULUS	Sets the conditions of signal source such as frequency range, power level, sweep type sweep time, and sweep resolution.
(4) RESPONSE	Sets measurement conditions of receiver part, measurement parameter, measurement format, and display format marker for the active channel.
(5) INSTRUMENT STATE	Sets the system such as save/recall or hard copy.
(6) GPIB	Sets controller function and GPIB.

- Press panel key [CAL] in RESPONSE block.

Calibration menu (1 of 2) appears on the screen. (Refer to Appendix page A-12 at the end of this document)

Soft menus shown below are displayed on the right portion of the display.

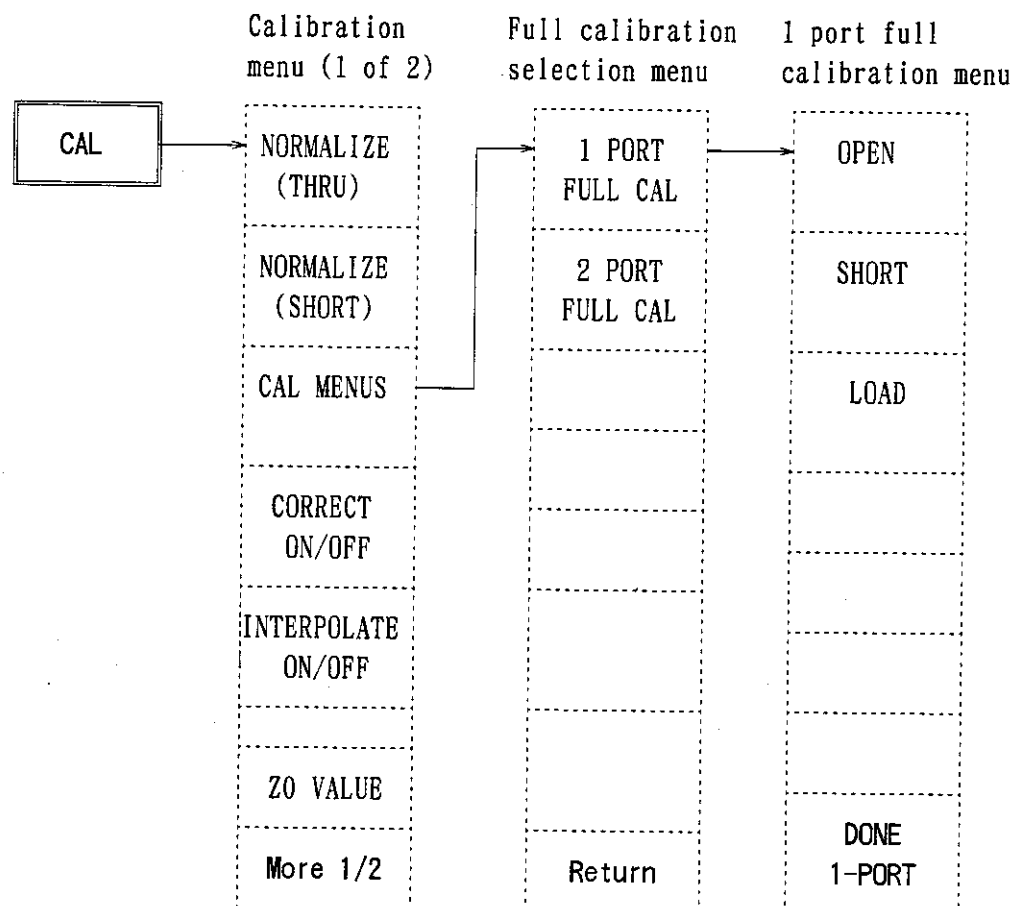

2. Operation Keys

There are 6 soft menus of [CAL] as shown in the previous page calibration menu (1 of 2), and 2 others are blank and not used now.

Some soft menu has more than one page, and some has hierarchy.

- When the soft menu has more than one page

Pressing [More 1/2] moves the page to the next.

Pressing [More 2/2] returns the page to the previous.

- When the soft menu has hierarchy

Pressing [Return] returns to the previous hierarchy menu.

- When the menu is of hierarchy of calibration data acquisition

In the case that more than one data acquisition is required for the calibration like 1 port full calibration,

Pressing [DONE 1-PORT] without acquiring each data can return to the previous hierarchy menu forcefully.

In order to move it to the top menu from the middle of a series of soft menu, press [CAL] key if the menu is of CAL. Ditto for others.

For example, pressing [MENU] key to invoke soft menu of MENU from the situation that the soft menu of CAL is displayed, and continuously pressing [CAL] key redisplay the same CAL soft menu as the one before [MENU] key pressed.

● Data setting

When a [panel key] and a [soft key] is pressed to set data, the function of the pressed key and the current set conditions are displayed at upper left on the screen.

This display area is called "active area". Set data, checking the values displayed in the active area.

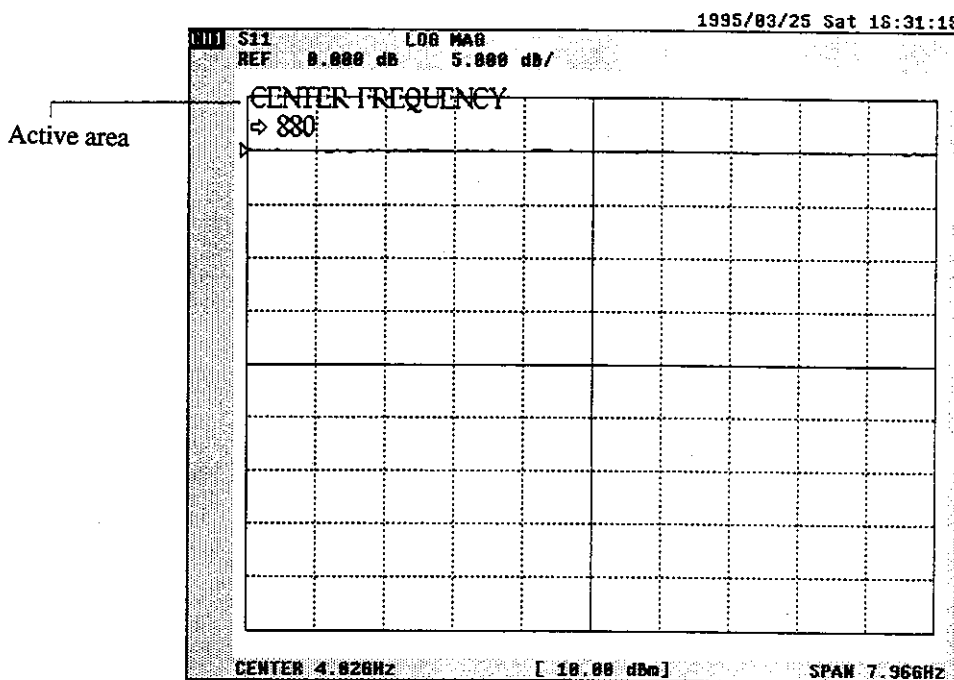

Figure 3-5 Displayed Active Area

○ There are 3 methods for setting data.

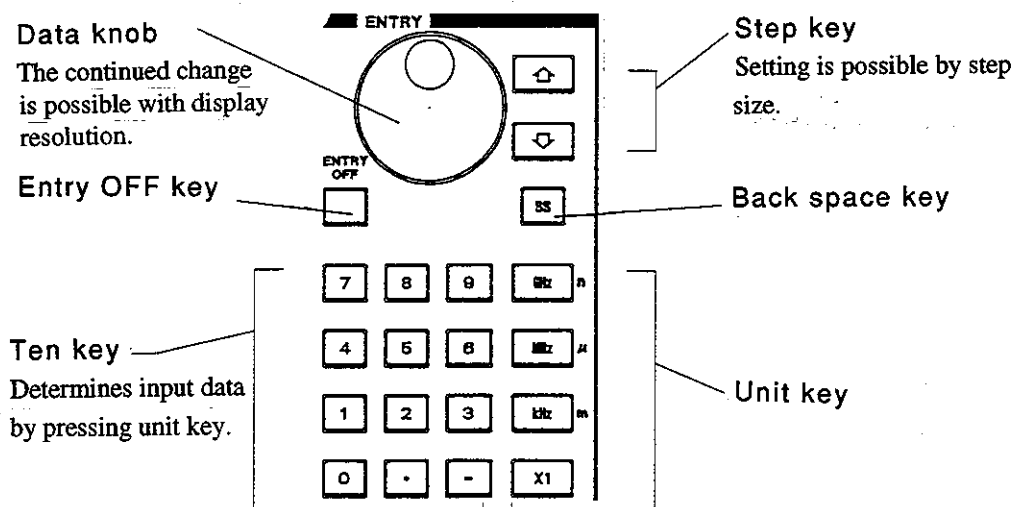

Figure 3-6 How to Set Data

2. Operation Keys

○ Ten-key and unit key

These keys are used to input numeric data.

Input a numeric value with ten-key, and press a unit key.

Pressing [BS] key deletes the rightmost digit of the numeric value which has been input with ten-key.

○ Step key and data knob

Step key is used to set data by predefined step size.

Pressing [↓] key increments the data, while pressing [↑] key decrements the data.

Data knob is used to set data in units of predefined display resolution. It is very convenient for finely adjusting set data.

○ Entry off key

Entry off key is operated by toggle.

Sets OFF the current entry data which is displayed in active area.

Press this key to avoid changing the entry data by actuating the knob by mistake. Then, the marker can be moved by data knob.

Pressing the entry off key again can switch the entry OFF to ON.

But when the preset key is pressed or when the analyzer is turned OFF automatically, the entry off key cannot be switched to ON again.

If this function is selected before plotting, the screen cleaned the active area can be plotted.



### 3. How to Read the Display Screen

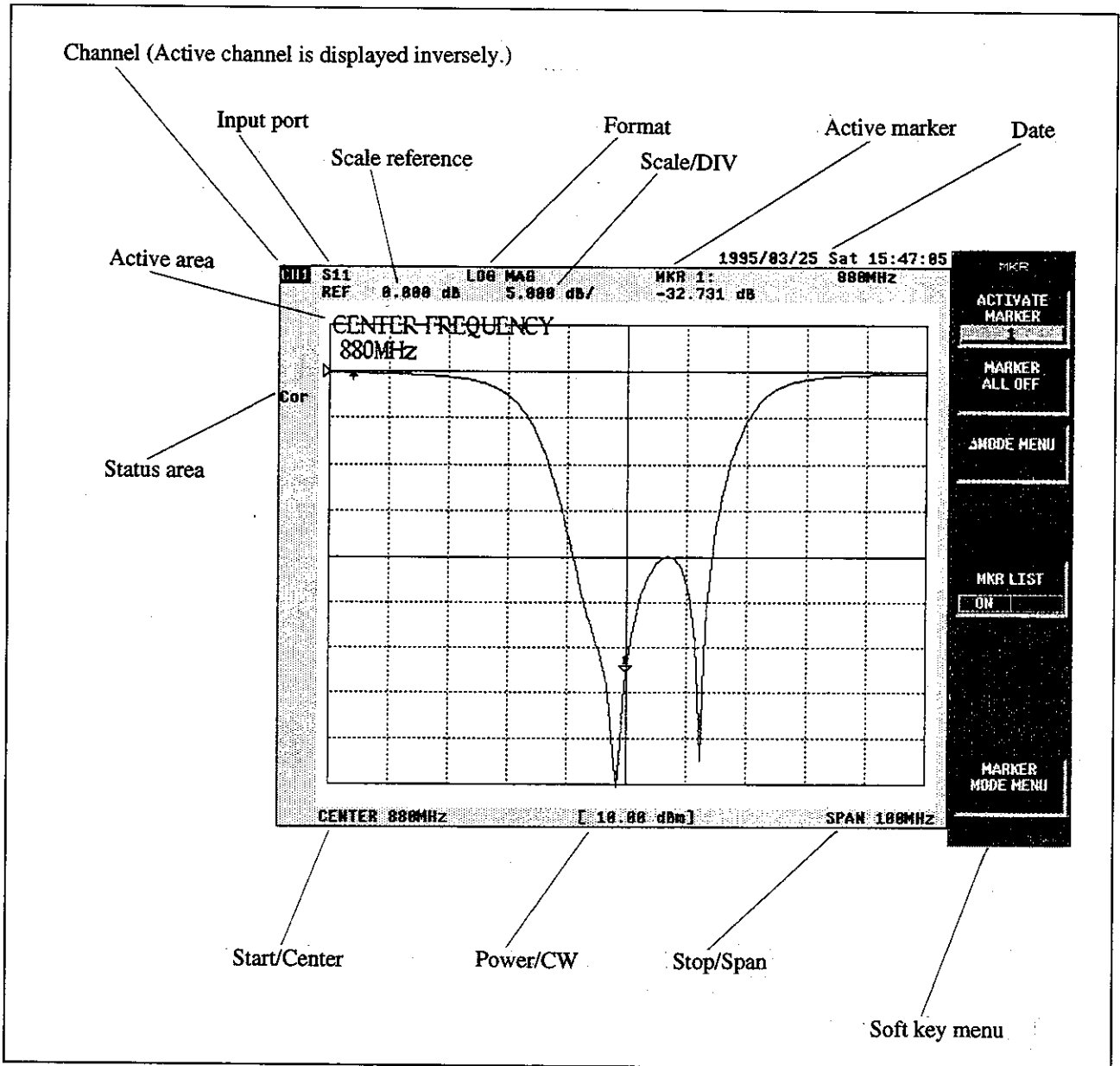

Figure 3-7 Annotation on the Screen (Annotation Character)

## 4. Basic Measuring Procedure

Shows basic measuring procedure of R3765/3767 series network analyzer.

### Measuring procedure

1. **Connection**  
Connect DUT to the analyzer.
2. **Setting of the analyzer**  
Initialize the analyzer by pressing [PRESET] key.  
Next, select the setting of the analyzer according to the measurement to perform.  
(If necessary, connect DUT temporarily then.)
3. **Calibration**  
Acquire the reference of magnitude and phase according to the measurement and eliminate measurement error.
4. **Measurement**  
Connect DUT and execute the measurement.  
Read the parameter to measure by using marker function, etc.
5. **Measured result output**  
The measured results can be output to the printer or the plotter with GPIB interface.  
Also they can be saved in floppy disk.

## 5. Measurement Samples of Simple Transmission Characteristics

### ■ Setup and Setting

The setup of the analyzer is performed as shown in Figure 3-8 or Figure 3-9 according to the type.

#### ● A type R3765A/3767A

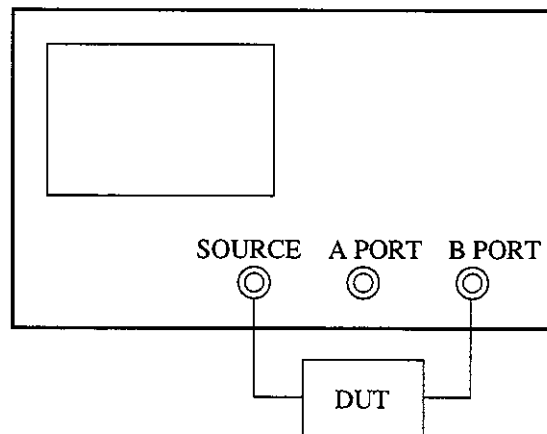

A type can be connected to S parameter test set R3961B (300kHz to 3.6GHz). (Refer to page 3-22.)

Figure 3-8 The Setup of Transmission Characteristic Measurement (A Type)

#### ● B/C type R3765B/3767B/3765C/3767C

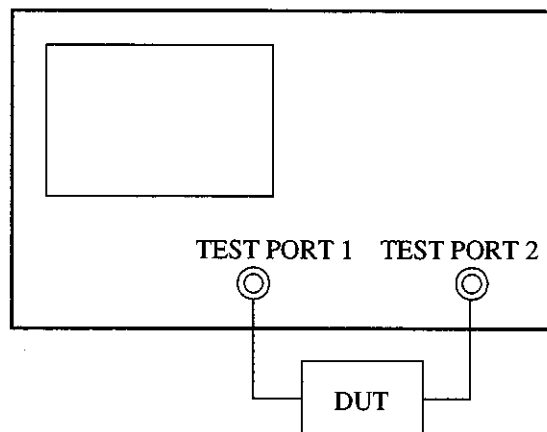

Figure 3-9 The Setup of Transmission Characteristic Measurement (B/C Type)

5. Measurement Samples of Simple Transmission Characteristics

●DUT to use for the measurement sample is the band-pass filter of center frequency 880MHz.

●All the screen displays used here are display samples of R3767C.

The displayed contents of input port in the upper left portion of the screen are different depending on the type of device as follows. (Active channel: CH2)

A type	A type + S parameter	B type	C type
B/R	S21	TRN	S21

TRN : TRANSMISSION

●Setting

Perform the preset. [PRESET]

Set the analyzer as follows.

Block name	Setting	Key operation
ACTIVE CHANNEL	Set the channel to 2.	[CH 2]
RESPONSE	Select the input port in the receiver part.	A type : [MEAS] [B/R] (Initial setup) B type : [MEAS] [TRANSMISSION] (Initial setup) C type or A type + S parameter [MEAS] [S21(B/R) TRANS FWD] (Initial setup)
	Set the measurement format to magnitude (log display).	[FORMAT] [LOG MAG] (Initial setup)
STIMULUS	Center frequency 880MHz Span frequency 100MHz	[CENTER] [8] [8] [0] [MHz] [SPAN] [1] [0] [0] [MHz]

## ■ Calibration (Normalize)

Calibrate the frequency characteristics of the analyzer.

1. Remove DUT and connect a through adapter instead.
2. Press [CAL] , [NORMALIZE (THRU)] .

The display on the screen changes as follows.

CORRECT key is set to ON automatically.

3. Following the completion, return the connection to DUT (filter).

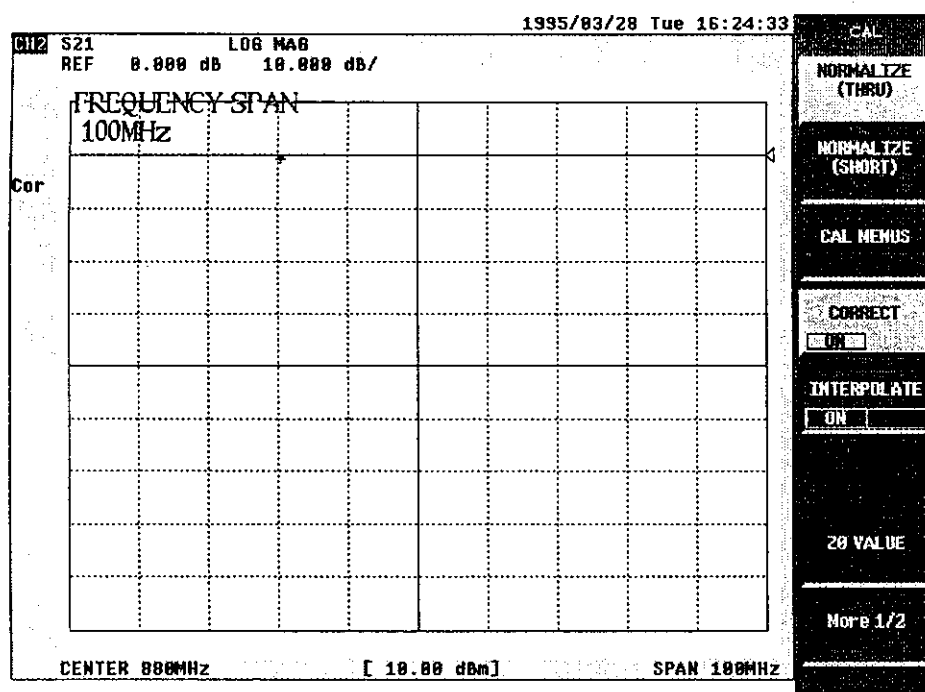

Figure 3-10 Screen of Frequency Characteristic Normalize

5. Measurement Samples of Simple Transmission Characteristics

■ Magnitude measurement

1. Calibrate the scale to see the display waveform easily.

[SCALE] [AUTO SCALE]

The display on the screen is as follows.

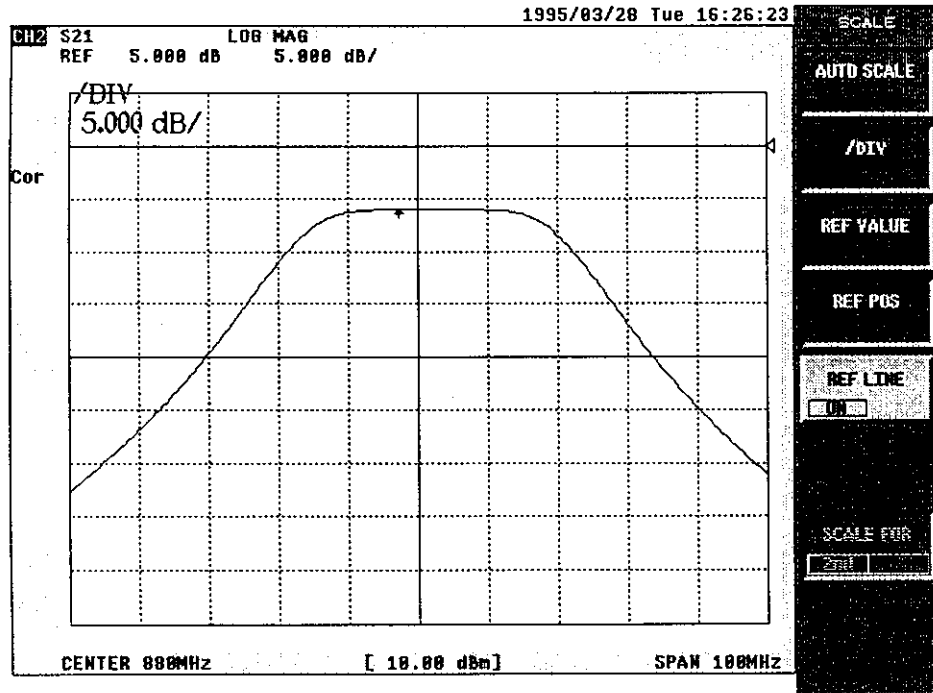

Figure 3-11 Auto-scale of Magnitude Measurement

5. Measurement Samples of Simple Transmission Characteristics

2. A measurement sample of 3dB bandwidth

Set the marker and activate the filter analysis function.

[MKR→] [MKR SEARCH [     ]] [FLTR ANAL] [FLTR ANAL ON/OFF]

The display on the screen is as follows.

Bandwidth is displayed with arrow (↓) on the waveform and the analyzed results are displayed.

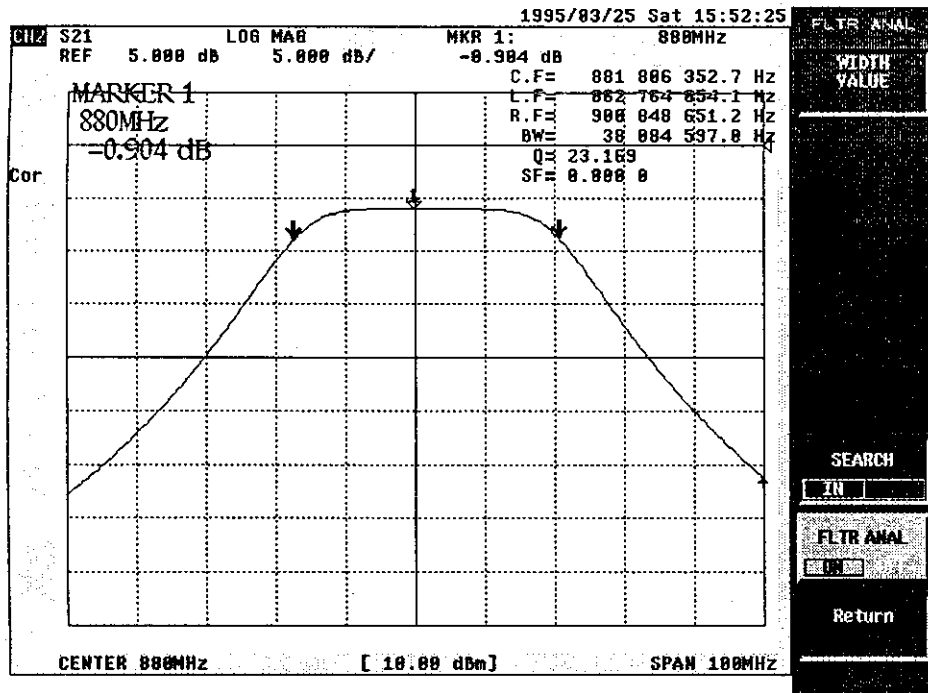

Figure 3-12 Filter Analyzing Function (3dB Bandwidth and Q Measurement)

5. Measurement Samples of Simple Transmission Characteristics

3. A measurement sample of 6dB bandwidth

Change WIDTH VALUE (bandwidth to search) from 3dB (initial value) to 6dB.  
 Press [WIDTH VALUE] , [6] , [×1]

The display on the screen is as follows.

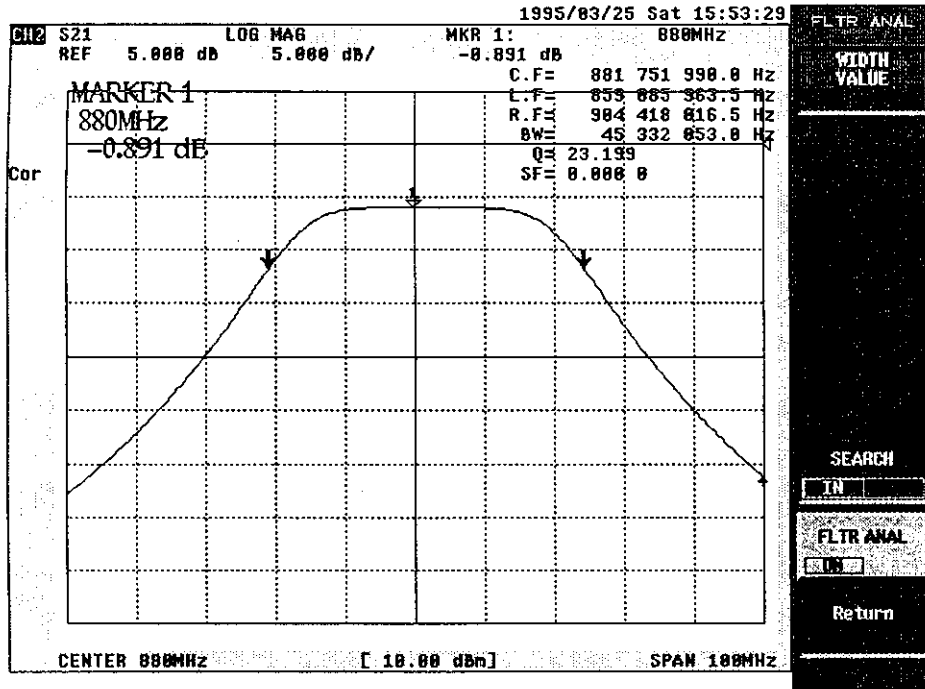

Figure 3-13 Filter Analyzing Function  
 (6dB Bandwidth and Q Measurement)



■ Phase measurement

1. Setup (refer to page 3-11) and preset (refer to page 4-4).

2. Set the analyzer as follows.

The measurement here is performed with the span lessened and inside of the bandwidth extended.

Block name	Setting	Key operation
ACTIVE CHANNEL	Set the channel to 2.	[CH 2]
RESPONSE	Select the input port in the receiver part.	A type : [MEAS] [B/R] (Initial setup) B type : [MEAS] [TRANSMISSION] (Initial setup) C type or A type + S parameter [MEAS] [S21(B/R) TRANS FWD] (Initial setup)
	Set the measurement format to phase display.	[FORMAT] [PHASE] (Initial setup)
STIMULUS	Center frequency 880MHz	[CENTER] [8] [8] [0] [MHz]
	Span frequency 50MHz	[SPAN] [5] [0] [MHz]

3. Calibrate (Normalize) frequency characteristics. (The same operation as page 3-13)

4. Calibrate the scale to see the display waveform easily.

Pressing [SCALE] , [AUTO SCALE] shows the following display on the screen.

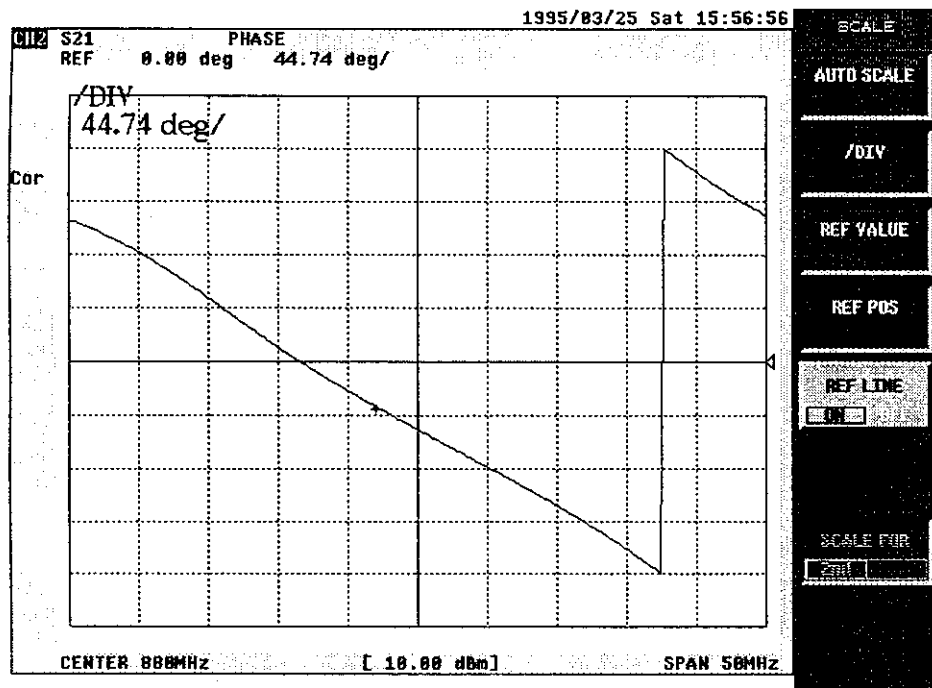

Figure 3-14 Auto-scale of Phase Measurement

5. Measurement Samples of Simple Transmission Characteristics

5. Set the phase extension display.

[FORMAT] [More 1/2] [PHASE -∞, +∞]  
[SCALE] [AUTO SCALE]

The display on the screen is as follows.

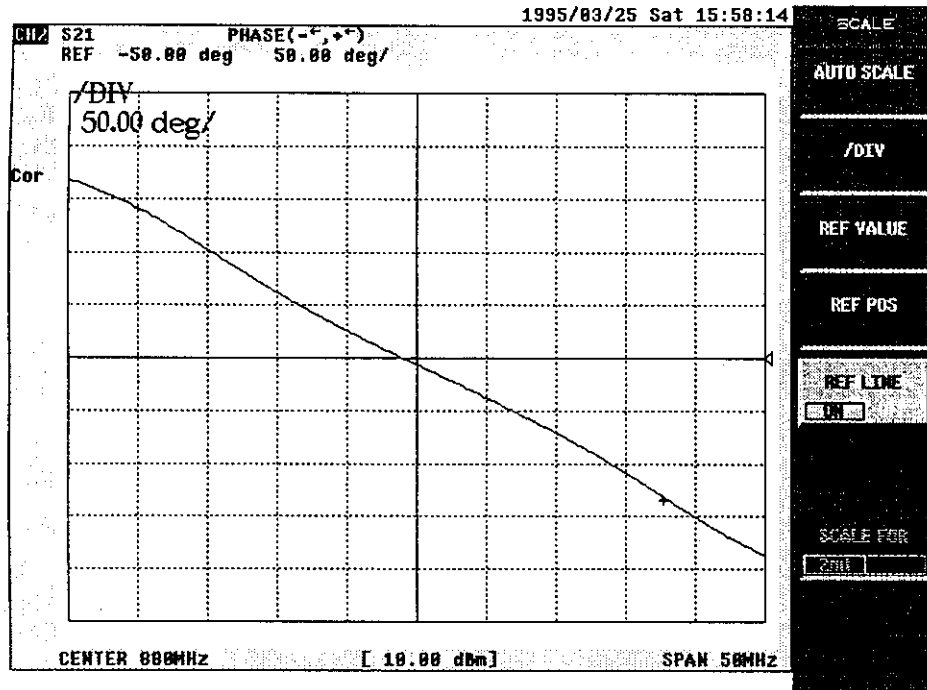

Figure 3-15 Phase Extension Display

## ■ Group delay time measurement

1. Setup (refer to page 3-11) and preset (refer to page 4-4).

2. Set the analyzer as follows.

The measurement here is performed with the span lessened and inside of the bandwidth extended.

Block name	Setting	Key operation
ACTIVE CHANNEL	Set the channel to 2.	[CH 2]
RESPONSE	Select the input port in the receiver part.	A type : [MEAS] [B/R] (Initial setup) B type : [MEAS] [TRANSMISSION] (Initial setup) C type or A type + S parameter [MEAS] [S21(B/R) TRANS FWD] (Initial setup)
	Set the measurement format to group delay time display.	[FORMAT] [DELAY] (Initial setup)
STIMULUS	Center frequency 880MHz Span frequency 50MHz	[CENTER] [8] [8] [0] [MHz] [SPAN] [5] [0] [MHz]

3. Calibrate frequency characteristics. (The same operation as page 3-13)

4. Calibrate the scale to see the display waveform easily.

Pressing [SCALE] , [AUTO SCALE] shows the following display on the screen.

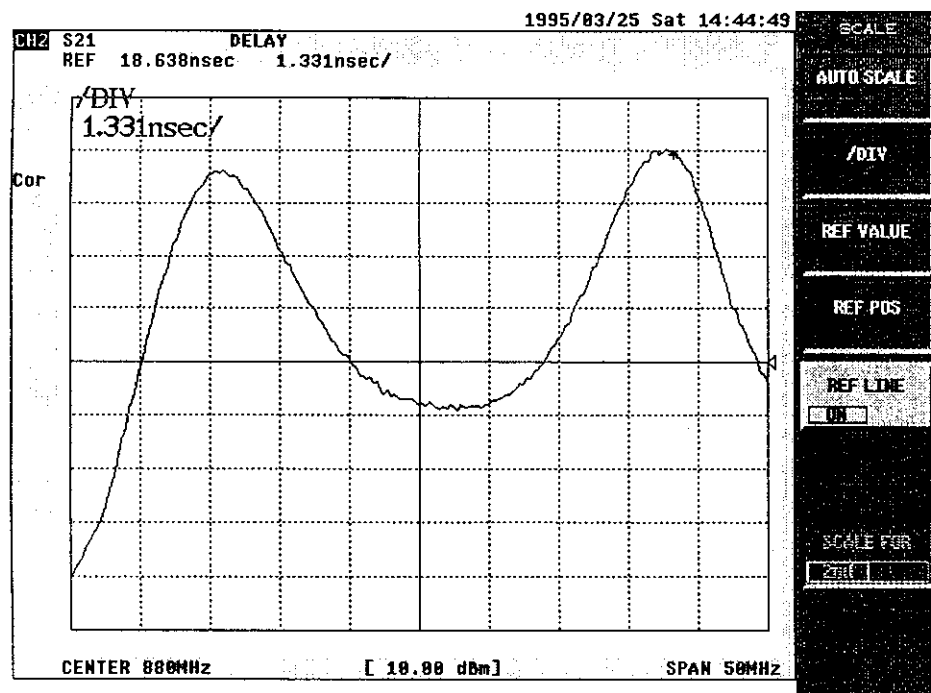

Figure 3-16 Auto-scale of Group Delay Time Measurement

5. Measurement Samples of Simple Transmission Characteristics

- 5. Change group delay aperture to 20%.  
[AVG] [GROUP DELAY APERTURE] [2] [0] [×1]

The display on the screen is as follows.

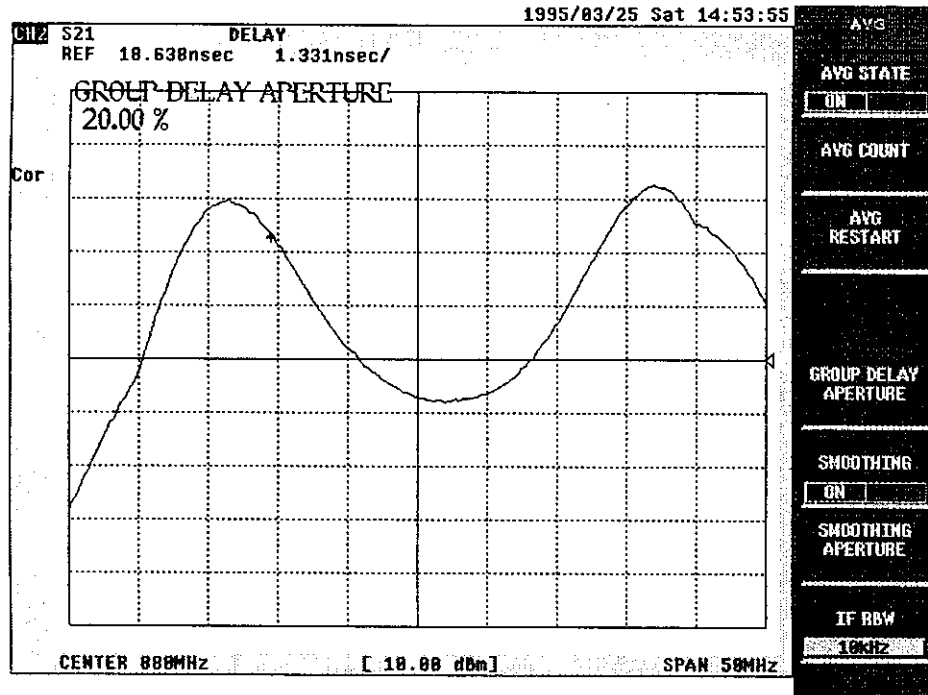

Figure 3-17 Change of Group Delay Aperture

## 6. Measurement Samples of Simple Reflection Characteristics

### ■ Setup

The analyzer is set up as shown in Figure 3-18, 3-19, or 3-20.

#### ● A type

In order to measure the reflection characteristics with A type, directive bridge to separate reflection wave and incident wave from DUT to measure are necessary.

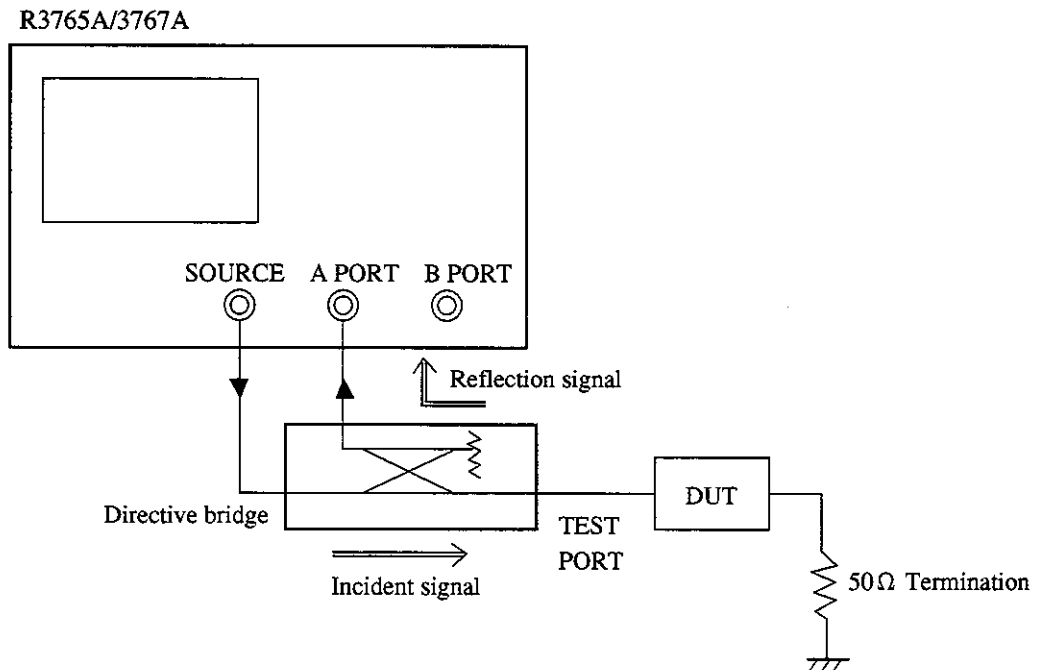

Figure 3-18 Setup I for A Type Reflection Characteristics Measurement

6. Measurement Samples of Simple Reflection Characteristics

Or by using S parameter test set R3961B(300kHz to 3.6GHz), transmission/reflection characteristics can be measured simply.

●A type

R3765A/3767A

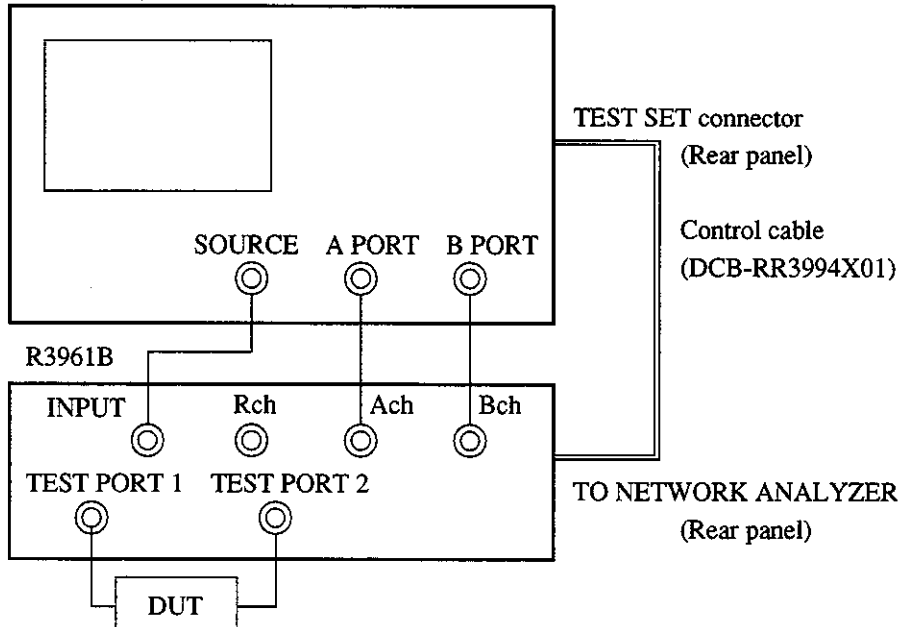

Figure 3-19 Setup II for A Type Reflection Characteristics Measurement

Above measuring method using S parameter test set is the same as the case of C type.

●B/C type

R3765B/3767B/3765C/3767C

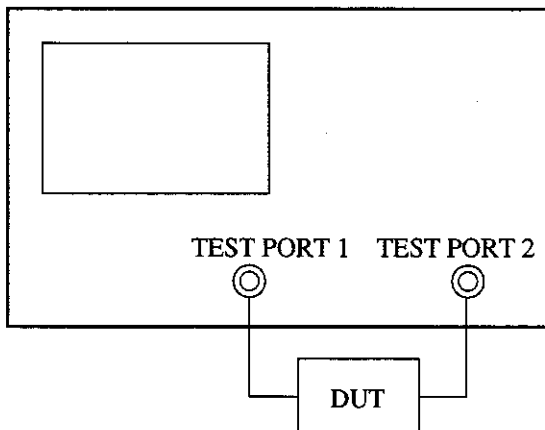

Figure 3-20 Setup for Reflection Characteristic Measurement

## 6. Measurement Samples of Simple Reflection Characteristics

- DUT of this measurement sample is band pass filter of center frequency 880MHz.
- All the displays used on the screen are display samples of R3767C.

The displayed contents of input port in the upper left portion of the screen are different depending on the type of device as follows.

A type	A type + S parameter	B type	C type
A/R	S11	RFL	S11

RFL : REFLECTION

- Setting

1. Press [PRESET] to preset.
2. Setting of the analyzer is as follows.

Block name	Setting	Key operation
ACTIVE CHANNEL	Set the channel to 1.	[CH 1]
RESPONSE	Select the input port in the receiver part.	A type : [MEAS] [A/R] (Initial setup) B type : [MEAS] [REFLECTION] (Initial setup) C type or A type + S parameter [MEAS] [S11(A/R) REFL FWD] (Initial setup)
	Set the measurement format to magnitude (log display).	[FORMAT] [LOG MAG] (Initial setup)
STIMULUS	Center frequency 880MHz Span frequency 100MHz	[CENTER] [8] [8] [0] [MHz] [SPAN] [1] [0] [0] [MHz]

## 6. Measurement Samples of Simple Reflection Characteristics

## ■ Calibration (1 port full calibration)

In the case of A type, perform 1 port full calibration of bridge test port.

In the case of B/C type or A type + S parameter test set, perform 1 port full calibration of test port 1.

## A D V I C E

1. If the calibration has already been executed, switch OFF the calibration, clear the calibration data, and then start calibration.
2. When the message "Wait for Sweep" disappeared, each calibration completes.
3. The analyzer, the cable, the connector, etc. must not be moved during the message is displayed.

1. Invoke 1 port full calibration menu.  
[CAL] [CAL MENUS] [1 PORT FULL CAL]
2. Connect the open standard to the test port and acquire the calibration data.  
[OPEN]  
The display on the screen is as follows.

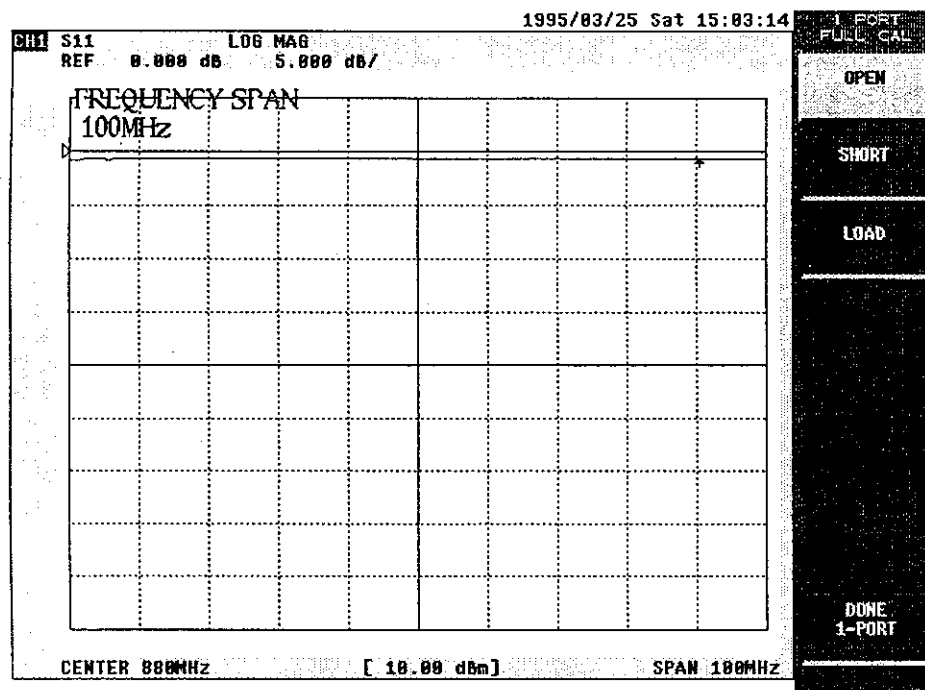

Figure 3-21 1 Port Full Calibration (Open)



6. Measurement Samples of Simple Reflection Characteristics

3. Connect the short standard to the test port and acquire the calibration data.

**[SHORT]**

The display on the screen is as follows.

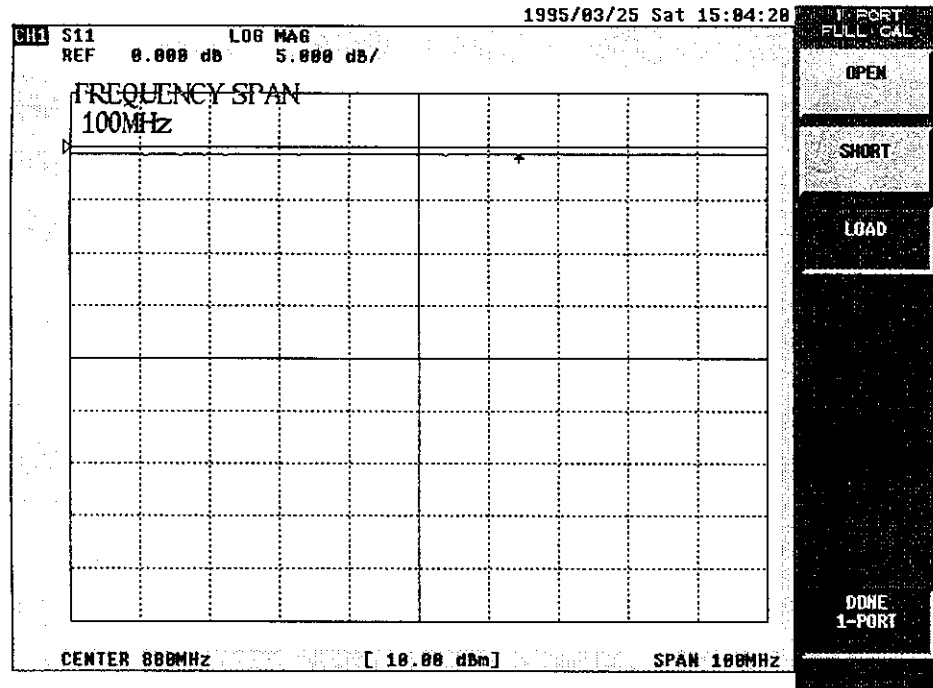

Figure 3-22 1 Port Full Calibration (Short)

6. Measurement Samples of Simple Reflection Characteristics

- 4. Connect the load standard to the test port and acquire the calibration data.

[LOAD]

The display on the screen is as follows.

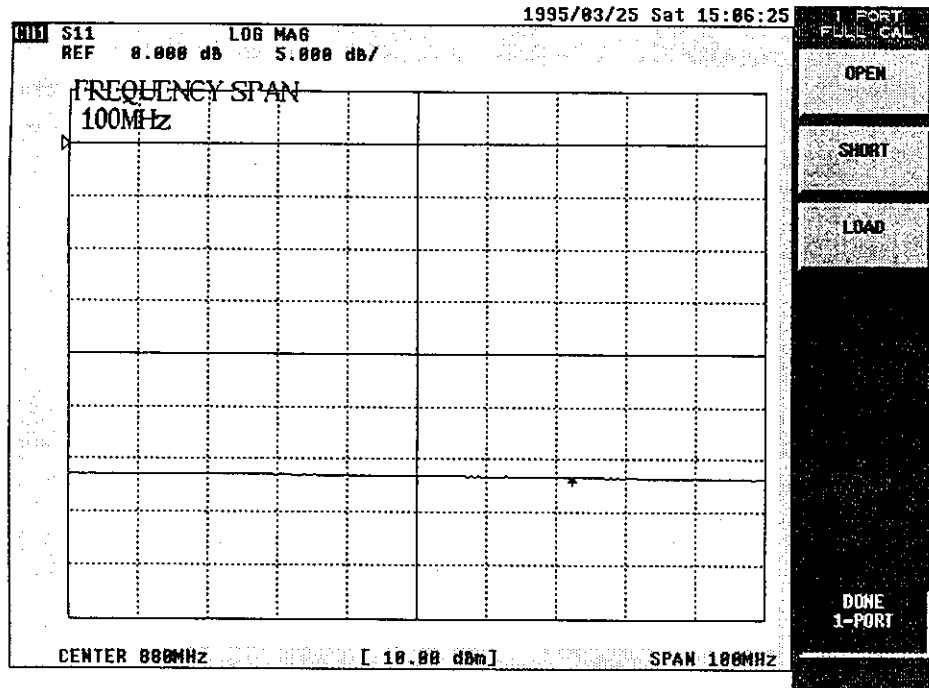

Figure 3-23 1 Port Full Calibration (Load)

- 5. Execute the calibration and end.  
[DONE 1-PORT]  
The calibration data becomes effective automatically.
- 6. Following the completion, return the connection to DUT (an example: filter).

## ■ Measurement by various formats

Here describes about measurement methods by various formats of reflection measurement (return loss, reflection coefficient, standing wave ratio, S parameter and impedance).

### 1. Return loss (LOG MAG format setting) measurement

Calibrate the scale to see the display waveform (magnitude ) easily.

[SCALE] 【AUTO SCALE】

Letting the reflective coefficient =  $\rho$  (= reflective signal/incident signal), the return loss is represented with the following equation.

$$\text{Return loss} = -20\log(\rho)$$

The display on the screen (return loss) is as follows.

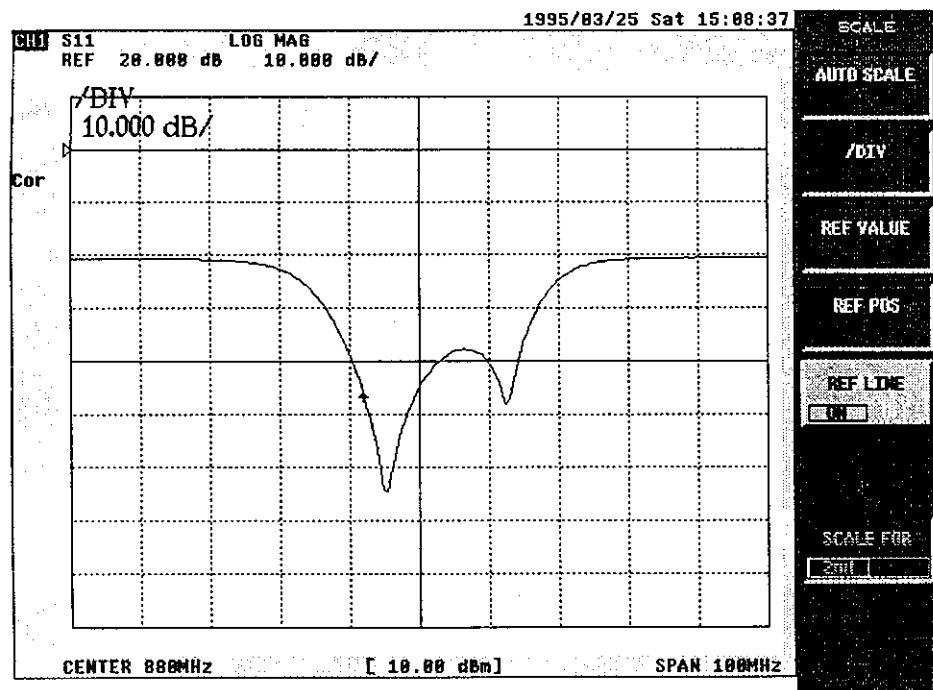

Figure 3-24 Return Loss Measurement

6. Measurement Samples of Simple Reflection Characteristics

2. Measurement of reflection coefficient (LIN MAG format setting)

The following operation is performed to display the return loss converted into reflection coefficient.

[FORMAT] [LIN MAG]

※If the format soft menu has already been displayed, it's not necessary to press [FORMAT] .

The top of the screen corresponds to reflection coefficient 1 (full reflection), and the bottom corresponds to reflection coefficient 0. The display becomes of linear scale.

[SCALE] [AUTO SCALE]

The display on the screen is as follows.

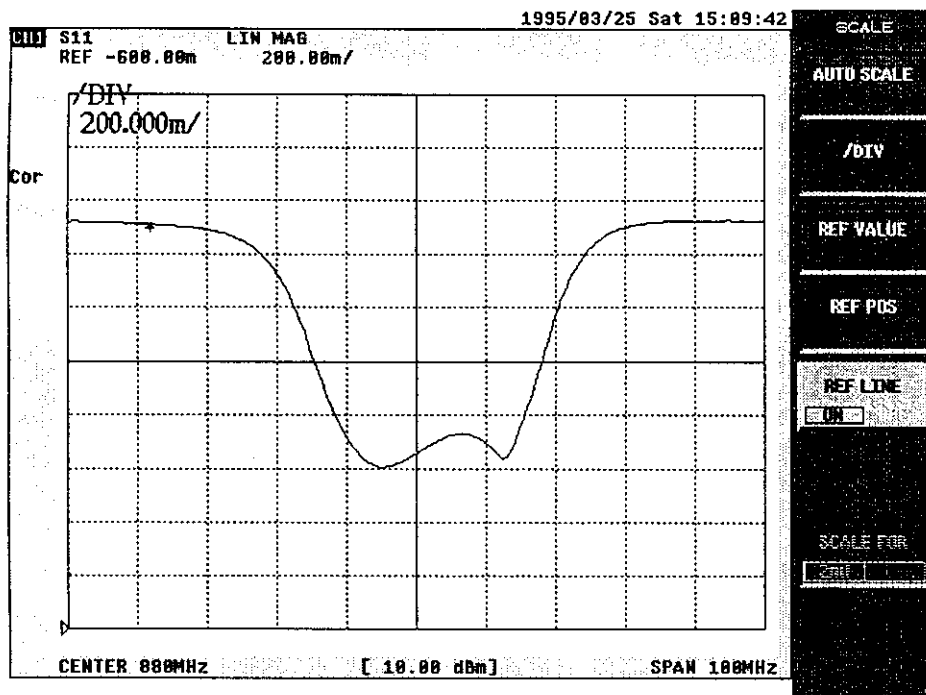

Figure 3-25 Reflection Coefficient Measurement

## 3. Standing wave ratio (SWR format setting) measurement

The following operation is performed to display the return loss as the standing wave ratio (SWR).

[FORMAT] [More 1/2] [SWR]  
[SCALE] [AUTO SCALE]

SWR=1 corresponds to the state of perfect matching.

The related expression between SWR and reflection coefficient  $\rho$  is as follows.

$$\text{SWR} = (1 + \rho) / (1 - \rho)$$

The display on the screen is as follows.

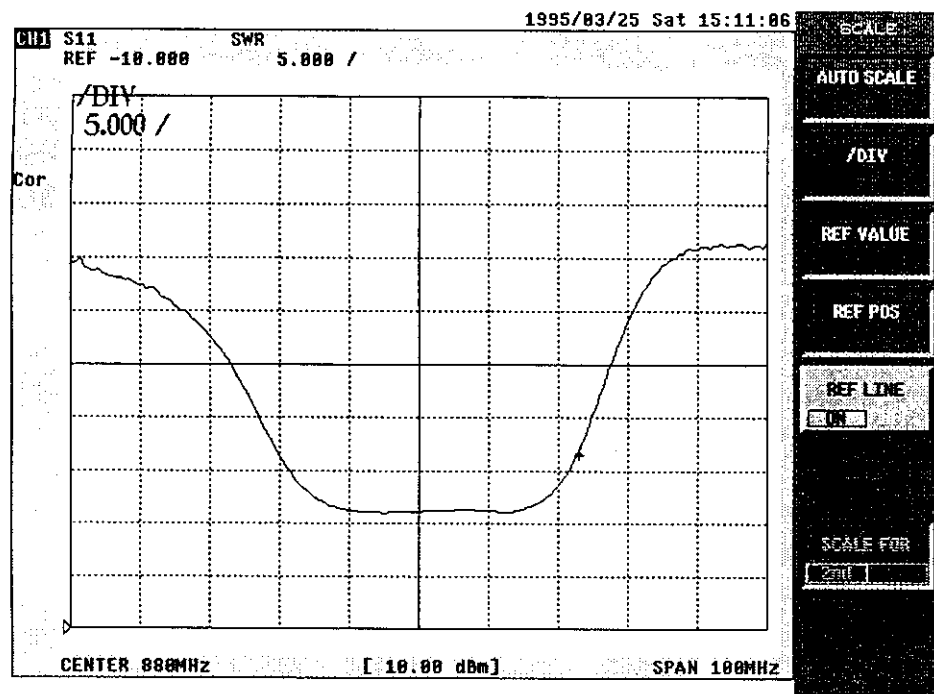

Figure 3-26 Standing Wave Ratio (SWR) Measurement

6. Measurement Samples of Simple Reflection Characteristics

4. S parameter (POLAR format setting) measurement

The following operation is performed to display polar coordinates.

[FORMAT] [POLAR]

The display on the screen is as follows.

Each coordinate shows the magnitude and the phase as follows.

- (1) The magnitude is displayed with line and the size of the magnitude is displayed with the radius of the circle.

The center of the circle : Reflection coefficient 0 (The state of perfect matching)

The most outer circumference of the circle :

Reflection coefficient 1 (Full reflection)

- (2) The phase is displayed with the angle from the plus direction of X axis.

It shows that the direction of 3 o'clock is phase angle 0 ° and the phases of the incident signal and the reflection signal are the same.

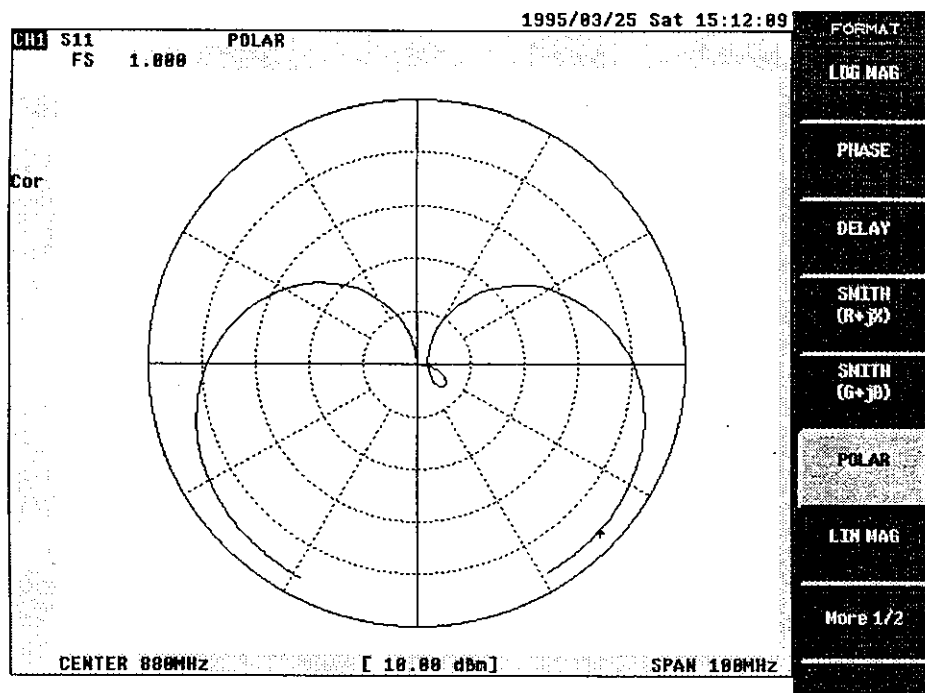

Figure 3-27 S Parameter Measurement

## 6. Measurement Samples of Simple Reflection Characteristics

## 5. Impedance (Smith chart setting) measurement

The following operation is performed to make Smith chart.

[FORMAT] [SMITH (R+jX)]

The display on the screen is as follows.

It shows that the impedance is inductive in the upper half circle of Smith chart and it is capacitive in the lower half circle.

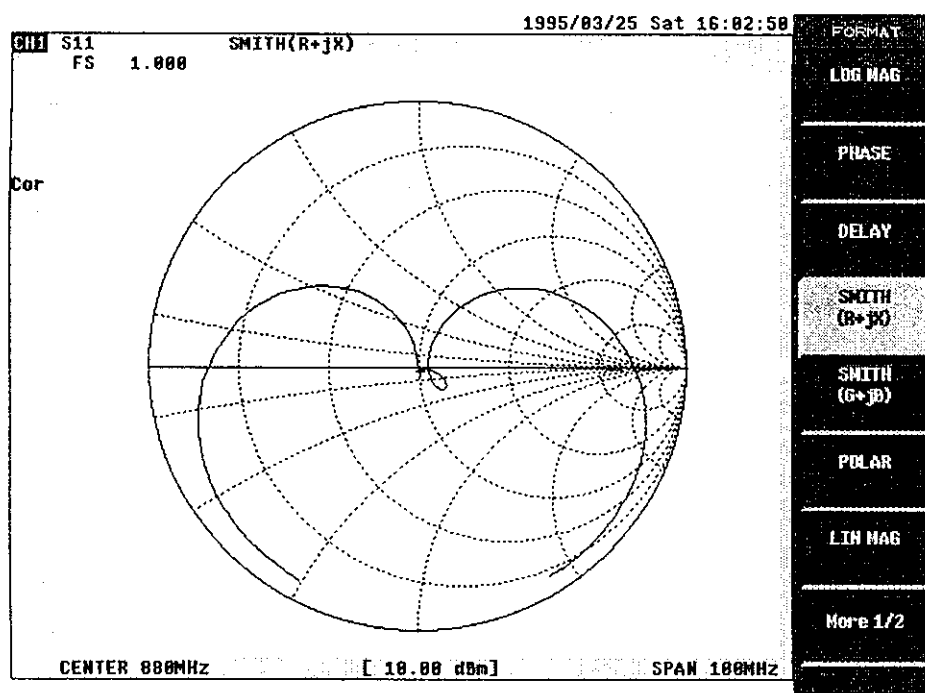

Figure 3-28 Impedance Measurement

## 6. The following operation is performed to convert to admittance chart.

Pressing [FORMAT] & [SMITH (G+jB)] displays the converted result.

MEMO





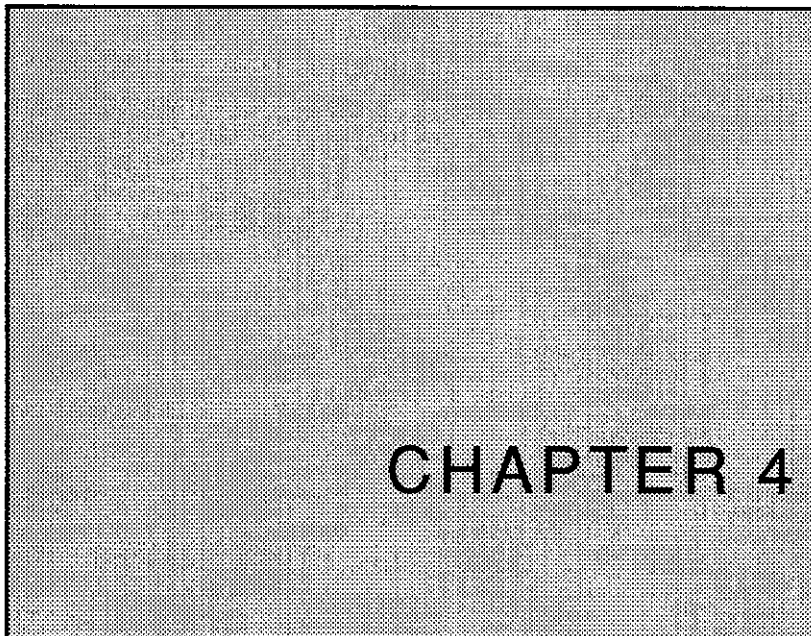

## OPERATING BASICS

This chapter describes about the keys and the soft menus of the analyzer basically.

---

### CONTENTS

---

1. Keys Necessary for Basic Operation .....	4-2
2. Samples of Basic Key Operation .....	4-2
3. Soft Menu Configuration .....	4-3
4. Initial Setup .....	4-4
How to Initialize .....	4-4
Initial Setup Value .....	4-4
5. Setting Backup Memory (Factory Default Settings) .....	4-7

---

## 1. Keys Necessary for Basic Operation

Front panel keys are grouped under the following six function blocks. The operation is performed by the combination of these blocks.

- **ACTIVE CHANNEL block**

The analyzer has 2 measurement channels. (Refer to page 7-2.)

Select an active channel which can be set and changed.

- **ENTRY block**

Input numeric value to the selected function. (Refer to page 7-4.)

- **STIMULUS block**

Make the setting for the signal resource. (Refer to page 7-6.)

- **RESPONSE block**

Make setting of the receiver part and the information on the display screen. (Refer to page 7-10.)

- **INSTRUMENT STATE block**

Make the system setting such as save/recall or hard copy, etc. (Refer to page 7-71.)

- **GPIB block**

Make the setting of controller function and GPIB. (Refer to page 7-84.)

## 2. Samples of Basic Key Operation

The key operation of the analyzer is performed in the following three ways.

- The case that the numeric value data input is required.

[Panel key] → [Soft key] → [Panel key] in ENTRY block

[Panel key] → [Panel key] in ENTRY block

- The case that the selection is made only by soft menu.

[Panel key] → [Soft key]

Pressing a key for more than about 0.5 seconds can input the key continuously.

But if more than two keys are pressed at the same time, none of the keys can be input.

### 3. Soft Menu Configuration

Soft menu has two types, having more than two pages and hierarchy.

Refer to 4 "Soft menu list" at the end of this document, page A-9 to A-20, for details.

●Soft menu having more than two pages

Pressing **【More 1/2】** moves the page to the next, and pressing **【More 2/2】** returns the page to the previous.

●Soft menu of hierarchy

Pressing **【Return】** returns to the previous hierarchy menu.

●Soft menu of calibration data acquisition hierarchy

After executing **【DONE】**, returns to the previous hierarchy menu.

Some functions cannot be used because the models of R3765/3767 series are different. The menu related to these operations is not displayed.

In the case of R3765A/3767A, check the connecting state of S parameter test set at power-on. When the test set is not connected, the menu related to S parameter is not displayed.

## 4. Initial Setup

### ■ How to Initialize

#### □ Operating Procedure

1. Press [PRESET] key of INSTRUMENT STATE block.  
The contents of the setup is initialized to the following initial setup value.

### ■ Initial Setup Value

Table 4-1 Initial Setup Value (1 of 3)

Function	Initialize method	
	Power on or preset	*RST
<b>Stimulus</b>		
Sweep type	Linear frequency sweep	Linear frequency sweep
Continuous sweep	ON	OFF
Trigger source	Internal (FREE RUN)	Internal (FREE RUN)
Trigger delay	OFF (0sec)	OFF (0sec)
Sweep time	190.95msec (AUTO) (R3765A/B/C)	240.2msec (AUTO) (R3765A/B/C)
	402.0msec (AUTO) (R3767A/B/C)	420.35msec (AUTO) (R3767A/B/C)
Measurement point	201	1201
Start frequency	40MHz	40MHz
Stop frequency	3.8GHz (R3765A/B/C)	3.8GHz (R3765A/B/C)
	8.0GHz (R3767A/B/C)	8.0GHz (R3767A/B/C)
Center frequency	1.92GHz (R3765A/B/C)	1.92GHz (R3765A/B/C)
	4.02GHz (R3767A/B/C)	4.02GHz (R3767A/B/C)
Frequency span	3.76GHz (R3765A/B/C)	3.76GHz (R3765A/B/C)
	7.96GHz (R3767A/B/C)	7.96GHz (R3767A/B/C)
Frequency display	Start/Stop	Start/Stop
Fixed frequency of level sweep	1GHz	1GHz
Output level	※1	※1
Start level	※2	※2
Stop level	※2	※2
Two-channel interlocking	ON	ON
Program sweep segment	All clear	All clear
<b>Response</b>		
Dual channel	OFF	OFF
Active channel	CH 1	CH 1
Resolution bandwidth	10kHz	10kHz
Selection item of input port	※3	※3
Average	OFF (Number of times 16)	OFF (Number of times 16)
Trace operation	NONE	NONE
Conversion	NONE	NONE
Characteristic impedance	50 Ω	50 Ω
Measurement format	※4	※4
Group delay aperture	10%	0.01%
Smoothing	OFF (Aperture 10%)	OFF (Aperture 0.01%)
Display	Data	Data
Split/Overlap	Overlap	Overlap
Label	NONE	NONE

## ※1 : Output level

Type	Power on or preset	*RST
A	0dBm	0dBm
B	0dBm	0dBm
C	10dBm	10dBm
A+S parameter		

## ※2 : Start/Stop level

Type	Power on or preset		*RST	
	Start	Stop	Start	Stop
A	-13dBm	0dBm	-13dBm	22dBm
B	-15dBm	0dBm	-15dBm	20dBm
C	-20dBm	0dBm	-20dBm	10dBm
A+S parameter				

## ※3 : Selection item of input port

Type	Channel	CH1	CH2	CH3	CH4
A		A/R	B/R	A/R	B/R
B		REFLECTION	TRANSMISSION	REFLECTION	TRANSMISSION
C		S11	S21	S11	S21
A+S parameter					

## ※4 : Measurement format

Type	Channel	CH1	CH2	CH3	CH4
A		LOG MAG	LOG MAG	LOG MAG	LOG MAG
B		LOG MAG	LOG MAG	POLAR	LOG MAG
C		LOG MAG	LOG MAG	POLAR	LOG MAG
A+S parameter					

## 4. Initial Setup

Table 4-2 Initial Setup Value (2 of 3)

Function	Initialize method	
	Power on or preset	*RST
<b>Reference value</b>		
Logarithm amplitude	0dB	0dB
Phase	0°	0°
Group delay	0sec	0sec
Smith chart	1	1
Polar coordinate	1	1
Linear amplitude	0	0
SWR	1	1
Real part	10	10
Imaginary part	10	10
Continuous phase	0°	0°
<b>The value per division of Y-axis</b>		
Logarithm amplitude	※5	※5
Phase	45°	45°
Group delay	100nsec	100nsec
Smith chart	—	—
Polar coordinate	—	—
Linear amplitude	100m	100m
SWR	1	1
Real part	1	1
Imaginary part	1	1
Continuous phase	360°	360°
<b>Reference position</b>		
Logarithm amplitude	※6	※6
Phase	50%	50%
Group delay	50%	50%
Smith chart	—	—
Polar coordinate	—	—
Linear amplitude	0%	0%
SWR	0%	0%
Real part	100%	100%
Imaginary part	100%	100%
Continuous phase	50%	50%

※5 : Logarithm amplitude (the value per division of Y-axis)

Type \ Channel	CH1	CH2	CH3	CH4
A	10dB	10dB	1dB	1dB
B	5dB	10dB	1 UNIT	1dB
C	5dB	10dB	1 UNIT	1dB
A+S parameter				

※6 : Logarithm amplitude (reference position)

Type \ Channel	CH1	CH2	CH3	CH4
A	90%	90%	90%	90%
B	90%	90%	—	90%
C	90%	90%	—	90%
A+S parameter				

Table 4-3 Initial Setup Value (3 of 3)

Function	Initialize method	
	Power on or preset	*RST
<b>Calibration</b>		
Correct measurement	OFF	OFF
Calibration data	Clear	Clear
Electrical length calibration	OFF (0sec)	OFF (0sec)
Phase offset	OFF (0° )	OFF (0° )
Measurement end extension correction	OFF	OFF
R input	0sec	0sec
A input	0sec	0sec
B input	0sec	0sec
Port 1	0sec	0sec
Port 2	0sec	0sec
Transfer constant	1	1

## 5. Setting Backup Memory (Factory Default Settings)

Table 4-4 Setting Backup Memory

Item	Initial value
GPIB address	11
System controller/Addressable	Addressable
Printer GPIB address	18
Plotter GPIB address	5
Save register	All clear

MEMO 





# CHAPTER 5

## MEASUREMENT SAMPLE

This chapter describes the operating method of the analyzer.

---

### CONTENTS

---

1. Measurement of Transmission Characteristic	
(2 Trace Display) .....	5-2
Overlap Display Mode .....	5-2
Split Display Mode .....	5-7
2. Measurement of Transmission and Reflection Characteristic ..	5-11
Set-up .....	5-11
Calibration (2 Port Full Calibration) .....	5-13
4 Screen Display .....	5-21
3. Measurement of Narrow Bandwidth/Wide Bandwidth .....	5-27
4. Multi-marker List Display .....	5-30
5. Measurement of Ripple in Bandwidth .....	5-33
6. Measurement of Electrical Length .....	5-38
7. High Speed Measurement by Program Sweeping Function ..	5-42
8. GO/NG Measurement by Limit Line Function .....	5-47

---

# 1. Measurement of Transmission Characteristic (2 Trace Display)

## ■ Overlap Display Mode (Two Trace per Screen Measurement)

Here explains magnitude and phase measurement method using simultaneous display of 2 traces.

● 880MHz band-pass filter is used as DUT.

1. Set up (refer to page 3-11) and preset (refer to page 4-4).
2. The setting of the analyzer is as follows.

Block name	Setting	Key operation
ACTIVE CHANNEL	Set the channel to 2.	[CH 2]
RESPONSE	Select the input port in the receiver part.	A type : [MEAS] [B/R] (Initial setup) B type : [MEAS] [TRANSMISSION] (Initial setup) C type or A type + S parameter [MEAS] [S21(B/R) TRANS FWD] (Initial setup)
	Set the measurement format to magnitude (log display) & phase.	[FORMAT] [LOG MAG & PHASE] (Initial setup)
STIMULUS	Center frequency 880MHz	[CENTER] [8] [8] [0] [MHz]
	Span frequency 100MHz	[SPAN] [1] [0] [0] [MHz]

3. Calibrate the frequency characteristic  
Remove DUT and connect the through adapter instead.  
Normalize in this state.  
[CAL] [NORMALIZE (THRU)]  
Following the completion, return the connection to DUT (filter).
4. Change the scale of displayed waveform  
When the format is 2 trace simultaneous display like this, select which waveform is to be changed by "SCALE FOR".

## 1. Measurement of Transmission Characteristic (2 Trace Display)

Change the scale for the first waveform (magnitude).

[SCALE] [AUTO SCALE]

The display on the screen is as follows.

The screen displays used here are all R3767C's.

The display contents of input port on upper left of the screen are different depending on the model.

The display of each type is as follows. (Active channel : CH2)

A type	A type + S parameter	B type	C type
B/R	S21	TRN	S21

TRN : TRANSMISSION

The display section of input port (Example S21 : C type)

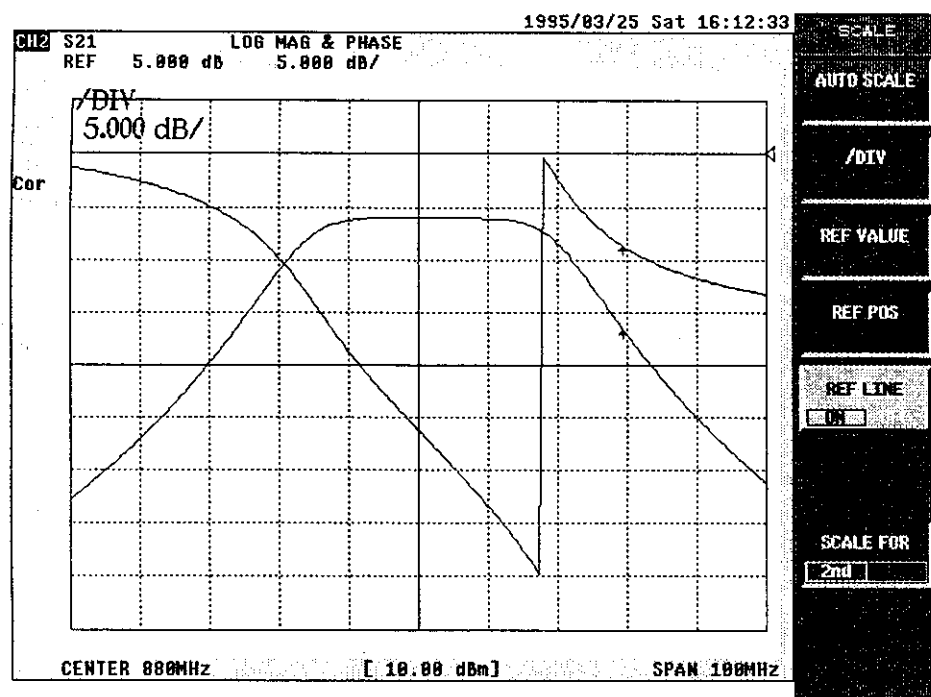

Figure 5-1 Auto-scale of the First Waveform of Magnitude/Phase Measurement (Overlap Display)

1. Measurement of Transmission Characteristic (2 Trace Display)

5. In order to change the object of scale change to the second waveform (phase), select 2nd by "SCALE FOR".

The reference line is also switched to the second waveform's.

Then the operation of marker also becomes effective to the second waveform.

**[SCALE FOR 2nd/1st] [AUTO SCALE]**

The display on the screen is as follows.

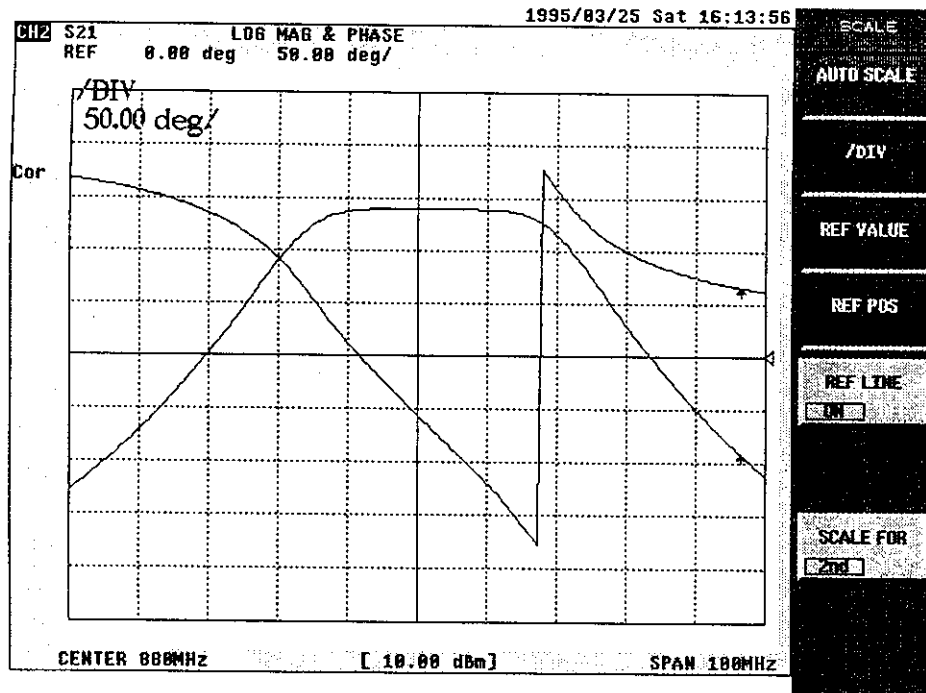

Figure 5-2 Auto-Scale of the Second Waveform of Magnitude/Phase Measurement (Overlap Display)

## 1. Measurement of Transmission Characteristic (2 Trace Display)

- By converting the format as follows, the measured results can be two-trace-overlap-displayed.

## 6. Magnitude/group delay time measurement

Set the format to magnitude (the first waveform)/group delay time (the second waveform) measurement.

[FORMAT] [More 1/2] [LOG MAG & DELAY]

The scale can be changed in the same way as step 4 & step 5.

[SCALE] [AUTO SCALE]

[SCALE FOR 2nd/1st] [AUTO SCALE]

The display on the screen is as follows.

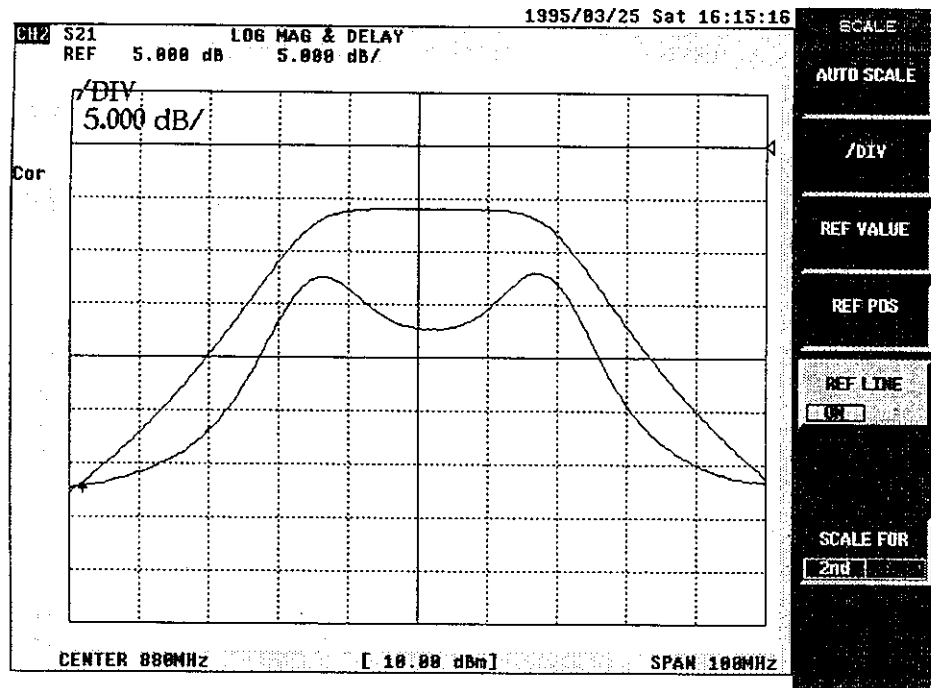

Figure 5-3 Magnitude/Group Delay time Measurement (Overlap Display)

1. Measurement of Transmission Characteristic (2 Trace Display)

7. Linear scale measurement of magnitude/phase

Set the format to linear magnitude (the first waveform)/phase (the second waveform) measurement.

[FORMAT] [LOG MAG & PHASE]

The scale can be changed in the same way as step 4 & step 5.

[SCALE] [AUTO SCALE]

[SCALE FOR 2nd/1st] [AUTO SCALE]

The display on the screen is as follows.

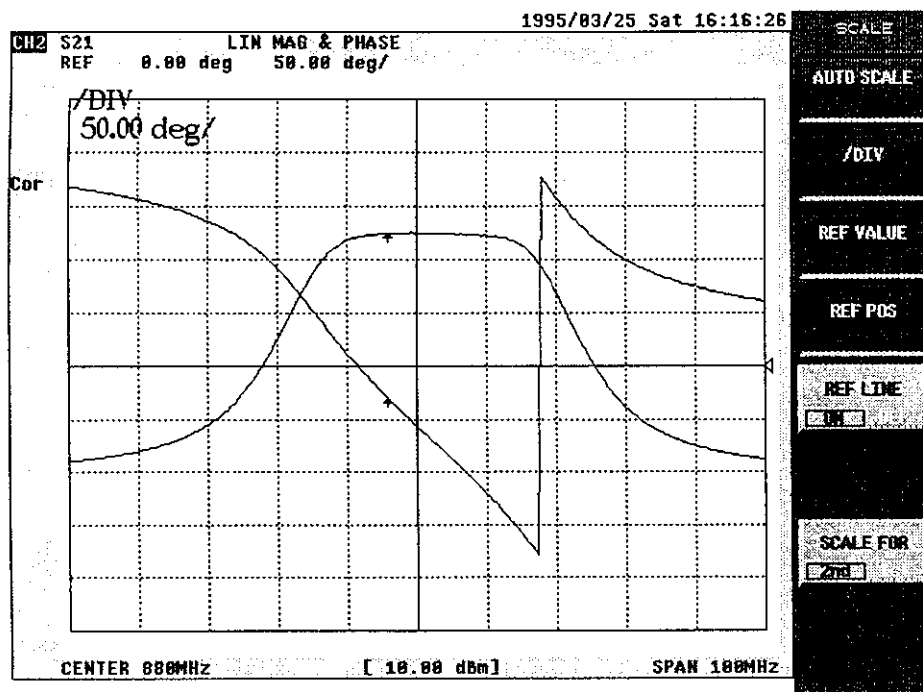

Figure 5-4 Linear Scale Measurement of Magnitude/Phase (Overlap Display)

## 1. Measurement of Transmission Characteristic (2 Trace Display)

## ■ Split Display

Here explains how to measure magnitude and phase with simultaneous display of channel 1 and 2.

●880MHz band-pass filter is used as DUT.

1. Set up (refer to page 3-11) and preset (refer to page 4-4).
2. The setting of the analyzer is as follows.

Block name	Setting	Key operation
ACTIVE CHANNEL	Set the channel to 2.	[CH 2]
RESPONSE	Select the input port in the receiver part.	A type : [MEAS] [B/R] (Initial setup) B type : [MEAS] [TRANSMISSION] (Initial setup) C type or A type + S parameter [MEAS] [S21(B/R) TRANS FWD] (Initial setup)
	Set the measurement format to magnitude (log display).	[FORMAT] [LOG MAG] (Initial setup)
STIMULUS	Center frequency 880MHz Span frequency 100MHz	[CENTER] [8] [8] [0] [MHz] [SPAN] [1] [0] [0] [MHz]

3. Change the input port of channel 1.

Block name	Setting	Key operation
ACTIVE CHANNEL	Set the channel to 1.	[CH 1]
RESPONSE	Select the input port in the receiver part.	A type : Bridge is used. [MEAS] [B/R] B type : [MEAS] [TRANSMISSION] C type or A type + S parameter [MEAS] [S21(B/R) TRANS FWD]

1. Measurement of Transmission Characteristic (2 Trace Display)

3. Calibrate the frequency characteristic.
  - First, remove DUT and connect the through adapter instead.
  - Normalize in this state.
  - [CH 2] [CAL] [NORMALIZE (THRU)]
  - Following the completion, return the connection to DUT (filter).
4. Display two screens simultaneously.
  - [DISPLAY] [DUAL CH ON/OFF] [SPLIT CH ON/OFF]
5. In two screens display, the operation of format or scale, etc. is performed to the active channel independently. The display of active channel becomes inverted one and the frame of the screen display changes to white.

Set channel 2 to the phase display.

[FORMAT] [PHASE]

This corresponds to the magnitude/phase measurement (overlap display) of page 5-3 and 5-4.

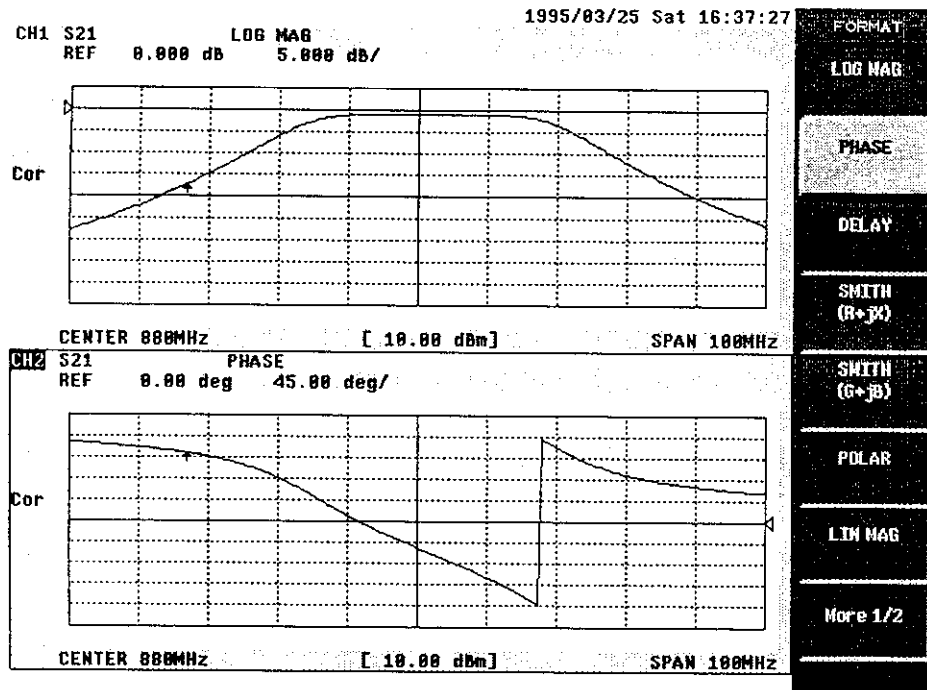

Figure 5-5 Magnitude/Phase Measurement (Split Display)



1. Measurement of Transmission Characteristic (2 Trace Display)

6. Set channel 2 to the group delay time display.  
 [DELAY] [SCALE] [AUTO SCALE]

The display on the screen is as follows.

This corresponds to the magnitude/group delay time measurement (overlap display) of page 5-5.

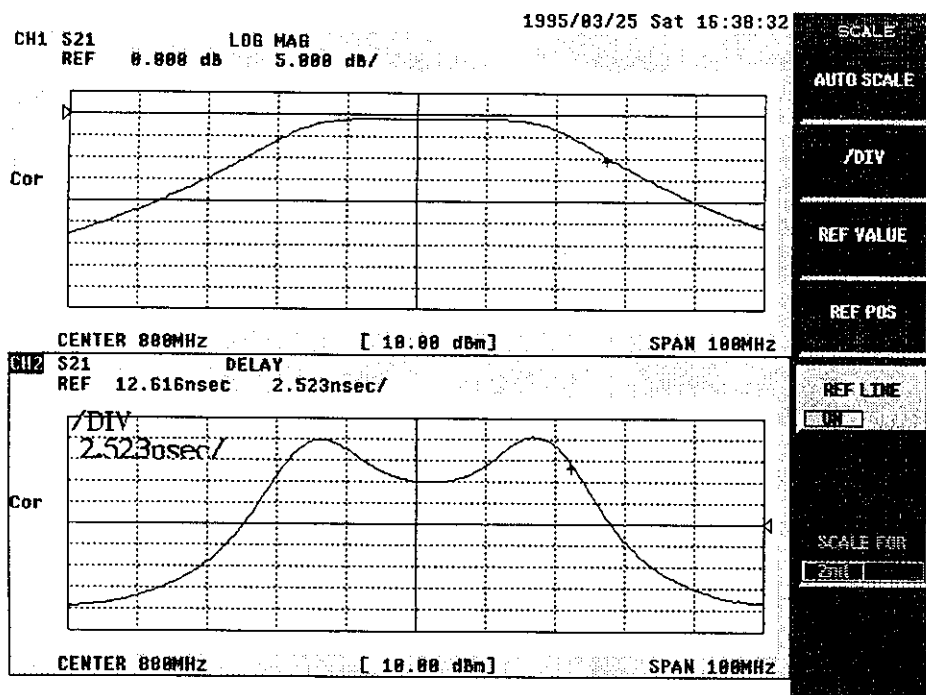

Figure 5-6 Magnitude/Group Delay Time Measurement (Split Display)

1. Measurement of Transmission Characteristic (2 Trace Display)

7. Set channel 2 to the phase and channel 1 to the linear magnitude.

[FORMAT] [PHASE]

[CH 1] [LIN MAG] [SCALE] [AUTO SCALE]

The display on the screen is as follows.

This corresponds to the linear magnitude/phase measurement (overlap display) of page 5-6.

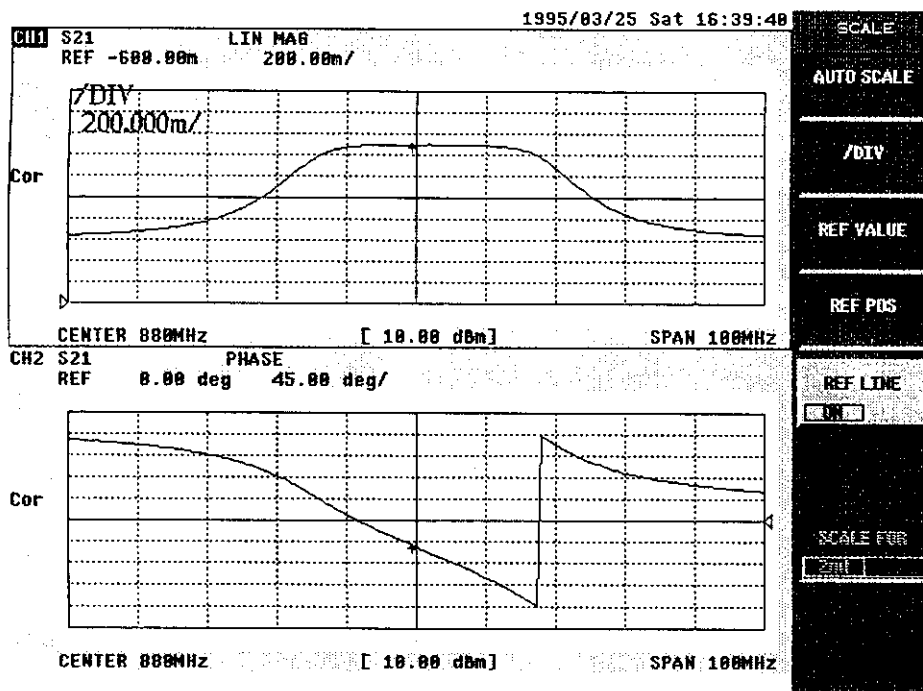

Figure 5-7 Linear Magnitude/Phase Measurement (Split Display)

## 2. Measurement of the Transmission and the Reflection Characteristic (Four Screen Display Mode)

### ■Set-up

Here explains how to measure all S parameters with four screen display.

S parameter measurement is possible only when A type + S parameter test set or C type is used.

Four screen display is possible for either A type or B type.

●880MHz band-pass filter is used as DUT.

#### 1. Set up.

●In the case of A type + R3961 ( ~3.6GHz)

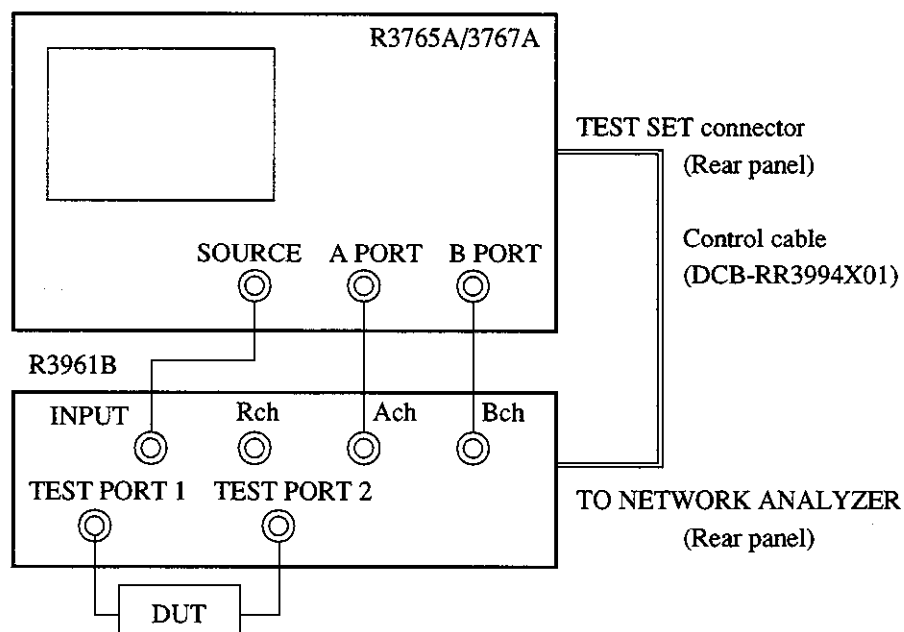

Figure 5-8 Setup of A Type S Parameter Measurement

2. Measurement of Transmission and Reflection Characteristic

● C type

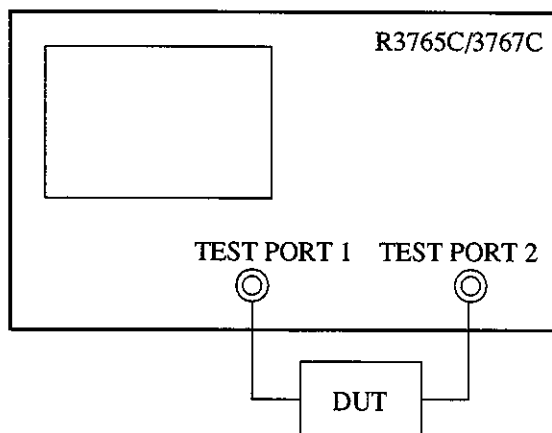

Figure 5-9 Setup of the Reflection Characteristic Measurement

The display on the screen used hereafter are all R3767C's.

2. Set up the analyzer as follows.

First, preset by pressing [PRESET].

Block name	Setting	Key operation
ACTIVE CHANNEL	Set the channel to 1.	[CH 1] (Initial setup)
RESPONSE	Select the input port in the receiver part.	C type or A type + S parameter [MEAS] [S11(A/R) REFL FWD] (Initial setup)
	Set the measurement format to magnitude (log display).	[FORMAT] [LOG MAG] (Initial setup)
STIMULUS	Center frequency 880MHz	[CENTER] [8] [8] [0] [MHz]
	Span frequency 100MHz	[SPAN] [1] [0] [0] [MHz]

## ■ Calibration (two port full calibration)

Here explains about the calibration of the directivity of two-port-device forward direction and inverse direction, the source match, the load match, the frequency tracking and the isolation. By this calibration, all S parameters of 2-port-device can be measured at the highest accuracy. This calibration is possible only in the case of A type + S parameter test set or C type.

### A D V I C E

If the calibration has already been executed, switch OFF the calibration, clear the calibration data, and then start the calibration. When the message "Wait for Sweep" disappeared, each calibration completes. During it's displayed, the analyzer, the cable, the connector, etc. must not be moved.

1. Invoke 2-port full calibration menu.  
[CAL] [CAL MENUS] [2PORT FULL CAL]
2. Invoke the reflection menu of 2-port reflection calibration.  
[REFLECT'N]
3. Connect the open-standard to the test port 1 and acquire calibration data.

Pressing [S11: OPEN], the display on the screen becomes as follows.

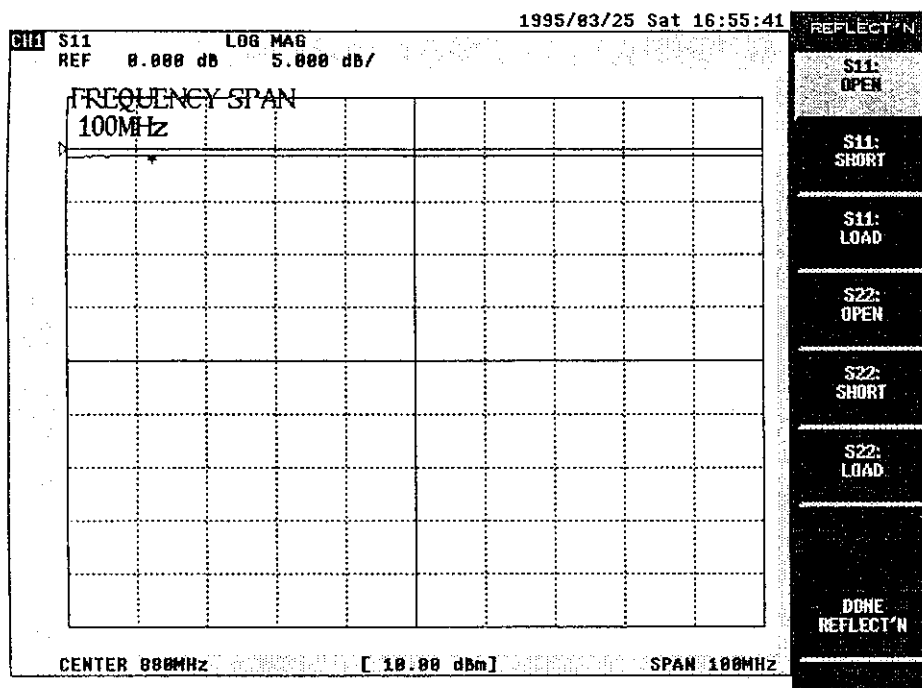

Figure 5-10 Calibration of 2-Port Reflection (Test Port/Open)

2. Measurement of Transmission and Reflection Characteristic

4. Connect the short-standard to the test port 1 and acquire calibration data.

[S11: SHORT]

The display on the screen is as follows.

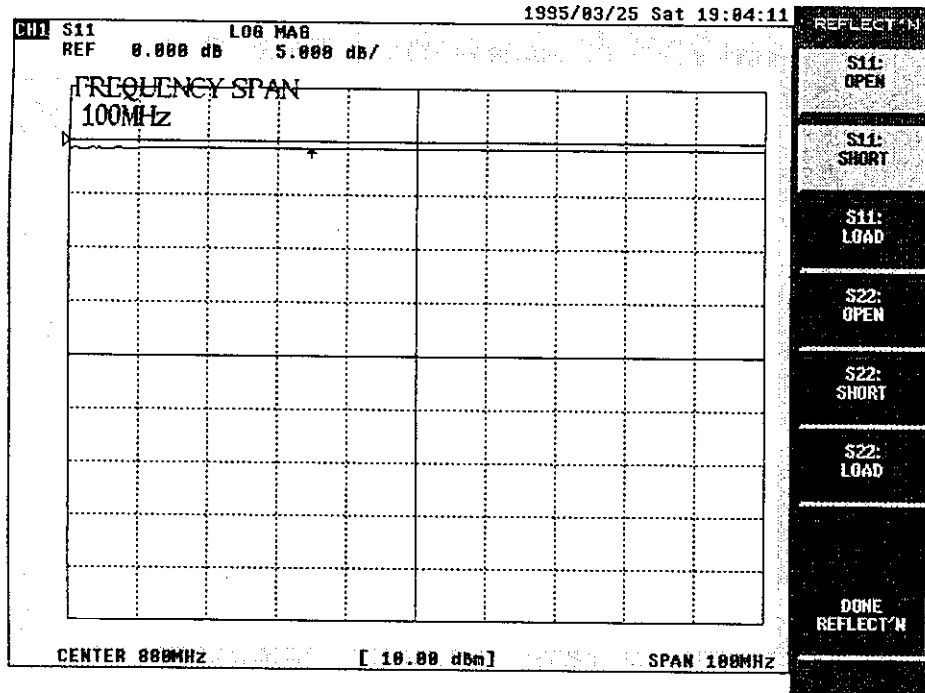

Figure 5-11 Calibration of 2-Port Reflection (Test Port/Short)

2. Measurement of Transmission and Reflection Characteristic

5. Connect the load-standard to the test port 1 and acquire calibration data.

[S11: LOAD]

The display on the screen is as follows.

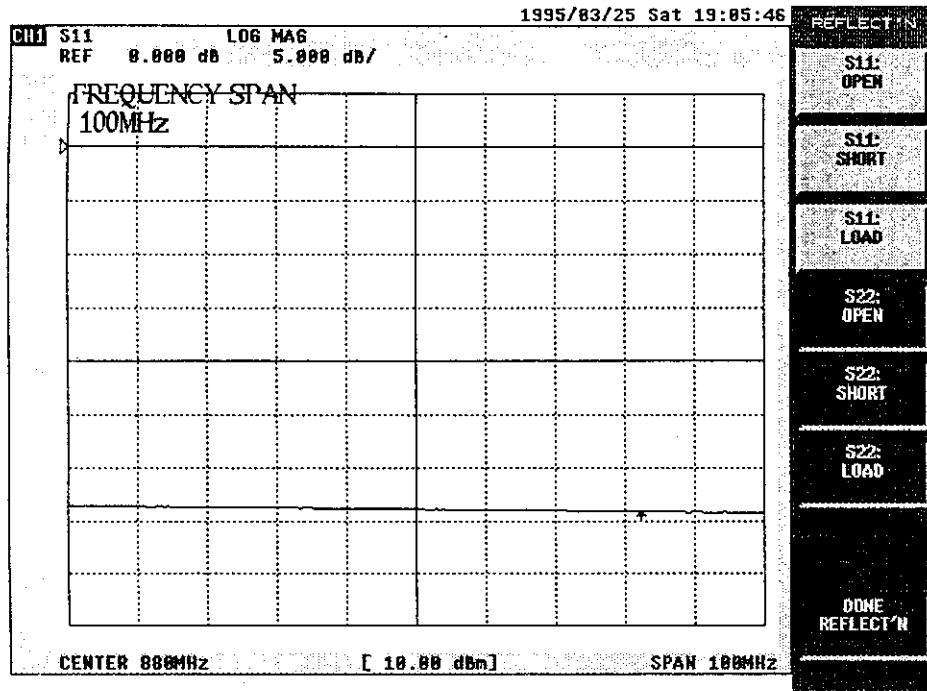

Figure 5-12 Calibration of 2-Port Reflection (Test Port/Load)

2. Measurement of Transmission and Reflection Characteristic

6. Calibrate the test port 2 in the same way as the test port 1.  
Connect the open-standard to the test port 2 and acquire calibration data.  
    [S22: OPEN]
7. Connect the short-standard to the test port 2 and acquire calibration data.  
    [S22: SHORT]
8. Connect the load-standard to the test port 2 and acquire calibration data.  
    [S22: LOAD]
9. Execute calibration of the reflection characteristic.  
"Calibration data of each calibration standard can be acquired again before this key is pressed."

[DONE REFLECT'N]

Following the completion of the reflection characteristic calibration, returns to 2 port full calibration menu.

The display on the screen is as follows.

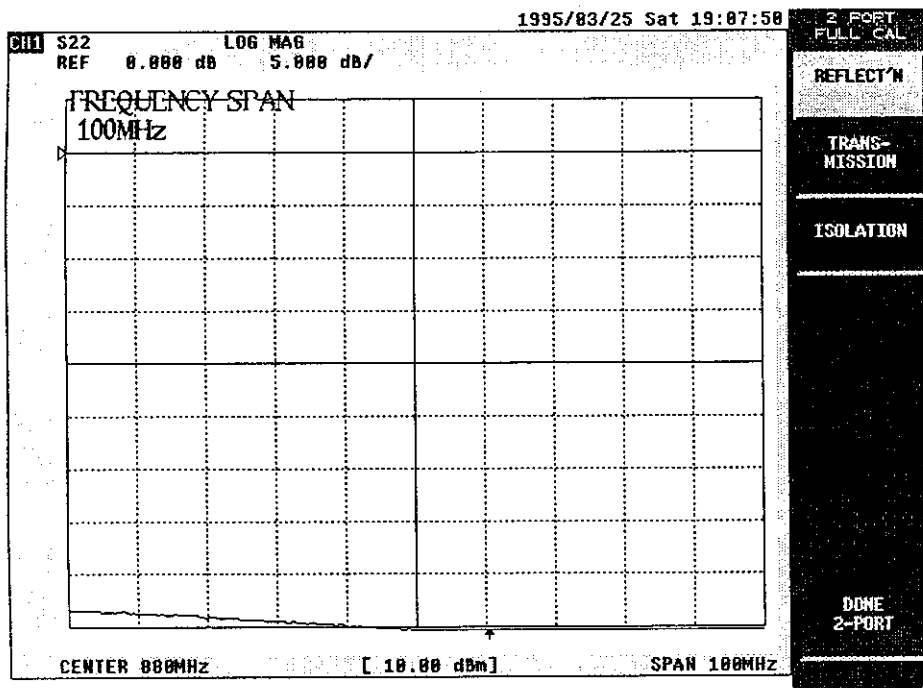

Figure 5-13 Execution of 2 Port Reflection Characteristic Calibration



## 2. Measurement of Transmission and Reflection Characteristic

10. Invoke transmission menu of 2 port transmission characteristic calibration.

[TRANSMISSION]

11. Connect the through-standard between test port 1 and test port 2.

[FWS.TRANS THRU]

The display on the screen is as follows.

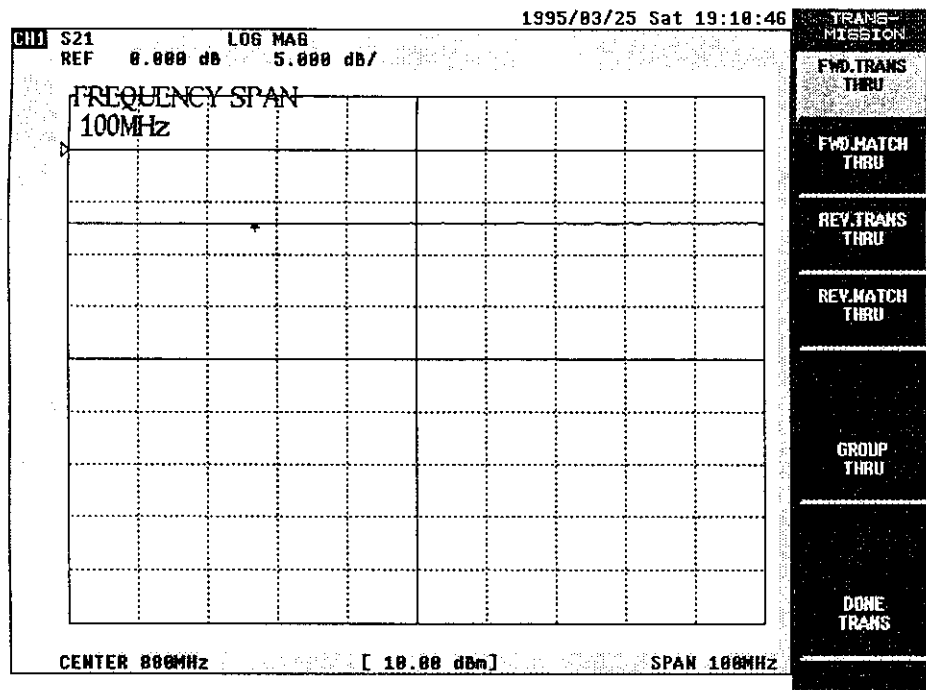

Figure 5-14 Calibration of 2-Port Transmission Characteristic (Forward Direction)

2. Measurement of Transmission and Reflection Characteristic

12. Acquire the following each calibration data.

[FWD.MATCH THRU] \*

[REV. TRANS THRU] \*

[REV. MATCH THRU] \*

\* : [GROUP THRU] can be substituted.

13. Execute calibration of the transmission calibration.

"Calibration data of each calibration standard can be acquired again before this key is pressed."

[DONE TRANS]

Following the completion of transmission characteristic calibration, returns to 2 port full calibration menu.

The display on the screen is as follows.

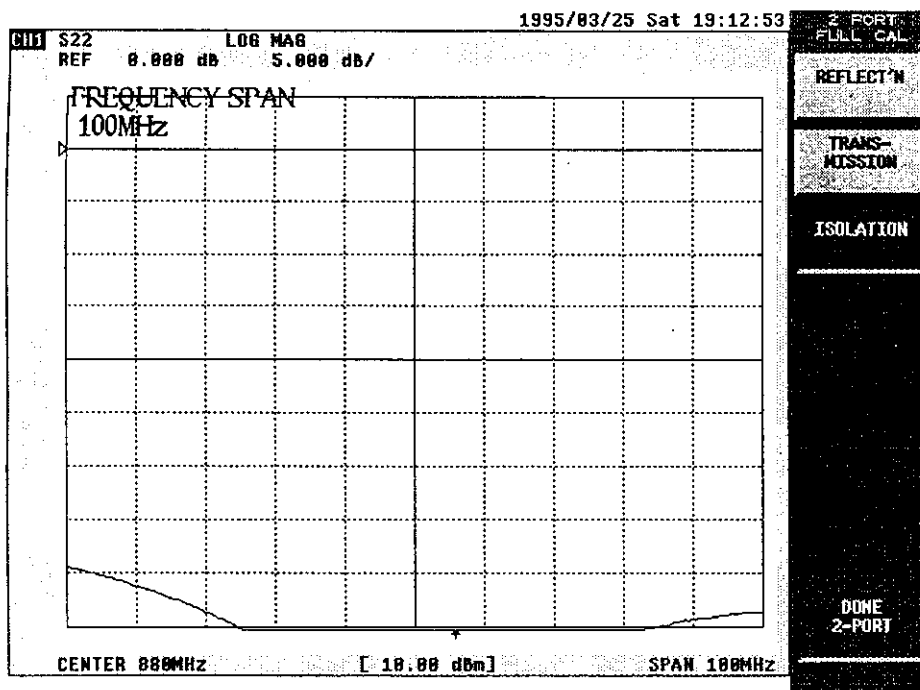

Figure 5-15 Execution of 2-Port Transmission Characteristic Calibration

## 2. Measurement of Transmission and Reflection Characteristic

14. Invoke 2-port isolation menu.  
[ISOLATION]
15. When the isolation calibration is omitted,  
[OMIT ISOLATION]  
When the isolation calibration is performed,  
Connect the load-standard to the test port 1 and the test port 2 to acquire calibration data.  
[FWD ISOLL]  
[REV ISOLL]
16. Executes the isolation calibration  
[DONE ISOLATION]

Following the completion of the isolation calibration, returns to 2 port full calibration menu.

The display on the screen is as follows.

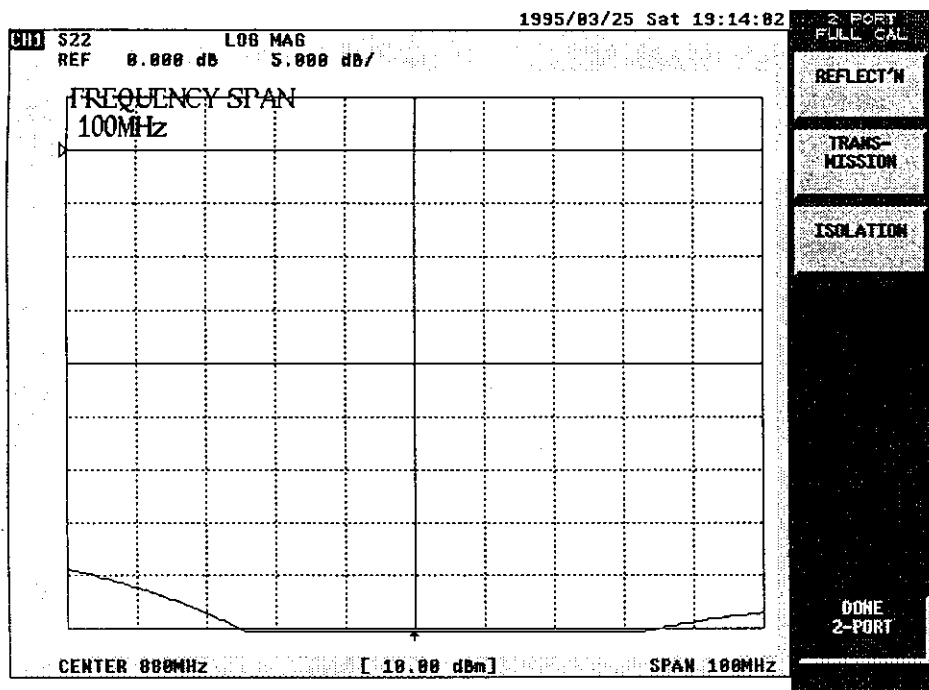

Figure 5-16 Execution of the Isolation Calibration

2. Measurement of Transmission and Reflection Characteristic

17. Executes 2-port full calibration  
【DONE 2-PORT】

The display on the screen is as follows.

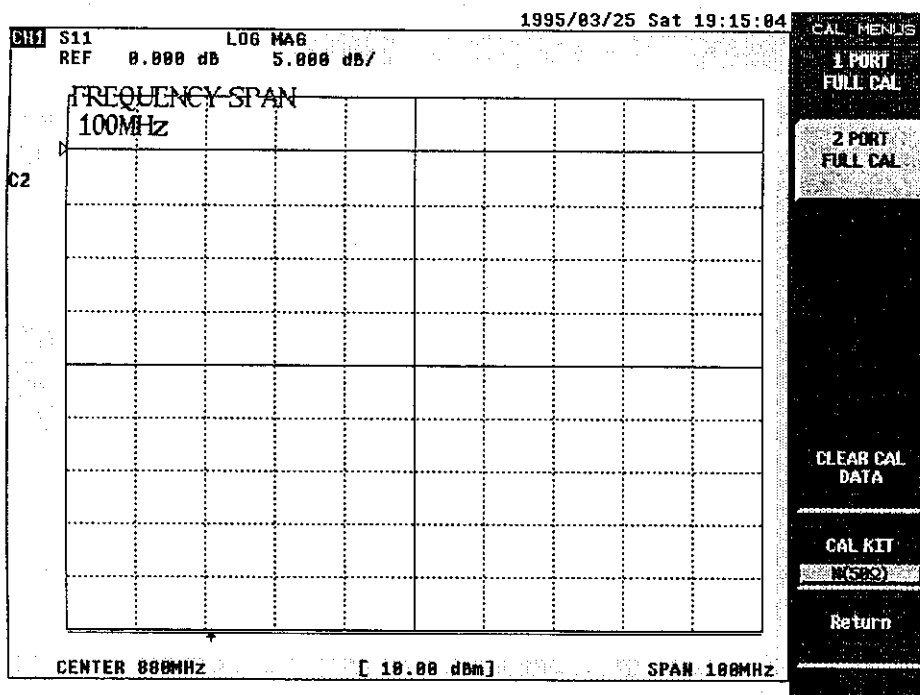

Figure 5-17 Execution of 2-Port Full Calibration

18. Connect DUT again and perform the measurement.

### ■ Four Screen Display

Here explains how to operate 4 screen display of all S parameters.

The following is a sample of 4 screen display.

[CH1] : S11 Smith chart [SMITH (R+jX)]	[CH2] : S12 Magnitude/Phase [LOG MAG & PHASE]
[CH3] : S22 Smith chart [SMITH (R+jX)]	[CH4] : S21 Magnitude/Group delay time [LOG MAG & DELAY]

The position of channel 1 to 4 is fixed, but the measurement mode, the format and the scale, etc. can be set to active channel automatically.

1. Set S11 Smith chart to channel 1.  
[FORMAT] [SMITH (R+jX)]

The display on the screen is as follows.

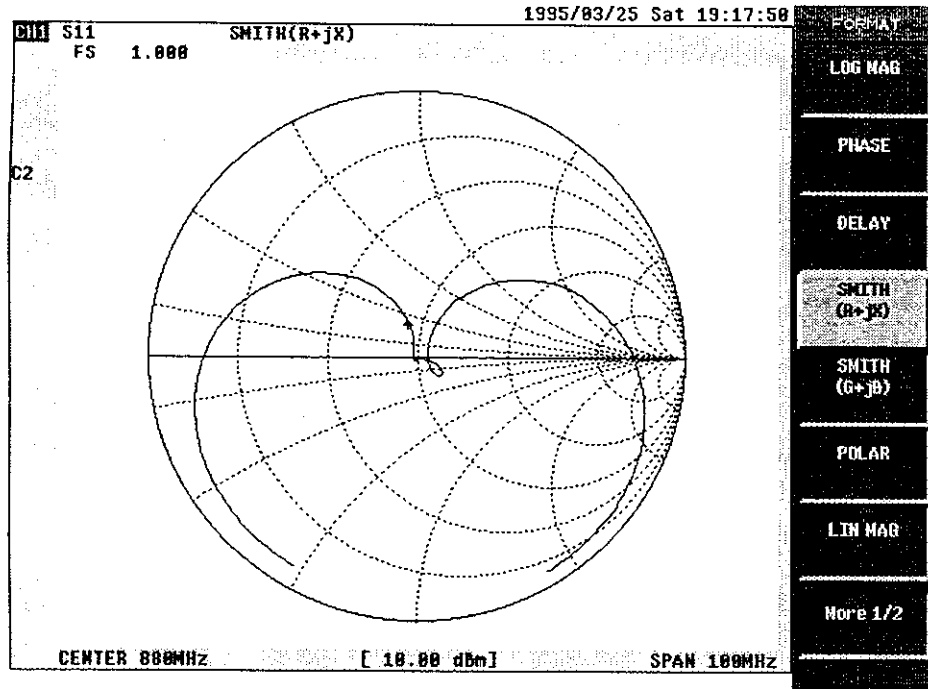

Figure 5-18 4 Screen Display (Channel 1)

2. Measurement of Transmission and Reflection Characteristic

2. Select S22 for channel 3.

[MEAS] [SUB MEAS ON/OFF] [S22 (B/R) REFL REV]  
 \_\_\_\_\_ Switch ON.

The active channel is switched to 3 and the format is set with Smith chart.

[FORMAT] [SMITH (R+jX)]

Each time [CH1] is pressed, the active channel is switched between channel 1 and channel 3.

The display on the screen is as follows.

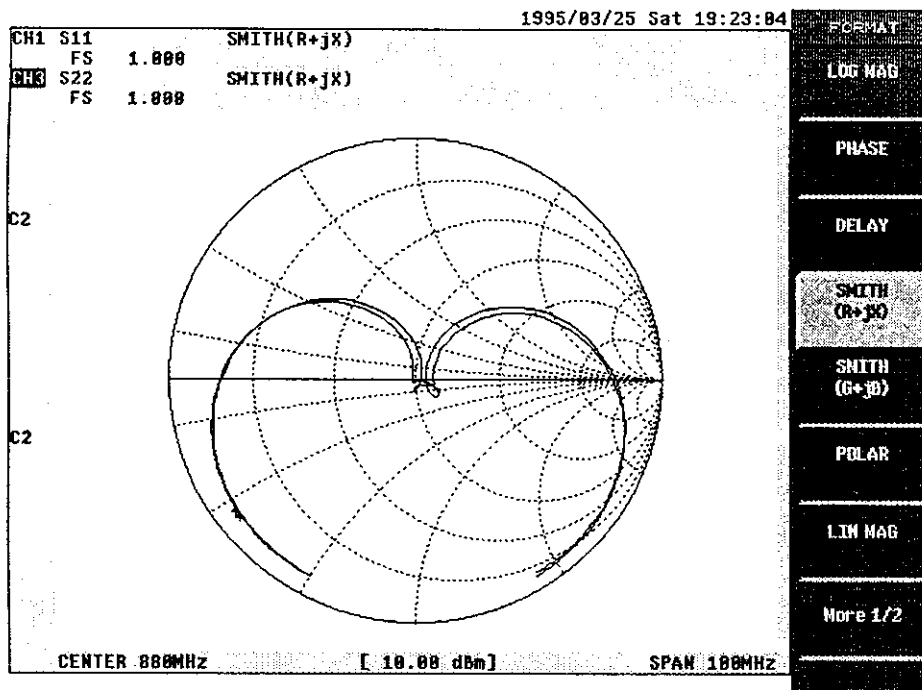

Figure 5-19 4 Screen Display (Overlap Display of Channel 1 and 3)

2. Measurement of Transmission and Reflection Characteristic

3. Split-displays channel 1 and 3.  
 [DISPLAY] [SPLIT CH ON/OFF]

Each time [CH1] is pressed, the active channel is switched between channel 1 and 3.

The display on the screen is as follows.

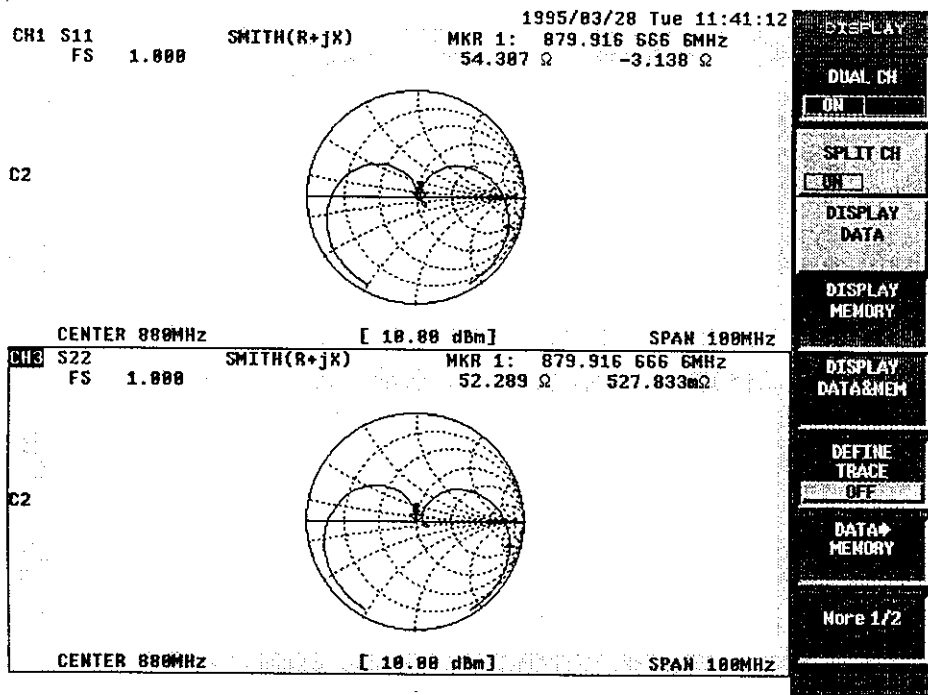

Figure 5-20 4 Screen Display (Split Display of Channel 1 and 3)

2. Measurement of Transmission and Reflection Characteristic

4. Select S12 for channel 2.

[CH 2] [MEAS] [S12 (A/R) TRANS REV]

Change the format to magnitude (log) and phase.

[FORMAT] [LOGMAG & PHASE]

Change the scale.

[SCALE] [AUTO SCALE] [SCALE FOR 2nd/1st] [AUTO SCALE]

The display on the screen is as follows.

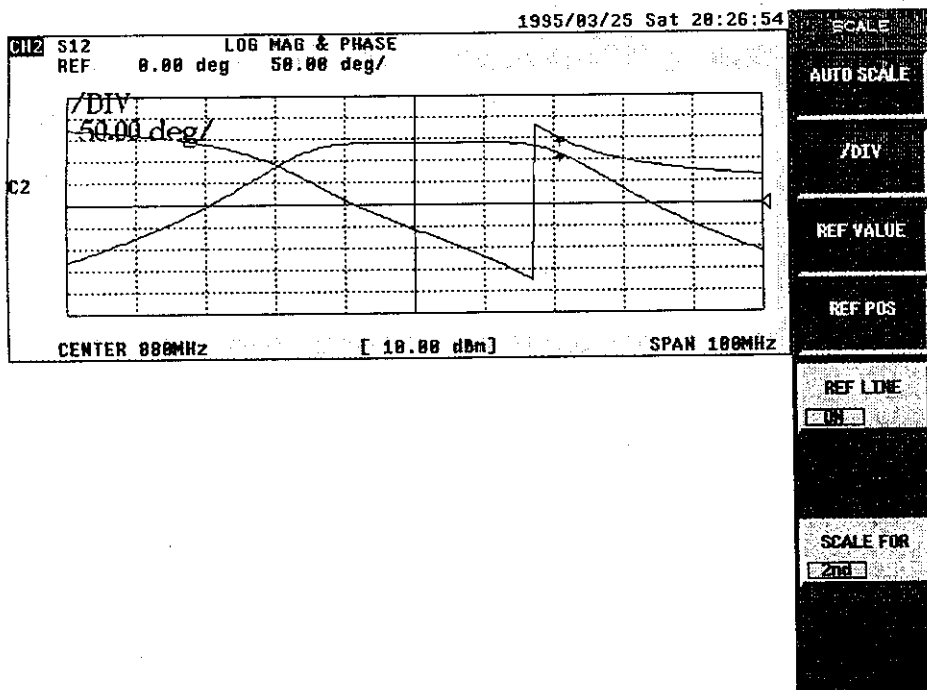

Figure 5-21 4 Screen Display (Channel 2)



## 2. Measurement of Transmission and Reflection Characteristic

5. Select S21 for channel 4.

[MEAS] [SUB MEAS ON/OFF] [S21 (B/R) TRANS FWD]  
 Switch ON.

Active channel is switched to 4 and the format is set with amplitude & group delay time.

[FORMAT] [More 1/2] [LOG MAG & DELAY]

Each time [CH2] is pressed, the active channel is switched between channel 2 and channel 4.

Change the scale.

[SCALE] [AUTO SCALE] [SCALE FOR 2nd/1st] [AUTO SCALE]

The display on the screen is as follows.

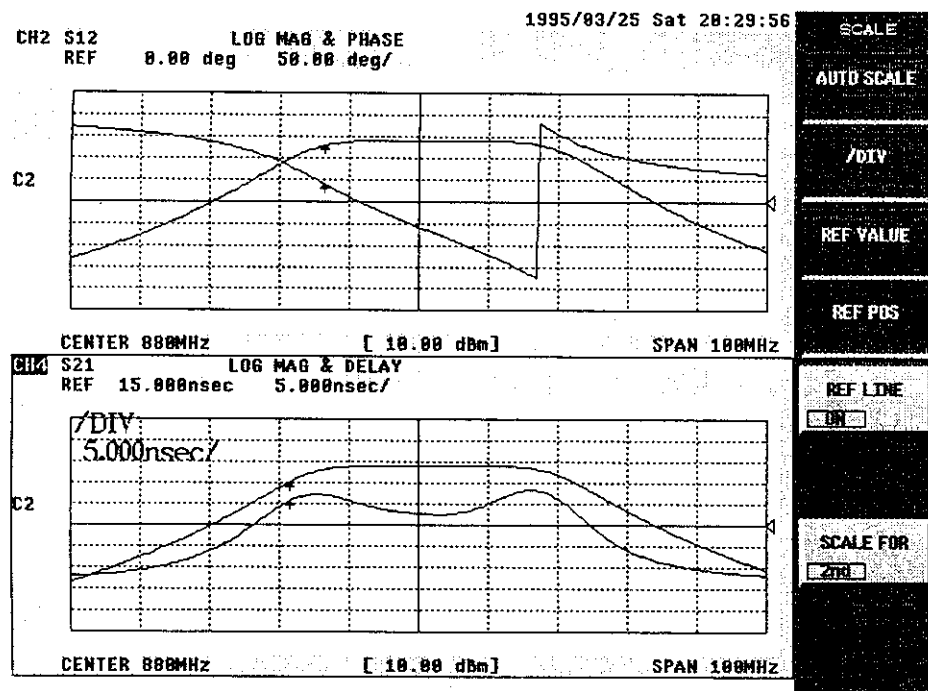

Figure 5-22 4 Screen Display (Split Display of Channel 2 and 4)

2. Measurement of Transmission and Reflection Characteristic

6. Dual-display channel 1 (channel 3) and channel 2 (channel 4).  
 [DISPLAY] [DUAL CH ON/OFF]

Then the active channel becomes channel 4.

Each time [CH2] is pressed, the channel is switched to 2.

When channel 1 or channel 3 is required to change to active channel, press [CH1].

The display on the screen is as follows.

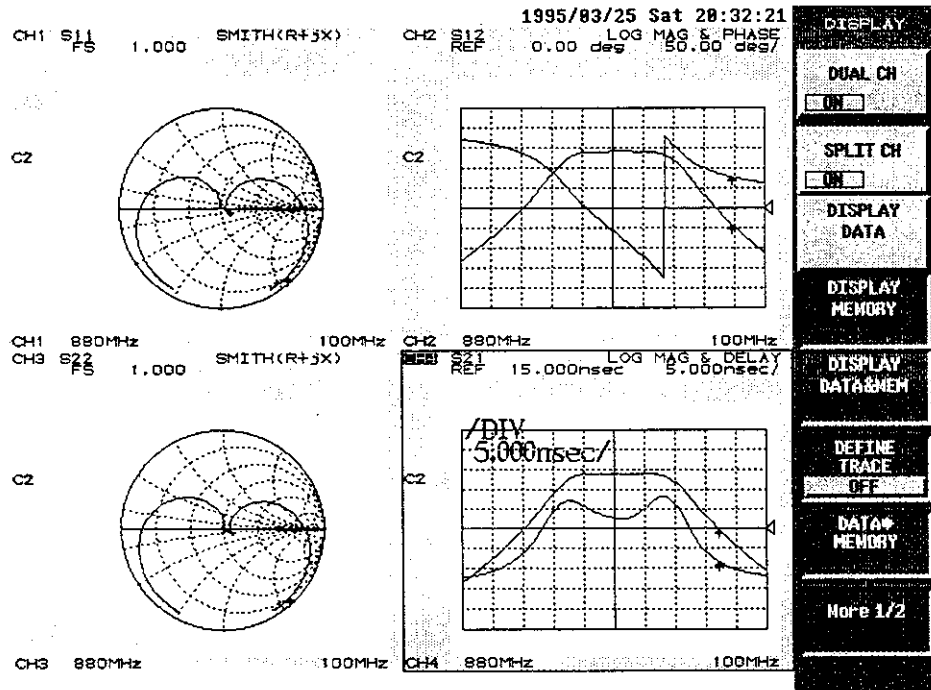

Figure 5-23 The Finished 4 Screen Display

### 3. Measurement of Narrow Bandwidth/Wide Bandwidth

Here explains how to set different measurement conditions between channel 1 and 2.

●880MHz band-pass filter is used as DUT.

1. Set up (filter connection) and preset.  
Refer to page 3-11 and 4-4.
2. Set the measurement conditions of channel 1 and channel 2 independently.  
[MEAS] [COUPLED CH ON/OFF]
3. Set the measurement mode, the bandwidth, and the format of channel 1.  
[MEAS]  
A type : [B/R]  
B type : [TRANSMISSION]  
C type : [S21 (B/R) TRANS FWD]  
[CENTER] [8] [8] [0] [MHz]  
[SPAN] [1] [0] [0] [MHz]  
[FORMAT] [LOG MAG]
4. Set the format and the bandwidth of channel 2.  
[CH 2]  
[CENTER] [8] [8] [0] [MHz]  
[SPAN] [6] [0] [0] [MHz]  
[FORMAT] [LOG MAG]

3. Measurement of Narrow Bandwidth/Wide Bandwidth

5. Calibrate the frequency characteristic of channel 1.  
 Remove DUT and connect the through adapter instead.  
 Normalize in this state.  
 [CH 1] [CAL] [NORMALIZE (THRU)]
6. Calibrate the frequency characteristic of channel 2 in the same way.  
 [CH 2] [NORMALIZE (THRU)]

Following the completion, return the connection to DUT (filter).

7. Display two channels simultaneously.  
 [DISPLAY] [DUAL CH ON/OFF]

The measurement screen is as follows.

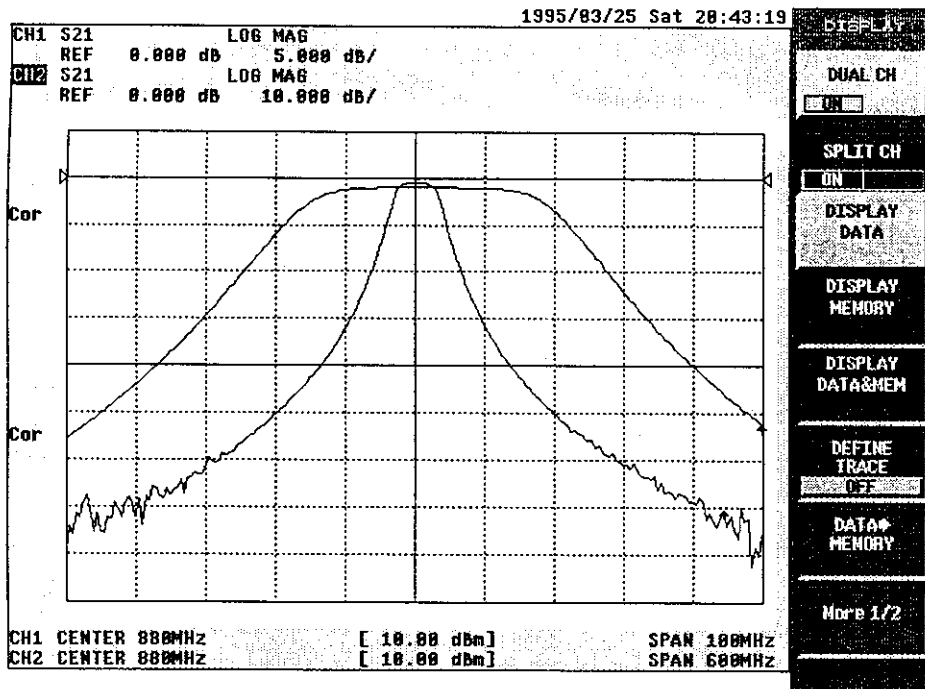

Figure 5-24 Two Channels Simultaneous Display (Overlap Display)

3. Measurement of Narrow Bandwidth/Wide Bandwidth

- 8. Display split into two parts, upper and lower. (Split display)  
 [SPLIT CH ON/OFF]

The measurement screen is as follows.

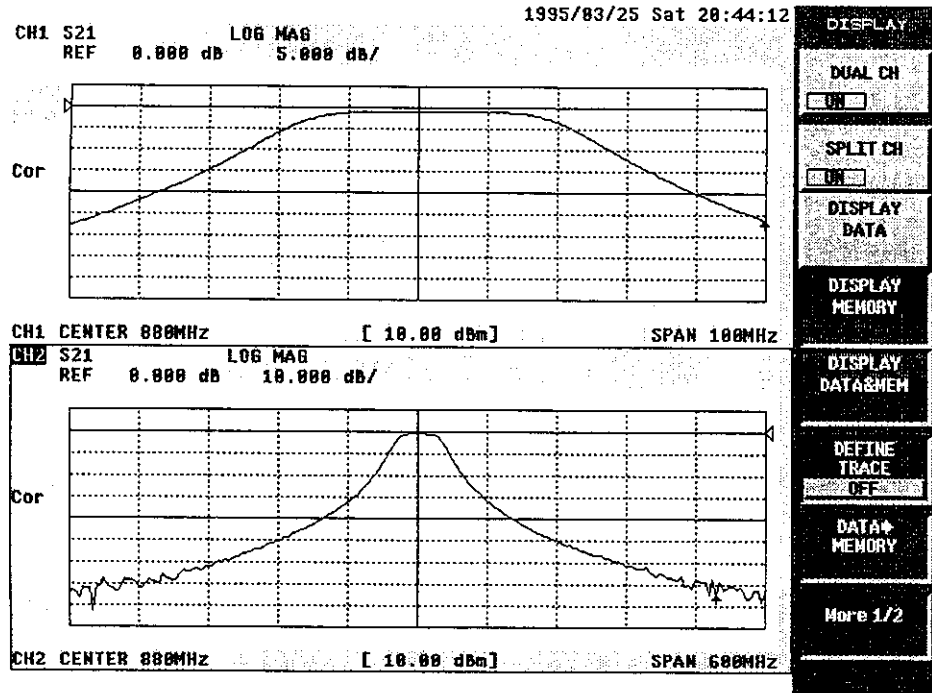

Figure 5-25 Two Channels Simultaneous Display (Split Display)

## 4. Multi-marker List Display

Here explains how to operate multi-marker.

●880MHz band-pass filter is used as DUT.

1. Set up (filter connection) and preset. (Refer to page 3-11 and 4-4.)  
Press [CH 2] to set the active channel to 2.
2. Set the center frequency and the span.  
[CENTER] [8] [8] [0] [MHz]  
[SPAN] [6] [0] [0] [MHz]
3. Calibrate the frequency characteristic.  
Remove DUT and connect the through adapter instead.  
Normalize in this state.  
Following [CAL] [NORMALIZE (THRU)] , return the connection to DUT (filter).
4. Display multi-marker.  
Maximum 10 markers are displayed in one channel.  
A marker is displayed in each calibration marking of the horizontal axis.  
[MRK]  
[ACTIVE MARKER [ ]] [MARKER 2] [↑]  
[MARKER 3] [↑] [↑]  
[MARKER 4] [↑] [↑] [↑]  
[MARKER 5] [↑] [↑] [↑] [↑]  
[More 1/2] [MARKER 6] [↓]  
[MARKER 7] [↓] [↓]  
[MARKER 8] [↓] [↓] [↓]  
[MARKER 9] [↓] [↓] [↓] [↓]  
[MARKER 10] [↓] [↓] [↓] [↓] [↓]

By the operation in the previous page, the markers are displayed as follows.

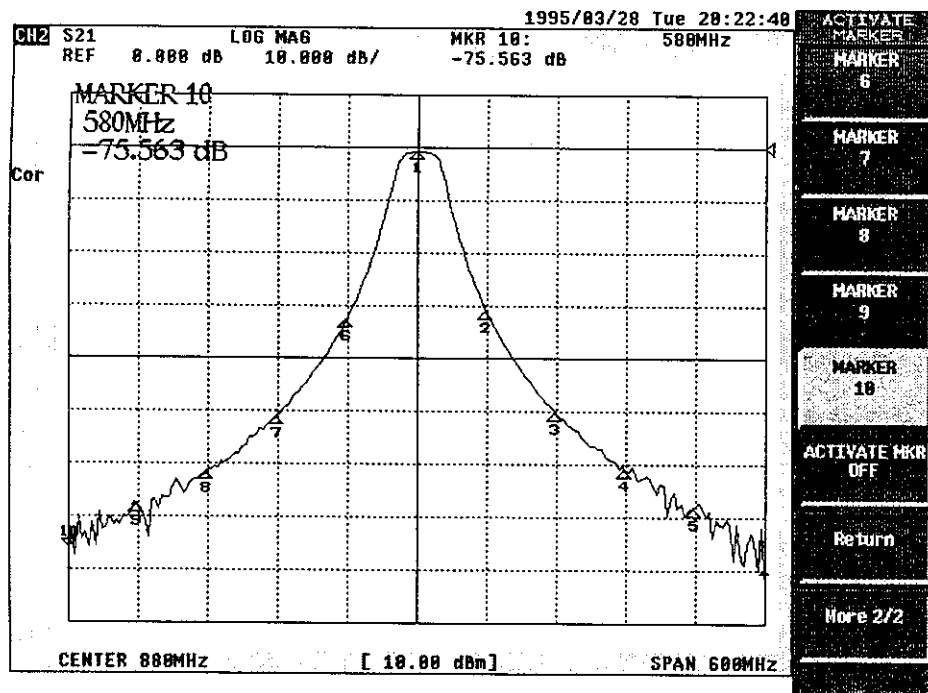

Figure 5-26 Multi-marker Display

4. Multi-marker List Display

5. Display marker list.

All the marker data are displayed.

**[Return] [MKR LIST ON/OFF]**

By the operation above, the marker and the list are displayed as follows.

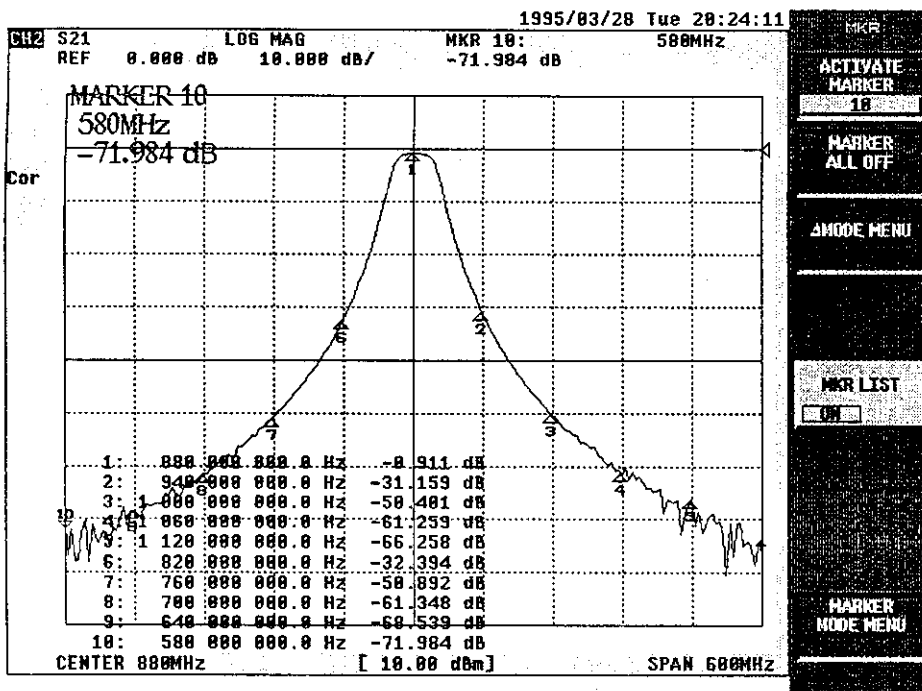

Figure 5-27 Display of Multi-marker List



## 5. Ripple Measurement in the Bandwidth

Here explains how to measure the ripple in the bandwidth.

●43MHz band-pass filter is used as DUT.

1. Set up (filter connection) and preset. (Refer to page 3-11.)  
Press [CH 2] to set the active channel to 2.
2. Set the center frequency and the span.  
[CENTER] [4] [3] [MHz]  
[SPAN] [1] [0] [MHz]
3. Calibrate the frequency characteristic.  
Remove DUT and connect the through adapter instead.  
Normalize in this state.  
[CAL] [NORMALIZE (THRU)]  
  
Following the completion, return the connection to DUT (filter).
4. Set the measurement format to magnitude (log display) and calibrate the scale.  
[SCALE] [AUTO SCALE]
5. Specify a part (delta section).  
Specify a delta section.  
Move marker 1 with the data knob to one end of the specified section.  
[MKR]

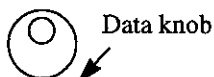

5. Measurement of Ripple in Bandwidth

Set the reference marker to the position of marker 1.

**[Δ MODE MENU] [Δ REF=Δ MKR]**

Move marker 1 with the data knob to the other end of the specified section.

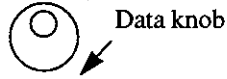

The area between the reference marker and marker 1 is the delta section.

Specify the delta section as the range of partial search.

**[MKR→] [PART SRCH [ ]] [SET RANGE]**

Make the partial search effective.

**[PART SRCH ON/OFF]**

The display on the screen is as follows.

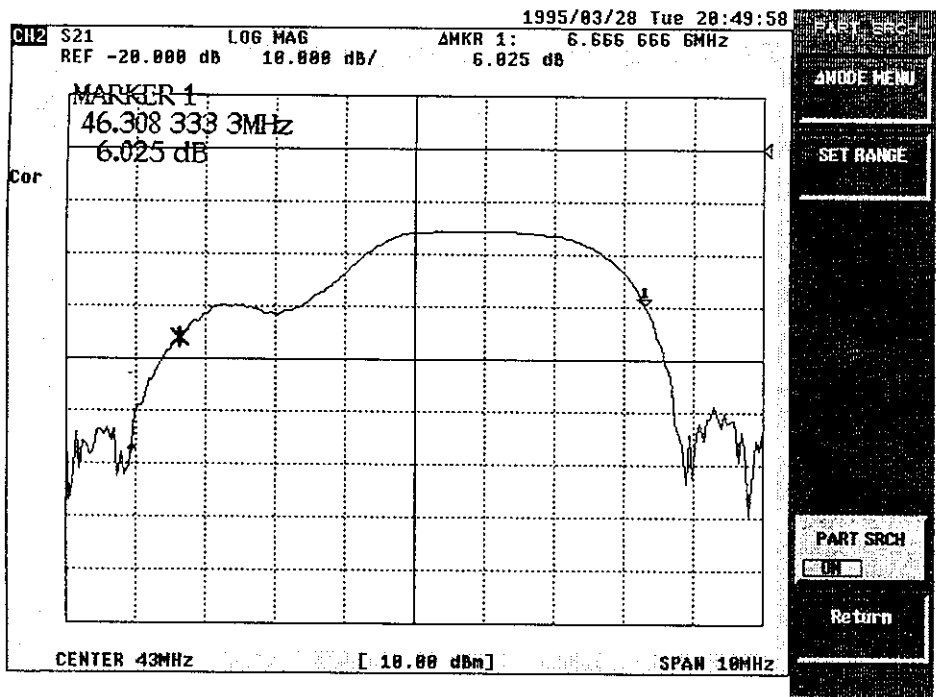

Figure 5-28 Specification of Delta Section (Partial Search)

6. Search the maximum value in the delta section.

[Return] [MKR SRCH [ ]] [MAX]

The display on the screen is as follows.

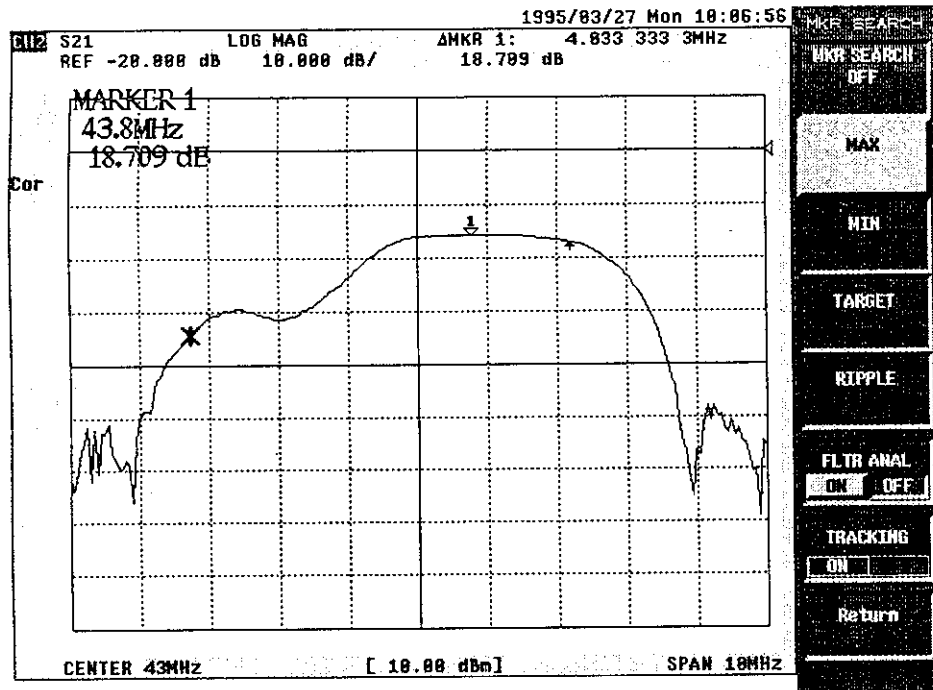

Figure 5-29 Measurement of Maximum Value in the Delta section

5. Measurement of Ripple in Bandwidth

7. Search the minimum value in the delta section.  
【MIN】

The display on the screen is as follows.

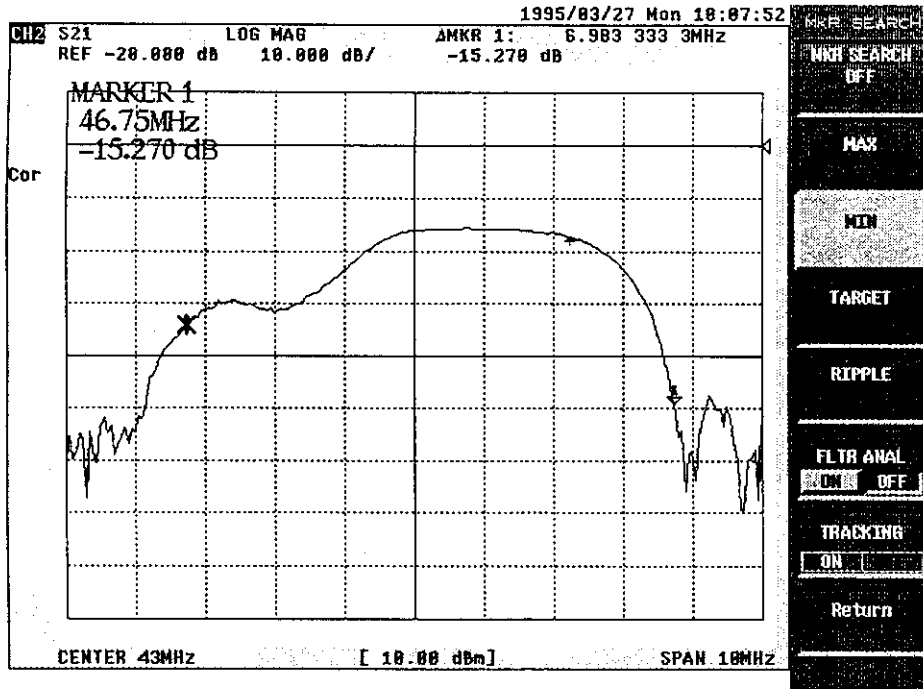

Figure 5-30 Measurement of Minimum Value in the Delta Section

8. Search ripple in the delta section.  
 [RIPPLE] [ΔMAX-MIN]

The reference marker moves to the most minimum point of the minimum points and the active marker moves to the most maximum point of the maximum points.

The display on the screen is as follows.

The difference of the both marker values is displayed in the active marker area.

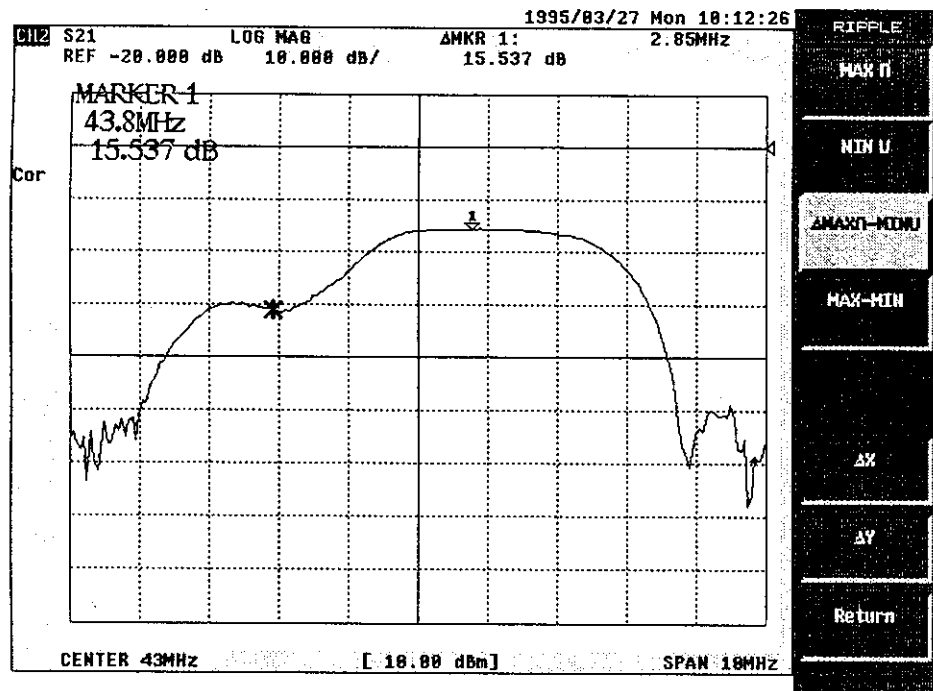

Figure 5-31 Measurement of Ripple in the Delta Section

## 6. Measurement of Electrical Length

Here explains about the measurement of electrical length using compensation function of electrical length.

●Cable is used as DUT.

1. Set up (cable connection) and preset. (Refer to page 3-11 and 4-4.)  
Press [CH 2] to set the active channel to 2.
2. Set the start-frequency and the stop-frequency.  
[START] [4] [0] [MHz]  
[STOP] [1] [GHz]
3. Calibrate the frequency characteristic.  
Remove DUT and connect the through adapter instead.  
Normalize in this state.  
[CAL] [NORMALIZE (THRU)]  
  
After the completion, return the connection to DUT (cable).
4. Change the measurement format.  
[FORMAT] [PHASE]

The display on the screen is shown in the next page, Figure 5-32.

Thus the phase characteristic shows that DUT has electrical length, by which the phase decreases linearly.

The electrical length of this DUT can be measured by compensating the electrical length.

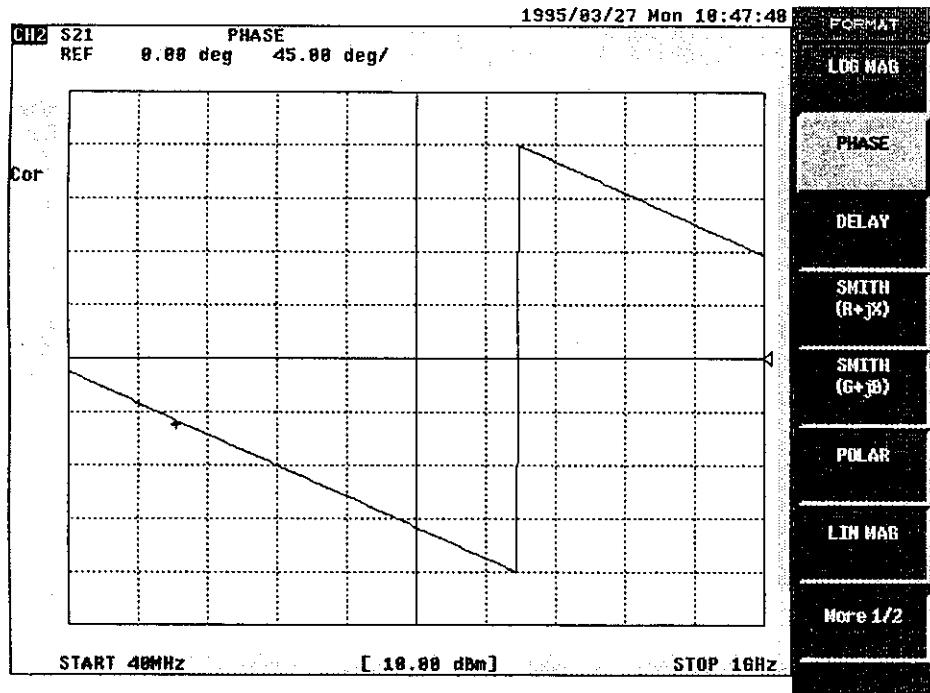

Figure 5-32 Electrical Length of Cable

6. Measurement of Electrical Length

5. Set to electrical length compensation mode.

[CAL] [More 1/2] [ELEC DELAY ON/OFF] [ELECTRICAL DELAY]

The display on the screen is as follows.

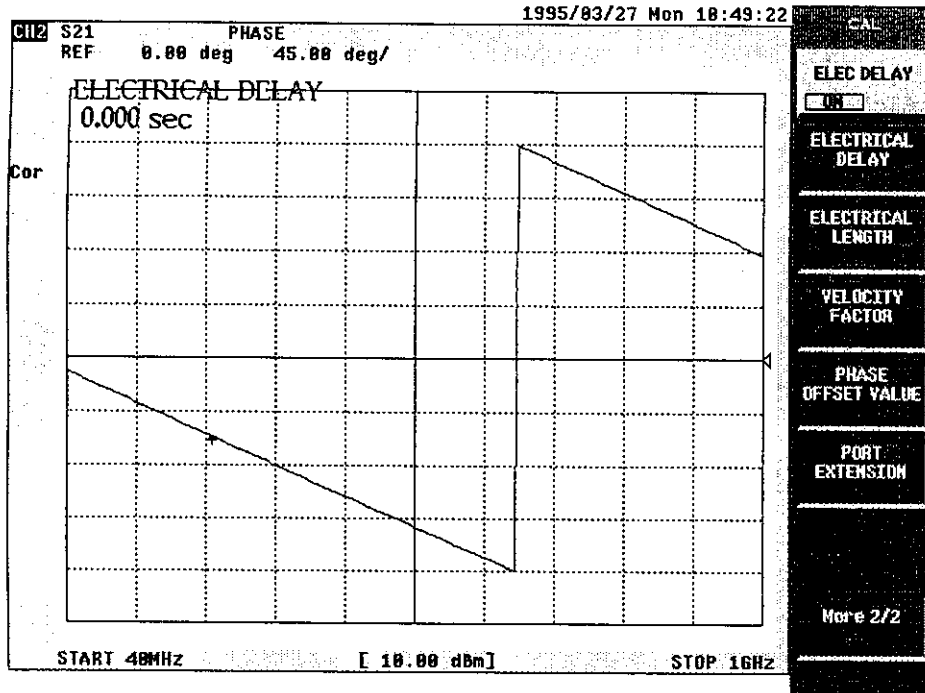

Figure 5-33 Electrical Length Compensation Mode



6. Measurement of Electrical Length

6. Compensate the electrical length by using the phase characteristic until the phase characteristic becomes flat.

(It may be necessary to turn the knob several times until the phase characteristic becomes flat.)

This compensation value is the electrical length of DUT.

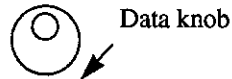

The display on the screen is as follows.

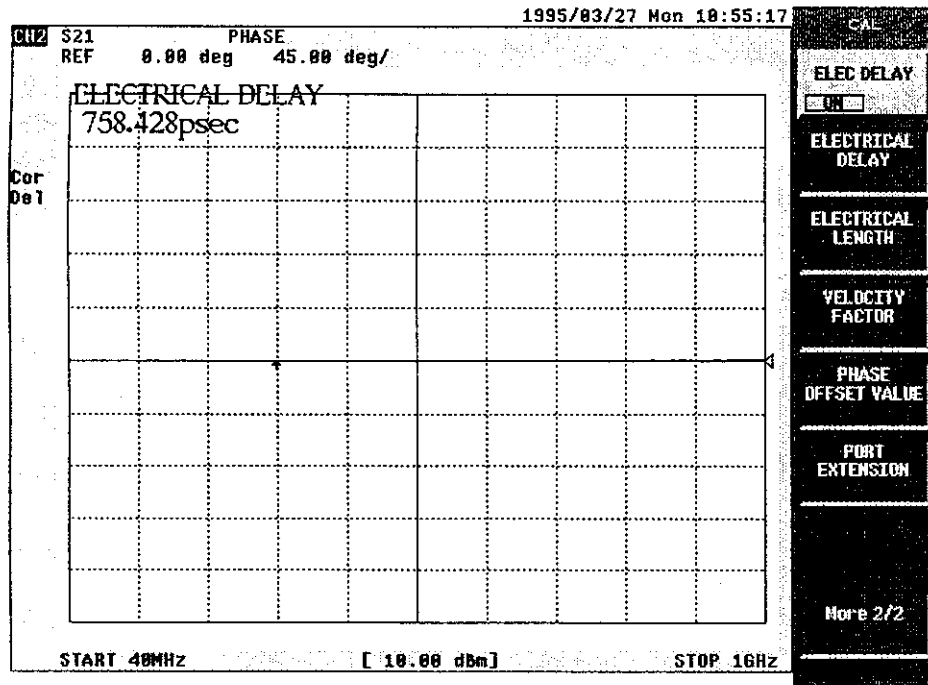

Figure 5-34 Measurement of Electrical Length

## 7. High-speed Measurement Using Program Sweeping Function

Here explains about the program sweeping function that can execute sweeping according to the list of already specified sweeping segment.

This function is useful to shorten measurement time or to improve dynamic range.

●880MHz band-pass filter is used as DUT.

1. Set up (filter connection) and preset. (Refer to page 3-11.)  
Press [CH 2] to set the active channel to 2.
2. Set start-frequency and stop-frequency.  
[CENTER] [8] [8] [0] [MHz]  
[SPAN] [1] [.] [6] [GHz]
3. Set the measurement format to magnitude (log display).  
Set up the scale (display coordinates). Set the reference value at -10dBm here.  
[SCALE] [REF VALUE] [-] [1] [0] [ $\times 1$ ]

Calibration is performed following the completion of program sweeping edition.  
The display on the screen is as follows.

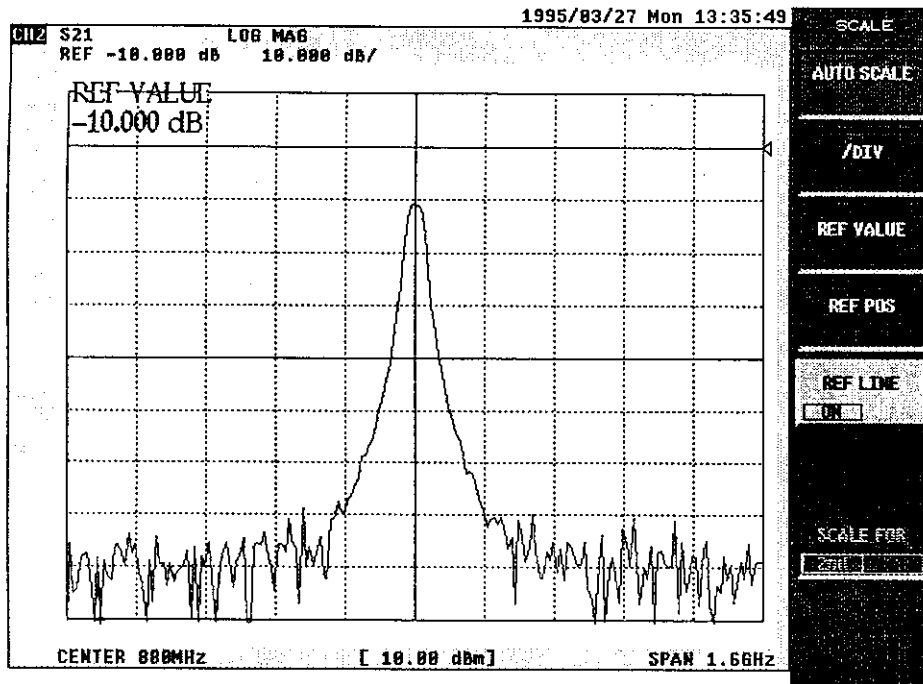

Figure 5-35 Linear Sweeping

## 7. High Speed Measurement by Program Sweeping Function

●Next, enlarge and measure the specified bandwidth about this filter by using program sweep.

Here, divide the pass-band into the following three segments to enlarge and measure.

SEG.	START	STOP	POINT
0	80MHz	860MHz	50
1	860MHz	900MHz	50
2	900MHz	1680MHz	50

Each sweep segment (SEG.) is independent so that different sweeping point number, power level value and IF bandwidth value can be set up.

Program sweep function allows to sweep up to all sweeping point 1201 at a time and connect up to 30 kinds of these segment sweep settings (SEG.NUMBER 0 to 29).

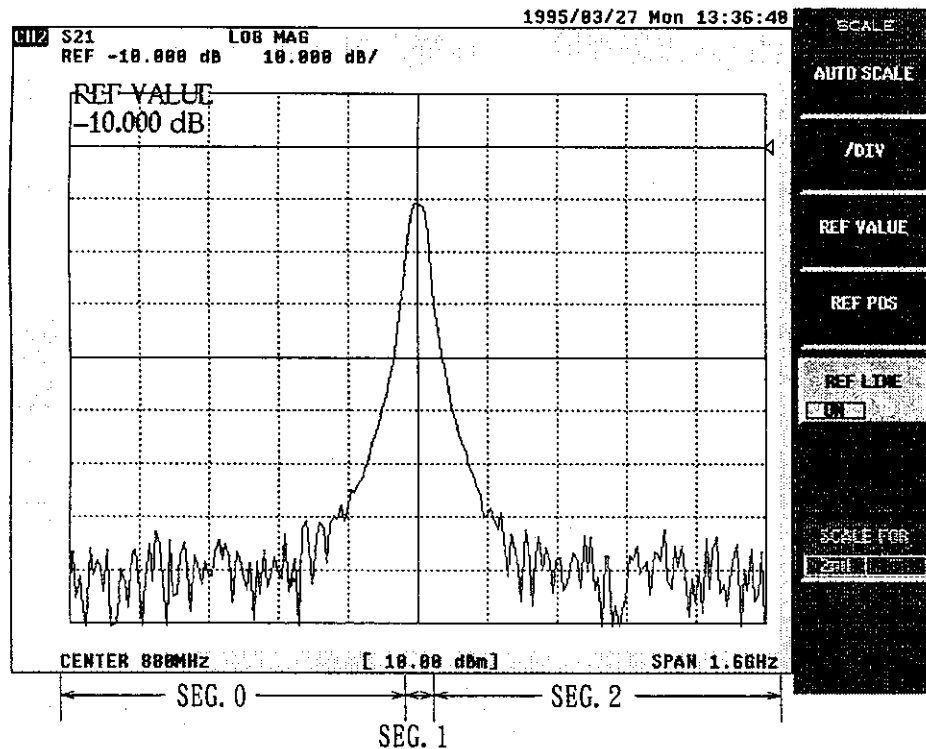

Figure 5-36 Setting of Program Sweeping

## 7. High Speed Measurement by Program Sweeping Function

## 4. Edit each setup value of the program sweep.

For the divided three segments, set up the data in 0, 1 and 2 segments.

[MENU] [SWEEP TYPE [        ]] [EDIT PROG SWEEP]

    [SEGMENT NUMBER] [0] [×1]

    [START] [8] [0] [MHz]

    [STOP] [8] [6] [0] [MHz]

    [POINT] [5] [0] [×1]

    [SEGMENT NUMBER] [1] [×1]

    [START] [8] [6] [0] [MHz]

    [STOP] [9] [0] [0] [MHz]

    [POINT] [5] [0] [×1]

    [SEGMENT NUMBER] [2] [×1]

    [START] [9] [0] [0] [MHz]

    [STOP] [1] [6] [8] [0] [MHz]

    [POINT] [5] [0] [×1]

## 5. Set the sweep type to the program sweep.

Press [Return] [PROGRAM SWEEP] .

## 6. Calibrate frequency characteristic.

Remove DUT and connect the through adapter instead.

Normalize in this state.

[CAL] [NORMALIZE (THRU)]

Following the completion, return the connection to DUT (filter).

The display on the screen is as follows.

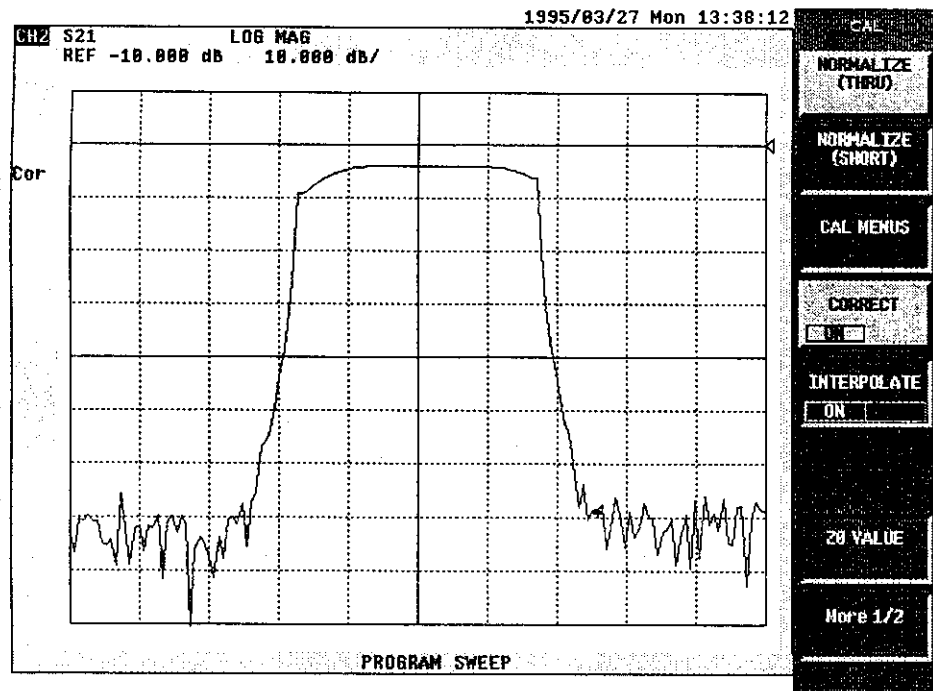

Figure 5-37 Execution of the Program Sweep

7. High Speed Measurement by Program Sweeping Function

- 7. In the program sweep, the power level value and IF bandwidth value can be set in each segment.

Therefore the measurement is possible to improve the analyzer's dynamic range.

Set IF bandwidth of segment 0 to 1kHz and power level of segment 1 to +5.0dBm, here.

```
[MENU] [SWEEP TYPE [  ] ] [EDIT PROG SWEEP]
[SEGMENT NUMBER] [0] [×1]
[More 1/2]
[IF RBW [  ] ] [1] [kHz]
[More 2/2]
[SEGMENT NUMBER] [1] [×1]
[More 1/2]
[SEGMENT POWER] [5] [.] [0] [×1]
[Return]
[PROGRAM SWEEP]
```

The display on the screen is as follows.

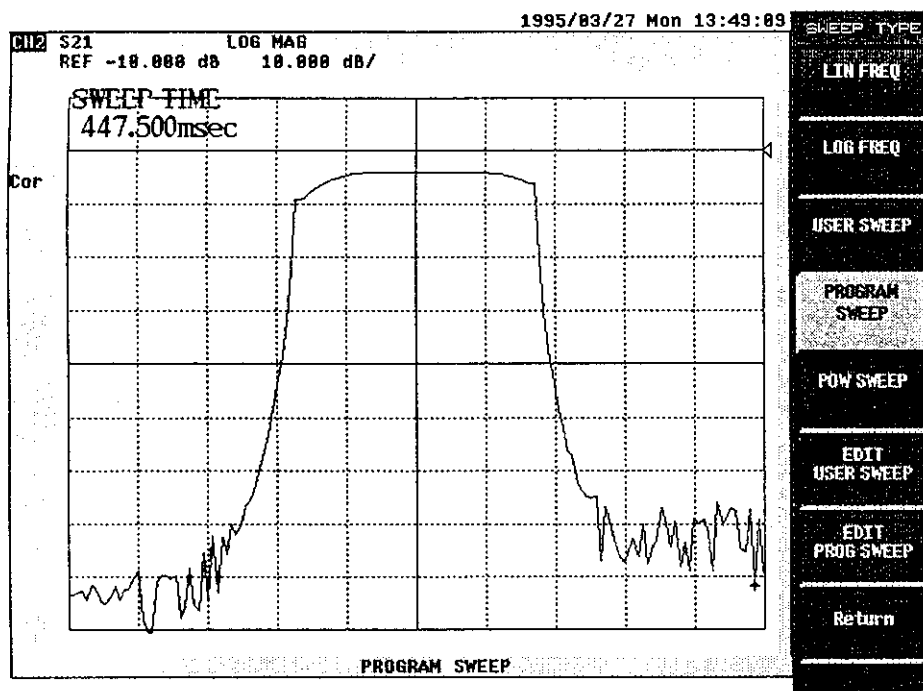

Figure 5-38 Change of the Program Sweep

## 8. GO/NG Measurement Using Limit Line Function

GO/NG of DUT can be judged by using the limit line function of the analyzer.

Besides the judgement of magnitude, GO/NG of Smith chart and Polar coordinates display can be judged.

- The following shows an example of how the limit line of 880MHz band-pass filter is generated.

### □ Setting procedure

1. Set up (filter connection) and preset. (Refer to page 3-11/4-4)  
Press [CH 2] to set the active channel to 2.
2. Set up start-frequency and stop-frequency.  
[CENTER] [8] [8] [0] [MHz]  
[SPAN] [2] [0] [0] [MHz]
3. Calibrate the frequency characteristic.  
Remove DUT and connect the through adapter instead.  
Normalize in this state.  
Following the completion of [CAL] , [NORMALIZE (THRU)] , return the connection to DUT.
4. Set the measurement format to magnitude (log display).  
The display on the screen is as follows.

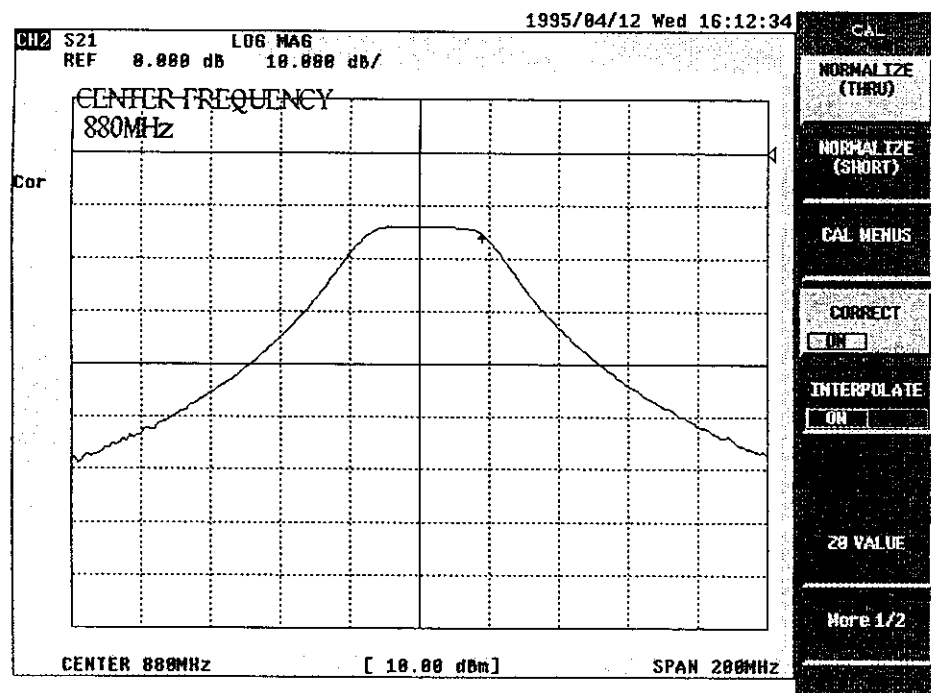

Figure 5-39 Screen before Execution of Limit Line Measurement

8. GO/NG Measurement Using Limit Line Function

5. Set limit line.

Limit line is set the upper limit value and the lower limit line for each segment. The segment can be set up to 31 pcs.(0 to 30)

Here generates the limit line of the following table.

SEGMENT No.	0	1	2	3	4
Stimulus value	780MHz	820MHz	866MHz	898MHz	960MHz
Upper limit value	-40dB	-40dB	-10dB	-10dB	-40dB
Lower limit value	-65dB	-65dB	-30dB	-30dB	-65dB

The following figure shows the limit line to set.

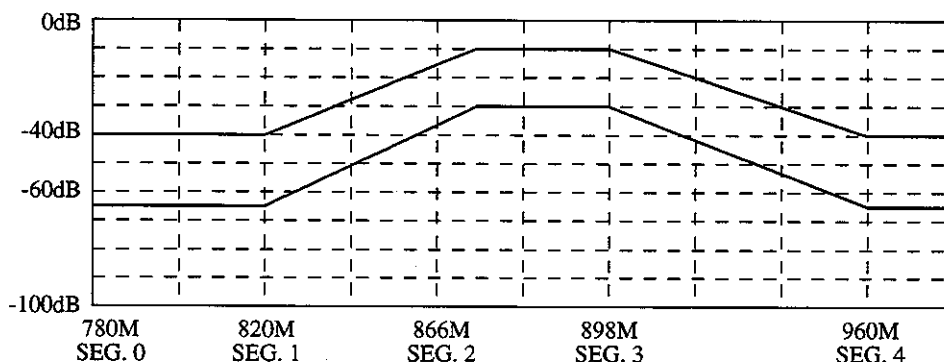

Figure 5-40 Setting of the Limit Line

● Establish the edit mode.

[SYSTEM] [LIMIT MENU] [EDIT LIMIT LINE]

The display on the screen is as follows.

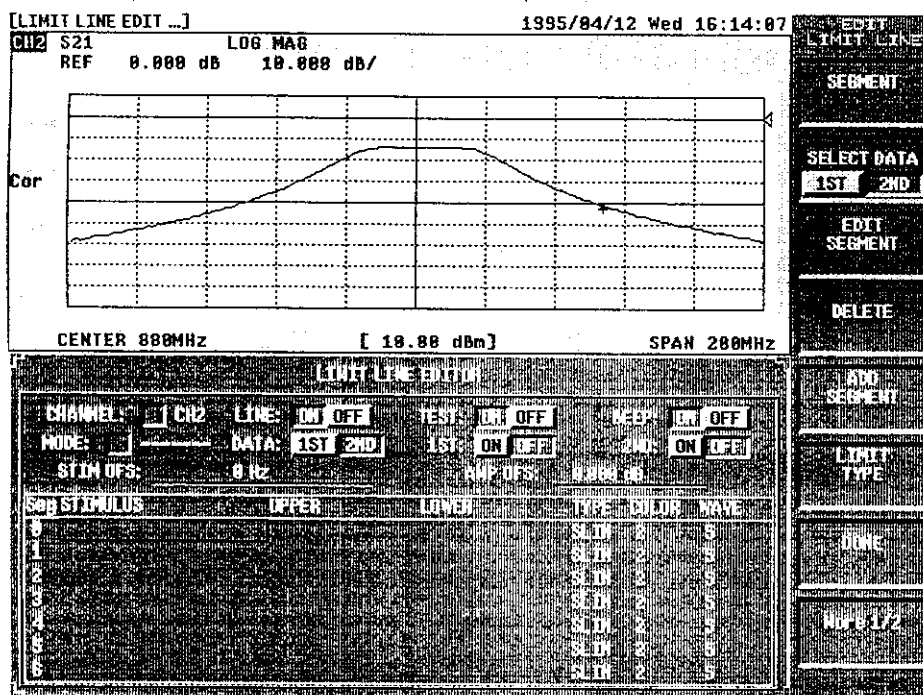

Figure 5-41 Limit Line Editing



8. GO/NG Measurement Using Limit Line Function

● Set each segment.

Setting of segment 0.

SEGMENT 0 : [EDIT SEGMENT]  
 [STIMULUS VALUE] [7] [8] [0] [MHz]  
 [UPPER LIMIT] [-] [4] [0] [×1]  
 [LOWER LIMIT] [-] [6] [5] [×1]  
 [Return]

As the marker can be used with data knob, etc. now, it's useful to confirm the setting value of each segment.

The display on the screen is as follows.

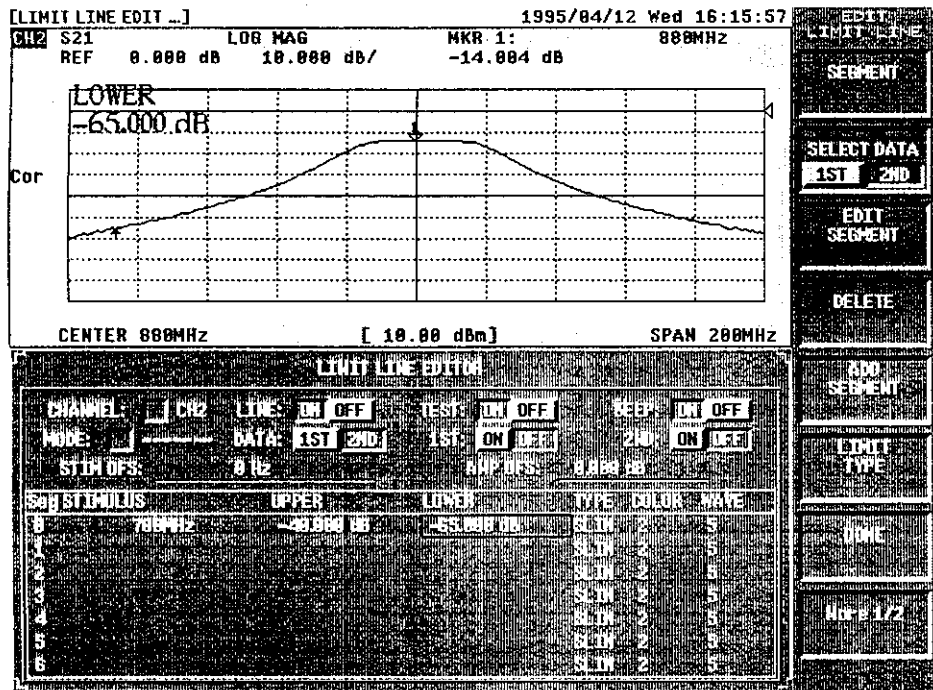

Figure 5-42 Setting of Segment 0

## 8. GO/NG Measurement Using Limit Line Function

Set segment 1, segment 2, segment 3 and segment 4 in the same way.

SEGMENT 1 :    【ADD SEGMENT】  
                  【STIMULUS VALUE】 [8] [2] [0] [MHz]  
                  【UPPER LIMIT】 [-] [4] [0] [×1]  
                  【LOWER LIMIT】 [-] [6] [5] [×1]  
                  【Return】

SEGMENT 2 :    【ADD SEGMENT】  
                  【STIMULUS VALUE】 [8] [6] [6] [MHz]  
                  【UPPER LIMIT】 [-] [1] [0] [×1]  
                  【LOWER LIMIT】 [-] [3] [0] [×1]  
                  【Return】

SEGMENT 3 :    【ADD SEGMENT】  
                  【STIMULUS VALUE】 [8] [9] [8] [MHz]  
                  【UPPER LIMIT】 [-] [1] [0] [×1]  
                  【LOWER LIMIT】 [-] [3] [0] [×1]  
                  【Return】

SEGMENT 4 :    【ADD SEGMENT】  
                  【STIMULUS VALUE】 [9] [6] [0] [MHz]  
                  【UPPER LIMIT】 [-] [4] [0] [×1]  
                  【LOWER LIMIT】 [-] [6] [5] [×1]  
                  【Return】

8. GO/NG Measurement Using Limit Line Function

The display on the screen is as follows.

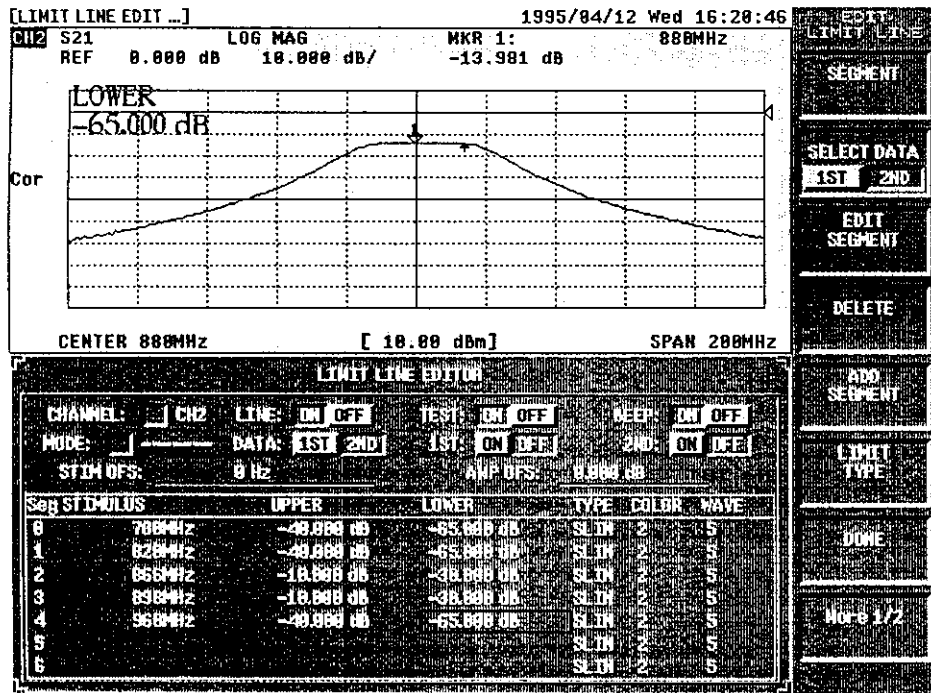

Figure 5-43 Setting of Each Segment

● Select a display type of limit line from the following 3 types for each segment.

- [1] SLOPING LINE (SLIN) : Links to the next segment with a straight-line.
- [2] FLAT LINE (FLIN) : Links to the next segment with parallel lines.
- [3] SINGLE POINT (SPO) : Shows each segment with a point.

In the above example, the type is not set as it's linked with SLOPING LINE of default.

For example, if you want to set FLAT LINE, operate as follows when the menu returned to the edit menu.

[LINE TYPE] [FLAT LINE]

Returns to the edit menu of limit line.

[Return]

8. GO/NG Measurement Using Limit Line Function

6. Define the setting of limit line and return to the edit menu.  
    [DONE]
7. Switch ON the GO/NG judgement.  
    [LIMIT TEST ON/OFF]
8. Switch ON the limit line.  
    [LIMIT LINE ON/OFF]

The display on the screen is as follows.

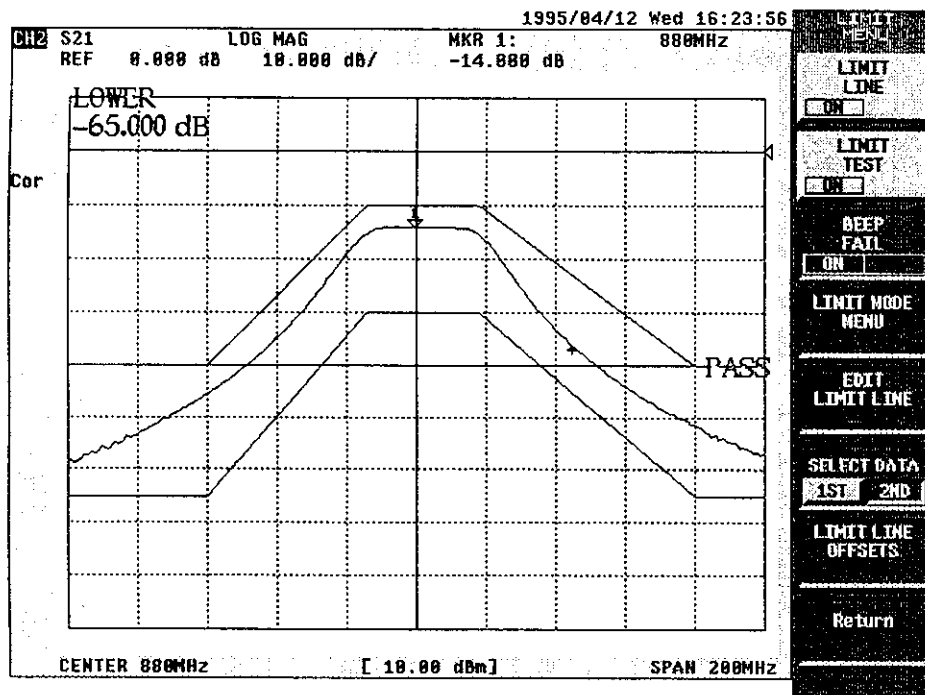

Figure 5-44 Execution of Limit Test

## 8. GO/NG Measurement Using Limit Line Function

9. Change the lower limit values of segment 2 and segment 3 to -20dB.

```
[EDIT LIMIT LINE]
[SEGMENT] [2] [×1] [EDIT SEGMENT]
[LOWER LIMIT] [-] [2] [0] [×1]
[Return]
[SEGMENT] [3] [×1] [EDIT SEGMENT]
[LOWER LIMIT] [-] [2] [0] [×1]
[Return]
[DONE]
```

The display on the screen is as follows.

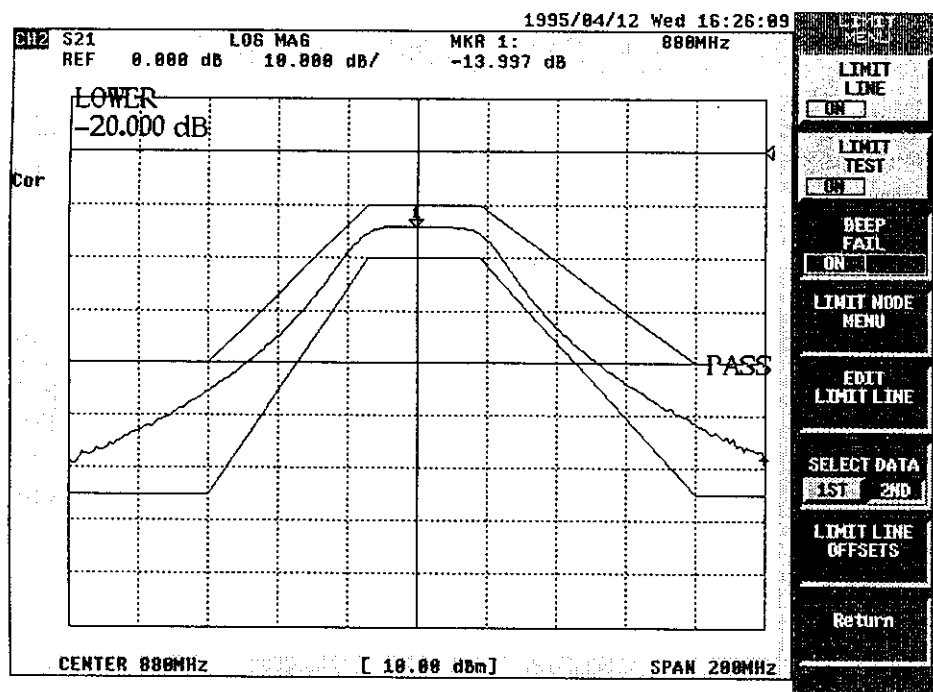
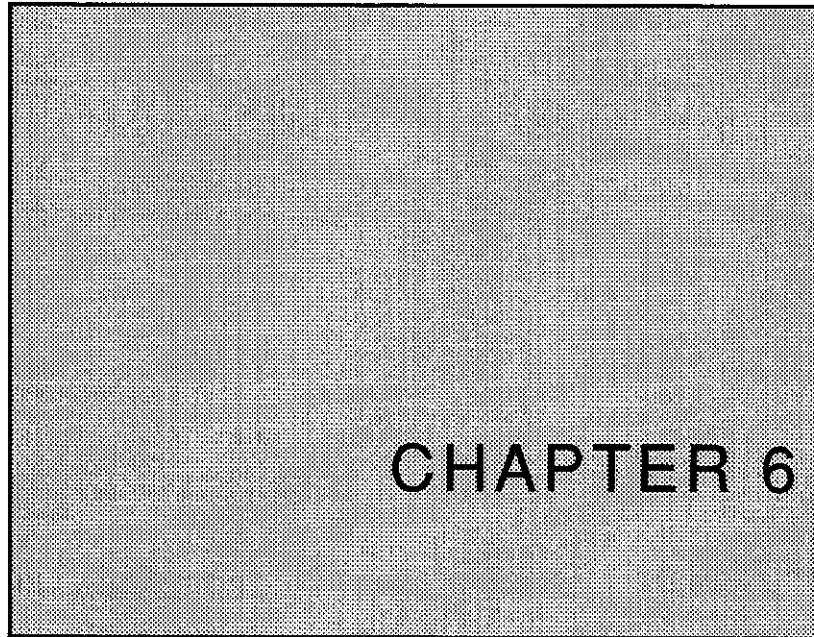

Figure 5-45 Change of Limit Line

MEMO 



## RECORD and OUTPUT

This chapter describes how to output the measurement data to the plotter, how to save it into the floppy disk and how to recall it.

---

### CONTENTS

---

1. Outputting to the Potter .....	6-2
2. Saving/Recalling into the Save/Recall-register .....	6-6
3. Saving into the Floppy Disk and Recalling .....	6-8
About the Measurement Data to Save .....	6-12

---

# 1. Output to the Plotter

Here explains how to output the measurement data to the plotter.

●It's assumed that the plotter is set in HP mode and the address is set to 5.

1. Display the markers, etc. and set the measurement screen to plot.
2. In order to use the plotter, set R3765/3767 to SYSTEM CONTROLLER.  
[LCL] [SYSTEM CONTROLLER]
3. Set GPIB address of the plotter to R3765/3767.  
[SET ADDRESS] [ADDRESS PLOTTER] [5] [×1]

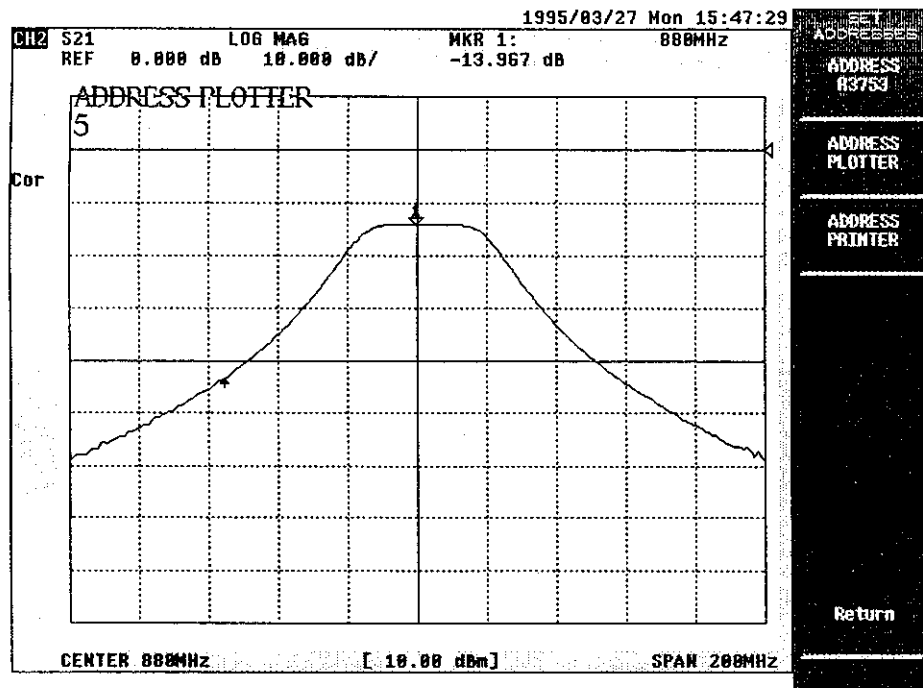

Figure 6-1 Setting of Plotter GPIB Address



4. Select the mode of the plotter.

The plotter is initial-set in HP mode.

Set the plotter of the analyzer to HP mode too.

[COPY] [PRINT/PLOT SETUPS]

[DEFAULT SETUPS]

[PLOTTER HP/AT] Select HP.

[Return]

5. Select the data to output to the plotter.

The following is set here.

● Output measurement data, coordinates data, text data, marker data, reference data.

● Memory data is not output.

All initial values are set to "ON" (output).

Only memory data is set to "OFF" (not output).

[DEFINE PLOT]

[PLOT MEMORY ON/OFF] Switch OFF.

Above operation displays the screen as shown in Figure 6-2 in next page.

3. Saving/Recalling to Floppy Disk

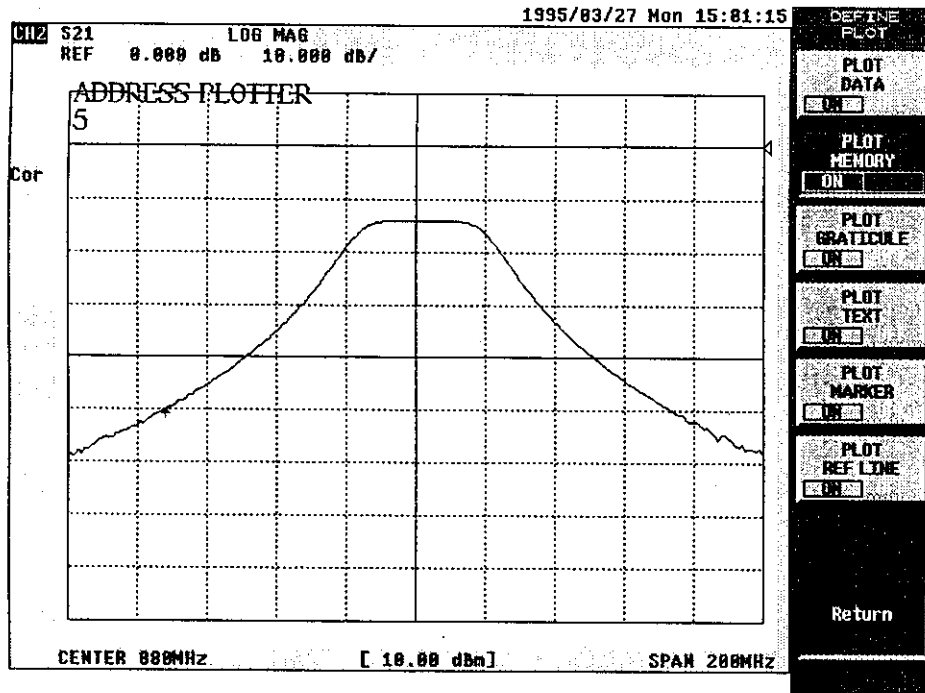

Figure 6-2 Change of Plotter Initial Setup Value (Initial Value)

- 6. Start the output to the plotter.  
[Return] [PLOT]

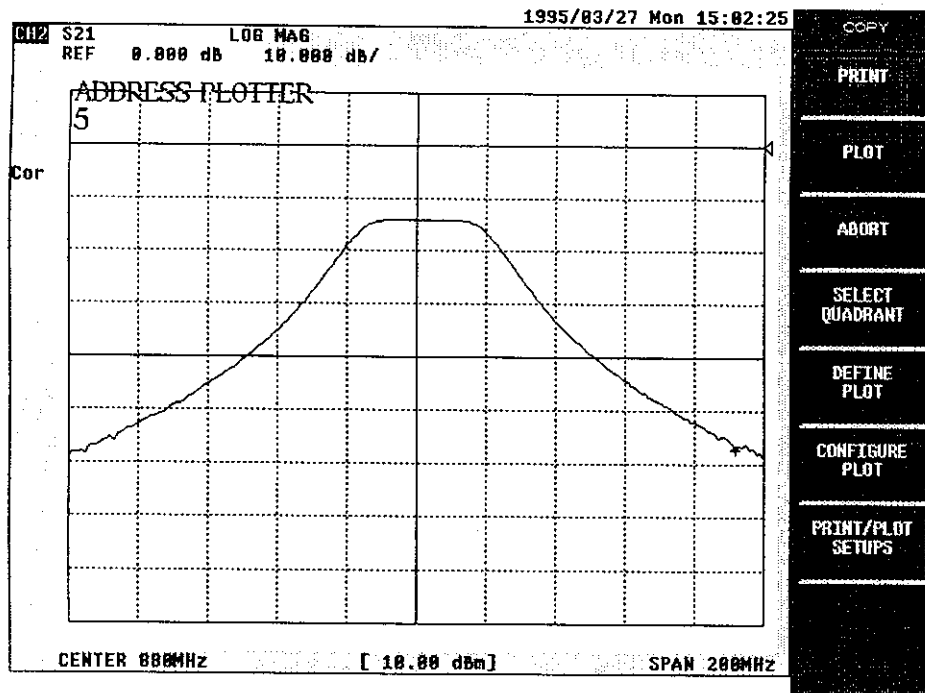

Figure 6-3 Output Data to the Plotter

7. The output result of the plotter is as follows.

**NOTE:** HP plotter sometimes makes error display such as the error lamp lights with normal plotting.

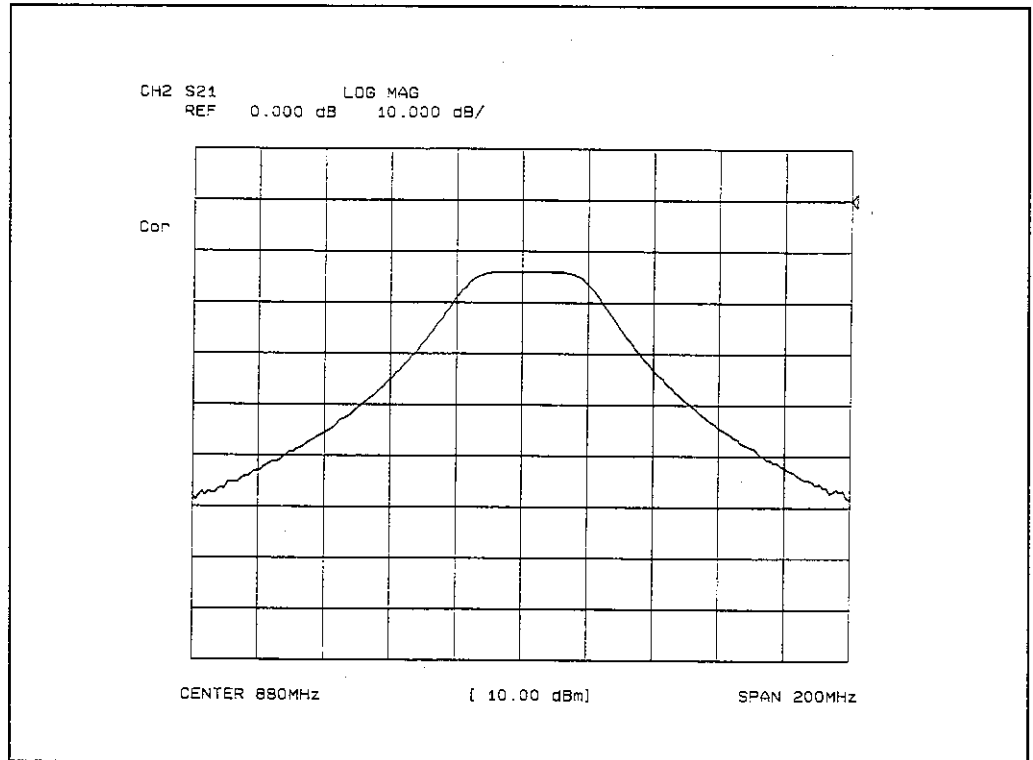

Figure 6-4 Output Result of the Plotter

## 2. Saving/Recalling to the Save/Recall-register

Here describes how to save/recall the set-data of the measurement to the save/recall-register.

**ADVICE**

For the saving of the save-register, If the power source is switched to OFF, the memory waveform data is cleared.

The set-data and the calibration data are backed up.

1. Display the markers, etc. and set the measurement screen to save.
2. Save the set-data in the save-register.  
 [SAVE] [SAVE REGISTER] [SAVE REG-1]

By the above operation, the display on the screen changes as follows.

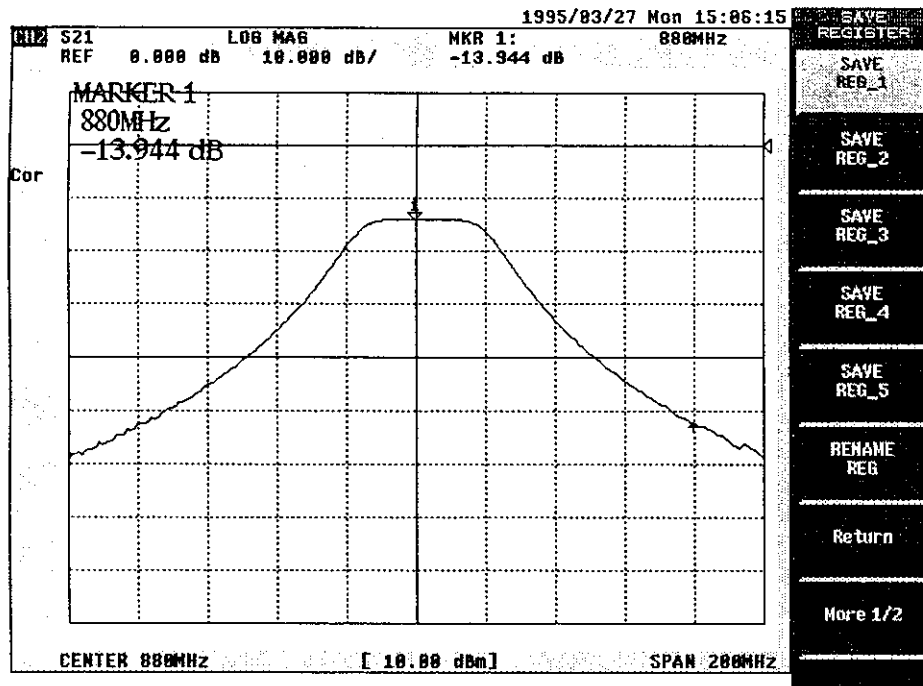

Figure 6-5 Saving into the Save-Register

●Next, recall the saved set-data.

3. Execute the preset and initialize the setting of the analyzer.  
[PRESET]
4. Recall the set-data by the recall-register.  
[RECALL] [RECALL REG-1]

By the above operation, the display on the screen changes as follows.

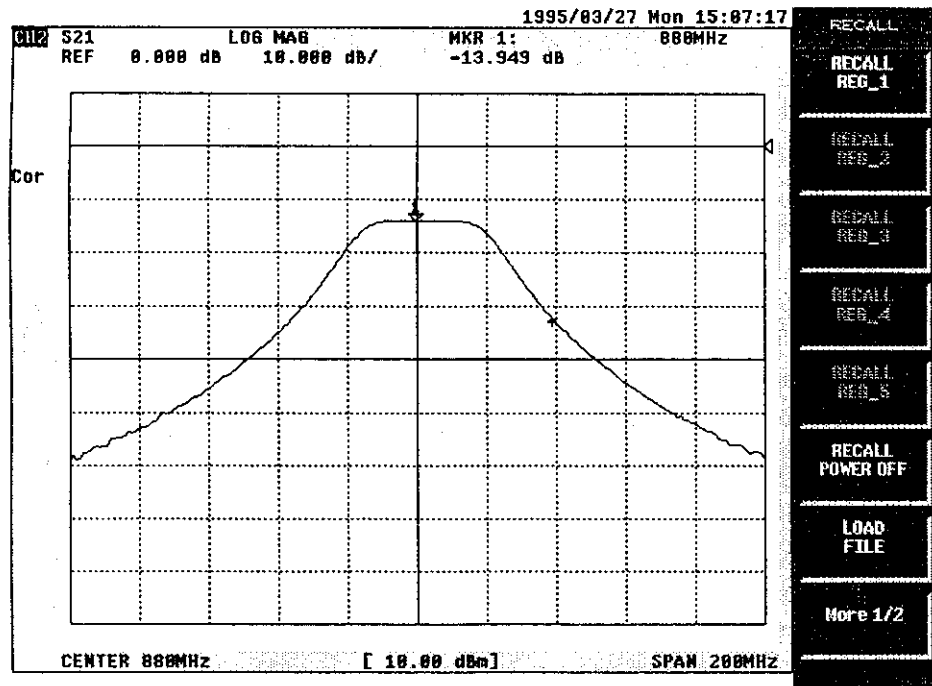

Figure 6-6 Recalling from the Recall-register

#### ADVICE

1. When the saving is performed to the save-register, the set-data and the calibration data are saved in C drive (RAM disk, with backed up), and the memory waveform data is saved in B drive (RAM disk, without backed up). Therefore, the memory waveform data is cleared at power source OFF.
2. In order to save the memory waveform data, use the store file function for saving/recalling to the floppy disk in the next page. Refer to page 7-97 for details.

### 3. Saving/Recalling to Floppy Disk.

Here describes how to save/recall the set-value of the measurement using the store/load-file.

In the store/load-file, the data is stored in the floppy disk inserted in A drive.

---

**A D V I C E**

1. Have a formatted floppy disk ready.
  2. The usable disks are DD720KB, HD1.2MB, HD1.44MB.
- 

● **Formatting procedure of floppy disk**

1. Insert floppy disk into floppy disk drive.

Format types in the initial state are ;

DD 720KB

HD 1.2MB (8 SECTORS)

2. Format.

[SAVE] [FORMAT DISK] [OK?]

**Operating procedure**

1. Display markers, etc. and set the measurement screen to save.
2. Insert the formatted floppy disk into A drive and select the store file menu.

After floppy disk inserted,

[SAVE] [STORE FILE]

Now the file list window is displayed.

## 3. Select a data to store.

The setting conditions, raw data before formatted, and calibration data are stored here.

**【DEFINE STORE】**

**【STATE ON/OFF】**  Switch ON.

**【RAW ARRAY ON/OFF】**

**【CORR COEF ON/OFF】** When the calibration was performed, switches ON automatically.

**【Return】**

## 4. Set a name to a file before saving the data to retrieve easily.

If it's saved under the default file name, go to step 5.

**【EDIT NAME】**

**【CLEAR NAME】**

●The file name is saved as "TEST".

(1) Put the cursor on the "T" with the rotary knob or [↑] [↓], and press [×1].

(2) Put the cursor on the "E" with the rotary knob or [↑] [↓], and press [×1].

(3) Put the cursor on the "S" with the rotary knob or [↑] [↓], and press [×1].

(4) Put the cursor on the "T" with the rotary knob or [↑] [↓], and press [×1].

3. Saving/Recalling to Floppy Disk

By the above operation, the display on the screen becomes as follows.

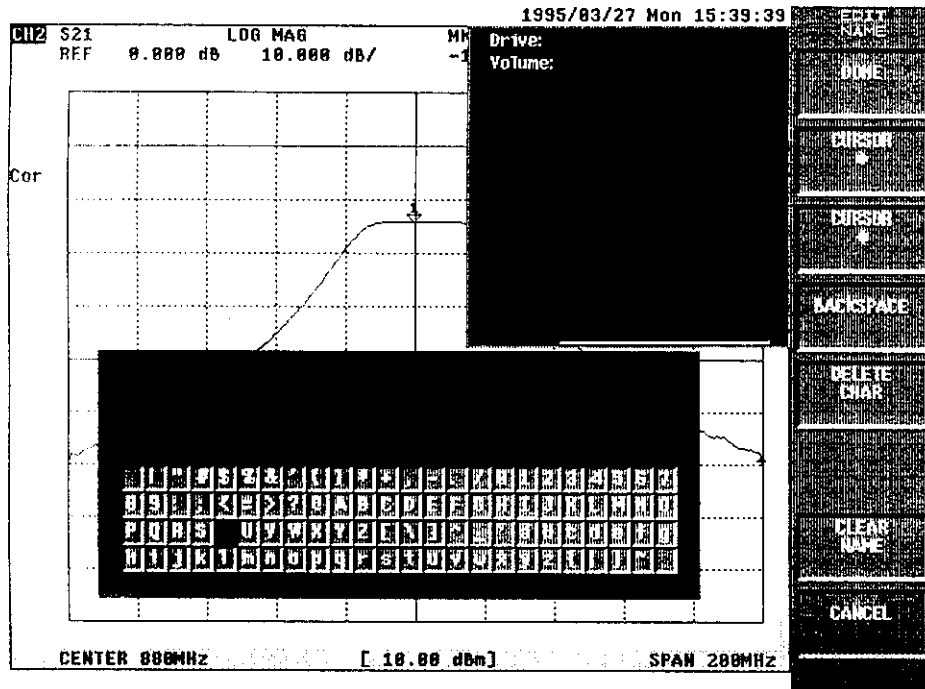

Figure 6-7 Saving to Floppy Disk

File name is defined with [DONE] .

5. Save.  
[STORE]

With the above operation, the data saving is completed.



● Next, recall the saved data.

6. Execute the preset and initialize the setting of the analyzer.  
[PRESET]
7. Recall the saved data from the file.  
[RECALL] [LOAD FILE]

Now the file list window is displayed.

8. Select the file name to recall from the file list (refer to page 7-98, Figure 7-5), and execute the recall of data.  
Put the cursor on the file to recall with [CURSOR ↑] and [CURSOR ↓].  
By [LOAD] the display on the screen becomes as follows.

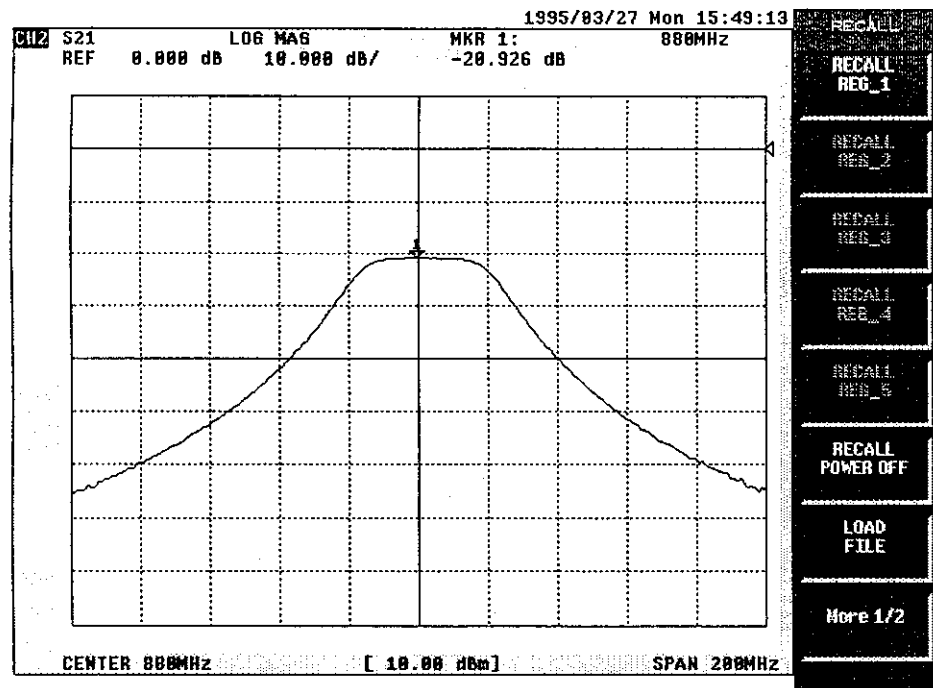

Figure 6-8 Recall from Floppy Disk

After the completion of the recall, the sweep is in the held state automatically.

3. Saving/Recalling to Floppy Disk

■ About the Measurement Data to Save.

There are three kinds in the measurement data to save.

- (1) RAW ARRAY (Raw data)
- (2) FORMAT ARRAY (Format data)
- (3) MEM ARRAY (Memory data)

Now (1) RAW ARRAY and (2) DATA ARRAY save the display data.

The difference between the two data is as follows.

- RAW ARRAY saves the data before the error compensation, the trace computation, etc. processed.
- DATA ARRAY saves the displayed data itself.

For example, when the saved data is recalled by RAW ARRAY, the right value when saved can be displayed even if the measurement format is changed.

In DATA ARRAY, if the displayed format when saved is of LOG MAG setting, the right value is displayed only with LOG MAG format at the data recalling.

Refer to Figure 9-1 Data flow (page 9-3) for the flow of three data.

# CHAPTER 7

## FUNCTION DESCRIPTIONS

This chapter describes about the function of each section in details to promote better understanding.  
Please make use of appendix 4 "Soft Key Menu List" at the end of this document.

---

### CONTENTS

---

1. ACTIVE CHANNEL Block .....	7-2
2. ENTRY Block .....	7-4
3. STIMULUS Block .....	7-6
4. RESPONSE Block .....	7-10
5. Calibration .....	7-28
6. Marker Function .....	7-48
7. Sweep .....	7-65
8. INSTRUMENT STATE Block .....	7-71
9. Limit Function .....	7-75
10. GPIB Block .....	7-84
11. Save/Recall .....	7-87
12. Hard Copy .....	7-98
13. Communication with Peripheral Devices .....	7-105

---

## 1. ACTIVE CHANNEL Block

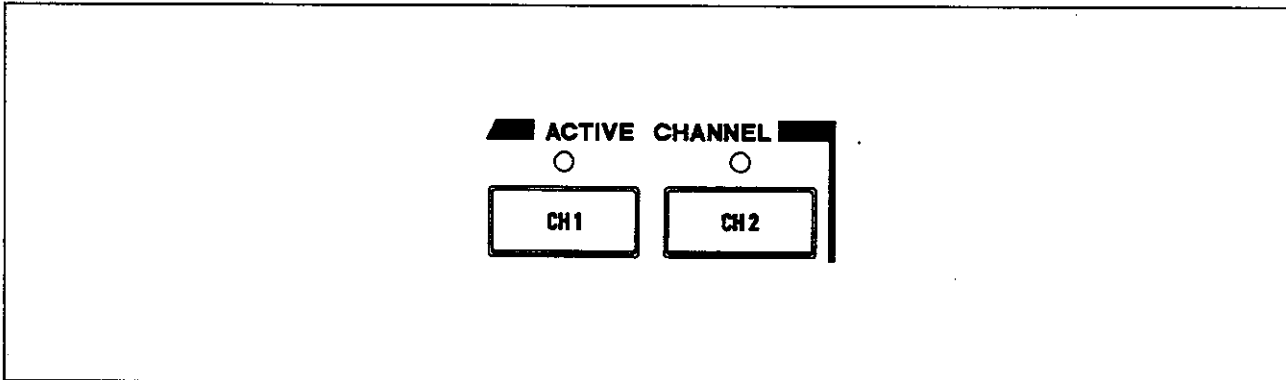

ACTIVE CHANNEL block is used to select which channel will be used for the active channel.

The analyzer has two measurement channels which can be independently used for measurement and data display.

The analyzer can perform the simultaneous measurement for reflection and transfer characteristics of DUT or the simultaneous measurement under different frequency conditions.

● The active channel is the channel for which various conditions can be set such as measurement or data display.

That is, all the channel-dependent functions will apply to the active channel.

The channel with its LED lit up is the current active channel.

● Each channel has the sub-measure screen.

The display on the sub-measure screen is displayed by setting input port under the conditions of the sub-measure ON in each channel. (Refer to page 7-11 for sub-measure screen selection.)

- For example, when the current channel 1 is active, repressing channel 1 makes the sub-measure screen (channel 3) of channel 1 to active. Pressing channel 1 once more returns to channel 1.
- Channel 3 and channel 4 are only sub-measurement screens which are not independent. Therefore channel 1 is necessary for channel 3 display, and also channel 2 is necessary for channel 4 display.

- The sub-measure screen of channel 1 is channel 3, and the sub-measure screen of channel 2 is channel 1.
- In order to make the sub-measure screen active, press the channel key again.

[CH 1] : Sets channel 1 or channel 3 to active.

[CH 2] : Sets channel 2 or channel 4 to active.

The setting of the signal source can be interlocked between the channels.

In the case, the conditions which has been set in the active channel will be also set in the other channel automatically. (See page 7-9.)

**NOTE :** The expression of 2 channels or channels designates channel 1 and channel 2.

Also there are some cases that channel 3 and channel 4 are expressed as sub-measure screens.

## 2. ENTRY Block

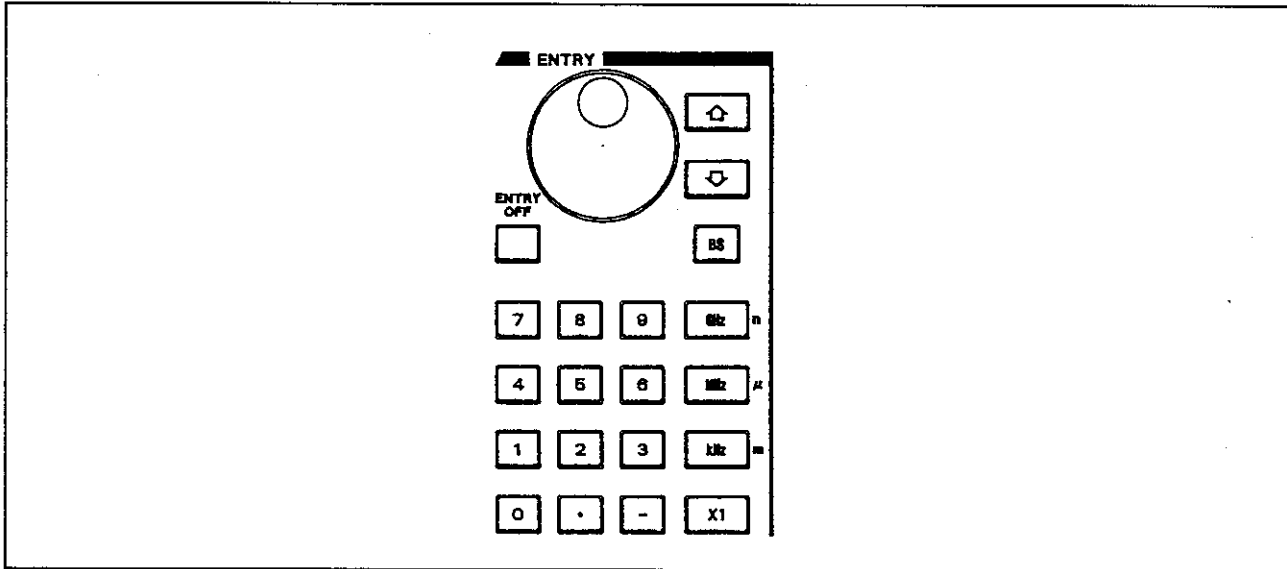

The ENTRY block is used to set data input/change for the selected function by using the [Panel key] and [Soft key].

This block is also used to set/change a marker.

Numeric keys : [0] to [9] ; Numeric keys.  
 [.] ; Decimal point key  
 [-] ; Minus sign key  
 [BS] ; Back space key  
 [ENTRY OFF] ; Entry off key  
 Clears all numeric data and also cancels an input request.

**NOTE:** After numeric key operation, press unit keys.

Input numeric values by using numeric keys, a decimal point key, and a minus sign key. Then, press a unit key after inputting the numeric value.

Pressing the unit key determines the unit of the input numeric values and terminates numeric entry. Namely the numeric entry is not complete until is specified by pressing a unit key.

While an arrow (→) is being displayed on the left side of the active entry area, the numeric entry does not complete.

### ● Unit key

- The suffix for basic units of "Hz", "deg", and "Ω" is commonly supported by the following unit keys.

[GHz] n : Giga ( $10^9$ )

[MHz]  $\mu$  : Mega ( $10^6$ )

[kHz] m : Kilo ( $10^3$ )

[×1] : ×1 ( $10^0$ )

- The suffix for basic units of "sec" and "m" or for real values without unit is commonly supported by the following unit keys.

[GHz] n : Nano ( $10^{-9}$ )

[MHz]  $\mu$  : Micro ( $10^{-6}$ )

[kHz] m : Milli ( $10^{-3}$ )

[×1] : ×1 ( $10^0$ )

If a basic unit other than the above is used, its suffix is not supported.

### ● ENTRY OFF key

The ENTRY OFF key is a toggle switch. When data entry is displayed, if the ENTRY OFF key is pressed, the current data entry is canceled.

If the ENTRY OFF key is pressed again, the data entry is displayed.

Once the PRESET key is pressed or the data entry is canceled by the analyzer itself, the ENTRY OFF key can not make the data entry displayed again.

### ● Step key : [↑] & [↓]

Increases or decreases the setting value with the specific step size. After the step key operation, no unit setting is required.

### ● Data knob :



Continuously makes the setting value variable.

After the data knob operation, no unit setting is required.

### 3. STIMULUS Block

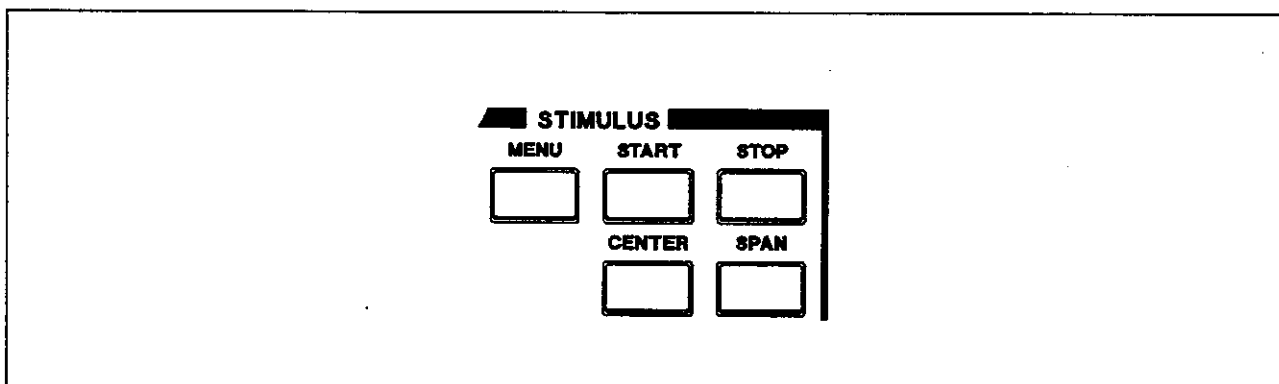

This block is used to set the conditions concerning the signal sources such as a frequency range, power level setting, sweep type, sweep time, and sweep resolution.

● Setup key

- [MENU] : Calls the signal source menu to be set such as an output level, sweep time, sweep type, and sweep resolution. (Refer to page 7-7.)
- [START] : Specifies the sweep start.  
Sets each start frequency or start power when the sweep type is a frequency type or power type.
- [STOP] : Specifies sweep stop.  
Sets each stop frequency or power when the sweep type is a frequency type or power type.
- [CENTER] : Specifies the center sweep.  
Set center frequency when the sweep type is a frequency type.
- [SPAN] : Specifies the sweep span.  
Set frequency span when the sweep type is a frequency type.

- Set the sweep range by pressing the START, STOP or CENTER, SPAN.
- For the other settings, press the MENU to call the signal source menu, then perform the setting.



## ■ Setting Signal Source

### □ The Setting and the Explanation

1. Press the [MENU] to call the signal source menu. (Refer to page A-9.)
2. Signal source menu
  - [POWER]** : Calls the power menu used for selecting an output power and an output port. (Go to step 3)
  - [SWEEP TIME]** : Sets the sweep time.  
When a zero is set, AUTO is selected.  
When AUTO is set, the minimum sweep time is set according to the sweep frequency range and receiver section resolution bandwidth.
  - [SWEEP TYPE [ ]]** :  
Calls the sweep type menu for selecting a sweep type. (Refer to page 7-65.)
  - [TRIGGER [ ]]** :  
Calls the trigger menu for selecting a sweep trigger condition. (Go to step 4)
  - [POINTS]** : Sets the number of sweep point. The number of settable points are: 3, 6, 11, 21, 51, 101, 201, 301, 401, 601, 601, 801, or 1201 points.
  - [COUPLED CH ON/OFF]** :  
Selects whether the setting conditions concerning the channels 1 and 2 are same or not. (Refer to page 7-9.)
  - [CW FREQ]** : Sets the frequency at power sweep.
  - [RESTART]** : Restarts the measurement from sweep start.  
When this key is pressed, the sweep restarts from the start, even if the sweep is uncompleted.
3. Power menu
  - [POWER]** : Sets the output level during frequency sweep.
  - [ATTENUATOR PORT1]** :  
Sets the PORT 1 attenuator value.  
\*Option 10 (Output attenuator)
  - [ATTENUATOR PORT2]** :  
Sets the PORT 2 attenuator value.  
\*Option 10 (Output attenuator)

3. STIMULUS Block

4. Trigger menu

- [CONTINUOUS]** : Continuously performs sweep.
- [SINGLE]** : Performs sweep once.  
If this key is pressed in the middle of a sweep, the measurement of the sweep is interrupted and a sweep is restarted.
- [HOLD]** : Stops sweep measurement.  
If this key is pressed in the middle of sweep, immediately sweep is interrupted.
- [INT TRIG]** : Automatically starts sweep by an internal source.
- [EXT TRIG]** : Starts sweep by an external synchronization signal.  
The external synchronization signal is input through the parallel I/O connector 18-pin of the rear panel.  
(Negative logic, pulse width ;  $1 \mu s$  or more.)
- [TRIGGER DELAY]** : Sets delay time between receiving the trigger signal and the start of sweep.

## ■ Interlocking between Channels

Selects whether the measurement condition concerning the signal source is set at the same condition or independently set in each channel when two-channel simultaneous measurement.

● For interlock setting :

The conditions which has been set to the active channel will be automatically set to the other channel as same.

● For independent setting :

Different measuring condition can be set to channel 1 and 2, respectively.

The setting conditions which can be interlocked between channels are shown below:

- Sweep type
- Frequency
- Output level
- Sweep time
- Number of measurement point
- Resolution bandwidth

## □ The Setting and the Explanation

1. Press the [MENU] to call the signal source menu. (Refer to page A-9.)
2. Press the [COUPLED CH ON/OFF] to select whether the setting conditions concerning two measurements are set to the same or not.

ON : Measures channel 1 and channel 2 simultaneously.

OFF : Measures channel 1 and channel 2 alternately. (Performs the measurement of channel 1, and then channel 2.)

● When the sub-measure screen (channel 3 or channel 4) of channel 1 or channel 2 is selected, channel 3 always operates with channel 1, and channel 4 operates with channel 2.

On the display of the sub-measure screen, the input port can be set in the state of sub-measure ON.

## 4. RESPONSE Block

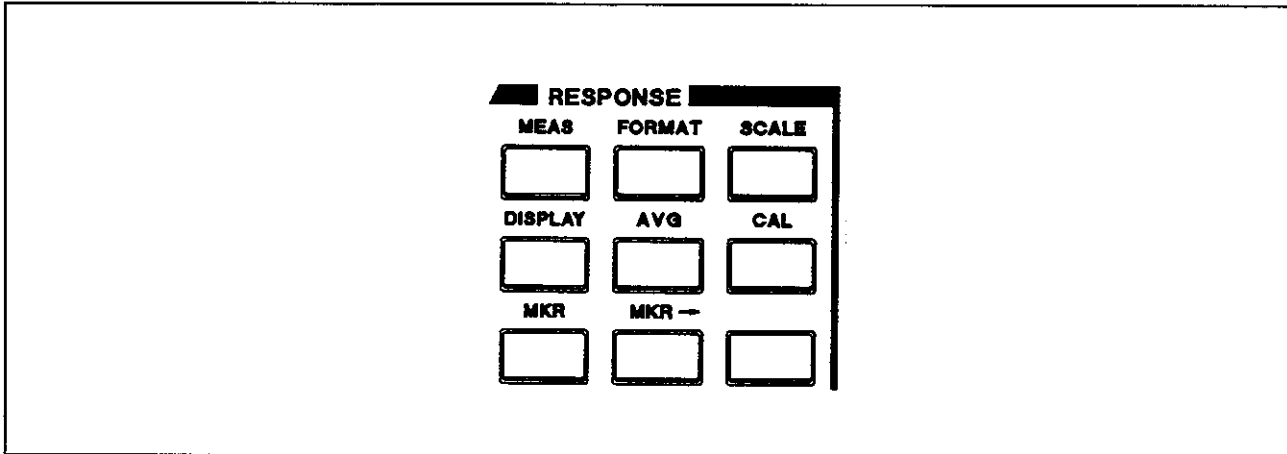

The RESPONSE block is used to set the measurement conditions of receiver section, measurement parameters, measurement format, display format, and marker for an active marker.

- [MEAS] : Calls the measurement menu for selecting an input port and measurement parameters. (Refer to page 7-11.)
- [FORMAT] : Calls the format menu for selecting the format of measurement data. (Refer to page 7-14.)
- [SCALE] : Calls the scale menu for setting the display coordinate axis. (Refer to page 7-15.)
- [DISPLAY] : Calls the display menu for executing 2-channel simultaneous display, trace operation function, and label input. (Refer to page 7-16.)
- [AVG] : Calls the average menu for executing data average, smoothing, resolution bandwidth setting. (Refer to page 7-25.)
- [CAL] : Calls the calibration menu for setting calibration function. (Refer to page 7-28.)
- [MKR] : Calls the marker menu for setting a marker. (Refer to page 7-48.)
- [MKR →] : Calls the marker search menu for setting analysis by using a marker. (Refer to page 7-58.)

## ■ Setting Input and Parameter Conversion

Selects the receiver section input port.

With the sub-measure screen, the input port can be set in the condition of sub-measure ON.

The data which is measured in the selected input port is a "complex data". This data is also formatted such as the amplitude, phase, group delay. Data before formatting can be changed to impedance, admittance, reverse S parameter.

### The Setting and the Explanation

1. Press the [MEAS] to call the measurement menu. (Refer to page A-10.)

2. Measurement menu

● For R3765A/3767A+S parameter, R3765C/3767C

【S11 (A/R) REFL FWD】 :

Sets the input port to S11 (A/R) REFL FWD.

【S21 (B/R) TRANS FWD】 :

Sets the input port to S21 (B/R) TRANS FWD.

【S12 (A/R) TRANS REV】 :

Sets the input port to S12 (A/R) TRANS REV.

【S22 (B/R) REFL REV】 :

Sets the input port to S22 (B/R) REFL REV.

【S11 & S21 FWD】 :

Sets the input port to S11 & S21 FWD.

【S22 & S12 REV】 :

Sets the input port to S22 & S12 REV.

【SUB MEAS ON/OFF】 :

Sets the ON/OFF of sub measurement..

【CONVERSION [     ]】 :

Calls the parameter menu for converting the measured data to an impedance, admittances, or reverse S parameters. (Go to step 3 of page 7-13.)

4. RESPONSE Block

●For R3765A/3767A

**[A/R]** : Sets the input port to A/R.

**[B/R]** : Sets the input port to B/R.

**[SUB MEAS ON/OFF]** :  
Sets the sub-measure ON or OFF.

**[CONVERSION [ ]]** :  
Calls the parameter converting menu to convert the measured data to impedance or admittance. (Go to step 3 in page 7-13.)

●For R3765B/3767B

**[REFLECTION]** : Sets the input port to REFLECTION.

**[TRANSMISSION]** :  
Sets the input port to TRANSMISSION.

**[REFL & TRANS]** :  
Sets the input port to REFL & TRANS.

**[SUB MEAS ON/OFF]** :  
Sets the sub-measure ON or OFF.

**[CONVERSION [ ]]** :  
Calls the parameter converting menu to convert the measured data to impedance or admittance. (Go to step 3 in page 7-13.)

## 3. Parameter conversion menu

**[Z(REFL)]** : Executes the impedance conversion by the reflection measurement.

$$\text{Conversion expression} = \frac{1+\rho}{1-\rho} \times Z_0$$

**[Z(TRANS)]** : Executes the impedance conversion by the transmission measurement.

$$\text{Conversion expression} = \frac{2(1-T)}{T} \times Z_0$$

**[Y(REFL)]** : Executes the admittance conversion by the reflection measurement.

$$\text{Conversion expression} = \frac{1-\rho}{1+\rho} \times \frac{1}{Z_0}$$

**[Y(TRANS)]** : Executes the admittance conversion by the transmission measurement.

$$\text{Conversion expression} = \frac{T}{2(1-T)} \times \frac{1}{Z_0}$$

**[1/S]** : Converts the S parameter to the reverse S parameter.

$$\text{Conversion expression} = \frac{1}{S}$$

**[OFF]** : Turns off the conversion function.

**[ZO VALUE]** : Sets the characteristics impedance ( $Z_0$ ).

**NOTE:**  $\rho$  ; Reflection coefficient  
 T ; Gain  
 S ; Reflection coefficient or gain  
 Z0 ; Characteristics impedance

## ■ Display Data Format

Formats the measurement data. Data is displayed as the type formatted.

### □ The Setting and the Explanation

1. Press the [FORMAT] to call the format menu. (Refer to page A-10.)

2. Format menu

#### ● Format menu (1 of 2)

**[LOG MAG]** : Sets to the logarithm amplitude display.

**[PHASE]** : Sets to the phase display.

The display is changed to the loop back display in  $\pm 180^\circ$ .

**[DELAY]** : Sets to the group delay display.

**[SMITH (R+jX)]** :

Sets to the Smith chart.

**[SMITH (G+jB)]** :

Sets to the admittance chart.

**[POLAR]** : Sets to the polar coordinates display.

**[LIN MAG]** : Sets to the liner amplitude.

#### ● Format menu (2 of 2)

**[SWR]** : Sets to the SWR (standing wave ratio) display.

**[REAL]** : Sets to the measurement data real display.

**[IMAG]** : Sets to the measurement data imaginary display.

**[PHASE  $-\infty, +\infty$ ]** :

Sets to the continuous phase display.

The phase is changed to the no loopback display in  $\pm 180^\circ$  based on the one point data.

**[LOG MAG & PHASE]** :

Sets to the simultaneous display with logarithm amplitude and phase.

**[LOG MAG & DELAY]** :

Sets to the simultaneous display with logarithm amplitude and group delay.

**[LIN MAG & PHASE]** :

Sets to the simultaneous display with linear amplitude and phase.



## ■ Setting Display Coordinate Scale

The coordinate in accordance with selected format is displayed on the screen.

The coordinate scale is changed on the scale menu.

### □ The Setting and the Explanation

1. Press the [SCALE] to call the scale menu. (Refer to page A-10.)

2. Scale menu

**[AUTO SCALE]** : Automatically sets the display coordinate to be an optimize value for display trace.

**[/DIV]** : For the cartesian format, sets the value of the vertical axis 1 scale.

**[REF VALUE]** : Sets the reference position value of the display coordinate.

※In the cases of Smith chart and Polar coordinates display, switches to **[FULL SCALE]** to set up a full scale value.

**[REF POS]** : Specifies the reference position of the display coordinate.

**[REF LINE ON/OFF]** :

Selects ON/OFF of the reference position display.

**[FULL SCALE]** : Sets a full scale value for a smith chart and polar coordinate display.

**[SCALE FOR 2nd / 1st]** :

Selects a preferred trace in displaying two traces simultaneously.

## ■ Selection of Four Screens Display and Display Information

The 2 channels simultaneous display can be performed.

Each channel has a sub-measure screen display, so that four-screen-display in total can be performed.

Also the selection of the trace data, the coordinate display ON/OFF, and the label input can be performed.

### □ The Setting and the Explanation

1. Press the [DISPLAY] to call the display menu. (Refer to page A-11.)

2. Display menu

● Display menu (1 of 2)

[DUAL CH ON/OFF] :

Selects ON/OFF of the two channels simultaneous display (overlap display). (See 'NOTE'.)

[SPLIT CH ON/OFF] :

Selects ON/OFF of the display split in two, the upper part and the lower part (split display). (See 'NOTE'.)

[DISPLAY DATA] :

Displays the measurement data only.

[DISPLAY MEMORY] :

Displays the memory data only.

[DISPLAY DATA & MEM] :

Displays both the measurement data and memory data.

[DEFINE TRACE [     ]] :

Calls the trace operation menu.

Perform the fundamental arithmetic operation between measurement data and memory data in the trace operation. (Refer to 7-23.)

[DATA→MEMORY] :

Sets the measurement data to the memory.

**NOTE:** The screen display depends on the sub-measure selection and ON/OFF of SPLIT CH and DUAL CH. (Refer to page 7-17, "Display Layout".)

● Display menu (2 of 2)

[GRATICULE ON/OFF] :

Selects ON/OFF of the coordinate display.

[LABEL] :

Calls the label menu for entering the label. (Refer to page 7-24.)

■ Display Layout

In the case that Channel 1 (CH 1) is in Active.

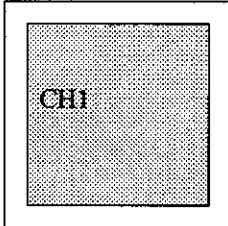
Setting conditions	Layout configuration
ACTIVE CH: CH1 DUAL CH: OFF SPLIT: OFF CH1: SUB MEAS: OFF CH2: SUB MEAS: OFF	

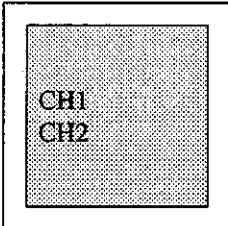
Setting conditions	Layout configuration
ACTIVE CH: CH1 DUAL CH: ON SPLIT: OFF CH1: SUB MEAS: OFF CH2: SUB MEAS: OFF	

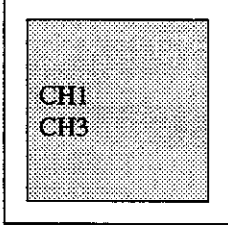
Setting conditions	Layout configuration
ACTIVE CH: CH1 DUAL CH: OFF SPLIT: OFF CH1: SUB MEAS: ON CH2: SUB MEAS: OFF	

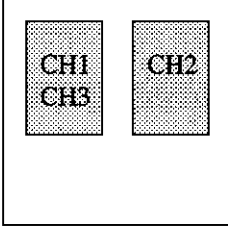
Setting conditions	Layout configuration
ACTIVE CH: CH1 DUAL CH: ON SPLIT: OFF CH1: SUB MEAS: ON CH2: SUB MEAS: OFF	

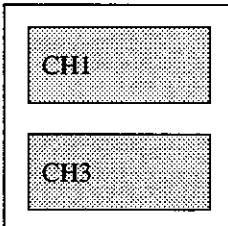
Setting conditions	Layout configuration
ACTIVE CH: CH1 DUAL CH: OFF SPLIT: ON CH1: SUB MEAS: ON CH2: SUB MEAS: OFF	

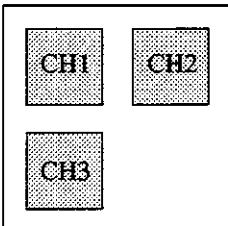
Setting conditions	Layout configuration
ACTIVE CH: CH1 DUAL CH: ON SPLIT: ON CH1: SUB MEAS: ON CH2: SUB MEAS: OFF	

4. RESPONSE Block

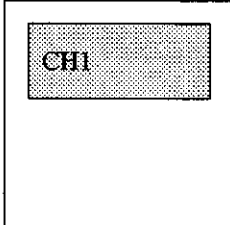
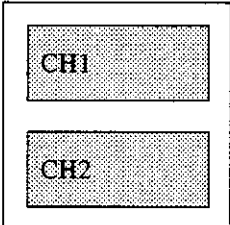
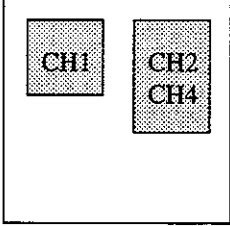
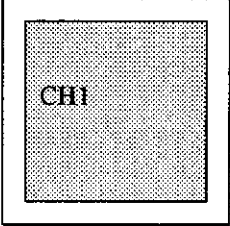
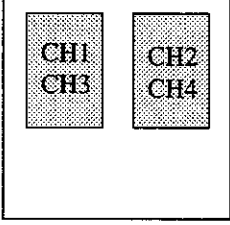
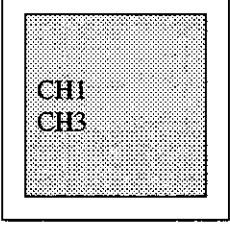
Setting conditions	Layout configuration	Setting conditions	Layout configuration
ACTIVE CH: CH1 DUAL CH: OFF SPLIT: ON CH1: SUB MEAS: OFF CH2: SUB MEAS: OFF		ACTIVE CH: CH1 DUAL CH: ON SPLIT: ON CH1: SUB MEAS: OFF CH2: SUB MEAS: OFF	
ACTIVE CH: CH1 DUAL CH: ON SPLIT: OFF CH1: SUB MEAS: OFF CH2: SUB MEAS: ON		ACTIVE CH: CH1 DUAL CH: OFF SPLIT: OFF CH1: SUB MEAS: OFF CH2: SUB MEAS: ON	
ACTIVE CH: CH1 DUAL CH: ON SPLIT: OFF CH1: SUB MEAS: ON CH2: SUB MEAS: ON		ACTIVE CH: CH1 DUAL CH: OFF SPLIT: OFF CH1: SUB MEAS: ON CH2: SUB MEAS: ON	

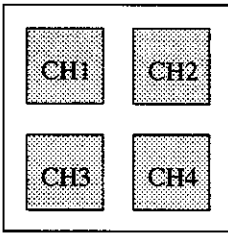
Setting conditions	Layout configuration
ACTIVE CH: CH1 DUAL CH: ON SPLIT: ON CH1: SUB MEAS: ON CH2: SUB MEAS: ON	

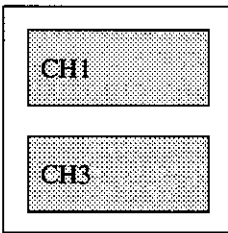
Setting conditions	Layout configuration
ACTIVE CH: CH1 DUAL CH: OFF SPLIT: ON CH1: SUB MEAS: ON CH2: SUB MEAS: ON	

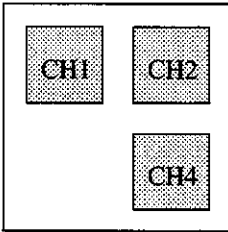
Setting conditions	Layout configuration
ACTIVE CH: CH1 DUAL CH: ON SPLIT: ON CH1: SUB MEAS: OFF CH2: SUB MEAS: ON	

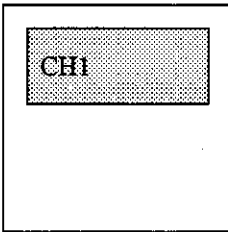
Setting conditions	Layout configuration
ACTIVE CH: CH1 DUAL CH: OFF SPLIT: ON CH1: SUB MEAS: OFF CH2: SUB MEAS: ON	

4. RESPONSE Block

In the case that Channel 2 (CH 2) is in Active.

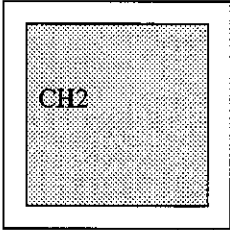
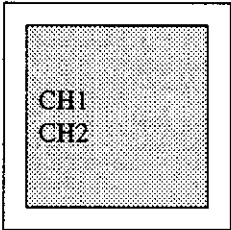
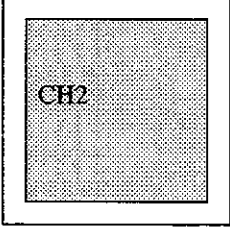
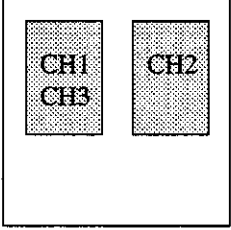
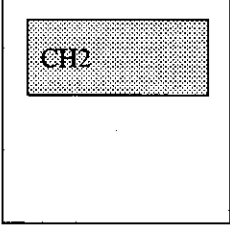
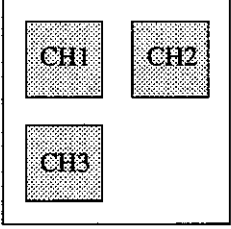
Setting conditions	Layout configuration	Setting conditions	Layout configuration
ACTIVE CH: CH2 DUAL CH: OFF SPLIT: OFF CH1: SUB MEAS: OFF CH2: SUB MEAS: OFF		ACTIVE CH: CH2 DUAL CH: ON SPLIT: OFF CH1: SUB MEAS: OFF CH2: SUB MEAS: OFF	
ACTIVE CH: CH2 DUAL CH: OFF SPLIT: OFF CH1: SUB MEAS: ON CH2: SUB MEAS: OFF		ACTIVE CH: CH2 DUAL CH: ON SPLIT: OFF CH1: SUB MEAS: ON CH2: SUB MEAS: OFF	
ACTIVE CH: CH2 DUAL CH: OFF SPLIT: ON CH1: SUB MEAS: ON CH2: SUB MEAS: OFF		ACTIVE CH: CH2 DUAL CH: ON SPLIT: ON CH1: SUB MEAS: ON CH2: SUB MEAS: OFF	

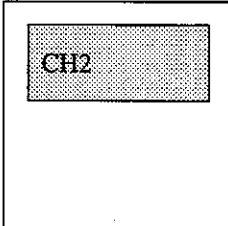
Setting conditions	Layout configuration
ACTIVE CH: CH2 DUAL CH: OFF SPLIT: ON CH1: SUB MEAS: OFF CH2: SUB MEAS: OFF	

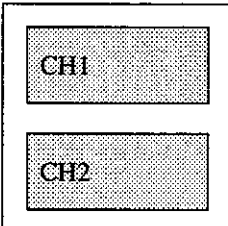
Setting conditions	Layout configuration
ACTIVE CH: CH2 DUAL CH: ON SPLIT: ON CH1: SUB MEAS: OFF CH2: SUB MEAS: OFF	

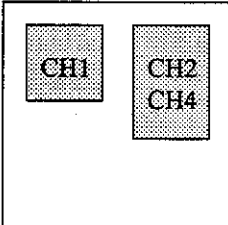
Setting conditions	Layout configuration
ACTIVE CH: CH2 DUAL CH: ON SPLIT: OFF CH1: SUB MEAS: OFF CH2: SUB MEAS: ON	

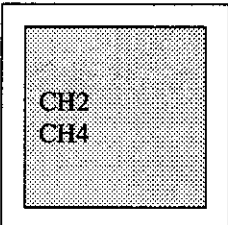
Setting conditions	Layout configuration
ACTIVE CH: CH2 DUAL CH: OFF SPLIT: OFF CH1: SUB MEAS: OFF CH2: SUB MEAS: ON	

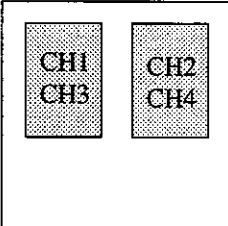
Setting conditions	Layout configuration
ACTIVE CH: CH2 DUAL CH: ON SPLIT: OFF CH1: SUB MEAS: ON CH2: SUB MEAS: ON	

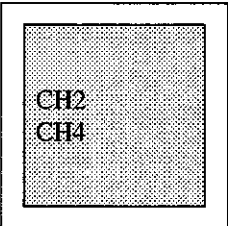
Setting conditions	Layout configuration
ACTIVE CH: CH2 DUAL CH: OFF SPLIT: OFF CH1: SUB MEAS: ON CH2: SUB MEAS: ON	

4. RESPONSE Block

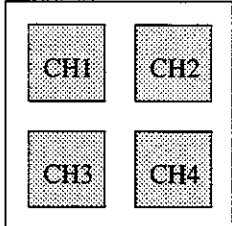
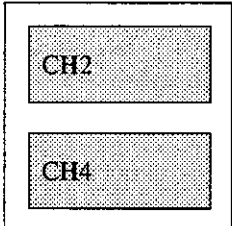
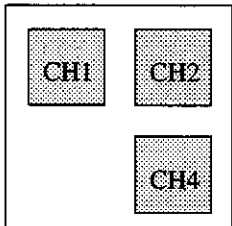
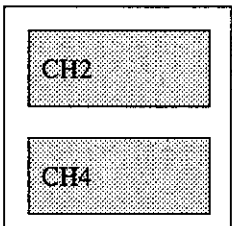
Setting conditions	Layout configuration	Setting conditions	Layout configuration
ACTIVE CH: CH2 DUAL CH: ON SPLIT: ON CH1: SUB MEAS: ON CH2: SUB MEAS: ON		ACTIVE CH: CH2 DUAL CH: OFF SPLIT: ON CH1: SUB MEAS: ON CH2: SUB MEAS: ON	
ACTIVE CH: CH2 DUAL CH: ON SPLIT: ON CH1: SUB MEAS: OFF CH2: SUB MEAS: ON		ACTIVE CH: CH2 DUAL CH: OFF SPLIT: ON CH1: SUB MEAS: OFF CH2: SUB MEAS: ON	



## ■ TRACE Operation

The trace operation is used to execute fundamental arithmetic operation between the measurement data and memory data.

### □ The Setting and the Explanation

1. Press the **[DISPLAY]** to call the display menu. (Refer to page A-11.)
2. Press the **[DEFINE TRACE [     ] ]** to call the trace operation.
3. Trace operation menu
  - [DATA/MEM]** : Executes the division of measurement data and memory data, then displays the result as the measurement data.
  - [DATA-MEM]** : Executes the subtraction of measurement data and memory data, then displays the result as the measurement data.
  - [DATA\*MEM]** : Executes the of multiplication of measurement data and memory data, then displays the result as the measurement data.
  - [DATA+MEM]** : Executes the addition of measurement data and memory data, then displays the result as the measurement data.
  - [OFF]** : Cancels the operation (calculation).

4. RESPONSE Block

■ Label Input

An annotation of measurement data and so on is input as a label. Maximum 64 characters can be input.

□ The Setting and the Explanation

1. Press the [DISPLAY] to call the display menu. (Refer to page A-11.)
2. Press the [More 1/2] .
3. Press the [LABEL] to call the label window and label menu.
4. Label menu

(Select the character of label menu by using the data knob, and press the [×1] .)

- [DONE] : Completes the label input.
- [CURSOR →] : Shifts the cursor indicating the label input position to the right.
- [CURSOR ←] : Shifts the cursor indicating the label input position to the left.
- [BACK SPACE] : Backspaces.
- [DELETE CHAR] : Deletes one character.
- [CLEAR LINE] : Deletes all characters.
- [CANCEL] : Cancels the edit.

Label Window Display

REG1															
	!	"	#	\$	%	&	'	()	*	+	,	-	.	/	0
1	2	3	4	5	6	7	8	9	:	;	<	=	>	?	@
A	B	C	D	E	F	G	H	I	J	K	L	M	N	O	P
Q	R	S	T	U	V	W	X	Y	Z	[	\	^	_	'	a
b	c	d	e	f	g	h	i	j	k	l	m	n	o	p	q
r	s	t	u	v	w	x	y	z				~			

## ■ Averaging/Smoothing and Resolution Bandwidth

Averaging [time average] and smoothing [moving average] are provided as the function which statistically reduces random errors that cannot be reproduced. (Refer to page 7-26 and 7-27.)

Narrow resolution bandwidth will reduce noise component, thus decreasing random errors. However, the case will increase the sweeping time.

### □ The Setting and the Explanation

1. Press the [AVG] to call the average menu. (Refer to page A-11.)

2. Average menu

**[AVG STATE ON/OFF]** :

Selects ON/OFF of averaging

**[AVG COUNT]** : Sets the number of times for averaging.

**[AVG RESTART]** :

Resets the averaging and restarts at the average time 1.

**[GROUP DELAY APERTURE]** :

Sets the aperture for group delay measurement. The aperture should be considered in the same manner as the smoothing aperture.

**[SMOOTHING ON/OFF]** :

Selects ON/OFF of smoothing.

**[SMOOTHING APERTURE]** :

Sets the smoothing aperture.

**[IF RBW [ ]]** :

Sets the resolution bandwidth.

Resolution bandwidth	Maximum sweeping per point
10kHz	0.15ms/POINTS
3kHz	0.40ms/POINTS
1kHz	1.0ms/POINTS
300Hz	3.4ms/POINTS
100Hz	10ms/POINTS
30Hz	131ms/POINTS
10Hz	384ms/POINTS
3Hz	1222ms/POINTS

## 4. RESPONSE Block

The following describes about averaging and smoothing.

● **Averaging**

In the averaging function, the measured data are averaged with time weight before formatting it. Since vector quantity is averaged, there also is an effect that reduces the noise level.

○ **Averaging process**

$$\bar{Y}(n) = \frac{n-1}{n} \times \bar{Y}(n-1) + \frac{1}{n} Y(n) \quad (n \leq N)$$

$$\bar{Y}(n) = \frac{N-1}{N} \times \bar{Y}(n-1) + \frac{1}{N} \times Y(n) \quad (n > N)$$

$\bar{Y}(n)$  : nth averaged data  
 $Y(n)$  : nth data not averaged yet  
 $N$  : Number of times for averaging

● **Smoothing**

The smoothing obtains the moving average between adjacent pieces of formatted data. Since scaler quantity is averaged, the noise width is reduced but the noise level will not be reduced.

○ **Smoothing process**

$$\bar{D}(n) = \frac{D(n-m) + \dots + D(n) + \dots + D(n+m)}{2m+1}$$

$\bar{D}(n)$  : nth format data already smoothed  
 $D(n)$  : nth format data not smoothed yet  
 $2m$  : Smoothing aperture

The aperture for the setting value is obtained using the following equation:

$$\text{Aperture} \langle 2m \rangle = \frac{(\text{measurement points}) - 1}{100} \times \langle \text{value} \rangle$$

That equation means that the aperture is set by the percentage for the number of the measurement points. Even if the number of the measurement points has been changed, the setting value of the aperture will be maintained and the aperture  $\langle 2m \rangle$  will be calculated again by the number of the measurement points after the change.

〈Example〉

Number of measurement points : 101(Point)

$$\text{Aperture : } 2(\%) \rightarrow \text{Aperture}(2m) = \frac{101-1}{100} \times 2 = 2$$



## 5. Calibration

There are six types of calibration methods to reduce the system errors, as follows:

- Normalizing .....(1) (Refer to page 7-28 and 7-32.)
- Normalizing & Isolation calibration .....(2) (Refer to page 7-29 and 7-33.)
- 1-port full calibration .....(3) (Refer to page 7-29 and 7-34.)
- 2-port full calibration .....(4) (Refer to page 7-30 and 7-36.)
- Averaging .....(5) (Refer to page 7-25.)
- Smoothing .....(6) (Refer to page 7-25.)

The methods of (1), (2), (3) and (4) are used to remove error factors which can be reproduced. These methods measure the standard whose real value has been known. The result is used to obtain the real value of the measurement according to the error model.

The methods of (5) and (6) are used to statistically reduce random errors by obtaining the time average and moving average respectively.

**NOTE:** The calibration methods of (1), (2), (3) and (4) can not be performed simultaneously. Since the methods of (5) and (6) can be independently operated, they can be performed simultaneously.

### ■ Normalizing

Calibrates the frequency characteristics of the amplitude and phase. This method can be easily performed but cannot obtain a high accuracy.

#### ● For measuring transfer

Calibrates the frequency characteristics including that on the connection cable and connector by connecting the through standard with the condition where any sample is removed. (Refer to page 7-32.)

#### ● For measuring reflection

An open standard or a short standard can be selected for the calibration standard. The frequency characteristics is calibrated in the reflection measurement by connecting the calibration standard. (Refer to page 7-32.)

Both the open standard and short standard are full reflection and the phase for the short standard is shifted by  $180^\circ$ .

For the open standard, make sure that the reflection measurement port is actually made open. For example, the calibration can be made when the measurement port is open (unloading condition) without the open standard for a calibrated N type connector.

However, if the open capacity is uncertain or if the open condition cannot be obtained because the measurement port is the line on the base board, the short standard should be used or the calibration should be made with the line made short.

## ■ Normalize & Isolation Calibration

In the measurement of the transmission characteristic, calibrate the frequency characteristics and the isolation. (Refer to page 7-33.)

The crosswalk from the signal source of this analyzer to the receiver section and the change for the worse of isolation caused by the jig connected between the test ports can be calibrated easily to enlarge the dynamic range.

- The frequency characteristic containing the cable and the connector is calibrated by connecting the through standards .
- The crosswalk characteristic is calibrated by connecting the load standard to the test port for the isolation characteristic.

Also the isolation of the jig for measurement can be calibrated as well.

## ■ 1-Port Full Calibration

Calibrates the directivity, source match, and frequency tracking in the reflection measurement. (Refer to page 7-34.)

This method highly accurately measures the reflection of a one port device or a two port device whose one end is terminated.

- Three kinds of calibration standards are required as follows:

- (1) Open standard
- (2) Short standard
- (3) Load standard

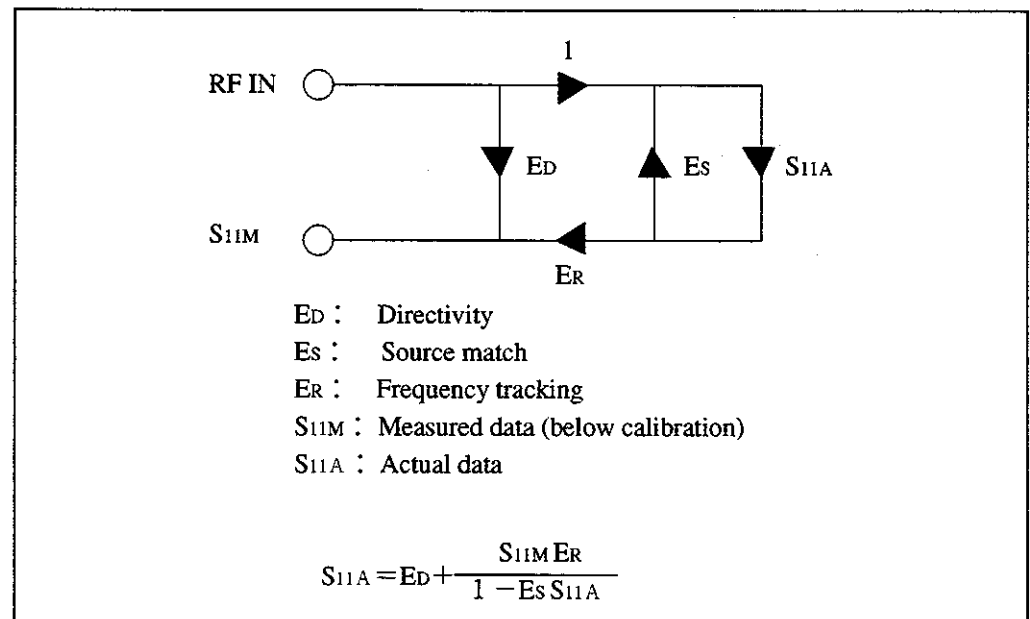

- The signal flow graph below shows the error model.

5. Calibration

- Directivity : The directivity connector/bridge which is used for the reflection measurement detects the reflection signal from the sample device. However, it actually detects not only the reflection signal but also a few incidence signals.  
The limitation where the reflection signal and the incidence signal can be separated is called a "directivity".
- Source match : The reflection signal from the sample device reflects at the signal source and is injected in the sample to make errors. The reflection coefficient at that signal source is called a "source match".
- Frequency tracking : Is the frequency characteristics of the measurement system including the cable and connector.

## ■ 2-Port Full Calibration

Calibrates the directivity of two port device forward and inverse direction, source match, load match, frequency tracking, and isolation. (Refer to page 7-36.)

All S parameters of 2-port device can be measured with the highest accuracy.

This calibration method can be performed only with R3765A/67A + S parameter test set and R3765C/3767C.

● The following four kinds of standard are needed for the calibration.

- (1) Open standard
- (2) Short standard
- (3) Load standard
- \* 2 pcs. are needed for the calibration of isolation.
- (4) Through standard

As the characteristics of both directions, forward and inverse, are needed for the execution of calibration, if the characteristic of one of the directions are to be measured, the characteristics of both directions are measured.

Therefore, for S<sub>21</sub> measurement, the sweeping is performed twice for the measurement of the forward direction and the inverse direction at the execution of 2-port full calibration.



●The following signal flow graph shows an error model.

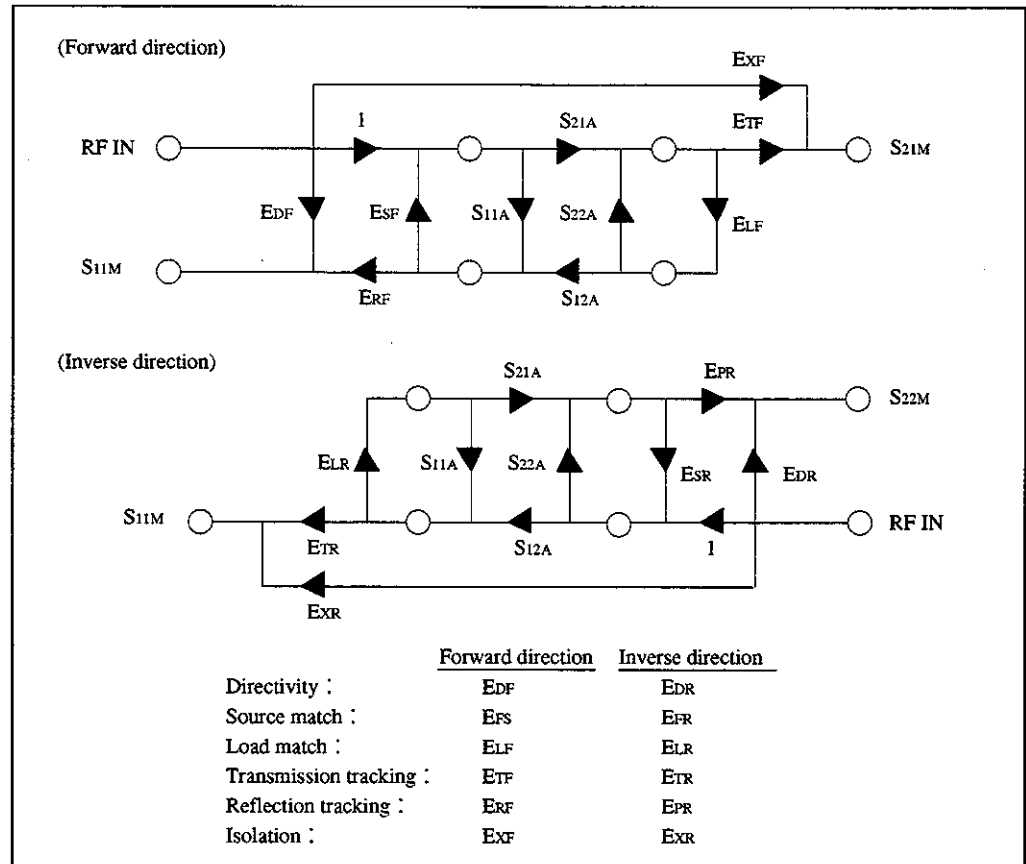

- Directivity :** The directional coupler/bridge for measurement of reflection detects a reflection signal from DUT.  
But actually it detects not only reflection signal but a little incident signal. The limitation that can separate this reflection signal from the incident signal is called "directivity".
- Source match :** The error is produced by the reflection signal from DUT which was reflected again from the signal source and then entered into DUT.  
The reflection coefficient in this signal source is called "source match".
- Load match :** The signal passed through DUT is input into the receiver section, where the signal is reflected according to the reflection coefficient of the receiver section.  
This reflected signal passes DUT again and returns to the signal source. Then produces an error.  
This reflection coefficient in the receiver section is called "load match".
- Transmission tracking :** It's the measurement frequency characteristics of transmission direction.
- Reflection tracking :** It's the measurement frequency characteristics of reflection direction.

5. Calibration

■ Calibration Method

● Normalizing (transfer)

□ The Setting and the Explanation

1. Set up the analyzer to the transfer measurement.
2. Connect a through standard between the measurement ports.
3. Press the [CAL] to call the calibration menu (1 of 2). (Refer to page A-12.)
4. Press the [NORMALIZE (THRU)] .  
The message "Wait for Sweep" is displayed and the calibration data are obtained. The calibration is completed when the message disappears. (See NOTE.)
5. Connects a sample to perform the measurement.

● Normalizing (reflection)

□ The Setting and the Explanation

1. Set up the analyzer to the reflection measurement.
2. Connect a open standard or a short standard to the measurement port.
3. Press the [CAL] to call the calibration menu (1 of 2). (Refer to page A-12.)
4. When the open standard is used, then press the [NORMALIZE (THRU)] .  
When the short standard is used, then press the [NORMALIZE (SHORT)] .  
The message "Wait for Sweep" is displayed and the calibration data are obtained. The calibration ends when the message disappears. (See NOTE.)
5. Connects a sample to perform the measurement.

- NOTE:**
1. Do not move the analyzer, the cable, the connector, the standard, and the others during the message "Wait for Sweep" is displayed.
  2. When the set condition is changed during the message is displayed, the message "Calibration aborted" is displayed and the current calibration data cannot be acquired.

**● Normalize & isolation calibration****□ The Setting and the Explanation**

1. Sets up the analyzer to the transmission measurement.
2. Press [CAL] to call the calibration menu (1 of 2).
3. Press [CAL MENUS] to call the full calibration selection menu.
4. Press [NORMALIZE & ISOL'N] to call the normalize & isolation calibration menu.
5. Connect the through standard between the test ports and press [THRU].  
The message "Wait for Sweep" is displayed and the calibration data is obtained. The calibration is completed when the message disappears. (See NOTE.)
6. Connect the load standard to each test port and press [ISOLATION].  
The message "Wait for Sweep" is displayed and the calibration data is obtained. The calibration is completed when the message disappears. (See NOTE.)
7. Press [DONE NORM & ISO] to complete the calibration of the normalize & isolation calibration.
8. Connect DUT to perform the measurement.

- NOTE:**
1. Do not move the analyzer, the cable, the connector, the standard, and the others when the message "Wait for Sweep" is displayed.
  2. When the set condition is changed during the message is displayed, the message "Calibration aborted" is displayed and the current calibration data cannot be acquired.

5. Calibration

● 1-port full calibration

□ The Setting and the Explanation

1. Sets the analyzer to the reflection measurement.
2. Press the [CAL] to call the calibration menu (1 of 2). (Refer to page A-12.)
3. Press the [CAL MENUS] to call the full calibration selection menu.
4. Press the [1PORT FULL CAL] to select the 1-port full calibration selection menu, and call the 1-port full calibration menu.
5. Connect the open standard to the measurement port and press the [OPEN] .  
The message "Wait for Sweep" is displayed and the calibration data are obtained. The calibration is completed when the message disappears. (See NOTE.)
6. Connect the short standard to the measurement port and press the [SHORT] .  
The message "Wait for Sweep" is displayed and the calibration data are obtained. The calibration is completed when the message disappears. (See NOTE.)
7. Connect the long standard to the measurement port and press the [LOAD] .  
The message "Wait for Sweep" is displayed and the calibration data are obtained. The calibration is completed when the message disappears. (See NOTE.)
8. Press the [DONE 1-PORT] to execute the 1-port full calibration.
9. Connect a sample to perform the measurement.

- NOTE:**
1. Do not move the analyzer, the cable, the connector, the standard, and the others when the message "Wait for Sweep" is displayed.
  2. When the set condition is changed during the message is displayed, the message "Calibration aborted" is displayed and the current calibration data cannot be acquired.

---

**A D V I C E**

1. When the measurement has already been executed, set the calibration setting to OFF and clear the measurement data, then restart the calibration. The full calibration cannot perform the measurement operation to prevent the calibration data loss by miss operation during the calibration or if the data existed. (Refer to page 7-47.)
  2. Each calibration data can be obtained again before pressing the **[DONE 1-PORT]** .
  3. When the sweep condition is changed before **[DONE 1-PORT]** pressed, the message "Calibration canceled" is displayed and the calibration data is cleared.
-

5. Calibration

● 2-port full calibration

\* It can be performed only with R3765A/67A + S parameter test set and R3765C/67C.

□ The Setting and the Explanation

1. Press [CAL] to call the calibration menu (1 of 2). (Refer to page A-12.)
2. Press [CAL MENUS] to call the full calibration selection menu.
3. Pressing [2 PORT FULL CAL] selects the 2-port calibration to call the 2-port full calibration menu.

---

A D V I C E

1. When the measurement has already been executed, set the calibration setting to OFF and clear the measurement data, then restart the calibration.
2. During the calibration or if the data exists, the full calibration cannot perform the measurement operation to prevent the calibration data loss by miss operation. (Refer to page 7-47.)
3. When the sweep condition is changed before [DONE 2-PORT] pressed, the message "Calibration canceled" is displayed and the calibration data is cleared.

- 
4. Press [REFLECT'N] to call the 2-port reflection menu.
  5. Connect the open standard to port 1 (forward direction reflection measurement port) and press [S11 OPEN] .  
The message "Wait for Sweep" is displayed and the calibration data is obtained. The calibration is completed when the message disappears.

- NOTE:**
1. Do not move the analyzer, the cable, the connector, the standard, and the others during the message "Wait for Sweep" is displayed.
  2. When the set condition is changed during the message is displayed, the message "Calibration aborted" is displayed and the current calibration data cannot be acquired.

6. Connect the short standard to port 1 (forward direction reflection measurement port) and press **【S11 SHORT】** .  
The message "Wait for Sweep" is displayed and the calibration data is obtained. The calibration is completed when the message disappears. (See NOTE.)
7. Connect the load standard to port 1 (forward direction reflection measurement port) and press **【S11 LOAD】** .  
The message "Wait for Sweep" is displayed and the calibration data is obtained. The calibration is completed when the message disappears. (See NOTE)
8. Connect the open standard to port 2 (inverse direction reflection measurement port) and press **【S22 OPEN】** .  
The message "Wait for Sweep" is displayed and the calibration data is obtained. The calibration is completed when the message disappears. (See NOTE.)
9. Connect the Short standard to port 2 (inverse direction reflection measurement port) and press **【S22 SHORT】** .  
The message "Wait for Sweep" is displayed and the calibration data is obtained. The calibration is completed when the message disappears. (See NOTE)
10. Connect the load standard to port 2 (inverse direction reflection measurement port) and press **【S22 LOAD】** .  
The message "Wait for Sweep" is displayed and the calibration data is obtained. The calibration is completed when the message disappears. (See NOTE.)

- NOTE :**
1. Do not move the analyzer, the cable, the connector, the standard, and the others during the message "Wait for Sweep" is displayed.
  2. When the set condition is changed during the message is displayed, the message "Calibration aborted" is displayed and the current calibration data cannot be acquired.

5. Calibration

11. Pressing **[DONE REFLECT'N]** executes the reflection calibration.  
When the reflection calibration is completed, returns to the 2-port full calibration menu.

---

**AD V I C E**

The calibration data of each calibration standard can be acquired again before **[DONE REFLECT'N]** pressed.

---

12. Press **[TRANSMISSION]** to call the 2-port transmission menu.
13. Connect the through standard between port 1 and port 2.
14. Press **[GROUP THRU]** .  
The message "Wait for Sweep" is displayed and the calibration data is obtained. The calibration is completed when the message disappears. (See NOTE.)  
When this operation is performed, the following operation of step 15 to 18 is not necessary.
15. Press **[FWD.TRANS THRU]** .  
The message "Wait for Sweep" is displayed and the calibration data is obtained. The calibration is completed when the message disappears. (See NOTE.)

- NOTE:**
1. Do not move the analyzer, the cable, the connector, the standard, and the others during the message "Wait for Sweep" is displayed.
  2. When the set condition is changed during the message is displayed, the message "Calibration aborted" is displayed and the current calibration data cannot be acquired.



16. Press **[FWD. MATCH THRU]** .  
The message "Wait for Sweep" is displayed and the calibration data is obtained. The calibration is completed when the message disappears. (See NOTE.)
17. Press **[REV. TRANS THRU]** .  
The message "Wait for Sweep" is displayed and the calibration data is obtained. The calibration is completed when the message disappears. (See NOTE.)
18. Press **[REV. MATCH THRU]** .  
The message "Wait for Sweep" is displayed and the calibration data is obtained. The calibration is completed when the message disappears. (See NOTE.)
19. Pressing **[DONE TRANS]** executes transmission calibration.  
Returns to 2-port calibration menu when the transmission calibration is completed.

**NOTE:**

1. Do not move the analyzer, the cable, the connector, the standard, and the others during the message "Wait for Sweep" is displayed.
2. When the set condition is changed during the message is displayed, the message "Calibration aborted" is displayed and the current calibration data cannot be acquired.

---

**A D V I C E**

The calibration data of each calibration standard can be acquired again before **[DONE TRANS]** pressed.

---

5. Calibration

20. Press **[ISOLATION]** to call the 2-port isolation menu.

21. In case the isolation omitted.

Press **[OMIT ISOLATION]** and then **[DONE ISOLATION]** .

Isolation calibration

(1) Connect the load standard to port 1 and port 2.

(2) Press **[FMD ISOL'N]** .

The message "Wait for Sweep" is displayed and the calibration data is obtained. The calibration is completed when the message disappears. (See NOTE.)

(3) Press **[REV ISOL'N]** .

The message "Wait for Sweep" is displayed and the calibration data is obtained. The calibration is completed when the message disappears. (See NOTE.)

22. Press **[DONE ISOLATION]** .

Executes the isolation calibration and returns to the 2-port full calibration menu.

- NOTE:**
1. Do not move the analyzer, the cable, the connector, the standard, and the others during the message "Wait for Sweep" is displayed.
  2. When the set condition is changed during the message is displayed, the message "Calibration aborted" is displayed and the current calibration data cannot be acquired.

---

**A D V I C E**

The calibration data of each calibration standard can be acquired again before **[DONE ISOLATION]** pressed.

---

23. Press **[DONE 2-PORT]** .

Executes 2-port full calibration.

## ■ Interpolation of Calibration Data (Calibration Interpolate)

When **[INTERPOLATE ON/OFF]** is set to ON, the calibration data is performed the interpolation error compensation measurement even if the stimulus setting such as (1), (2), and (3) shown below is changed during error compensation measurement (during calibration).

- (1) Change of the sweep range (within the calibration range)
- (2) Change of the sweep type (within the constraints)
- (3) Change of the sweep point number

Table 7-1 Combination of Interpolatable Sweep Type (o; possible, x; impossible)

The sweep type at the calibration The sweep type at the present	Linear Sweep	Log Sweep	User Sweep	Program Sweep	Power Sweep
	Linear Sweep	○	×	×	×
Log Sweep	○	○	×	×	×
User Sweep	○	×	×	×	×
Program Sweep	○	×	×	×	×
Power Sweep	○*1	×	×	×	○*2

\*1 : Obtain the calibration data (1 point) corresponding to CW frequency from the linear sweep frequency range at the calibration and make all the points to the same calibration data.  
Compensate with the output level only when CW frequency is the same.

\*2 : The status display beside the scale showing the calibration status shows the following meaning.

Compensate with the output level only when CW frequency is the same.

The status display beside the scale showing the calibration status shows the following meaning.

Table 7-2 Status Display

	Normalize	Normalize & Isolation	1-port Cal.	2-port Cal.
Normal compensation	"Cor"	"Cor"	"Cor"	"C2"
Interpolative compensation	"C?"	"C?"	"C?"	"C2?"
Abnormal compensation	"C!"	"C!"	"C!"	"C2!"

Normal compensation : When all the setting conditions are the same as of the calibration data acquired.

Interpolative compensation : When the interpolation is possible and it is performed though the setting conditions are different.

Abnormal compensation : When the setting conditions are different and the calibration data which is acquired with interpolation of impossible is used as it is.

5. Calibration

---

**A D V I C E**

When the interpolation is impossible, the sweep range is out of the calibration, or the setting is INTERPOLATE OFF, "C!" is displayed and the acquired calibration data is used as it is.

But when the following setting is made, the calibration (CORRECT) is switched to OFF, and it becomes impossible to switch ON the calibration (CORRECT) again.

- (1) When the number of points are changed and furthermore the sweep range is out of the calibration range.
  - (2) When the setting is made as shown by X in Figure 7-1 of the previous page.
  - (3) When the setting of CW frequency is out of the calibration range in the setting of \*1 in Figure 7-1.
- 

**■ Calibration Kit Selection**

Select CAL KIT when the calibration is performed.

The Setting and the Explanation

1. Press [CAL] to call the calibration menu (1 of 2). (Refer to page A-12.)
2. Press [CAL MENUS] to call the selection menu of full calibration.
3. Press [CAL KIT] to call the cal kit menu. (Go to step 4.)

#### 4. Cal kit menu

- [N (50 Ω)]** : Compensate the error of N type 50 Ω connector open capacity and electrical length. Calls FEMAL/MAL selection menu. (Go to step 5.)
- [N (75 Ω)]** : Compensate the error of N type 75 Ω connector open capacity and electrical length. Calls FEMAL/MAL selection menu. (Go to step 5.)
- [3.5 mm]** : Compensate the error of 3.5mm connector open capacity and electrical length. Calls FEMAL/MAL selection menu. (Go to step 5.)
- [7 mm]** : Compensate the error of 7mm connector open capacity and electrical length. The 7mm connector does not have distinction of FEMAL and MAL.
- [USER DEFINE]** : Compensate the error of the user-defined open capacity and electrical length. In order to input this parameter, an application software is required.
- [DON'T CARE]** : It is used when error compensation is not performed with the connector.

#### 5. FEMAL/MAL selection menu

- [PORT 1 FEMAL/MAL]** :  
Sets FEMAL/MAL of the port 1 connector.
- [PORT 2 FEMAL/MAL]** :  
Sets FEMAL/MAL of the port 2 connector.

---

#### A D V I C E

The setting of the cal kit is effective in 1 port and 2 port full calibration. As the compensation data is calculated by using this set parameter when **[DONE]** is pressed at each calibration, if the setting of cal kit is changed after the **[DONE]** pressed, it has no effect on the calibration.

---

## ■ Extending Measurement Reference Surface

Is the function which moves the calibration surface to the end of the cable when the extension cable is connected to the test port after calibration. The function calibrates the addition of the electrical length, assuming that the cable having no loss completely has been added. That is, it obtains the phase characteristics only for a sample by calibrating the phase shift for the addition.

### ● Electrical length calibration

Calibrates the electrical length which has been set to the measurement data. The measurement port type is not identified. It can be used not only for calibration but also measuring the electrical length of the cable. Also, it can be used to measure flatness of the phase by removing phase change due to the electrical length of the actual sample.

### ● Port extension

Measurement is made, assuming that the extension cable with the electrical length already set is connected to the measurement port. That is, the electrical length already set is automatically calibrated according to the change of the measurement port. For example, if a calibration value 10ns is set to the port 1 and a value 20ns is set to the port 2 when S parameter test-set is used, the calibration is automatically made as follows:

For S11 measurement: (PORT 1)×2=20ns

For S21 measurement: (PORT 1)+(PORT 2)=30ns

### ● Phase offset

This function does not calibrate the electrical length. It adds a constant phase value as an offset regardless of the frequency.

### ● Transfer constant ( $V_r$ )

Sets the transfer constant value to be used to calculate the electrical length. The initial setting is  $V_r=1$ .

$$V_r = \frac{1}{(\epsilon_R)^{1/2}}$$

### ● Phase offset value/compensation value

$$\begin{aligned}\Phi \text{ (deg)} &= \frac{L}{c} \times \frac{1}{V_r} \times f \times 360 \\ &= S \times f \times 360\end{aligned}$$

$V_r$ :	Transfer constant
$L$ :	Electrical length (distance)
$c$ :	Light speed
$S$ :	Electrical length (time)
$f$ :	Frequency
$\epsilon_R$ :	Dielectric constant

The Setting and the Explanation

● Calibration menu (2 of 2) includes the menu with which the reference surface is extended.

1. Press the [CAL] to call the calibration menu (1 of 2). (Refer to page A-12.)
2. Press the [More 1/2] to call the calibration menu (2 of 2).
3. Calibration menu (2 of 2)

[ELEC DELAY ON/OFF] : Selects ON/OFF of the electrical length calibration.

[ELECTRICAL DELAY] : Sets the calibration value for the electrical length in a unit of time.

[ELECTRICAL LENGTH] : Sets the calibration value for the electrical length in a unit of distance.

[VELOCITY FACTOR] : Sets the transfer constant value.

[PHASE OFFSET VALUE] : Sets the phase offset value.

[PORT EXTENSION] : Calls the port extension menu. (Go to step 4.)

5. Calibration

4. Port extension menu

●For R3765A/3767A+S parameter, R3765B/3767B, R3765C/3767C

**[EXTENSION ON/OFF]** : Selects ON/OFF of the port extension.

**[EXTENSION INPUT R]** : Sets the value of the input port R extension by time.

**[EXTENSION INPUT A]** : Sets the value of the input port A extension by time.

**[EXTENSION INPUT B]** : Sets the value of the B input port B extension by time.

**[EXTENSION PORT 1]** : Sets the value of the S parameter test-set port 1 extension by time.

**[EXTENSION PORT 2]** : Sets the value of the S parameter test-set port 2 extension by time.

●For R3765A/3767A

**[EXTENSION ON/OFF]** : Selects ON/OFF of the port extension.

**[EXTENSION INPUT R]** : Sets the value of the input port R extension by time.

**[EXTENSION INPUT A]** : Sets the value of the input port A extension by time.

**[EXTENSION INPUT B]** : Sets the value of the B input port B extension by time.



## ■ Calibration Data Clear

Once the calibration is executed, the **【CORRECT ON/OFF】** which indicates the calibration being executed is set to ON. For re-calibration, the calibration data must be cleared.

**NOTE:** Re-calibration operations differ between the case of normalize and the case of normalize & isolation calibration and full calibration.

● For normalize

Whether calibrated or not, the data is re-calibrated by pressing the **【NORMALIZE】**.

**NOTE:** The normalize calibration data is overwritten by the re-calibration operation so that the function for creating the calibration data is not provided.

● The case of normalize & isolation calibration and full calibration

If the calibration data of the normalize & isolation calibration and full calibration has already been existed, in either case the calibration ON or OFF, the re-calibration cannot be executed. To re-calibrate the data, the data must be cleared.

The calibration data cannot be cleared during the calibration operation in order to prevent miss operation. But if the sweeping condition is changed during the calibration, the data can be cleared forcefully because the sweeping condition of each acquired calibration data is changed.

## □ The Setting and the Explanation

1. Press the **【CAL】** to call the calibration menu (1 of 2). (Refer to page A-12.)
2. Sets the **【CORRECT ON/OFF】** to OFF.
3. Press the **【CAL MENUS】** to call the full-calibration selection menu.
4. Press the **【CLEAR CAL DATA】** to clear the calibration data.
5. Select any one of 1-port/2-port full calibration and enter the calibration operation.

---

### ADVICE

If the **【CORRECT ON/OFF】** is set to OFF, unless the calibration data is not cleared, the calibration can be set to ON again.

---

## 6. Marker Function

The value of the data displayed can be read out with the marker. Also, the marker can find out the maximum or minimum value and change the settings of the signal source and the display.

Up to ten markers can be set for the sub measure screen of each channel.

One of the ten markers per channel is set to the active marker. The change of the marker setting is made to the active marker.

The values on active marker is always displayed in the specified position on the screen.

Also, the marker list function can display all the values on other markers than the active marker at the same time.

- [MKR] : Calls a marker menu to set a marker.  
[MKR→] : Calls a marker search menu for a marker analysis.

●An active marker and a normal marker are shown in the following.

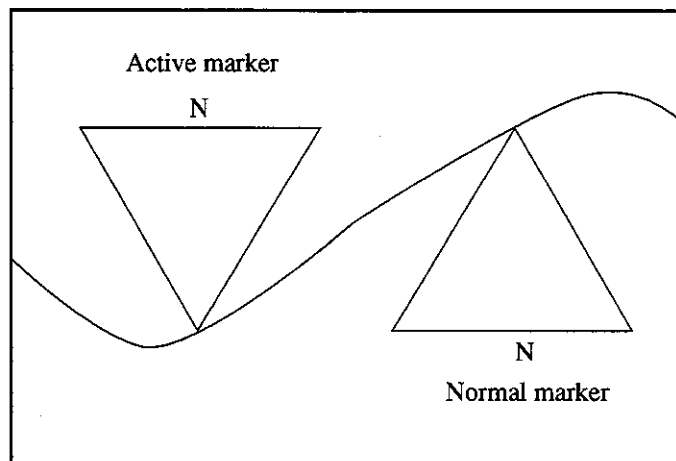

N : Marker number (value of 1 to 10.)

## ■ Setting Marker

Up to ten markers can be set for each channel and the marker which is displayed at the marker area on the screen is called an "active marker".

This function sets the active marker or changes the marker already set.

### □ The Setting and the Explanation

1. Press the [MKR] to call the marker menu. (Refer to page A-13.)
2. Press the [ACTIVATE MARKER [     ]] to call the active marker menu.
3. Active marker menu

#### ● Active marker menu (1 of 2)

[MARKER 1] : Sets the marker 1 for the active menu.

[MARKER 2] : Sets the marker 2 for the active menu.

[MARKER 3] : Sets the marker 3 for the active menu.

[MARKER 4] : Sets the marker 4 for the active menu.

[MARKER 5] : Sets the marker 5 for the active menu.

[ACTIVATE MKR OFF] :

Sets off only the active marker.

If plural markers are set, a marker of the smallest number becomes an active marker.

Only when a marker frequency is displayed in the active area, its marker is controlled with the ten - key and the UP/DOWN key.

#### ● Active marker menu (2 of 2)

[MARKER 6] : Sets the marker 6 for the active menu.

[MARKER 7] : Sets the marker 7 for the active menu.

[MARKER 8] : Sets the marker 8 for the active menu.

[MARKER 9] : Sets the marker 9 for the active menu.

[MARKER 10] : Sets the marker 10 for the active menu.

[ACTIVATE MKR OFF] :

Sets off only the active marker.

## ■ Marker Coupling between Channels

The analyzer has two channels. The function is used to select if the markers are interlocked between the channels or not.

"Marker interlock between channels" means that the marker which has been set for the active channel is automatically set for the non-active channel regardless of ON/OFF of the dual channel display. "Non-interlock" means that the markers are made to independently operate for each channel.

### □ The Setting and the Explanation

1. Press the [MKR] to call the marker menu. (Refer to page A-13.)
2. Press the [MARKER MODE MENU] to call the marker mode menu.
3. Press the [MKR CPL/UNCPL] to select the marker coupling between the channels.
  - CPL : Coupling ON (interlock between channels)
  - UNCPL : Coupling OFF (non interlock between channels)

If sweep time satisfies the following conditions, even if the MKR CPL is specified, a marker is not coupled.

- (1) When the sweep type of either of CH1 or CH2 is set to the USER SWEEP or the PROGRAM SWEEP.
- (2) When both a frequency sweep and a level sweep are set simultaneously.
- (3) When CH 1/2 is set to the zero span mode.

#### ● For MKR UNCPL

Only a marker on the active channel moves independently.

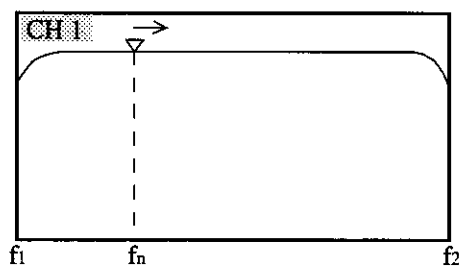

$f_n$  ; Active marker frequency

#### ● For MKR CPL

A marker on the inactive channel moves to  $f_n$ , coupled to the marker at  $f_n$  on the active channel.

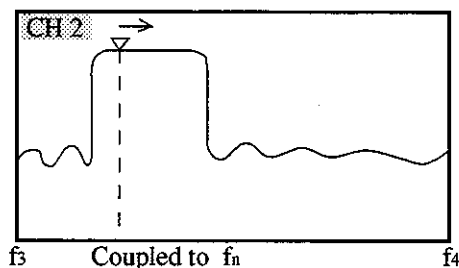

## ■ Interpolation between Measurement

The marker can be assigned to either of one mode that sets markers and reads data of each marker by interpolating linearly between measuring points and another mode that sets markers to only actual measuring points.

### □ The Setting and the Explanation

1. Press the [MKR] to call the marker menu. (Refer to page A-13.)
2. Press the [MARKER MODE MENU] to call the marker mode menu.
3. Interpolation between measurement points is selected by [MKR CMP/UNCMP] .

CMP : Interpolation ON

UNCMP : Interpolation OFF

When the sweep type is set to USER SWEEP/PROG SWEEP, even if CMP is selected, the interpolation depends on the number of set points.

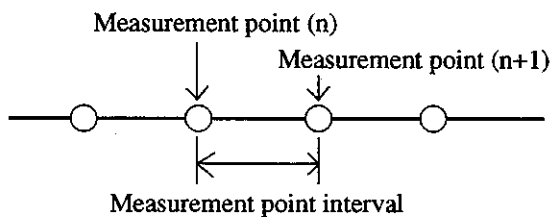

## 6. Marker Function

**■ Displaying Marker Read out Value**

The marker value displayed on the screen always indicates the active marker. To display other than that marker, use the marker list function to list all the marker settings at a time.

 The Setting and the Explanation

1. Press the [MKR] to call the marker menu. (Refer to page A-13.)
2. Press the [MKR LIST ON/OFF] to select ON/OFF of the marker list display.

**■ Delta-Marker Function**

The delta-marker function is used to find out the difference between the active marker and the specified marker. Three kinds of modes are available depending on the marker to be specified, as follows:

**●  $\Delta$  MKR mode**

Obtains the difference between the child and active markers by setting the child marker to the position of the active marker. The difference between the current position and the previous position (child marker) can be obtained by moving the active marker.

**● ACT MKR mode**

Obtains the difference between the active marker and the other marker.

**● FIXED MKR mode**

Obtains the difference between the active marker and the fixed marker by freely setting the fixed marker regardless of the trace data. The fixed marker is set with the stimulus and response values.

However, the fixed marker is always fixed to the position of the stimulus and response values regardless of the trace data.

The response values for the other markers including the child marker are on the trace data.

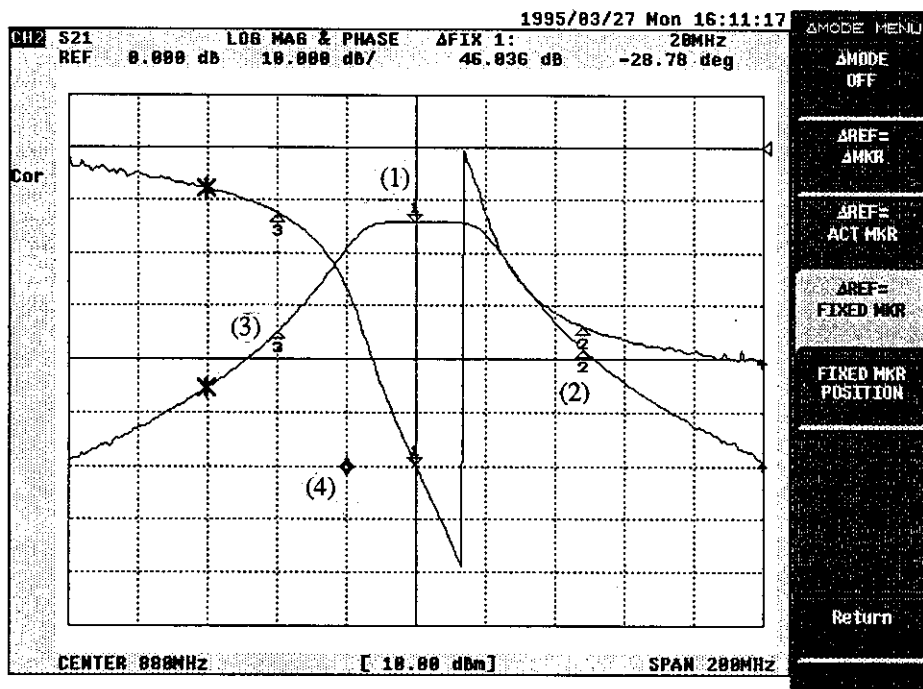

Figure 7-1 Delta-Marker Function

- $\Delta$ REF= $\Delta$ MKR : The delta value of active marker (1) and the child marker (3) is measured.
- $\Delta$ REF=ACT MKR : The delta values of active marker (1) and compare marker (2) is measured.
- $\Delta$ REF=FIXED MKR : The delta value of active marker (1) and the Fixed marker (4) is measured.

#### The Setting and the Explanation

1. Press the [MKR] to call the marker menu. (Refer to page A-13.)
2. Press the [ $\Delta$ MODE MENU] to call the delta-mode menu.
3. Delta mode menu
  - [ $\Delta$ MODE OFF] : Sets OFF the delta mode.
  - [ $\Delta$ REF= $\Delta$ MKR] : Selects the  $\Delta$ MKR mode. (Go to step 4.)
  - [ $\Delta$ REF=ACT MKR] : Selects the ACT MKR mode to call the ACT MKR menu. (Go to step 5.)
  - [ $\Delta$ REF=FIXED MKR] : Selects the FIXED MKR mode.
  - [FIXED MKR POSITION] : Calls the FIXED MKR setting menu. (Go to step 6.)

## 6. Marker Function

4. For  $\Delta$  MKR mode

Pressing the **【 $\Delta$  REF=  $\Delta$  MKR】** in step 3 causes the child marker (\*) to be displayed on the active marker position and the result to be displayed at the active area on the screen.

Since the active marker setting can be changed, obtain the data by moving the active marker using the data knob.

## 5. For ACT MKR mode

Pressing the **【 $\Delta$  REF= ACT MKR】** in step 3 calls the ACT MKR menu. Set the marker for comparison. Since the menu has also the software menu to change the active marker, it is possible to change the active marker without returning to the **【MKR】**.

## ●ACT MKR menu(1 of 2)

**【COMPARE MARKER 1】** :

Changes the marker for comparison to the marker 1.

**【COMPARE MARKER 2】** :

Changes the marker for comparison to the marker 2.

**【COMPARE MARKER 3】** :

Changes the marker for comparison to the marker 3.

**【COMPARE MARKER 4】** :

Changes the marker for comparison to the marker 4.

**【COMPARE MARKER 5】** :

Changes the marker for comparison to the marker 5.

**【ACTIVATE MARKER [     ]】** :

Calls the active marker menu. (Refer to page 7-49.)

## ●ACT MKR menu (2 of 2)

**【COMPARE MARKER 6】** :

Changes the marker for comparison to the marker 6.

**【COMPARE MARKER 7】** :

Changes the marker for comparison to the marker 7.

**【COMPARE MARKER 8】** :

Changes the marker for comparison to the marker 8.

**【COMPARE MARKER 9】** :

Changes the marker for comparison to the marker 9.

**【COMPARE MARKER 10】** :

Changes the marker for comparison to the marker 10.

**【ACTIVATE MARKER [     ]】** :

Calls the active marker menu. (Refer to page 7-49.)



## 6. For FIXED MKR mode

Pressing the **【 $\Delta$  REF= FIXED MKR】** in step 3 displays the difference between the active MKR and the FIXED MKR ( $\diamond$ ) on the active area of the screen.

To set the FIXED MKR position, press the **【FIXED MKR POSITION】** on the same menu to call the FIXED MKR setting menu.

**●** FIXED MKR setting menu

**【FIXED MKR STIMULUS】** : Sets the FIXED MKR stimulus value.

**【FIXED MKR VALUE】** : Sets the FIXED MKR response value.

**【FIXED MKR AUX VALUE】** : Sets the response value (that is, the imaginary part) of FIXED MKR in the display of a smith chart and polar coordinate.

**【FIXED MKR  $\rightarrow$  ACTIVE MKR】** :

Sets the FIXED MKR to the active marker position.

If changing the stimulus value, reference value, or others cause the fixed marker to move outside the screen, the fixed marker is not displayed.

The fixed marker can be displayed and set even if the delta mode is off.

If a parameter other than "1/S" has been set to CONVERSION ON in the measure or parameter conversion menu, the fixed marker can not be set nor displayed.

※FIXED MKR STIMULUS/VALUE/AUX VALUE can be set only with the ten-key.

## ■ Marker Menu during Impedance Measurement

The marker menu can select the impedance from three modes (parameter conversion, Smith chart display, polar coordinate) during parameter conversion or impedance measurement by the marker to directly read the impedance.

### □ The Setting and the Explanation

1. Press the **[MKR]** to call the marker menu. (Refer to page A-13.)
2. Press the **[MARKER MODE MENU]** to call the marker mode menu.
3. Marker mode menu
  - [CONVERSION MKR MENU [     ]]** :  
Calls the conversion marker menu which sets the marker data display mode during the parameter conversion. (Go to step 4.)
  - [SMITH MKR MENU [     ]]** :  
Calls the Smith marker menu which sets the marker data display mode during the Smith chart display. (Go to step 5.)
  - [POLAR MKR MENU [     ]]** :  
Calls the menu which sets the marker data display mode during the polar coordinate display. (Go to step 6.)
4. Conversion marker menu
  - [DEFAULT]** : Displays the value corresponding to the data format.
  - [LIN MKR]** : Displays the liner amplitude value and the phase value.  
When a format is selected except SMITH and POLAR in the format menu, if SMOOTHING is set to ON, a correct value can not be obtained.
  - [Re/Im MKR]** : Displays the complex data.  
When some format is selected except SMITH and POLAR in the format menu, if SMOOTHING is set to ON, a correct value can not be obtained.

## 5. Smith marker menu

- [LIN MKR]** : Displays the liner amplitude value and the phase value.
- [LOG MKR]** : Displays the logarithm amplitude value and the phase value.
- [Re/Im MKR]** : Displays the complex data.
- [R+jX MKR]** : Displays the complex impedance.
- [G+jB MKR]** : Displays the complex admittance.
- [ZO VALUE]** : Sets the characteristic impedance.

## 6. Polar marker menu

- [LIN MKR]** : Displays the liner amplitude value and the phase value.
- [LOG MKR]** : Displays the logarithm amplitude value and the phase value.
- [Re/Im MKR]** : Displays the complex data.
- [ZO VALUE]** : Sets the characteristic impedance.

## ■ Marker Analysis Function

The marker analysis function has the search functions for obtaining the values such as maximum value and minimum value.

This function also provide the functions to change the signal source and the display scale setting by the marker value.

● The following items are provided for search functions:

- (1) Maximum value
- (2) Minimum value
- (3) Phase : 0 deg
- (4) Phase :  $\pm 180$  deg
- (5) Specified response value (amplitude, phase)
- (6) Filter analysis (bandwidth, Q, shaping factor)

To perform the analysis operation, two modes are provided. Select any one of the mode for only one execution, or the mode for repeating every sweeping. The analysis area is selected the all measurement area, or the part search mode performing within the area specified by the marker delta mode.

---

### A D V I C E

Searching is basically performed to the displayed data, but

- The case that phase  $0^\circ$  or phase  $\pm 180^\circ$  was selected when the phase data was not displayed
- The SMITH/POLAR case

In the above cases, the displayed data is not searched but the internal data.

---

### □ The Setting and the Explanation

1. Press the [MKR →] to call the marker search menu. (Refer to page A-14.)
2. Marker search menu  
(This menu is used to change the signal source or the display scale.)

- |                             |  |
|-----------------------------|--|
| 【MARKER → START】 :          | Changes the sweep-start value of the signal source to the active marker position.            |
| 【MARKER → STOP】 :           | Changes the sweep-stop value of the signal source to the active marker position.             |
| 【MARKER → CENTER】 :         | Changes the sweep-center value of the signal source to the active marker position.           |
| 【 $\Delta$ MARKER → SPAN】 : | Changes the span of the signal source to the area specified by the $\Delta$ MARKER.          |
| 【MARKER → REF. VALUE】 :     | Changes the reference value of the display scale to the response value of the active marker. |

- [PART SRCH [ ]]** : Calls the part search menu. (Go to step 7.)  
**[MKR SEARCH [ ]]** : Calls the search menu. (Go to step 3.)

### 3. Search menu

- [MKR SEARCH OFF]** :  
The search function is released.
- [MAX]** :  
Moves the active marker to the position of maximum value.  
If the FORMAT is SMITH/POLAR, the active marker moves to the maximum value position of the internal LOGMAG data.
- [MIN]** :  
Moves the active marker to the position of minimum value.  
If the FORMAT is SMITH/POLAR, the active marker moves to the minimum value position of the internal LOGMAG data.
- [TARGET]** :  
Calls the target menu which searches the specified value. (Go to step 4.)
- [RIPPLE]** :  
Calls the ripple menu which searches the ripple. (Go to step 5.)
- [FLTR ANAL]** :  
Calls the filter analysis menu. (Go to step 6.)
- [TRACKING ON/OFF]** :  
Selects the function for searching every sweep.  
OFF : Searches one time.  
ON : Searches every sweep. When ON is selected, the search is performed on the search menu, and the search is repeated/executed every sweep.

---

#### A D V I C E

If MAX search and MIN search is performed when FORMAT is SMITH/POLAR, the searched position may not be the same as the display when SMOOTHING is ON.

Because the SMOOTHING is performed to the display data but not to the internal LOGMAG data.

---

6. Marker Function

4. Target menu

- [TARGET VALUE]** : Searches the specified value (response value).  
If SMITH or POLAR is set in the format menu, LOG MAG type of data is searched as TARGET VALUE.  
However, if SMOOTHING is set to ON, the active marker does not move to a correct data.
- [0° ]** : Searches the phase 0° .  
The phase data is surely searched without regard to any format.  
If SMOOTHING is set to ON, the active marker does not move to a correct data.
- [±180° ]** : Searches the phase 180° .  
The phase data is surely searched without regard to any format.  
If SMOOTHING is set to ON, the active marker does not move to a correct data.
- [LEFT SEARCH]** : Searches specified value of left side from current mark position.
- [RIGHT SEARCH]** : Searches specified value of right side from current mark position.
- 

A D V I C E

1. When the internal data is searched, the searched position may not be the same as the display because the smoothing is performed to the internal data when SMOOTHING is ON.
  2. TARGET VALUE can be specified only with the ten-key.
- 

5. Ripple menu

- [MAX ∩]** : Searches for the maximum of local maximum peak values.  
When FORMAT is SMITH/POLAR, the internal LOGMAG data is searched.
- [MIN ∪]** : Searches for the minimum of local minimum peak values.  
When FORMAT is SMITH/POLAR, the internal LOGMAG data is searched.

**【 $\Delta$ MAX $\cap$ -MIN $\cup$ 】** : Calculates the difference between the maximum of local maximum peak values and the minimum of local minimum peak values.

Moves the active marker to the position of the maximum of local maximum peak values and moves the delta marker (other than FIXED MKR) to the position of the minimum of local minimum peak values.

When FORMAT is SMITH/POLAR, the internal LOGMAG data is searched.

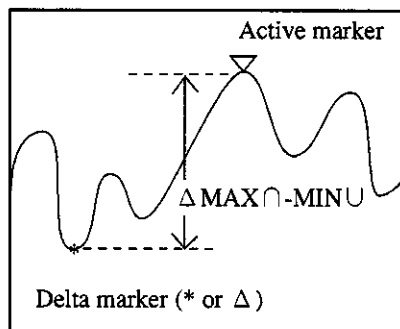

**【MAX - MIN】** : Searches for the difference between the maximum and the minimum.

**【 $\Delta$ X】** : Specifies the detecting sensitivity for the ripple search. The differential coefficient  $\Delta X$  is specified here. Specify a ratio, regarding the full scale of the horizontal axis as 100%.

$\Delta X$  is specified only with the ten-key.

**【 $\Delta$ Y】** : Specifies the detecting sensitivity for the ripple search.

The differential coefficient  $\Delta Y$  is specified here.

$\Delta Y$  are specified only with the ten-key.

● For obtaining ripple (local maximum peak value)

To obtain ripple value under the detecting sensitivity  $\Delta Y/\Delta X$ , search for a point (a) where the gradient (Y/X) of the waveform is larger than  $\Delta Y/\Delta X$ .

Next, search a point (d) where the reverse gradient (Y/X) of the waveform is larger than  $\Delta Y/\Delta X$ . Then the maximum value between (a) and (d) is obtained as a local maximum peak value.

○ A local minimum peak value can be obtained by reversing the polarity of  $\Delta Y/\Delta X$  in the above procedure.

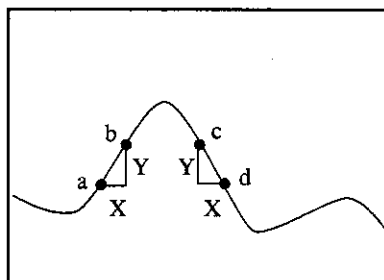

6. Marker Function

---

A D V I C E

1. When the internal data is searched, the searched position may not be the same as the display because the smoothing is performed to the internal data when SMOOTHING is ON.
  2.  $\Delta X$  and  $\Delta Y$  setting are possible only with ten keys.
- 

6. Filter analysis menu

**[WIDTH VALUE]** : Specifies the bandwidth to be searched.  
The bandwidth is determined by specifying loss (X dB) off the active marker position.

**[SEARCH IN/OUT]** :  
IN ; Searches from the active marker position to the screen edge.  
OUT ; Searches from the screen edge to the active marker position.

**[FILTER ANAL ON/OFF]** :  
Displays the result of filter analysis on the screen.  
C.F ; Center frequency in the bandwidth determined by specifying loss (X dB) off the active marker position.  
L.F ; Left side frequency in the bandwidth  
R.F ; Right side frequency in the bandwidth  
BW ; Bandwidth  
Q ; Q factor  
SF ; Shaping factor

※Q factor and Shaping factor are determined by minimum loss value.

---

A D V I C E

1. When the LOGMAG data is not displayed, the internal LOGMAG data is analyzed.  
If the SMOOTHING is ON here, the searched position may not be the same as the display because the smoothing is performed to the internal data.
  2. WIDTH VALUE setting is possible only with ten keys.
-



《Example of the result of filter analysis》

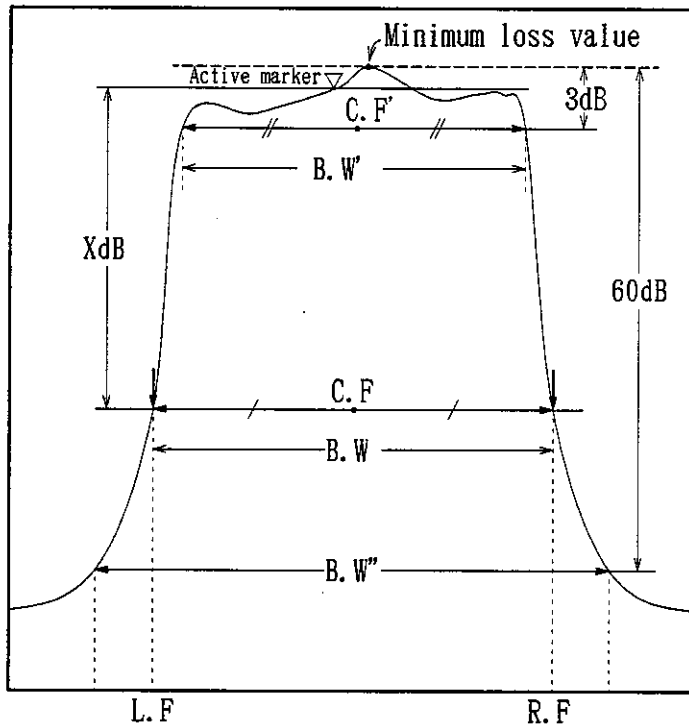

Q factor is calculated from a bandwidth B.W.' where data is 3 dB or less off a minimum loss value of the measured data, and the center frequency C.F.' in the bandwidth B.W.'.

$$Q = \frac{C.F'}{B.W'}$$

Shaping factor is calculated from a bandwidth B.W.' where data is 3 dB or less off minimum loss value of the measured data, and a bandwidth B.W.'' where data is 60 dB or less off the minimum loss value.

$$S.F = \frac{B.W''}{B.W'}$$

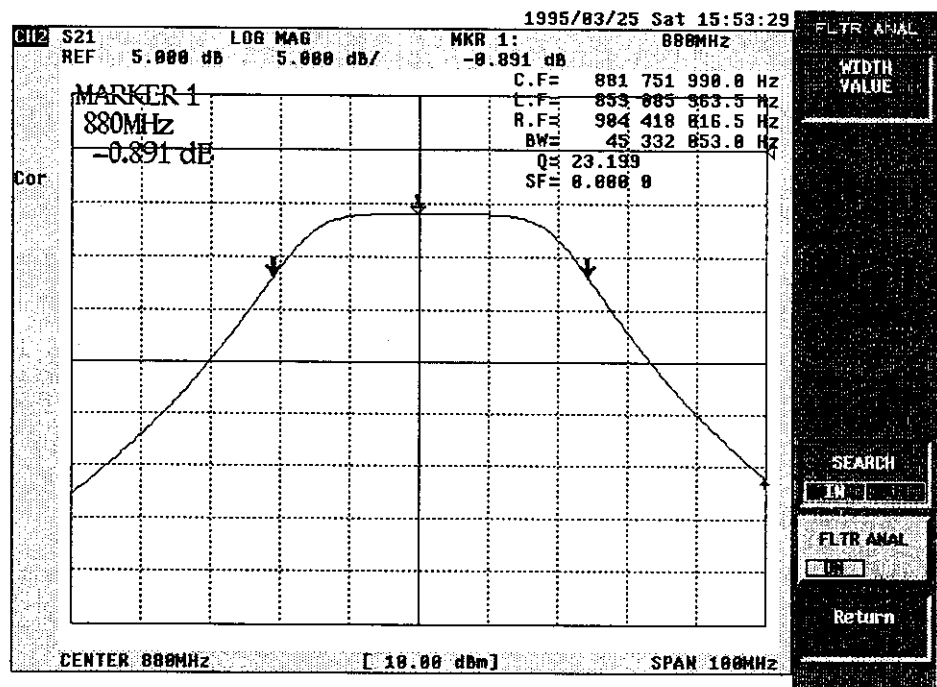

Figure7-2 Example of Filter Analysis Execution

6. Marker Function

7. Part search menu

This menu is used to search specified area instead of the whole measurement area for obtaining the analysis which obtains the maximum value and minimum value.

**【 $\Delta$  MODE MENU**】 : Calls the  $\Delta$  marker mode menu. (Refer to step 2 of page 7-53.)

**【SET RANGE**】 : Sets partially search range which was set at  $\Delta$  marker mode.

**【PART SRCH ON/OFF**】 :

Selects ON/OFF of the part search.

ON ; Part search

OFF ; All search

● Measurement example by MAX search

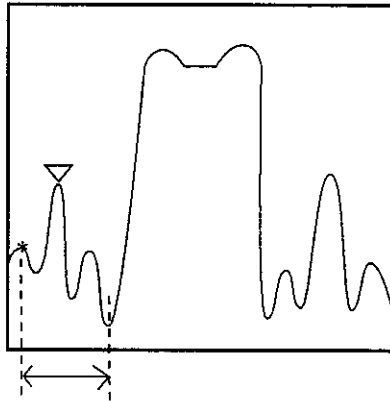

At OFF :

Searches a maximum response value within measurement frequency.

At ON :

Set a range specified with \*marker mode as a partial search range with SET RANGE. Then set PART SRCH to ON and a marker begins to search the maximum value in the set range.

A range specified with  $\Delta$  marker.

## 7. Sweep

The following five types are provided for sweeping the signal source.

- Linear frequency sweep :  
The frequency sweep between measurement points is performed in equal steps linearly.
- Log (logarithm) frequency sweep :  
The frequency sweep between measurement points is performed in logarithmic step.
- User frequency sweep : The user frequency sweep is used to perform in every segments by dividing the measurement points into maximum 30 segments.  
For example, if the segments are set in the stop area, pass area, twofold pass area of the band pass filter, then high data throughput can be obtained because of no sweeping in unnecessary area.
- Program sweep :  
The program sweep is used to perform in every segments by dividing the measurement points into maximum 30 segments. Other than frequency, the output level, receiver section resolution bandwidth, and settling time can be set in every segments. The optimum sweep condition can be set, including throughput and dynamic range.
- Power sweep :  
The power sweep is used for level characteristic measurement.

## 7. Sweep

## ■ Setting Sweep Type

## □ The Setting and the Explanation

1. Press the [MENU] to call the signal source menu. (Refer to page A-9.)
2. Press the [SWEEP TYPE [     ]] to call the sweep type menu.
3. Sweep type menu

[LIN FREQ] :	Sets to the liner frequency sweep.
[LOG FREQ] :	Sets to the log (logarithm) frequency sweep.
[USER SWEEP] :	Sets to the user frequency sweep.
[PROGRAM SWEEP] :	Sets to the program sweep.
[POW SWEEP] :	Sets to the power sweep.
[EDIT USER SWEEP] :	Calls the segment editing menu of the user frequency sweep. (Refer to page 7-67.)
[EDIT PROG SWEEP] :	Calls the segment editing menu of the program frequency sweep. (Refer to page 7-68.)

## ○ Setting sweep area

● Sweep area settings for the linear frequency sweep, log frequency sweep, and power sweep are performed as follows:

Press the [START] , [STOP] or [CENTER] , [SPAN] .

● For the user sweep and program sweep, set the sweep area on each segment editing menu.

---

**A D V I C E**

If USER SWEEP or PROGRAM SWEEP is set, input segments are detected and arranged internally in increasing order of frequency.

If STOP frequency of a segment is higher than START frequency of the next segment in the arranged segments, an error occurs.

---

## ■ Editing Segment of User Frequency Sweep

### □ The Setting and the Explanation

1. Press the **[MENU]** to call the signal source menu. (Refer to page A-9.)
2. Press the **[SWEEP TYPE [ ]]** to call the sweep type menu.
3. Press the **[EDIT USER SWEEP]** to call the user frequency sweep segment editing menu.
4. User frequency sweep segment editing menu

<b>[SEGMENT: NUMBER]</b> :	Specifies the segment number in the range of 0 to 29.
<b>[START]</b> :	Sets the start frequency of the specified segment number.
<b>[STOP]</b> :	Sets the stop frequency of the specified segment number.
<b>[FREQ]</b> :	When the specified segment number is set to 1 point, sets the frequency of the specified point. In reverse, if this frequency is set, then point number automatically becomes 1 point.
<b>[POINT]</b> :	Sets the point number of the specified segment number.
<b>[CLEAR SEG]</b> :	Clears the specified segment.
<b>[CLEAR ALL SEG]</b> :	Clears all segments.

---

#### A D V I C E

1. If the same segment number is edited on the segment editing menu of the program sweep, then the user frequency segment is also changed. Segment holds the program sweep in common.
  2. The setting is not available such as the total setting point number of each segment by user frequency scan exceeds 1201 points. The maximum value of measurement point number is 1201 points.
-

7. Sweep

■ Editing Segment of Program Sweep

□ The Setting and the Explanation

1. Press the [MENU] to call the signal source menu. (Refer to page A-9.)
2. Press the [SWEEP TYPE [     ]] to call the sweep type menu.
3. Press the [EDIT PROG SWEEP] to call the program sweep segment editing menu.
4. Program sweep segment editing menu

● Program sweep segment editing menu (1 of 2)

[SEGMENT: NUMBER] :

Specifies the segment number in the range of 0 to 29.

[START] : Sets the start frequency of the specified segment number.

[STOP] : Sets the stop frequency of the specified segment number.

[POINT] : Sets the point number of the specified segment number.

[CLEAR SEG] : Clears the specified segment.

[CLEAR ALL SEG] : Clears all segments.

● Program sweep segment editing menu (2 of 2)

[SEGMENT: POWER] :

Sets the output level of the set segment number.

[IF RBW] : Sets the receiver section resolution bandwidth of the set segment number.

[SETTLING TIME] : Sets the settling time of the set segment number.

---

A D V I C E

1. If the same segment number is edited on the segment editing menu of the program sweep, then the user frequency segment is also changed. (Segment holds the program sweep in common.)
  2. The setting is not available such as the total setting point number of each segment by user frequency scan exceeds 1201 points. (The maximum value of measurement point number is 1201 points.)
-

《Example of program sweep execution》

The waveform of the screen upper shown as follows is measured by using program sweep.

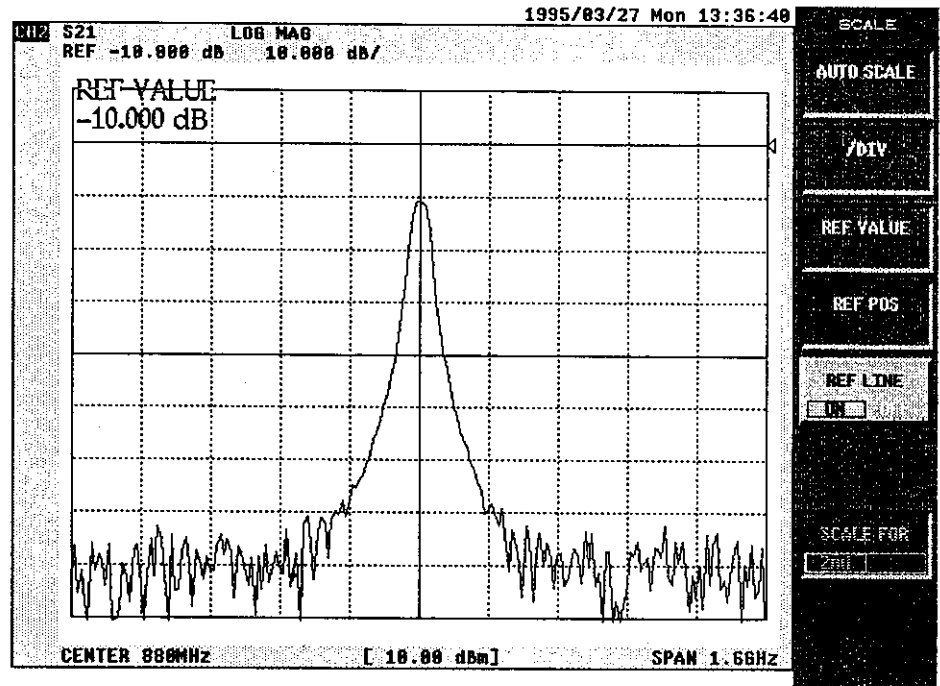

Figure 7-3 The Screen before the Segment Edited

7. Sweep

SEG.	START	STOP	POWER	IF RBW	POINT
0	80MHz	860MHz	10.0dBm	1kHz	50
1	860MHz	900MHz	5.0dBm	10kHz	50
2	900MHz	1680MHz	10.0dBm	10kHz	50

Each segment is shown like the above-mentioned.

And edits and the result of execution is shown in the following.

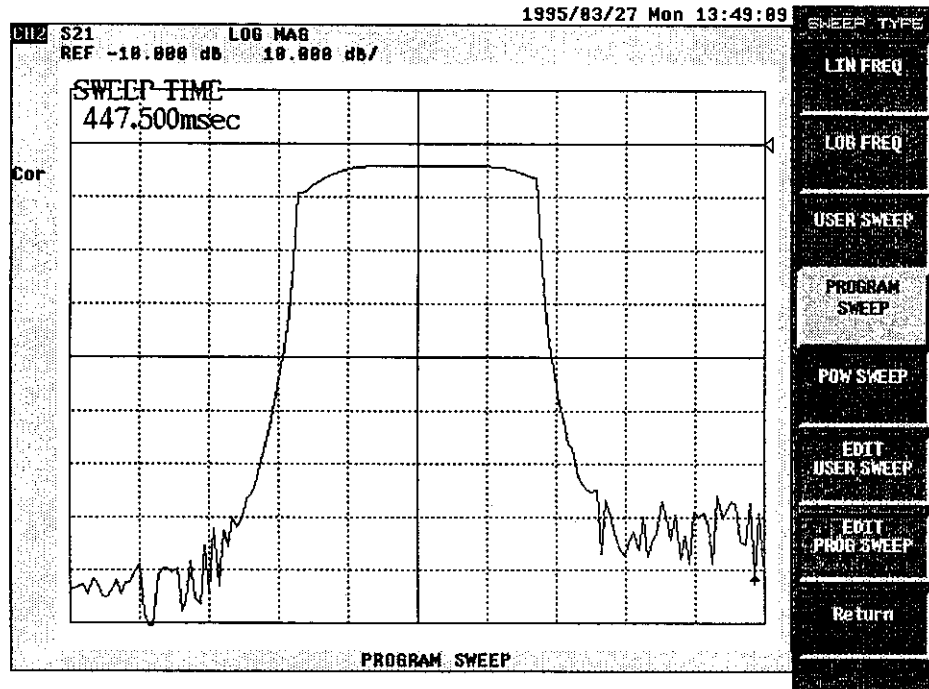
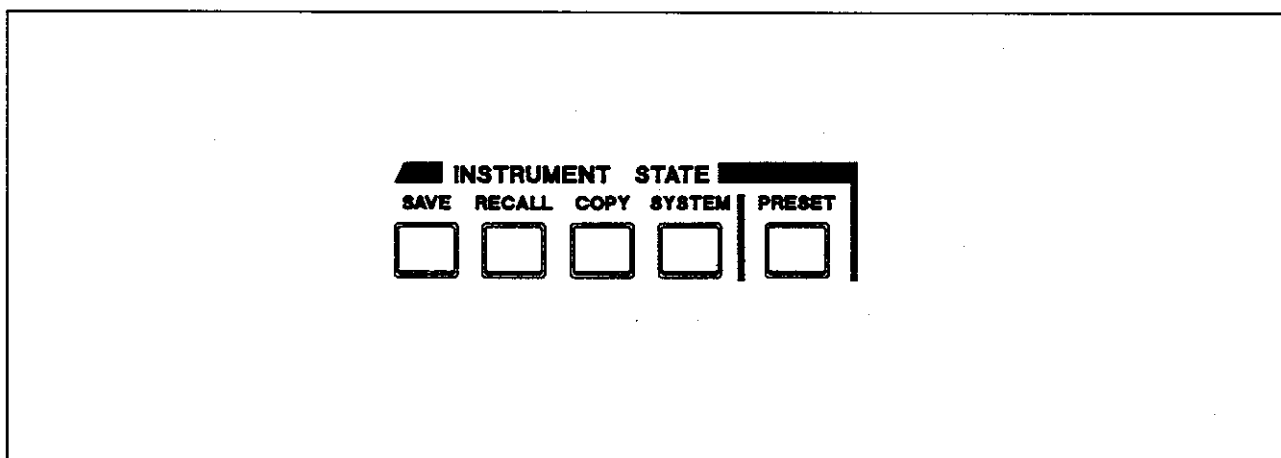

Figure 7-4 The Screen after the Segment Edited



## 8. INSTRUMENT STATE Block



The INSTRUMENT STATE block is used to set the system control functions which have no concern with the measurement. The functions are provided such as a time/date set, limit-line test, save/recall, and hard copy.

- [SAVE] : Calls the save menu to be saved such as a setting data and calibration data of the analyzer. (Refer to page 7-87.)
- [RECALL] : Calls the recall menu to be recalled such as a setting data and calibration data of the analyzer. (Refer to page 7-96.)
- [COPY] : Calls the copy menu to execute the hard copy of screen for a plotter/printer. (Refer to page 7-98.)
- [SYSTEM] : Calls the system menu to be set such as an internal disk, date/time display and limit line. (Refer to page 7-72.)
- [PRESET] : Initializes the settings of the analyzer. (Refer to page 4-4.)

## ■ System Menu

### □ The Setting and the Explanation

1. Press the [SYSTEM] to call the system menu. (Refer to page A-18.)
2. System menu
  - [SYSTEM DRIVE]** : Calls the system for selecting a drive and disk to be used and its format type. (Go to step 3.)
  - [SET CLOCK]** : Calls the real-time clock menu for setting a date/time. (Go to step 6.)
  - [LIMIT MENU]** : Calls the limit menu. (Refer to page 7-75.)
  - [MEAS SUB MENU]** : Calls the measure sub menu. (Go to step 7.)
  - [SERVICE MENU]** : Calls the service menu. (Go to step 8.)
3. System drive menu
  - [DEFAULT DRIVE]** : Calls the default drive menu.(Go to step 4.)  
A drive selected on this menu is set as a current drive when power is turned on.
  - [FORMAT TYPE]** : Calls the disk format menu for selecting a initialize format type. (Go to step 5.)
4. Default drive menu
  - [A:]** : Selects the drive A.  
Floppy disk drive
  - [B:]** : Selects the drive B.  
RAM disk drive (Without backup)
  - [C:]** : Selects the drive C.  
RAM disk drive (With backup)
  - [D:]** : Selects the drive D.  
ROM disk drive (Read only)

## 5. Disk format menu

- [1.2MB 8 SECTORS]** : Specifies the 1.2Mbyte 8 sectors per track when initializing a 2HD floppy disk. (Same as NEC PC9801 series, 2HD floppy disk format)
- [1.2MB 15 SECTORS]** : Specifies the 1.2Mbyte 15 sectors per track when initializing a 2HD floppy disk. (Same as TOSHIBA J3100 series, 2HD floppy disk format)
- [1.44MB 18 SECTORS]** : Specifies the 1.44Mbyte 18 sectors per track when initializing a 2HD floppy disk. (Same as IBM PC series, 2HD floppy disk format)

## 6. Real-time clock menu

- [YEAR]** : Sets an year.
- [MONTH]** : Sets a month.
- [DAY]** : Sets a date.
- [HOUR]** : Sets an hour.
- [MINUTE]** : Sets a minute.
- [SECOND]** : Sets a second.

## 7. Measure sub menu

- [A/R]** : Sets the input port to A/R.
- [B/R]** : Sets the input port to B/R.
- [A/B]** : Sets the input port to A/B.
- [R]** : Sets the input port to R.
- [A]** : Sets the input port to A.
- [B]** : Sets the input port to B.

8. INSTRUMENT STATE Block

8. Service menu

- 【SERVICE MOSES】** : Calls the service mode menu. (Go to step 9.)
- 【SET KEYBOARD 101/106】** : Selects the keyboard type.  
101 is English keyboard and 106 is Japanese keyboard.
- 【FIRMWARE REVISION】** : Displays the firmware revision.

9. Service mode menu

- 【SOURCE CORR ON/OFF】** : Selects whether the frequency characteristic of signal source will be corrected or not.
- 【INPUT CORR ON/OFF】** : Selects whether the frequency characteristic of receiver part will be corrected or not.
- 【SOURCE PLL ON/OFF】** : It's used only for the function test of the analyzer.  
Refer to chapter 10. (Refer to page 10-15.)

## 9. Limit Function

This function defines the segment for the measurement data, sets the upper limit and the lower limit for the segment, and judges pass/fail comparing with the data.

The limit can be set in each channel (CH1 and CH2) and in each sub-measure screen (CH3 and 4) independently.

● How to output the pass/fail judgement is as follows.

○ PASS or FAIL is displayed on the screen.

In the case of FAIL

- (1) Displays the waveform in the Fail section with a selected color.
- (2) Outputs beep sound.
- (3) Sets Limit Fail Summary-Bit of Questionable Status Register.
- (4) Set LOW Status on the parallel I/O port of the rear panel.

### ■ Limit Menu

□ The setting and the explanation

1. Press [SYSTEM] to call the system menu. (Refer to page A-18/19.)
2. Press [LIMIT MENU] to call the limit menu. (Go to step 3.)
3. Limit menu

**[LIMIT LINE ON/OFF]** : Selects ON or OFF in the display of limit line.

When the limit line is set and it is in the state of ON, the limit line is displayed to compare the measurement data on the scale.

The displays of the limit line are different depending on DISPLAY FORMAT and LIMIT TYPE of the segment.

In the format of rectangular coordinate, ^ and v marks or lines (straight lines or parallel lines) are put between break points of each segment.

In the Polar coordinates, circle or straight line showing the angle is described.

9. Limit Function

- 【LIMIT TEST ON/OFF】** : Selects ON/OFF of the limit test.  
Under the limit line ON, the limit values and the data set at each measurement point are compared.  
The limit test is performed during sweeping or after swept, when the data was updated, or when the limit test was set to ON first.
- 【BEEP FAIL ON/OFF】** : Selects beep sound ON or OFF in the case of over limit.  
Beep sounds each time fail was detected during the limit test.
- 【LIMIT MODE MENU】** : Calls the limit mode menu to control the limit test partially and select the limit type of Polar coordinate format. (Go to step 4.)
- 【EDIT LIMIT LINE】** : Calls the edit limit menu (1 of 2) to display the list (Limit Table Window) of limit line segment in the lower half of the display to change the limit setting. (Go to step 5.)  
The limit table window is displayed on the channel side, but not on the active channel side.
- 【SELECT DATA 1ST/2ND】** :  
Switches the judgement parameter to operate.  
2 parameters per channel can be specified for the judgement parameter.  
In the display format of the rectangular coordinates, they corresponds to the first waveform and the second waveform.  
In the display format of Polar coordinates, they corresponds to the judgement parameters to select in LIMIT MODE MENU.
- 【LIMIT LINE OFFSETS】** :  
Calls the offset limit menu to control the stimulus value and the response value of the limit. (Go to step 10.)

#### 4. Limit mode menu

**【1ST DATA ON/OFF】** : Sets the first parameter ON/OFF.  
Judgement of the first parameter limit is performed when the LIMIT TEST is set to ON and also the 1ST DATA is set to ON.

**【2ND DATA ON/OFF】** : Sets the second parameter ON/OFF.  
Judgement of the second parameter limit is performed when the LIMIT TEST is set to ON and also the 2ND DATA is set to ON.  
But the judgement is not performed if effective 2nd waveform data does not exist in the state the display format of Polar coordinates selected.

**【MAG DATA LIN/LOG】** :  
The limit test of Smith chart and Polar display is judged with MAG and PHASEN.  
Select whether this judgement is performed with LIN (linear scale) of MAG DATA or LOG (log scale). (Default setting is LOG.)  
This soft menu is effective only when the format (Refer to page 7-14) is of Smith chart or Polar display.

#### 5. Edit limit menu (1 of 2)

**【SEGMENT】** :  
Selects a segment number to edit.  
Up to 31 segments can be set with starting number 0.  
Up to 7 segments can be displayed at a time and scroll-displayed on the Limit Table Window.  
When EMPTY was displayed in the limit Table, a new segment can be added with ADD SEGMENT or EDIT SEGMENT soft key.  
When no segment was set, 0 is displayed on the active area, and in other cases, the next number to the last specified segment is displayed.  
But soon after the edit limit menu was called, the largest number of the set segments is displayed.  
Also the segment is not updated after the last segment was set.

## 9. Limit Function

- 【SELECT DATA 1ST/2ND】 :**  
Switches the judgement parameter to operate.  
2 parameters per channel can be specified for the judgement parameter.  
In the display format of the rectangular coordinates, they corresponds to the first waveform and the second waveform.  
In the display format of the Polar coordinates, they corresponds to the judgement parameters to select in LIMIT MODE MENU.
- 【EDIT SEGMENT】 :** Calls the edit segment menu to set and change the stimulus value and upper/lower limit value of the specified segment.  
(Go to step 7.)  
If the Limit Table is empty, the segment with initial setting is displayed.  
Also, if an empty segment exists between the largest current set segment and the specified segment, the specified segment number is ignored.  
In this case, the operation is the same as ADD SEGMENT soft key operation.
- 【DELETE】 :** Deletes the segment shown with a pointer >.  
But if the specified segment is empty, this operation is ignored.
- 【ADD SEGMENT】 :** Calls the edit segment menu to add a new segment at the end of the Limit Table. The setting of segment which was selected at SEGMENT and shown with > is input with the initial value of the added segment.
- 【LIMIT TYPE】 :** Calls the limit type menu to select current segment type selected with >. (Go to step 9 of page 7-82.)
- 【DONE】 :** Displays the input segments sorted in ascending stimulus order and returns to the limit menu.  
The updated limit becomes effective by pressing DONE soft key.
- 【More 1/2】 :** Calls the edit limit menu (2 of 2). (Go to step 6 of next page.)



## 6. Edit limit menu (2 of 2)

- 【LIMIT LINE ON/OFF】** : Selects ON or OFF of the limit line display.  
When the limit line is set and it is in the state of ON, the limit line is displayed to compare the measurement data on the scale.  
The displays of the limit line are different depending on DISPLAY FORMAT and LIMIT TYPE of the segment.  
In the format of rectangular coordinates,  $\wedge$  and  $\vee$  marks or lines (straight lines or parallel lines) are put between the break points of each segment.  
In Polar coordinate, circle or straight line showing the angle is described.
- 【LIMIT TEST ON/OFF】** : Selects ON/OFF of the limit test.  
Under the limit line ON, the limit values and the data set at each measurement point are compared.  
The limit test is performed during sweeping or after swept, when the data was updated, or when the limit test was set to ON first.
- 【BEEP FAIL ON/OFF】** : Selects beep sound ON or OFF in the case of over limit (Fail).  
Beep sounds each time fail was detected during the limit test.
- 【MAG DATA LIN/LOG】** :  
The limit test of Smith chart and Polar display is judged with MAG and PHASEN.  
Select whether this judgement is performed with LIN (linear scale) of MAG DATA or LOG (log scale). (Default setting is with LOG.)  
This soft menu is effective only when the format (Refer to page 7-14) is of Smith chart or Polar display.

9. Limit Function

**[LIMIT MODE MENU]** : Calls the limit mode menu to control the limit test partially and select the limit type of Polar coordinates format. (Go to step 4.)

**[LIMIT LINE OFFSETS]** :  
Calls the offset limit menu to control the stimulus value and the response value of the limit. (Go to step 10.)

**[CLEAR LIST]** :  
Calls the clear limit menu to clear all the segments in the limit table. (Go to step 8.)

7. Edit segment menu

**[STIMULUS VALUE]** : Sets stimulus value of segment with ENTRY block.

**[MARKER TO STIMULUS]** :  
Sets stimulus value of segment with active marker.  
Turning the rotary knob moves the active marker right and left.

**[UPPER LIMIT]** :  
Sets the upper limit value of segment.  
It is necessary to set both values, upper limit and lower limit.  
If the upper limit value is not required, set an extreme large value for the upper limit value.  
When the limit value is set with middle value/delta value, it's displayed by upper limit value/lower limit value on the screen.  
If a value smaller than the lower limit is input for the upper limit value or the reverse, the same values are set for the both limit values.

**[LOWER LIMIT]** : Sets the lower limit value of segment.  
It is necessary to set both values, upper limit and lower limit.  
If the lower limit value is not required, set an extreme small value for the lower limit value.

**[DELTA LIMITS]** : Sets the difference to a middle value as the limit.  
For example, when  $-5\text{dB} \pm 3\text{dB}$  is set for the pass area of the limit test, input  $-5\text{dB}$  to the middle value and  $3\text{dB}$  to the delta value.  
Pressing DELTA LIMITS or MIDDLE VALUE soft key displays the center value/delta value on the screen though the limit value is set with upper limit value/lower limit value.

**[MIDDLE VALUE]** : Sets the middle value of DELTA LIMITS.

**[MARKER TO MIDDLE]** :  
Sets the middle value with active marker.

#### 8. Clear limit menu

**[CLEAR LIST YES]** : Clears the Limit Table and returns to the edit limit menu.

**[CLEAR LIST NO]** : Returns to the edit limit menu without clearing the Limit Table.

## 9. Limit Function

## 9. Limit type menu

- 【SLOPING LINE】** : Connects to the limit value of the next segment break point with a sloped line.  
For the final segment, parallel lines are drawn to the largest point of stimulus.  
For the display format of Polar coordinates, the limit value is fixed up to the next segment break point.  
In this case, the result is the same as flat line.  
The slope line segment is displayed with SLIN in the Limit Table.
- 【FLAT LINE】** : Parallel lines are drawn up to the next segment break point.  
It's not connected to the different limit value.  
The limit value is fixed up to the next segment break point.  
For the final segment, parallel lines are drawn to the largest point of stimulus.  
Flat line segment is displayed with FLIN in the Limit Table.
- 【SINGLE POINT】** : The judgement is performed at a single stimulus point.  
Measurement point of the upper limit value is displayed with  $\nabla$  on the display, and measurement point of the lower limit value is displayed with  $\wedge$ .  
The single point segment can be used for the terminal of flat line or sloping line.  
Single point segment is displayed with SPO in the Limit Table.
- 【LIMIT COLOR】** : Sets line color.  
Color-to-setup number relationship is as follows.  
2 ; Red  
3 ; Purple  
4 ; Green  
5 ; Blue  
6 ; Yellow  
7 ; White
- 【WAVE COLOR】** : Sets waveform data color in Fail section.  
The relationship of color-to-setup number is the same as above **【LIMIT COLOR】** .

## 10. Offset limit menu

**[STIMULUS OFFSET]** : Adds/subtracts offset value to/from stimulus value of all segments.

Input offset value by using ENTRY block.

**[AMPLITUDE OFFSET]** :

Adds/subtracts offset value to/from amplitude value of all segments.

Input offset value by using ENTRY block.

**[MARKER TO AMP. OFS]** :

Sets offset value of amplitude value by using the active marker.

## 10. GPIB Block

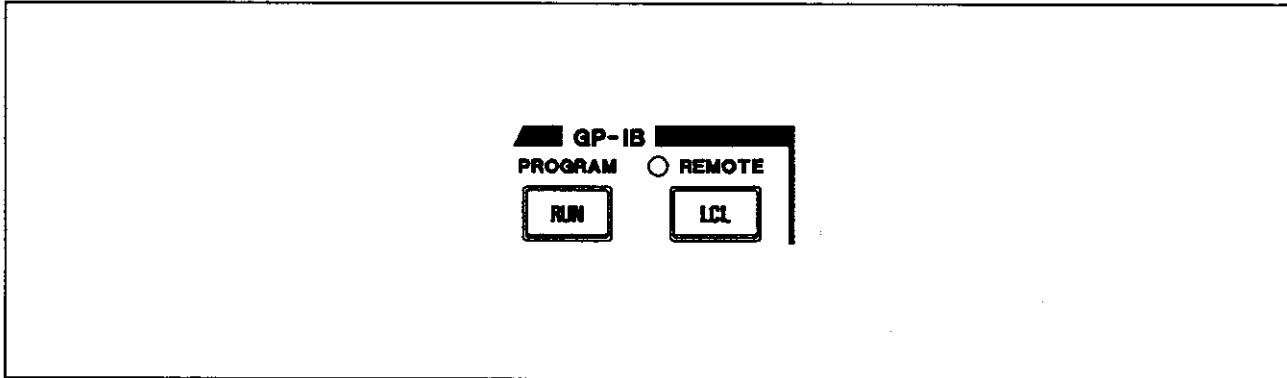

The GPIB block is used to set the controller function, GPIB bus, and GPIB address. For procedure how to create a program, refer to the programming manual of the separate volume.

●PROGRAM

[RUN] : Calls the controller menu. (Refer to page 7-85.)

●REMOTE

[LCL] : Calls the GPIB menu. (Refer to page 7-86.)

Moreover, when R3765/3767 is the remote mode by GPIB, it return back to the local mode by pressing the key.

**NOTE:** The operation key of all the panel key becomes disable in the remote mode expect this key.

## ■ Controller Menu

### □ The setting and the explanation

1. Press the **[RUN]** to call the controller menu. (Refer to page A-20.)

2. Controller menu

**[RUN]** : Starts a program.

**[LOAD MENU]** : Displays a file list and calls the load menu. (Go to step 3.)

**[LIST]** : Displays a program list.

**[CLS]** : Clears the text display on the screen.

**[CONT]** : Restarts a program from the next line immediately after program pauses.

**[STOP]** : Stops a program.

3. Load menu

**[LOAD]** : Loads the file specified by the cursor.  
Following the completion of load, returns to the controller menu. (Go to step 2.)

**[CURSOR ↑]** : Shifts up the cursor used for specifying a file.

**[CURSOR ↓]** : Shifts down the cursor used for specifying a file.

**[DRIVE CHANGE]** :  
Calls the drive menu to change the current drive. (Go to step 4.)

4. Drive menu

**[A:]** : Selects the drive A.  
Floppy disk drive

**[B:]** : Selects the drive B.  
RAM disk drive (without backup)

**[C:]** : Selects the drive C.  
RAM disk drive (with backup)

**[D:]** : Selects the drive D.  
ROM disk drive (Read only)

10. GPIB Block

■ GPIB Menu

□ The setting and the explanation

1. Press the [LCL] to call the GPIB menu. (Refer to page A-20.)

2. GPIB menu

    【SYSTEM CONTROLLER】 : Sets the analyzer to the system controller.

    【TALKER LISTENER】 : Sets the analyzer to the talker/listener.

    【SET ADDRESSES】 : Calls the address menu used for setting the GPIB address. (Go to step 3.)

3. Address menu

    【ADDRESS R3765】 : Sets the GPIB address of the analyzer. (See NOTE.)

    【ADDRESS PLOTTER】 : Sets the GPIB address of the plotter.

    【ADDRESS PRINTER】 : Sets the GPIB address of the printer.

**NOTE :** R3767 is displayed for R3767 series.



## 11. Save/Recall

By using an internal disk, the analyzer setting and the data saving/recalling (store/read) can be performed.

The following two methods for saving data are provided in accordance with informations to be saved and an internal disk.

Save register :

Saves the analyzer setting and calibration data into RAM disk.

- Setting ; Drive C (RAM disk, backup)
- Calibration data ; Drive B (RAM disk, backup)
- Memory waveform data ; Drive B (RAM disk, without backup)

**NOTE :** Since the calibration data and the memory waveform data can not be backed up, if the power is turned off, they are erased.

Store file :

Store the analyzer setting, calibration data, and measurement data on a floppy disk.

- All informations ; Drive A (floppy disk)

### ■ Selection of Save Type

The setting and the explanation

1. Press the [SAVE] to call the save menu. (Refer to page A-15.)
2. Save menu

**[SAVE REGISTER] :** Calls the save register menu.(Refer to page 7-89.)

**[CLEAR REGISTER] :** Calls the clear register menu used for clearing the stored save register. (Refer to page 7-94.)

**[STORE FILE] :** Calls the store file menu used for storing files or setting file names. (Refer to page 7-90.)

The file list (Figure 7-5) will be displayed on the screen.

**[PURGE FILE] :** Calls the purge file menu used for clearing the stored file. (Refer to page 7-95.)

The file list (Figure 7-5) will be displayed on the screen.

**[FORMAT DISK] :** Initializes a floppy disk inserted in drive A.

**NOTE :** Before STORE FILE or PURGE FILE is executed, be sure to insert a formatted floppy disk to the drive.

11. Save/Recall

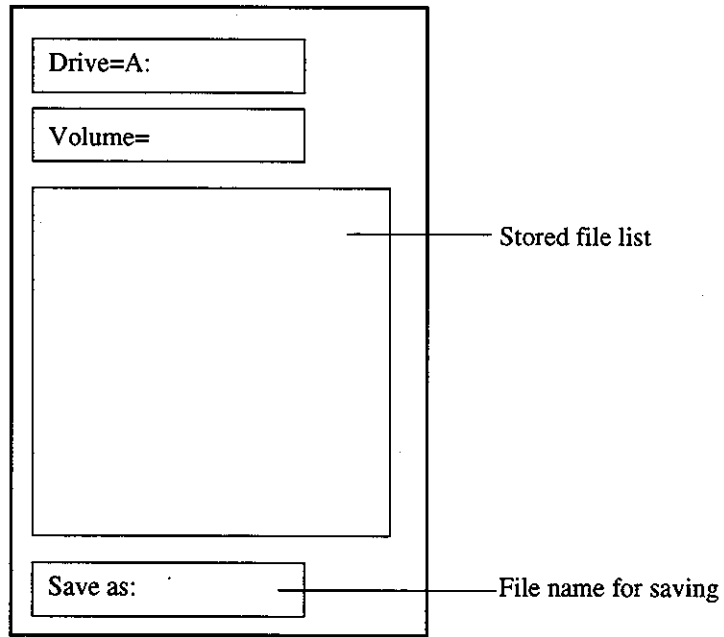

Figure 7-5 File List Display

## ■ Executing Save Register

**NOTE:** When storing data into the saved register, execute the save register operation after erasing data on the clear register menu. (Refer to page 7-94.)

### □ The setting and the explanation

1. Press the [SAVE] to call the save source menu. (Refer to page A-15.)
2. Press the [SAVE REGISTER] to call the save register menu.
3. Save register menu

#### ● Save register menu (1 of 2)

- [SAVE REG-1] : Saves the settings, and calibration data, and memory waveform data into the register 1.
- [SAVE REG-2] : Saves the settings, and calibration data, and memory waveform data into the register 2.
- [SAVE REG-3] : Saves the settings, and calibration data, and memory waveform data into the register 3.
- [SAVE REG-4] : Saves the settings, and calibration data, and memory waveform data into the register 4.
- [SAVE REG-5] : Saves the settings, and calibration data, and memory waveform data into the register 5.
- [RENAME REG] : Calls the rename editing menu used to define a register name. (Refer to page 7-91.)

#### ● Save register menu (2 of 2)

- [SAVE REG-6] : Saves the settings, and calibration data, and memory waveform data into the register 6.
- [SAVE REG-7] : Saves the settings, and calibration data, and memory waveform data into the register 7.
- [SAVE REG-8] : Saves the settings, and calibration data, and memory waveform data into the register 8.
- [SAVE REG-9] : Saves the settings, and calibration data, and memory waveform data into the register 9.
- [SAVE REG-10] : Saves the settings, and calibration data, and memory waveform data into the register 10.
- [RENAME REG] : Calls the rename editing menu used to define a register name. (Refer to page 7-91.)

**NOTE:** As the memory waveform data is not backed up, if the power source of this analyzer is switched OFF, the data is cleared.

## ■ Executing Store File

### □ The setting and the explanation

1. Press the **[SAVE]** to call the save menu. (Refer to page A-15.)
2. Press the **[STORE FILE]** to call the store file menu.
3. Store file menu

**[STORE]** : Stores the setting data, calibration data, measurement data and memory waveform data as a file name for storing.

**[ROLL ↑]** :  Shifts the cursor up/down of the saved file list.

**[ROLL ↓]** :

**[DEFINE STORE]** : Calls the file data menu used to select informations to be stored. (Go to step 4.)

**[EDIT NAME]** : Calls the menu of character editor to define the file name for storing. (Refer to page 7-91.)

**[NAME ↑]** :  Shifts the cursor up/down of the file name for saving.

**[NAME ↓]** :

**[CANCEL]** : Cancels the file store.

### 4. File data menu

When ON is selected, saves data. (Refer to page 9-3, "Data Flow".)

**[STATE ON/OFF]** : Selects ON/OFF of setting conditions data saving.

**[RAW ARRAY ON/OFF]** :  
Selects ON/OFF of the raw data saving before formatting.

**[CORR COEF ON/OFF]** :  
Selects ON/OFF of the calibration data saving.  
When the calibration is performed, ON is automatically selected.

**[DATA ARRAY ON/OFF]** :  
Selects ON/OFF of the format data saving.

**[MEM ARRAY ON/OFF]** :  
Selects ON/OFF of the memory data saving.

## ■ Setting Register Name

The register name is used to set a name for searching easily. When recalling, the register is called as the named register set.

### □ The setting and the explanation

1. Press the [SAVE] to call the save menu. (Refer to page A-15.)
2. Press the [SAVE REGISTER] to call the store file menu.
3. Press the [RENAME REG] to display the label window and calls the name editing menu.
4. Name editing menu

**[EDIT NAME]** : Displays the label window (Figure 7-6) and calls the character editing menu. (Go to step 5.)

**[CURSOR ↑]** :  Shifts the cursor up/down of the register list (Figure 7-7).

**[CURSOR ↓]** :  Edits the register name of the cursor position.

5. Character editing menu

**[DONE]** : Completes editing.

**[CURSOR →]** : Shifts the label cursor right.

**[CURSOR ←]** : Shifts the label cursor left.

**[BACKSPACE]** : Executes the back space operation.

**[DELETE CHAR]** : Deletes the character of the cursor position.

**[CLEAR NAME]** : Clears all the characters (names).

**[CANCEL]** : Cancels editing.

REG1															
	!	"	#	\$	%	&	'	␣	*	+	,	-	.	/	0
	1	2	3	4	5	6	7								
8	9	:	<	=	>	?	@	A	B	C	D	E	F	G	H
								I	J	K	L	M	N	O	
P	Q	R	S	T	U	V	W	X	Y	Z	[	\	^	_	'
								a	b	c	d	e	f	g	
h	i	j	k	l	m	n	o	p	q	r	s	t	u	v	w
								x	y	z			~		

Figure 7-6 Label Window Display

11. Save/Recall

REGISTER LIST	
1:	REG1
2:	REG2
3:	REG3
4:	REG4
5:	REG5
6:	REG6
7:	REG7
8:	REG8
9:	REG9
10:	REG10

Figure 7-7 Register List Display

---

**A V D I C E**

The setting of register name is effective only for the saved register.

If the name is set to the unsaved register and the power source is switched off without executing the saving, the set register name is not saved.

---

## ■ Setting File Name

The file name is used to set a name for searching easily. When recalling, the file is called as the named file set.

### The setting and the explanation

1. Press the **[SAVE]** to call the save menu. (Refer to page A-15.)
2. Press the **[STORE FILE]** to call the store file menu.
3. Press the **[NAME ↑]** , **[NAME ↓]** to select a desired file name.
4. Press the **[EDIT NAME]** to display the label window (Figure 7-6) and calls the character editing menu.
5. Character menu

<b>[DONE]</b> :	Completes editing.
<b>[CURSOR →]</b> :	Shifts the label cursor right.
<b>[CURSOR ←]</b> :	Shifts the label cursor left.
<b>[BACKSPACE]</b> :	Executes the back space operation.
<b>[DELETE CHAR]</b> :	Deletes the character of the cursor position.
<b>[CLEAR NAME]</b> :	Clears all the characters (names).
<b>[CANCEL]</b> :	Cancel editing.

---

### A D V I C E

The setting of file name is effective only for the stored file.  
If the name is set to the unstored file and the power source is switched off without executing the store, the set file name is not stored.

---

11. Save/Recall

## ■ Clearing Saved Register

Clears registers.

When the register name is defined, the defined register name is displayed on the screen.

### The setting and the explanation

1. Press the **[SAVE]** to call the save menu. (Refer to page A-15.)
2. Press the **[CLEAR REGISTER]** to call the clear register menu.
3. Clear register menu

#### ● Clear register menu (1 of 2)

- [CLEAR REG-1]** : Clears the register 1.
- [CLEAR REG-2]** : Clears the register 2.
- [CLEAR REG-3]** : Clears the register 3.
- [CLEAR REG-4]** : Clears the register 4.
- [CLEAR REG-5]** : Clears the register 5.

#### ● Clear register menu (2 of 2)

- [CLEAR REG-6]** : Clears the register 6.
- [CLEAR REG-7]** : Clears the register 7.
- [CLEAR REG-8]** : Clears the register 8.
- [CLEAR REG-9]** : Clears the register 9.
- [CLEAR REG-10]** : Clears the register 10.



## ■Purging Stored File

Purges files.

When the file name is defined, the defined file name is displayed on the screen.

### The setting and the explanation

1. Press the [SAVE] to call the save menu. (Refer to page A-15.)
2. Press the [PURGE FILE] to call the purge file menu.
3. Purges files menu

[PURGE] : Purges the file.

[CURSOR ↑] :  Shifts the cursor up/down of file list.

[CURSOR ↓] :

※Purges the file of the cursor position.

## ■ Executing Recall

Recalls register or file.

When the register/file name is defined, the defined name is displayed on the screen.

### □ The setting and the explanation

1. Press the [RECALL] to call the recall menu. (Refer to page A-16.)

2. Recall menu

#### ● Recall menu (1 of 2)

[RECALL REG-1] :	Recalls the setting data, and calibration data, and memory waveform data saved in the register 1.
[RECALL REG-2] :	Recalls the setting data, and calibration data, and memory waveform data saved in the register 2.
[RECALL REG-3] :	Recalls the setting data, and calibration data, and memory waveform data saved in the register 3.
[RECALL REG-4] :	Recalls the setting data, and calibration data, and memory waveform data saved in the register 4.
[RECALL REG-5] :	Recalls the setting data, and calibration data, and memory waveform data saved in the register 5.
[RECALL POWER OFF] :	Saves the current setting when the power of the analyzer is turned off. When the power is turned on again, the setting for the analyzer is set as a default (initial state). By pressing this key, the default setting is changed to the stored data reproduction for this recall operator.
[LOAD FILE] :	Calls the load file menu used to load the all informations stored in the file. (See step 3 or Figure 7-5.)

- NOTE:**
1. Before LOAD FILE is executed, be sure to insert a formatted floppy disk to the drive.
  2. As the memory waveform data is not backed up, if the power source of this analyzer is switched OFF, the data is cleared.

● Recall menu (2 of 2)

- [RECALL REG-6]** : Recalls the setting data, and calibration data, and memory waveform data saved in the register 6.
- [RECALL REG-7]** : Recalls the setting data, and calibration data, and memory waveform data saved in the register 7.
- [RECALL REG-8]** : Recalls the setting data, and calibration data, and memory waveform data saved in the register 8.
- [RECALL REG-9]** : Recalls the setting data, and calibration data, and memory waveform data saved in the register 9.
- [RECALL REG-10]** : Recalls the setting data, and calibration data, and memory waveform data saved in the register 10.
- [RECALL POWER OFF]** : Saves the current setting when the power of the analyzer is turned off. When the power is turned on again, the setting for the analyzer is set as a default (initial state). By pressing this key, the default setting is changed to the stored data setting for this recall operator.
- [LOAD FILE]** : Calls the load file menu used to load the all informations stored in the file. (See step 3 or Figure 7-5.)

3. Load file menu

- [LOAD]** : Loads all informations stored in the file.
- [CURSOR ↑]** :  Shifts the cursor up/down of file list.
- [CURSOR ↓]** :
- ※Recalls the file of the cursor position.
- [Return]** : Makes the control return to the recall menu.

**NOTE :** If a file stored with RAW ARRAY or DATA ARRAY ON is loaded, the sweep becomes HOLD without reservation.

## 12. Hard Copy

Hard copy of the screen data can be output to the block or the graphic printer. The plotter outputs from GPIB and the printer outputs from GPIB or RS232C.

When GPIB is to be used, set the analyzer to the system controller on the GPIB block, furthermore, specify GPIB address of the printer and the plotter. (Refer to page 7-86.)

### The setting and the explanation

1. Press the [COPY] to call the copy menu. (Refer to page A-17.)
2. Copy menu

[PRINT] :	Executes hard copy to the printer.
[PLOT] :	Executes hard copy to the plotter. (NOTE)
[ABORT] :	Aborts the hard copy operation. Continued operation cannot be performed.
[SELECT QUADRANT] :	Calls the plot scale menu used to select the size and location of the hard copy. (Go to step 3 of page 7-99.)
[DEFINE PLOT] :	Calls the plot data menu used to define the items for hard copy operation. (Go to step 3 of page 7-100.)
[CONFIGURE PLOT] :	Calls the plotter pen menu used to select pen number and data-line type to be used. (Go to step 3 of page 7-101.)
[PRINT/PLOT SETUP] :	Calls the setup menu used to set up the setting of printer or plotter. (Go to step 3 of page 7-102.)

**NOTE:** In using the plotter of HP company, the indication of the error such as error lamp lighting will be occasionally done.

## ■ Setting Plot Scale

Specifies the output position and the size for plotting on A4 size paper.

### The setting and the explanation

1. Press the [COPY] to call the copy menu. (Refer to page A-17.)
2. Press the [SELECT QUADRANT] to call the plot scale menu.
3. Plot scale menu

- [FULL PAGE]** : Selects the plot scale to output one data on A4 size paper with full page.
- [LEFT]** : Selects the plot scale to output data to the left position by dividing A4 size paper into two blocks.
- [RIGHT]** : Selects the plot scale to output data to the right position by dividing A4 size paper into two blocks.
- [LEFT UPPER]** : Selects the plot scale to output data to upper left position by dividing A4 size paper into four blocks.
- [LEFT LOWER]** : Selects the plot scale to output data to lower left position by dividing A4 size paper into four blocks.
- [RIGHT UPPER]** : Selects the plot scale to output data to upper right position by dividing A4 size paper into four blocks.
- [RIGHT LOWER]** : Selects the plot scale to output data to lower right position by dividing A4 size paper into four blocks.

〈Hard copy example〉

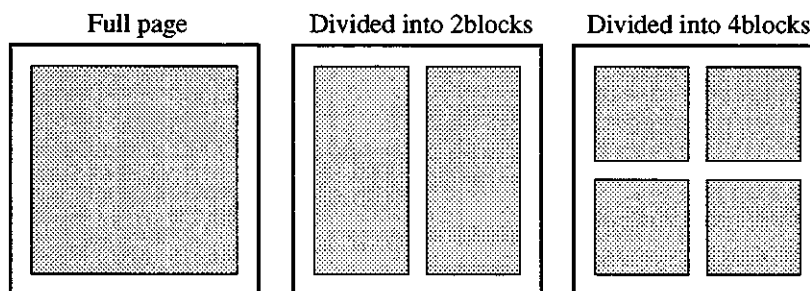

## 12. Hard Copy

**■ Selecting Plot Data**

Selects items to be hard-copied.

Since the items to be set in this menu are interlocking to the channels, they are set to the active channel only.

 The setting and the explanation

1. Press the [COPY] to call the copy menu. (Refer to page A-17.)
2. Press the [DEFINE PLOT] to call the plot data menu.
3. Plot data menu

<b>[PLOT DATA ON/OFF]</b>	:	Sets ON/OFF of the measurement data output.
<b>[PLOT MEMORY ON/OFF]</b>	:	Sets ON/OFF of the memory data output.
<b>[PLOT GRATICULE ON/OFF]</b>	:	Sets ON/OFF of the coordinate output.
<b>[PLOT TEXT ON/OFF]</b>	:	Sets ON/OFF of the text data output.
<b>[PLOT MARKER ON/OFF]</b>	:	Sets ON/OFF of the marker data output.
<b>[PLOT REF LINE ON/OFF]</b>	:	Sets ON/OFF of the reference line output.

**NOTE:** When both the text data output and the marker data output are set to ON, the output of the marker list and filter analysis result is also set.

## ■ Specifying Pen

Selects the pen number and line type to be used.

### The setting and the explanation

1. Press the [COPY] to call the copy menu. (Refer to page A-17.)
2. Press the [CONFIGURE PLOT] to call the plotter pen menu.
3. Plotter pen menu

[PEN NUM DATA] :	Specifies the pen number of the measurement data.
[PEN NUM MEMORY] :	Specifies the pen number of the memory data.
[PEN NUM GRATICULE] :	Specifies the pen number of the coordinate data.
[PEN NUM TEXT] :	Specifies the pen number of the text data.
[PEN NUM MARKER] :	Specifies the pen number of the marker data.
[LINE TYPE DATA] :	Selects the line type of the measurement data.
[LINE TYPE MEMORY] :	Selects the line type of the memory data.

### ● The selection of the line type is as follows.

- 0 ; Solid line
- 1 ; Dotted line
- 2 ; Dashed line
- 3 ; Chain line

## ■ Plotter Setup

### □ The setting and the explanation

1. Press the [COPY] to call the copy menu. (Refer to page A-17.)
2. Press the [PRINT/PLOT SETUPS] to call the setup menu.
3. Setup menu

**[PRINTER]** : Calls the printer setting menu. (Refer to page 7-104.)

**[PRINT SPEED FAST/SLOW]** :  
Selects FAST/SLOW of printer speed. (Refer to page 7-104.)

**[PLOT LABEL ON/OFF]** : Selects ON/OFF of the label and real-time clock output.

**[PLOT P. TXT ON/OFF]** : Sets ON/OFF of output of the characters which have been written on the screen using the controller function.

**[DEFAULT SETUPS]** : Returns all the copy menu to the initial settings.

**[PLOTTER HP/AT]** : Selects the HP or AT plotter.

**NOTE:** In using the plotter of HP company, the indication of the error such as error lamp lighting will be occasionally done.

#### 4. Setting R9833 DIP switches

The DIP switches should be set to the standard values as shown in Figure 7-8. These switched are used to set the initial conditions at powering on and the interface conditions.

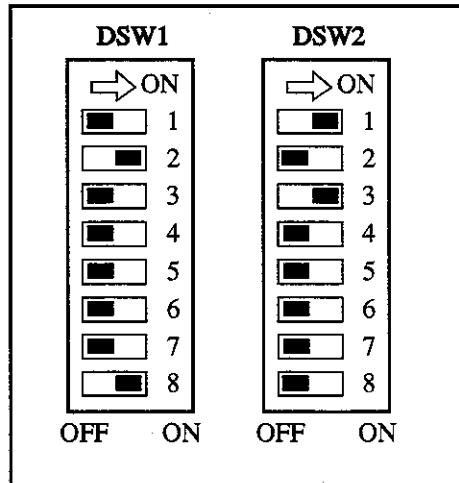

#### SW1 :

HP mode when SW No.8 is ON.

GP-GL mode when SW No.8 is OFF.

In AT mode, it is required to set OFF SW No.8 and ON SW No.4. (See Table 7-3.)

#### DSW2 :

Sets the plotter address to 5. (See Table 7-4.)

Figure 7-8 Setting DIP Switches



Table 7-3 DSW1 Function

SW No.	Functions (ON=1)				Standards
1 to 3	Paper size setting		(SW3=0)	(SW3=1)	SW1=0
	SW1	SW2	ISO/JIS	ANSI	SW2=1
	0	0	A3 maximum width and depth	B maximum width and depth	SW3=0
	1	0	A3 long vertical way direction filling up	B long vertical way direction filling up	A4 long side way
	0	1	A4 long side way direction filling up	A long side way direction filling up	
1	1	A4 long vertical way direction filling up	A long vertical way direction filling up		
4	Setting rotational coordinates		1: rotational coordinates ON		0
5	Selection of unit length for step number		0: normal 1: switch		0
6	Paper detection disable		0: with paper detection function 1: not with paper detection function		0
7	Switching input buffer capacity		1: maximum (12KB) 0: 1KB		0
8	FP-GL-I/FP-GLII select		1:FP-GL-I 0:FP-GLII		1

Table 7-4 DSW2 Function

SW No.	Functions (ON=1)					Standards					
1 to 5	Plotter address setup: Defines the device address with all bits.					SW1=1					
	Bit structure <table border="1" style="display: inline-table; vertical-align: middle;"><tr><td>SW5</td><td>SW4</td><td>SW3</td><td>SW2</td><td>SW1</td></tr></table>					SW5	SW4	SW3	SW2	SW1	SW2=1
	SW5	SW4	SW3	SW2	SW1						
Address 31 is for listen only mode.					SW3=1						
6	Selection of EOI signal control 0: EOI disabled 1: EOI enabled					0					
	However, available only when using FP-GL-II. Not defined for FP-GL-I.										
7	Not defined					0					
8	Selection of reduced drawing mode (only when using FP-GL-II). 1: Selects reduced drawing mode (0.9 time)					0					

If EOI signal is set to ON (enable) and EOI terminal receives "L" when using FP-GL-II, the plotter operates in the same manner as the terminator.

When the plotter sends data, EOI terminal is set to "L" at the same time as it outputs the last "LF" code of sending data.

If the reduced drawing mode is selected when using FP-GL-II, the plotter outputs the drawing being reduced to 0.9 time, based on the global origin.

Then, the actual size of the valid drawing range is not changed and the range to be specified by the program is extended.

12. Hard Copy

■ Printer Setup

□ The setting and the explanation

1. Press the [COPY] to call the copy menu. (Refer to page A-17.)
2. Press the [PRINT/PLOT SETUPS] to call the setup menu.
3. Setup menu

- [PRINTER]** : Selects the printer. (Go to step 4.)
- [PRINT SPEED FAST/SLOW]** :  
Switches the printing speed of the printer.  
In the case of EPSON make, setting to FAST makes the screen small.
- [PLOT LABEL ON/OFF]** : Selects ON/OFF of the label and real-time clock output.
- [PLOT P.TXT ON/OFF]** : Sets ON/OFF of output of the characters which have been written on the screen using the controller function.
- [DEFAULT SETUPS]** : Returns all the copy menu to the initial setting.
- [PLOTTER HP/AT]** : Selects the HP or AT plotter.

4. Printer setup menu

- [HP ThinkJet]** : Selects HP Think Jet.
- [EPSON ESC/P]** : Selects ESC/P-compliant printer.
- [PRINT PORT GPIB]** : Outputs the screen data from GPIB.
- [PRINT PORT RS232C]** : Outputs the screen data from RS232C.

## 13. Communication with Peripheral Devices

As standard, the analyzer is equipped with the parallel I/O interface and RS-232 interface as well as the GPIB interface. With these interfaces, it can communicate with peripherals.

### ○Parallel I/O

Used for communication with peripheral devices such as the handler.

### ○RS-232

Used for output of screen hard copy or print from BASIC by connecting to the printer. (Refer to page 7-98 and 7-114.)

## ■Parallel I/O Port

### ●Outline

The parallel I/O port is the input/output port to communicate with the handler or peripherals.

Use always the shield cable for the condition.

The parallel I/O connector on the back panel is used for communication.

Figure 7-10 shows the internal pin assignment and signals of the connector.

These I/O port is controlled with ENTER and OUTPUT commands.

#### · Input/output port

There are two output ports and two input/output ports, as follows:

Port only for output : A port ; 8-bit width

B port ; 8-bit width

Input/output port : C port ; 4-bit width

D port ; 4-bit width

#### · Port C status output, port D status output

Shows the settings of the input of the input/output ports C and D. It is low when C or D port is set to input, it is high when it is set to output

#### · Write strobe output for output port

By generating a negative pulse on the write strobe output, it shows which output port is used for data output.

13. Communication with Peripheral Devices

Figure below shows the timing chart of the write strobe output and data output.

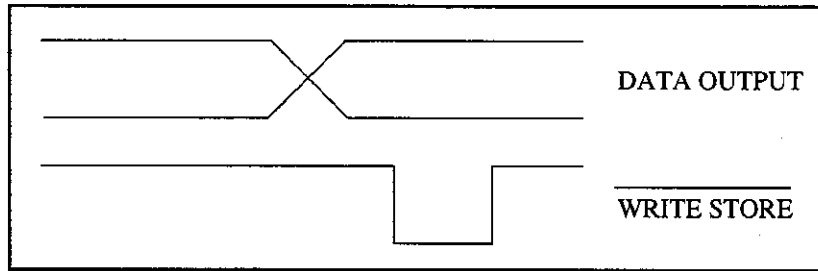
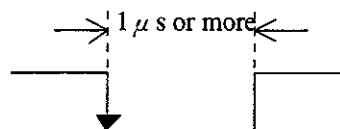

Figure 7-9 Timing Chart of WRITE STORE

- INPUT 1  
By entering a negative pulse on the INPUT 1, the outputs 1 and 2 are set to LOW. The pulse width of the input signal to be entered in the INPUT 1 should be more than  $1 \mu s$ .
- OUTPUT 1 and 2  
These two signal lines are the latch output terminals set to LOW when a negative pulse is entered on the INPUT 1. It can be set to LOW or HIGH with the BASIC command (OUTPUT).
- PASS/FAIL output  
Generates LOW when the result of the limit test is PASS and HIGH when the result is FAIL. This function is available only when the limit test function is ON.
- Write strobe output for PASS/FAIL output  
When the limit test result is output to the PASS/FAIL output line, generates a negative pulse.
- SWEEP END  
When the analyzer finishes the sweeping, generates a negative pulse with a width of  $10 \mu s$ .
- +5V output  
 $+5 V$  output is provided for the external device. The maximum current to be supplied is  $100mA$ . This line has a fuse which will be blown when overcurrent flows for circuit protection. The blown fuse needs to be replaced.
- EXT TRIG input  
By entering a negative pulse on this line, it is possible to trigger the sweeping measurement. The pulse width should be at least  $1 \mu s$ . The sweeping starts at the rising edge of the pulse. When this signal line is used, the trigger mode should be set external source.



● Parallel connector internal pin assigned and signal standard

Pin No	Signal name	Function
1	GND	Ground
2	INPUT 1	Negative logic pulse input of TTL level (width: 1 $\mu$ s or more)
3	OUTPUT 1	Negative logic latch output of TTL level
4	OUTPUT 2	Negative logic latch output of TTL level
5	Output port A0	Negative logic latch output of TTL level
6	Output port A1	Negative logic latch output of TTL level
7	Output port A2	Negative logic latch output of TTL level
8	Output port A3	Negative logic latch output of TTL level
9	Output port A4	Negative logic latch output of TTL level
10	Output port A5	Negative logic latch output of TTL level
11	Output port A6	Negative logic latch output of TTL level
12	Output port A7	Negative logic latch output of TTL level
13	Output port B0	Negative logic latch output of TTL level
14	Output port B1	Negative logic latch output of TTL level
15	Output port B2	Negative logic latch output of TTL level
16	Output port B3	Negative logic latch output of TTL level
17	Output port B4	Negative logic latch output of TTL level
18	EXT TRIG	EXTERNAL TRIGGER input (width: 1 $\mu$ s or more),negative logic
19	Output port B5	Negative logic latch output of TTL level
20	Output port B6	Negative logic latch output of TTL level
21	Output port B7	Negative logic latch output of TTL level
22	Input/output port C0	Negative logic state input/latch output of TTL level
23	Input/output port C1	Negative logic state input/latch output of TTL level
24	Input/output port C2	Negative logic state input/latch output of TTL level
25	Input/output port C3	Negative logic state input/latch output of TTL level
26	Input/output port D0	Negative logic state input/latch output of TTL level
27	Input/output port D1	Negative logic state input/latch output of TTL level
28	Input/output port D2	Negative logic state input/latch output of TTL level
29	Input/output port D3	Negative logic state input/latch output of TTL level
30	Port C status	TTL level, Input mode: LOW, Output mode: HIGH
31	Port D status	TTL level, Input mode: LOW, Output mode: HIGH
32	Write strobe signal	TTL level, Negative logic, Pulse output
33	PASS/FAIL signal	TTL level, PASS: LOW, FAIL: HIGH, latch output
34	SWEEP END signal	TTL level, Negative logic, Pulse output (width: 10 $\mu$ s or more)
35	+5V	+5V $\pm$ 10% 100mA MAX
36	Write strobe signal (PASS/FAIL)	TTL level, Negative logic, Pulse output

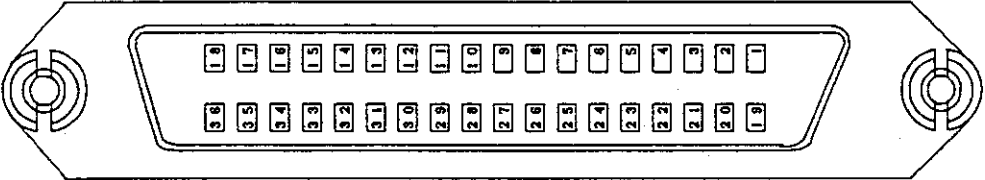
When there's no connection, except for GND, they have high impedance.

Figure 7-10 Parallel I/O (36-pin) Connector Pin Assignment and Signal

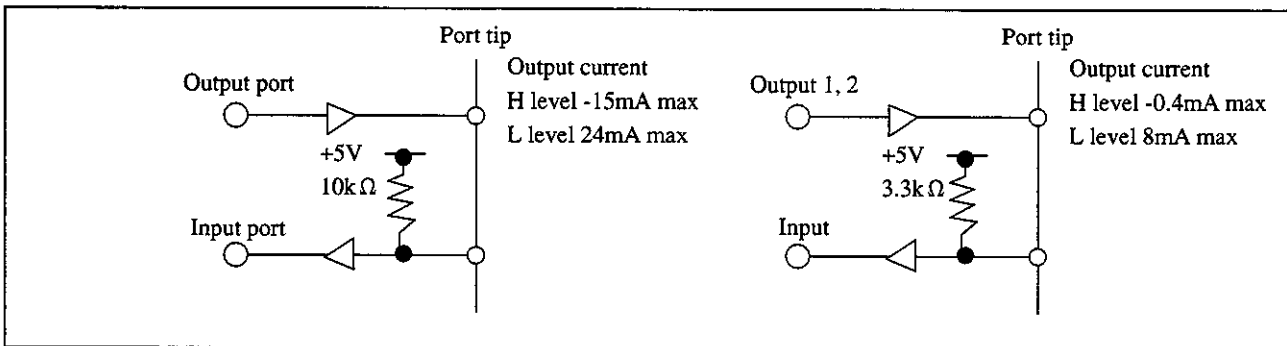

Figure 7-11 Schematic Circuit Diagram of Parallel I/O Port

● Mode setting of port

Command	Output port	Input port
OUTPUT 36 ; 16	A, B, C, D	
OUTPUT 36 ; 17	A, B, D	C
OUTPUT 36 ; 18	A, B, C	D
OUTPUT 36 ; 19	A, B	CD

To use a parallel I/O port, first set the mode setting of port. The combination of the setting command and the input port is referred the above table.

《Example》

```
10 OUTPUT 36;19
20 OUTPUT 33;255
30 ENTER 37;A
```

Set the output port for port A and port B, and the input port for port CD.

● Each port operation method

Describes the operation method by built-in BASIC.

OUTPUT statement (for output) and ENTER statement (for input) are used for data input/output.

In the BASIC command (OUTPUT and ENTER statements), each port is distinguished by the address used in the statement.

(a) BASIC format

```
OUTPUT (address) ; (output data)
ENTER (address) ; [variable]
(Input data are assigned to specified variable.)
```

## (b) Address and data range

Address	Port to be used
33	Port A (Output only: OUTPUT statement only)
34	Port B (Output only: OUTPUT statement only)
35	Port C (Input/output: ENTER, OUTPUT)
36	Port D (Input/output: ENTER, OUTPUT)
37	Port CD (Input/output: ENTER, OUTPUT)

## · OUTPUT 33, 34, 37

OUTPUT  $\times \times$  ; 0 to 255 (8bit)

## · OUTPUT 35, 36

OUTPUT  $\times \times$  ; 0 to 15 (4bit)

※The OUTPUT 35 concerns with the Set/Reset of Flip Flop.

## · ENTER 35, 36

ENTER  $\times \times$  ; numeric variable (4bit) (Data from 0 to 15 are assigned.)

## · ENTER 37

ENTER 37 ; numeric variable (8bit) (Data from 0 to 255 are assigned.)

13. Communication with Peripheral Devices

● INPUT 1, OUTPUT 1, and OUTPUT 2 Terminals

By combining with the signal lines of INPUT 1, OUTPUT 1, and OUTPUT 2, convenient functions are provided to easily control external devices.

The functions are; function which sets two latch outputs to LOW by pulse input to INPUT 1, and function which detects the state of variable OUTPUT 1 by INPUT 1.

Also, the state of OUTPUTs 1 and 2 can be controlled by OUTPUT command.

(a) Setting OUTPUT 1 and OUTPUT 2, and Reset

The following four types are provided for set/reset as follows:

- Setting OUTPUT 1 : OUTPUT 35 ; 16
- Setting OUTPUT 2 : OUTPUT 35 ; 48
- Resetting OUTPUT 1 : OUTPUT 35 ; 80
- Resetting OUTPUT 2 : OUTPUT 35 ; 112

(b) INPUT 1 (external input)

The state of variable OUTPUT 1 by INPUT 1 can be observed by ENTER statement.

ENTER 34; (numeric variable)

If the numeric variable is set to 1, OUTPUT 1 will become ON (Low level: negative logic), if 0, the result will become OFF (High level).

《Example》

```
10 OUTPUT 36 ; 16
20 ENTER 34 ; A
30 IF A <> 1 THEN GOTO 20
40 OUTPUT 33 ; 1
```

By observing the state of OUTPUT 1, if OUTPUT 1 is set to ON, then 1 is output to the port A.



(1) Examples of INPUT 1, OUTPUT 1, and OUTPUT 2

When program is executed by trigger switch:

●Circuit example

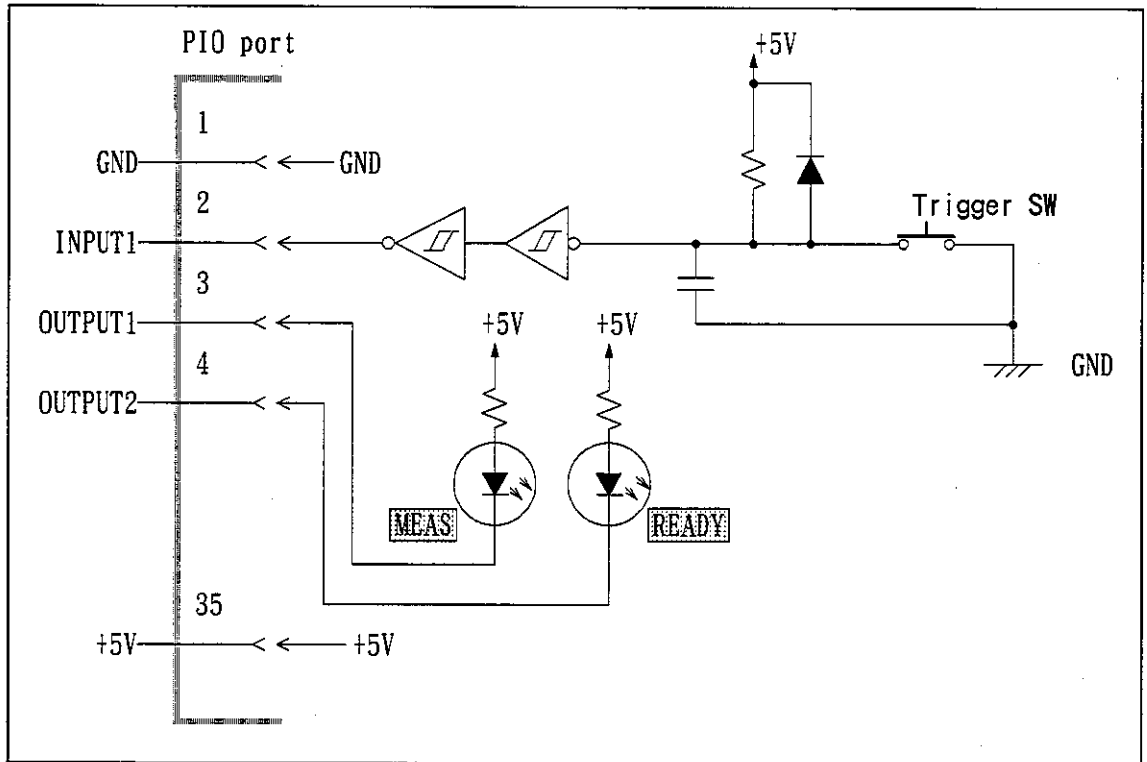

●Program example

Waiting time for measurement:

Represents "READY".

During measurement operation:

Represents "MEAS".

```

10 OUTPUT 35 ; 80
20 OUTPUT 35 ; 112 "READY" "MEAS" turns OFF.
:
:
:
100 OUTPUT 35 ; 48 "READY" turns ON.
110 ENTER 34 ; A
120 IF A < 1 THEN GOTO 110 Recognition of Trigger SW
130 OUTPUT 35 ; 112 "READY" turns OFF.
:
:
:
500 OUTPUT 35 ; 80 "MEAS" turns OFF.
510 GOTO 100 When repeating the measurement
520 STOP
    
```

13. Communication with Peripheral Devices

(2) Usage example of output ports A and B

When LED is used for selecting devices (when port A is used):

● Circuit example

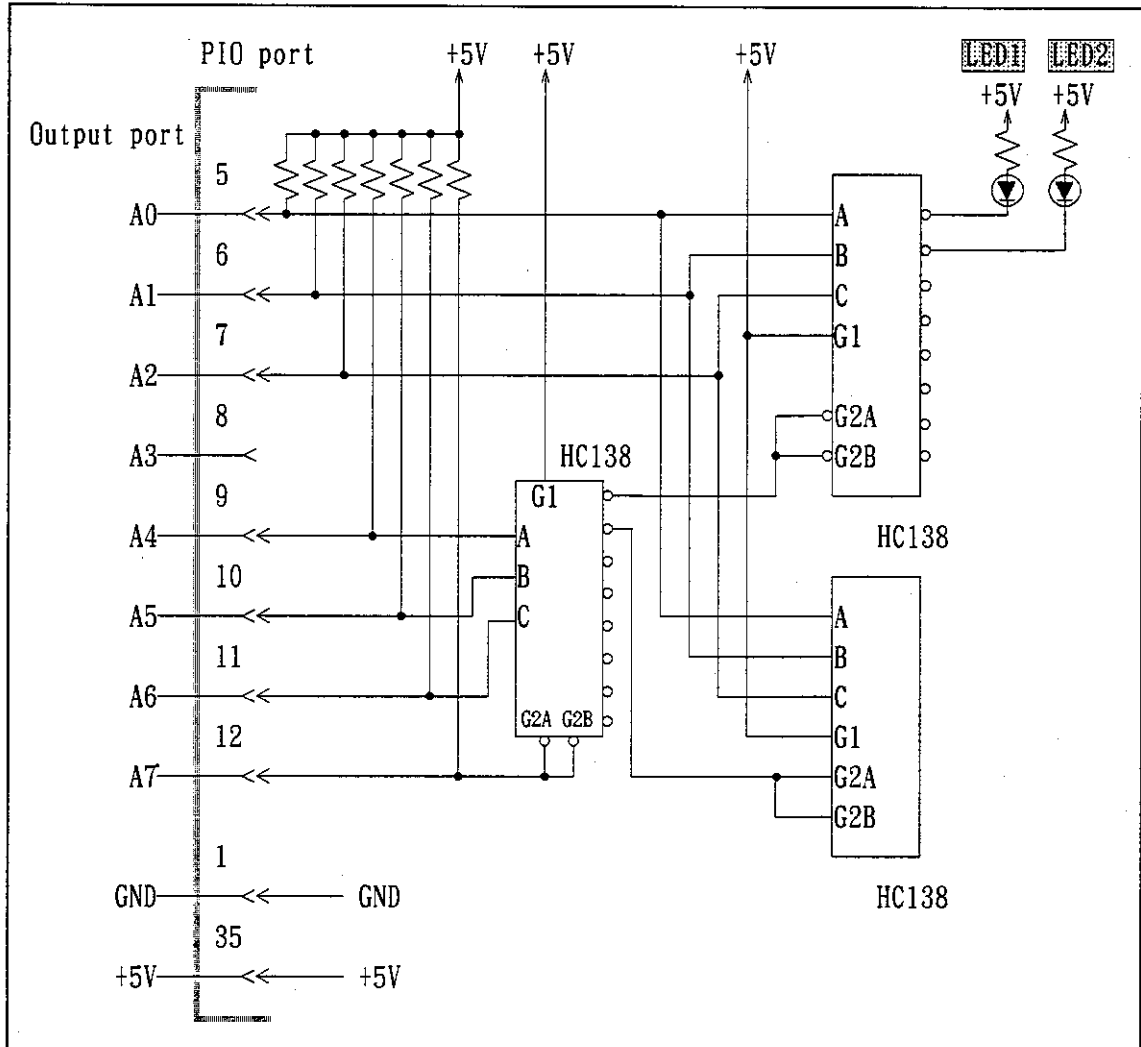

● Program example

```

10 OUTPUT 36 ; 16   Defines ports A, B, C, and D as output port.
20 OUTPUT 33 ; 0   Initializes LED.
30
:                   Measurement and judgment < measurement variable: A >
:                   (Judgment range: JED0 to JED1, JED1 to JED2...)
500 IF A>=JED0 AND A<JED1 THEN OUTPUT 33 ; 0xFF
:                   (When JED0 to JED1, lights up LED 1.)
510 IF A>=JED1 AND A<JED2 THEN OUTPUT 33 ; 0xFF
:                   (When JED1 to JED2, lights up LED 2.)
:
800 GOTO 30
810 STOP
    
```

## (3) Usage example of input ports C and D

Example to change routine whether bit 0 of I/O port C is 0 or 1

## ●Circuit example

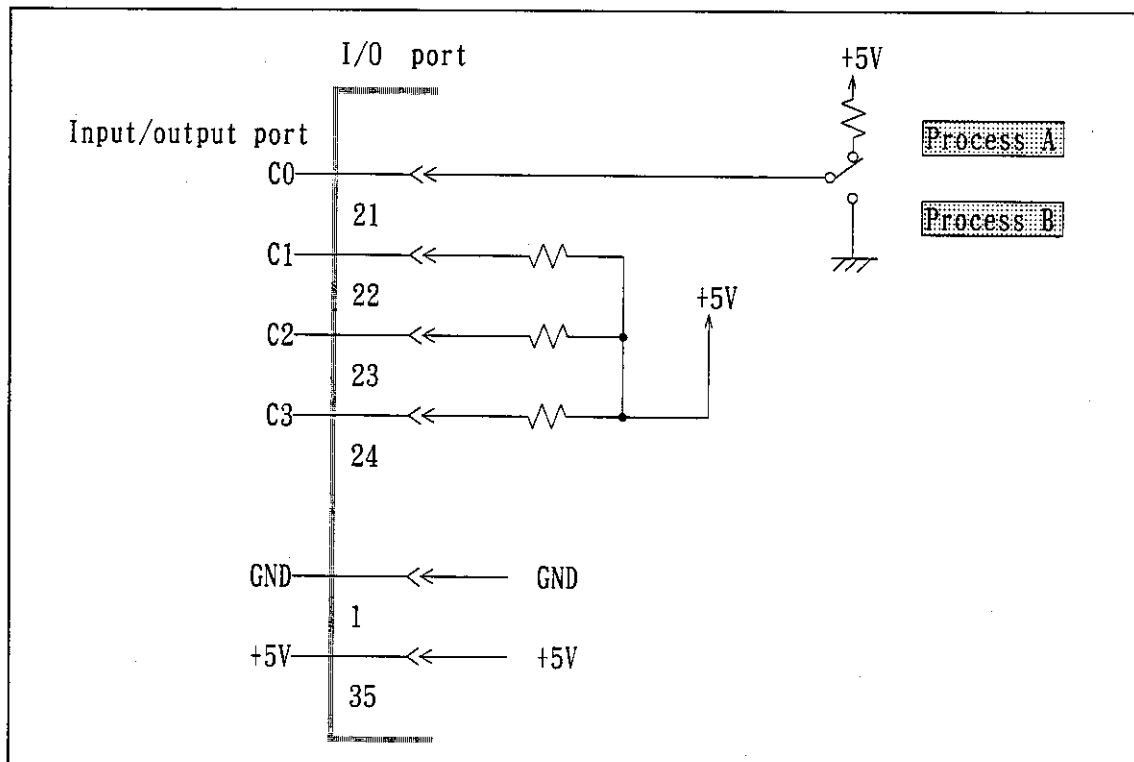

## ●Program example (Check the port C by pressing "Trigger SW" in example (1).)

```

10 OUTPUT 36 ; 19           Defines ports A and B as output port.
20 OUTPUT 35 ; 80         Defines ports C and D as input port.
30 OUTPUT 35 ; 112
:
:                           Network analyzer initial setup
100 *TRIG
110 ENTER 34 ; A
120 IF A<0 THEN GOTO *TRIG
130 ENTER 35 ; B           Obtains value of port C.
140 IF B=1 THEN GOTO *ROUT_B
150 *ROUT_A
:                           Process A
490 GOTO *TRIG
500 *ROUT_B
:                           Process B
900 GOTO *TRIG
910 STOP

```

## ■ RS-232

The analyzer is equipped with an RS-232 interface as a standard. Therefore, the measurement data or the analysis data can be output to an RS-232 printer by BASIC.

The RS-232 interface defines data terminal standardized by Electronic Industries Association (EIA) and mechanical and electrical characteristics of interface for connecting between data communication devices.

### ● Connection connector and signal table

Connection connector : 25-pin D-sub connector (male type)

Signal table

Pin No.	Signal name	Description
1	FG	Ground for security
2	TxD	Sending data
3	RxD	Receiving data
4	RTS	Sending request
5	CTS	Can be sending
6	DSR	Data set ready
7	SG	Signal ground
20	DTR	Data terminal ready

Signals TxD, RTS, and DTR are transferred with SN75188N (power:  $\pm 12V$ ).

Signals RxD, CTS, and DSR are received with SN75189AN.

### ● Printer output method

The LLIST or LPRINT instruction is used to output to the RS-232 printer of the analyzer. The setting such as a baud rate is defined by the CONTROL statement.

Refer to "Programming manual" for details.

LLIST : Outputs BASIC program to the printer.

LPRINT : Outputs the contents of character strings, numeric values, and variables.

CONTROL : Sets the values such as a baud rate, character length, and others.

The setup value on power-up is as follows.

Baud rate : 9600 baud

Character length : 8 bit

Parity : None

Stop bit : 1 bit

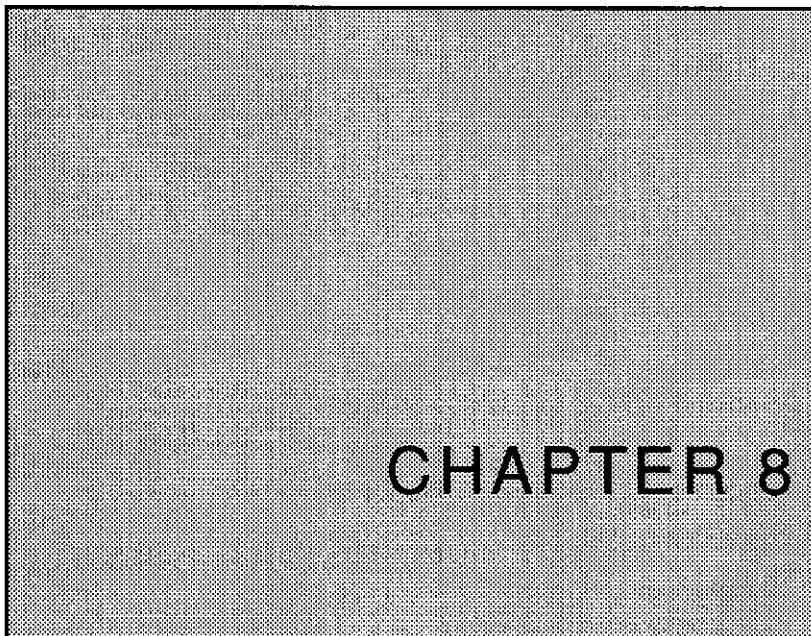

# IN ABNORMALITIES

Read this chapter when the device becomes abnormal.

---

## CONTENTS

---

1. Inspection and Simple Troubleshooting .....	8-2
2. Error Messages .....	8-3
Hardware Trouble .....	8-3
Notice of Hardware Information .....	8-4
Operating Error .....	8-5
Warning of Internal Set, Change, etc. ....	8-10
Notice of the Completion and the State of Operation .....	8-13

---

# 1. Inspection and Simple Troubleshooting

If the device becomes abnormal, check the following items before asking for repair.

When the trouble cannot be resolved by the following countermeasures, contact a nearby ADVANTEST Sales Office.

The addresses and the phone numbers are mentioned at the end of this document.

Their address and phone number are attached at the end of this document. The fare will be charged on the user even for a repair as shown in the table below.

Symptom	Assumed cause	Remedy
The power cannot be turned on.	Power cable is not surely inserted in the connector.	Turn the power switch OFF, and re-connect the power cable.
	Power fuse is blown.	Replace power fuse.
No waveform appears on the screen.	BACK LIGHT is set to OFF.	Press the BACK LIGHT to switch ON.
	Input cable or connector is loose.	Re-connect the input cable or connector.
Does not sweep.	Setting of the trigger is SINGLE.	Set to CONTINUOUS.
The measured result is incorrect.	The calibration was not performed correctly.	Execute the calibration meeting the measurement.
Key does not work.	Not in GPIB remote control mode.	When a program is being executed, stop it and press LCL key.
Data cannot be read (recalled) from floppy disk.	Floppy disk defect.	Check operation with other floppy disk.
	FDD (Floppy disk drive) defect.	Ask ADVANTEST for repair.
	A: Not set to A:drive.	A: Set it to A:drive.
Data cannot be recorded (saved) in floppy disk.	The floppy disk is not initialized.	Initialize the floppy disk.
	The write protect is enabled.	Release the write protect.
	A: Not set to A:drive.	A: Set it to A:drive.

## 2. Error Messages

This chapter explains the error messages displayed on the screen.

### ●Types of error message

- |   |                       |
|---|-----------------------|
| (1) Hardware trouble  | (Refer to page 8-3.)  |
| (2) Notice of hardware information  | (Refer to page 8-4.)  |
| (3) Operating error   | (Refer to page 8-5.)  |
| (4) Warning of the change of internal setting and the like                      | (Refer to page 8-10.) |
| (5) Notice of the completion of an operation, the operating state, and the like | (Refer to page 8-13.) |

### ●Error message display

- The message is displayed on the fixed position of the liquid crystal display. Therefore the message is overwritten and only the last message is displayed.
- The message does not disappear until some panel key is pressed. However, the messages in (1) and (2) disappear when the analyzer is returned from the state.
- The messages of (4), (5) and (6) are not displayed during GPIB command operation (including BASIC).

### ●Error message, the cause, and the solving method

Explains in the following error message table.

### ■Hardware Trouble

<u>Colling Fan Stop.</u> <u>Please Power OFF.</u>	Cooling fan stopped. Please power off. <How to handle> Contact ADVANTEST sales office.
--	---

2. Error Messages

■ Notice of Hardware Information

<p><u>Ach Overload</u></p> <p><u>Bch Overload</u></p>	<p>Overlevel is input into A channel.</p> <p>Overlevel is input into B channel.</p> <p>&lt; How to handle &gt;</p> <p>Check the input signal level.</p>
<p><u>External Standard In.</u></p> <p><u>External Trigger Ignored.</u></p>	<p>An external reference signal has been input.</p> <p>An input external trigger was ignored. (That does not mean a prohibiting state.)</p> <p>&lt; How to handle &gt;</p> <p>An external trigger (PIO-18pin) has been input in a state of not waiting for the external trigger.</p> <p>The state of waiting for the external trigger is not under sweeping but in a state of initiating an external trigger source (that is, in a state that TRIGGER[CONT] or TRIGGER[SINGLE] on the panel).</p> <p>If next trigger pulse is input during a sweep in using an external trigger source, the above error occurs.</p> <p>Check the trigger setting and the specification of an external trigger signal.</p>



## ■ Operating Error

<u>Already Memorized.</u>	<p>Memorizing calibration data which DONE operation was already executed was attempted.</p> <p>&lt;How to handle&gt;</p> <p>Clear the already- memorized calibration data with CLEAR-CAL-DATA. (Reafer to page 7-47.)</p>
<u>Calibration aborted.</u>	<p>Memorizing calibration data was aborted.</p> <p>&lt;How to handle&gt;</p> <p>While calibration data is being memorized, if the setting is changed, the calibration is aborted.</p> <p>Do not change the setting until the calibration is finished. (Reafer to page 7-32 and 7-40.)</p>
<u>Calibration canceled.</u>	<p>The acquired calibration data was cleared because the sweeping conditions were changed during calibration operated.</p> <p>&lt;How to handle&gt;</p> <p>The sweeping conditions must not be changed to acquire more than two calibration data.</p> <p>Execute the calibration data acquisition from the first. (Refer to page 7-35 and 7-36.)</p>
<u>Calibration data not found.</u>	<p>CORRECT ON was executed without memorized calibration data.</p> <p>&lt;How to handle&gt;</p> <p>Memorize the calibration data. (Reafer to page 7-32.)</p>
<u>Can't ... When CORRECT ON.</u>	<p>To Memorize calibration data or to execute CLEAR CAL DATA was attempted in the state of CORRECT ON.</p> <p>&lt;How to handle&gt;</p> <p>Choose CORRECT OFF. (Reafer to page 7-47.)</p>
<u>Can't ... When PROG-SWEEP.</u>	<p>To Specify the number of points or to clear segments was attempted in the state of CORRECT ON.</p> <p>&lt;How to handle&gt;</p> <p>Specify s sweep type other than PROGRAM SWEEP and USER SWEEP. (Reafer to page 7-65.)</p>
<u>Can't ... When USER-SWEEP.</u>	<p>To Set the number of points or to clear segments was attempted in the state of CORRECT ON.</p> <p>&lt;How to handle&gt;</p> <p>Specify a sweep type other than PROGRAM SWEEP and USER SWEEP. (Reafer to page 7-65.)</p>

## 2. Error Messages

## Operating Error

<u>Can't find plotter !!!</u>	<p>A plotter was not found in a plot output.</p> <p>&lt; How to handle &gt;</p> <p>The plotter is not connected or GPIB address of the plotter is not correct. (Refer to page 7-86.)</p>
<u>Data and Coef not matched.</u>	<p>CORRECT ON was to be executed under a condition differing from the measurement condition under which the correction data was acquired.</p> <p>&lt; How to handle &gt;</p> <p>Specify the same measurement condition as the one under which the correction data was acquired. (Refer to page 7-32 and 7-41.)</p>
<u>Data and Memory not matched.</u>	<p>Trace operation (DATA/MEM, etc.) or memory waveform display (DISPLAY-MEMORY, DISPLAY-DATA/MEM) were to be executed under a condition differing from the measurement condition under which the memory waveform was acquired.</p> <p>&lt; How to handle &gt;</p> <p>Specify the same measurement condition as the one under which the memory waveform was acquired. (Refer to page 7-16 and 7-23.)</p>
<u>Disk not found.</u>	<p>A floppy disk could not be found in one of the operations, LOAD MENU, STORE-FILE, or DATA-FILE of the analyzer.</p> <p>&lt; How to handle &gt;</p> <ol style="list-style-type: none"> <li>(1) The floppy disk has some scratches.</li> <li>(2) It's not formatted.</li> <li>(3) It's not inserted in the drive.</li> </ol> <p>Check the floppy disk. (Refer to page 6-8, 7-72, 7-85, 7-90 and 7-97.)</p>
<u>Duplicate name.</u>	<p>The same name that has already been edited or a reserved name is input with the SAVE, STORE-FILE, or EDIT NAME key in R3765/3767 series.</p> <p>&lt; How to handle &gt;</p> <p>Input a different name. (Refer to page 7-87, 7-90, 7-91, and 7-93.)</p>

## Operating Error

<u>File load error.</u>	<p>An error occurred in a LOAD-FILE execution.</p> <p>&lt;How to handle&gt;</p> <p>Something is wrong with the floppy disk, or a file other than files stored in the analyzer was specified. Check the floppy disk. (Refer to page 7-97.)</p>
<u>File store error.</u>	<p>An error occurred in a STORE-FILE execution.</p> <p>&lt;How to handle&gt;</p> <p>(1) The floppy disk has no available space.  (2) It's not formatted.  (3) It's in the state of write protection.</p> <p>Check the floppy disk. (Refer to page 7-90.)</p>
<u>Formatting Failure.</u>	<p>Something was wrong in the formatting operation.</p> <p>&lt;How to handle&gt;</p> <p>(1) The floppy disk has some scratched.  (2) It's in the state of write protection.</p> <p>Check the floppy disk. (Refer to page 7-88.)</p>
<u>Illegal PROG-SWEEP points.</u>	<p>With the number of total points of all segments being less than 3 or more than 1201, the program sweep was specified.</p> <p>&lt;How to handle&gt;</p> <p>Specify the number of the segment point again. (Refer to page 7-66.)</p>
<u>Illegal USER-SWEEP points.</u>	<p>With the number of total points of all segments being less than 3 or more than 1201, the program sweep was specified.</p> <p>&lt;How to handle&gt;</p> <p>Specify the number of the segment point again. (Refer to page 7-66.)</p>

## 2. Error Messages

## Operating Error

<u>Memory not found.</u>	<p>A trace operation (DATA/MEM, etc.) or a memory waveform display (DISPLAY-MEMORY, DISPLAY-DATA&amp;MEM) was specified, with a memory waveform not stored.</p> <p>&lt;How to handle&gt;</p> <p>Obtain the memory waveform. (Refer to page 7-16 and 7-23.)</p>
<u>None Controller.</u>	<p>A plot output was specified in a mode other than a system controller mode.</p> <p>&lt;How to handle&gt;</p> <p>Set to the system controller mode. (Refer to page 7-86.)</p>
<u>Now plotting !!!</u>	<p>Another plot output was specified in the course of executing a plot output.</p> <p>&lt;How to handle&gt;</p> <p>Until the current plot output is complete, the following plot can not be executed.</p> <p>Wait until the current plot output is completed. (Refer to page 7-98.)</p>
<u>Please set 1-trace FORMAT.</u>	<p>With the measurement format two traces (LOGMAG&amp;PHASE, LOGMAG&amp;DELAY, LOGMAG&amp;PHASE), the memory waveform display (DISPLAY-MEMORY, DISPLAY-DATA&amp;MEM) was specified.</p> <p>&lt;How to handle&gt;</p> <p>The memory waveform display is invalid with the measurement format two traces.</p> <p>Set the measurement format to one trace (other than LOGMAG&amp;PHASE, LOGMAG&amp;DELAY, or LOGMAG&amp;PHASE). (Refer to page 7-14 and 7-16.)</p>
<u>Register recall error.</u>	<p>An error occurred in recalling a register.</p> <p>&lt;How to handle&gt;</p> <p>(1) An unsaved register was specified.</p> <p>(2) The register was damaged.</p> <p>Clear the register with CLEAR REG and save it again. (Refer to page 7-96.)</p>

## Operating Error

<u>Register save error.</u>	<p>An error occurred in saving a register.</p> <p>&lt; How to handle &gt;</p> <p>Available space is not in C: drive.</p> <p>Delete unwanted files. (Reafer to page 7-87.)</p>
<u>Segment #x error.</u>	<p>The PROGRAM SWEEP or USER SWEEP was specified in a state that STOP FREQ of the Xth segment is higher than START FREQ of the following segment.</p> <p>&lt; How to handle &gt;</p> <p>Specify the frequency of the Xth segment again. (Reafer to page 7-67 and 7-68.)</p>
<u>Segment not entried.</u>	<p>The PROGRAM SWEEP or USER SWEEP was specified without setting any segment.</p> <p>&lt; How to handle &gt;</p> <p>Specify the segment. (Reafer to page 7-67 and 7-68.)</p>
<u>Segment STD not memorized.</u>	<p>To execute the DONE operation was attempted without obtaining all related calibration data.</p> <p>&lt; How to handle &gt;</p> <p>Obtain all calibration data (OPEN, SHORT, LOAD). (Reafer to page 7-34 and 7-40.)</p>
<u>Can't... When Sub Trace ON.</u>	<p>The measurement format was to be set to two traces (LOGMAG&amp;PHASE, LOGMAG&amp;DELAY, or LINMAG&amp;PHASE) in the state that the InputMeas setting was S11&amp;S21 or S22&amp;S12.</p> <p>&lt; How to handle &gt;</p> <p>When the InputMeas setting is S11&amp;S21 or S22&amp;S12, the measurement format cannot be set to two traces (LOGMAG&amp;PHASE, LOGMAG&amp;DELAY, or LINMAG&amp;PHASE).</p> <p>Change the InputMeas. (Refer to page 7-11/16.)</p>

## 2. Error Messages

## ■ Warning of Internal Set, Change, etc.

<u>STIMURUS changed.</u>	<p>By the CORRECT ON setting, STIMULUS set value was changed internally to the one at the time the calibration data acquired.</p> <p>However, only when INTERPORATE OFF setting. (Refer to page 7-7.)</p>
<u>CORRECT turned off.</u>	<p>The CORRECT setting was internally altered to OFF.</p> <p>&lt; How to handle &gt;</p> <p>The measuring condition in which the correction data was obtained must be the same as the current measuring condition in the correcting measurement (CORRECT ON).</p> <p>Therefore, when the number of points or a sweep type is altered in a state of CORRECT ON, this message is displayed and CORRECT OFF is set.</p> <p>(Reafer to page 7-34 and 7-36.)</p>
<u>CORR or MEM can't be saved.</u>	<p>Correction data and memory waveform data could not be saved by the save register operation.</p> <p>&lt; How to handle &gt;</p> <p>In the save register, the correction data is saved in C:drive and the memory waveform data is saved in B:drive.</p> <p>If available space is not in the drive, this message is displayed. (However, the setting condition in this case is saved.)</p> <p>Clear unnecessary register. (Refer to page 7-87.)</p>
<u>Data file can't be stored.</u>	<p>The waveform data (RAW, COEF, MEM, DATA) was not able to be saved with STORE-FILE.</p> <p>&lt; How to handle &gt;</p> <p>Available space is not in A: drive (floppy disk). (However, the setting condition of the analyzer is saved.)</p> <p>Clear unwanted registers or use another floppy disk. (Reafer to page 7-90.)</p>

## Warning of Internal Set, Change, etc.

<u>Display Mode changed.</u>	<p>The display mode setting was internally altered to DISPLAY DATA.</p> <p>&lt;How to handle&gt;</p> <p>In the memory waveform display (DISPLAY-MEMORY, DISPLAY-DATA&amp;MEM), the measuring condition under which the memory waveform was acquired must be the same as the current measuring condition and the measuring format must be set to one trace.</p> <p>Therefore, when the number of points or the sweep type is altered in a state that the memory waveform is displayed, or when the measuring format is set to two traces (LOGMAG&amp;PHASE, LOGMAG&amp;DELAY, or LINMAG&amp;PHASE), this message is displayed and the display mode is altered to DISPLAY-DATA internally. (Refer to page 7-16.)</p>
<u>Sweep time increased.</u>	<p>The setting of the sweep time was internally altered and the sweep time was increased.</p> <p>&lt;How to handle&gt;</p> <p>The minimum setting value of the sweep time is decided according to the RBW setting, etc. When the sweep time is set to AUTO, this message is not displayed. Therefore, when the sweep time is not set to AUTO, if this message is displayed by altering the setting of the RBW or and the sweep time is increased.</p> <p>Afterward, even if the RBW setting is set to the previous setting, the sweep time setting can not be reset to the previous setting. (Refer to page 7-68 and 7-69.)</p>
<u>Trace-Math turned off.</u>	<p>The setting of the trace operation (DATA+MEM and others) was internally altered to OFF.</p> <p>&lt;How to handle&gt;</p> <p>The measuring condition in which the memory waveform was obtained must be the same as the current measuring condition in the trace operation.</p> <p>Therefore, when the number of points or the sweep type was altered with the trace operation executed, this message is displayed and the trace operation is set to OFF. (Refer to page 7-23.)</p>

2. Error Messages

Warning of Internal Set, Change, etc.

<p><u>FORMAT changed.</u></p>	<p>Setting of the measurement format is changed internally (to LOGMAG).          &lt;How to handle&gt;          When the setting of InputMeas is S11&amp;S21 or S22&amp;S12, the measurement format cannot be set to 2 traces (LOGMAG&amp;PHASE, LOGMAG&amp;DELAY, or LINMAG&amp;PHASE).          Therefore, when the measurement format is in the state of 2 traces and furthermore InputMeas is set to S11&amp;S21 or S22&amp;S12, this message is displayed and the measuring format is changed to LOGMAG internally.          (Refer to page 7-11 and 7-16.)</p>
<p>ZO VALUE changed.</p>	<p>Setting of ZA VALUE is changed internally.          &lt;How to handle&gt;          Changing the setting of CAL KIT is interlocked to the setting of ZO VALUE.          For N(50Ω) or 3.5mm, 50Ω          For N(75Ω), 75Ω.          (Refer to page 7-42 and A-12.)</p>



## ■ Notice of the Completion and the State of Operation

<u>Abort PLOT !!!</u>	The plot output was interrupted by pushing the ABORT key, PRESET key, or STOP key.
<u>Clear Completed.</u>	The memorized calibration data was cleared with CLEAR-CAL-DATA.
<u>Formatting now...</u>	The floppy disk is now under formatting.
<u>Formatting completed.</u>	Formatting the floppy disk was correctly complete.
<u>Store completed.</u>	A data waveform was copied into a memory waveform with DATA→MEMORY.
<u>Wait for sweep.</u>	A sweep is being executed to obtain the calibration data.
<u>Please wait , STORING FILE...</u>	STORE FILE is in execution.
<u>Please wait , LOADING FILE...</u>	LOAD FILE is in execution.
<u>Please wait , PURGING FILE...</u>	PURGE FILE is in execution.
<u>STORE FILE completed !</u>	STORE FILE completed normally.
<u>LOAD FILE completed !</u>	LOAD FILE completed normally.
<u>PURGE FILE completed !</u>	PURGE FILE completed normally.

MEMO 

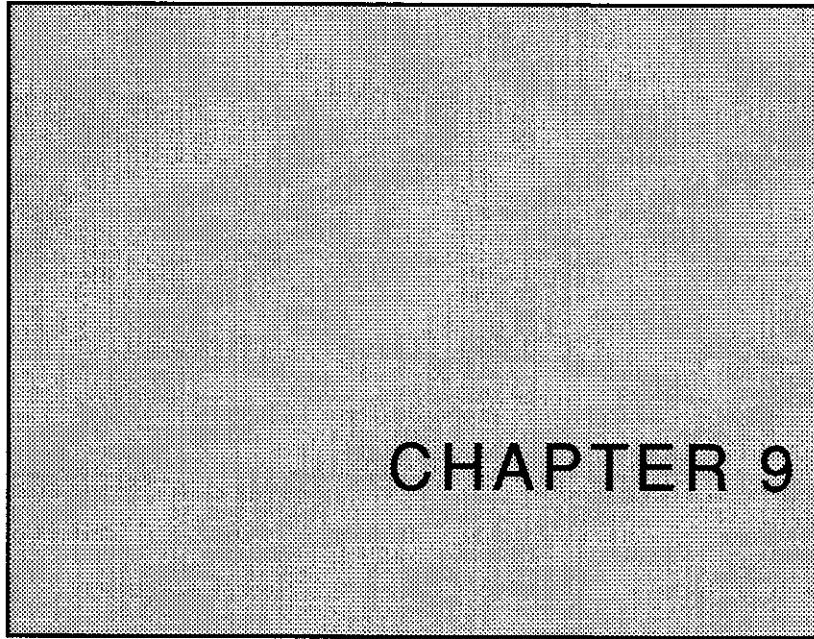

## THE PRINCIPLE

This chapter explains about the basic operation of the analyzer in flow charts.

---

### CONTENTS

---

1. The Principle .....	9-2
2. Data Flow .....	9-3
3. Block Chart .....	9-4
R3765A/3767A Diagrammatic Sketch of Block .....	9-4
R3765B/3767B Diagrammatic Sketch of Block .....	9-5
R3765C/3767C Diagrammatic Sketch of Block .....	9-6

---

# 1. The Principle

## ● Signal source section

R3765 series output the total output signal of 40MHz to 3.8GHz output from 4.44GHz to 8.2GHz synthesizer and 4.4GHz fixed- signal generator.

R3767 series output the total output signal of 40MHz to 3.8GHz output from 4.44GHz to 8.2GHz synthesizer and 4.4GHz fixed-signal generator, and the output signal of 3.8GHz to 8.0GHz output from the synthesizer directly.

The range of output level is decided according to A, B, and C type as follows.

Also the range of output level can be changed by adding option 10 (output attenuator) 0dB to 70dB ATT.

The leveling of 3.8GHz to 8.0GHz is not performed.

The leveling can be done by option 11 (8GHz output AMP).

Type		40 MHz to 3.8 GHz	3.8 GHz to 8.0 GHz
R3765	A	+17dBm to - 8dBm	—
	B	+ 7dBm to -18dBm	—
	C	+10dBm to -15dBm	—
R3767	A	+17dBm to - 8dBm	Fixed value of over 0dBm *
	B	+15dBm to -10dBm	Fixed value of over 0dBm *
	C	+10dBm to -15dBm	Fixed value of over -10dBm *
R3767 (with option 11)	A	+17dBm to - 8dBm	+17dBm to - 8dBm
	B	+15dBm to -10dBm	+ 7dBm to -18dBm
	C	+10dBm to -15dBm	+10dBm to -15dBm

\* : The leveling is not performed.

## ● Receiver section

- (1) The input signal of 40MHz to 3.8GHz (for R3767 series, to 8.0GHz) is converted to 820k IF signal with the Sampler to input into the Mixer.
- (2) 1st IF signal is converted to 20kHz 2nd IF signal with the Mixer and output to A/D circuit.
- (3) A/D processed data is performed high speed arithmetic processing with digital signal processor (DSP) and displayed in the display section.

## 2. Data Flow

The signal input into the receiver section is processed according to the following flow.

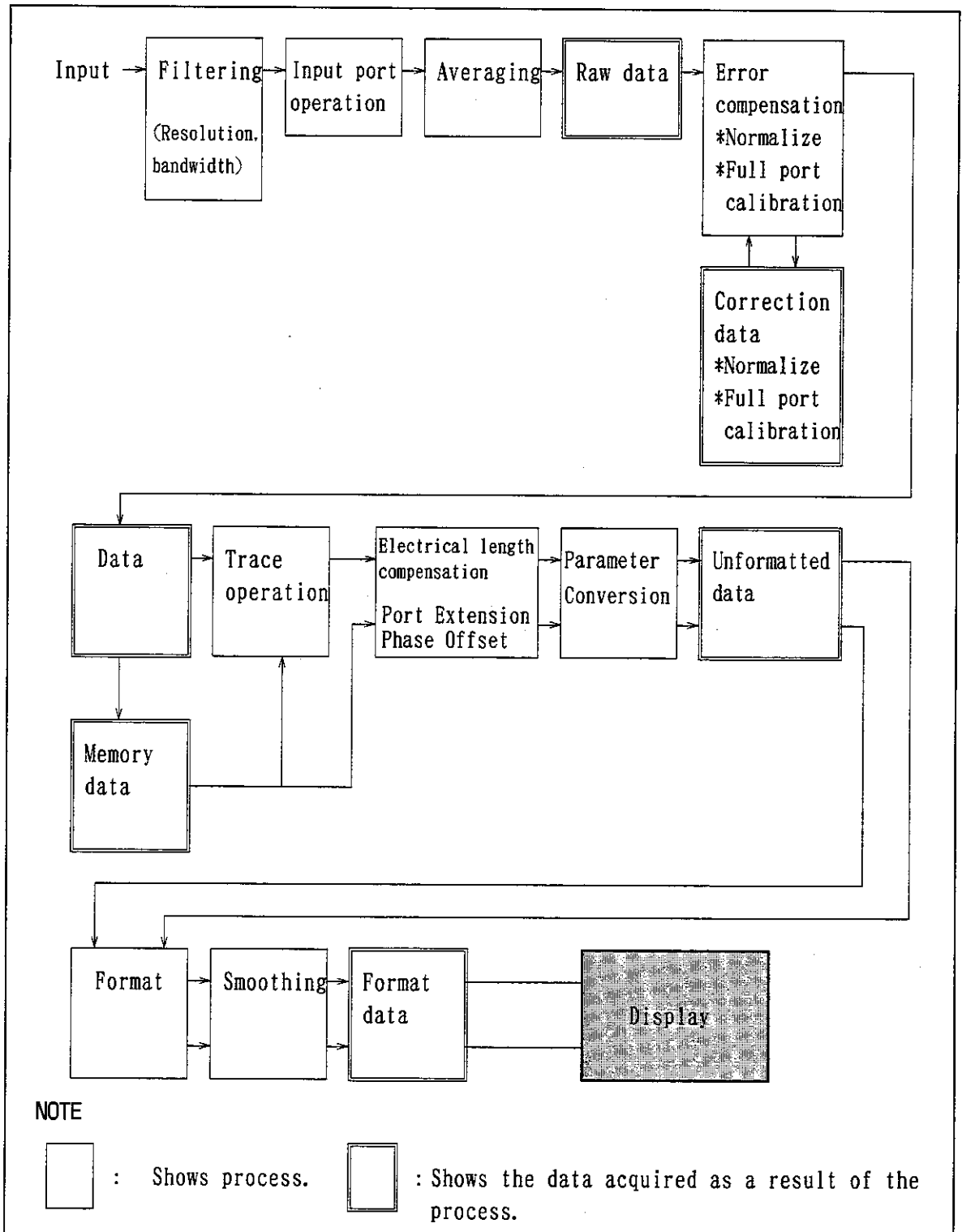
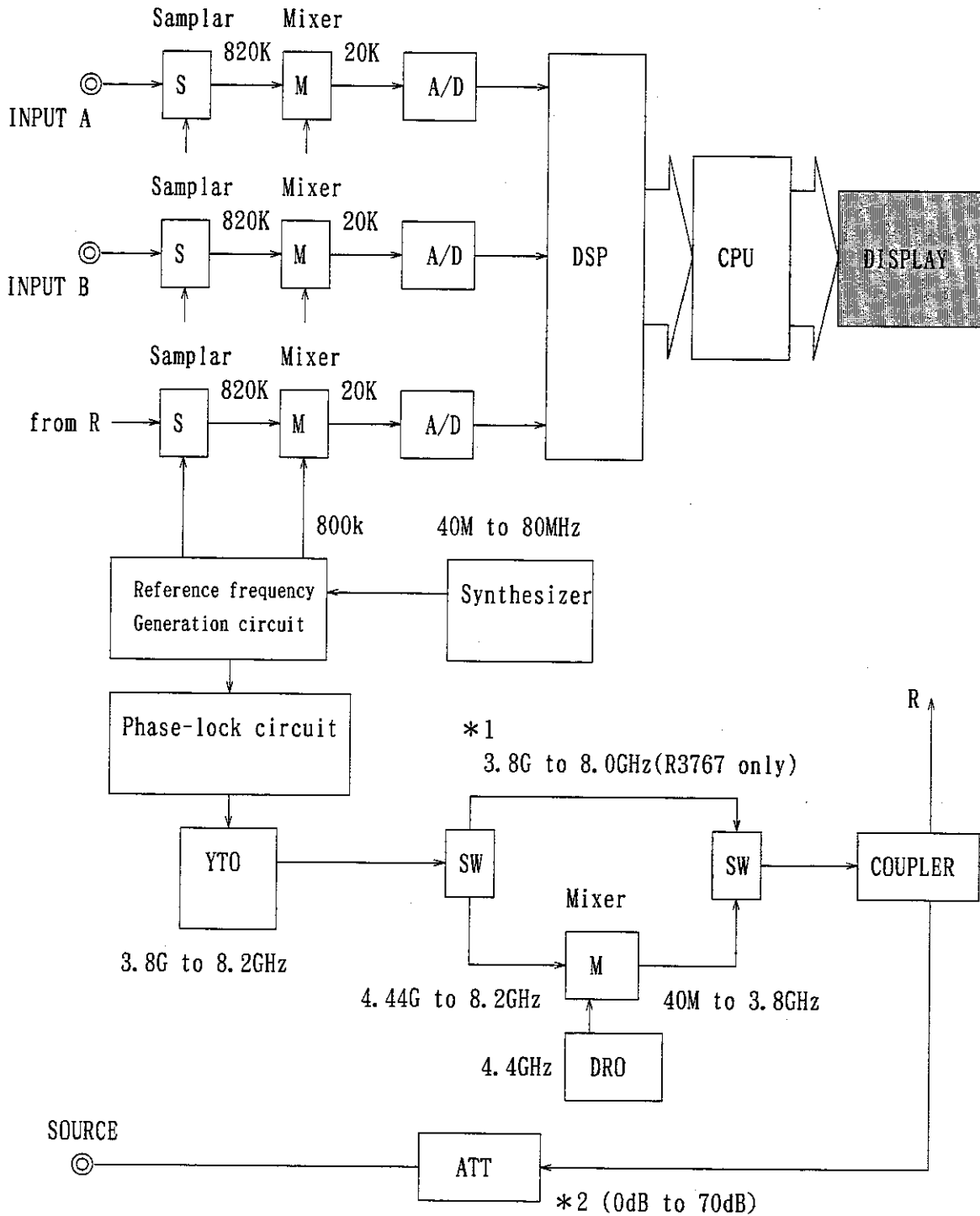

Figure 9-1 Data Flow

### 3. Block Chart

Shows block chart for each type, A type, B type and C type.

#### ■ R3765A/3767A Diagrammatic Sketch of Block



\*1 : Leveling is possible with option 11 (8G output AMP).

\*2 : Option 10 (output attenuator)

■ R3765B/3767B Diagrammatic Sketch of Block

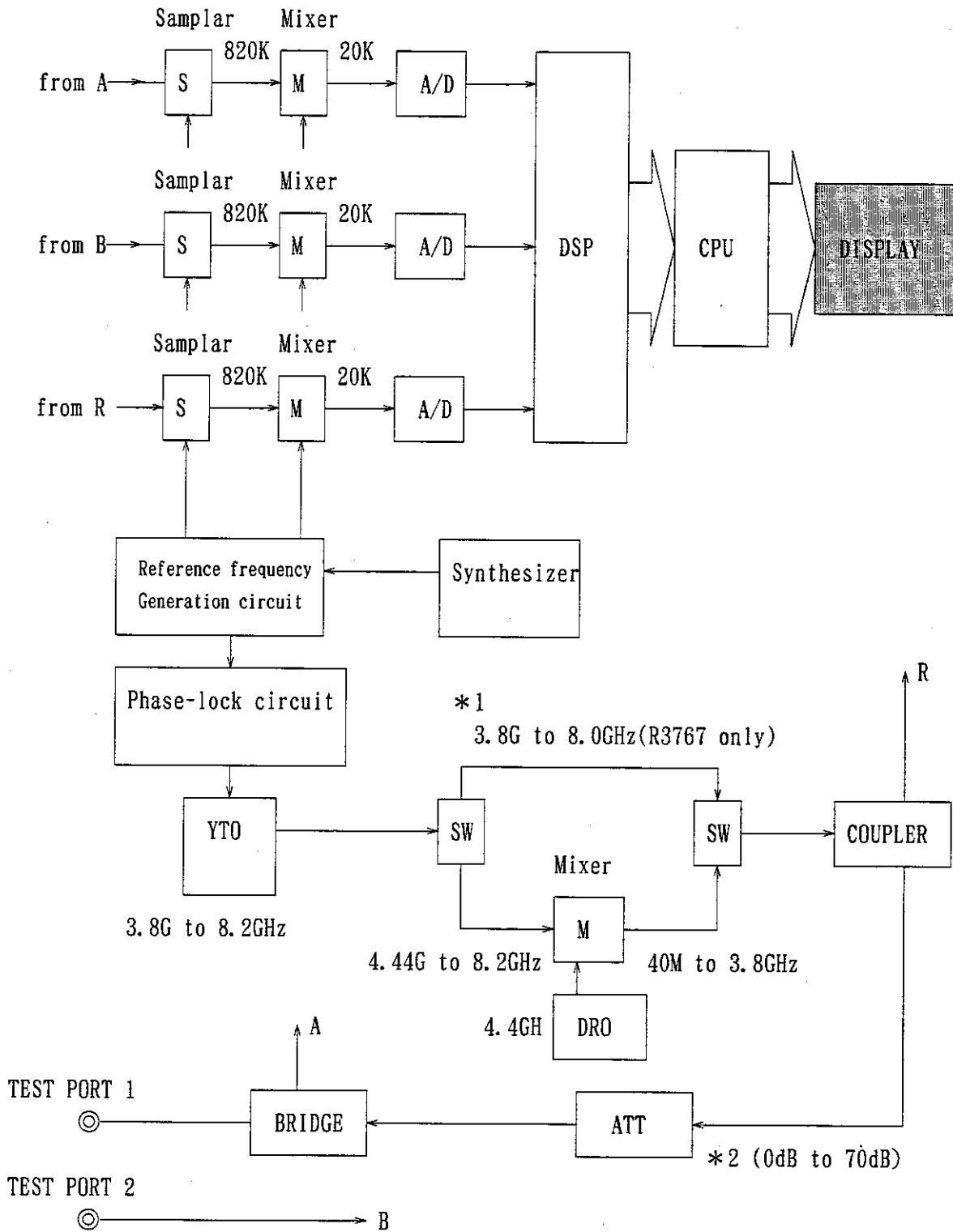

3. Block Chart

■ R3765C/3767C Diagrammatic Sketch of Block

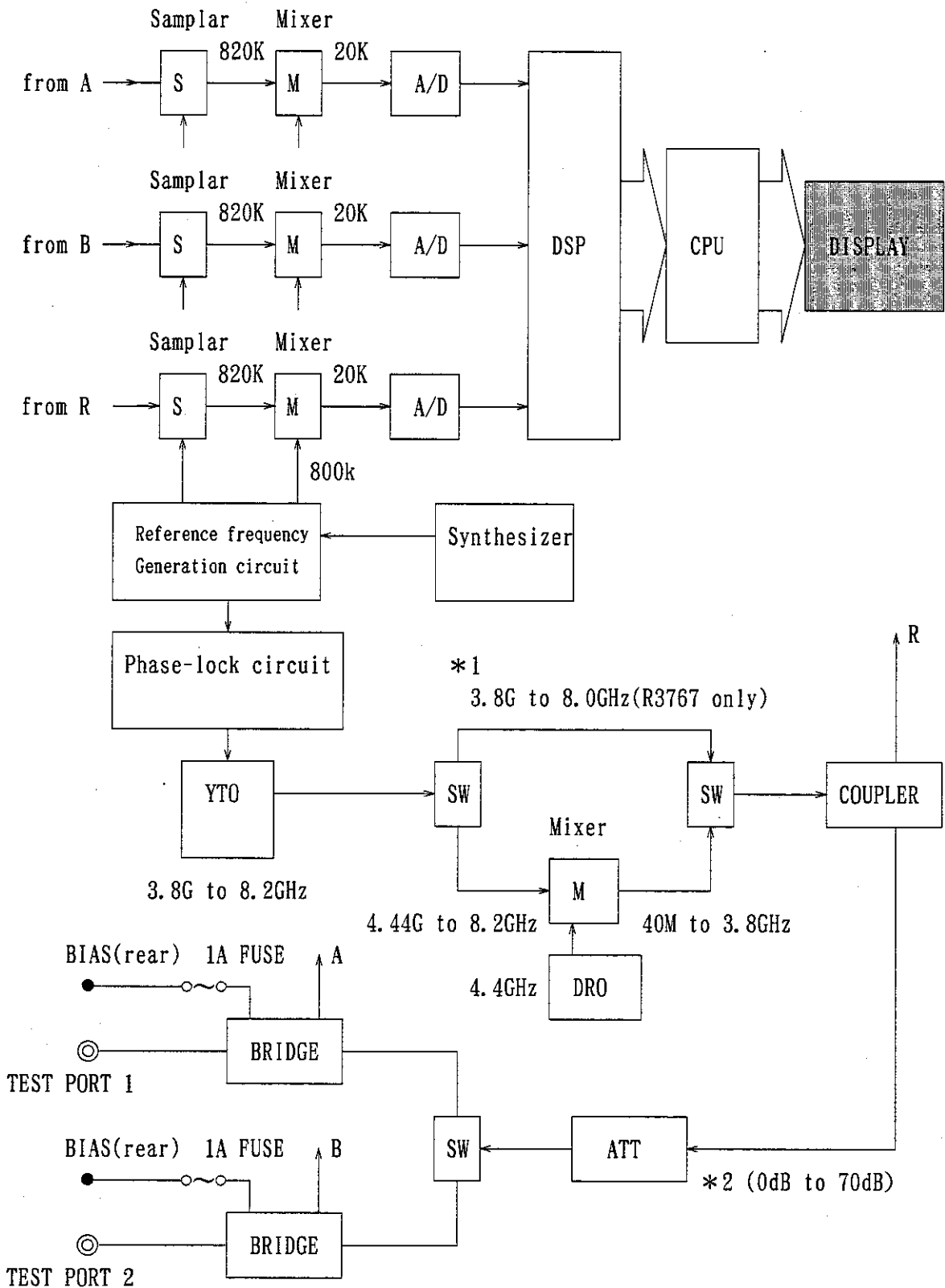

\*1 : Leveling is possible with option 11 (8G output AMP).  
 \*2 : Option 10 (output attenuator)



# CHAPTER 10

## CALIBRATION (PERFORMANCE TEST)

This chapter describes the test method to keep the performance of R3765/3767.  
Contact ADVANTEST for other test methods than the items described in this chapter.

---

### CONTENTS

---

1. Preparing for Performance Test .....	10-2
Warm up .....	10-2
Preparing Measurement Instrument .....	10-2
General Note .....	10-2
2. Frequency Accuracy and Range .....	10-3
3. Output Level Accuracy and Flatness .....	10-4
Setup .....	10-4
Output Level Accuracy .....	10-4
Flatness .....	10-5
4. Output Level Linearity .....	10-6
5. Directivity .....	10-7
6. Load Match of Test Port .....	10-9
7. Noise Level .....	10-15
8. Crosstalk .....	10-18

---

# 1. Preparing for Performance Test

## ■ Warm up

Warm up the analyzer for at least 60 minutes (pre-heating). Also, warm up each calibration standards as well.

## ■ Preparing Measurement Instrument

The following measurement instruments are required referring to the test items listed in Table 10-1.

Table 10-1 Required Measurement Instrument for Calibration

Test items	Measurement Instrument	Remarks	
Frequency accuracy and range	<ul style="list-style-type: none"> <li>● Counter</li> <li>Frequency : 40MHz to 3.8GHz (R3765) 40MHz to 8.0GHz (R3767)</li> <li>Display : 7 digits or more</li> <li>Accuracy : 0.1ppm or less</li> </ul>	R5372 (to 18GHz) or R5373 (to 26GHz) (Manufactured by ADVANTEST)	Refer to page 10-3.
	<ul style="list-style-type: none"> <li>● RF cable</li> <li>BNC-BNC, N-N Type</li> </ul>		
Output/input level and flatness	<ul style="list-style-type: none"> <li>● Power meter</li> <li>Frequency : 40MHz to 3.8GHz</li> <li>Power range : -15dBm to +17dBm</li> </ul>	HP436A/HP437B (HP438A) (Calibrated under the national standard)	Refer to page 10-4.
	<ul style="list-style-type: none"> <li>● Power sensor</li> <li>Frequency : 40MHz to 3.8GHz</li> <li>Power range : -15dBm to +17dBm</li> </ul>	HP8482A (100kHz to 4.2GHz)	
Output level linearity	<ul style="list-style-type: none"> <li>● Power meter</li> <li>Frequency : 40MHz to 3.8GHz (R3765)</li> <li>Power range : -15dBm to +17dBm</li> </ul>	HP436A/HP437B(HP438A) (Calibrated under the national standard)	Refer to page 10-6.
	<ul style="list-style-type: none"> <li>● Power sensor</li> <li>Frequency : 40MHz to 3.8GHz</li> <li>Power range : -15dBm to +17dBm</li> </ul>	HP8482A (100kHz to 4.2GHz)	
Directivity	<ul style="list-style-type: none"> <li>● Calibration kit</li> </ul>	Model 9617A3 (DC to 18GHz, N type connector)	Refer to page 10-7.
Test port load match	<ul style="list-style-type: none"> <li>● Calibration kit</li> </ul>	Model 9617A3 (DC to 18GHz, N type connector)	Refer to page 10-9.
	<ul style="list-style-type: none"> <li>● Directivity bridge</li> </ul>	ZRB2VAR-52 (5MHz to 3GHz)	
Crosstalk	<ul style="list-style-type: none"> <li>● Calibration kit</li> </ul>	Model 9617A3 (DC to 18GHz, N type connector)	Refer to page 10-18.

## ■ General Note

- Use an AC power source having a voltage of 90V to 250V and a frequency of 48Hz to 66Hz.
- When connecting the power supply cable, OFF the POWER switch.
- The analyzer must be calibrated under the following conditions:  
 Temperature : +25°C to ±5°C  
 Relative humidity : 80% RH or less  
 Free from dust, vibration, and noise.

## 2. Frequency Accuracy and Range

### □ Testing procedure

1. Setup the analyzer as follows:

For A type, connect to "SOURCE" terminal. For B/C type, to "TEST PORT 1".

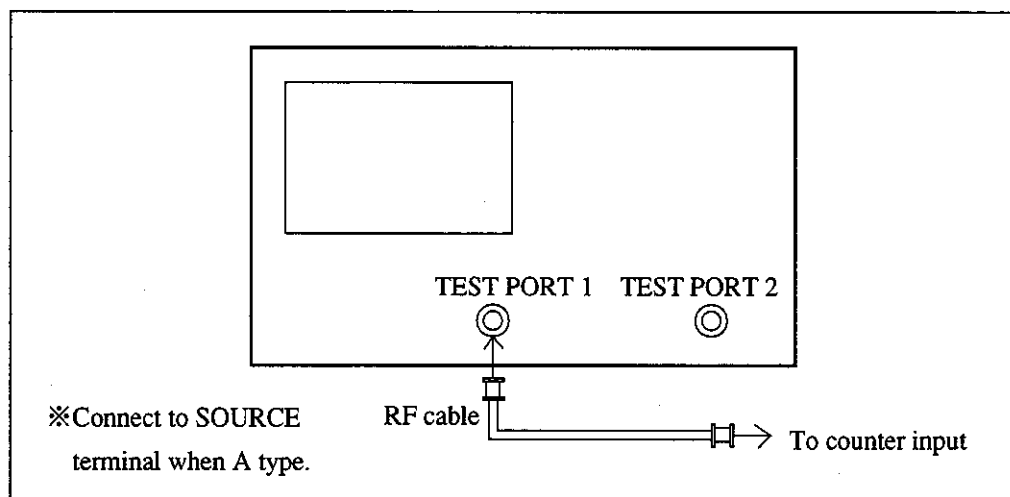

Figure 10-1 Frequency Accuracy and Range

2. Set the analyzer as follows:

Span: 0Hz  
Trigger mode: HOLD

3. Change any center frequency in the range of 40MHz to 3.8GHz (R3767 Series; to 8.0GHz).

4. **Check :**

Counter read frequency < center frequency  $\pm$  center frequency  $\times 20 \times 10^{-6}$

《Example》

When the center frequency is 100MHz : 100MHz  $\pm$  2kHz  
That is, 99,998,000Hz to 100,002,000Hz is enable.

### 3. Output Level Accuracy and Flatness

#### ■ Setup

Set up the analyzer as follows:

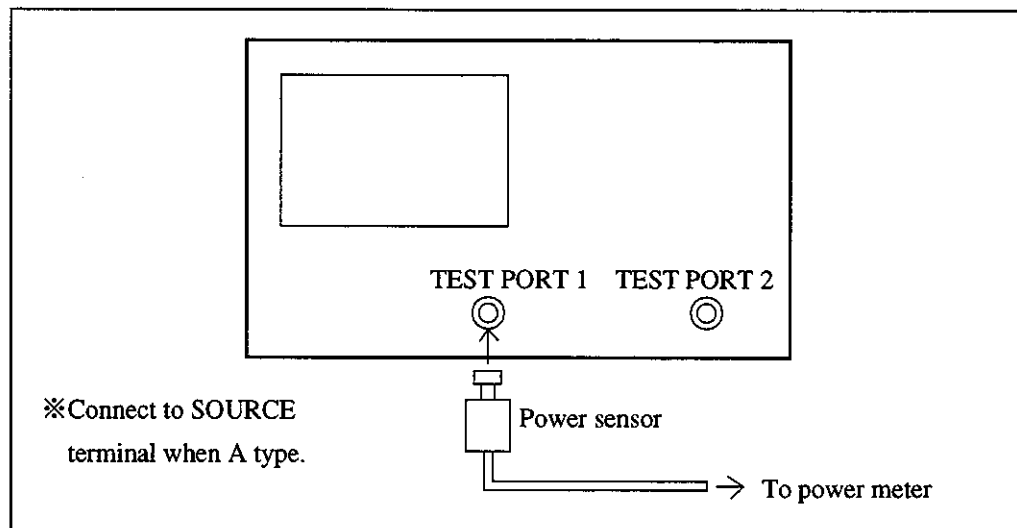

Figure 10-2 Output Level Accuracy and Flatness

#### ■ Output Level Accuracy

##### Testing procedure

1. Calibrate the power meter to zero.
  2. Set analyzer as follows.
 

Center frequency :	50MHz
Span :	0Hz
Output level :	0dBm
Sweep mode :	HOLD
  3. Connect the power sensor to the output terminal and perform the measurement.
 

Connect to "SOURCE" terminal for A type and to "TEST PORT 1" for B/C type.
- Note :** The calibration factor is set to 50MHz.
4. **Check :** Output level accuracy (at 0dBm and 50MHz)  $\pm 0.5$ dB

**■ Flatness** Testing procedure

1. Calibrate the power meter to zero.
2. Set the analyzer as follows:  
  
Center frequency : 50MHz  
Span : 0Hz  
Output level : 0dBm  
Sweep mode : HOLD
3. Press the [REL] of the power meter and set to 0dB (ratio test mode).
4. The span and output level are fixed. Change the center frequency and obtain data from the power meter.  
**Note :** Use the calibration factor at the center frequency.
5. **Check :** Flatness (at 0dBm) 40MHz to 3.8GHz  $\pm 2.0$ dB

**Note :** In the case of R3767 series, leveling is not performed for over 3.8GHz.

## 4. Output Level Linearity

### □ Testing procedure

1. Calibrate the power meter to zero.
2. Set analyzer as follows.
  - Center frequency : 50MHz
  - Span : 0Hz
  - Output level : 0dBm
  - Sweep mode : HOLD
3. Connect the power sensor to the output terminal and perform the measurement. (See Figure 10-3.)  
Connect to "SOURCE" terminal for A type and to "TEST PORT 1" for B/C type.

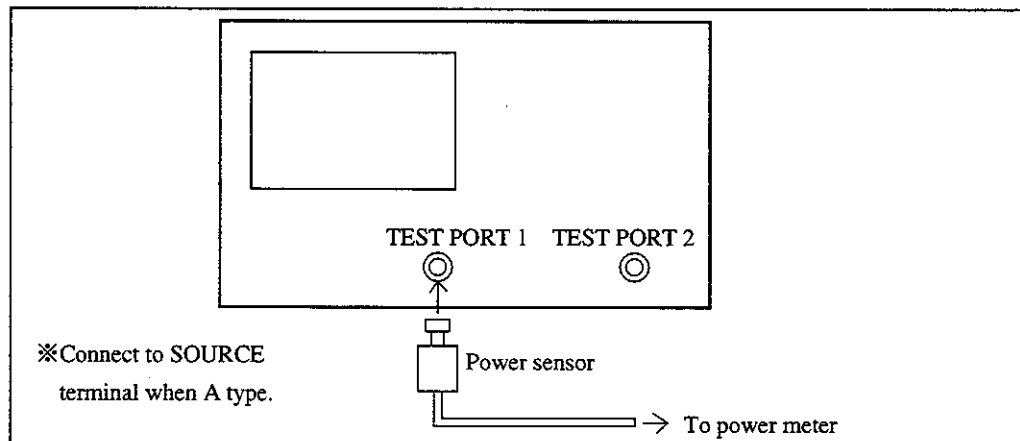

Figure 10-3 Output Level Linearity

4. Press the [REL] and set to 0dB (ratio test mode).
5. When changing the output level, obtain linearity data.  
**Note :** The calibration factor is set to 50MHz.
6. **Check :**
  - For R3765A/3767A (Reference +7dBm)
    - $\pm 0.4\text{dB}$  (+12dBm to -3dBm)
    - $\pm 0.7\text{dB}$  (+17dBm to -8dBm)
  - For R3765B/3767B (Reference -3dBm)
    - $\pm 0.4\text{dB}$  (+10dBm to -5dBm)
    - $\pm 0.7\text{dB}$  (+15dBm to -10dBm)
  - For R3765C/3767C (Reference 0dBm)
    - $\pm 0.4\text{dB}$  (+5dBm to -10dBm)
    - $\pm 0.7\text{dB}$  (+10dBm to -15dBm)

## 5. Directivity

### □ Testing procedure

1. Set up as follows.

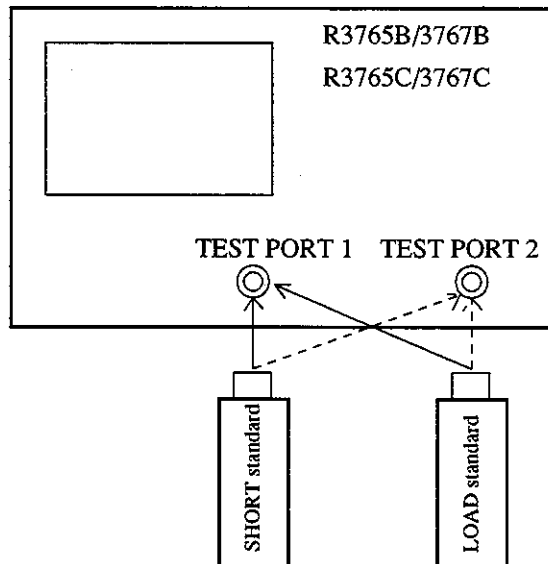

In the case of R3765B and R3767B,  
only full line (TEST PORT 1)

2. Perform the normalize (SHORT) of TEST PORT 1.
  - (1) [MEAS] [S11 (A/R) REFL FWD] or [MEAS] [REFLECTION] .
  - (2) Connect the short standard to TEST PORT 1.
  - (3) [CAL] [NORMALIZE (SHORT)] .
3. Connect the load standard to TEST PORT 1 and read the value of directivity from waveform data with the marker.
4. **Check :** The directivity of TEST PORT 1 (in  $25^{\circ}\text{C} \pm 5^{\circ}\text{C}$ )
 

40MHz to 2.6GHz :	under -30dB
2.6GHz to 3.8GHz :	under -26dB
3.8GHz to 8.0GHz :	under -22dB (R3767B/3767C only)

5. Directivity

●The following operating procedure is only for R3765C/3767C.

5. Perform the normalize (SHORT) of TEST PORT 2.
  - (1) [MEAS] [S22 (B/R) REFL REV] .
  - (2) Connect the short standard to TEST PORT 2.
  - (3) [CAL] [NORMALIZE (SHORT)] .
  - (4) Remove the short standard.
  
6. Connect the load standard to TEST PORT 2 and read the value of directivity from waveform data with the marker.
  
7. **Check :** The directivity of TEST PORT 2 (in  $25^{\circ}\text{C} \pm 5^{\circ}\text{C}$ )
  - 40MHz to 2.6GHz : under -30dB
  - 2.6GHz to 3.8GHz : under -26dB
  - 3.8GHz to 8.0GHz : under -22dB (R3767C only)



## 6. Load Match of Test Port

### ■ When R3765A/3767A

#### ● Load match measurement of A PORT

#### □ Testing procedure

1. Set up as follows.

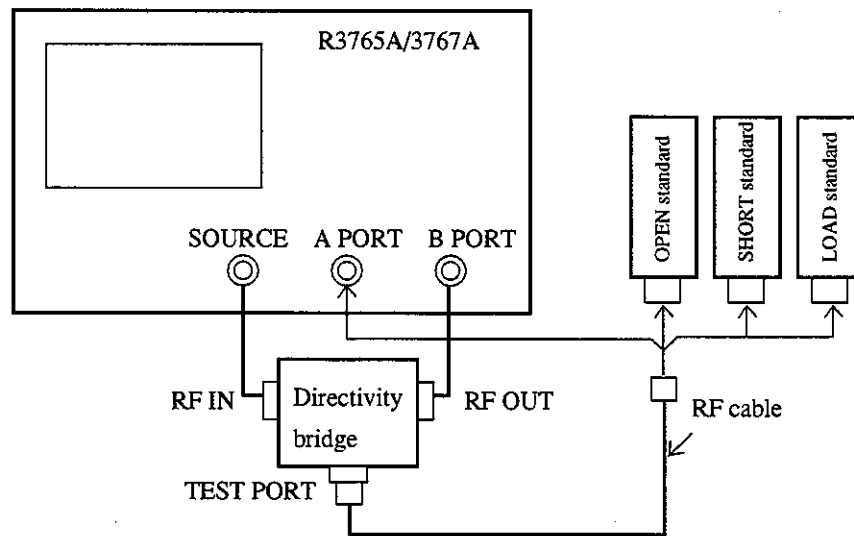

2. Perform 1 port full calibration

- (1) [MEAS] [B/R] .
- (2) [CAL] [CAL MENU] [1 PORT FULL CAL] .
- (3) Connect the open standard to the tip of RF cable and press [OPEN] .
- (4) Connect the short standard to the tip of RF cable and press [SHORT] .
- (5) Connect the load standard to the tip of RF cable and press [LOAD] .
- (6) Press [DONE 1 PORT] .

## 6. Load Match of Test Port

3. Connect A PORT of the analyzer and the tip of RF cable.
4. Read the load match of A PORT from waveform data with the marker.
5. **Check:** A PORT load match (in  $25\text{ }^{\circ}\text{C} \pm 5\text{ }^{\circ}\text{C}$ )

40MHz to 2.6GHz :	under -18dB
2.6GHz to 3.8GHz :	under -16dB
3.8GHz to 8.0GHz :	under -14dB (R3767A only)

● Load match measurement of B PORT

□ Testing procedure

1. Set up as follows.

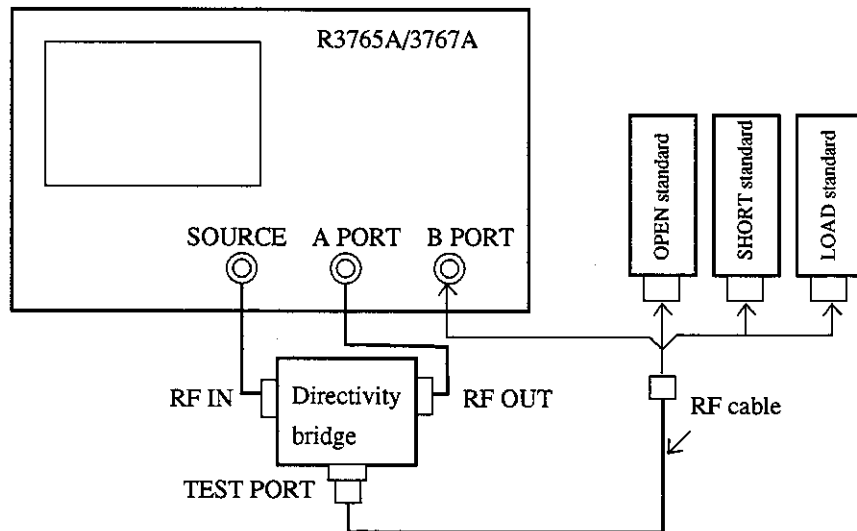

2. Perform 1 port full calibration.

- (1) [MEAS] [A/R] .
- (2) [CAL] [CAL MENU] [1 PORT FULL CAL] .
- (3) Connect the open standard to the tip of RF cable and press [OPEN] .
- (4) Connect the short standard to the tip of RF cable and press [SHORT] .
- (5) Connect the load standard to the tip of RF cable and press [LOAD] .
- (6) Press [DONE 1 PORT] .

3. Connect A PORT of the analyzer and the tip of RF cable.
4. Read the load match of B PORT from waveform data with the marker.
5. **Check:** B PORT load match (in  $25\text{ }^{\circ}\text{C} \pm 5\text{ }^{\circ}\text{C}$ )

40MHz to 2.6GHz : under -18dB

2.6GHz to 3.8GHz : under -16dB

3.8GHz to 8.0GHz : under -14dB (R3767A only)

## 6. Load Match of Test Port

## ■ When R3765B/3767B

## □ Testing procedure

1. Set up as follows.

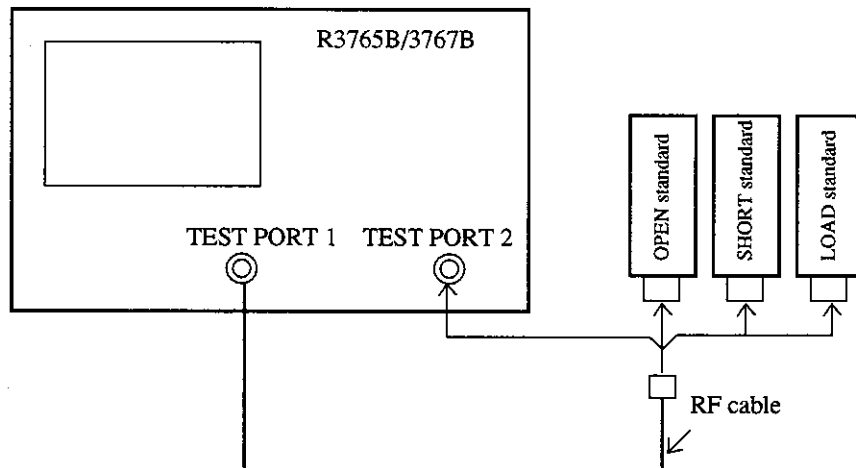

2. Perform 1 port full calibration

- (1) [MEAS] [REFLECTION] .
- (2) [CAL] [CAL MENU] [1 PORT FULL CAL] .
- (3) Connect the open standard to the tip of RF cable and press [OPEN] .
- (4) Connect the short standard to the tip of RF cable and press [SHORT] .
- (5) Connect the load standard to the tip of RF cable and press [LOAD] .
- (6) Press [DONE 1 PORT] .

3. Connect TEST PORT 2 of the analyzer and the tip of RF cable.

4. Read the load match of TEST PORT 2 from waveform data with the marker.

5. **Check:** TEST PORT 2 load match (in  $25^{\circ}\text{C} \pm 5^{\circ}\text{C}$ )

40MHz to 2.6GHz :	under -18dB
2.6GHz to 3.8GHz :	under -16dB
3.8GHz to 8.0GHz :	under -14dB (R3767B only)

## ■ When R3765C/3767C

### ● Load match measurement of TEST PORT 1

#### □ Testing procedure

1. Set up as follows.

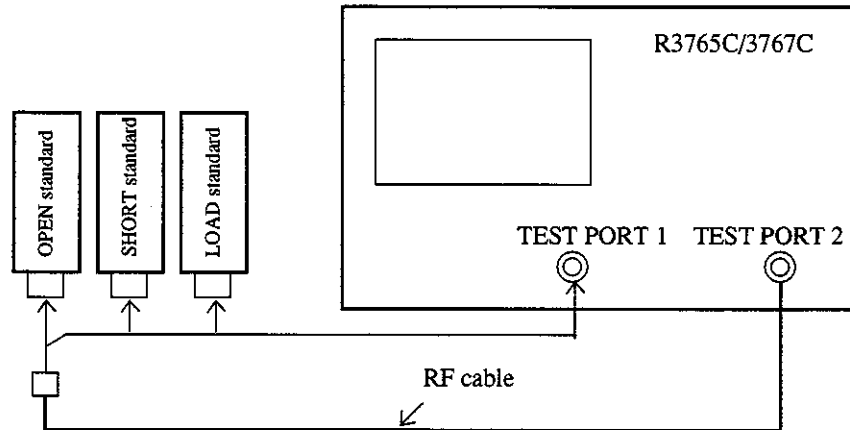

2. Perform 1 port full calibration

- (1) [MEAS] [S22 (B/R) REFL REV] .
- (2) [CAL] [CAL MENU] [1 PORT FULL CAL] .
- (3) Connect the open standard to the tip of RF cable and press [OPEN] .
- (4) Connect the short standard to the tip of RF cable and press [SHORT] .
- (5) Connect the load standard to the tip of RF cable and press [LOAD] .
- (6) Press [DONE 1 PORT] .

3. Connect TEST PORT 1 of the analyzer and the tip of RF cable.

4. Read the load match of TEST PORT 1 from waveform data with the marker.

5. **Check:** TEST PORT 1 load match (in  $25^{\circ}\text{C} \pm 5^{\circ}\text{C}$ )

- |                    |                           |
|--------------------|---------------------------|
| 40MHz to 2.6GHz :  | under -18dB               |
| 2.6GHz to 3.8GHz : | under -16dB               |
| 3.8GHz to 8.0GHz : | under -14dB (R3767C only) |

## 6. Load Match of Test Port

## ● Load match measurement of TEST PORT 2

## □ Testing procedure

1. Set up as follows.

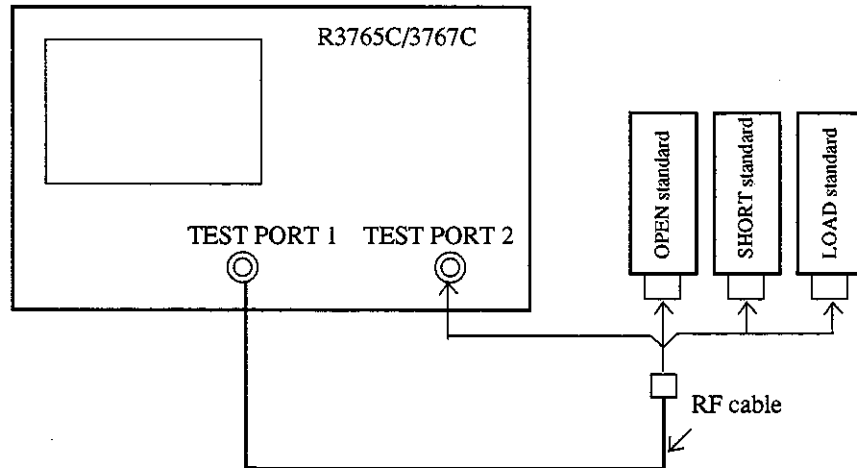

2. Perform 1 port full calibration
  - (1) [MEAS] [S11 (A/R) REFL FWD] .
  - (2) [CAL] [CAL MENU] [1 PORT FULL CAL] .
  - (3) Connect the open standard to the tip of RF cable and press [OPEN] .
  - (4) Connect the short standard to the tip of RF cable and press [SHORT] .
  - (5) Connect the load standard to the tip of RF cable and press [LOAD] .
  - (6) Press [DONE 1 PORT] .
3. Connect TEST PORT 2 of the analyzer and the tip of RF cable.
4. Read the load match of TEST PORT 2 from waveform data with the marker.
5. **Check:** TEST PORT 2 load match (in  $25^{\circ}\text{C} \pm 5^{\circ}\text{C}$ )
 

40MHz to 2.6GHz :	under -18dB
2.6GHz to 3.8GHz :	under -16dB
3.8GHz to 8.0GHz :	under -14dB (R3767C only)

## 7. Noise Level

### Testing procedure

#### 1. Set the analyzer as follows.

- (1) [SCALE] [/DIV] [1] [0] [×1] .
- (2) [AVG] [SMOOTHING ON] [SMOOTHING APERTURE] [2] [0] [×1] .
- (3) [SYSTEM] [SERVICE MENU] [SERVICE MODES] [SOURCE PLL OFF] .

●For R3765A/3767A, go to step 2.

●For R3765B/3767B, go to step 3.

●For R3765C/3767C, go to step 4.

---

#### A D V I C E

1. The phase lock of the analyzer's signal source is set to OFF by this operation, so that the receiver section is not affected by the leakage from the signal source, by which only the noise level in the receiver section can be measured.
  2. The input port must not be connected with anything.
- 

#### 2. When R3765A/3767A

●Measure the noise level of A input and B input according to the following procedure.

- (1) Press [MEAS] & [A] to display the noise level of A input.
- (2) Read the noise level value by the marker.
- (3) Press [MEAS] & [B] to display the noise level of B input.
- (4) Read the noise level value by the marker.

#### Check :

Noise level under -90dB (10kHz bandwidth)

7. Noise Level

3. When R3765B/3767B

- (1) Press [SYSTEM] , [MEAS SUB MENU] & [B] to display the noise level of B input.
- (2) Read the noise level value by the marker.

**Check :**

Noise level under -90dB (10kHz bandwidth)

4. When R3765C/3767C

●Measure the noise level of B input.

- (1) [MEAS] [S21 (B/R) TRANS FWD] .
- (2) Press [SYSTEM] , [MEAS SUB MENU] & [B] to display the noise level of B input.
- (3) Read the noise level value by the marker.

●Measure the noise level of A input.

- (1) [MEAS] [S12 (A/R) TRANS REV] .
- (2) Press [SYSTEM] , [MEAS SUB MENU] & [A] to display the noise level of A input.
- (3) Read the noise level value by the marker.

**Check :**

Noise level under -75dB (10kHz bandwidth)



## 8. Crosstalk

### ■ When R3765A/3767A

#### ● Crosstalk measurement of A PORT

#### □ Testing procedure

1. Set up as follows.

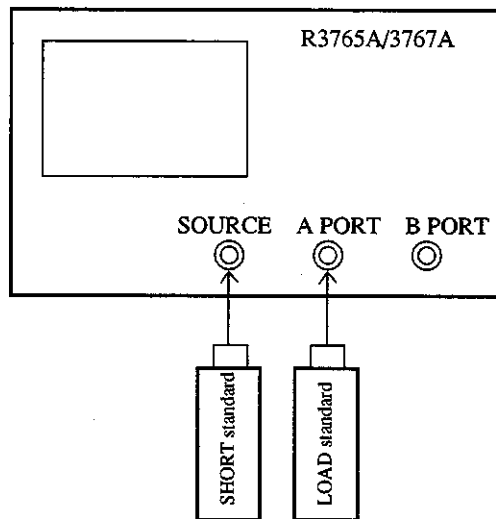

2. Set up the analyzer.

MEAS : A/R  
 RBW : 100Hz  
 Average : 16 times

3. Connect the short standard to the SOURCE terminal.
4. Connect the load standard to A PORT.
5. Read the crosstalk value of A PORT from the waveform data.
6. **Check :** Crosstalk of A PORT

40MHz to 3.8GHz : under -90dB  
 3.8GHz to 5.0GHz : under -80dB (R3767A only)  
 5.0GHz to 8.0GHz : under -70dB (R3767A only)

8. Crosstalk

● Crosstalk measurement of B PORT

□ Testing procedure

1. Set up as follows.

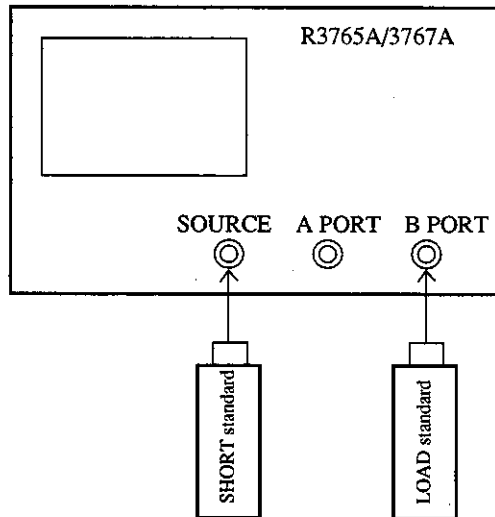

2. Set up the analyzer.

MEAS : B/R  
 RBW : 100Hz  
 Average : 16 times

3. Connect the short standard to the SOURCE terminal.
4. Connect the load standard to B PORT.
5. Read the crosstalk value of B PORT from the waveform data.
6. **Check :** Crosstalk of B PORT

40MHz to 3.8GHz : under -90dB  
 3.8GHz to 5.0GHz : under -80dB (R3767A only)  
 5.0GHz to 8.0GHz : under -70dB (R3767A only)

## ■ When R3765B/3767B

### □ Testing procedure

1. Set up as follows.

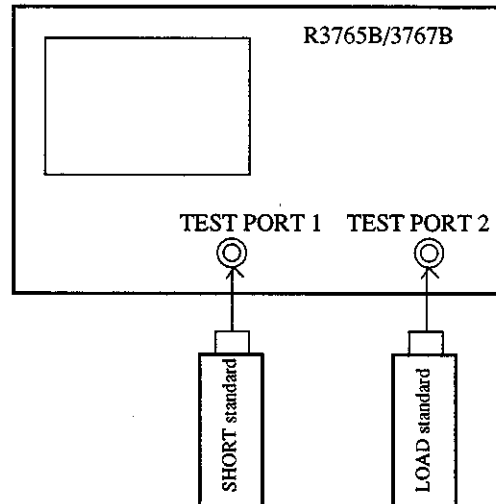

2. Set up the analyzer.

MEAS : TRANSMISSION  
 RBW : 100Hz  
 Average : 16 times

3. Connect the short standard to TEST PORT 1.
4. Connect the load standard to TEST PORT 2.
5. Read the crosstalk value from the waveform data.
6. **Check :** Crosstalk (only about TEST PORT)

40MHz to 3.8GHz : under -90dB  
 3.8GHz to 5.0GHz : under -80dB (R3767B only)  
 5.0GHz to 8.0GHz : under -70dB (R3767B only)

■ When R3765C/3767C

● Crosstalk of TEST PORT 1

□ Testing procedure

1. Set up as follows.

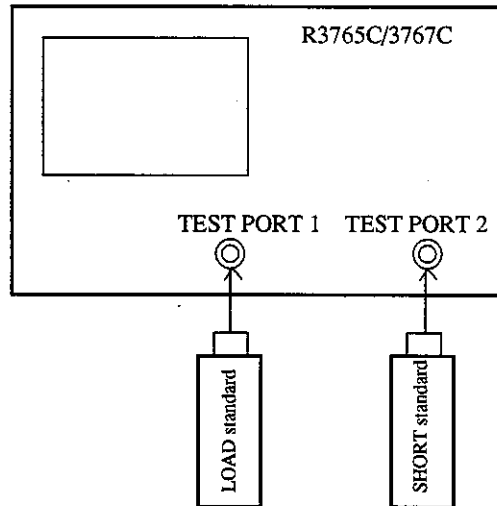

2. Set up the analyzer.

MEAS : S12  
RBW : 100Hz  
Average : 16 times

3. Connect the short standard to TEST PORT 2.
4. Connect the load standard to TEST PORT 1.
5. Read the crosstalk value of TEST PORT 1 from the waveform data.
6. **Check:** Crosstalk of TEST PORT 1

40MHz to 2.6GHz : under -90dB  
2.6GHz to 3.8GHz : under -85dB  
3.8GHz to 5.0GHz : under -70dB (R3767C only)  
5.0GHz to 8.0GHz : under -60dB (R3767C only)

● Crosstalk of TEST PORT 2

□ Testing procedure

1. Set up as follows.

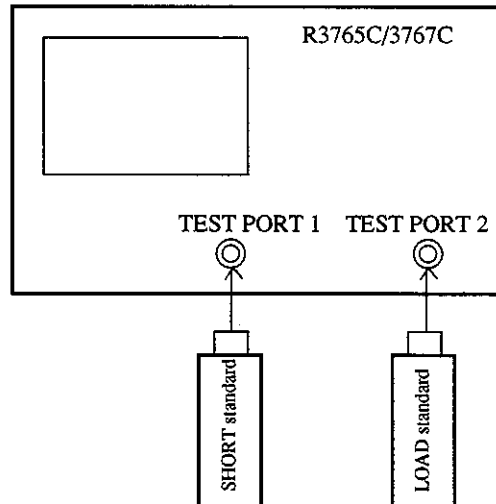

2. Set up the analyzer.

MEAS : S21  
 RBW : 100Hz  
 Average : 16 times

3. Connect the short standard to TEST PORT 1.
4. Connect the load standard to TEST PORT 2.
5. Read the crosstalk value of TEST PORT 2 from the waveform data.
6. **Check:** Crosstalk of TEST PORT 2

40MHz to 2.6GHz : under -90dB  
 2.6GHz to 3.8GHz : under -85dB  
 3.8GHz to 5.0GHz : under -70dB (R3767C only)  
 5.0GHz to 8.0GHz : under -60dB (R3767C only)

MEMO 

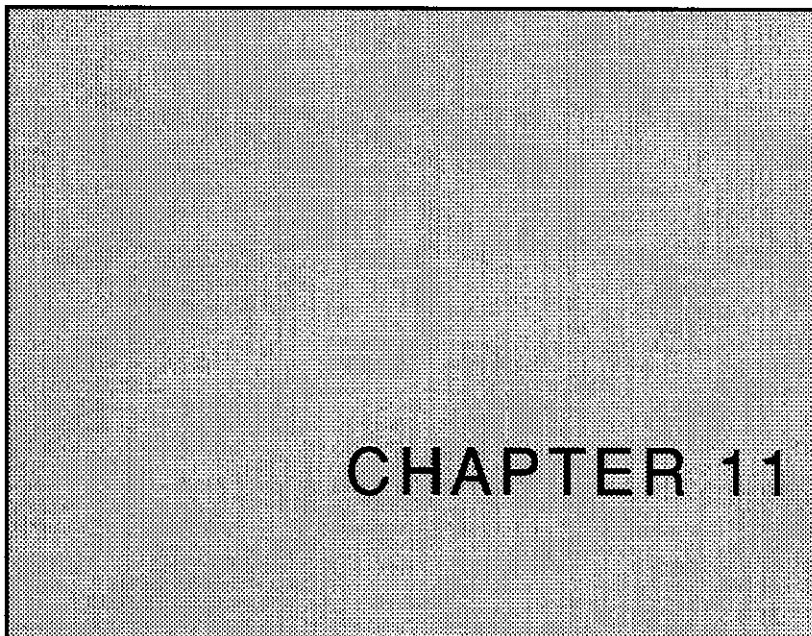

# SPECIFICATION

This chapter describes about the function of the analyzer and the performance/specification together.

---

## CONTENTS

---

Measurement Function .....	11-2
Signal Source Section .....	11-3
Characteristic of the Receiver Part .....	11-5
Test Port Characteristic .....	11-7
Error Compensation Function .....	11-8
Display Section .....	11-9
Other Functions .....	11-10
Program Function .....	11-10
Connection to External Devices .....	11-11
General Specification .....	11-11

---

## ■ Measurement Function

Sweep channel	2 channel (CH1, CH2)
Display channel	4 channel (CH1, CH2, CH3, CH4)
Trace	2 traces/channels
Display parameter	A/R, B/R, A, B, R (R3765A/3767A)  TRANSMISSION, REFLECTION, TRANS&REFL (R3765B/3767B)  S11, S21, S22, S12, S11&S21, S22&S12 (R3765C/3767C)
Parameter conversion	Z, Y, 1/S (All type)
Format	
Rectangular display	The real part and the imaginary part of log/linear magnitude, phase, group-delay, or complex number.   Z   , R, X (when impedance-conversion measurement)   Y   , G, B (when admittance-conversion measurement) Phase-delay display function
Smith chart	Reading with marker is for log/linear magnitude & phase, real part + imaginary part, $R + jX$ , $G + jB$ .
Polar coordinates display	Reading with marker is for log/linear magnitude & phase, real part + imaginary part.



## ■ Signal Source Section

<b>Measurement frequency</b> <b>Range</b>  <b>Setting resolution</b> <b>Measurement resolution</b> <b>Accuracy</b>	40MHz to 3.8GHz (R3765A/B/C) 40MHz to 8.0GHz (R3767A/B/C)  1Hz $\pm 0.005\text{ppm}$ $\pm 20\text{ppm}$ ( $25^{\circ}\text{C} \pm 5^{\circ}\text{C}$ )
<b>Output level (40MHz to 3.8GHz)</b> <b>Range</b>  <b>Resolution</b>  <b>Accuracy</b>  <b>Output level linearity</b>  <b>Flatness</b>	+17dBm to -8dBm (R3765A, R3767A) +7dBm to -18dBm (R3765B, R3767B) +10dBm to -15dBm (R3765C, R3767C)  0.01dB  $\pm 0.5\text{dB}$ (50MHz, 0dB, $25^{\circ}\text{C} \pm 5^{\circ}\text{C}$ ) (at Test Port 1 when R3765C & R3767C)  $25^{\circ}\text{C} \pm 5^{\circ}\text{C}$ ● +7dBm reference when R3765A/3767A $\pm 0.4\text{dB}$ (+12dBm to -3dBm) $\pm 0.7\text{dB}$ (+17dBm to -8dBm) ● -3dBm reference when R3765B/3767B $\pm 0.4\text{dB}$ (+10dBm to -5dBm) $\pm 0.7\text{dB}$ (+15dBm to -10dBm) ● 0dBm reference when R3765C/3767C $\pm 0.4\text{dB}$ (+5dBm to -10dBm) $\pm 0.7\text{dB}$ (+10dBm to -15dBm)  $2.0\text{dBp-p}$ ( $25^{\circ}\text{C} \pm 5^{\circ}\text{C}$ ) (at Test Port 1 when R3765C & R3767C)
<b>Output level (3.8GHz to 8.0GHz)</b>  <b>Output impedance</b>	Output level fixed -3dBm or more (R3767A) -16dBm or more (R3767B) -13dBm or more (R3767C)  50 $\Omega$

## Signal Source Section

Signal purity	
Harmonic distortion	$\leq -20\text{dBc}$ (40MHz to 3.8GHz, 25 °C $\pm$ 5 °C when maximum output)
Non harmonic spurious	$\leq -25\text{dBc}$ (40MHz to 3.8GHz, 25 °C $\pm$ 5 °C when maximum output)
Phase noise	10kHz offset, 1kHz bandwidth, $-85\text{dBc} + 20\log(f/40\text{MHz})$ when maximum output
Sweep function	
Sweep parameter	Frequency, signal level
Maximum sweep range	
Frequency	40MHz to 3.8GHz (R3765A/B/C) 40MHz to 8.0GHz (R3767A/B/C)
Signal level (40MHz to 3.8GHz)	+17dBm to -8dBm (R3765A, R3767A) +7dBm to -18dBm (R3765B, R3767B) +10dBm to -15dBm (R3765C, R3767C)
Sweep type	Start/Stop or Center/Span Linear/log frequency sweep, sweep by partial and arbitrary frequency, level sweep, and CW (single frequency) sweep
Sweep time	0.15ms/1 point (when the normalize cal. used) 0.25ms/1 point (when the 2 port full cal. used) However, the minimum sweeping time is different depending on the measuring format, the type of error compensation, the sweeping width per point, the measuring point number, and the measuring IF bandwidth.
Measuring point	3, 6, 11, 21, 51, 101, 201, 301, 401, 601, 801, 1201 point
Sweep trigger	Sets with either 'sequence, hold, single sweep' or 'external trigger'.
Sweep mode	
Dual sweep	Sweeps 2 channels in the same frequency range.
Alternate sweep	2 channels (CH1 and CH2) can be measured with different sweep types and in different frequency ranges.



Characteristic of the Receiver Part

<p>Group delay-time characteristic Range</p>	<p>Can be obtained by the following equation.  <math display="block">\tau = \frac{\Delta \phi}{360 \times \Delta f}</math> <p style="text-align: right;"> <math>\Delta \phi</math> : Phase  <math>\Delta f</math> : Aperture frequency (Hz)                 </p> </p>
<p>Measurement range</p>	<p>1ps to 250s</p>
<p>Group delay-time resolution</p>	<p>1ps</p>
<p>Aperture frequency</p>	<p>equals <math>\Delta f</math> and can be set optionally up to 100% from  <math>\frac{100}{\text{measurement point-1}} \times 2\%</math> of the frequency span in the resolution of  <math>\frac{100}{\text{measurement point-1}} \times 2\%</math> .</p>
<p>Accuracy</p>	<p><math>\frac{\text{phase accuracy}}{360 \times \text{aperture frequency (Hz)}}</math></p>

## ■ Test Port Characteristic

Test port load match	<p>※25°C ± 5°C</p> <p>18dB (40MHz to 2.6GHz)</p> <p>16dB (2.6GHz to 3.8GHz)</p> <p>14dB (3.8GHz to 8.0GHz) *R3767A/B/C only</p>
Directivity	<p>※25°C ± 5°C</p> <p>30dB (40MHz to 2.6GHz)</p> <p>26dB (2.6GHz to 3.8GHz)</p> <p>22dB (3.8GHz to 8.0GHz) *R3767B/C only</p>
Crosstalk	<p>●When R3765A/B</p> <p>90dB (40MHz to 3.8GHz)</p> <p>●When R3767A/B</p> <p>90dB (40MHz to 3.8GHz)</p> <p>80dB (3.8GHz to 5.0GHz)</p> <p>70dB (5.0GHz to 8.0GHz)</p> <p>●When R3765C</p> <p>90dB (40MHz to 2.6GHz)</p> <p>85dB (2.6GHz to 3.8GHz)</p> <p>●When R3765C/3767C</p> <p>90dB (40MHz to 2.6GHz)</p> <p>85dB (2.6GHz to 3.8GHz)</p> <p>70dB (3.8GHz to 5.0GHz)</p> <p>60dB (5.0GHz to 8.0GHz)</p>
Connector	N type (f), 50 Ω
Noise level	<p>From the test port maximum input level</p> <p>-90dB (3kHz bandwidth)</p> <p>-100dB (10Hz bandwidth)</p>
Maximum input level	<p>0dBm (R3765A/B, R3767A/B)</p> <p>+12dBm (R3765C, R3767C)</p>
Maximum port-biased	±30V <sub>DC</sub> , 0.5A (R3765C, R3767C)
Input head damage level	+21dBm, ±30V <sub>DC</sub>

## ■ Error Compensation Function

Normalize	Frequency response (both magnitude and phase) in transmission measurement and reflection measurement is compensated.
Normalize & isolation	Frequency response and isolation in transmission measurement are compensated.
1 port calibration	The error caused by bridge directivity, frequency response, and source match in reflection measurement is compensated. For the error compensation, the short, the open, and the load are required.
2 ports calibration	The error caused by directivity, source match, load match, frequency response, and isolation in transmission measurement and reflection measurement is compensated. (R3765C and R3767C only)
Data averaging	Average of each sweep data (vector value) The average factor can be set between 2 to 999.
Data smoothing	Average of moving between adjacent measurement points.
Electrical length compensation	Add equivalent electrical length or delay-time to the measured phase and the group delay-time.
Phase offset compensation	Add phase offset to the measured phase constantly.
Calibration by frequency compensation	In the calibration by frequency interpolation mode, the error count is performed the difference calculation even when the frequency and the horizontal axis point number are changed. Change of the frequency range (start/stop) is applied within the frequency range of the first calibration.

## ■ Display Section

Displaying device	7.8 inch TFT color liquid display
Resolution	640 × 480 dot
Display mode	Rectangular log/linear coordinates, polar coordinates, smith chart (impedance/admittance display)
Display format	Single channel 2 channels (overlap-display, separate-display) 4 channels (separate-display)
Measuring conditions display	Start/Stop Center/Span Scale/DIV Reference level Marker value Soft key function Warning message
Position of the reference line	The top (100%) to the bottom (0%) of the vertical axis memory
Auto-scale	The reference and the scale are set to display the trace under measurement in the best form.
Brightness	ON/OFF of backlight is possible.

■ Other Functions

Marker function	
Marker display	Marker reading can be converted to the display value corresponding to each measurement format.
Multi-marker	Independent 10 markers can be set to each channel.
Delta-marker	All the ten markers can be specified to the reference marker to measure the delta value between the moved makers.
Marker couple	Each channel marker can be set with both coupled or with separated.
Analysis for any specified section	Marker search can be done in the marker-specified section.
MKR search	MAX search, MIN search
Marker track	Searches at every sweep
Target search	Frequency value of XdB down point bandwidth, middle frequency, calculation of Q, etc., and phase 0° .
MKR→	MKR→ Reference value, MKR→ START, MKR→ STOP, MKR→ CENTER
Limit line function	

■ Program Function

BASIC controller function	The controller function with standard function can control the analyzer itself and other instruments equipped with GPIB interface.
Built-in function	The measured data can be analyzed at a high speed with the built-in function.
FDD function	Based on MS-DOS format. For 3 modes (DD 720KB, HD 1.2MB/1.4MB)



## ■ Connection to External Devices

Signal for external display	15 pins, D-SUB connector (VGA)
GPIB data output & remote control	IEEE488 applicable
Parallel I/O output	TLL level, 8 bit output (2 ports) 4 bit input/output (2 ports)
Serial port	Based on RS232
Keyboard	Based on IBM PC-AT
External reference frequency input	Inputable range 1MHz, 2MHz, 5MHz, 10MHz $\pm$ 10ppm More than 0dBm(50 $\Omega$ )
Power source for probing	$\pm$ 15V $\pm$ 0.5V, 300mA

## ■ General Specification

Operating environment When FDD used.	Temperature range +5 to +40 °C Relative humidity under 80% (non-condensing)
When FDD unused.	Temperature range 0 to +50 °C Relative humidity under 80% (non-condensing)
Storing environment	-20 to +60°C
Power source	AC100V to 120V, 48Hz to 66Hz AC220V to 240V, 48Hz to 66Hz ※Auto-switch between 100VAC type and 200VAC type
Outer dimensions	About 424 (width) $\times$ 220 (height) $\times$ 400 (depth) unit:mm
Quantity	About under 16kg
Power draw	Under 300VA

MEMO 

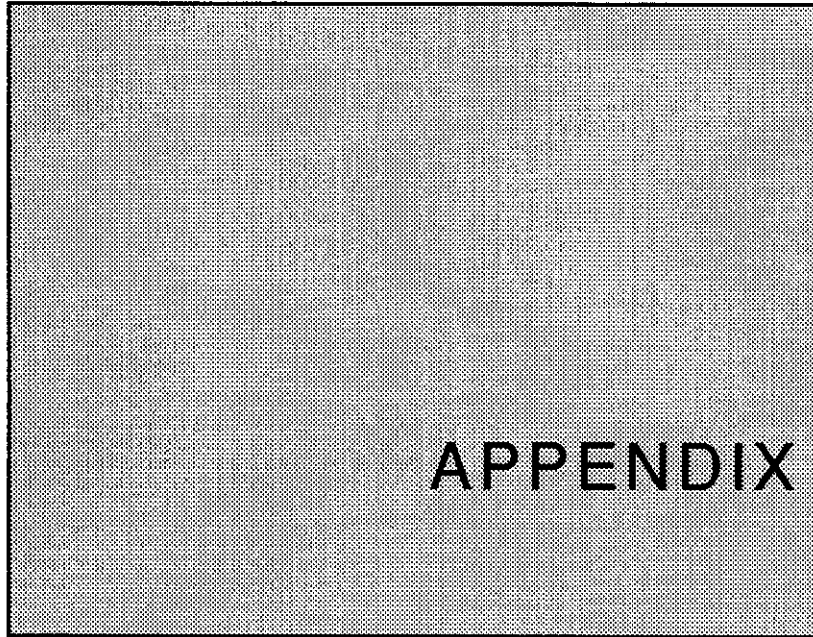

Information for reference useful in operating is described in the APPENDIX.

---

CONTENTS

---

1. The Relation of Data between each Function .....	A-2
2. Measuring Time .....	A-4
3. Initial Setting Value .....	A-5
4. Soft Key Menu List .....	A-9
5. Other Information .....	A-21

---

# 1. The Relation of Data between each Function

Here describes about the relation of data between each function.

## ■ The Relation of Data between each Channel and each Function

Here describes about the relation between the data of each function and each channel.

The sub-channel of channel 1 is channel 3, and the sub-channel of channel 2 is channel 4.

### ● In the case of COUPLE CH ON

Function	Channel			
	CH1	CH3	CH2	CH4
MEAS	○	×	○	×
SUB MEAS	×	○	×	○
STIMULUS / RBW	Common			
Averaging	Common		Common	
Smoothing	Common		Common	
Trace operation	Independent	Independent	Independent	Independent
Parameter conversion	Independent	Independent	Independent	Independent
FORMAT	Independent	Independent	Independent	Independent
Scale	Independent	Independent	Independent	Independent
Marker	Independent	Independent	Independent	Independent
Limit line	Independent	Independent	Independent	Independent

Mark ○ shows that it can be set.

Mark × shows that it cannot be set.

1. The Relation of Data between each Function

● In the case of COUPLE CH OFF

Function	Channel			
	CH1	CH3	CH2	CH4
MEAS	○	×	○	×
SUB MEAS	×	○	×	○
STIMULUS / RBW	Common		Common	
Averaging	Common		Common	
Smoothing	Common		Common	
Trace operation	Independent	Independent	Independent	Independent
Parameter conversion	Independent	Independent	Independent	Independent
FORMAT	Independent	Independent	Independent	Independent
Scale	Independent	Independent	Independent	Independent
Marker	Independent	Independent	Independent	Independent
Limit line	Independent	Independent	Independent	Independent

Mark ○ shows that it can be set.

Mark × shows that it cannot be set.

■ The Data Interlocking to each Item in MEAS Menu.

The data of the following functions are interlocked for each selected input port in the analyzer.  
Also the data of the scale function are interlocked for each FORMAT as well.

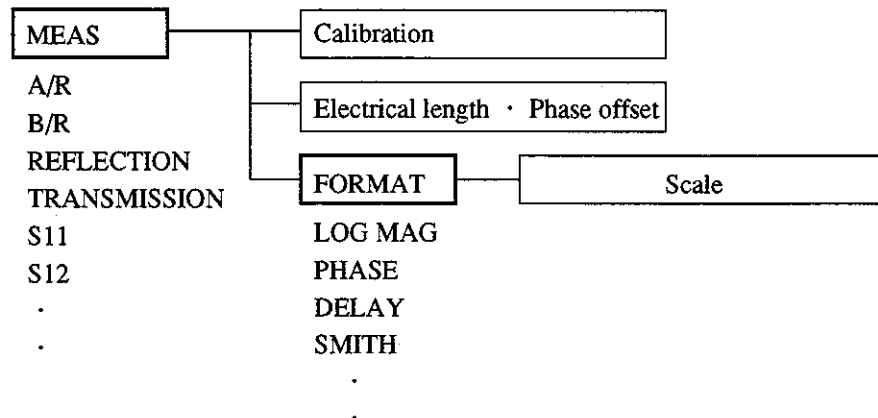

## 2. Measuring Time

The measurement time is the time to acquire the data plus the frequency setup time.

Data acquiring time is set up as SWEEP time.

Frequency setup time is different depending on the frequency setup.

The following shows the typical values.

《Example》

Start frequency            1GHz  
 Stop frequency            2GHz  
 Measuring point number   101 points

- (1) Frequency between measuring points : 10MHz → Setup time, 100 μ sec/point  
 Total setup time is (100 μ sec/point) × 100 points = 10msec.

● When the frequency between the measuring points is more than 5MHz, the setup time is 100 μ sec per about 5MHz.

- (2) Band switching time : About 8msec

● The analyzer is composed by the following frequency bands.  
 Each time the band is switched, the setup time is about 8msec.

Band	Frequency range
1	40MHz to 80MHz
2	80MHz to 160MHz
3	160MHz to 320MHz
4	320MHz to 560MHz
5	560MHz to 1120MHz
6	1120MHz to 2160MHz
7	2160MHz to 3800MHz
8	3800MHz to 6000MHz
9	6000MHz to 8000MHz

- (3) The setup time is the total of (1) and (2), that is 18msec. Therefore, the measurement time is SWEEP TIME plus 18msec.

### 3. Initial Setting Value

Initial Setting Value (1 of 3)

Function	Initialize method	
	Power on or preset	*RST
<b>Stimulus</b>		
Sweep type	Linear frequency sweep	Linear frequency sweep
Continuous sweep	ON	OFF
Trigger source	Internal (FREE RUN)	Internal (FREE RUN)
Trigger delay	OFF (0sec)	OFF (0sec)
Sweep time	190.95msec (AUTO) (R3765A/B/C)	240.2msec (AUTO) (R3765A/B/C)
	402.0msec (AUTO) (R3767A/B/C)	420.35msec (AUTO) (R3767A/B/C)
Measurement point	201	1201
Start frequency	40MHz	40MHz
Stop frequency	3.8GHz (R3765A/B/C)	3.8GHz (R3765A/B/C)
	8.0GHz (R3767A/B/C)	8.0GHz (R3767A/B/C)
Center frequency	1.92GHz (R3765A/B/C)	1.92GHz (R3765A/B/C)
	4.02GHz (R3767A/B/C)	4.02GHz (R3767A/B/C)
Frequency span	3.76GHz (R3765A/B/C)	3.76GHz (R3765A/B/C)
	7.96GHz (R3767A/B/C)	7.96GHz (R3767A/B/C)
Frequency display	Start/Stop	Start/Stop
Fixed frequency of level sweep	1GHz	1GHz
Output level	※1	※1
Start level	※2	※2
Stop level	※2	※2
Two-channel interlocking	ON	ON
Program sweep segment	All clear	All clear
<b>Response</b>		
Dual channel	OFF	OFF
Active channel	CH 1	CH 1
Resolution bandwidth	10kHz	10kHz
Selection item of input port	※3	※3
Average	OFF (Number of times 16)	OFF (Number of times 16)
Trace operation	NONE	NONE
Conversion	NONE	NONE
Characteristic impedance	50 Ω	50 Ω
Measurement format	※4	※4
Group delay aperture	10%	0.01%
Smoothing	OFF (Aperture 10%)	OFF (Aperture 0.01%)
Display	Data	Data
Split/Overlap	Overlap	Overlap
Label	NONE	NONE

3. Initial Setting Value

※1 : Output level

Type	Power on or preset	*RST
A	0dBm	0dBm
B	0dBm	0dBm
C	10dBm	10dBm
A+S parameter		

※2 : Start/Stop level

Type	Power on or preset		*RST	
	Start	Stop	Start	Stop
A	-13dBm	0dBm	-13dBm	22dBm
B	-15dBm	0dBm	-15dBm	20dBm
C	-20dBm	0dBm	-20dBm	10dBm
A+S parameter				

※3 : Selection item of input port

Type	Channel	CH1	CH2	CH3	CH4
A		A/R	B/R	A/R	B/R
B		REFLECTION	TRANSMISSION	REFLECTION	TRANSMISSION
C		S11	S21	S11	S21
A+S parameter					

※4 : Measurement format

Type	Channel	CH1	CH2	CH3	CH4
A		LOG MAG	LOG MAG	LOG MAG	LOG MAG
B		LOG MAG	LOG MAG	POLAR	LOG MAG
C		LOG MAG	LOG MAG	POLAR	LOG MAG
A+S parameter					



## Initial Setting Value (2 of 3)

Function	Initialize method	
	Power on or preset	*RST
<b>Reference value</b>		
Logarithm amplitude	0dB	0dB
Phase	0°	0°
Group delay	0sec	0sec
Smith chart	1	1
Polar coordinate	1	1
Linear amplitude	0	0
SWR	1	1
Real part	10	10
Imaginary part	10	10
Continuous phase	0°	0°
<b>The value per division of Y-axis</b>		
Logarithm amplitude	※5	※5
Phase	45°	45°
Group delay	100nsec	100nsec
Smith chart	—	—
Polar coordinate	—	—
Linear amplitude	100m	100m
SWR	1	1
Real part	1	1
Imaginary part	1	1
Continuous phase	360°	360°
<b>Reference position</b>		
Logarithm amplitude	※6	※6
Phase	50%	50%
Group delay	50%	50%
Smith chart	—	—
Polar coordinate	—	—
Linear amplitude	0%	0%
SWR	0%	0%
Real part	100%	100%
Imaginary part	100%	100%
Continuous phase	50%	50%

## 3. Initial Setting Value

※5 : Logarithm amplitude (the value per division of Y-axis)

Type \ Channel	CH1	CH2	CH3	CH4
A	10dB	10dB	1dB	1dB
B	5dB	10dB	1 UNIT	1dB
C	5dB	10dB	1 UNIT	1dB
A+S parameter				

※6 : Logarithm amplitude (reference position)

Type \ Channel	CH1	CH2	CH3	CH4
A	90%	90%	90%	90%
B	90%	90%	—	90%
C	90%	90%	—	90%
A+S parameter				

## Initial Setting Value (2 of 3)

Function	Initialize method	
	Power on or preset	*RST
<b>Calibration</b>		
Correct measurement	OFF	OFF
Calibration data	Clear	Clear
Electrical length calibration	OFF (0sec)	OFF (0sec)
Phase offset	OFF (0°)	OFF (0°)
Measurement end extension correction	OFF	OFF
R input	0sec	0sec
A input	0sec	0sec
B input	0sec	0sec
Port 1	0sec	0sec
Port 2	0sec	0sec
Transfer constant	1	1

# 4. Soft Key Menu List

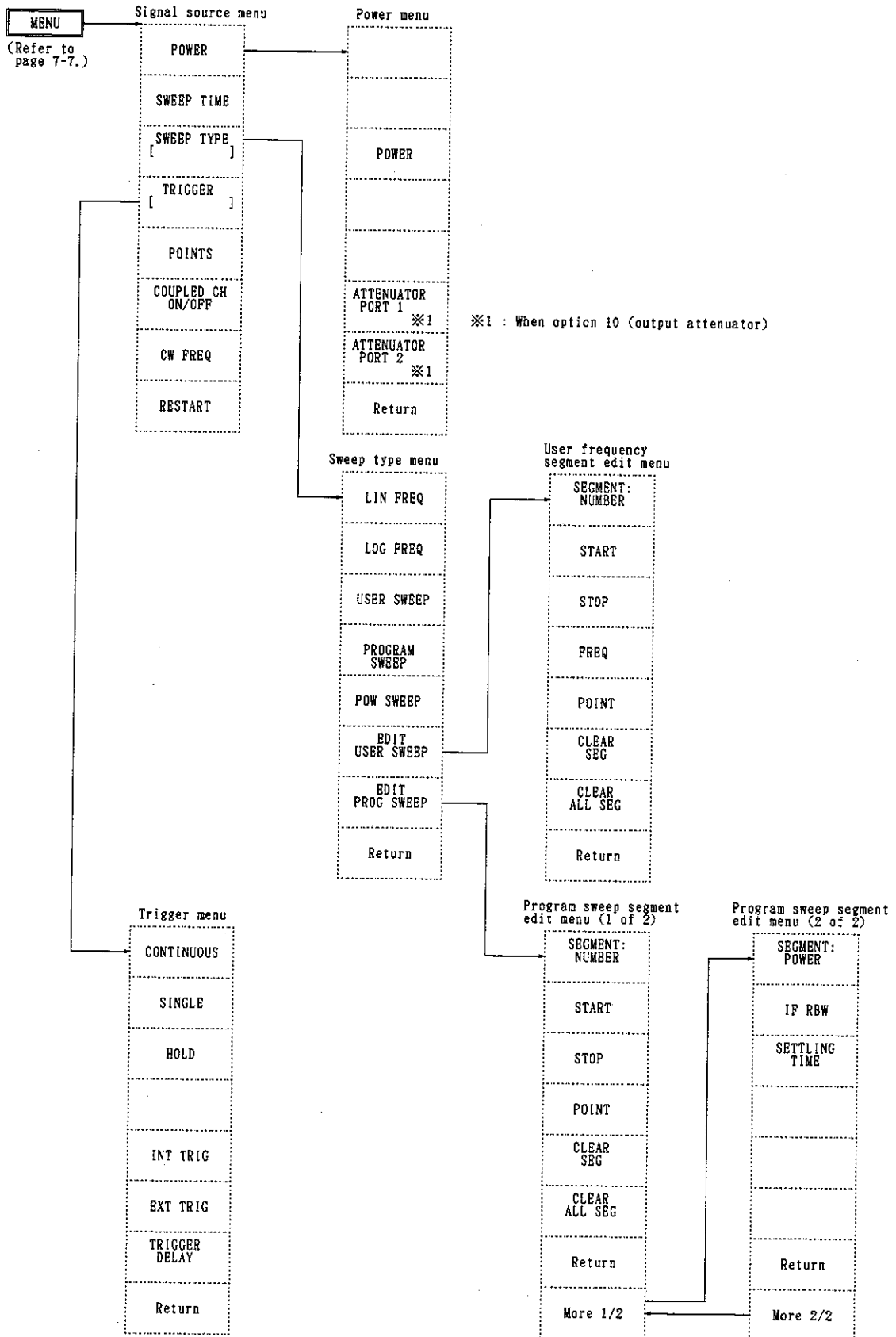

4. Soft Key Menu List

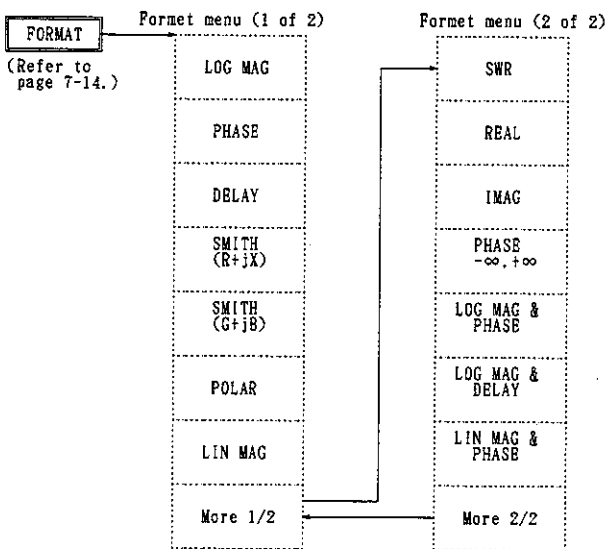
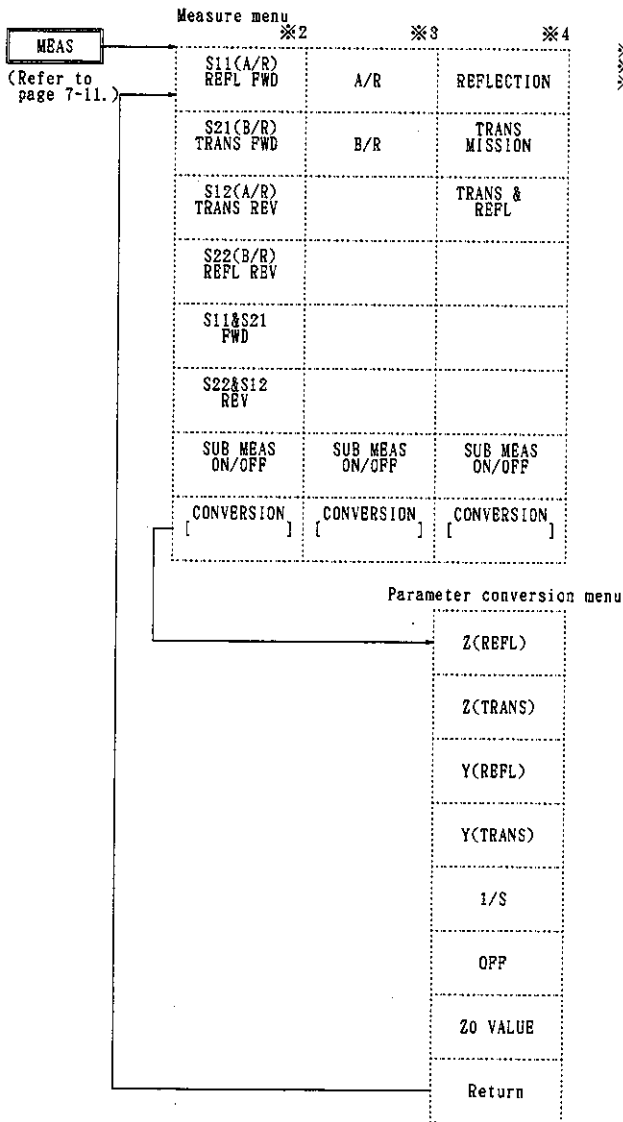

※5 : FULL SCALE is displayed here at the Smith chart or the polar coordinates display.

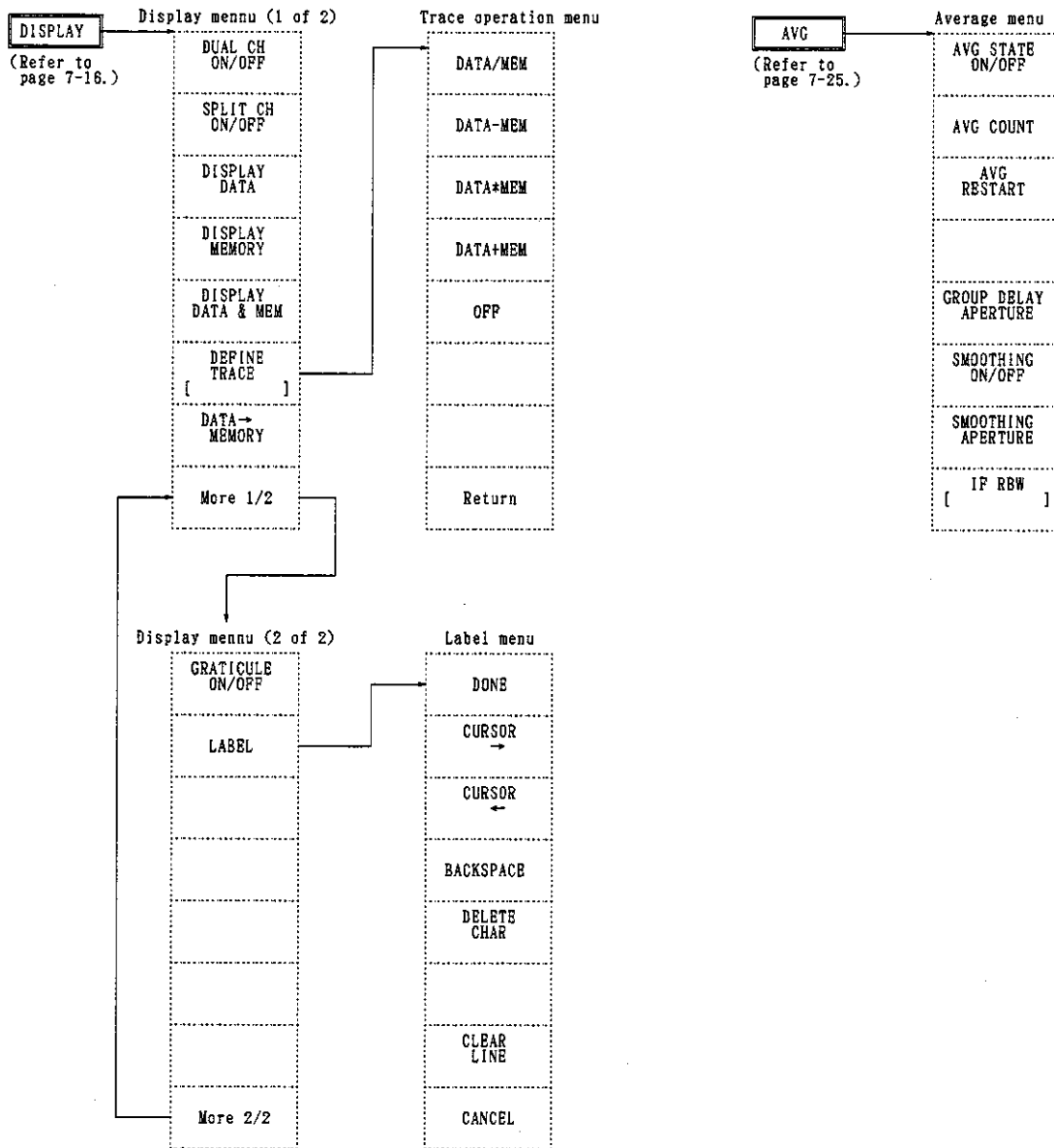

4. Soft Key Menu List

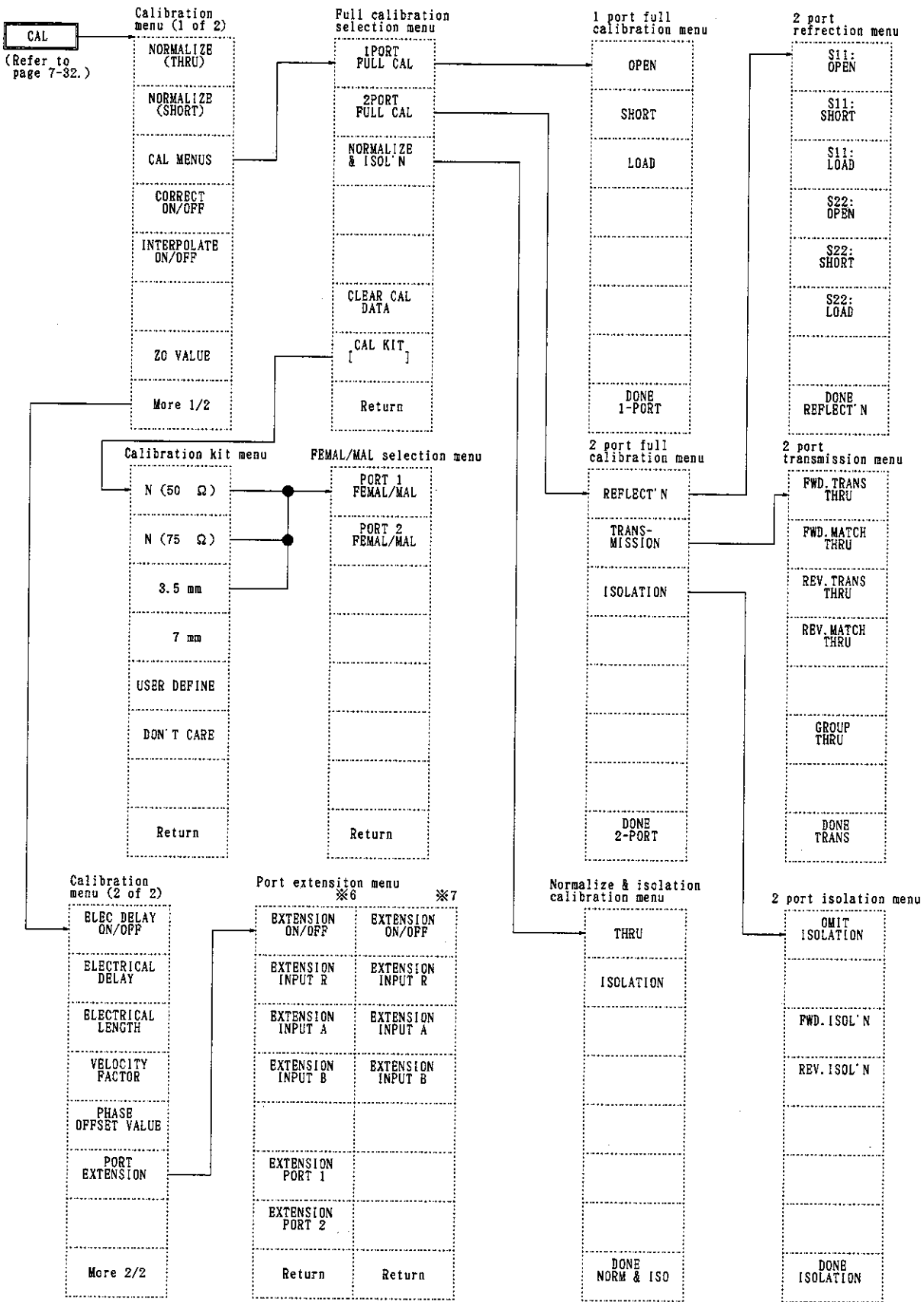

※6 : When R3765A/3767A+S parameter. R3765B/3767B and R3765C/3767C.  
 ※7 : When R3765A/3767A.

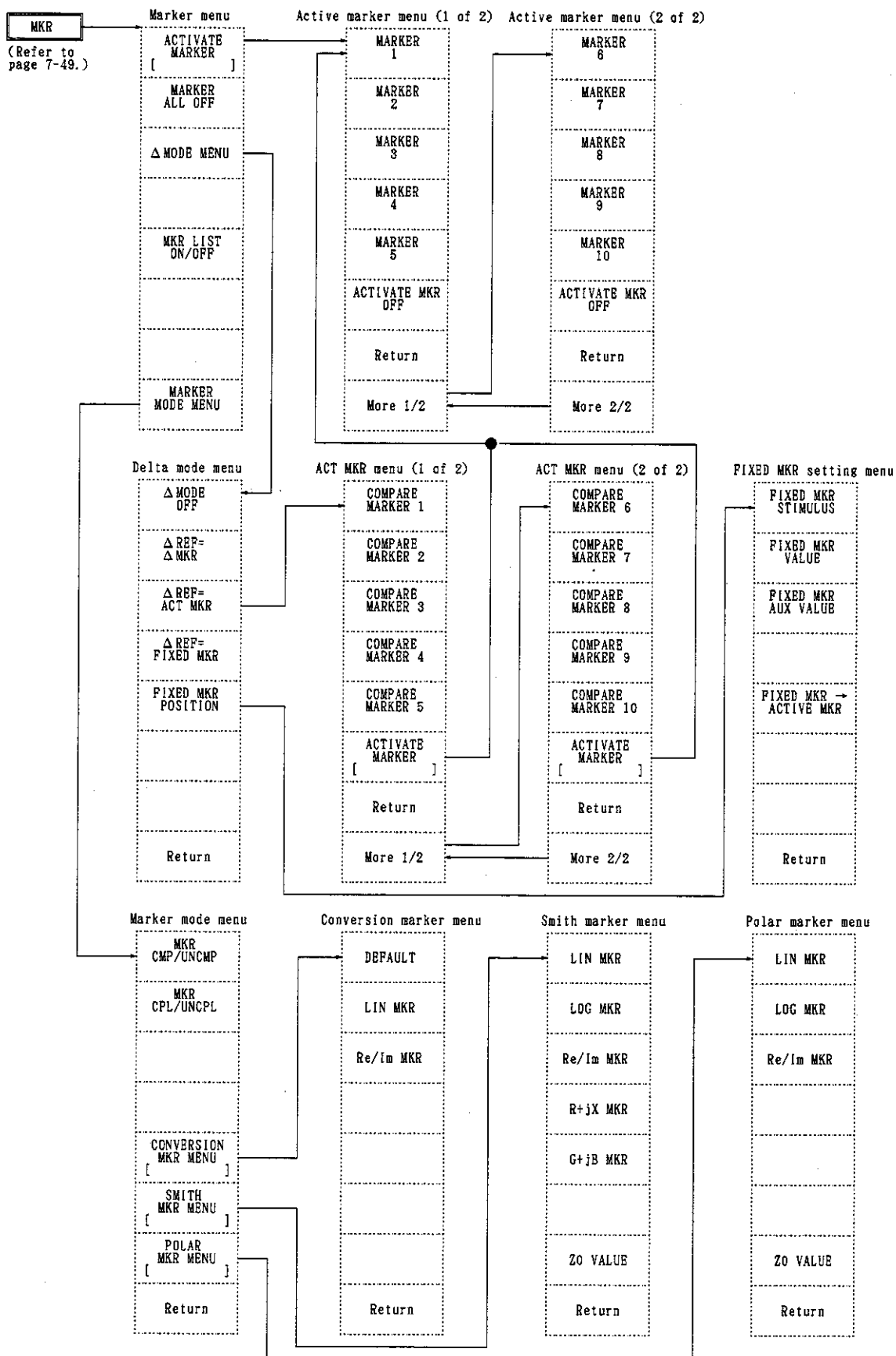

4. Soft Key Menu List

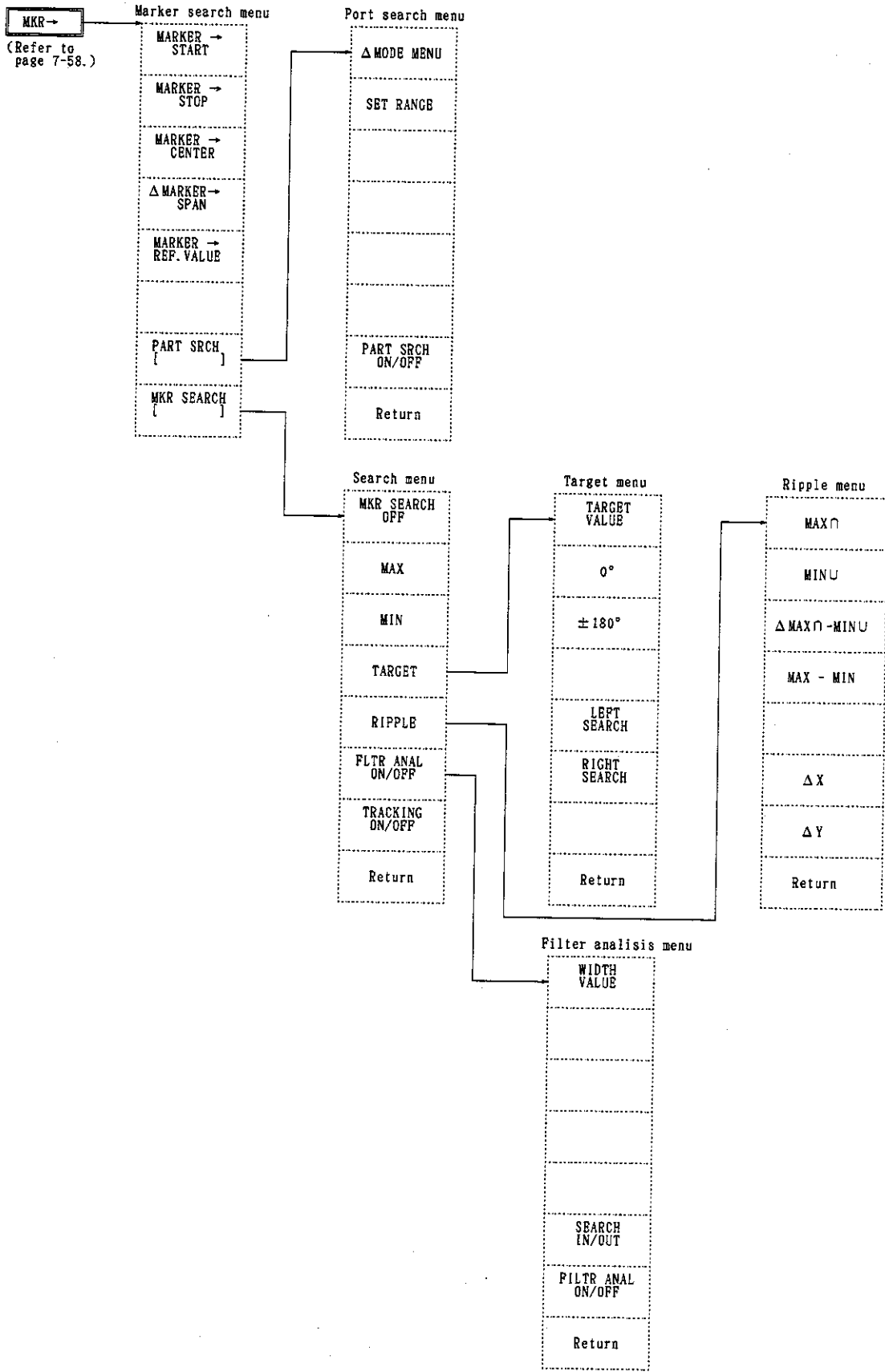



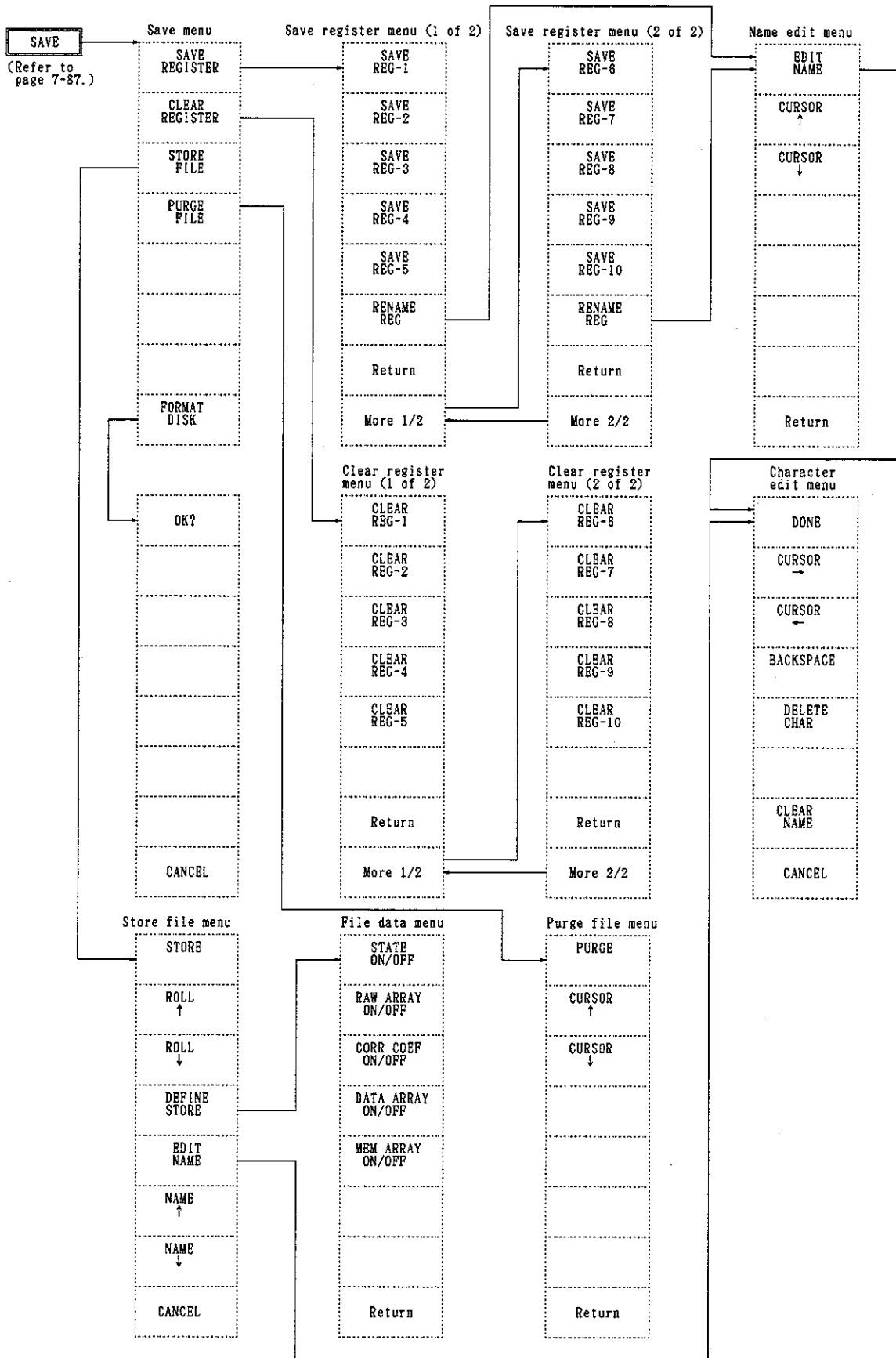

4. Soft Key Menu List

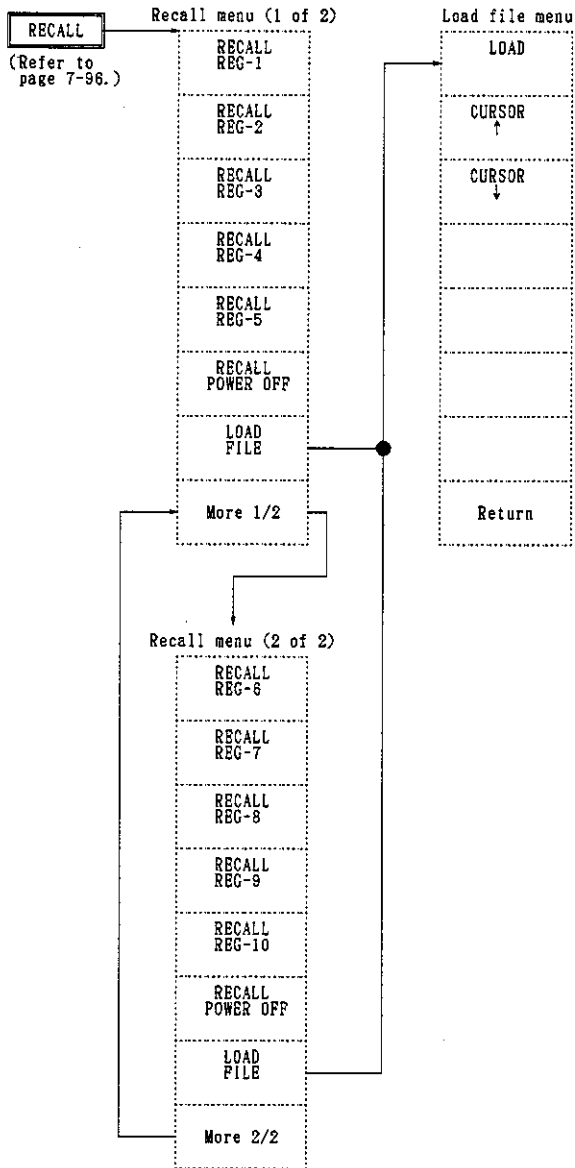

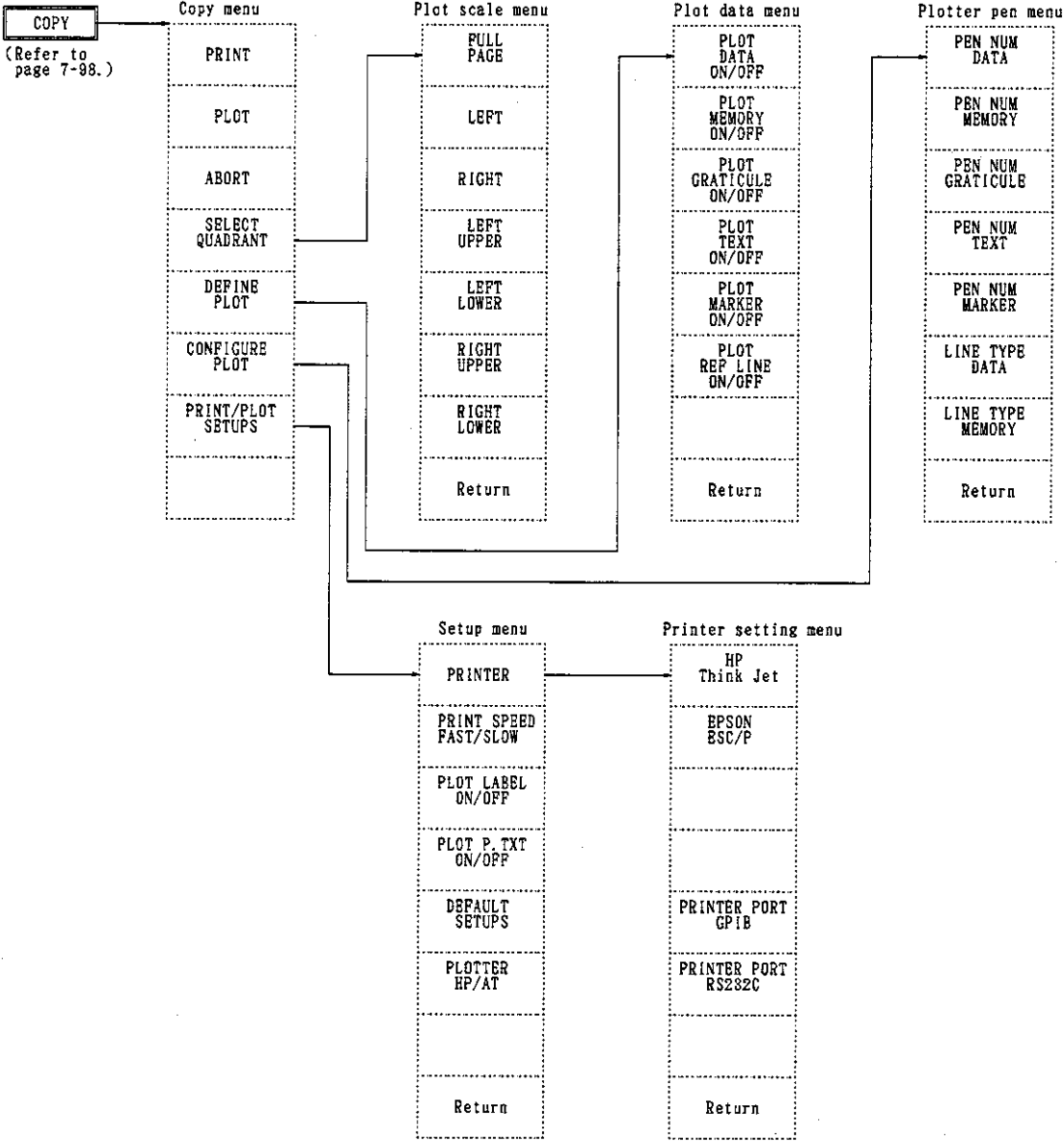

4. Soft Key Menu List

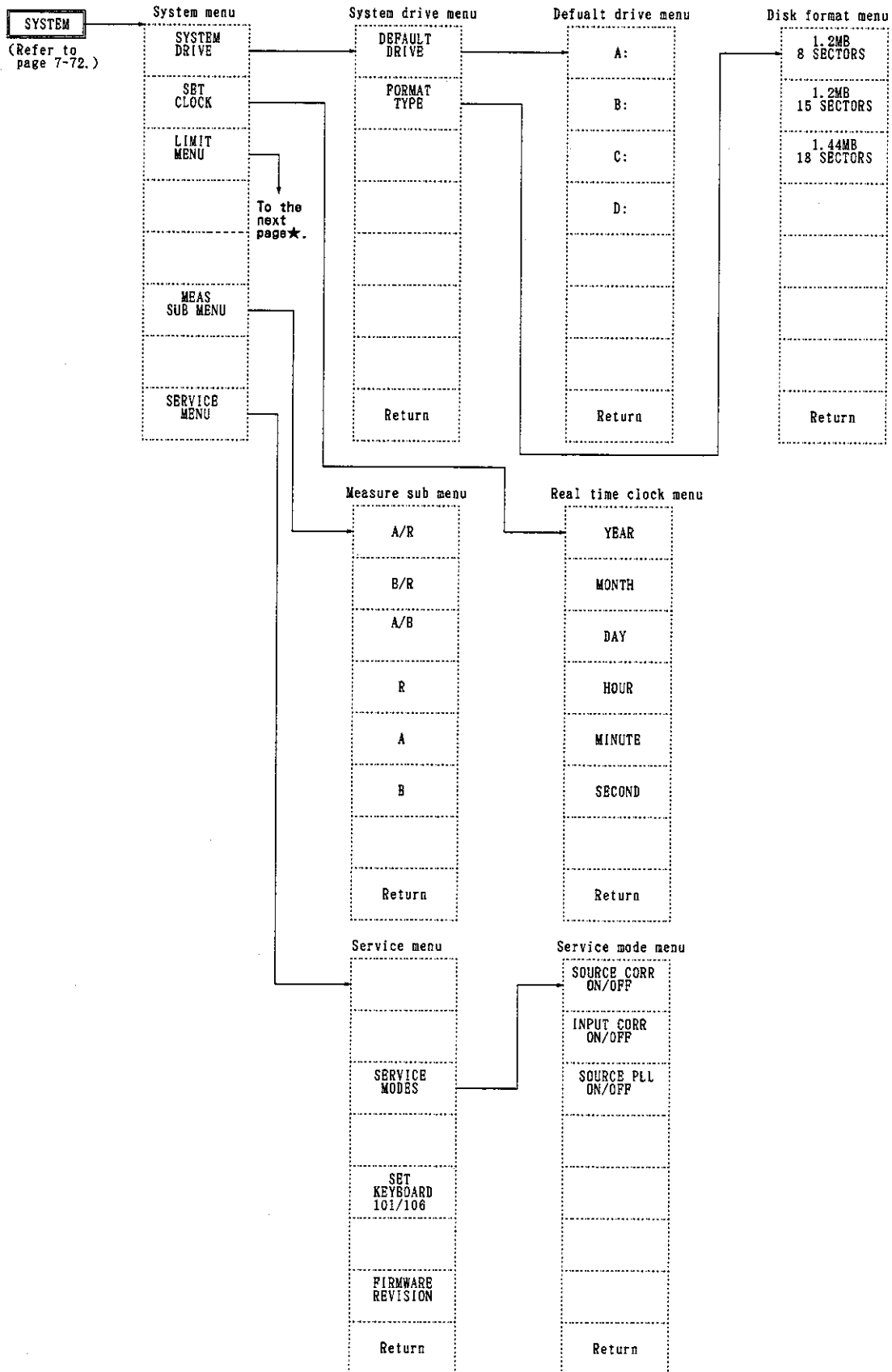

From the previous page★.

↓

Limit menu  
(Refer to page 7-75.)

LIMIT LINE ON/OFF
LIMIT TEST ON/OFF
BEEP FAIL ON/OFF
LIMIT MODE MENU
EDIT LIMIT LINE
SELECT DATA 1ST/2ND
LIMIT LINE OFFSETS
Return

Limit mode menu

1ST DATA ON/OFF
2ND DATA ON/OFF
MAG DATA LIN/LOG
Return

Edit limit menu (1 of 2)

SEGMENT
SELECT DATA 1ST/2ND
EDIT SEGMENT
DELETE
ADD SEGMENT
LIME TYPE
DONE
More 1/2

Edit segment menu

STIMULUS VALUB
MARKER TO STIMULUS
UPPER LIMIT
LOWER LIMIT
DELTA LIMIT
MIDDLE VALUE
MARKER TO MIDDLE
Return

Limit type menu

SLOPING LINE
FLAT LINE
SINGLE POINT
LIMIT COLOR
WAVE COLOR
Return

Offset limit menu

STIMULUS OFFSET
AMPLITUDE OFFSET
MARKER TO AMP. OFS
Return

Edit limit menu (2 of 2)

LIMIT LINE ON/OFF
LIMIT TEST ON/OFF
BEEP FAIL ON/OFF
MAG DATA LIN/LOG
LIMIT MODE MENU
LIMIT LINE OFFSETS
CLEAR LIST
More 2/2

Clear limit menu

CLEAR LIST
YES
CLEAR LIST
NO

4. Soft Key Menu List

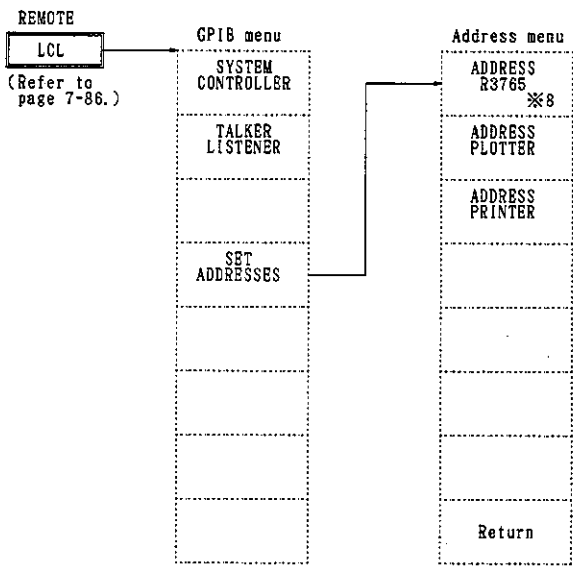
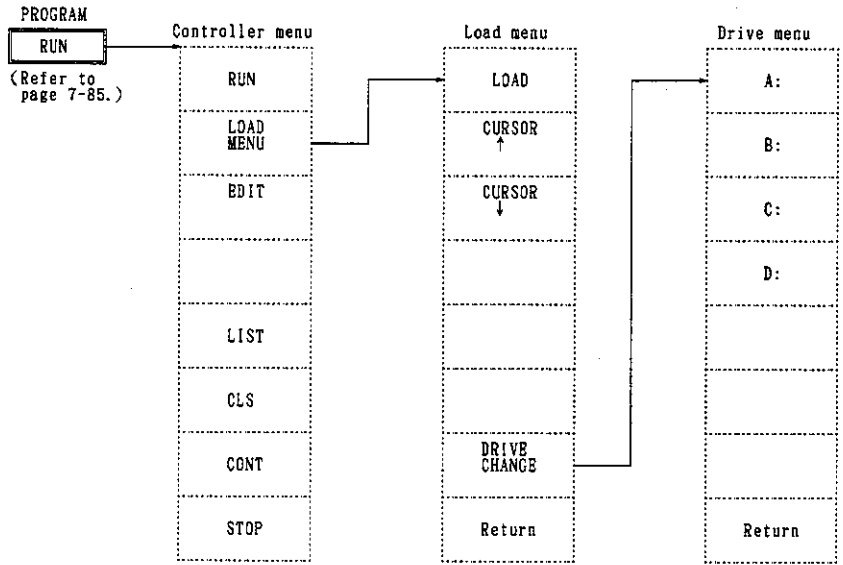

※8 R3767 is displayed for R3767 series.

## 5. Other Information

### ■ Error Message

It's described in chapter 8 "In abnormalities" of this document.

Refer to the following pages.

● Hardware Trouble .....	8-3
● Trouble in the Input Part .....	8-4
● Notice of Hardware Information .....	8-4
● Operating Error .....	8-5
● Warning of internal set, change, etc. ....	8-10
● Notice of the Completion and the State of Operation .....	8-13

### ■ Setting of Backup Memory (at the factory-shipped)

Item	Initial value
GPIB address	11
System controller/Addressable	Addressable
Printer GPIB address	18
Plotter GPIB address	5
Save register	All clear

### ■ GPIB Command List for Panel Key/Soft Key

It's described in a separate-volume "Programming manual" part 2/Appendix A2.

Refer to the following pages.

A2. GPIB command list for panel key/soft key .....	A2-1
A2.1 ACTIVE CHANNEL block .....	A2-1
A2.2 STIMULUS block .....	A2-2
A2.3 RESPONSE block .....	A2-8
A2.4 INSTRUMENT block .....	A-32
A2.5 GPIB BLOCK block .....	A2-43

MEMO 



## ALPHABETICAL INDEX

[Panel Key]			
[.]	7-4	[SCALE]	7-10 A-10
[-]	7-4	[SPAN]	7-6
[0] to [9]	7-4	[START]	7-6
[AVG]	7-10 A-11	[STOP]	7-6
[BS]	7-4	[SYSTEM]	7-71 A-18
[CAL]	7-10 A-12		
[CENTER]	7-6	[Δ]	
[CH1]	7-2	Δ MKR mode	7-52
[CH2]	7-2		
[COPY]	7-71 A-17	[Numeric]	
[DISPLAY]	7-10 A-11	1 port full calibration	3-24
[ENTRY OFF]	7-4	1 Port Full Calibration (Load)	3-26
[FORMAT]	7-10 A-10	1 Port Full Calibration (Open)	3-24
[LCL]	7-84 A-20	1 Port Full Calibration (Short)	3-25
[MEAS]	7-10 A-10	1-Port Full Calibration	7-29
[MENU]	7-6 A-9	2 Port Full Calibration	5-13
[MRK]	7-10 A-13	2 Trace Display	5-2
[MRK→]	7-10 A-14	2-Port Full Calibration	7-30
[PRESET]	7-71	4 Screen Display	5-21
[RECALL]	7-71 A-16	4 Screen Display (Channel 1)	5-21
[RUN]	7-84 A-20	4 Screen Display (Channel 2)	5-24
[SAVE]	7-71 A-15	4 Screen Display (Overlap Display of Channel 1 and 3)	5-22
		4 Screen Display (Split Display of Channel 1 and 3)	5-23
		4 Screen Display (Split Display of Channel 2 and 4)	5-25

<b>[A]</b>		
About the Measurement Data to Save	6-12	
Accessory	Preface-6	
ACT MKR mode	7-52	
ACTIVE CHANNEL Block	7-2	
Address and data range	7-109	
Annotation on the Screen		
(Annotation Character)	3-9	
Auto-scale of Group Delay Time		
Measurement	3-19	
Auto-scale of Magnitude Measurement	3-14	
Auto-scale of Phase Measurement	3-17	
Auto-scale of the First Waveform of		
Magnitude/Phase Measurement	5-3	
Auto-Scale of the Second Waveform of		
Magnitude/Phase Measurement	5-4	
Averaging and Resolution Bandwidth	7-25	
<b>[B]</b>		
BASIC format	7-108	
Basic Measuring Procedure	3-10	
Before Use the Product	1-1	
Block Chart	9-4	
<b>[C]</b>		
Calibration	7-28	
	10-1	
Calibration (1 port full calibration)	3-24	
Calibration (2 Port Full Calibration)	5-13	
Calibration (Normalize)	3-13	
Calibration Data Clear	7-47	
Calibration Interpolate	7-41	
Calibration Kit Selection	7-42	
Calibration Method	7-32	
		Calibration of 2-Port Reflection
		(Test Port/Load)
		5-15
		Calibration of 2-Port Reflection
		(Test Port/Open)
		5-13
		Calibration of 2-Port Reflection
		(Test Port/Short)
		5-14
		Calibration of 2-Port Transmission
		Characteristic (Forward Direction)
		5-17
		Case that abnormality occurs
		1-12
		Caution of System-up
		1-9
		Cautions on the Overload to the
		Input Part
		1-9
		Cautions when scrapping the analyzer
		1-12
		Change of Group Delay Aperture
		3-20
		Change of Limit Line
		5-53
		Change of Plotter Initial Setup Value
		6-4
		Change of the Program Sweep
		5-46
		Channel 1 (CH 1) is in Active
		7-17
		Channel 2 (CH 2) is in Active
		7-20
		Characteristic of the Receiver Part
		11-5
		Characteristics
		3-11
		Checking Power Requirements
		1-5
		Circuit example
		7-111
		Cleaning
		1-11
		Clearing Saved Register
		7-94
		Combination of Interpolatable
		Sweep Type
		7-41
		Communication with Peripheral Devices
		7-105
		Confirmation of Product and
		Attachment
		Preface-5
		Connecting FET Probe
		1-8
		Connecting the Power Cable
		1-6
		Connecting the Power Cable
		3-2
		Connecting to AC Power Source
		3-2
		Connection connector and signal table
		7-114
		Connection to External Devices
		11-11
		Controller Menu
		7-85
		Crosstalk (R3765A/3767A)
		10-18
		Crosstalk (R3765B/3767B)
		10-19
		Crosstalk (R3765C/3767C)
		10-20

## 【D】

Data Flow	9-3
Data knob	7-5
Delta-Marker Function	7-52
Delta-Marker Function	7-53
Diagrammatic Sketch of Block	9-4
Directivity	10-7
Display Data Format	7-14
Display Layout	7-17
Display Marker Read out Value	7-52
Display of Multi-marker List	5-32
Display Section	11-9
Displayed Active Area	3-7
DSW1 Function	7-103
DSW2 Function	7-103

## 【E】

Each port operation method	7-108
Editing Segment of Program Sweep	7-68
Editing Segment of	
User Frequency Sweep	7-67
Electrical length calibration	7-44
Electrical Length Compensation Mode	5-40
Electrical Length of Cable	5-39
Electromagnetic interface	1-12
ENTRY Block	7-4
Environmental Conditions	1-4
Error Compensation Function	11-8
Error Message	A-21
Error Messages	8-3
Example of Filter Analysis Execution	7-63
Executing Recall	9-96
Executing Save Register	7-89
Executing Store File	7-90
Execution of 2 Port Reflection	
Characteristic Calibration	5-16
Execution of 2-Port Full Calibration	5-20

## Execution of 2-Port Transmission

Characteristic Calibration	5-18
Execution of Limit Test	5-52
Execution of the Isolation Calibration	5-19
Execution of the Program Sweep	5-45
Extending Measurement Reference	
Surface	7-44

## 【F】

Factory Default Settings	4-7
FET Probe	1-8
File List Display	7-88
Filter Analyzing Function	
(3dB Bandwidth and Q Measurement)	3-15
Filter Analyzing Function	
(6dB Bandwidth and Q Measurement)	3-16
FIXED MKR mode	7-52
Flatness	10-5
Four Screen Display Mode	5-11
Frequency Accuracy and Range	10-3
Front-Panel Descriptions	
(R3765A/3767A)	2-2
Front-Panel Descriptions	
(R3765B/3767B)	2-4
Front-Panel Descriptions	
(R3765C/3767C)	2-6
Function Descriptions	7-1

## 【G】

General Note	10-2
General Specification	11-11
Getting Started	3-1
GO/NG Measurement by Limit Line	
Function	5-47
GPIO Block	7-84
GPIO Command List for Panel Key/	
Soft Key	A-21
GPIO Menu	7-86
Group delay time measurement	3-19

**【 H 】**

Hard Copy ..... 7-98  
 Hardware Trouble ..... 8-3  
 High Speed Measurement by Program  
     Sweeping Function ..... 5-42  
 How to Initialize ..... 4-4  
 How to Read the Display Screen ..... 3-9  
 How to Read this Manual ..... Preface-3  
 How to Replace the Protective Fuse for  
     Bias Input ..... 1-10  
 How to Set Data ..... 3-7

**【 I 】**

Impedance Measurement ..... 3-31  
 In Abnormalities ..... 8-1  
 In the Beginning ..... Preface-1  
 Initial Power-on ..... 3-2  
 Initial Setting Value ..... A-5  
 Initial Setup ..... 4-4  
 Initial Setup Value ..... 4-4  
 INPUT 1, OUTPUT 1, and OUTPUT 2  
     Terminals ..... 7-110  
 Inspection and Simple Troubleshooting ..... 8-2  
 Installation Posture ..... 1-4  
 INSTRUMENT STATE Block ..... 7-71  
 Interlocking between Channels ..... 7-9  
 Interpolation between Measurement ..... 7-51  
 Interpolation of Calibration Data ..... 7-41

**【 K 】**

Keys Necessary for Basic Operation ..... 4-2

**【 L 】**

Label Input ..... 7-24  
 Label Window Display ..... 7-24  
     ..... 7-91  
 Life time of ports ..... 1-13  
 Limit Function ..... 7-75  
 Limit Line Editing ..... 5-48  
 Limit Menu ..... 7-75  
 Linear frequency sweep ..... 7-65  
 Linear Magnitude/Phase Measurement  
     (Split Display) ..... 5-10  
 Linear Scale Measurement of  
     Magnitude/Phase (Overlap Display) ..... 5-6  
 Linear Sweeping ..... 5-42  
 Load Match of Test Port  
     (R3765A/3767A) ..... 10-9  
 Load Match of Test Port  
     (R3765B/3767B) ..... 10-12  
 Load Match of Test Port  
     (R3765C/3767C) ..... 10-13  
 Log (logarithm) frequency sweep ..... 7-65

**【 M 】**

Magnitude measurement ..... 3-14  
 Magnitude/Group Delay time  
     Measurement (Overlap Display) ..... 5-5  
 Magnitude/Group Delay Time  
     Measurement (Split Display) ..... 5-9  
 Magnitude/Phase Measurement  
     (Split Display) ..... 5-8  
 Marker Analysis Function ..... 7-58  
 Marker Coupling between Channels ..... 7-50  
 Marker Function ..... 7-48  
 Marker Menu during Impedance  
     Measurement ..... 7-56  
 Measurement by various formats ..... 3-27

Measurement Function ..... 11-2

Measurement of Electrical Length ..... 5-38  
5-41

Measurement of Maximum Value in the  
Delta section ..... 5-35  
5-36

Measurement of Narrow  
Bandwidth/Wide Bandwidth ..... 5-27

Measurement of Ripple in Bandwidth .... 5-33

Measurement of Ripple in the  
Delta Section ..... 5-37

Measurement of Transmission and  
Reflection Characteristic ..... 5-11

Measurement of Transmission  
Characteristic ..... 5-2

Measurement Sample ..... 5-1

Measurement Samples of Simple  
Reflection Characteristics ..... 3-21

Measurement Samples of Simple  
Transmission ..... 3-11

Measurement Time ..... 1-9

Measuring Time ..... A-4

MKR CPL ..... 7-50

MKR UNCPL ..... 7-50

Mode setting of port ..... 7-108

Multi-marker Display ..... 5-31

Multi-marker List Display ..... 5-30

**【N】**

Noise Level ..... 10-15

Normalize ..... 3-13

Normalize & Isolation Calibration ..... 7-29

Normalizing ..... 7-28

Notes on Use ..... 1-12

Notes on use of Parallel I/O Port ..... 1-9

Notes on use of Serial I/O Port ..... 1-9

Notice of Hardware Information ..... 8-4

Notice of the Completion and the  
State of Operation ..... 8-13

**【O】**

Operating Conditions ..... 1-3

Operating Error ..... 8-5

Operation Basics ..... 4-1

Operation Keys ..... 3-4

Option ..... Preface-6

Other Functions ..... 11-10

Other Information ..... A-21

Outline of Product ..... 1-2

Output ..... 6-1

Output Data to the Plotter ..... 6-4

Output Level Accuracy ..... 10-4

Output Level Accuracy and Flatness ..... 10-4

Output Level Linearity ..... 10-6

Output Result of the Plotter ..... 6-5

Outputting to the Potter ..... 6-2

Overlap Display Mode ..... 5-2

**【P】**

Panel Description ..... 2-1

Panel Keys ..... 3-4

Parallel I/O (36-pin) Connector Pin  
Assignment and Signal ..... 7-107

Parallel I/O Port ..... 7-105

Performance Test ..... 10-1

Phase compensation value ..... 7-44

Phase Extension Display ..... 3-18

Phase measurement ..... 3-17

Phase offset ..... 7-44

Phase offset value ..... 7-44

Plotter Setup ..... 7-102

Port extension ..... 7-44

Power Source ..... 1-5

Power sweep ..... 7-65

Power Switch ..... 3-3

Power-on ..... 3-3

Preparing for Performance Test ..... 10-2

Preparing Measurement Instrument ..... 10-2

Printer output method	7-114
Printer Setup	7-104
Program example	7-111
Program Function	11-10
Program sweep	7-65
Purging Stored File	7-95

## 【R】

R3765A/3767A	
Diagrammatic Sketch of Block	9-4
R3765B/3767B	
Diagrammatic Sketch of Block	9-5
R3765C/3767C	
Diagrammatic Sketch of Block	9-6
Rear Panel Descriptions	
(R3765A/3767A)	2-8
Rear Panel Descriptions	
(R3765B/3767B)	2-10
Rear Panel Descriptions	
(R3765C/3767C)	2-12
Recall	7-87
Recall from Floppy Disk	6-11
Recalling from the Recall-register	6-7
Recalling to Floppy Disk	6-8
Receiver section	9-2
Recommended Kit	Preface-6
Record	6-1
Reflection Coefficient Measurement	3-28
Register List Display	7-92
Replacement of protective fuse for	
bias input	1-10
Replacing the Power Fuse	1-5
Required Measurement Instrument for	
Calibration	10-2
RESPONSE Block	7-10
Return Loss Measurement	3-27
RS-232	7-114

## 【S】

S Parameter Measurement	3-30
Samples of Basic Key Operation	4-2
Save	7-87
Saving into the Save-register	6-6
Saving to Floppy Disk	6-8
	6-10
Schematic Circuit Diagram of Parallel	
I/O Port	7-108
Screen before Execution of Limit	
Line Measurement	5-47
Screen Display Descriptions	2-14
Screen of Frequency Characteristic	
Normalize	3-13
Selecting Plot Data	7-100
Selection of Four Screens Display and	
Display Information	7-16
Selection of Save Type	7-87
Setting Backup Memory	4-7
Setting DIP Switches	7-102
Setting Display Coordinate Scale	7-15
Setting File Name	7-93
Setting Input and Parameter Conversion	7-11
Setting Marker	7-49
Setting of Backup Memory	A-21
Setting of Each Segment	5-51
Setting of Plotter GPIB Address	6-2
Setting of Program Sweeping	5-43
Setting of Segment 0	5-49
Setting of the Limit Line	5-48
Setting Plot Scale	7-99
Setting Register Name	7-91
Setting Screen When Switch on or Preset	3-3
Setting Signal Source	7-7
Setting Sweep Type	7-66

Setup and Setting .....	3-11
Setup for Reflection Characteristic	
Measurement .....	3-22
Setup I for A Type Reflection	
Characteristics Measurement .....	3-21
Setup II for A Type Reflection	
Characteristics Measurement .....	3-22
Setup of A Type S Parameter	
Measurement .....	5-11
Setup of the Reflection Characteristic	
Measurement .....	5-12
Signal Source Section .....	11-3
Signal source section .....	9-2
Smoothing and Resolution Bandwidth .....	7-25
Soft Key Menu List .....	A-9
Soft Keys .....	3-4
Soft Menu Configuration .....	4-3
Specification .....	11-1
Specification of Delta Section	
(Partial Search) .....	5-34
Specifying Pen .....	7-101
Split Display Mode .....	5-7
Standard attachment list .....	Preface-5
Standing Wave Ratio (SWR)	
Measurement .....	3-29
Status Display .....	7-41
Step key .....	7-5
STIMULUS Block .....	7-6
Storage .....	1-11
Supply voltage .....	1-5
Sweep .....	7-65
System Menu .....	7-72

## 【T】

Test Port Characteristic .....	11-7
The Data Interlocking to each Item in	
MEAS Menu .....	A-3
The Finished 4 Screen Display .....	5-26
The Principle .....	9-2
The Relation of Data between each	
Channel .....	A-2
The Relation of Data between each	
Function .....	A-2
The Screen after the Segment Edited .....	7-70
The Screen before the Segment Edited .....	7-69
The Setup of Transmission Characteristic	
Measurement (A Type) .....	3-11
The Setup of Transmission Characteristic	
Measurement (B/C Type) .....	3-11
Timing Chart of WRITE STORE .....	7-106
To be Going to Use it Safely .....	Preface-2
TRACE Operation .....	7-23
Transfer constant .....	7-44
Transportation .....	1-11
Troubleshooting .....	8-2
Two Channels Simultaneous Display	
(Overlap Display) .....	5-28
Two Channels Simultaneous Display	
(Split Display) .....	5-29

## 【U】

Unit key .....	7-5
User frequency sweep .....	7-65

## 【W】

Warm up .....	1-12
	10-2
Warning of Internal Set, Change, etc. ....	8-10





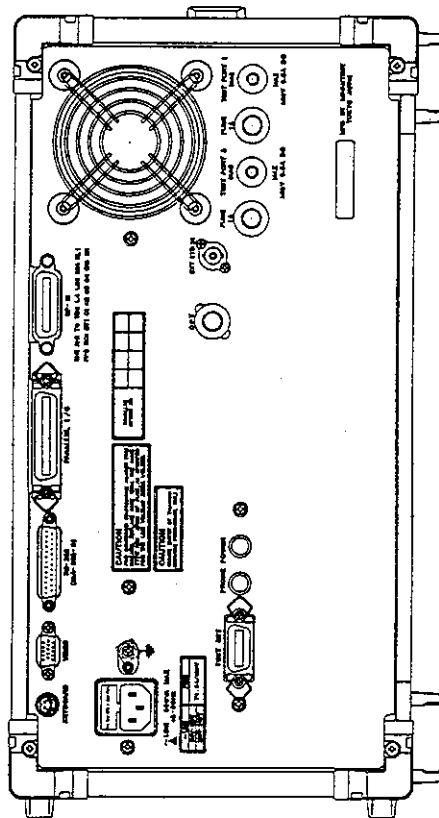
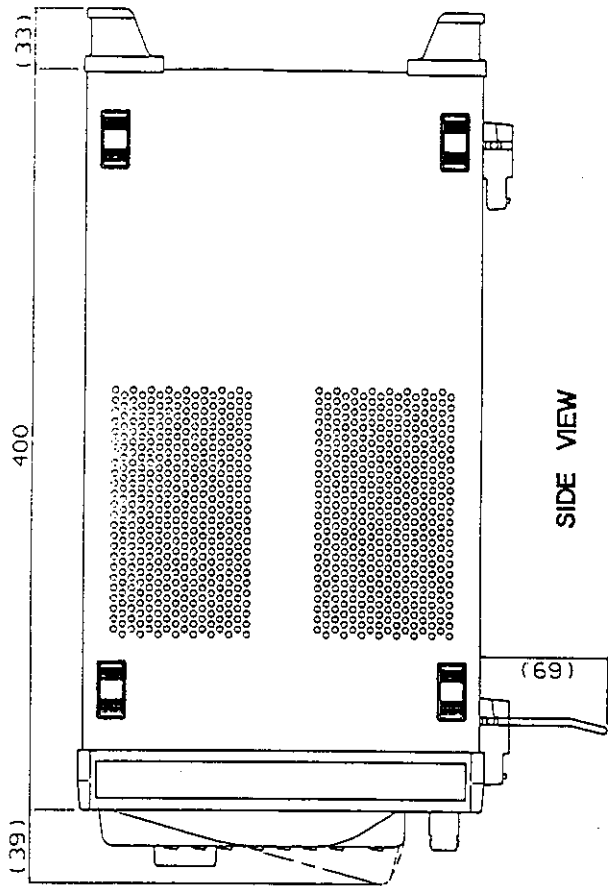
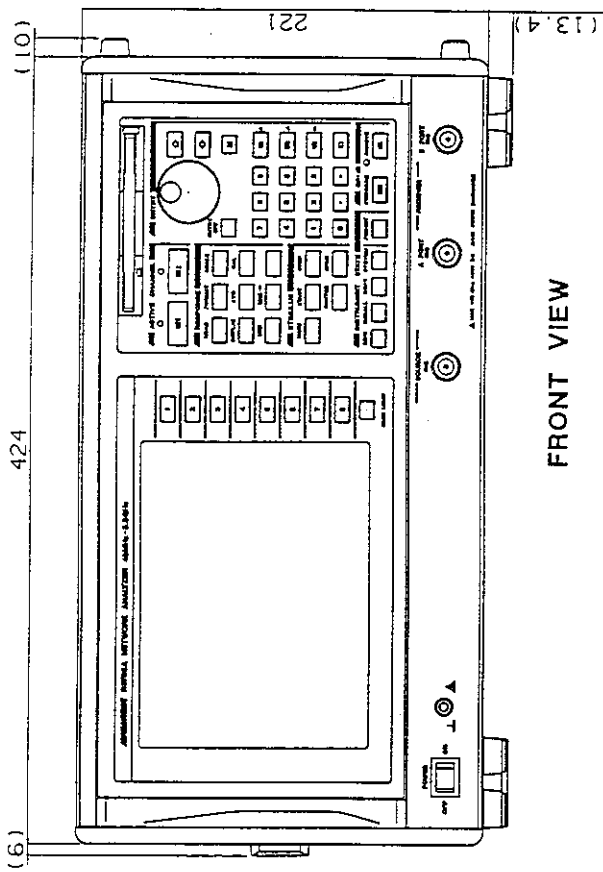

R3765A/R3767A  
EXTERNAL VIEW

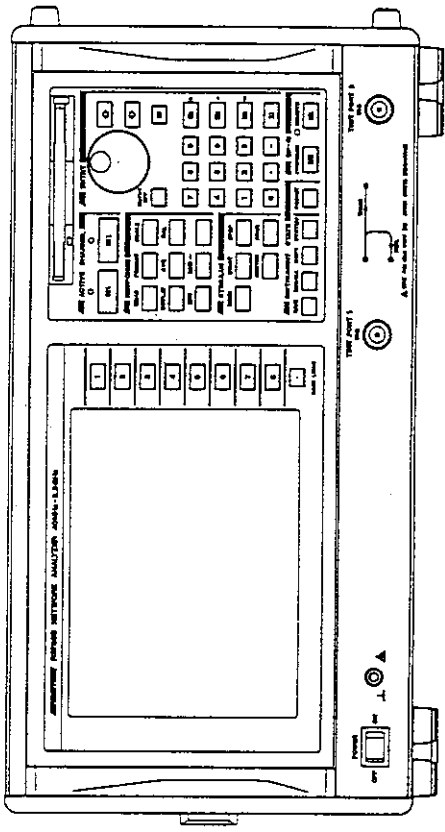

FRONT VIEW

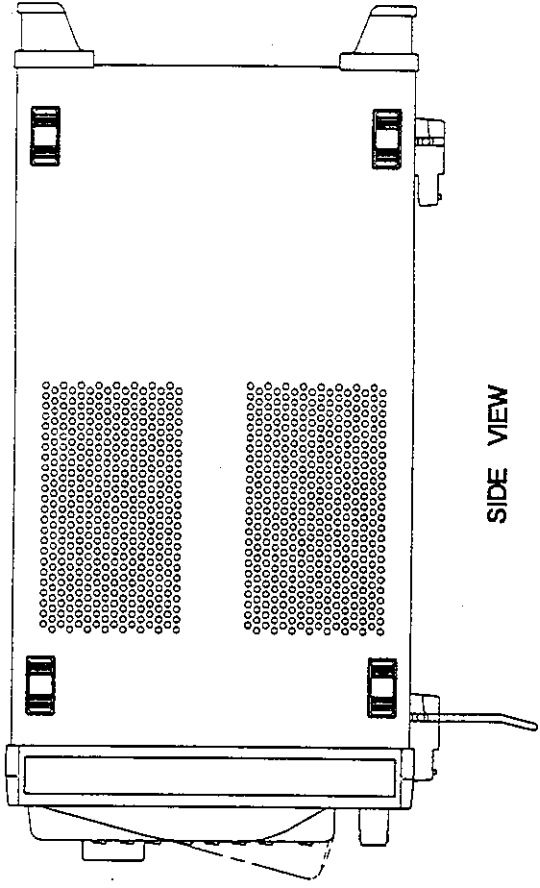

SIDE VIEW

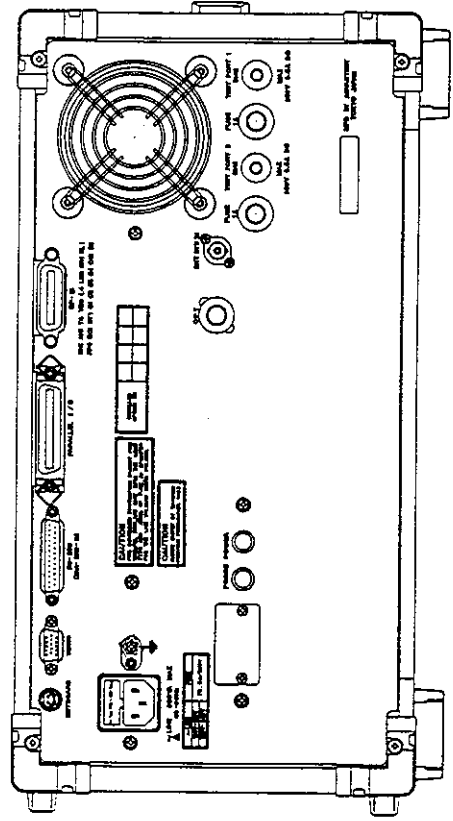

REAR VIEW

R3765B/R3767B  
EXTERNAL VIEW

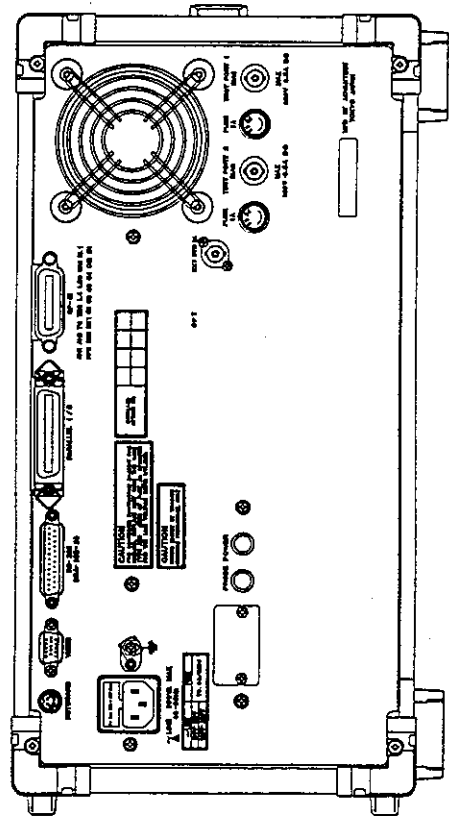
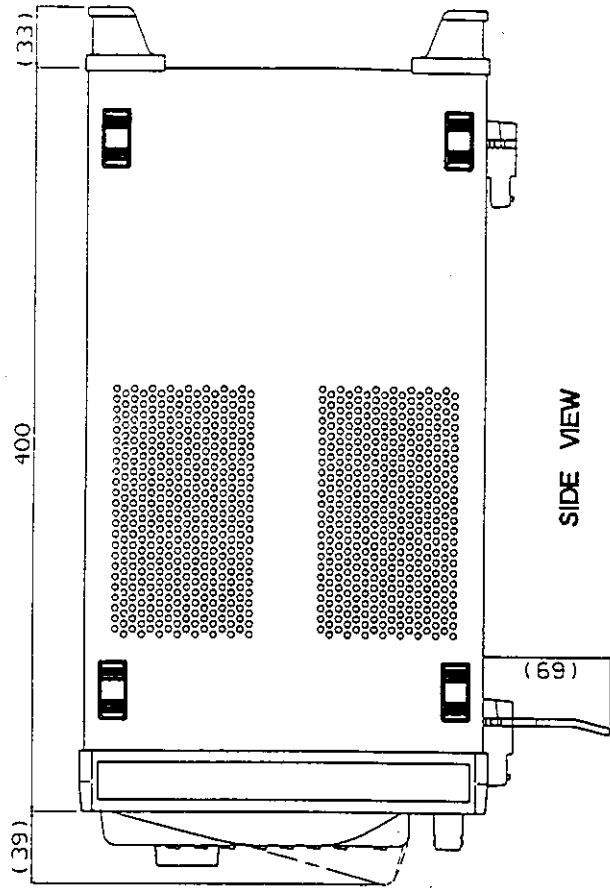
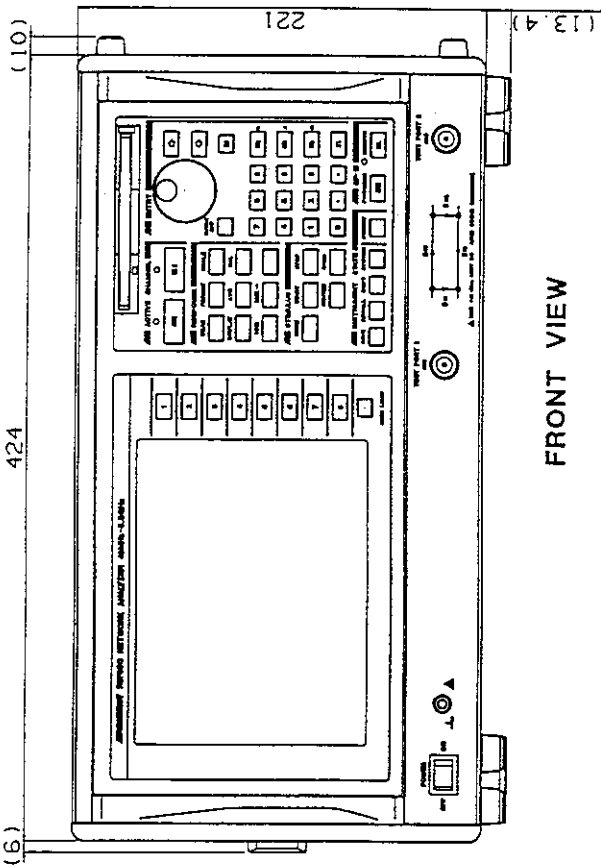

R3765C/R3767C  
EXTERNAL VIEW

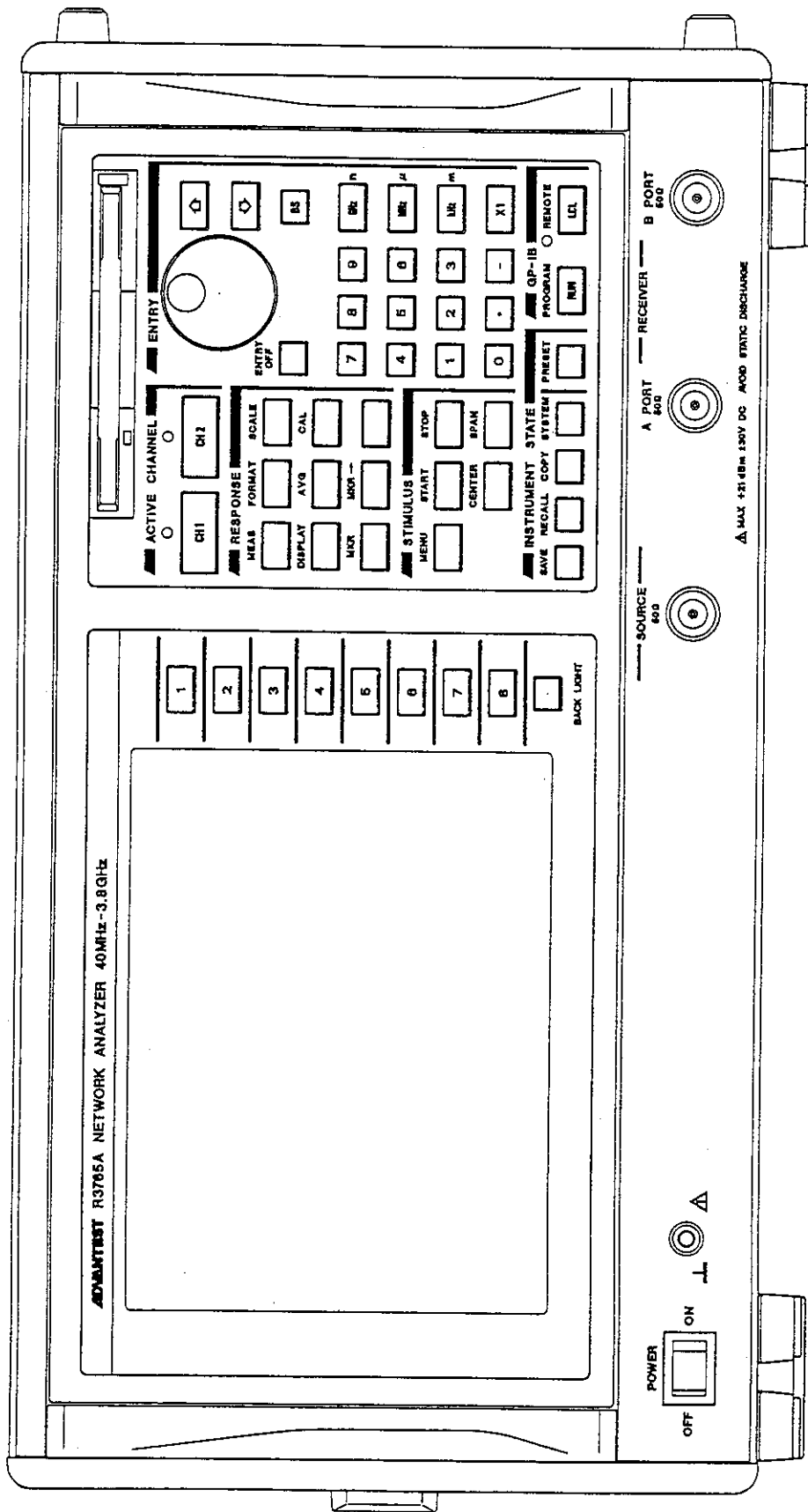

R3765A/R3767A

FRONT VIEW

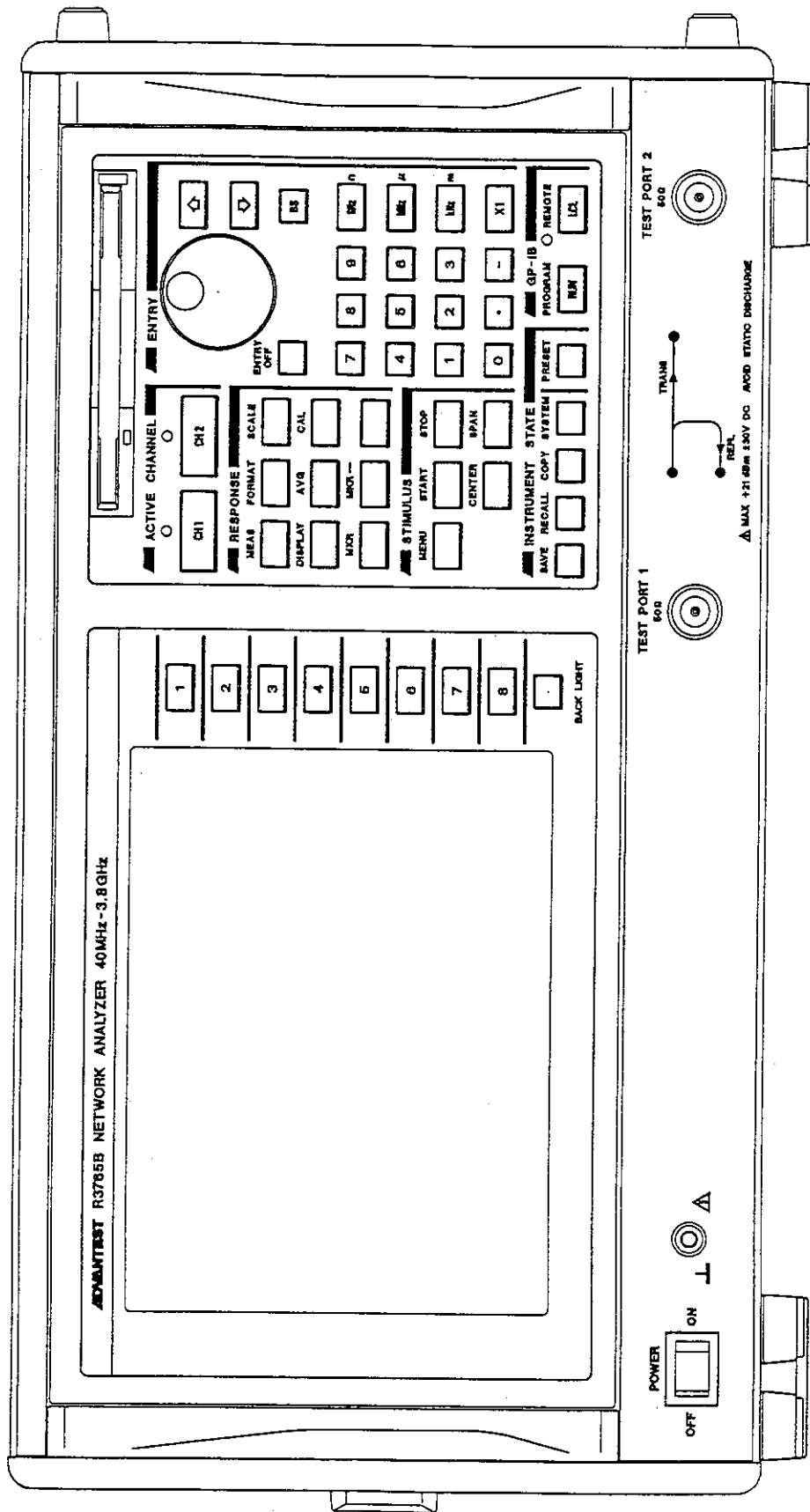

R3765B/R3767B

FRONT VIEW

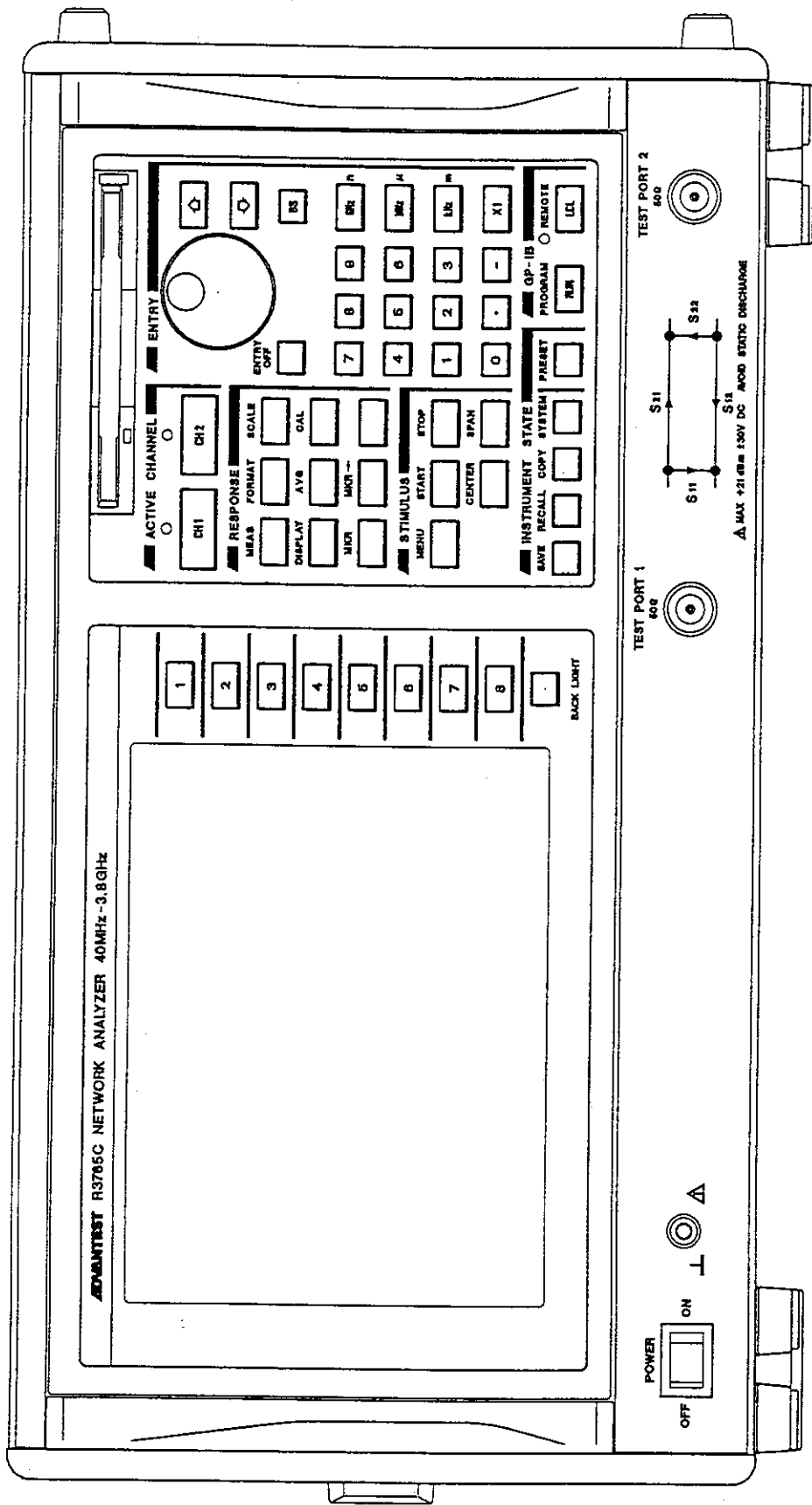

R3765C / R3767C  
 FRONT VIEW

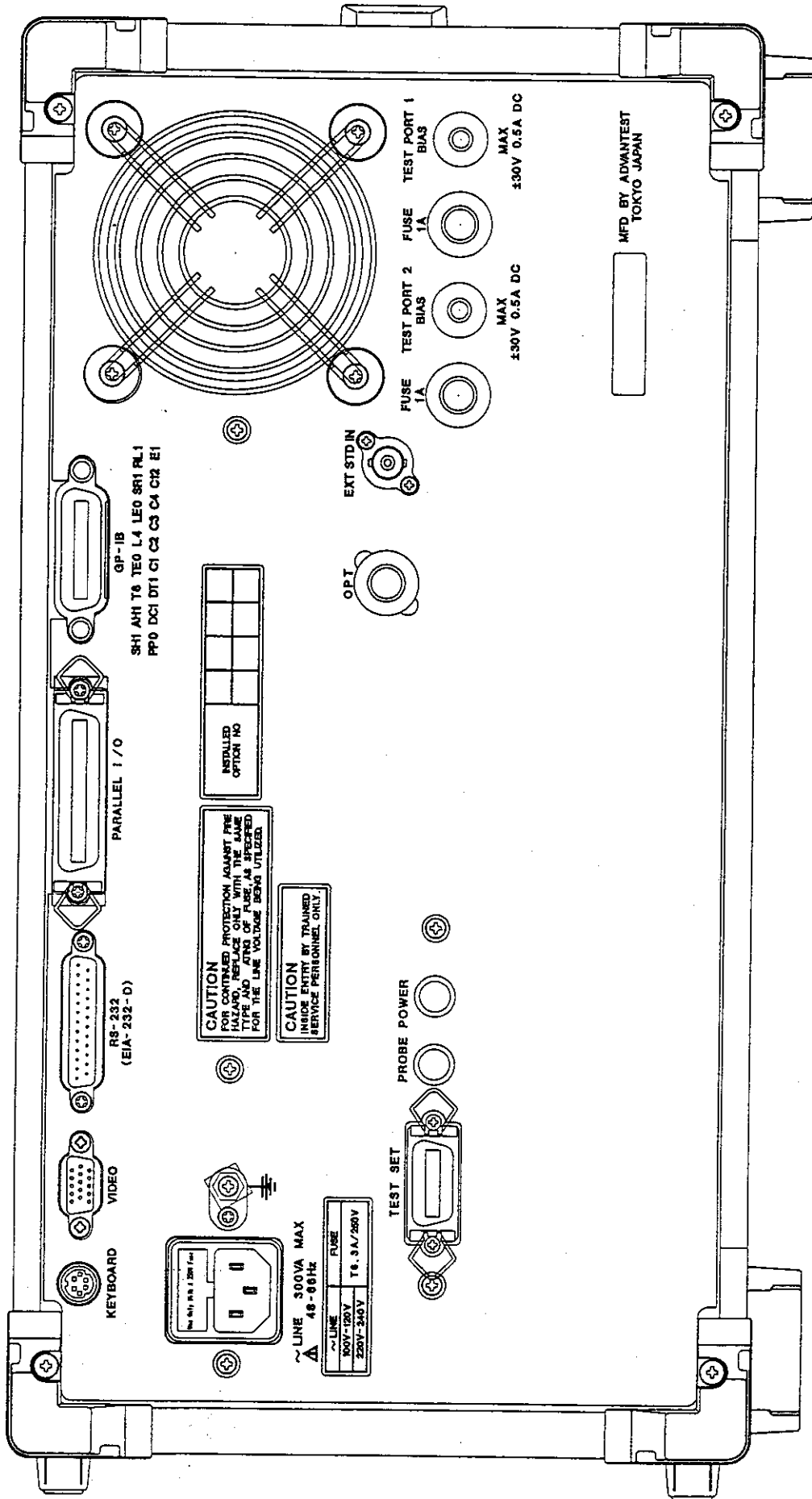

R3765A/R3767A  
REAR VIEW

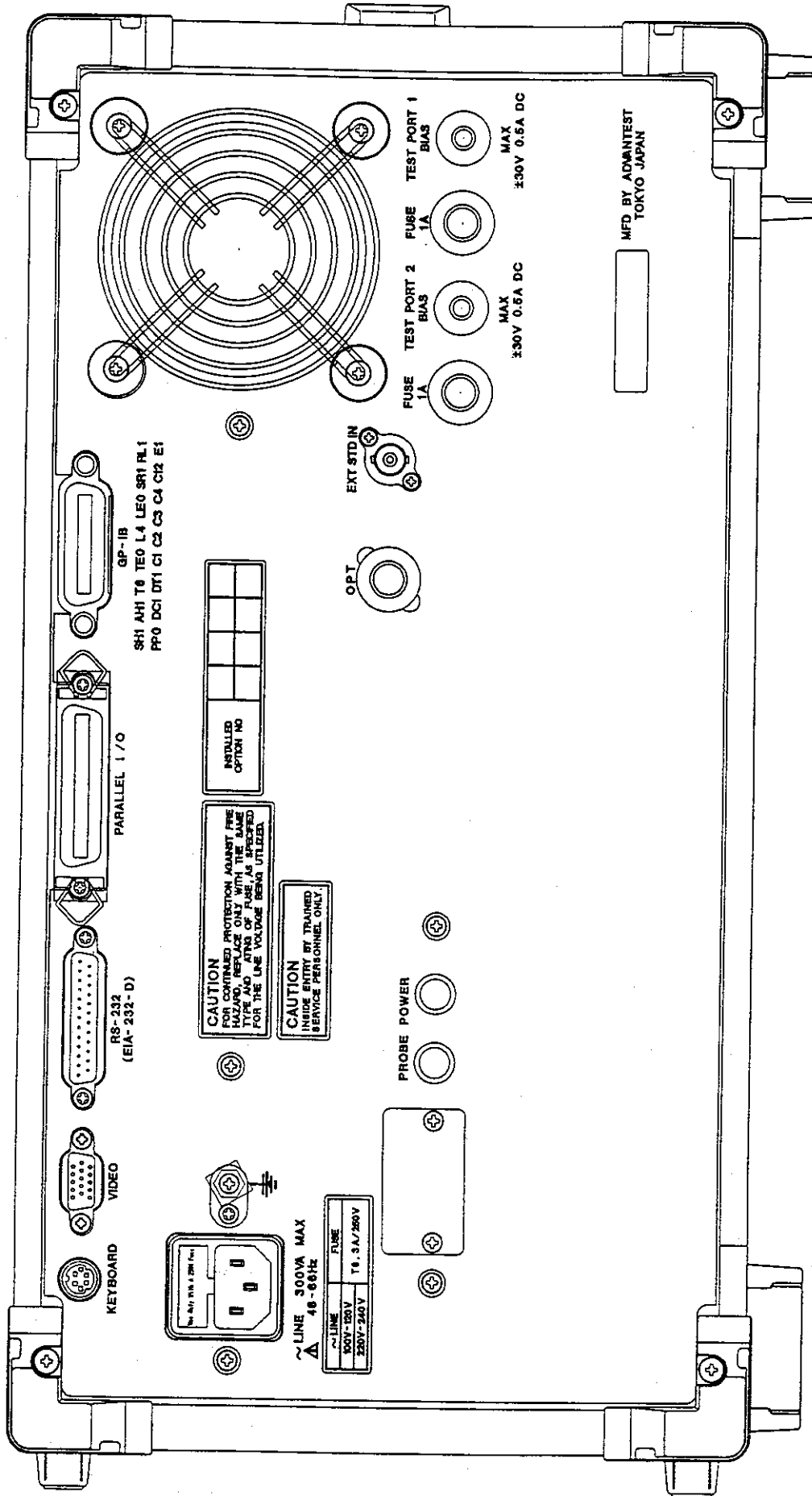

R3765B/R3767B  
REAR VIEW



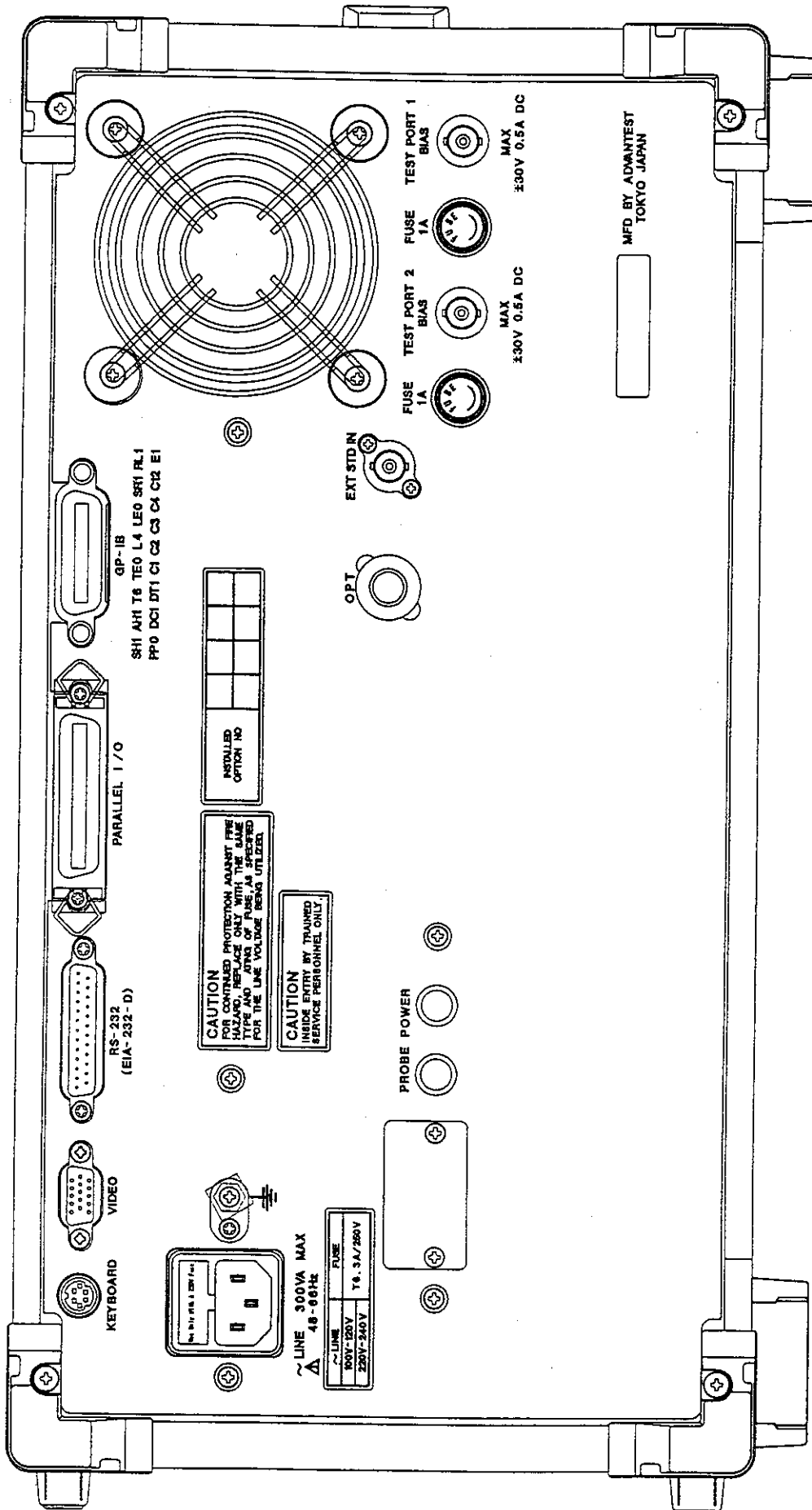

R3765C/R3767C

REAR VIEW

## **IMPORTANT INFORMATION FOR ADVANTEST SOFTWARE**

PLEASE READ CAREFULLY: This is an important notice for the software defined herein. Computer programs including any additions, modifications and updates thereof, operation manuals, and related materials provided by Advantest (hereafter referred to as "SOFTWARE"), included in or used with hardware produced by Advantest (hereafter referred to as "PRODUCTS").

### **SOFTWARE License**

All rights in and to the SOFTWARE (including, but not limited to, copyright) shall be and remain vested in Advantest. Advantest hereby grants you a license to use the SOFTWARE only on or with Advantest PRODUCTS.

### **Restrictions**

- (1) You may not use the SOFTWARE for any purpose other than for the use of the PRODUCTS.
- (2) You may not copy, modify, or change, all or any part of, the SOFTWARE without permission from Advantest.
- (3) You may not reverse engineer, de-compile, or disassemble, all or any part of, the SOFTWARE.

### **Liability**

Advantest shall have no liability (1) for any PRODUCT failures, which may arise out of any misuse (misuse is deemed to be use of the SOFTWARE for purposes other than its intended use) of the SOFTWARE. (2) For any dispute between you and any third party for any reason whatsoever including, but not limited to, infringement of intellectual property rights.

## LIMITED WARRANTY

1. Unless otherwise specifically agreed by Seller and Purchaser in writing, Advantest will warrant to the Purchaser that during the Warranty Period this Product (other than consumables included in the Product) will be free from defects in material and workmanship and shall conform to the specifications set forth in this Operation Manual.
2. The warranty period for the Product (the "Warranty Period") will be a period of one year commencing on the delivery date of the Product.
3. If the Product is found to be defective during the Warranty Period, Advantest will, at its option and in its sole and absolute discretion, either (a) repair the defective Product or part or component thereof or (b) replace the defective Product or part or component thereof, in either case at Advantest's sole cost and expense.
4. This limited warranty will not apply to defects or damage to the Product or any part or component thereof resulting from any of the following:
  - (a) any modifications, maintenance or repairs other than modifications, maintenance or repairs (i) performed by Advantest or (ii) specifically recommended or authorized by Advantest and performed in accordance with Advantest's instructions;
  - (b) any improper or inadequate handling, carriage or storage of the Product by the Purchaser or any third party (other than Advantest or its agents);
  - (c) use of the Product under operating conditions or environments different than those specified in the Operation Manual or recommended by Advantest, including, without limitation, (i) instances where the Product has been subjected to physical stress or electrical voltage exceeding the permissible range and (ii) instances where the corrosion of electrical circuits or other deterioration was accelerated by exposure to corrosive gases or dusty environments;
  - (d) use of the Product in connection with software, interfaces, products or parts other than software, interfaces, products or parts supplied or recommended by Advantest;
  - (e) incorporation in the Product of any parts or components (i) provided by Purchaser or (ii) provided by a third party at the request or direction of Purchaser or due to specifications or designs supplied by Purchaser (including, without limitation, any degradation in performance of such parts or components);
  - (f) Advantest's incorporation or use of any specifications or designs supplied by Purchaser;
  - (g) the occurrence of an event of force majeure, including, without limitation, fire, explosion, geological change, storm, flood, earthquake, tidal wave, lightning or act of war; or
  - (h) any negligent act or omission of the Purchaser or any third party other than Advantest.
5. **EXCEPT TO THE EXTENT EXPRESSLY PROVIDED HEREIN, ADVANTEST HEREBY EXPRESSLY DISCLAIMS, AND THE PURCHASER HEREBY WAIVES, ALL WARRANTIES, WHETHER EXPRESS OR IMPLIED, STATUTORY OR OTHERWISE, INCLUDING, WITHOUT LIMITATION, (A) ANY WARRANTY OF MERCHANTABILITY OR FITNESS FOR A PARTICULAR PURPOSE AND (B) ANY WARRANTY OR REPRESENTATION AS TO THE VALIDITY, SCOPE, EFFECTIVENESS OR USEFULNESS OF ANY TECHNOLOGY OR ANY INVENTION.**
6. **THE REMEDY SET FORTH HEREIN SHALL BE THE SOLE AND EXCLUSIVE REMEDY OF THE PURCHASER FOR BREACH OF WARRANTY WITH RESPECT TO THE PRODUCT.**
7. **ADVANTEST WILL NOT HAVE ANY LIABILITY TO THE PURCHASER FOR ANY INDIRECT, INCIDENTAL, SPECIAL, CONSEQUENTIAL OR PUNITIVE DAMAGES, INCLUDING, WITHOUT LIMITATION, LOSS OF ANTICIPATED PROFITS OR REVENUES, IN ANY AND ALL CIRCUMSTANCES, EVEN IF ADVANTEST HAS BEEN ADVISED OF THE POSSIBILITY OF SUCH DAMAGES AND WHETHER ARISING OUT OF BREACH OF CONTRACT, WARRANTY, TORT (INCLUDING, WITHOUT LIMITATION, NEGLIGENCE), STRICT LIABILITY, INDEMNITY, CONTRIBUTION OR OTHERWISE. TORT (INCLUDING, WITHOUT LIMITATION, NEGLIGENCE), STRICT LIABILITY, INDEMNITY, CONTRIBUTION OR OTHERWISE.**
8. **OTHER THAN THE REMEDY FOR THE BREACH OF WARRANTY SET FORTH HEREIN, ADVANTEST SHALL NOT BE LIABLE FOR, AND HEREBY DISCLAIMS TO THE FULLEST EXTENT PERMITTED BY LAW ANY LIABILITY FOR, DAMAGES FOR PRODUCT FAILURE OR DEFECT, WHETHER ARISING OUT OF BREACH OF CONTRACT, TORT (INCLUDING, WITHOUT LIMITATION, NEGLIGENCE), STRICT LIABILITY, INDEMNITY, CONTRIBUTION OR OTHERWISE.**

## **CUSTOMER SERVICE DESCRIPTION**

In order to maintain safe and trouble-free operation of the Product and to prevent the incurrence of unnecessary costs and expenses, Advantest recommends a regular preventive maintenance program under its maintenance agreement.

Advantest's maintenance agreement provides the Purchaser on-site and off-site maintenance, parts, maintenance machinery, regular inspections, and telephone support and will last a maximum of ten years from the date the delivery of the Product. For specific details of the services provided under the maintenance agreement, please contact the nearest Advantest office listed at the end of this Operation Manual or Advantest's sales representatives.

Some of the components and parts of this Product have a limited operating life (such as, electrical and mechanical parts, fan motors, unit power supply, etc.). Accordingly, these components and parts will have to be replaced on a periodic basis. If the operating life of a component or part has expired and such component or part has not been replaced, there is a possibility that the Product will not perform properly. Additionally, if the operating life of a component or part has expired and continued use of such component or part damages the Product, the Product may not be repairable. Please contact the nearest Advantest office listed at the end of this Operation Manual or Advantest's sales representatives to determine the operating life of a specific component or part, as the operating life may vary depending on various factors such as operating condition and usage environment.

## SALES & SUPPORT OFFICES

Advantest Korea Co., Ltd.

22BF, Kyobo KangNam Tower,  
1303-22, Seocho-Dong, Seocho-Ku, Seoul #137-070, Korea  
Phone: +82-2-532-7071  
Fax: +82-2-532-7132

Advantest (Suzhou) Co., Ltd.

Shanghai Branch Office:  
Bldg. 6D, NO.1188 Gumei Road, Shanghai, China 201102 P.R.C.  
Phone: +86-21-6485-2725  
Fax: +86-21-6485-2726

Shanghai Branch Office:  
406/F, Ying Building, Quantum Plaza, No. 23 Zhi Chun Road,  
Hai Dian District, Beijing,  
China 100083  
Phone: +86-10-8235-3377  
Fax: +86-10-8235-6717

Advantest (Singapore) Pte. Ltd.

438A Alexandra Road, #08-03/06  
Alexandra Technopark Singapore 119967  
Phone: +65-6274-3100  
Fax: +65-6274-4055

Advantest America, Inc.

3201 Scott Boulevard, Suite, Santa Clara, CA 95054, U.S.A  
Phone: +1-408-988-7700  
Fax: +1-408-987-0691

ROHDE & SCHWARZ Europe GmbH

Mühldorfstraße 15 D-81671 München, Germany  
(P.O.B. 80 14 60 D-81614 München, Germany)  
Phone: +49-89-4129-13711  
Fax: +49-89-4129-13723

**ADVANTEST®**

<http://www.advantest.co.jp>