

---

---

**ADVANTEST®**  
ADVANTEST CORPORATION

---

*R3965/66 Series*

*3-Port Test Set*

*Operation Manual*

MANUAL NUMBER FOE-8335015A01

---

*Applicable models*

*R3965A*  
*R3965B*  
*R3966A*  
*R3966B*



---

## Safety Summary

To ensure thorough understanding of all functions and to ensure efficient use of this instrument, please read the manual carefully before using. Note that Advantest bears absolutely no responsibility for the result of operations caused due to incorrect or inappropriate use of this instrument.

If the equipment is used in a manner not specified by Advantest, the protection provided by the equipment may be impaired.

- **Warning Labels**

Warning labels are applied to Advantest products in locations where specific dangers exist. Pay careful attention to these labels during handling. Do not remove or tear these labels. If you have any questions regarding warning labels, please ask your nearest Advantest dealer. Our address and phone number are listed at the end of this manual.

Symbols of those warning labels are shown below together with their meaning.

**DANGER:** Indicates an imminently hazardous situation which will result in death or serious personal injury.

**WARNING:** Indicates a potentially hazardous situation which will result in death or serious personal injury.

**CAUTION:** Indicates a potentially hazardous situation which will result in personal injury or a damage to property including the product.

- **Basic Precautions**

Please observe the following precautions to prevent fire, burn, electric shock, and personal injury.

- Use a power cable rated for the voltage in question. Be sure however to use a power cable conforming to safety standards of your nation when using a product overseas.
- When inserting the plug into the electrical outlet, first turn the power switch OFF and then insert the plug as far as it will go.
- When removing the plug from the electrical outlet, first turn the power switch OFF and then pull it out by gripping the plug. Do not pull on the power cable itself. Make sure your hands are dry at this time.
- Before turning on the power, be sure to check that the supply voltage matches the voltage requirements of the instrument.
- Connect the power cable to a power outlet that is connected to a protected ground terminal. Grounding will be defeated if you use an extension cord which does not include a protected ground terminal.
- Be sure to use fuses rated for the voltage in question.
- Do not use this instrument with the case open.
- Do not place anything on the product and do not apply excessive pressure to the product. Also, do not place flower pots or other containers containing liquid such as chemicals near this

---

## Safety Summary

product.

- When the product has ventilation outlets, do not stick or drop metal or easily flammable objects into the ventilation outlets.
- When using the product on a cart, fix it with belts to avoid its drop.
- When connecting the product to peripheral equipment, turn the power off.

- **Caution Symbols Used Within this Manual**

Symbols indicating items requiring caution which are used in this manual are shown below together with their meaning.

**DANGER:** Indicates an item where there is a danger of serious personal injury (death or serious injury).

**WARNING:** Indicates an item relating to personal safety or health.

**CAUTION:** Indicates an item relating to possible damage to the product or instrument or relating to a restriction on operation.

- **Safety Marks on the Product**

The following safety marks can be found on Advantest products.



: ATTENTION - Refer to manual.



: Protective ground (earth) terminal.



: DANGER - High voltage.



: CAUTION - Risk of electric shock.

- **Replacing Parts with Limited Life**

The following parts used in the instrument are main parts with limited life.

Replace the parts listed below before their expected lifespan has expired to maintain the performance and function of the instrument.

Note that the estimated lifespan for the parts listed below may be shortened by factors such as the environment where the instrument is stored or used, and how often the instrument is used.

The parts inside are not user-replaceable. For a part replacement, please contact the Advantest sales office for servicing.

Each product may use parts with limited life.

For more information, refer to the section in this document where the parts with limited life are described.

## Main Parts with Limited Life

Part name	Life
Unit power supply	5 years
Fan motor	5 years
Electrolytic capacitor	5 years
LCD display	6 years
LCD backlight	2.5 years
Floppy disk drive	5 years
Memory backup battery	5 years

- **Hard Disk Mounted Products**

The operational warnings are listed below.

- Do not move, shock and vibrate the product while the power is turned on.  
Reading or writing data in the hard disk unit is performed with the memory disk turning at a high speed. It is a very delicate process.
- Store and operate the products under the following environmental conditions.  
An area with no sudden temperature changes.  
An area away from shock or vibrations.  
An area free from moisture, dirt, or dust.  
An area away from magnets or an instrument which generates a magnetic field.
- Make back-ups of important data.  
The data stored in the disk may become damaged if the product is mishandled. The hard disc has a limited life span which depends on the operational conditions. Note that there is no guarantee for any loss of data.

- **Precautions when Disposing of this Instrument**

When disposing of harmful substances, be sure dispose of them properly with abiding by the state-provided law.

Harmful substances: (1) PCB (polycarbon biphenyl)  
(2) Mercury  
(3) Ni-Cd (nickel cadmium)  
(4) Other  
Items possessing cyan, organic phosphorous and hexadic chromium and items which may leak cadmium or arsenic (excluding lead in solder).

Example: fluorescent tubes, batteries

# Environmental Conditions

This instrument should only be used in an area which satisfies the following conditions:

- An area free from corrosive gas
- An area away from direct sunlight
- A dust-free area
- An area free from vibrations
- Altitude of up to 2000 m

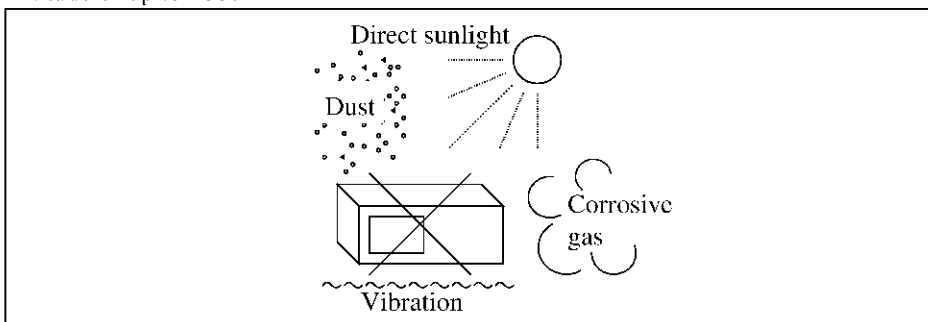

**Figure-1 Environmental Conditions**

- Operating position

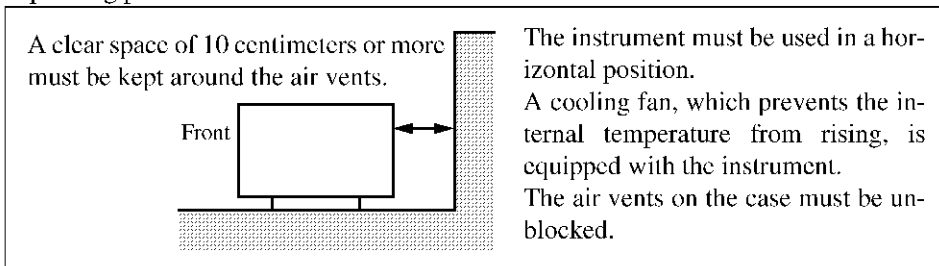

**Figure-2 Operating Position**

- Storage position

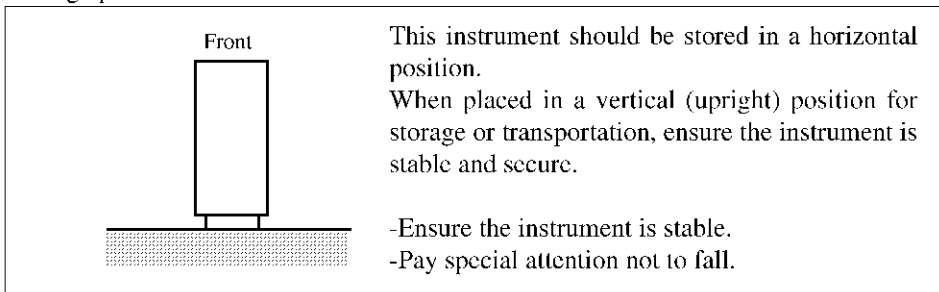

**Figure-3 Storage Position**



- The classification of the transient over-voltage, which exists typically in the main power supply, and the pollution degree is defined by IEC61010-1 and described below.

Impulse withstand voltage (over-voltage) category II defined by IEC60364-4-443

Pollution Degree 2

## Types of Power Cable

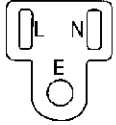
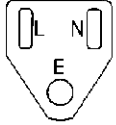
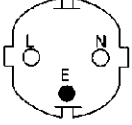
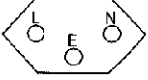
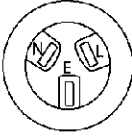
Replace any references to the power cable type, according to the following table, with the appropriate power cable type for your country.

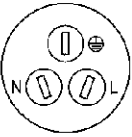
Plug configuration	Standards	Rating, color and length	Model number (Option number)
	PSE: Japan  Electrical Appliance and Material Safety Law	125 V at 7 A Black 2 m (6 ft)	Straight: A01402  Angled: A01412
	UL: United States of America  CSA: Canada	125 V at 7 A Black 2 m (6 ft)	Straight: A01403 (Option 95)  Angled: A01413
	CEE: Europe DEMKO: Denmark NEMKO: Norway VDE: Germany KEMA: The Netherlands CEBEC: Belgium OVE: Austria FIMKO: Finland SEMKO: Sweden	250 V at 6 A Gray 2 m (6 ft)	Straight: A01404 (Option 96)  Angled: A01414
	SEV: Switzerland	250 V at 6 A Gray 2 m (6 ft)	Straight: A01405 (Option 97)  Angled: A01415
	SAA: Australia, New Zealand	250 V at 6 A Gray 2 m (6 ft)	Straight: A01406 (Option 98)  Angled: -----
	BS: United Kingdom	250 V at 6 A Black 2 m (6 ft)	Straight: A01407 (Option 99)  Angled: A01417
	CCC: China	250 V at 10 A Black 2 m (6 ft)	Straight: A114009 (Option 94)  Angled: A114109





## PREFACE

- This manual describes the following test sets and test adapters:
  - 3-port test set:           The R3965A and R3965B
  - 3-port test adapter:       The R3966A and R3966B
- The R3965A and R3965B can be connected to the R3765AH and R3767AH network analyzers.
- The R3966A and R3966B can be connected to the R3765CH and R3767CH network analyzers.



## TABLE OF CONTENTS

1	OUTLINE .....	1-1
1.1	Products Overview .....	1-1
1.2	R3965A/B and R3966A/B Precautions .....	1-1
1.3	Attachments .....	1-2
1.4	Accessories .....	1-3
2	PANEL DESCRIPTION .....	2-1
2.1	Front Panel Description .....	2-1
2.2	Rear Panel Description .....	2-3
3	CONNECTING THE R3965/66 TO A NETWORK ANALYZER .....	3-1
3.1	RF Cable Connection .....	3-1
3.2	Control Cable Connection .....	3-3
4	BASIC MEASUREMENTS .....	4-1
4.1	Measurement Overview .....	4-1
4.2	Calibration (TRIPLEX 2PORT CAL) .....	4-2
4.3	Measurement Examples .....	4-10
5	OPERATION DESCRIPTION .....	5-1
5.1	Operation of R3965A/B .....	5-1
5.2	Operation of R3966A/B .....	5-5
6	PERFORMANCE TESTS .....	6-1
6.1	Preparations for the Tests .....	6-1
6.2	Directivity (R3965A/B only) .....	6-2
6.3	Test Port Load Match (R3965A/B only) .....	6-4
6.4	Frequency Characteristics (R3965A/B only) .....	6-9
6.4.1	Transmission Magnitude (R3965A/B only) .....	6-9
6.4.2	Reflection Magnitude (R3965A/B only) .....	6-12
6.5	Insertion Loss .....	6-15
6.6	Isolation .....	6-21
7	SPECIFICATIONS .....	7-1
7.1	Specifications of R3965A/B .....	7-1
7.2	Specifications of R3966A/B .....	7-3
	APPENDIX .....	A-1
A.1	MEAS Extension and Calibration Function Extension .....	A-1
A.1.1	MEAS extension (test port switching in three-port mode) .....	A-1

Table of Contents

A.1.2	Calibration function extension (TRIPLEX 2 PORT CAL / FULL 3 PORT CAL) .....	A-2
A.1.3	List of GPIB codes .....	A-5
EXTERNAL VIEWS .....		EXT-1
R3965A FRONT VIEW .....		EXT-1
R3965B FRONT VIEW .....		EXT-2
R3966A FRONT VIEW .....		EXT-3
R3966B FRONT VIEW .....		EXT-4
R3965A/66A REAR VIEW .....		EXT-5
R3965B REAR VIEW .....		EXT-6
R3966B REAR VIEW .....		EXT-7

## LIST OF ILLUSTRATIONS

No.	Title	Page
2-1	R3965A Front Panel .....	2-1
2-2	R3965B Front Panel .....	2-1
2-3	R3966A Front Panel .....	2-2
2-4	R3966B Front Panel .....	2-2
2-5	A Type Rear Panel .....	2-3
2-6	R3965B Rear Panel .....	2-3
2-7	R3966B Rear Panel .....	2-4
3-1	R3965A Connection .....	3-1
3-2	R3965B Connection .....	3-1
3-3	R3966A Connection .....	3-2
3-4	R3966B Connection .....	3-2
3-5	A Type Connection .....	3-3
3-6	B Type Connection .....	3-4
4-1	PORT1 Reflection Calibration Using the Open Standard .....	4-2
4-2	PORT1 Reflection Calibration Using the Short Standard .....	4-3
4-3	PORT1 Reflection Calibration Using the Load Standard .....	4-3
4-4	TRIPLEX 2PORT (PORT1) Reflection Calibration .....	4-4
4-5	TRIPLEX 2PORT (PORT1 to PORT2) Transmission Characteristics .....	4-5
4-6	TRIPLEX 2PORT Transmission Calibration .....	4-6
4-7	TRIPLEX 2PORT (PORT1 to PORT2) Isolation Calibration .....	4-7
4-8	TRIPLEX 2PORT Isolation Calibration .....	4-8
4-9	TRIPLEX 2PORT Calibration .....	4-9
4-10	Setup Diagram .....	4-10
4-11	Transmission Characteristics between TEST PORT1 and TEST PORT2 .....	4-11
4-12	Transmission Characteristics between TEST PORT1 and TEST PORT3 .....	4-12
4-13	Transmission Characteristics between TEST PORT2 and TEST PORT3 .....	4-13
5-1	R3965A/B Operation Block Diagram .....	5-4
5-2	R3966A/B Operation Block Diagram .....	5-7



---

## LIST OF TABLES

No.	Title	Page
1-1	Standard Attachments for R3965A/B .....	1-2
1-2	Standard Attachments for R3966A/B .....	1-2
1-3	Accessories .....	1-3
A-1	Relationship between the New and Previous MEAS Commands .....	A-6
A-2	Relationship between the Panel Menu and the STAN Command .....	A-9





# 1 OUTLINE

## 1.1 Products Overview

The R3965A and R3965B are three-port test sets which can be connected to the R3765AH and R3767AH network analyzers and used to measure transmission characteristics and reflection characteristics for three-port devices.

The test sets allow you to measure S parameters in three directions without changing the device connections .

The R3966A and R3966B are three-port test adapters which can be connected to the R3765CH and R3767CH network analyzers and used to measure transmission characteristics and reflection characteristics for three-port devices.

The test adapters can measure S parameters in three directions without the device connections being changed.

In this manual, the above test sets and test adapters are sometimes referred to as "the instrument".

## 1.2 R3965A/B and R3966A/B Precautions

- (1) Turn the network analyzer power ON only after connecting the rear control cable between the instrument and the network analyzer.
- (2) When turning the network analyzer on, make sure that the instrument is connected to the network analyzer. If not, the instrument can not be controlled from the network analyzer.
- (3) If the instrument is connected to the network analyzer after its' power has been turned on, the network analyzer cannot control the instrument.

## 1.3 Attachments

**1.3 Attachments**

When the instrument is delivered, make sure to check the following:

- ① Visually check to make sure there is no damage to the instrument.
- ② Make sure that the standard attachments listed in Table 1-1 and Table 1-2 are present.

If any of attachment is damaged or missing, contact an ADVANTEST customer engineering center or the nearest sales office.

Addresses and phone numbers are listed on the last page of this manual.

**Note:** *Please refer to attachments by their stock number when ordering.*

**Table 1-1 Standard Attachments for R3965A/B**

Part name	Stock number	Quantity
N-N cable	A01247	3
Control cable used for A type	A01241	1
Control cable used for B type	A01281	1
N-SMA adapter used for B type	JCF-AA001PX16-5	6

**Table 1-2 Standard Attachments for R3966A/B**

Part name	Stock number	Quantity
N-N cable	A01247	2
Control cable used for A type	A01241	1
Control cable used for B type	A01281	1
N-SMA adapter used for B type	JCF-AA001PX16-5	5

## 1.4 Accessories

**Table 1-3 Accessories**

Part name	Type name	Remarks
N type 50 $\Omega$ CAL kit	Model 9617A3	DC to 18GHz female & male
3.5mm CAL kit	Model 9617F3	DC to 18GHz female & male
Conversion adapter 50 $\Omega$	HRM-555S	N (male) to SMA (male)
Conversion adapter 50 $\Omega$	HRM-554S	N (male) to SMA (female)



## 2 PANEL DESCRIPTION

### 2.1 Front Panel Description

(1) R3965A/B

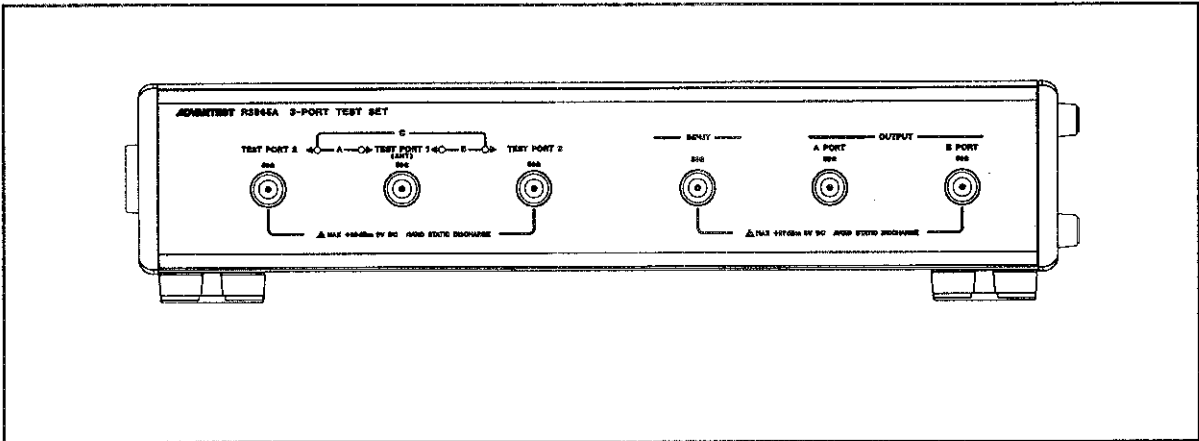

Figure 2-1 R3965A Front Panel

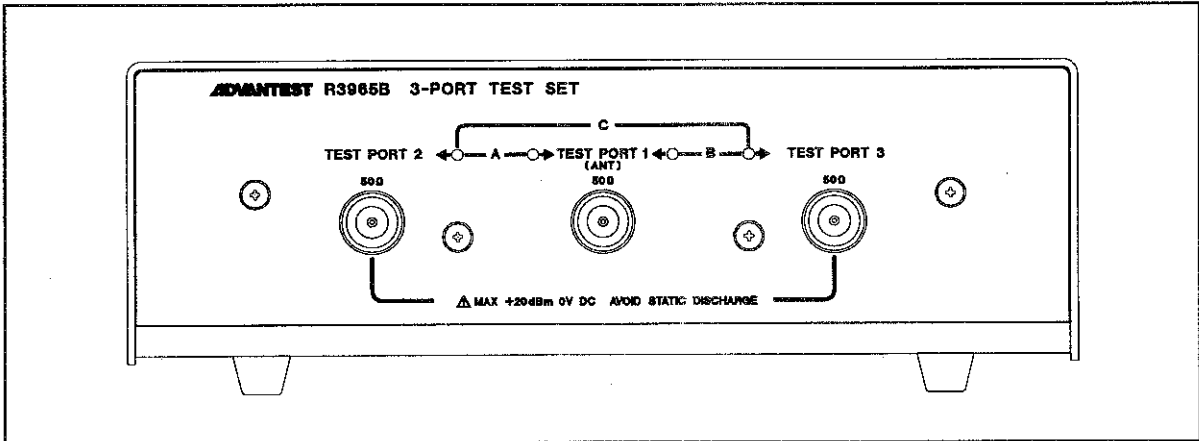

Figure 2-2 R3965B Front Panel

2.1 Front Panel Description

(2) R3966A/B

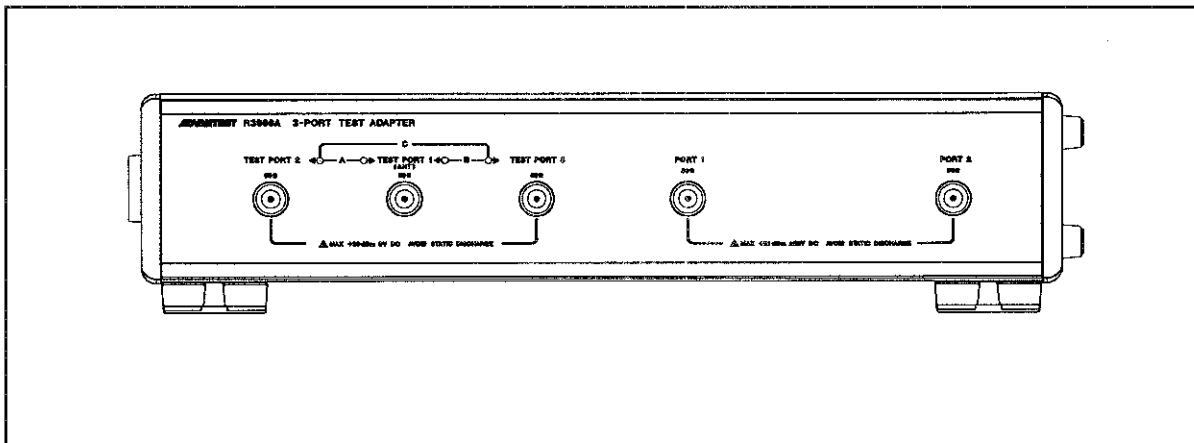

Figure 2-3 R3966A Front Panel

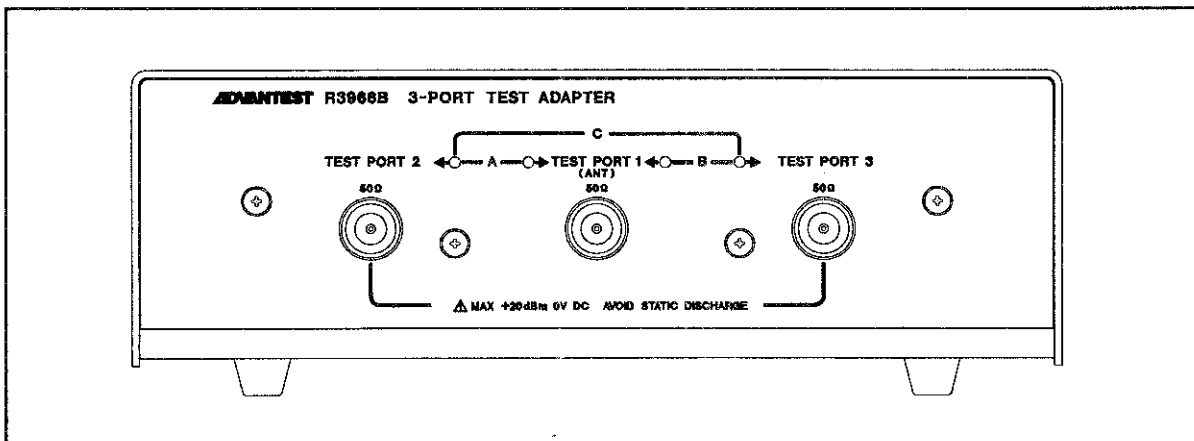

Figure 2-4 R3966B Front Panel

2.2 Rear Panel Description

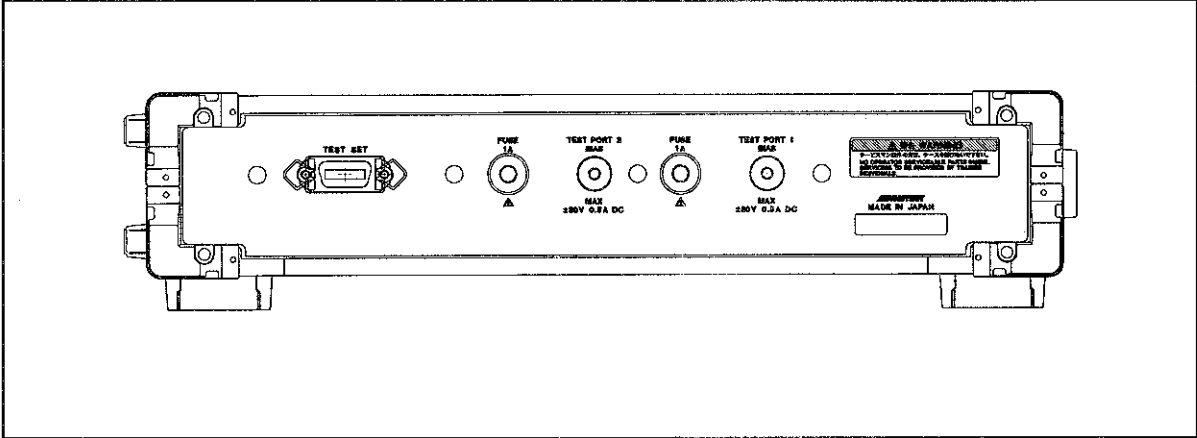

Figure 2-5 A Type Rear Panel

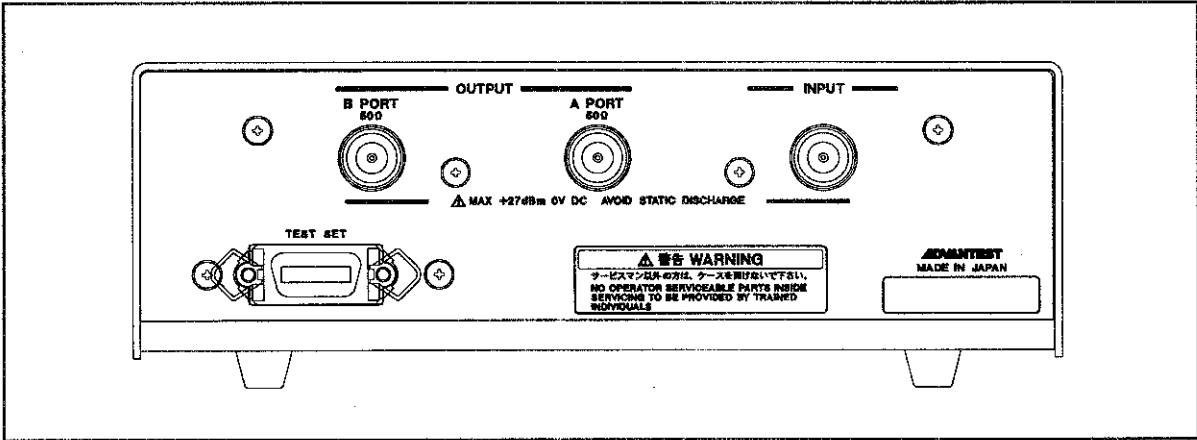

Figure 2-6 R3965B Rear Panel

2.2 Rear Panel Description

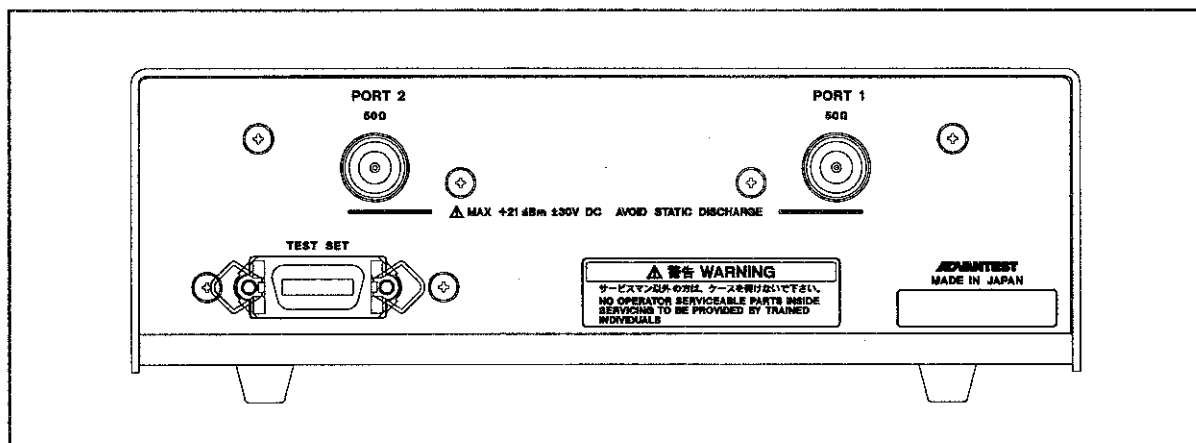

Figure 2-7 R3966B Rear Panel



### 3 CONNECTING THE R3965/66 TO A NETWORK ANALYZER

The R3965A and R3965B can be connected to the R3765AH or R3767AH.  
 The R3966A and R3966B can be connected to the R3765CH or R3767CH.

#### 3.1 RF Cable Connection

- (1) R3965A/B

Connect the instrument to the network analyzer using the attached N-N cables as shown below:

R3965A/B		R3765AH/R3767AH	Cable used
INPUT	●—————●	SOURCE	A01247
A PORT	●—————●	A PORT	A01247
B PORT	●—————●	B PORT	A01247

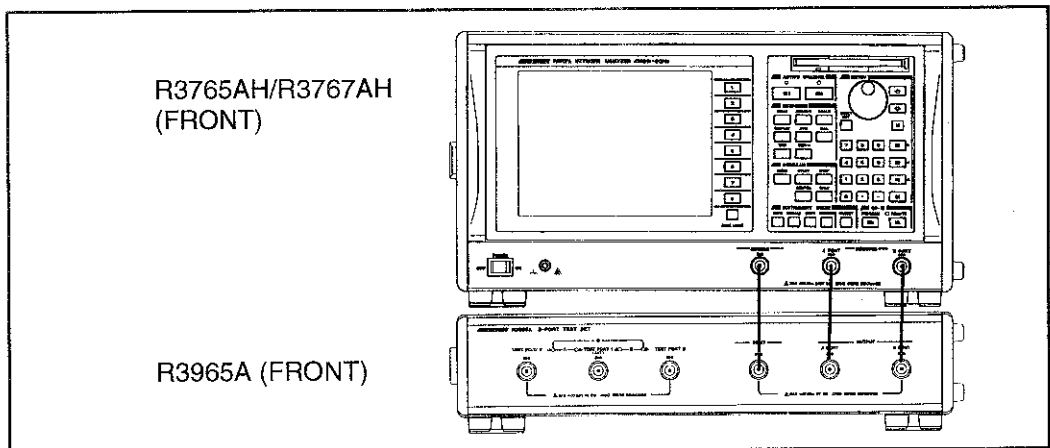

Figure 3-1 R3965A Connection

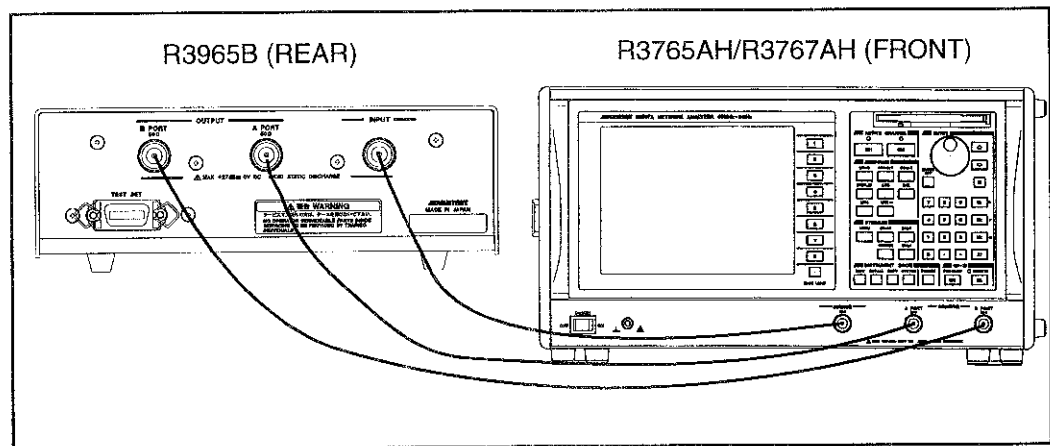

Figure 3-2 R3965B Connection

3.1 RF Cable Connection

(2) R3966A/B

Connect the instrument to the network analyzer using the attached N-N cables as shown below:

R3966A/B	R3765CH/R3767CH	Cable used
PORT1	TEST PORT1	A01247
PORT2	TEST PORT2	A01247

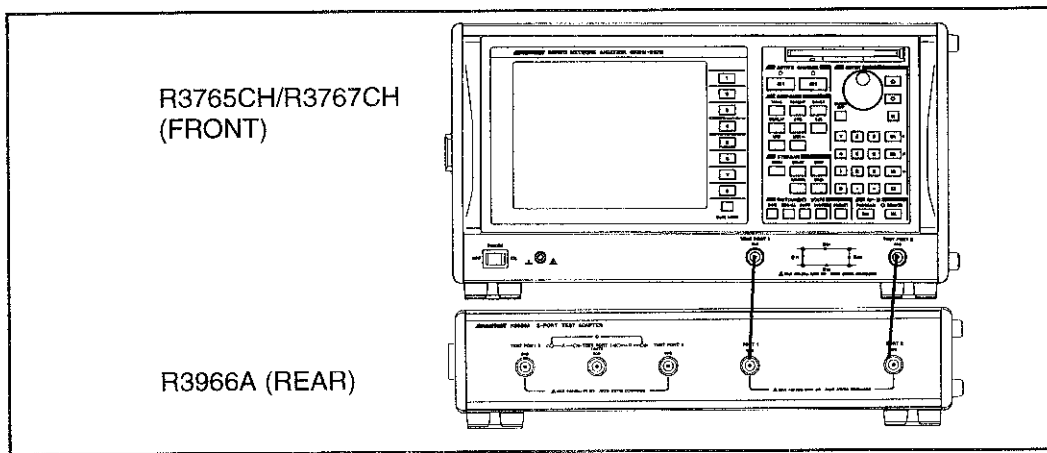

Figure 3-3 R3966A Connection

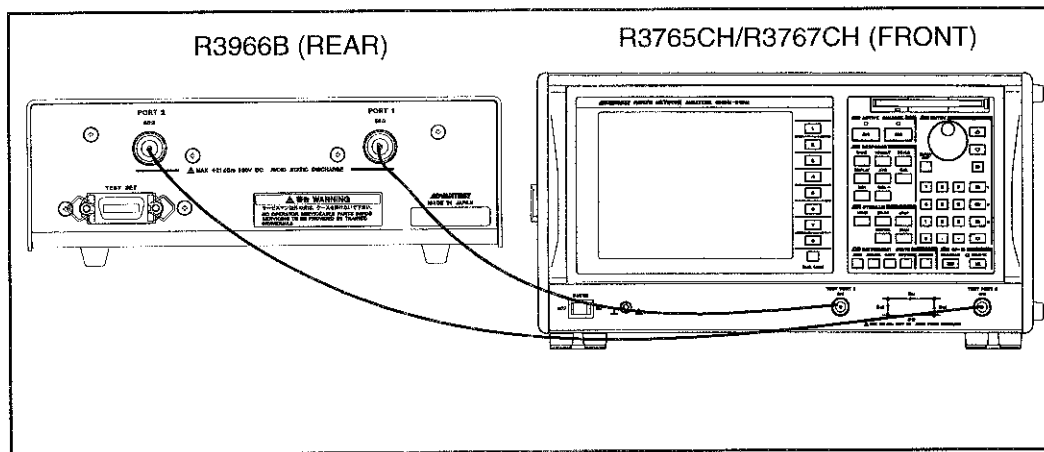

Figure 3-4 R3966B Connection

### 3.2 Control Cable Connection

- (1) R3965A/R3966A

Connect the instrument to the network analyzer using the attached control cable (A01241) as shown below:

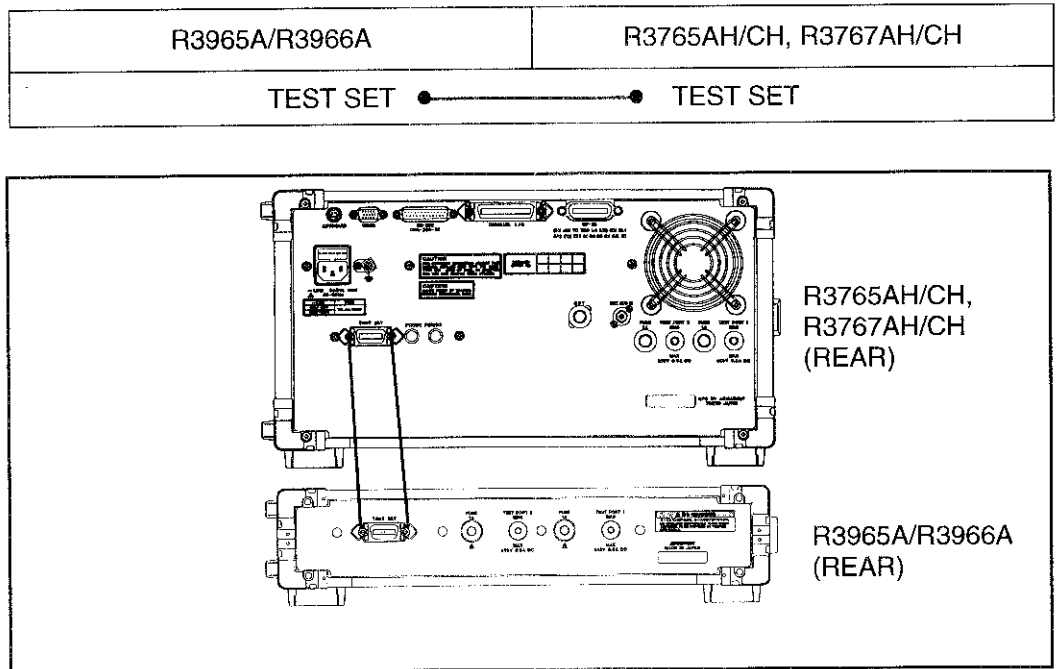

Figure 3-5 A Type Connection

3.2 Control Cable Connection

(2) R3965B/R3966B

Connect the instrument to the network analyzer using the attached cable (A01281) as shown below:

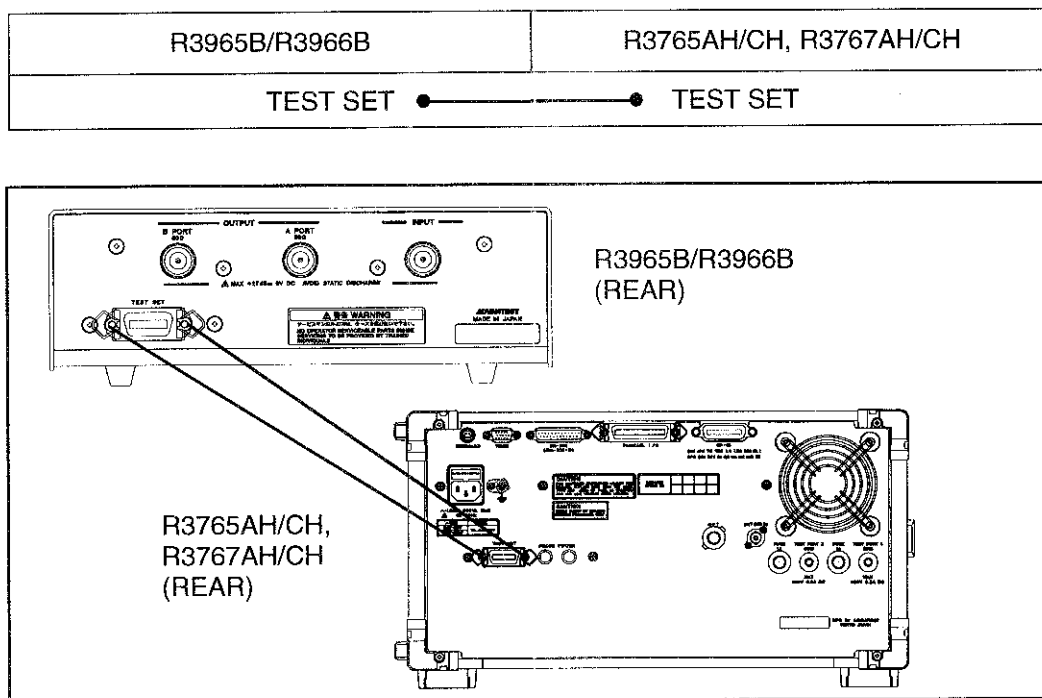

Figure 3-6 B Type Connection

## 4 BASIC MEASUREMENTS

### 4.1 Measurement Overview

**CAUTION!**

*Use the 50  $\Omega$ -system CAL kit and connecting cables for the instrument being used.  
When calibrating the instrument, set the CAL kit type and FEMAL/MAL (polarity) according to connector terminals used before performing measurements.*

Select the S parameter to be measured using the **MEAS** key.

<b>S11</b> :	Reflection characteristics for TEST PORT1
<b>S22</b> :	Reflection characteristics for TEST PORT2
<b>S33</b> :	Reflection characteristics for TEST PORT3
<b>S21</b> :	Transmission characteristics from TEST PORT1 to TEST PORT2
<b>S23</b> :	Transmission characteristics from TEST PORT3 to TEST PORT2
<b>S12</b> :	Transmission characteristics from TEST PORT2 to TEST PORT1
<b>S13</b> :	Transmission characteristics from TEST PORT3 to TEST PORT1
<b>S31</b> :	Transmission characteristics from TEST PORT1 to TEST PORT3
<b>S32</b> :	Transmission characteristics from TEST PORT2 to TEST PORT3

4.2 Calibration (TRIPLEX 2PORT CAL)

4.2 Calibration (TRIPLEX 2PORT CAL)

A procedure for performing a TRIPLEX 2PORT CAL and measuring devices using the R3965A or R3965B three-port test set is shown below:  
 The triplex two-port calibration has the same procedure as the three-port calibration.

**CAUTION!**

1. *When a calibration has already been performed, clear the previous calibration data by selecting CLEAR CAL DATA and then start the new calibration.*
2. *The calibration is completed when the "Wait for Sweep" message is turned off.*
3. *While this message is displayed, do not move the instrument, connecting cables, or connectors.*

- ① Invoke the TRIPLEX 2PORT CAL menu as shown below:  
**CAL, CAL MEAS, TRIPLEX 2PORT CAL**
- ② Invoke the PORT1 REFLECTION menu from the TRIPLEX 2PORT Reflection Calibration.  
**PORT1 REFLECT'N**
- ③ Connect the open standard to the TEST PORT1 to obtain the calibration data.  
**S11(PORT1) OPEN**

The screen displayed after the calibration data has been obtained is shown in Figure 4-1.

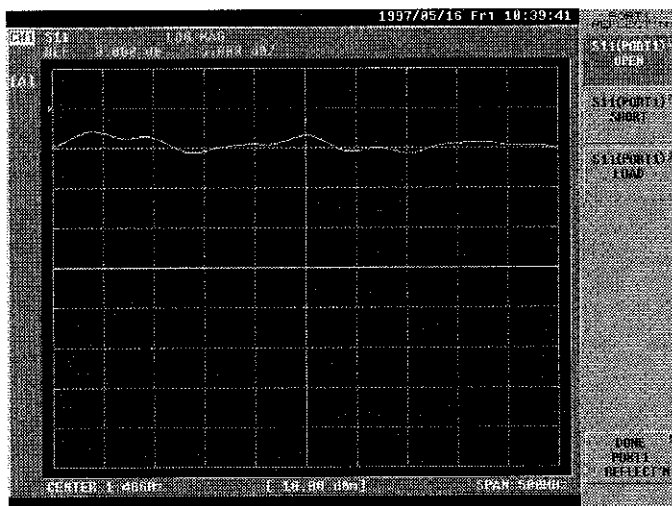

Figure 4-1 PORT1 Reflection Calibration Using the Open Standard

- ④ Connect the short standard to TEST PORT1 to obtain the calibration data.  
**S11(PORT1) SHORT**

The screen displayed after the calibration data has been obtained is shown in Figure 4-2.

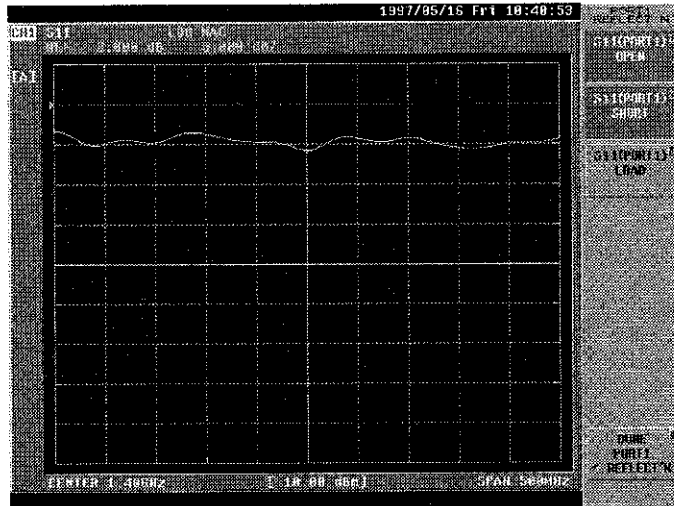

Figure 4-2 PORT1 Reflection Calibration Using the Short Standard

- ⑤ Connect the load standard to TEST PORT1 to obtain the calibration data.  
**S11(PORT1) LOAD**

The screen displayed after the calibration data has been obtained is shown in Figure 4-3.

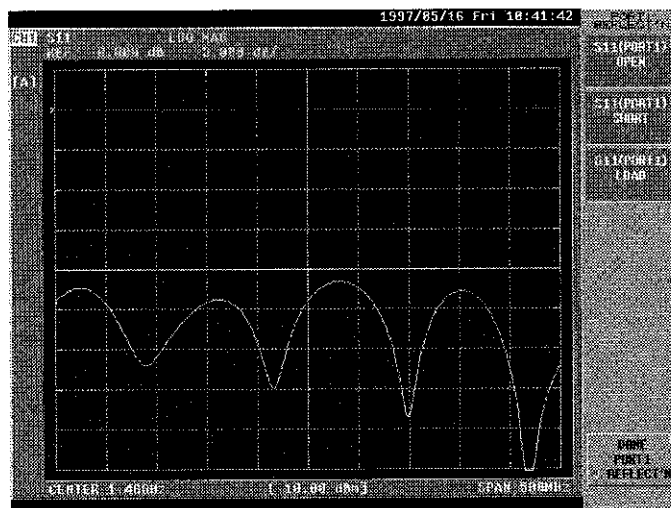

Figure 4-3 PORT1 Reflection Calibration Using the Load Standard

4.2 Calibration (TRIPLEX 2PORT CAL)

- ⑥ Perform the TEST PORT1 reflection calibration.  
**DONE PORT1 REFLECT'N**  
(It is possible to obtain the calibration data again for each calibration standard if this key is not pressed.)

The screen returns to the TRIPLEX 2PORT CAL menu when the TEST PORT1 reflection calibration is completed.

When the key is pressed, the screen is displayed as shown in Figure 4-4.

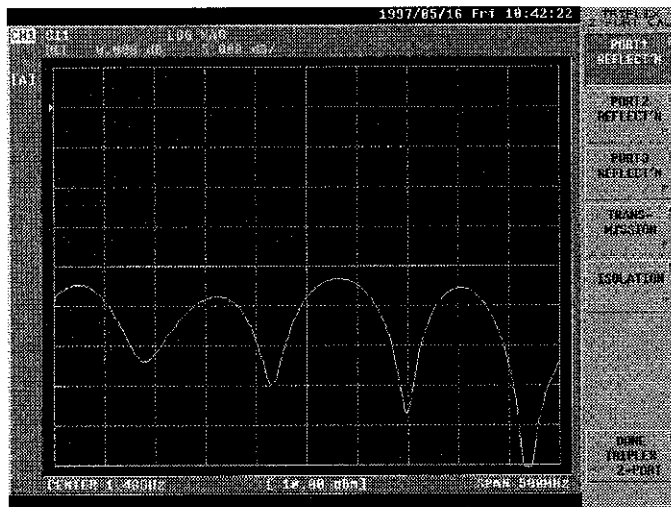

Figure 4-4 TRIPLEX 2PORT (PORT1) Reflection Calibration

- ⑦ Calibrate TEST PORT2 and TEST PORT3 in the same way as TEST PORT1  
Step ⑧ to step ⑱ shown below list how to do this:
- ⑧ Invoke the PORT2 REFLECTION menu from the TRIPLEX 2PORT Reflection Calibration.  
**PORT2 REFLECT'N**
- ⑨ Connect the open standard to TEST PORT2 to obtain the calibration data.  
**S22(PORT2) OPEN**
- ⑩ Connect the short standard to TEST PORT2 to obtain the calibration data.  
**S22(PORT2) SHORT**
- ⑪ Connect the load standard to TEST PORT2 to obtain the calibration data.  
**S22(PORT2) LOAD**
- ⑫ Execute the TEST PORT2 reflection calibration.  
**DONE PORT2 REFLECT'N**  
(It is possible to obtain the calibration data again for each calibration standard if this key is not pressed.)
- ⑬ The screen returns to the TRIPLEX 2PORT CAL menu when the TEST PORT2 reflection calibration is completed.



- ⑭ Invoke the PORT3 REFLECTION menu from the TRIPLEX 2PORT Reflection Calibration.  
**PORT3 REFLECTION**
- ⑮ Connect the open standard to TEST PORT3 to obtain the calibration data.  
**S33(PORT3) OPEN**
- ⑯ Connect the short standard to TEST PORT3 to obtain the calibration data.  
**S33(PORT3) SHORT**
- ⑰ Connect the load standard to TEST PORT3 to obtain the calibration data.  
**S33(PORT3) LOAD**
- ⑱ Execute the TEST PORT3 reflection calibration.  
**DONE PORT3 REFLECTION**  
(It is possible to obtain the calibration data again for each calibration standard if this key is not pressed.)
- ⑲ The screen returns to the TRIPLEX 2PORT CAL menu when the TEST PORT3 reflection calibration is completed.
- ⑳ Invoke the TRANS MISSION menu from the TRIPLEX 2PORT Transmission Calibration.  
**TRANS MISSION**
- ㉑ Perform the transmission calibration between TEST PORT1 and TEST PORT2.  
Connect the thru standard between TEST PORT1 and TEST PORT2.  
**A(P1-P2) THRU**

The screen displayed after the calibration data has been obtained is shown in Figure 4-5.

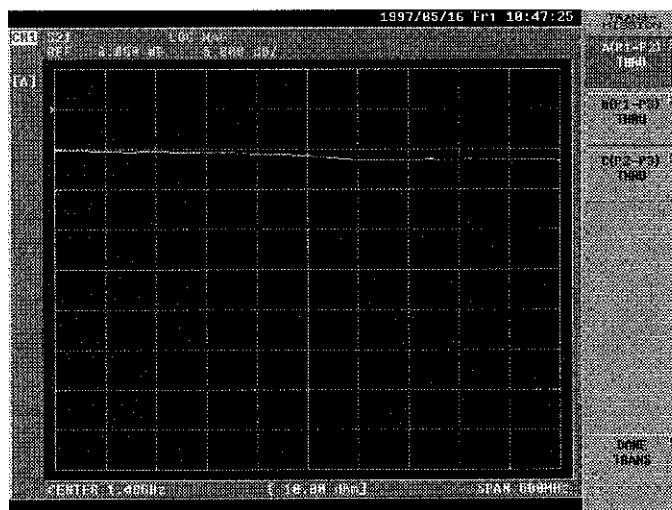

Figure 4-5 TRIPLEX 2PORT (PORT1 to PORT2) Transmission Characteristics

4.2 Calibration (TRIPLEX 2PORT CAL)

- ② Perform the transmission calibration between TEST PORT1 and TEST PORT3.  
Connect the thru standard between TEST PORT1 and TEST PORT3.  
**B(P1-P3) THRU**
- ③ Perform the transmission calibration between TEST PORT2 and TEST PORT3.  
Connect the thru standard between TEST PORT2 and TEST PORT3.  
**C(P2-P3) THRU**
- ④ Execute the transmission calibration.  
**DONE TRANS**  
(It is possible to obtain the calibration data again for each calibration standard if this key is not pressed.)

The screen returns to the TRIPLEX 2PORT CAL menu when the transmission calibration is completed.

The screen displayed after the calibration data has been obtained is shown in Figure 4-6.

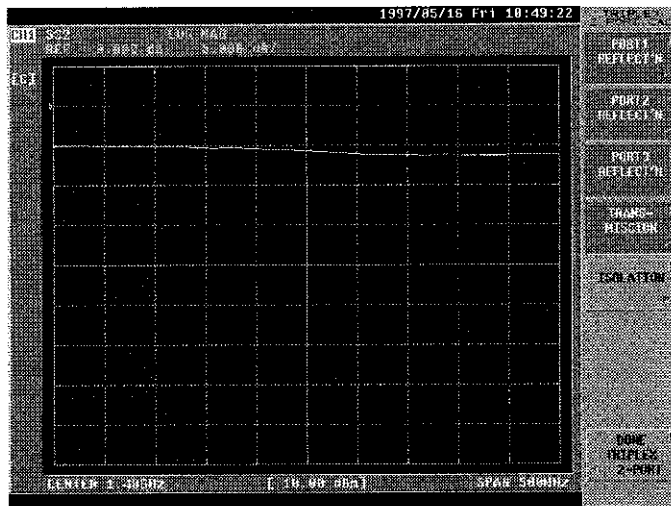

Figure 4-6 TRIPLEX 2PORT Transmission Calibration

- ②⑤ Invoke the TRIPLEX 2PORT ISOLATION menu.  
**ISOLATION**
- ②⑥ When you do not want to perform an isolation calibration, press the following key:  
**OMIT ISOLATION**
- ②⑦ To perform an isolation calibration, do the following:  
Connect the load standards to TEST PORT1 and TEST PORT2 to obtain the calibration data.  
**A(P1-P2) ISOLATION**  
The screen displayed after the calibration data has been obtained is shown in Figure 4-7.

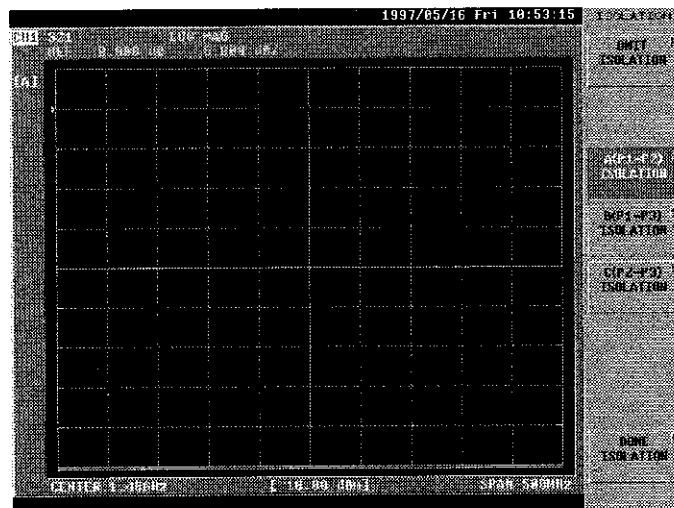

Figure 4-7 TRIPLEX 2PORT (PORT1 to PORT2) Isolation Calibration

4.2 Calibration (TRIPLEX 2PORT CAL)

- ② Connect the load standards to TEST PORT1 and TEST PORT3 and obtain the calibration data.

***B(P1-P3) ISOLATION***

- ② Connect the load standards to TEST PORT2 and TEST PORT3 and obtain the calibration data.

***C(P2-P3) ISOLATION***

- ③ Execute the ISOLATION calibration.

***DONE ISOLATION***

(It is possible to obtain the calibration data again for each calibration standard if this key is not pressed.)

The screen displayed after the calibration data has been obtained is shown in Figure 4-8.

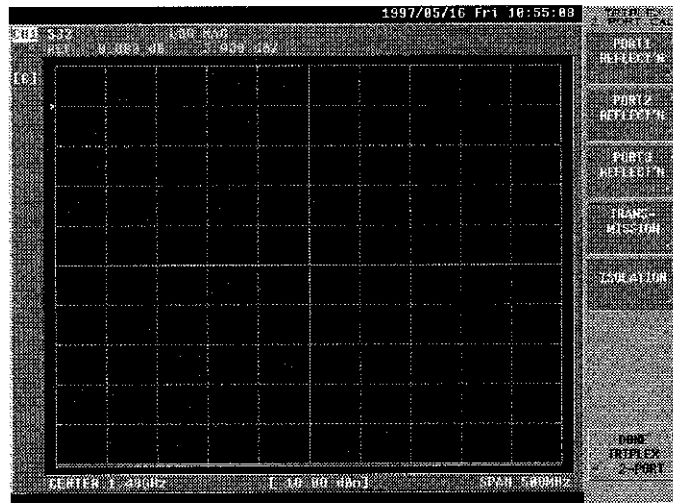
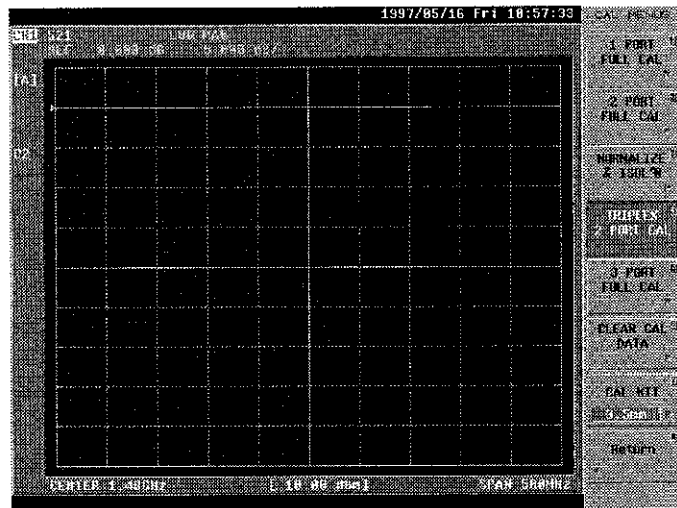

Figure 4-8 TRIPLEX 2PORT Isolation Calibration

- ③ Execute the TRIPLEX 2PORT CAL.  
***DONE TRIPLEX 2-PORT***

The screen is displayed as shown in Figure 4-9.



**Figure 4-9 TRIPLEX 2PORT Calibration**

The TRIPLEX 2PORT CAL is now finished.

4.3 Measurement Examples

### 4.3 Measurement Examples

This section describes a method of measuring transmission characteristics using simultaneous display of channel 1 and channel 3(using SUB MEAS).  
A 1.48 GHz circulator is used as an example.

- ① Perform a setup and preset referring to Figure 4-10 and section 4.4.1 of the Network Analyzer Operation Manual.

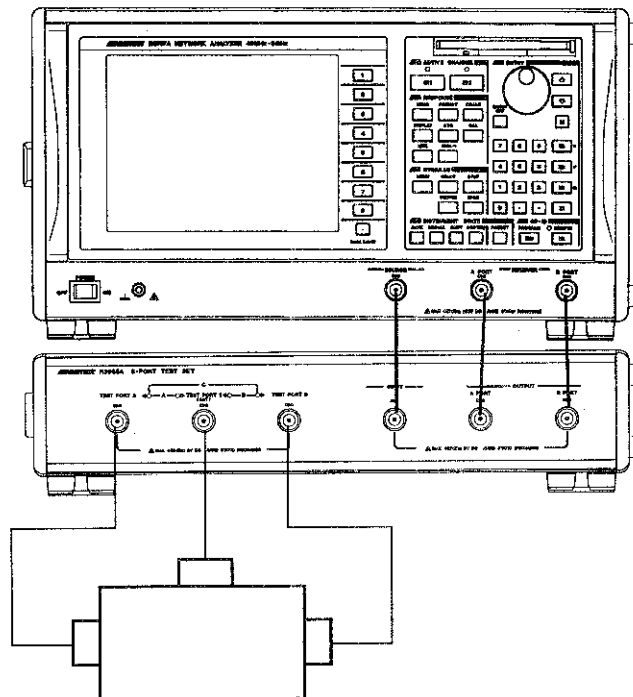

Figure 4-10 Setup Diagram

- ② To measure transmission characteristics between TEST PORT1 and TEST PORT2, set the network analyzer as shown below.

Block name	Setting contents	Key operation
ACTIVE CHANNEL	Set to channel 1.	CH1
RESPONSE	Select the receiving section input port.	MEAS, TEST PORT CONNECTION A(P1-P2) MEAS, S21[A] TRANS FWD (P1→P2) MEAS, SUB MEAS (ON)
	Set the log magnitude format	FORMAT, LOGMAG
	Set to 5/DIV	SCALE, 5/DIV
	Select the receiving section input port.	MEAS, S12[A] TRANS REV (P1←P2)
STIMULUS	Set the center frequency to 1.48GHz. Set the span frequency to 500MHz.	CENTER, 1, ., 4, 8, GHz SPAN, 5, 0, 0, MHz

- ③ Perform the calibration (TRIPLEX CAL).  
(see section 4.2 Calibration)
- ④ The screen when TEST PORT CONNECTION A(P1-P2) is executed is displayed as shown in Figure 4-11.  
CH1 shows S21 measurement data and CH3 (SUB MEAS) shows S12 measurement data.

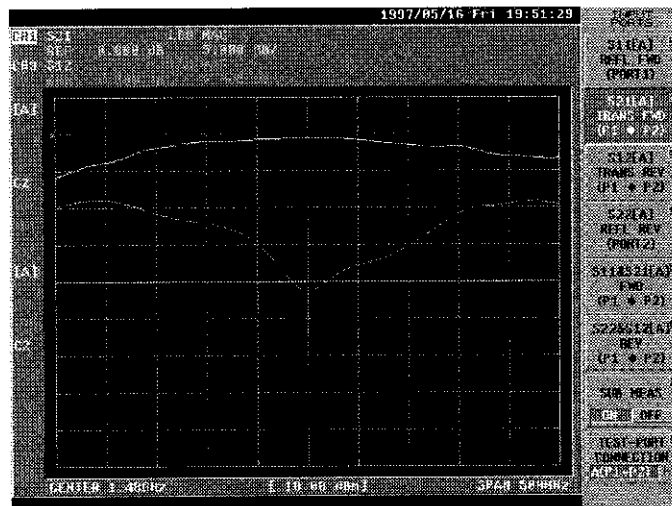

Figure 4-11 Transmission Characteristics between TEST PORT1 and TEST PORT2

4.3 Measurement Examples

- ⑤ To measure transmission characteristics between TEST PORT1 and TEST PORT3, set the network analyzer as shown below.

Block name	Setting contents	Key operation
ACTIVE CHANNEL	Set to channel 1.	CH1
RESPONSE	Select the receiving section input port.	MEAS, TEST PORT CONNECTION B(P1-P3) MEAS, S31[B] TRANS FWD (P1→P3) MEAS, SUB MEAS (ON)
	Set the log magnitude format	FORMAT, LOGMAG
	Set the scale to 5/DIV.	SCALE, 5/DIV
	Select the receiving section input port.	MEAS, S13[B] TRANS REV (P1←P3)

- ⑥ TEST PORT CONNECTION B(P1-P3) is displayed as shown in Figure 4-12. The CH1 shows S31 measurement data and the CH3 (SUB MEAS) shows S13 measurement data.

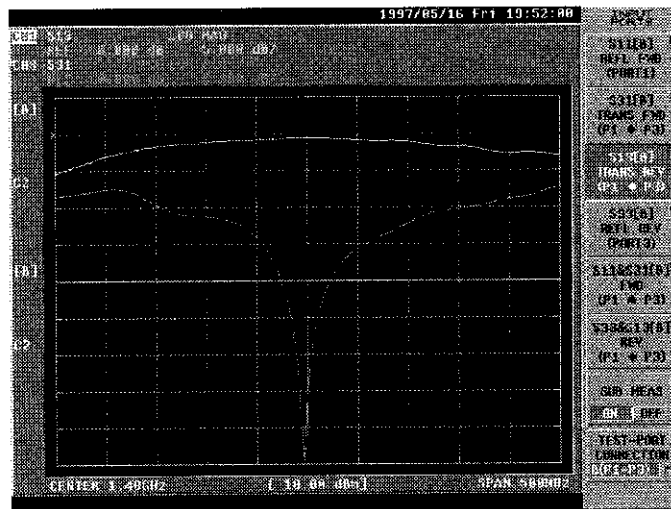

Figure 4-12 Transmission Characteristics between TEST PORT1 and TEST PORT3



- ⑦ To measure transmission characteristics between TEST PORT2 and TEST PORT3, set the network analyzer as shown below.

Block name	Setting contents	Key operation
ACTIVE CHANNEL	Set to channel 1.	CH1
RESPONSE	Select the receiving section input port.	MEAS, TEST PORT CONNECTION C(P2-P3) MEAS, S32[C] TRANS FWD (P2→P3) MEAS, SUB MEAS (ON)
	Set the log magnitude format	FORMAT, LOGMAG
	Set the scale to 5/DIV.	SCALE, 5/DIV
	Select the receiving section input port.	MEAS, S23[C] TRANS REV (P2←P3)

- ⑧ TEST PORT CONNECTION C(P2-P3) is displayed as shown in Figure 4-13. CH1 shows S32 measurement data and CH3 (SUB MEAS) shows S23 measurement data.

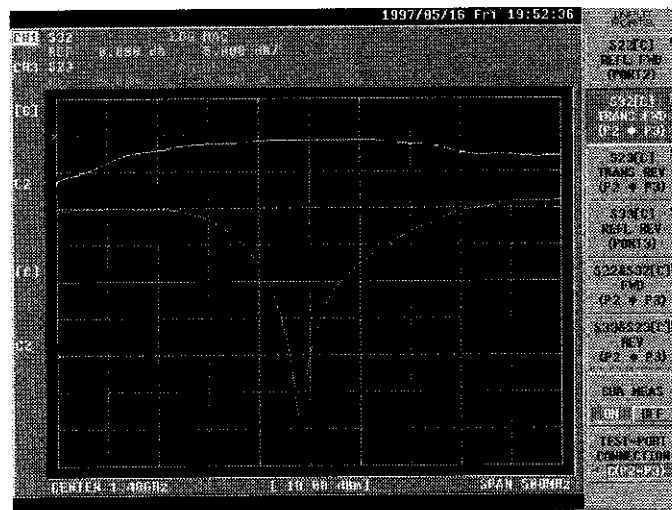

Figure 4-13 Transmission Characteristics between TEST PORT2 and TEST PORT3



## 5 OPERATION DESCRIPTION

### 5.1 Operation of R3965A/B

(1). Reflection characteristics

- ① When TEST-PORT CONNECTION [A(P1-P2)],S11[A] is set:

The signal from <INPUT> is passed through J0 and J2 of the SW4, and the IN and TEST of the Directional Bridge 2, and then output to <TEST PORT1>.

Reflected components from <TEST PORT1> are passed through TEST and OUT of Directional Bridge 2, and J2 and J0 of the SW 2, and then output to <A PORT>.

- ② When TEST-PORT CONNECTION [A(P1-P2)],S22[A] is set:

The signal from <INPUT> is passed through J0 and J1 of the SW4, J0 and J1 of the SW5, and the IN and TEST of the Directional Bridge 3, and then output to <TEST PORT2>.

Reflected components from <TEST PORT2> are passed through TEST and OUT of Directional Bridge 3, and J0 and J1 of SW 3, the J1 and J0 of the SW1, and then output to <B PORT>.

- ③ When TEST-PORT CONNECTION [B(P1-P3)],S11[B] is set:

The input signal and reflected components are passed through in the same way as case ① above .

- ④ When TEST-PORT CONNECTION [B(P1-P3)],S33[B] is set:

The signal from the <INPUT> is passed through J0 and J1 of the SW4, and the J0 and J2 of the SW5, to the IN and TEST of Directional Bridge 1, and then output to <TEST PORT3>.

Reflected components from <TEST PORT 3> are passed through TEST and OUT of the Directional Bridge 1, to the J2 and J0 of the SW 1, and then output to the <B PORT>.

- ⑤ When TEST-PORT CONNECTION [C(P2-P3)],S22[C] is set:

The signal from <INPUT> is passed through J0 and J1 of the SW4, and J0 and J1 of the SW 5, to the IN and TEST of the Directional Bridge 3, and then output to the <TEST PORT2>.

Reflected components from <TEST PORT2> are passed through TEST and OUT of the Directional Bridge 3, the J0 and J2 of the SW 3, and the J1 and J0 of the SW2, and then output to the <A PORT>.

- ⑥ When TEST-PORT CONNECTION [C(P2-P3)], S33[C] is set:

The input signal and reflected components are passed through in the same way as case ④ above.

- ⑦ The network analyzer compares and measures the <INPUT> signal to the <A PORT> signal or <B PORT> signal, and displays the results.

## 5.1 Operation of R3965A/B

### (2) Transmission characteristics

① When TEST-PORT CONNECTION [A(P1-P2)],S11[A] is set:

The signal from the <INPUT> is passed through J0 to J2 of SW4, and the IN and TEST of the Directional Bridge 2, and output to <TEST PORT1>. Then, the signal is passed through the device between <TEST PORT1> and <TEST PORT2> and input into <TEST PORT2>.

The signal input into <TEST PORT2> is passed through TEST and OUT of Directional Bridge 3, J0 and J1 of SW3, J1 and J0 of SW1, and then output to <B PORT>.

② When TEST-PORT CONNECTION [A(P1-P2)],S12[A] is set:

The signal from the <INPUT> is passed through J0 and J1 of SW4, J0 and J1 of SW5, and the IN and TEST of Directional Bridge 3, and output to <TEST PORT2>. Then, the signal is passed through the device between <TEST PORT2> and <TEST PORT1> and input into <TEST PORT1>.

The signal input into <TEST PORT1> is passed through TEST and OUT of Directional Bridge 2, the J2 and J0 of SW2, and output to <A PORT>.

③ When TEST-PORT CONNECTION [B(P1-P3)],S31[B] is set:

The signal from the <INPUT> is passed through J0 and J2 of the SW4, the IN and TEST of Directional Bridge 2, and output to <TEST PORT1>. Then, the signal is passed through the device between <TEST PORT1> and <TEST PORT3> and input into <TEST PORT3>.

The signal input into <TEST PORT3> is passed through TEST and OUT of Directional Bridge 1, J2 and J0 of the SW1, and output to the <B PORT>.

④ When TEST-PORT CONNECTION [B(P1-P3)],S13[B] is set:

The signal from <INPUT> is passed through J0 and J1 of SW4, J0 and J2 of SW5, the IN and TEST of Directional Bridge 1, and output to <TEST PORT3>. Then, the signal is passed through the device between <TEST PORT3> and <TEST PORT1> and input into <TEST PORT1>.

The signal input into <TEST PORT1> is passed through TEST and OUT of Directional Bridge 2, J2 and J0 of SW2, and output to <A PORT>.

⑤ When TEST-PORT CONNECTION [C(P2-P3)],S32[C] is set:

The signal from <INPUT> is passed through J0 and J1 of the SW4, J0 and J1 of SW5, the IN and TEST of Directional Bridge 3, and output to <TEST PORT2>. Then, the signal is passed through the device between <TEST PORT2> and <TEST PORT3> and input to <TEST PORT3>.

The signal input into <TEST PORT3> is passed through between the TEST and OUT of Directional Bridge 1, J2 and J0 of SW1, and output to <B PORT>.

- ⑥ When TEST-PORT CONNECTION [C(P2-P3)],S23[C] is set:  
The signal from <INPUT> is passed through J0 and J1 of SW4, J0 and J2 of SW5, the IN and TEST of Directional Bridge 1, and output to <TEST PORT3>. Then, the signal is passed through the device between <TEST PORT3> and <TEST PORT2> and input to <TEST PORT2>.  
The signal input into <TEST PORT2> is passed through TEST and OUT of Directional Bridge 3, J0 and J2 of SW3, J1 and J0 of SW2, and output to <A PORT>.
- ⑦ The network analyzer compares and measures the <INPUT> signal to the <A PORT> signal or <B PORT> signal, and displays the results.

5.1 Operation of R3965A/B

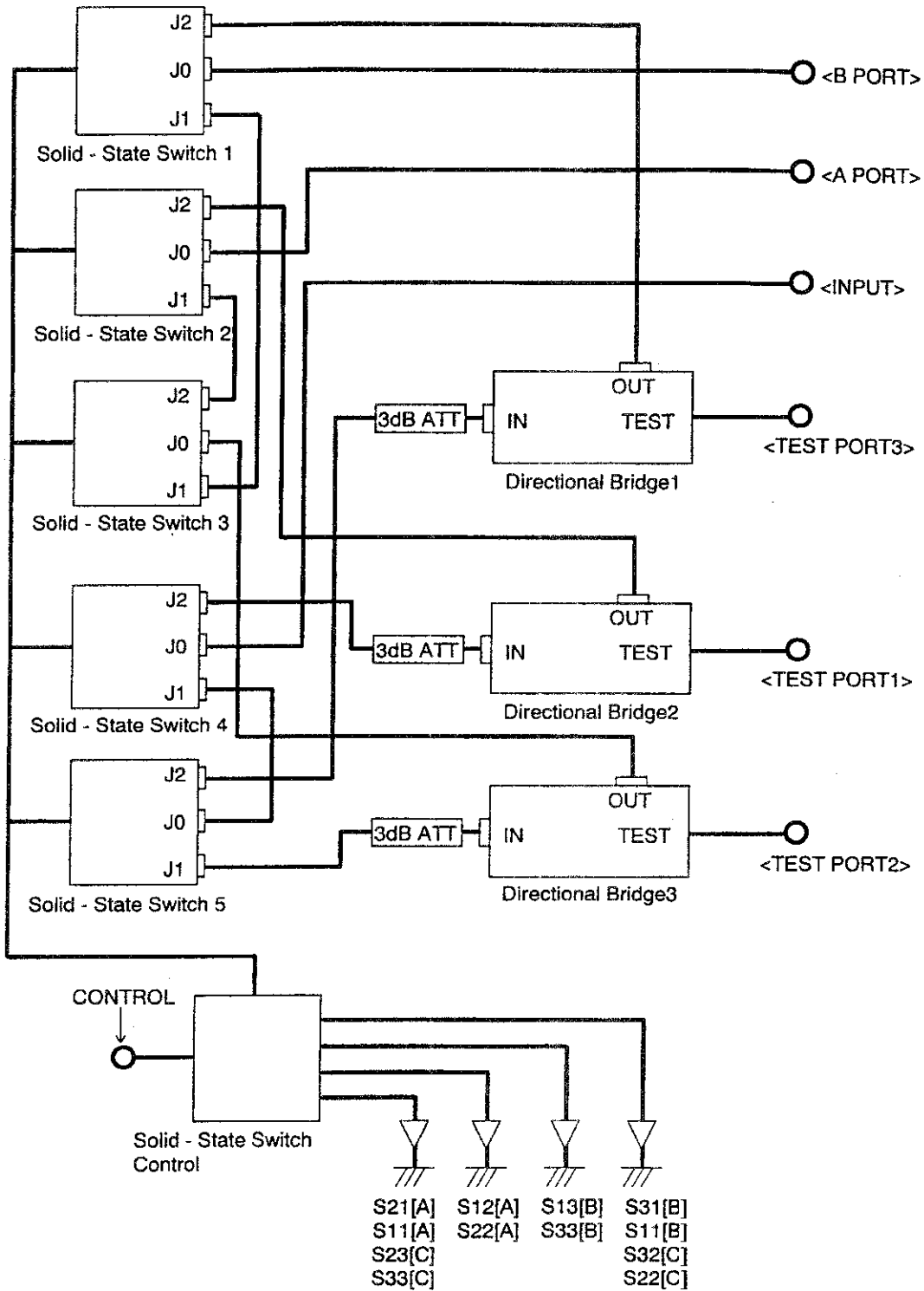

Figure 5-1 R3965A/B Operation Block Diagram

## 5.2 Operation of R3966A/B

### (1) Reflection characteristics

① When TEST-PORT CONNECTION [A(P1-P2)], S11[A] is set:

The signal is input from PORT1. This signal is passed through J0 and J1 of SW2 and output to <TEST PORT1>.

Reflected components from <TEST PORT1> are passed through J2 and J0 of SW2 and output to the <PORT1>.

② When TEST-PORT CONNECTION [A(P1-P2)], S22[A] is set:

The signal is input from PORT2. This signal is passed through J0 and J1 of SW1, J1 and J0 of SW3, and output to <TEST PORT2>.

Reflected components from <TEST PORT2> are passed through J0 and J1 of SW3, J1 and J0 of SW1, and output to <PORT2>.

③ When TEST-PORT CONNECTION [B(P1-P3)], S11[B] is set:

The input signal and reflected components are passed through in the same way as the case ① above.

④ When TEST-PORT CONNECTION [B(P1-P3)], S33[B] is set:

The signal is input from PORT2. This signal is passed through J0 and J2 of SW1 and output to <TEST PORT3>.

Reflected components from <TEST PORT3> are passed through J2 and J0 of SW1 and output to <PORT2>.

⑤ When TEST-PORT CONNECTION [C(P2-P3)], S22[C] is set:

The signal is input from PORT1. This signal is passed through J0 and J1 of SW2, J2 and J0 of SW3, and output to <TEST PORT2>.

Reflected components from <TEST PORT2> are passed through J0 and J2 of SW3, J1 and J0 of SW2, and output to <PORT1>.

⑥ When TEST-PORT CONNECTION [C(P2-P3)], S33[C] is set:

The input signal and reflected components are passed through in the same way as case ④ above.

5.2 Operation of R3966A/B

(2) Transmission characteristics

- ① When TEST-PORT CONNECTION [A(P1-P2)], S21[A] is set:

The signal is input from PORT1. This signal is passed through J0 and J2 of SW2 and output to <TEST PORT1>. Then, the signal is passed through the device between <TEST PORT1> and <TEST PORT2> and input into <TEST PORT2>. The signal input into <TEST PORT2> is passed through between J0 and J1 of SW3, J1 and J0 of SW1, and output to <PORT2>.

- ② When TEST-PORT CONNECTION [A(P1-P2)], S12[A] is set:

The signal is input from PORT2. This signal is passed through J0 and J1 of the SW1, the J1 to J0 of the SW3, and output to the <TEST PORT2>. Then, the signal is passed through the device between <TEST PORT2> and <TEST PORT1> and input into <TEST PORT1>. The signal input into <TEST PORT1> is passed through J2 and J0 of SW2, and output to <PORT1>.

- ③ When TEST-PORT CONNECTION [B(P1-P3)], S31[B] is set:

The signal is input from PORT1. This signal is passed through J0 and J2 of SW2 and output to <TEST PORT1>. Then, the signal is passed through the device between <TEST PORT1> and <TEST PORT3> and input into <TEST PORT3>. The signal input into <TEST PORT3> is passed through J2 and J0 of SW1, and output to <PORT2>.

- ④ When TEST-PORT CONNECTION [B(P1-P3)], S13[B] is set:

The signal is input from PORT2. This signal is passed through J0 and J2 of SW1 and output to <TEST PORT3>. Then, the signal is passed through the device between <TEST PORT3> and <TEST PORT1> and input into <TEST PORT1>. The signal input into <TEST PORT1> is passed through J2 and J0 of SW2, and output to <PORT1>.

- ⑤ When TEST-PORT CONNECTION [C(P2-P3)], S32[C] is set:

The signal is input from PORT1. This signal is passed through J0 and J1 of SW2, the J2 and J0 of SW3, and output to <TEST PORT2>. Then, the signal is passed through the device between <TEST PORT2> and <TEST PORT3> and input into <TEST PORT3>. The signal input into <TEST PORT3> is passed through J2 and J0 of SW1 and output to <PORT2>.

- ⑥ When TEST-PORT CONNECTION [C(P2-P3)], S23[C] is set:

The signal is input from PORT2. This signal is passed through between J0 and J2 of SW1 and output to <TEST PORT3>. Then, the signal is passed through the device between <TEST PORT3> and <TEST PORT2> and input into <TEST PORT2>. The signal input into <TEST PORT2> is passed through between the J0 and J2 of the SW3, J1 and J0 of SW1, and output to <PORT1>.



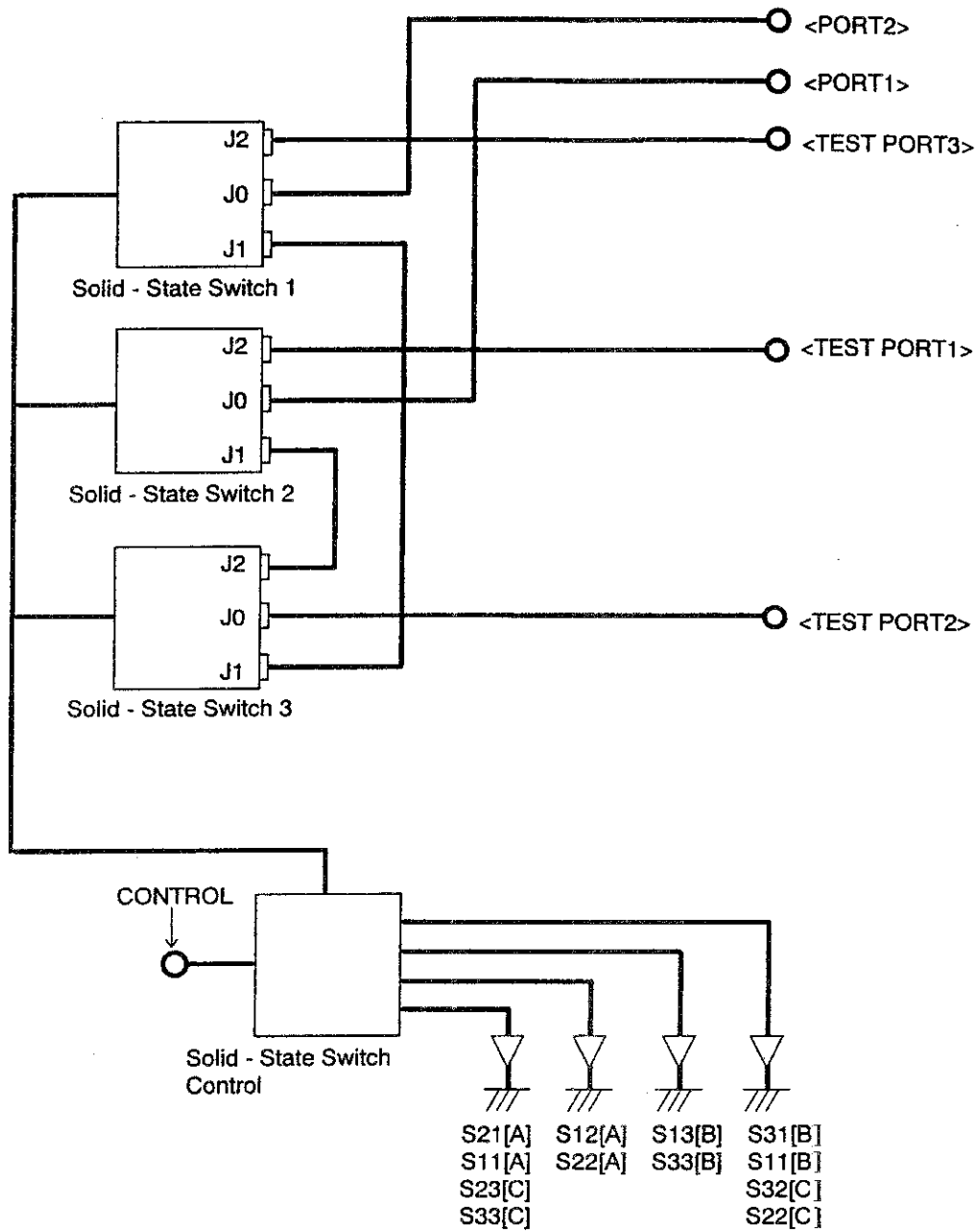

Figure 5-2 R3966A/B Operation Block Diagram



## 6 PERFORMANCE TESTS

### 6.1 Preparations for the Tests

(1) Warm-up

Warm up the instrument at least 60 minutes before starting the performance tests.

Use the **PRESET** key to initialize the instrument before the start of every test item.

(2) Instrument Preparation

Prepare the following equipment for the tests listed as indicated on the chart below:

Test	Equipment	Remarks
Directivity	Calibration kit	For R3965A/B only See Section 6.2
Test port load match	Calibration kit RF cable (TEST CABLE)	For R3965A/B only See Section 6.3
Frequency characteristics	Calibration kit RF cable (TEST CABLE)	For R3965A/B only See Section 6.4
Insertion loss	RF cable (TEST CABLE) Conversion adapter	See Section 6.5
Isolation	Calibration kit RF cable (TEST CABLE) Conversion adapter	See Section 6.6

Calibration kit: Model 9617A3 (18GHz, N connector) for the R3965A and R3966A.  
Calibration kit: Model 9617F3 (18GHz, 3.5mm connector) for the R3965B and R3966B.

RF cable: Use cables with good frequency characteristics (approx. 0.25dB/GHz).

Use N-connector cables for the R3965A and R3966A.

Use SMA-connector cables for the R3965B and R3966B.

Conversion adapter: HRM-554S

For the R3965B and R3966B, use adapters which convert the network analyzer ports to SMA.

(3) Take account of the RF cables\* frequency characteristics when performing a in the performance test.

(4) General precautions

- Use 90VAC to 250VAC and 48Hz to 66Hz input power.
- Connect the power cable only after turning the POWER switch OFF.
- Perform tests under the following environmental conditions only.

Test temperature range: +25°C ±5°C

Relative humidity: 80% or lower

Places free from dust, vibration, noise and so on.

6.2 Directivity (R3965A/B only)

6.2 Directivity (R3965A/B only)

- ① Connect the instrument to the network analyzer.

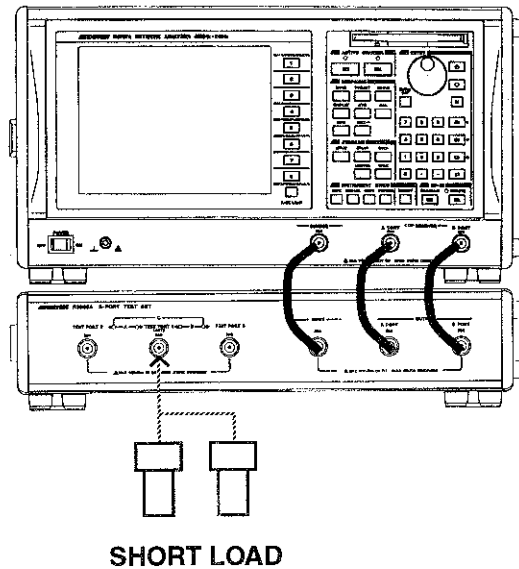

- ② Perform NORMALIZE (SHORT) for TEST PORT1
  - ②-1 **CH1, MEAS, TEST-PORT CONNECTION [A(P1-P2)], S11[A] REFL FWD(PORT1)**
  - ②-2 Connect the short standard to TEST PORT1.  
**CAL, NORMALIZE(SHORT)**
- ③ Connect the load standard to TEST PORT1 and read the directivity value from the trace data using the marker.

<b>VERIFY</b>	Directivity of TEST PORT1	40MHz to 2.6GHz	-30dB typical
		2.6GHz to 3.8GHz	-29dB typical
		3.8GHz to 8.0GHz	-25dB typical

- ④ Perform NORMALIZE (SHORT) for TEST PORT2.
  - ④-1 **CH1, MEAS, TEST-PORT CONNECTION [A(P1-P2)], S22[A] REFL REV(PORT2)**
  - ④-2 Connect the short standard to TEST PORT2.
  - ④-3 **CAL, NORMALIZE(SHORT)**

- ⑤ Connect the load standard to TEST PORT2 and read the directivity value from the trace data using the marker.

VERIFY	Directivity of TEST PORT2	40MHz to 2.6GHz	-30dB typical
		2.6GHz to 3.8GHz	-29dB typical
		3.8GHz to 8.0GHz	-25dB typical

- ⑥ Perform NORMALIZE (SHORT) for TEST PORT3.

⑥-1 **CH1, MEAS, TEST-PORT CONNECTION[B(P1-P3)], S33[B] REFL REV(PORT3)**

⑥-2 Connect the short standard to TEST PORT3.

⑥-3 **CAL, NORMALIZE(SHORT)**

- ⑦ Connect the load standard to TEST PORT3 and read the directivity value from the trace data using the marker.

VERIFY	Directivity of TEST PORT3	40MHz to 2.6GHz	-30dB typical
		2.6GHz to 3.8GHz	-29dB typical
		3.8GHz to 8.0GHz	-25dB typical

6.3 Test Port Load Match (R3965A/B only)

6.3 Test Port Load Match (R3965A/B only)

- ① Connect the instrument to the network analyzer.
- ② Connect the test cable to TEST PORT2 and perform a 1PORT FULL CAL.

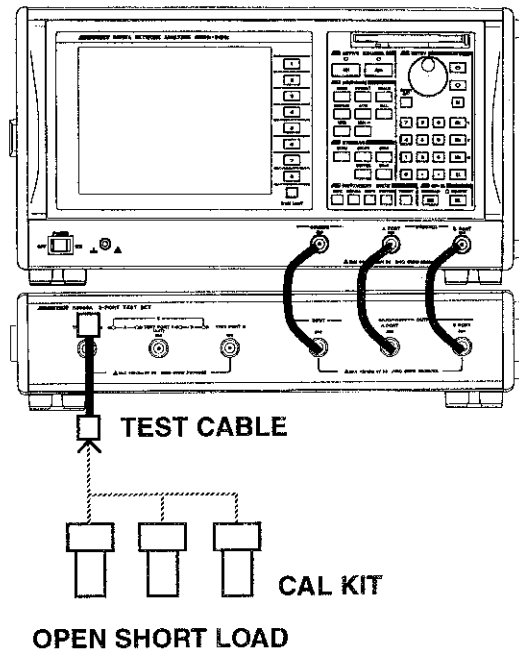

- ②-1 **CH1, MEAS, TEST-PORT CONNECTION[A(P1-P2)], S22[A] REFL REV(PORT2)**
- ②-2 **CAL, CAL MENUS, 1PORT FULL CAL**
- ②-3 Connect the open standard to the test cable and press the **OPEN** key.
- ②-4 Connect the short standard to the test cable and press the **SHORT** key
- ②-5 Connect the load standard to the test cable and press the **LOAD** key.
- ②-6 Press the **DONE 1-PORT** key.

- ③ Connect the test cable to TEST PORT1 and read the test port load match value from the trace data using the marker.

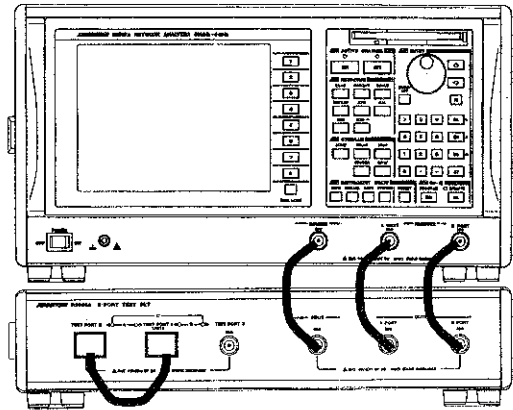

<b>VERIFY</b>	Load match of TEST PORT1	40MHz to 2.6GHz	-25dB typical
		2.6GHz to 3.8GHz	-20dB typical
		3.8GHz to 8.0GHz	-14dB typical

- ④ Connect the test cable to TEST PORT1 and perform a 1PORT FULL CAL.

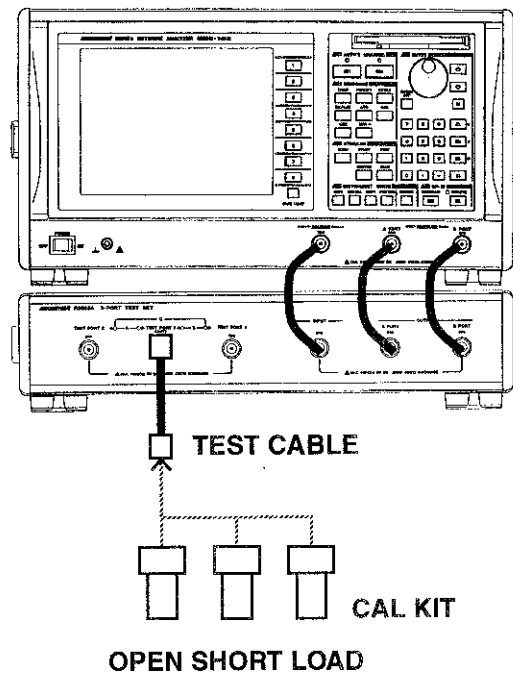

6.3 Test Port Load Match (R3965A/B only)

- ④-1 **CH1, MEAS, TEST-PORT CONNECTION [A(P1-P2)], S11[A] REFL FWD(PORT1)**
- ④-2 **CAL, CAL MENUS, 1PORT FULL CAL**
- ④-3 Connect the open standard to the test cable and press the **OPEN** key.
- ④-4 Connect the short standard to the test cable and press the **SHORT** key.
- ④-5 Connect the load standard to the test cable and press the **LOAD** key.
- ④-6 Press the **DONE 1-PORT** key.
- ⑤ Connect the test cable to TEST PORT2 and read the test port load match value from the trace data using the marker.

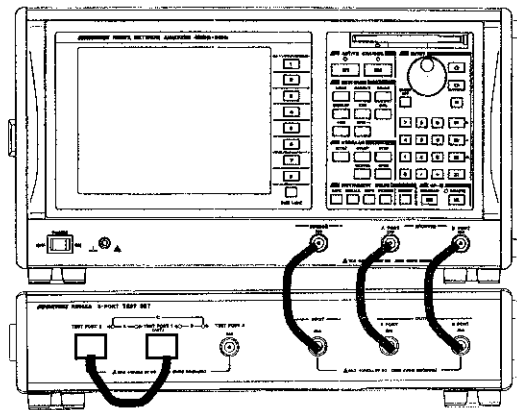

<b>VERIFY</b>	Load match of TEST PORT2	40MHz to 2.6GHz	-25dB typical
		2.6GHz to 3.8GHz	-20dB typical
		3.8GHz to 8.0GHz	-14dB typical



- ⑥ Connect the test cable to TEST PORT1 and perform a 1PORT FULL CAL.

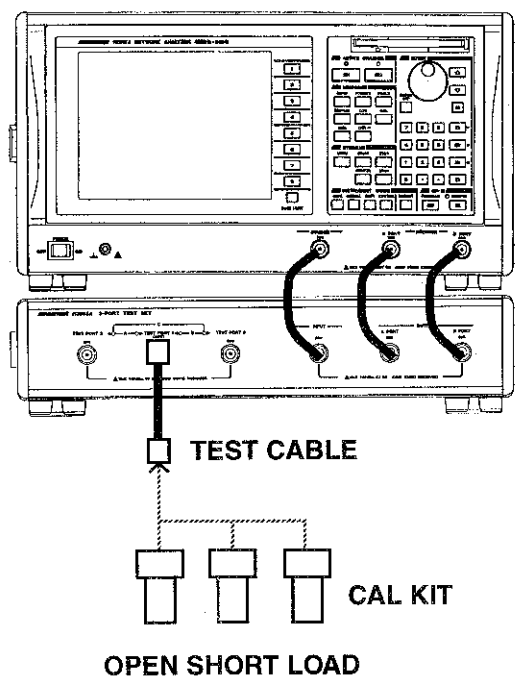

- ⑥-1 **CH1, MEAS, TEST-PORT CONNECTION [B(P1-P3)], S11[B] REFL FWD(PORT1)**
- ⑥-2 **CAL, CAL MENUS, 1PORT FULL CAL**
- ⑥-3 Connect the open standard to the test cable and press the **OPEN** key.
- ⑥-4 Connect the short standard to the test cable and press the **SHORT** key.
- ⑥-5 Connect the load standard to the test cable and press the **LOAD** key.
- ⑥-6 Press the **DONE 1-PORT** key.

6.3 Test Port Load Match (R3965A/B only)

- ⑦ Connect the test cable to the TEST PORT3 and read the test port load match value from the trace data using the marker.

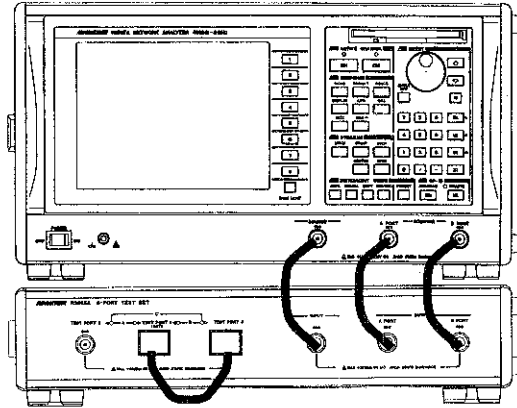

VERIFY

Load match of TEST PORT3

40MHz to 2.6GHz -25dB typical  
2.6GHz to 3.8GHz -20dB typical  
3.8GHz to 8.0GHz -14dB typical

## 6.4 Frequency Characteristics (R3965A/B only)

### 6.4.1 Transmission Magnitude (R3965A/B only)

- ① Connect the instrument to the network analyzer.
- ② Connect the test cable between TEST PORT1 and TEST PORT2.

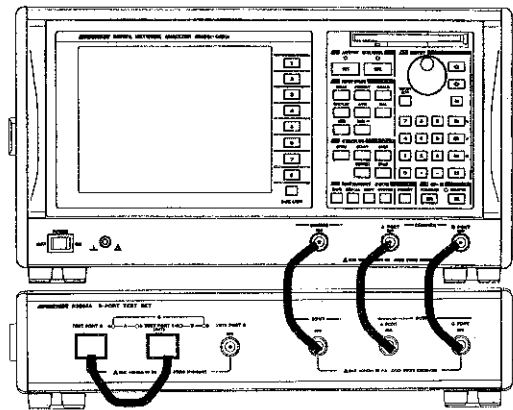

- ②-1 **MEAS, TEST-PORT CONNECTION [A(P1-P2)], S21[A] TRNS FWD(P1→P2)**
- ②-2 **SCALE, AUTO SCALE**
- ③ Read the frequency characteristics from the trace data using the marker.
  - ③-1 **MKR→, MKR SEARCH [ ], RIPPLE, MAX-MIN**
  - ③-2 The transmission magnitude from TEST PORT1 to TEST PORT2 is displayed as a marker value.

**VERIFY** Transmission magnitude between TEST PORT1 and TEST PORT2  
4dB p-p typical

- ④ Set the network analyzer to measure frequency characteristics from TEST PORT2 to TEST PORT1.
  - ④-1 **MEAS, TEST-PORT CONNECTION [A(P1-P2)], S12[A] TRNS REV(P1←P2)**
  - ④-2 **SCALE, AUTO SCALE**

6.4 Frequency Characteristics (R3965A/B only)

⑤ Read the frequency characteristics from the trace data using the marker.

⑤-1 **MKR→, MKR SEARCH [ ], RIPPLE, MAX-MIN**

⑤-2 The transmission magnitude of TEST PORT2 to TEST PORT1 is displayed as a marker value.

**VERIFY** Transmission magnitude from TEST PORT2 to TEST PORT1  
4dB p-p typical

⑥ Connect the test cable between TEST PORT3 and TEST PORT1.

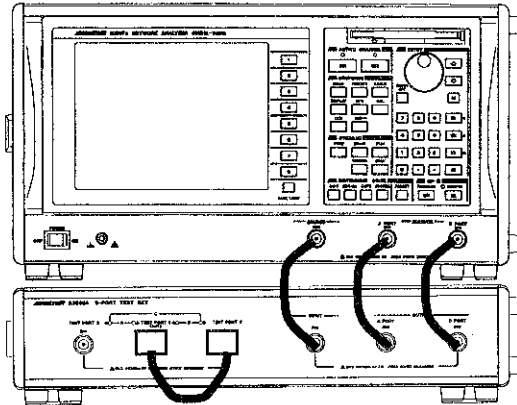

⑥-1 **CH1, MEAS, TEST-PORT CONNECTION [B(P1-P3)], S31[B] TRNS FWD(P1→P3)**

⑥-2 **SCALE, AUTO SCALE**

⑦ Read the frequency characteristics from the trace data using the marker.

⑦-1 **MKR→, MKR SEARCH [ ], RIPPLE, MAX-MIN**

⑦-2 The transmission magnitude of TEST PORT1 to TEST PORT3 is displayed as a marker value.

**VERIFY** Transmission magnitude of TEST PORT1 to TEST PORT 3  
4dB p-p typical

⑧ Set the network analyzer to measure the frequency characteristics from TEST PORT3 to TEST PORT1.

⑧-1 **MEAS, TEST-PORT CONNECTION [B(P1-P3)], S13[B] TRNS REV(P1←P3)**

⑧-2 **SCALE, AUTO SCALE**

⑨ Read the frequency characteristics from the trace data using the marker.

⑨-1 **MKR→, MKR SEARCH [ ], RIPPLE, MAX-MIN**

⑨-2 The transmission magnitude from TEST PORT3 to TEST PORT1 is displayed as a marker value.

**VERIFY** Transmission magnitude from TEST PORT3 to TEST PORT1  
4dB p-p typical

⑩ Connect the test cable between TEST PORT2 and TEST PORT3.

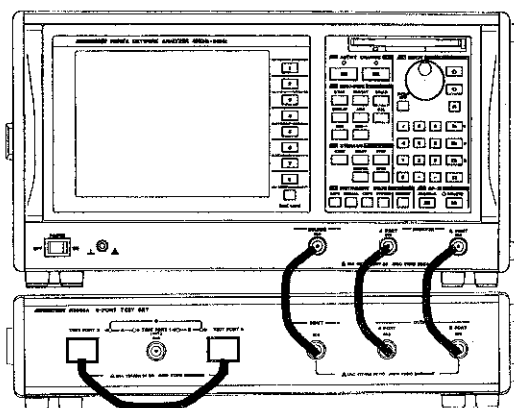

⑩-1 **CH1, MEAS, TEST-PORT CONNECTION [C(P2-P3)], S32[C] TRNS FWD(P2→P3)**

⑩-2 **SCALE, AUTO SCALE**

⑪ Read the frequency characteristics from the trace data using the marker.

⑪-1 **MKR→, MKR SEARCH [ ], RIPPLE, MAX-MIN**

⑪-2 The transmission magnitude from TEST PORT2 to TEST PORT3 is displayed as a marker value.

**VERIFY** Transmission magnitude from TEST PORT2 to TEST PORT3  
4dB p-p typical

⑫ Set the network analyzer to measure the frequency characteristics from TEST PORT3 to TEST PORT2.

⑫-1 **MEAS, TEST-PORT CONNECTION [C(P2-P3)], S23[C] TRNS REV(P2←P3)**

⑫-2 **SCALE, AUTO SCALE**

6.4 Frequency Characteristics (R3965A/B only)

⑬ Read the frequency characteristics from the trace data using the marker.

⑬-1 **MKR→, MKR SEARCH [ ], RIPPLE, MAX-MIN**

⑬-2 The transmission magnitude from TEST PORT3 to TEST PORT2 is displayed as a marker value.

**VERIFY** Transmission magnitude from TEST PORT3 to TEST PORT2  
4dB p-p typical

6.4.2 Reflection Magnitude (R3965A/B only)

① Connect the instrument to the network analyzer.

② Connect the short standard to TEST PORT1.

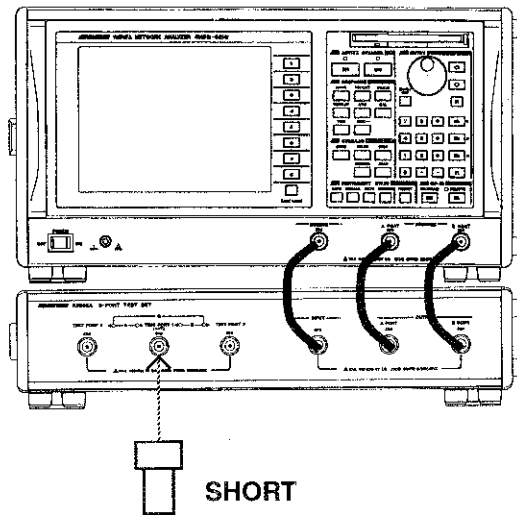

②-1 **CH1, MEAS, TEST-PORT CONNECTION[A(P1-P2)], S11[A] REFL FWD(PORT1)**

②-2 **SCALE, AUTO SCALE**

③ Read the frequency characteristics from the trace data using the marker.

③-1 **MKR→, MKR SEARCH [ ], RIPPLE, MAX-MIN**

③-2 The frequency characteristics of TEST PORT1 are displayed as a marker value.

**VERIFY** Frequency characteristics of the TEST PORT1  
6dB p-p typical

- ④ Connect the short standard to TEST PORT2.

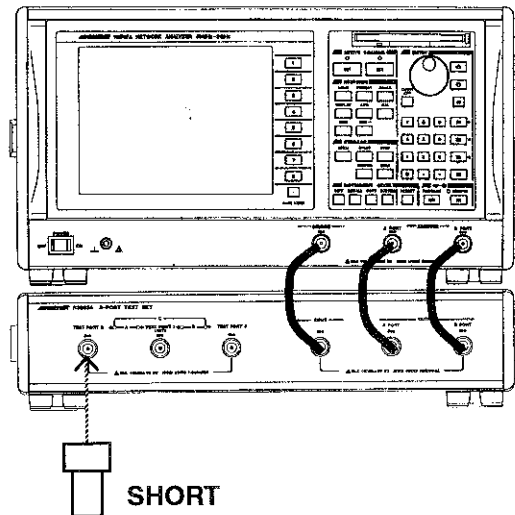

- ④-1 **CH1, MEAS, TEST-PORT CONNECTION[A(P1-P2)], S22[A] REFL REV(PORT2)**

- ④-2 **SCALE, AUTO SCALE**

- ⑤ Read the frequency characteristics from the trace data using the marker.

- ⑤-1 **MKR→, MKR SEARCH [ ], RIPPLE, MAX-MIN**

- ⑤-2 The frequency characteristics of TEST PORT2 are displayed as a marker value.

**VERIFY** Reflection magnitude of TEST PORT2 6dB p-p typical

- ⑥ Set TEST PORT2 to three-port mode and measure the reflection magnitude.

- ⑥-1 **CH1, MEAS, TEST-PORT CONNECTION [C(P2-P3)], S22[C] REFL FWD(PORT2)**

- ⑥-2 **SCALE, AUTO SCALE**

- ⑦ Read the frequency characteristics from the trace data using the marker.

- ⑦-1 **MKR→, MKR SEARCH [ ], RIPPLE, MAX-MIN**

- ⑦-2 The frequency characteristics of TEST PORT2 are displayed as a marker value.

**VERIFY** Reflection magnitude of TEST PORT3 in the three-port setting  
6dB p-p typical.

6.4 Frequency Characteristics (R3965A/B only)

- ⑧ Connect the short standard to the TEST PORT3.

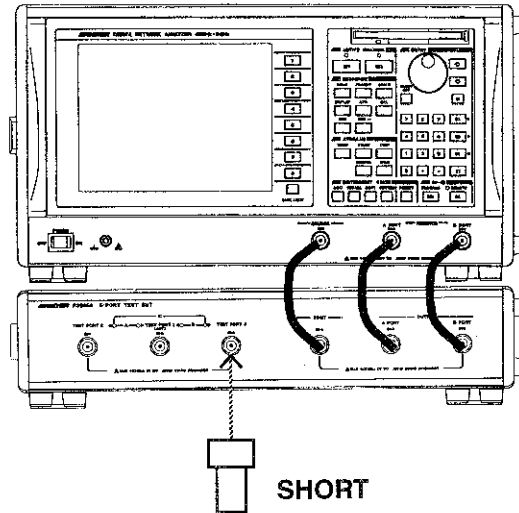

- ⑧-1 CH1, MEAS, TEST-PORT CONNECTION[B(P1-P3)], S33[B] REFL REV(PORT3)

- ⑧-2 SCALE, AUTO SCALE

- ⑨ Read the frequency characteristics from the trace data using the marker.

- ⑨-1 MKR→, MKR SEARCH [ ], RIPPLE, MAX-MIN

- ⑨-2 The frequency characteristics of TEST PORT3 are displayed as a marker value.

**VERIFY** Reflection magnitude of TEST PORT3 6dB p-p typical



## 6.5 Insertion Loss

### (1) R3965A/B

- ① Connect the instrument to the network analyzer.
- ② Change the cable connection as shown below.

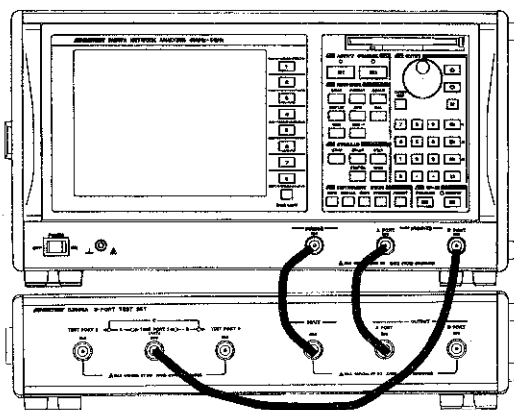

②-1 **CH1, MEAS, TEST-PORT CONNECTION[A(P1-P2)], S21[A] TRANS FWD(P1→P2)**

②-2 **SCALE, AUTO SCALE**

- ③ Read the insertion loss from INPUT to TEST PORT1 out of the trace data using the marker.

**VERIFY** Insertion loss from INPUT to TEST PORT1      -11dB typical

- ④ Change the cable connection as shown below.

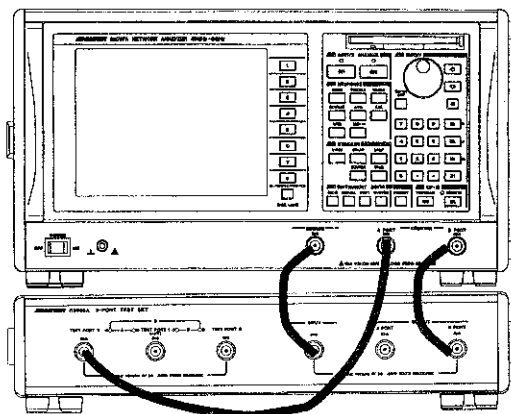

6.5 Insertion Loss

④-1 CH1, MEAS, TEST-PORT CONNECTION[A(P1-P2)], S12[A] TRNS REV(P1←P2)

④-2 SCALE, AUTO SCALE

⑤ Read the insertion loss from INPUT to TEST PORT2 out of the trace data using the marker.

**VERIFY** Insertion loss from INPUT to TEST PORT2 -14dB typical

⑥ Change the cable connection as shown below.

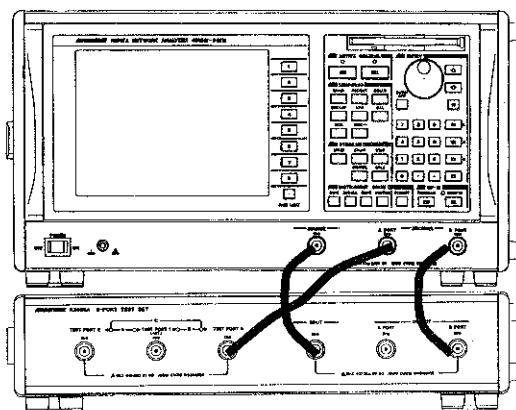

⑥-1 CH1, MEAS, TEST-PORT CONNECTION [B(P1-P3)], S13[B] TRNS REV(P1←P3)

⑥-2 SCALE, AUTO SCALE

⑦ Read the insertion loss from INPUT to TEST PORT3 out of the trace data using the marker.

**VERIFY** Insertion loss between INPUT and TEST PORT3 -14dB typical

⑧ Change the cable connection as shown below.

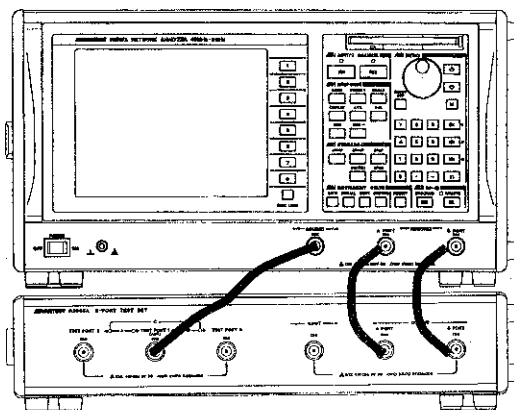

⑧-1 **CH1, MEAS, TEST-PORT CONNECTION [A(P1-P2)], S11[A] REFL FWD(PORT1)**

⑧-2 **SCALE, AUTO SCALE**

⑨ Read the insertion loss from TEST PORT1 to A PORT out of the trace data using the marker.

**VERIFY** Insertion loss from TEST PORT1 to A PORT -22dB typical

⑩ Change the cable connection as shown below.

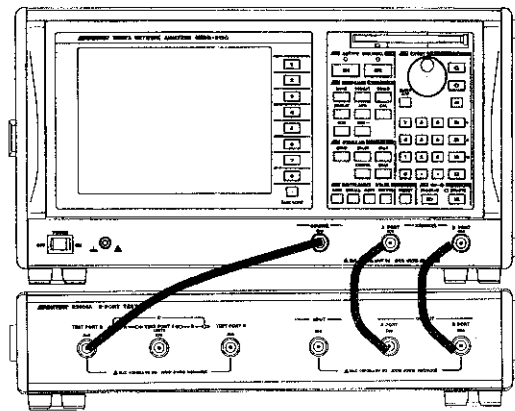

⑩-1 **CH1, MEAS, TEST-PORT CONNECTION[A(P1-P2)], S22[A] REFL REV(PORT2)**

⑩-2 **SCALE, AUTO SCALE**

⑪ Read the insertion loss from TEST PORT2 to B PORT out of the trace data using the marker.

**VERIFY** Insertion loss from TEST PORT2 to B PORT -25dB typical

⑫ Measure the insertion loss from TEST PORT2 to A PORT in the three-port setting.

⑫-1 **CH1, MEAS, TEST-PORT CONNECTION[C(P2-P3)], S22[C] REFL FWD(PORT2)**

⑫-2 **SCALE, AUTO SCALE**

⑬ Measure the insertion loss from TEST PORT2 to A PORT out of the trace data using the marker.

**VERIFY** Insertion loss from TEST PORT2 to A PORT -25dB typical

6.5 Insertion Loss

- ⑭ Change the cable connection as shown below.

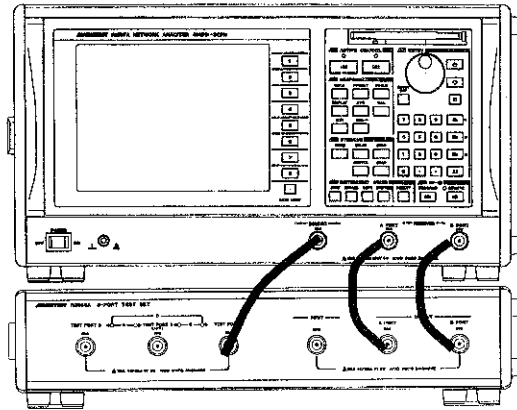

⑭-1 CH1, MEAS, TEST-PORT CONNECTION[B(P1-P3)], S33[B] REFL REV(PORT3)

⑭-2 SCALE, AUTO SCALE

- ⑮ Read the insertion loss from TEST PORT3 to B PORT out of the trace data using the marker.

**VERIFY** Insertion loss from TEST PORT3 to B PORT -22dB typical

(2) R3966A/B

- ① Connect the instrument to the network analyzer.
- ② Change the cable connection as shown below.

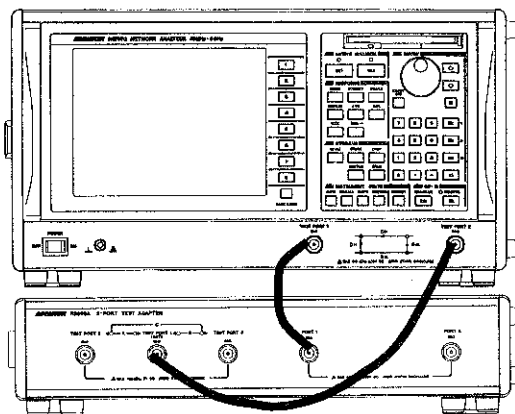

②-1 CH1, MEAS, TEST-PORT CONNECTION [A(P1-P2)], S21[A] TRNS FWD(P1→P2)

②-2 SCALE, AUTO SCALE

- ③ Read the insertion loss from PORT1 to TEST PORT1 out of the trace data using the marker.

**VERIFY** Insertion loss between from PORT1 to TEST PORT1      -4dB typical

- ④ Change the cable connection as shown below.

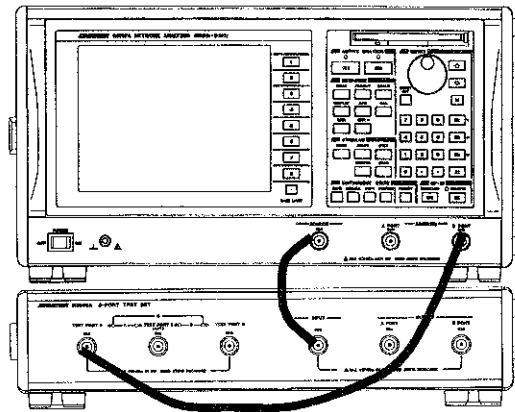

- ④-1 **CH1, MEAS, TEST-PORT CONNECTION [C(P2-P3)], S32[C] TRNS FWD(P2→P3)**

- ④-2 **SCALE, AUTO SCALE**

- ⑤ Read the insertion loss from PORT1 to TEST PORT2 out of the trace data using the marker.

**VERIFY** Insertion loss from PORT1 and to TEST PORT2      -6dB typical

- ⑥ Change the cable connection as shown below.

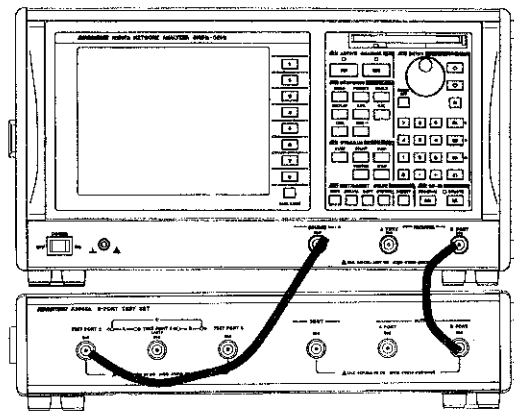

6.5 Insertion Loss

⑥-1 CH1, MEAS, TEST-PORT CONNECTION[A(P1-P2)], S12[A] TRNS REV(PORT2)

⑥-2 SCALE, AUTO SCALE

⑦ Read the insertion loss from PORT2 to TEST PORT2 out of the trace data using the marker.

**VERIFY** Insertion loss from PORT2 to TEST PORT2 -6dB typical

⑧ Change the cable connection as shown below.

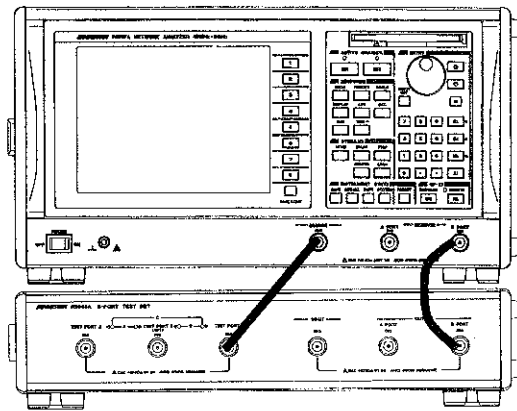

⑧-1 CH1, MEAS, TEST-PORT CONNECTION [B(P1-P3)], S13[B] TRNS REV(P1←P3)

⑧-2 SCALE, AUTO SCALE

⑨ Read the insertion loss from PORT2 to TEST PORT3 out of the trace data using the marker.

**VERIFY** Insertion loss from PORT2 to TEST PORT3 -4dB typical

## 6.6 Isolation

### (1) R3965A/B

- ① Connect the instrument to the network analyzer.
- ② Connect the test cable between TEST PORT1 and TEST PORT2.

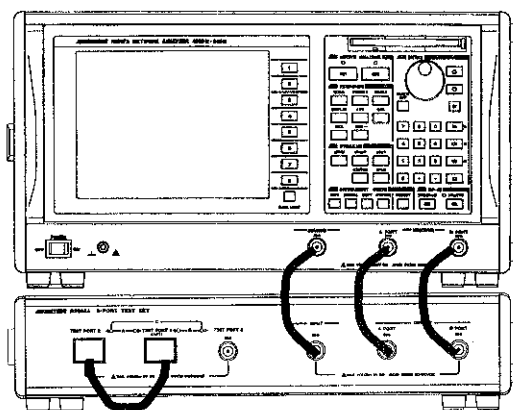

- ②-1 **MENU, POINTS, 1, 2, 0, 1, X1**
- ②-2 **CH1, MEAS, TEST-PORT CONNECTION[A(P1-P2)], S21[A] TRNS FWD(P1→P2)**
- ②-3 **SCALE, /DIV, 1, 0, X1, REF POS, 5, 0, X1, REF VALUE, -, 9, 0, X1**
- ②-4 **AVG, 1, 0, 0, X1**
- ②-5 **CAL, NORMLIZE (THRU)**
- ③ Disconnect the cable from the network analyzer B PORT and connect the Load standard to the B PORT.

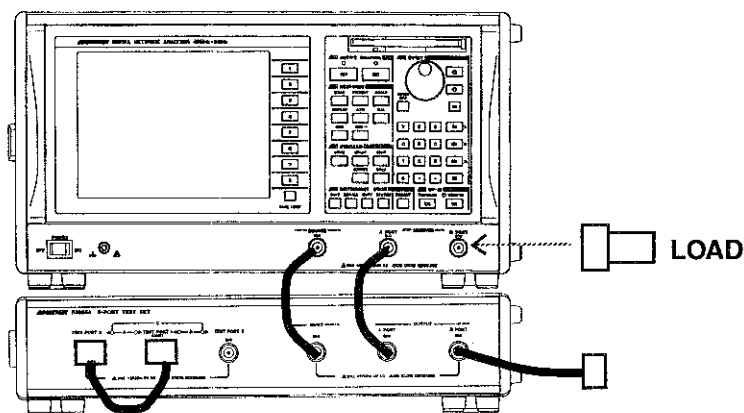

- ③-1 **AVG, AVG COUNT, 6, 4, X1, AVG STATE ON**

6.6 Isolation

- ④ An average count is displayed in the upper left of the screen.  
When the average count reaches 64, set the network analyzer as shown below.
- ④-1 **DISPLAY, DATA→MEMORY, DEFINE TRACE[ ], DATA\_MEMORY**
- ⑤ Connect the network analyzer B PORT to the instrument B PORT.  
Disconnect the test cable between TEST PORT1 and TEST PORT2 and connect the load standard to TEST PORT2.

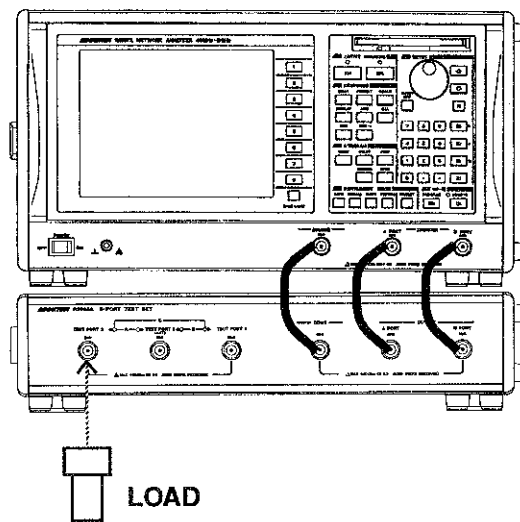

⑤-1 **AVG, AVG RESTART**

- ⑥ When the average count (shown in the upper left corner of the screen) reaches 64, read the isolation value using the marker.



Isolation from TEST PORT1 to TEST PORT2

40MHz to 2.6GHz	-85dB or less
2.6GHz to 3.8GHz	-80dB or less
3.8GHz to 5.0GHz	-65dB or less
5.0GHz to 8.0GHz	-55dB or less

Set the network analyzer as shown below after checking the above.

- ⑥-1 **AVG, AVG STATE OFF**
- ⑥-2 **DISPLAY, DEFINE TRACE [DATA-MEN], OFF**



- ⑦ Connect the test cable between TEST PORT1 and TEST PORT2.

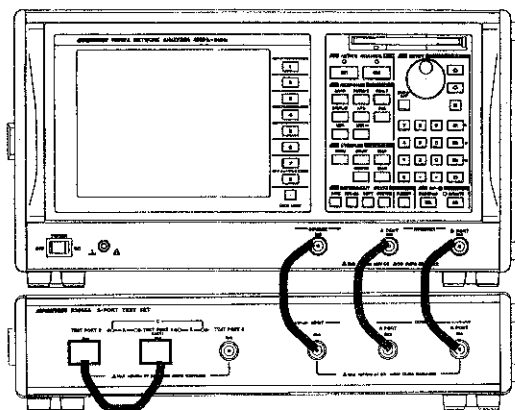

- ⑦-1 **CH1, MEAS, TEST-PORT CONNECTION [A(P1-P2)], S12[A] TRNS REV(P1←P2)**
- ⑦-2 **SCALE, /DIV, 1, 0, X1, REF POS, 5, 0, X1, REF VALUE, -, 9, 0, X1**
- ⑦-3 **CAL, NORMLIZE (THRU)**
- ⑧ Disconnect the cable connected to the network analyzer A PORT and connect the load standard to A PORT.

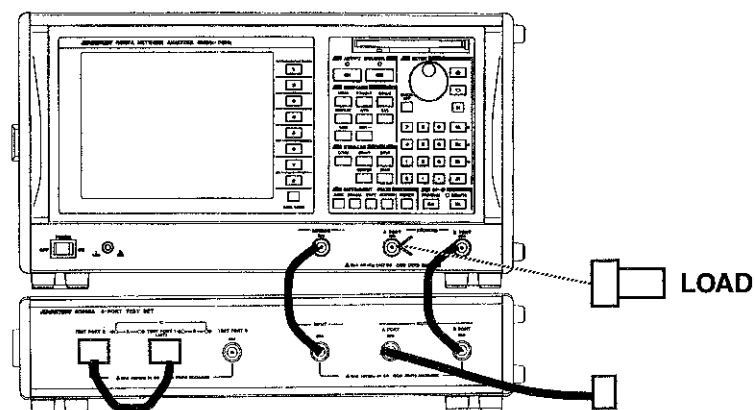

- ⑧-1 **AVG, AVG STATE ON**
- ⑨ The average count is displayed in the upper left of the screen.  
When the average count reaches 64, set the network analyzer as shown below.
- ⑨-1 **DISPLAY, DATA→MEMORY, DEFINE TRACE[ ], DATA→MEMORY**

6.6 Isolation

- ⑩ Connect the network analyzer A PORT to the instrument A PORT.  
Disconnect the cable between TEST PORT1 and TEST PORT2 and connect the load standard to TEST PORT1.

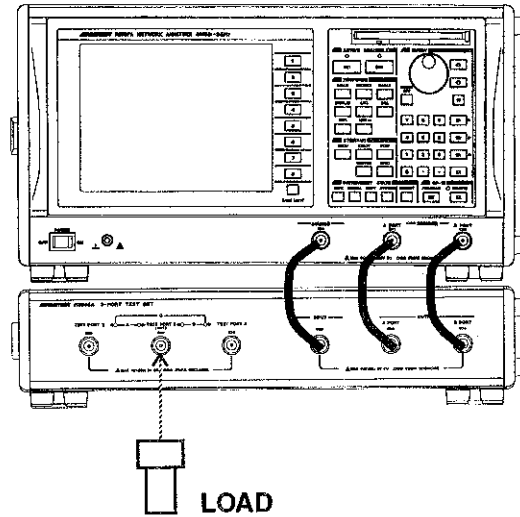

⑩-1 **AVG, AVG RESTART**

- ⑪ When the average count (shown in the upper left corner of the screen) reaches 64, read the isolation value using the marker.



Isolation from TEST PORT2 to TEST PORT1

40MHz to 2.6GHz	-85dB or less
2.6GHz to 3.8GHz	-80dB or less
3.8GHz to 5.0GHz	-65dB or less
5.0GHz to 8.0GHz	-55dB or less

Set the network analyzer as shown below after checking the above.

⑪-1 **AVG, AVG STATE OFF**

⑪-2 **DISPLAY, DEFINE TRACE[DATA-MEN], OFF**

- ⑫ Connect the test cable between TEST PORT1 and TEST PORT3.

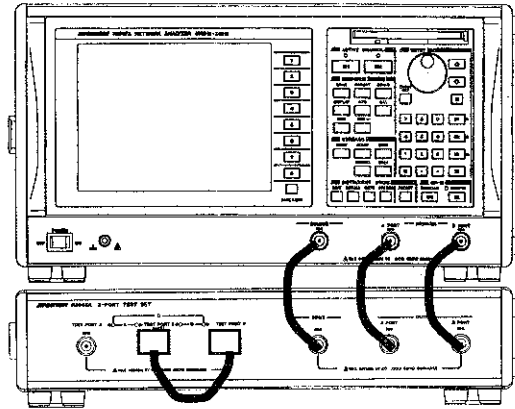

- ⑫-1 **CH1, MEAS, TEST-PORT CONNECTION[(B(P1-P3)], S31[B] TRNS FWD(P1←P3)**
- ⑫-2 **SCALE, /DIV, 1, 0, X1, REF POS, 5, 0, X1, REF VALUE, -, 9, 0, X1**
- ⑫-3 **CAL, NORMLIZE (THRU)**
- ⑬ Disconnect the cable connected to the network analyzer B PORT and connect the load standard to the B PORT.

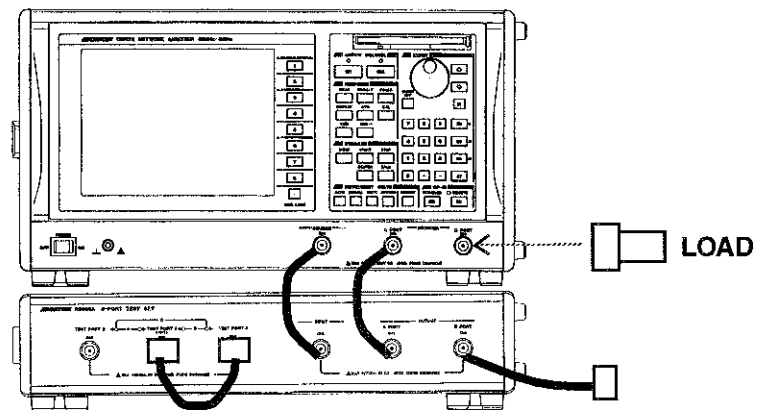

- ⑬-1 **AVG, AVG STATE ON**
- ⑭ The average count is displayed in the upper left of the screen.  
When the average count reaches 64, set the network analyzer as shown below.
- ⑭-1 **DISPLAY, DATA→MEMORY, DEFINE TRACE[ ], DATA→MEMORY**

6.6 Isolation

- ⑮ Connect the network analyzer B PORT to the instrument B PORT.  
Disconnect the cable between TEST PORT1 and TEST PORT3, and connect the load standard to TEST PORT3.

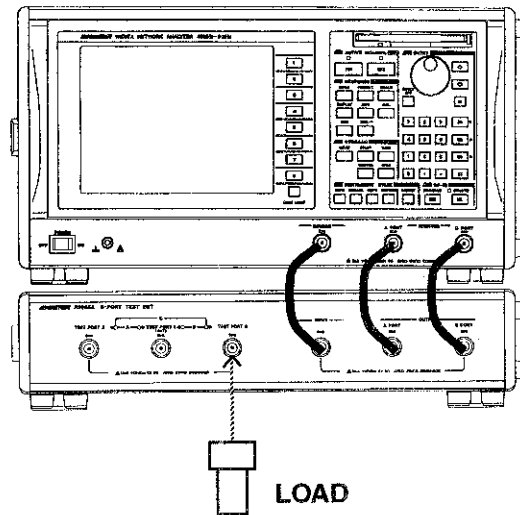

⑮-1 **AVG, AVG RESTART**

- ⑯ When the average count (shown in the upper left corner of the screen) reaches 64, read the isolation value using the marker.



Isolation from TEST PORT1 to TEST PORT3

40MHz to 2.6GHz	-85dB or less
2.6GHz to 3.8GHz	-80dB or less
3.8GHz to 5.0GHz	-65dB or less
5.0GHz to 8.0GHz	-55dB or less

Set the network analyzer as shown below after checking the above.

⑯-1 **AVG, AVG STATE OFF**

⑯-2 **DISPLAY, DEFINE TRACE[DATA-MEN], OFF**

- ⑰ Connect the test cable between TEST PORT1 and TEST PORT3.

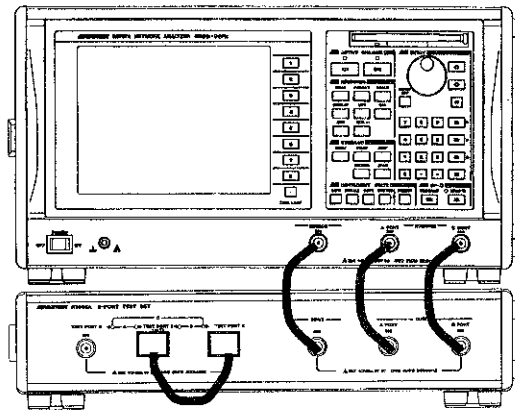

- ⑰-1 **CH1, MEAS, TEST-PORT CONNECTION B(P1-P3), S13[B] TRANS REV(P1←P3)**
- ⑰-2 **SCALE, /DIV, 1, 0, X1, REF POS, 5, 0, X1, REF VALUE, -, 9, 0, X1**
- ⑰-3 **CAL, NORMLIZE (THRU)**
- ⑱ Disconnect the network analyzer A PORT cable and connect the load standard to the A PORT.

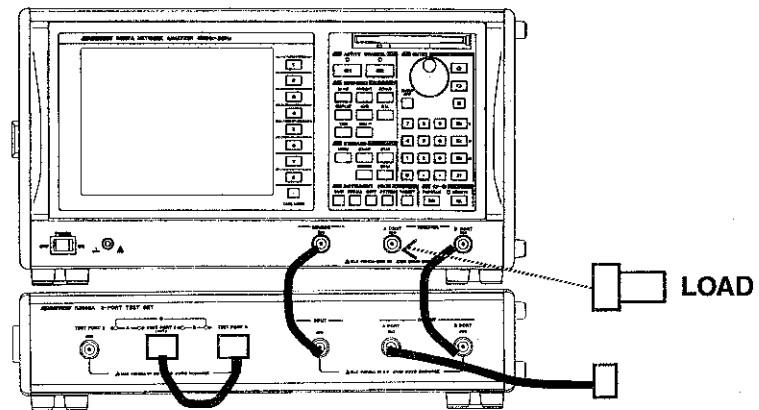

- ⑱-1 **AVG, AVG STATE ON**
- ⑲ The average count is displayed in the upper left of the screen.  
When the average count reaches 64, set the network analyzer as shown below.
- ⑲-1 **DISPLAY, DATA→MEMORY, DEFINE TRACE[ ], DATA-MEMORY**

6.6 Isolation

- ⑩ Connect the network analyzer A PORT to the instrument A PORT.  
Disconnect the test cable between TEST PORT1 and TEST PORT3 and connect the load standard to TEST PORT1.

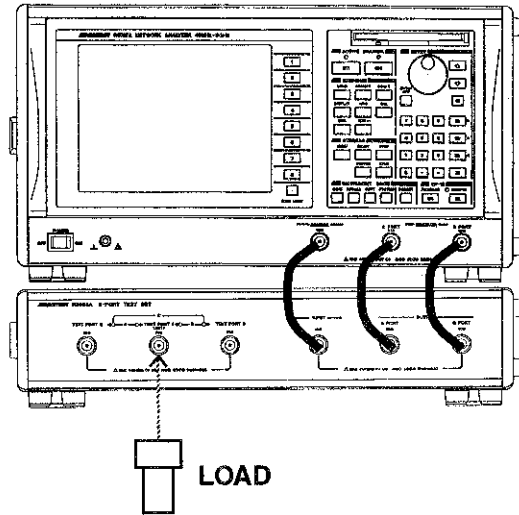

⑩-1 **AVG, AVG RESTART**

- ⑪ When the average count (shown in the upper left corner of the screen) reaches 64, read the isolation value using the marker.



Isolation from TEST PORT3 to TEST PORT1

40MHz to 2.6GHz	-85dB or less
2.6GHz to 3.8GHz	-80dB or less
3.8GHz to 5.0GHz	-65dB or less
5.0GHz to 8.0GHz	-55dB or less

- ⑫ Connect the test cable between TEST PORT2 and TEST PORT 3.

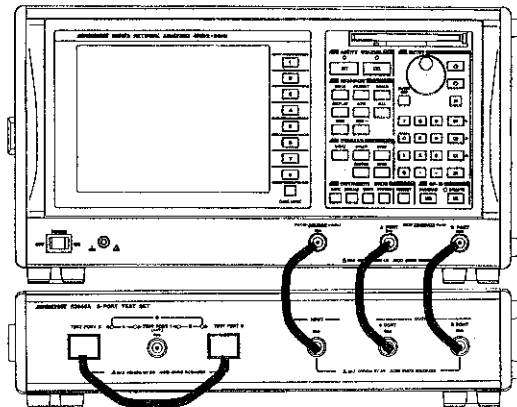

- ②-1 CH1, MEAS, TEST-PORT CONNECTION[C(P2-P3)], S32[C] TRANS FWD(P2→P3)
- ②-2 SCALE, /DIV, 1, 0, X1, REF POS, 5, 0, X1, REF VALUE, -, 9, 0, X1
- ②-3 CAL, NORMLIZE (THRU)
- ③ Disconnect the network analyzer B PORT cable and connect the load standard to B PORT.

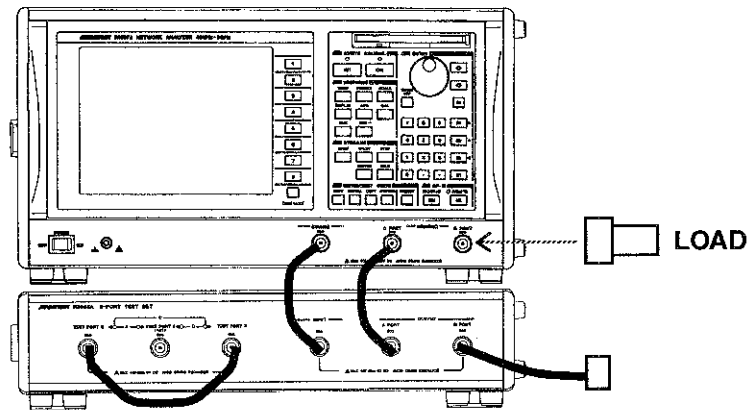

- ③-1 AVG, AVG STATE ON
- ④ The average count is displayed in the upper left of the screen.  
When the average count reaches 64, set the network analyzer as shown below.
- ④-1 DISPLAY, DATA→MEMORY, DEFINE TRACE[ ], DATA-MEMORY
- ⑤ Connect the network analyzer B PORT to the instrument B PORT.  
Disconnect the test cable between TEST PORT2 and TEST PORT3, and connect the load standard to TEST PORT3.

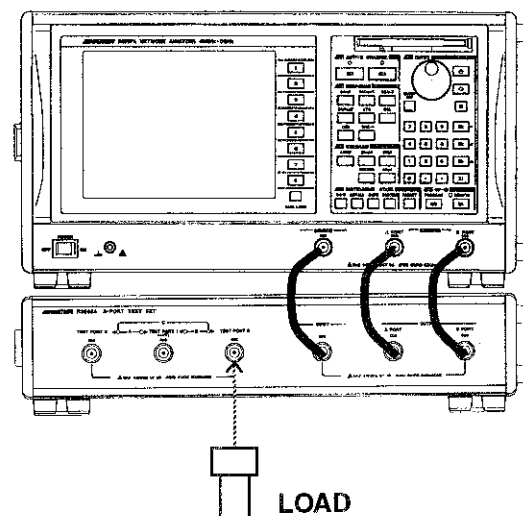

- ⑤-1 AVG, AVG RESTART

6.6 Isolation

- ② When the average count (shown in the upper left corner of the screen) reaches 64, read the isolation value using the marker.

**VERIFY**

Isolation from TEST PORT2 to TEST PORT3

- 40MHz to 2.6GHz -85dB or less
- 2.6GHz to 3.8GHz -80dB or less
- 3.8GHz to 5.0GHz -65dB or less
- 5.0GHz to 8.0GHz -55dB or less

Set the network analyzer as shown below after checking the above.

- ②-1 **AVG, AVG STATE OFF**
- ②-2 **DISPLAY, DEFINE TRACE[DATA-MEN], OFF**
- ③ Connect the cable between TEST PORT2 and TEST PORT3.

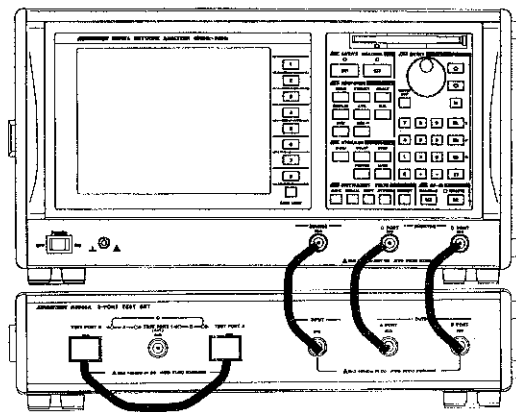

- ③-1 **CH1, MEAS, TEST-PORT CONNECTION [C(P2-P3)], S23[C] TRNS REV(P2-P3)**
- ③-2 **SCALE, /DIV, 1, 0, X1, REF POS, 5, 0, X1, REF VALUE, -, 9, 0, X1**
- ③-3 **CAL, NORMLIZE (THRU)**



- ⑳ Disconnect the network analyzer A PORT cable and connect the load standard to the A PORT.

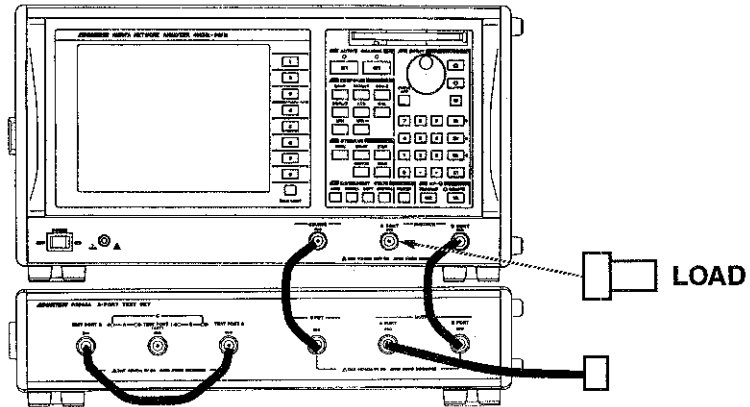

㉑-1 **AVG, AVG STATE ON**

- ㉑ The average count is displayed in the upper left of the screen.  
When the average count reaches 64, set the network analyzer as shown below.

㉒-1 **DISPLAY, DATA→MEMORY, DEFINE TRACE[ ], DATA-MEMORY**

- ㉒ Connect the network analyzer A PORT to the instrument A PORT.  
Disconnect the cable between TEST PORT2 and TEST PORT3, and connect the load standard to TEST PORT2.

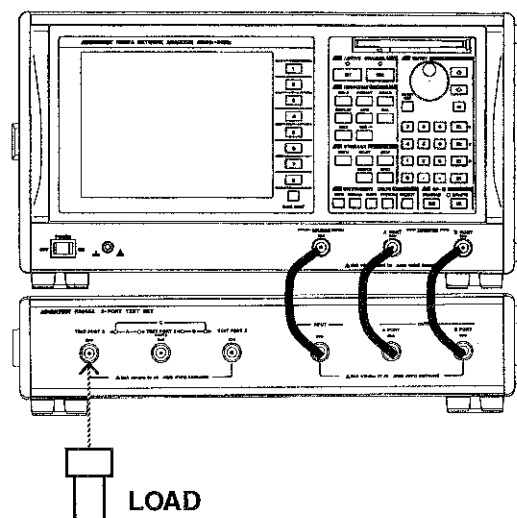

6.6 Isolation

③-1 **AVG, AVG RESTART**

③-2 When the average count (shown in the upper left corner of the screen) reaches 64, read the isolation value using the marker.



Isolation from TEST PORT2 from to TEST PORT3

- 40MHz to 2.6GHz -85dB or less
- 2.6GHz to 3.8GHz -80dB or less
- 3.8GHz to 5.0GHz -65dB or less
- 5.0GHz to 8.0GHz -55dB or less

Set the network analyzer as shown below after checking the above.

③-3 **AVG, AVG STATE OFF**

③-4 **DISPLAY, DEFINE TRACE[DATA-MEN], OFF**

(2) R3966A/B

- ① Connect the instrument to the network analyzer.
- ② Connect the test cable between TEST PORT1 and TEST PORT2.

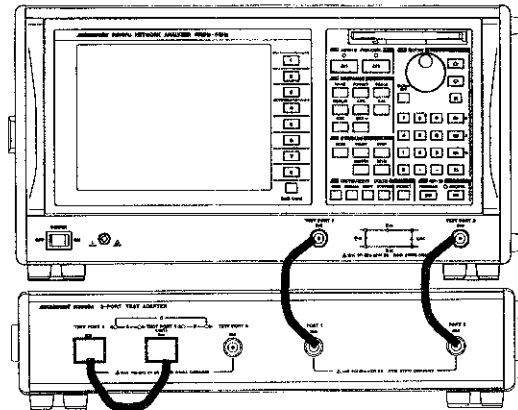

②-1 **CH1, MEAS, TEST-PORT CONNECTION[A(P1-P2)], S21[A] TRNS FWD(P1→P2)**

②-2 **SCALE, /DIV, 1, 0, X1, REF POS, 5, 0, X1, REF VALUE, -, 9, 0, X1**

②-3 **AVG, 1, 0, 0, X1**

②-4 **CAL, NORMLIZE (THRU)**

- ③ Disconnect the network analyzer TEST PORT2 cable and connect the load standard to TEST PORT2.

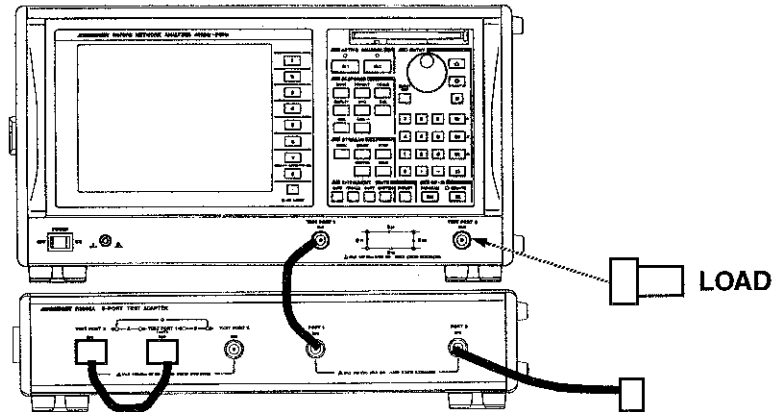

③-1 **AVG, AVG COUNT, 6, 4, X1, AVG STATE ON**

- ④ The average count is displayed in the upper left of the screen.  
When the average count reaches 64, set the network analyzer as shown below.

④-1 **DISPLAY, DATA→MEMORY, DEFINE TRACE[ ], DATA→MEMORY**

- ⑤ Connect TEST PORT2 of the network analyzer to PORT2 of the instrument.  
Disconnect the cable from TEST PORT1 and TEST PORT2, and connect the load standard to TEST PORT2.

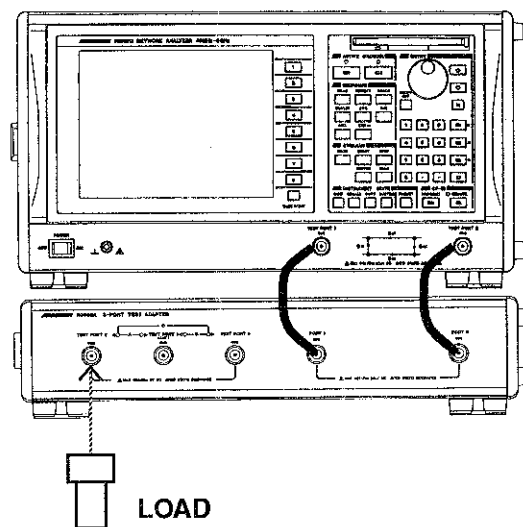

⑤-1 **AVG, AVG RESTART**

6.6 Isolation

- ⑥ When the average count (shown in the upper left corner of the screen) reaches 64, read the isolation value using the marker.

**VERIFY**

Isolation of TEST PORT1 from TEST PORT2

- 40MHz to 2.6GHz -85dB or less
- 2.6GHz to 3.8GHz -80dB or less
- 3.8GHz to 5.0GHz -65dB or less
- 5.0GHz to 8.0GHz -55dB or less

Set the network analyzer as shown below after checking the above.

⑥-1 **AVG, AVG STATE OFF**

⑥-2 **DISPLAY, DEFINE TRACE[DATA-MEN], OFF**

- ⑦ Connect the test cable between TEST PORT1 and TEST PORT2.

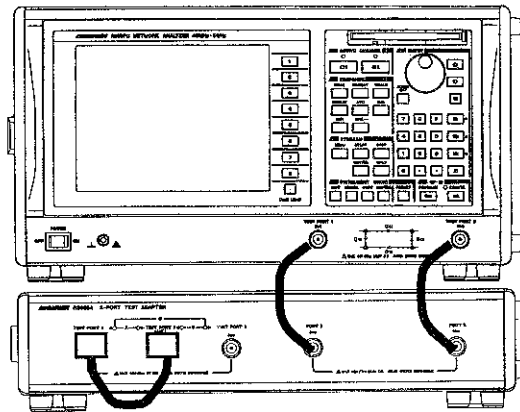

⑦-1 **CH1, MEAS, TEST-PORT CONNECTION [A(P1-P2)], S12[A] TRNS REV(P1←P2)**

⑦-2 **SCALE, /DIV, 1, 0, X1, REF POS, 5, 0, X1, REF VALUE, -, 9, 0, X1**

⑦-3 **CAL, NORMLIZE (THRU)**

- ⑧ Disconnect the cable connected to the network analyzer TEST PORT1 and connect the load standard to TEST PORT1.

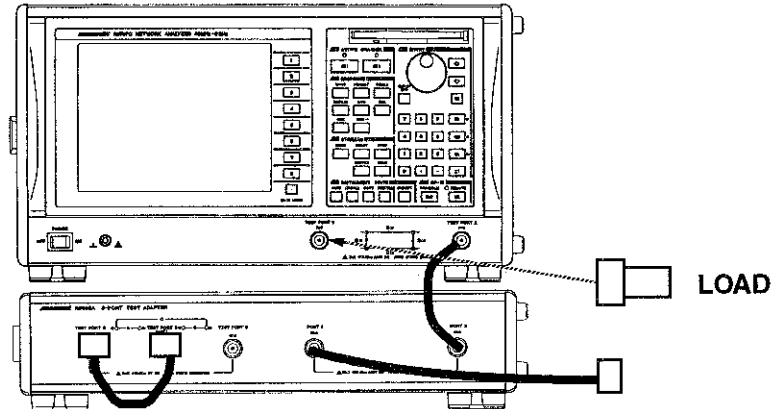

⑧-1 **AVG, AVG STATE ON**

- ⑨ The average count is displayed in the upper left of the screen.  
When the average count reaches 64, set the network analyzer as shown below.

⑨-1 **DISPLAY, DATA→MEMORY, DEFINE TRACE[ ], DATA→MEMORY**

- ⑩ Connect the network analyzer TEST PORT1 to the instrument PORT1.  
Disconnect the cable between TEST PORT1 and TEST PORT2, and connect the load standard to TEST PORT1.

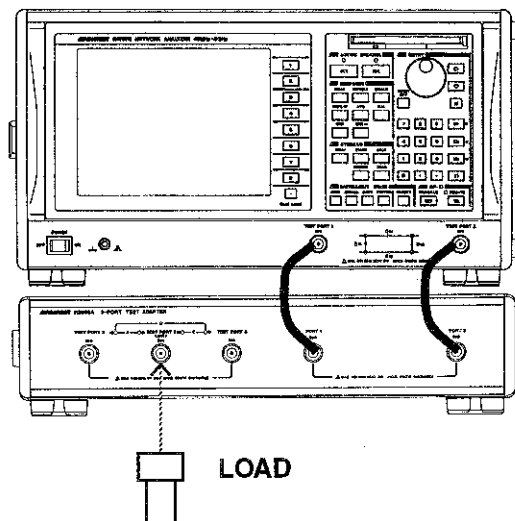

⑩-1 **AVG, AVG RESTART**

6.6 Isolation

- ⑪ When the average count (shown in the upper left corner of the screen) reaches 64, read the isolation value using the marker.



Isolation from TEST PORT2 to TEST PORT1

- 40MHz to 2.6GHz -85dB or less
- 2.6GHz to 3.8GHz -80dB or less
- 3.8GHz to 5.0GHz -65dB or less
- 5.0GHz to 8.0GHz -55dB or less

Set the network analyzer as shown below after checking the above.

- ⑪-1 **AVG, AVG STATE OFF**
- ⑪-2 **DISPLAY, DEFINE TRACE[DATA-MEN], OFF**
- ⑫ Connect the test cable between TEST PORT1 and TEST PORT3.

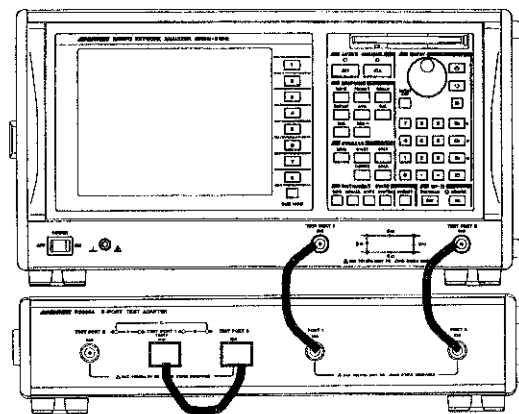

- ⑫-1 **CH1, MEAS, TEST-PORT CONNECTION[B(P1-P3)], S31[B] TRNS FWD(P1→P3)**
- ⑫-2 **SCALE, /DIV, 1, 0, X1, REF POS, 5, 0, X1, REF VALUE, -, 9, 0, X1**
- ⑫-3 **CAL, NORMLIZE (THRU)**

- ⑬ Disconnect the cable connected to network analyzer TEST PORT2 and connect the load standard to TEST PORT2.

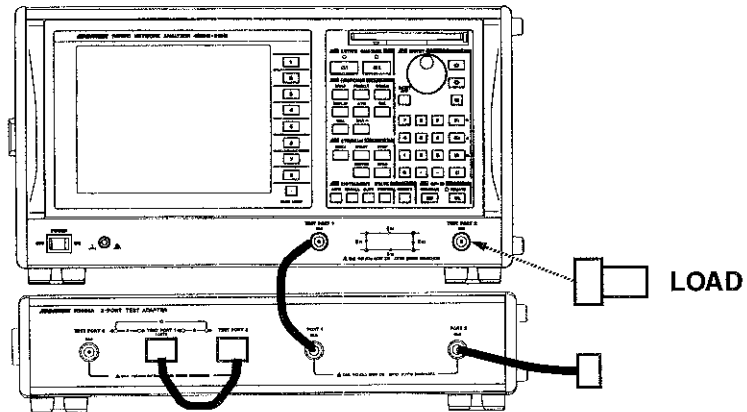

⑬-1 **AVG, AVG STATE ON**

- ⑭ The average count is displayed in the upper left of the screen.  
When the average count reaches 64, set the network analyzer as shown below.

⑭-1 **DISPLAY, DATA→MEMORY, DEFINE TRACE[ ], DATA-MEMORY**

- ⑮ Connect the network analyzer TEST PORT2 to the instrument PORT2.  
Disconnect the cable from TEST PORT1 and TEST PORT3, and connect the load standard to TEST PORT3.

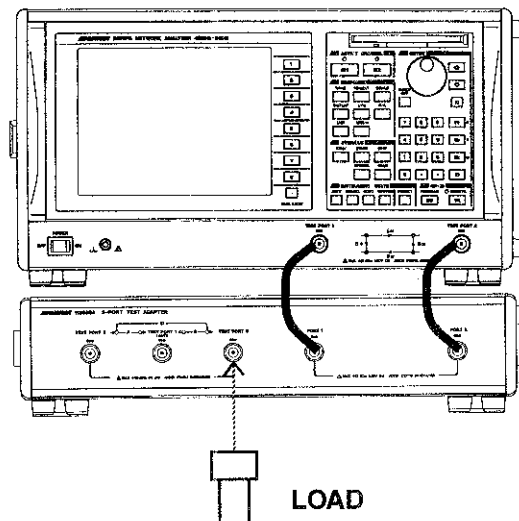

⑮-1 **AVG, AVG RESTART**

6.6 Isolation

- ⑩ When the average count (shown in the upper left corner of the screen) reaches 64, read the isolation value using the marker.



Isolation from TEST PORT1 to TEST PORT3

- 40MHz to 2.6GHz -85dB or less
- 2.6GHz to 3.8GHz -80dB or less
- 3.8GHz to 5.0GHz -65dB or less
- 5.0GHz to 8.0GHz -55dB or less

Set the network analyzer as shown below after checking the above.

- ⑩-1 **AVG, AVG STATE OFF**
- ⑩-2 **DISPLAY, DEFINE TRACE[DATA-MEN], OFF**
- ⑪ Connect the test cable between TEST PORT1 and TEST PORT3.

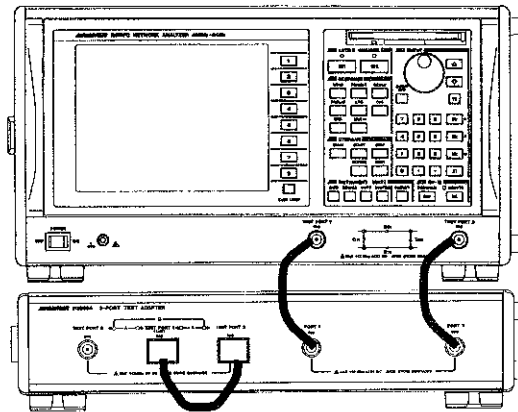

- ⑪-1 **CH1, MEAS, TEST-PORT CONNECTION[B(P1-P3)], S13[B] TRANS REV(P1←P3)**
- ⑪-2 **SCALE, /DIV, 1, 0, X1, REF POS, 5, 0, X1, REF VALUE, -, 9, 0, X1**
- ⑪-3 **CAL, NORMLIZE (THRU)**



- ⑮ Disconnect the cable connected to the network analyzer TEST PORT1 and connect the load standard to TEST PORT1.

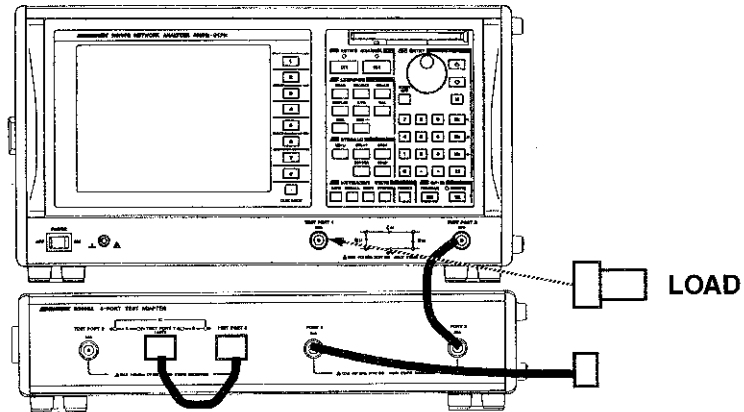

⑮-1 **AVG, AVG STATE ON**

- ⑲ The average count is displayed in the upper left of the screen.  
When the average count reaches 64, set the network analyzer as shown below.

⑲-1 **DISPLAY, DATA→MEMORY, DEFINE TRACE[ ], DATA-MEMORY**

- ⑳ Connect the network analyzer TEST PORT1 to the instrument PORT1.  
Disconnect the test cable between TEST PORT1 and TEST PORT3, and connect the load standard to TEST PORT1.

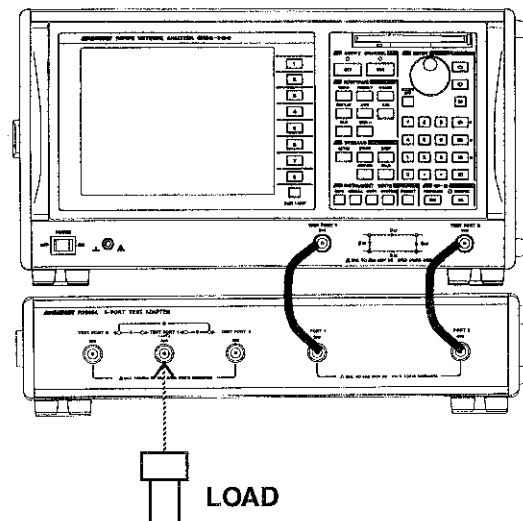

⑳-1 **AVG, AVG RESTART**

6.6 Isolation

- ① When the average count (shown in the upper left corner of the screen) reaches 64, read the isolation value using the marker.



Isolation from TEST PORT3 to TEST PORT1

- 40MHz to 2.6GHz -85dB or less
- 2.6GHz to 3.8GHz -80dB or less
- 3.8GHz to 5.0GHz -65dB or less
- 5.0GHz to 8.0GHz -55dB or less

Set the network analyzer as shown below after checking the above.

①-1 **AVG, AVG STATE OFF**

①-2 **DISPLAY, DEFINE TRACE [DATA-MEN], OFF**

- ② Connect the test cable between TEST PORT2 and TEST PORT 3.

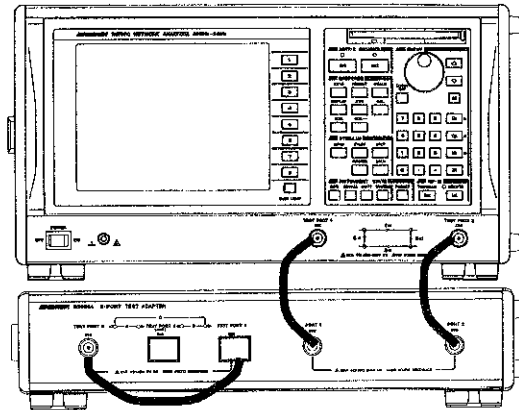

②-1 **CH1, MEAS, TEST-PORT CONNECTION[C(P2-P3)], S32[C] TRNS FWD(P2→P3)**

②-2 **SCALE, /DIV, 1, 0, X1, REF POS, 5, 0, X1, REF VALUE, -, 9, 0, X1**

②-3 **CAL, NORMLIZE (THRU)**

- ⑳ Disconnect the cable connected to the network analyzer TEST PORT2 and connect the load standard to TEST PORT2.

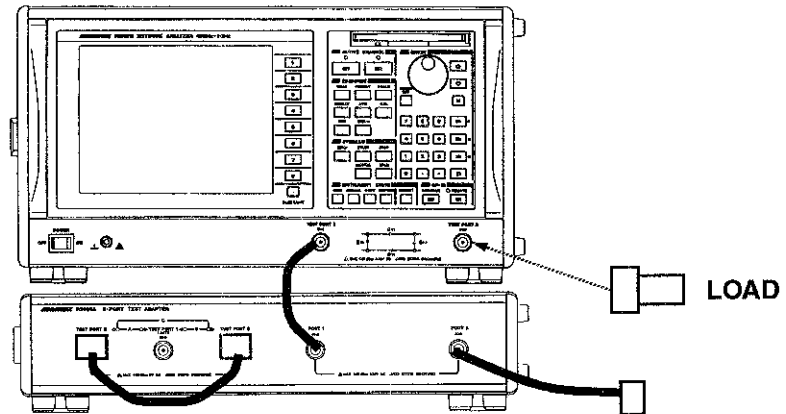

㉑-1 **AVG, AVG STATE ON**

- ㉒ The average count is displayed in the upper left of the screen.  
When the average count reaches 64, set the network analyzer as shown below.

㉒-1 **DISPLAY, DATA→MEMORY, DEFINE TRACE[ ], DATA-MEMORY**

- ㉓ Connect the network analyzer TEST PORT2 to the instrument POTR2.  
Disconnect the test cable between TEST PORT2 and TEST PORT3, and connect the load standard to TEST PORT3.

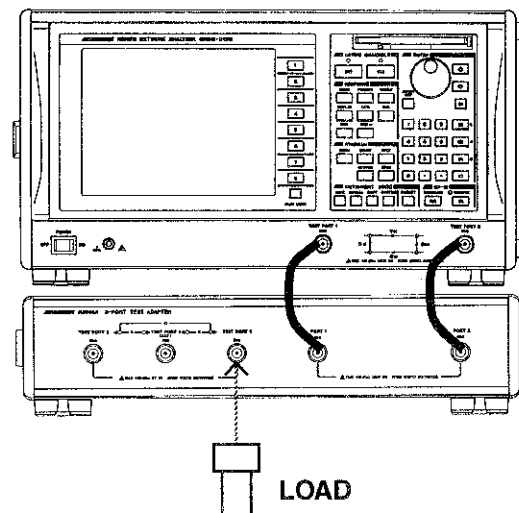

㉓-1 **AVG, AVG RESTART**

6.6 Isolation

- ⑳ When the average count (shown in the upper left corner of the screen) reaches 64, read the isolation value using the marker.



Isolation from TEST PORT2 to TEST PORT3

- 40MHz to 2.6GHz -85dB or less
- 2.6GHz to 3.8GHz -80dB or less
- 3.8GHz to 5.0GHz -65dB or less
- 5.0GHz to 8.0GHz -55dB or less

Set the network analyzer as shown below after checking the above.

- ㉑-1 **AVG, AVG STATE OFF**
- ㉑-2 **DISPLAY, DEFINE TRACE[DATA-MEN], OFF**
- ㉒ Connect the test cable between TEST PORT2 and TEST PORT3.

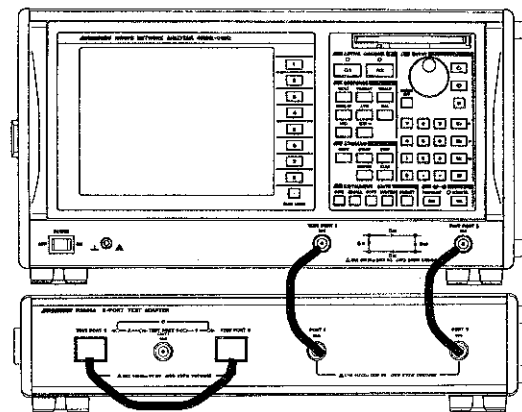

- ㉒-1 **CH1, MEAS, TEST-PORT CONNECTION [C(P2-P3)], S23[C] TRNS REV(P2←P3)**
- ㉒-2 **SCALE, /DIV, 1, 0, X1, REF POS, 5, 0, X1, REF VALUE, -, 9, 0, X1**
- ㉒-3 **CAL, NORMLIZE (THRU)**

- ⑳ Disconnect the cable connected to the network analyzer TEST PORT1 and connect the load standard to TEST PORT1.

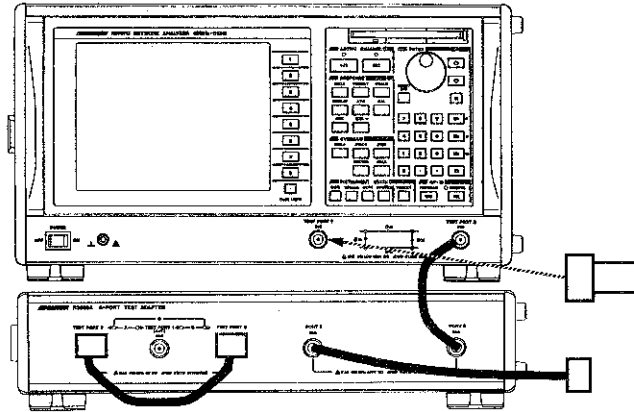

⑳-1 **AVG, AVG STATE ON**

- ㉑ The average count is displayed in the upper left of the screen.  
When the average count reaches 64, set the network analyzer as shown below.

㉑-1 **DISPLAY, DATA→MEMORY, DEFINE TRACE[ ], DATA-MEMORY**

- ㉒ Connect the network analyzer TEST PORT1 to the instrument PORT1 .  
Disconnect the cable between TEST PORT2 and TEST PORT3, and connect the load standard to TEST PORT2.

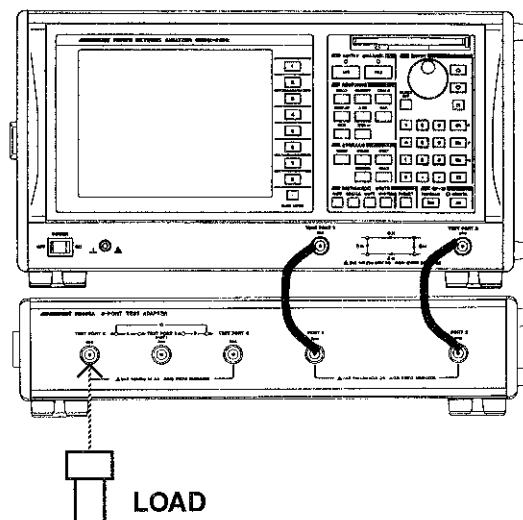

㉒-1 **AVG, AVG RESTART**

## 6.6 Isolation

- ③ When the average count (shown in the upper left corner of the screen) reaches 64, read the isolation value using the marker.



Isolation from TEST PORT3 to TEST PORT2

40MHz to 2.6GHz -85dB or less

2.6GHz to 3.8GHz -80dB or less

3.8GHz to 5.0GHz -65dB or less

5.0GHz to 8.0GHz -55dB or less

## 7 SPECIFICATIONS

### 7.1 Specifications of R3965A/B

Item	R3965A/B
Directivity (25°C ±5°C)	–30dB typical *–40dB typical (40MHz to 2.6GHz) –29dB typical *–32dB typical (2.6GHz to 3.8GHz) –25dB typical *–26dB typical (3.8GHz to 8.0GHz) * :When 2PORT FULL CAL is performed
Test port load match (25°C ±5°C)	–25dB typical *–40dB typical (40MHz to 2.6GHz) –20dB typical *–32dB typical (2.6GHz to 3.8GHz) –14dB typical *–26dB typical (3.8GHz to 8.0GHz) * : When 2PORT FULL CAL is performed
Frequency characteristics Transmission magnitude TEST PORT1 to TEST PORT2 {A(P1-P2)} TEST PORT1 to TEST PORT3 {B(P1-P3)} TEST PORT2 to TEST PORT3 {C(P2-P3)} Reflection magnitude TEST PORT1 {A(P1-P2)} TEST PORT2 {A(P1-2), C(P2-3) } TEST PORT3 {B(P1-3)}	4dB p-p typical 4dB p-p typical 4dB p-p typical 6dB p-p typical 6dB p-p typical 6dB p-p typical
Insertion loss INPUT to TEST PORT1 {A(P1-2), B(P1-3) } INPUT to TEST PORT2 {A(P1-2), C(P2-3) } INPUT to TEST PORT3 {B(P1-3), C(P2-3) } TEST PORT1 to A PORT {A(P1-2), B(P1-3) } TEST PORT2 to A PORT {C(P2-3)} TEST PORT2 to B PORT {A(P1-2)} TEST PORT3 to B PORT {B(P1-3), C(P2-3) }	–11dB typical –14dB typical –14dB typical –22dB typical –25dB typical –25dB typical –22dB typical

7.1 Specifications of R3965A/B

Item	R3965A/B
Isolation TEST PORT1 to TEST PORT2  TEST PORT1 to TEST PORT3  TEST PORT2 to TEST PORT3	--85dB or less (40MHz to 2.6GHz) --80dB or less (2.6GHz to 3.8GHz) --65dB or less (3.8GHz to 5.0GHz) --55dB or less (5.0GHz to 8.0GHz)  --85dB or less (40MHz to 2.6GHz) --80dB or less (2.6GHz to 3.8GHz) --65dB or less (3.8GHz to 5.0GHz) --55dB or less (5.0GHz to 8.0GHz)  --85dB or less (40MHz to 2.6GHz) --80dB or less (2.6GHz to 3.8GHz) --65dB or less (3.8GHz to 5.0GHz) --55dB or less (5.0GHz to 8.0GHz)
Frequency range	40MHz to 8.0GHz
RF breakdown level	+20dBm max.
Environmental conditions	Temperature range: 0°C to +50°C Humidity range: 80% or lower (no condensation)
Storage temperature range	-20°C to +60°C
Programming	The R3765AH or R3767AH controls all functions. Shares the R3765AH or R3767AH GPIB interface for remote control.
Power supply	Powered by the R3765AH or R3767AH
Mass	5kg or less
External dimensions R3965A R3965B	Approximately 424 (W) × 88 (H) × 400 (D) mm Approximately 252 (W) × 88 (H) × 165 (D) mm



## 7.2 Specifications of R3966A/B

Item	R3966A/B
Insertion loss PORT1 to TEST PORT1 {A(P1-P2), B(P1-P3) } PORT1 to TEST PORT2 {C(P2-P3)} PORT2 to TEST PORT2 {A(P1-P2)} PORT2 to TEST PORT3 {B(P1-P3), C(P2-P3) }	-4dB typical -6dB typical -6dB typical -4dB typical
Isolation TEST PORT1 to TEST PORT2  TEST PORT1 to TEST PORT3  TEST PORT2 to TEST PORT3	-85dB or less (40MHz to 2.6GHz) -80dB or less (2.6GHz to 3.8GHz) -65dB or less (3.8GHz to 5.0GHz) -55dB or less (5.0GHz to 8.0GHz)  -85dB or less (40MHz to 2.6GHz) -80dB or less (2.6GHz to 3.8GHz) -65dB or less (3.8GHz to 5.0GHz) -55dB or less (5.0GHz to 8.0GHz)  -85dB or less (40MHz to 2.6GHz) -80dB or less (2.6GHz to 3.8GHz) -65dB or less (3.8GHz to 5.0GHz) -55dB or less (5.0GHz to 8.0GHz)
Frequency range	40MHz to 8.0GHz
RF breakdown level	+20dBm max.
Environmental conditions	Temperature range: 0°C to +50°C Humidity range: 80% or lower (no condensation)
Storage temperature range	-20°C to +60°C
Programming	The R3765CH or R3767CH controls all functions. Shares the R3765CH or R3767CH GPIB interface for remote control.
Power supply	Powered by the R3765CH or R3767CH
Mass	5kg or less
External dimensions	R3966A Approximately 424 (W) × 88 (H) × 400 (D) mm R3966B Approximately 252 (W) × 88 (H) × 165 (D) mm



## APPENDIX

### A.1 MEAS Extension and Calibration Function Extension

When the instrument is connected to the R3765AH/CH or R3767AH/CH network analyzer, the following two functions are enabled:

- MEAS extension (test port switching in three-port mode)
- Calibration function extension    TRIPLEX 2PORT CAL  
   FULL 3PORT CAL

These two functions are described in this appendix.

#### A.1.1 MEAS extension (test port switching in three-port mode)

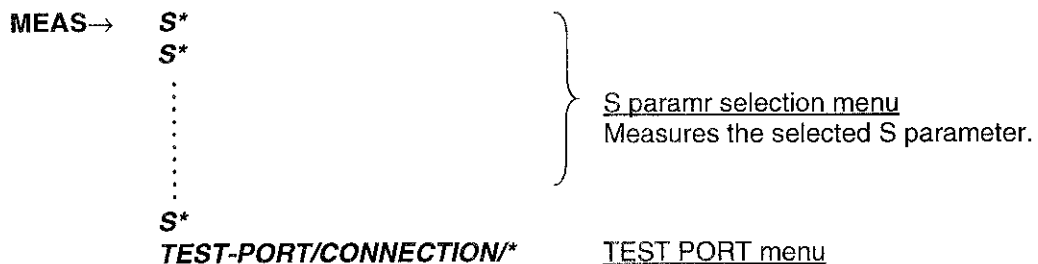

TEST PORT menu  
Selects a system between measuring ports. Selects the PORT1 to PORT2, the PORT1 to PORT3, or the PORT2 to PORT3 setting. Selecting these systems automatically changes the S parameter selection menu.

List of MEAS soft key menus

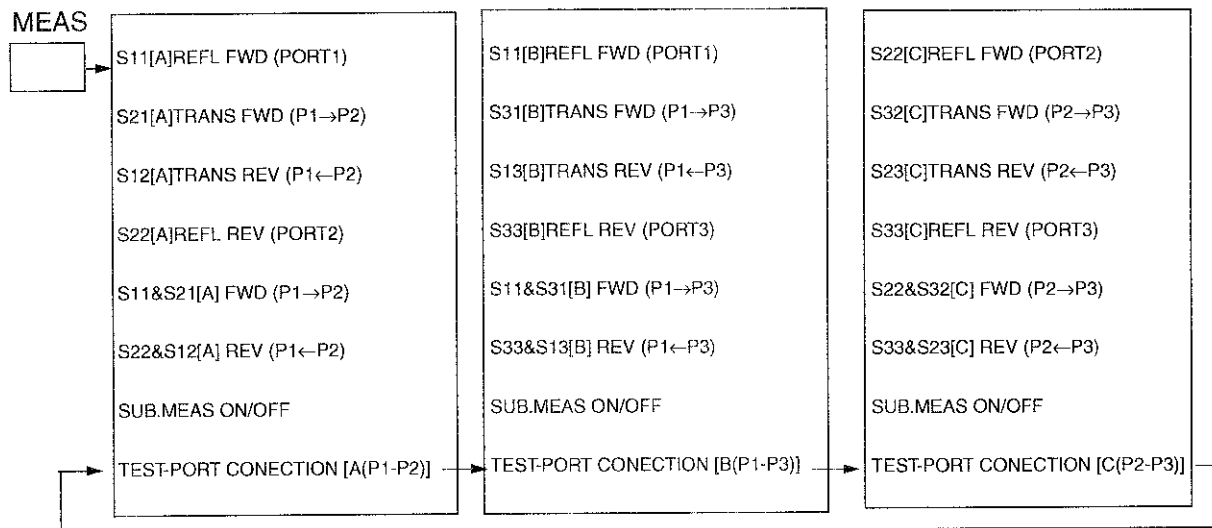

A.1 MEAS Extension and Calibration Function Extension

**A.1.2 Calibration function extension (TRIPLEX 2 PORT CAL / FULL 3 PORT CAL)**

The TRIPLEX 2PORT CAL and FULL 3PORT CAL function enables you to execute a calibration when measuring multi-port devices using a test set.

As calibration data is operated according to the measurement item selected by MEAS, measurement can be performed regardless of the combination between the measurement system (ANT port, Tx port or Rx port) and the calibration data.

**TRIPLEX 2PORT CAL →**

<b>PORT1 REFLECT'N</b>	Displays the PORT1 Reflection Error Data Acquisition menu
<b>PORT2 REFLECT'N</b>	Displays the PORT2 Reflection Error Data Acquisition menu
<b>PORT3 REFLECT'N</b>	Displays the PORT3 Reflection Error Data Acquisition menu
<b>TRANSMISSION</b>	Displays the PORT1, 2, and 3 Transmission Error Data Acquisition menu
<b>ISOLATION</b>	Displays the Isolation Data Acquisition menu
<b>DONE TRIPLEX 2-PORT</b>	Executes TRIPLEX 2PORT CAL.

**3PORT FULL CAL →**

<b>PORT1 REFLECT'N</b>	Displays the PORT1 Reflection Error Data Acquisition menu
<b>PORT2 REFLECT'N</b>	Displays the PORT2 Reflection Error Data Acquisition menu
<b>PORT3 REFLECT'N</b>	Developed to the PORT3 Reflection Error Data Acquisition menu
<b>TRANSMISSION</b>	Displays the PORT1, 2, and 3 Transmission Error Data Acquisition menu
<b>ISOLATION</b>	Displays the Isolation Data Acquisition menu
<b>DONE TRIPLEX 2-PORT</b>	Executes FULL 3PORT CAL

TRIPLEX 2PORT CAL simultaneously executes FULL 2PORT CAL for three combinations (PORT1 to PORT2, PORT1 to PORT3, and PORT2 to PORT3). As a result, when measuring PORT1 to PORT2, the reflection error from PORT3 cannot be removed because the error from PORT3 is not calibrated.

In the same way, the error of PORT2 is not calibrated when measuring PORT1 to PORT3, and the error of PORT1 is not calibrated when measuring PORT2 to PORT3.

As the FULL 3PORT CAL completely calibrates the three-port network, it calibrates the error of PORT3 even when measuring PORT1 to PORT2. As a result, it calibrates the error caused by the reflection from PORT3.

In the same way, the error of the PORT2 is calibrated when measuring PORT1 to PORT3, and the error of PORT1 is calibrated when measuring PORT2 to PORT3.

However, measurement is always executed in three directions when performing the FULL 3PORT CAL. As the FULL 3PORT CAL measures PORT1 to PORT3 and PORT2 to PORT3 while measuring PORT1 to PORT2, three times the FULL 2PORT CAL measurement time is required.

A.1 MEAS Extension and Calibration Function Extension

List of TRIPLEX 2PORT CAL soft key menus

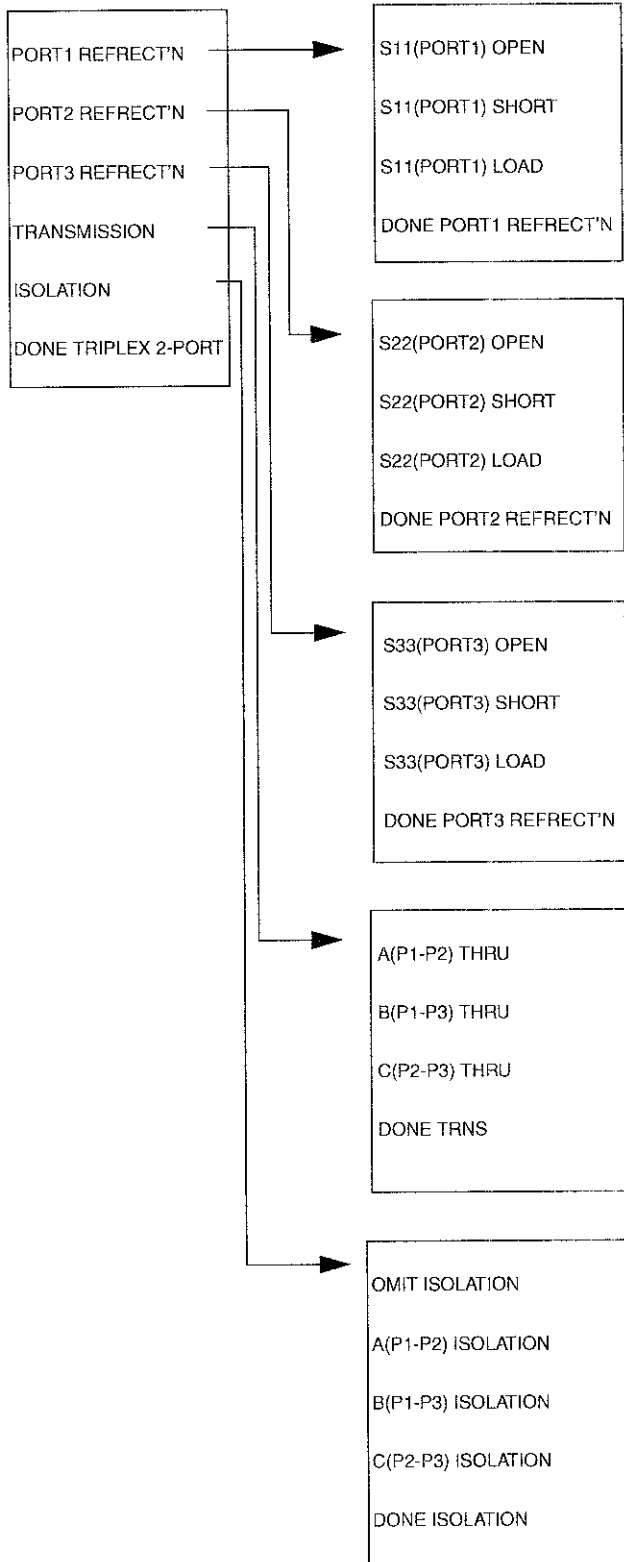

A.1 MEAS Extension and Calibration Function Extension

List of FULL 3PORT CAL soft key menus

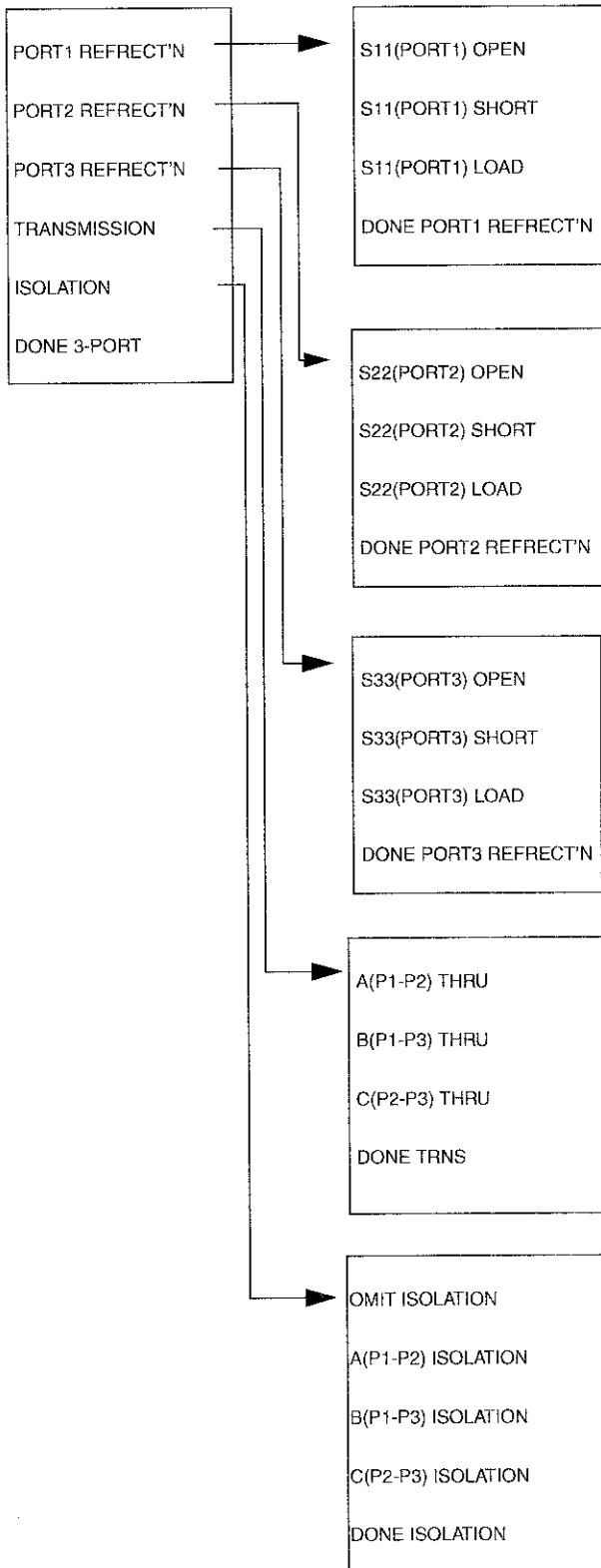

### A.1.3 List of GPIB codes

#### (1) MEAS-related codes

```
[SENSe:]FUNctIon[<chno>]:POWer
[SENSe:]FUNctIon[<chno>][:ON]
```

- Sets the Function MEAS mode and turns the SUB MEAS ON or OFF. (Command/Query)
- New commands

Commands                    [SENSe:]FUNctIon[ch]:POWer<input>  
                              [SENSe:]FUNctIon[ch][:ON]<str>

Parameters <input> = {RIABIARIBRIABIBDCIBDCRI  
                              S11[A]IS21[A]IS12[A]ISFWD[A]ISREV[A]  
S11BIS31BIS13BIS33BISFWDIBSREVB  
S22CIS32CIS23CIS33CISFWDICISREVC  
NONE}

<str>= {"POWer:{ACIDC} {1|2|3}"  
          "POWer:{ACIDC}:RATio{2,1|3,1|3,2}"  
          "POWer:{S11[A]IS21[A]IS12[A]IS22[A]ISFWD[A]ISREV[A]  
          S11BIS31BIS13BIS33BISFWDIBSREVB  
          S22CIS32CIS23CIS33CISFWDICISREVC}"  
          "POWer:NONE"}

Response type            RIAIBIARIBRIABIBDCIBDCRI S11IS21IS12ISFWDISREVI  
                              S11BIS31BIS13BIS33BISFWDIBSREVB  
                              S22CIS32CIS23CIS33CISFWDICISREVC  
                              NONE

"POW:{ACIDC}{1|2|3}"  
"POW:{ACIDC}:RAT{2,1|3,1|3,2}"  
"POW:{S11IS21IS12IS22ISFWDISREVI  
S11BIS31BIS13BIS33BISFWDIBSREVB  
S22CIS32CIS23CIS33CISFWDICISREVC}"  
"POW:NONE"

A.1 MEAS Extension and Calibration Function Extension

- Previous commands  
 Commands {RIAIBIARIBRIABIBDCIBDCR}IN,  
 S11[A],S21[A],S12[A],S22[A],SFWD[A],SREV[A],  
 S11B,S31B,S13B,S33B,SFWD[B],SREVB,  
 S22C,S32C,S23C,S33C,SFWD[C],SREVC  
  
 SMEAS<bool>  
  
 Response type 011  
  
 • Description See Table A-1.  
  
 • CAUTION When S11A to SREVC are set and as a result the switching of the test ports (A, B, and C) is necessary, the correspondent Main or Sub MEAS setting is used with the same port connection.  
 However, the channel MEAS setting used will be the previous MEAS setting for that port.

**Table A-1 Relationship between the New and Previous MEAS Commands**

Previous command	New command		Operation (input port)
	<input>	<str>	
S11A	S11A	"POW:S11A"	Sets S11[A]. (TEST PORT connection A)
S21A	S21A	"POW:S21A"	Sets S21[A]. (TEST PORT connection A)
S12A	S12A	"POW:S12A"	Sets S12[A]. (TEST PORT connection A)
S22A	S22A	"POW:S22A"	Sets S22[A]. (TEST PORT connection A)
SFWD[A]	SFWD[A]	"POW:SFWDA"	Sets S21&S21[A]. (TEST PORT connection A)
SREVA	SREVA	"POW:SREVA"	Sets S22&S12[A]. (TEST PORT connection A)
S11B	S11B	"POW:S11B"	Sets S11[B]. (TEST PORT connection B)
S31B	S31B	"POW:S31B"	Sets S31[B]. (TEST PORT connection B)
S13B	S13B	"POW:S13B"	Sets S13[B]. (TEST PORT connection B)
S33B	S33B	"POW:S33B"	Sets S33[B]. (TEST PORT connection B)
SFWD[B]	SFWD[B]	"POW:SFWDB"	Sets S11&S31[B]. (TEST PORT connection B)
SREVB	SREVB	"POW:SREVB"	Sets S33&S13[B]. (TEST PORT connection B)
S22C	S22C	"POW:S22C"	Sets S22[C]. (TEST PORT connection C)
S32C	S32C	"POW:S32C"	Sets S32[C]. (TEST PORT connection C)
S23C	S23C	"POW:S23C"	Sets S23[C]. (TEST PORT connection C)
S33C	S33C	"POW:S33C"	Sets S33[C]. (TEST PORT connection C)
SFWD[C]	SFWD[C]	"POW:SFWDC"	Sets S22&S32[C]. (TEST PORT connection C)
SREVC	SREVC	"POW:SREVC"	Sets S33&S23[C]. (TEST PORT connection C)



## (2) CAL-related commands

**Note** <port> : 1; PORT1

2;PORT2

3;PORT3

&lt;eport&gt;: 1;R channel

2;A channel

3;B channel

4;PORT1

5;PORT2

6;PORT3

## 1. [SENSE:]CORRection[&lt;chno&gt;]:COLLect:MEtHod

- Function Sets the CAL method (type).
- Presence of command and query  
Command/Query
- New command
 

Command	[SENSE:]CORRection[<chno>]:COLLect:MEtHod<type>
Parameter	<type>= {NORMalize SNORmalize F1Port NISolation  F2Port D2Port T2Port F3Port}
Response type	NONE NORM SNOR IF1 PINIS IF2 PID2 PIT2 PIF3P
- Previous command
 

Command	CAL{NONE NORM SNOR IF1 PINIS IF2 PID2 PIT2 PIF3P} (CALNONE is only for Query.)
Response type	0 1
- Description This command sets the CAL method in advance (see Table A-2) before the CORR:COLL[:ACQ]STAN<n> or STAN{1|2|\_c} is used.

A.1 MEAS Extension and Calibration Function Extension

- CAUTION                      When CORR:CSET:STAT or CORRECT is ON, this command cannot be set. Also, if another type is specified when the CAL has been obtained, the obtained data will be lost (same as CORR:COLL:DEL).
  
- The set value will be retained until the PRESET, \*RST, RECALL or LOAD command is used. (executed or reset).
  
- When a <type> unavailable for the instrument is specified, an error occurs.
  
- In Query, the currently used CAL type is returned even if the calibration has not been completed (ie. not in DONE status).
  
- When CORR:COLL:DEL or CLEAR is executed, NONE is automatically set.

2. [SENSE:]CORRection[<chno>]:COLLect[:ACQuire]<standard>

- Function                      Acquires the CAL (Calibration) data.
  
- Presence of command and query  
                                    Command
  
- New command  
  - Command                      [SENSE:]CORRection[<chno>]:COLLect[:ACQuire]<standard>
  - Parameter                      <standard>= {NORMalize|SNORmalize|...|STANdard<n>}
  
- Previous command  
  - Command                      STAN{1|2|3|4|5|6|7|8|9|10|11|12|13|14|15|16}
  
- CAUTION                      When using CORR:COLL STAN<n> or STAN{1|2|\_c}, it is necessary to set the CAL mode in advance using CORR:COLL:METH<type> or CAL{NORMISNORIF1PIF2PI\_c} (see Table A-2).
  
- When CORR:COLL:METH? is NONE, or CALNONE is 1, the result of CORR:COLL STAN<n> and STAN{1|2|\_c} will be invalid.

Table A-2 Relationship between the Panel Menu and the STAN Command

Panel menu	Corresponding GPIB command	Remarks
NORMALIZE (THRU)	CORR:COLL:METH NORM CORR:COLL STAN1;*WAI	Same as CORR:COLL NORM Same as CORR:COLL NORM
NORMALIZE (SHORT)	CORR:COLL:METH SNOR CORR:COLL STAN1;*WAI	Same as CORR:COLL SNOR Same as CORR:COLL SNOR
1 PORT FULL CAL OPEN SHORT LOAD DONE 1-PORT	CORR:COLL:METH F1P CORR:COLL STAN1;*WAI CORR:COLL STAN2;*WAI CORR:COLL STAN3;*WAI CORR:COLL:SAVE	Same as CORR:COLL OPEN Same as CORR:COLL SHORT Same as CORR:COLL LOAD
NORMALIZE & ISOLATION THRU ISOLATION DONE NORM & ISO	CORR:COLL:METH NIS CORR:COLL STAN1;*WAI CORR:COLL STAN2;*WAI CORR:COLL:SAVE	Same as CORR:COLL THRU Same as CORR:COLL ISOL
2 PORT FULL CALL FWD:OPEN FWD:SHORT FWD:LOAD REV:OPEN REV:SHORT REV:LOAD FWD.TRANS THRU FWD.MATCH THRU REV.TRANS THRU REV.MATCH THRU GROUP THRU OMIT ISOLATION FWD.ISOLATION REV.ISOLATION DONE 2-PORT	CORR:COLL:METH F2P CORR:COLL STAN1;*WAI CORR:COLL STAN2;*WAI CORR:COLL STAN3;*WAI CORR:COLL STAN4;*WAI CORR:COLL STAN5;*WAI CORR:COLL STAN6;*WAI CORR:COLL STAN7;*WAI CORR:COLL STAN8;*WAI CORR:COLL STAN9;*WAI CORR:COLL STAN10;*WAI CORR:COLL STAN11;*WAI CORR:COLL STAN12;*WAI CORR:COLL STAN13;*WAI CORR:COLL STAN14;*WAI CORR:COLL:SAVE	Same as CORR:COLL S11O Same as CORR:COLL S11S Same as CORR:COLL S11L Same as CORR:COLL S22O Same as CORR:COLL S22S Same as CORR:COLL S22L Same as CORR:COLL FTR Same as CORR:COLL FMAT Same as CORR:COLL RTR Same as CORR:COLL RMAT Same as CORR:COLL GTHR Same as CORR:COLL OIS Same as CORR:COLL FIS Same as CORR:COLL RIS
DUPLEX 2 PORT CALL TRIPLEX 2 PORT CALL 3 PORT FULL CALL	CORR:COLL:METH D2P CORR:COLL:METH T2P CORR:COLL:METH F3P	
S11(PORT1)OPEN S11(PORT1)SHORT S11(PORT1)LOAD S22(PORT2)OPEN S22(PORT2)SHORT S22(PORT2)LOAD S33(PORT3)OPEN S33(PORT3)SHORT S33(PORT3)LOAD A(P1-P2) THRU B(P1-P3) THRU C(P2-P3) THRU OMIT ISOLATION A(P1-P2) ISOLATION B(P1-P3) ISOLATION C(P2-P3) ISOLATION DONE xxx	CORR:COLL STAN1;*WAI CORR:COLL STAN2;*WAI CORR:COLL STAN3;*WAI CORR:COLL STAN4;*WAI CORR:COLL STAN5;*WAI CORR:COLL STAN6;*WAI CORR:COLL STAN7;*WAI CORR:COLL STAN8;*WAI CORR:COLL STAN9;*WAI CORR:COLL STAN10;*WAI CORR:COLL STAN11;*WAI CORR:COLL STAN12;*WAI CORR:COLL STAN13;*WAI CORR:COLL STAN14;*WAI CORR:COLL STAN15;*WAI CORR:COLL STAN16;*WAI CORR:COLL:SAVE	Invalid when DUPLEX 2 PORT  Invalid when DUPLEX 2 PORT DUPLEX,TRIPLEX,3-PORT

A.1 MEAS Extension and Calibration Function Extension

3. [SENSe:]CORRection[<chno>]:CKIT:TERMinal[<port>]
- Function Sets the male or female of the test port connector.
  - Presence of command and query Command/Query
  - New command
 

Command	[SENSe:]CORRection[<chno>]:CKIT:TERMinal[<port>]<type>
Parameter	<type> = {FEMale MALe}
Response type	FEMIMAL
  - Previous command
 

Command	PORT{1 2 3}{FEMIMAL}
Response type	0 1
  - Description Switches between the male and female settings of the test port connector when setting the CAL KIT for calibration.
  - CAUTION Sets the male or female for the test port, not for the CAL KIT.  
  
Sets the connector type of the CAL KIT using CORR:CKIT[:TYPE]<int> or CKIT{0|1|2|3|4|5}.
4. [SENSe:]CORRection[<chno>]:CKIT[:TYPE]
- Function Sets the CAL kit connector type.
  - Presence of command and query Command/Query
  - New command
 

Command	[SENSe:]CORRection[<chno>]:CKIT[:TYPE]<int>
Parameter	<int>
Response type	NR1 (Integer number)
  - Previous command
 

Command	CKIT{0 1 2 3 4 5}
Response type	0 1
  - Description Sets the CAL Kit connector type used when setting the CAL kit for calibration.

## A.1 MEAS Extension and Calibration Function Extension

Previous command	New command parameter	Connector type
CKIT0	0	Don't care
CKIT1	1	N type (50Ω) (male or female)
CKIT2	2	N type (75Ω) (male or female)
CKIT3	3	3.5mm (male or female)
CKIT4	4	7mm
CKIT5	5	User defines

- **CAUTION** The `CORR:CKIT:TERM {FEMIMAL}` or `PORT{1|2|3}{FEMIMAL}` sets the male or female setting for the connector.

## 5. [SENSe:]CORRection[&lt;chno&gt;]:PEXTension:TIME[&lt;eport&gt;]

- **Function** Setting correction value of reference plane extension
- **Presence of command and query** Command/Query
- **New command** [SENSe:]CORRection[<chno>]:PEXTension:TIME[<eport>] <real>
- **Previous command** EPORT{RIAIBI1|2|3}<real>
- **Parameter** <real>
- **Response type** NR3 (real value)
- **Description** Sets the value of the reference plane extension.

The command corrects the extension in accordance with the input port. While the electrical length correction simply corrects the set value, this command corrects in accordance with input conditions by setting the value corresponding to the input port.

For example, the command automatically sets the correction value to two times the port extension value for reflection measurements, and one time the port extension value for transfer measurements.

A.1 MEAS Extension and Calibration Function Extension

6. [SENSe:]CORrection[<chno>]:SLOPe:PHASe

- Function                      Sets Phase slope.
- Presence of command and query  
                                    Command/Query
- New command                [SENSe:]CORrection[<chno>]:SLOPe:PHASe<real>
- Previous command         PHASLO<real>
- Parameter                    <real>
- Response type              NR3 (Real number)
- Description                 Sets the Phase slope value (degree).  
                                    Adds a phase slope value to the phase data so that the  
                                    starting point is 0° and the ending point is the specified phase  
                                    value.  
                                    This slope is not related to frequencies and is linearly  
                                    calculated at the points.

7. [SENSe:]CORRection[<chno>]:CKIT:DEFine:SAVE

- Function                      Saves the set STD value in USER-DEFINE.
- Presence of command and query  
                                    Command
- New command                [SENSe:]CORRection[<chno>]:CKIT:DEFine:SAVE
- Previous command         STDSAVE
- Description                 Saves (registers) each STD value set by CORR: CKIT:DEF:  
                                    STN... or STD{1|2|3}... as USER-DEFINE.

8. [SENSe:]CORRection[<chno>]:CKIT:DEFine:STANdard[<port>]:OCAPacitance[<n>]

- Function                      Sets the open capacitance of the open standard.
- Presence of command and query  
                                    Command/Query
- New command                [SENSe:]CORRection[<chno>]:CKIT:DEFine:STANdard[<port>]:  
                                    OCAPacitance[<n>]<real>
- Previous command         STD{1|2|3}C{0|1|2|3}<real>

## A.1 MEAS Extension and Calibration Function Extension

- Parameter <real>
- Response type NR3 (Real number)
- Description Sets open capacitance of the open standard (CAL kit).

Previous command	New command<n>	Setting range
STD{1 2 3}C0	0	$\pm 10k (10^{\wedge} - 15F)$
STD{1 2 3}C1	1	$\pm 10k (10^{\wedge} - 27F/Hz)$
STD{1 2 3}C2	2	$\pm 10k (10^{\wedge} - 36F/Hz^{\wedge}2)$
STD{1 2 3}C3	3	$\pm 10k (10^{\wedge} - 45F/Hz^{\wedge}3)$

- CAUTION When the following operation is executed without performing CORR:CKIT:DEF:SAVE or STDSAVE after a setting has been made, the set value will be lost.

9. [SENSe:]CORRection[<chno>]:CKIT:DEFine:STANdard[<port>]:ODELay

- Function Sets the electrical length (time) of the open standard.
- Presence of command and query Command/Query
- New command [SENSe:]CORRection[<chno>]:CKIT:DEFine:STANdard[<port>]:ODELay<real>
- Previous command STD{1|2|3}ODEL<real>
- Parameter <real>
- Response type NR3 (Real number)
- Description Sets the electrical length of the open standard (CAL kit) in time.
- CAUTION When the following operation is executed without performing CORR:CKIT:DEF:SAVE or STDSAVE after a setting has been made, the set value will be lost.

A.1 MEAS Extension and Calibration Function Extension

10. [SENSe:]CORRection[<chno>]:CKIT:DEFine:STANdard[<port>]:OLOSSs

- Function                      Sets the loss of the open standard.
- Presence of command and query  
                                    Command/Query
- New command                 [SENSe:]CORRection[<chno>]:CKIT:DEFine:STANdard[<port>]:  
                                    OLOSSs<real>
- Previous command          STD{1|2|3}OLOS<real>
- Parameter                     <real>
- Response type                NR3 (Real number)
- Description                  Sets the loss ( $\Omega$ /sec) of the open standard (CAL kit).
- CAUTION                      When the following operation is executed without performing  
                                    CORR:CKIT:DEF:SAVE or STDSAVE after a setting has been  
                                    made, the set value will be lost.

11. [SENSe:]CORRection[<chno>]:CKIT:DEFine:STANdard[<port>]:OIMPedance

- Function                      Sets the impedance ( $Z_0$ ) of the open standard.
- Presence of command and query  
                                    Command/Query
- New command                 [SENSe:]CORRection[<chno>]:CKIT:DEFine:STANdard[<port>]:  
                                    OIMPedance<real>
- Previous command          STD{1|2|3}OIMP<real>
- Parameter                     <real>
- Response type                NR3 (Real number)
- Description                  Sets the impedance ( $Z_0$ ) of the open standard (CAL kit).
- CAUTION                      When the following operation is executed without performing  
                                    CORR:CKIT:DEF:SAVE or STDSAVE after a setting has been  
                                    made, the set value will be lost.



## 12. [SENSe:]CORRection[&lt;chno&gt;]:CKIT:DEFine:STANdard[&lt;port&gt;]:SDELay

- Function Sets the electrical length (time) of the short standard.
- Presence of command and query  
Command/Query
- New command [SENSe:]CORRection[<chno>]:CKIT:DEFine:STANdard[<port>]:  
SDELay<real>
- Previous command STD{1|2|3}SDEL<real>
- Parameter <real>
- Response type NR3 (Real number)
- Description Sets the electrical length of the short standard (CAL kit) in time.
- CAUTION When the following operation is executed without performing CORR:CKIT:DEF:SAVE or STDSAVE after a setting has been made, the set value will be lost.

## 13. [SENSe:]CORRection[&lt;chno&gt;]:CKIT:DEFine:STANdard[&lt;port&gt;]:SLOSs

- Function Sets the loss of the short standard.
- Presence of command and query  
Command/Query
- New command [SENSe:]CORRection[<chno>]:CKIT:DEFine:STANdard[<port>]:  
SLOSs<real>
- Previous command STD{1|2|3}SLOS<real>
- Parameter <real>
- Response type NR3 (Real number)
- Description Sets the loss (/sec) of the short standard (CAL kit).
- CAUTION When the following operation is executed without performing CORR:CKIT:DEF:SAVE or STDSAVE after a setting has been made, the set value will be lost.

A.1 MEAS Extension and Calibration Function Extension

14. [SENSe:]CORRection[<chno>]:CKIT:DEFine:STANdard[<port>]:SIMPedance

- Function Sets the impedance (Z0) of the short standard.
- Presence of command and query  
Command/Query
- New command [SENSe:]CORRection[<chno>]:CKIT:DEFine:STANdard[<port>]:SIMPedance<real>
- Previous command STD{1|2|3}SIMP<real>
- Parameter <real>
- Response type NR3 (Real number)
- Description Sets the impedance (Z0) of the short standard (CAL kit).
- CAUTION When the following operation is executed without performing CORR:CKIT:DEF:SAVE or STDSAVE after a setting has been made, the set value will be lost.

15. [SENSe:]CORRection[<chno>]:CKIT:DEFine:STANdard[<port>]:TDElay

- Function Sets the electrical length (time) of the thru standard.
- Presence of command and query  
Command/Query
- New command [SENSe:]CORRection[<chno>]:CKIT:DEFine:STANdard[<port>]:TDElay<real>
- Previous command STD{1|2|3}TDEL<real>
- Parameter <real>
- Response type NR3 (Real number)
- Description Sets the electrical length of the thru standard (CAL kit) in time.

Previous command	New command<port>	Corresponding port
STD1TDEL	1	Between PORT1 and PORT2
STD2TDEL	2	Between PORT1 and PORT3
STD3TDEL	3	Between PORT2 and PORT3

A.1 MEAS Extension and Calibration Function Extension

- CAUTION When the following operation is executed without performing CORR:CKIT:DEF:SAVE or STDSAVE after a setting has been made, the set value will be lost.

16. [SENSe:]CORRection[<chno>]:CKIT:DEFine:STANdard[<port>]:TLOSs

- Function Sets the loss of the thru standard.
- Presence of command and query Command/Query
- New command [SENSe:]CORRection[<chno>]:CKIT:DEFine:STANdard[<port>]:TLOSs<real>
- Previous command STD{1|2|3}TLOS<real>
- Parameter <real>
- Response type NR3 (Real number)
- Description Sets the loss ( $\Omega$ /sec) of the thru standard (CAL kit).

Previous command	New command<port>	Corresponding port
STD1TLOS	1	Between PORT1 and PORT2
STD2TLOS	2	Between PORT1 and PORT3
STD3TLOS	3	Between PORT2 and PORT3

- CAUTION When the following operation is executed without performing CORR:CKIT:DEF:SAVE or STDSAVE after a setting has been made, the set value will be lost.

17. [SENSe:]CORRection[<chno>]:CKIT:DEFine:STANdard[<port>]:TIMPedance

- Function Sets the impedance ( $Z_0$ ) of the thru standard.
- Presence of command and query Command/Query
- New command [SENSe:]CORRection[<chno>]:CKIT:DEFine:STANdard[<port>]:TIMPedance<real>
- Previous command STD{1|2|3}TIMP<real>
- Parameter <real>
- Response type NR3 (Real number)

A.1 MEAS Extension and Calibration Function Extension

- Description                      Sets the impedance (Z0) of the thru standard (CAL kit).

Previous command	New command<port>	Corresponding port
STD1TIMP	1	Between PORT1 and PORT2
STD2TIMP	2	Between PORT1 and PORT3
STD3TIMP	3	Between PORT2 and PORT3

- CAUTION                              When the following operation is executed without performing CORR:CKIT:DEF:SAVE or STDSAVE after a setting has been made, the set value will be lost.

# EXTERNAL VIEWS

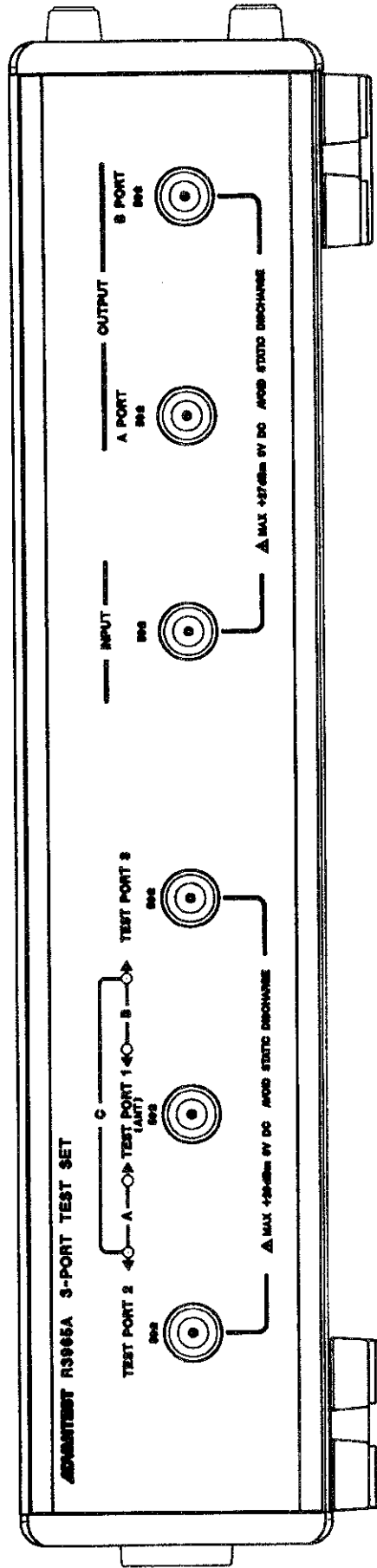

R3965A FRONT VIEW

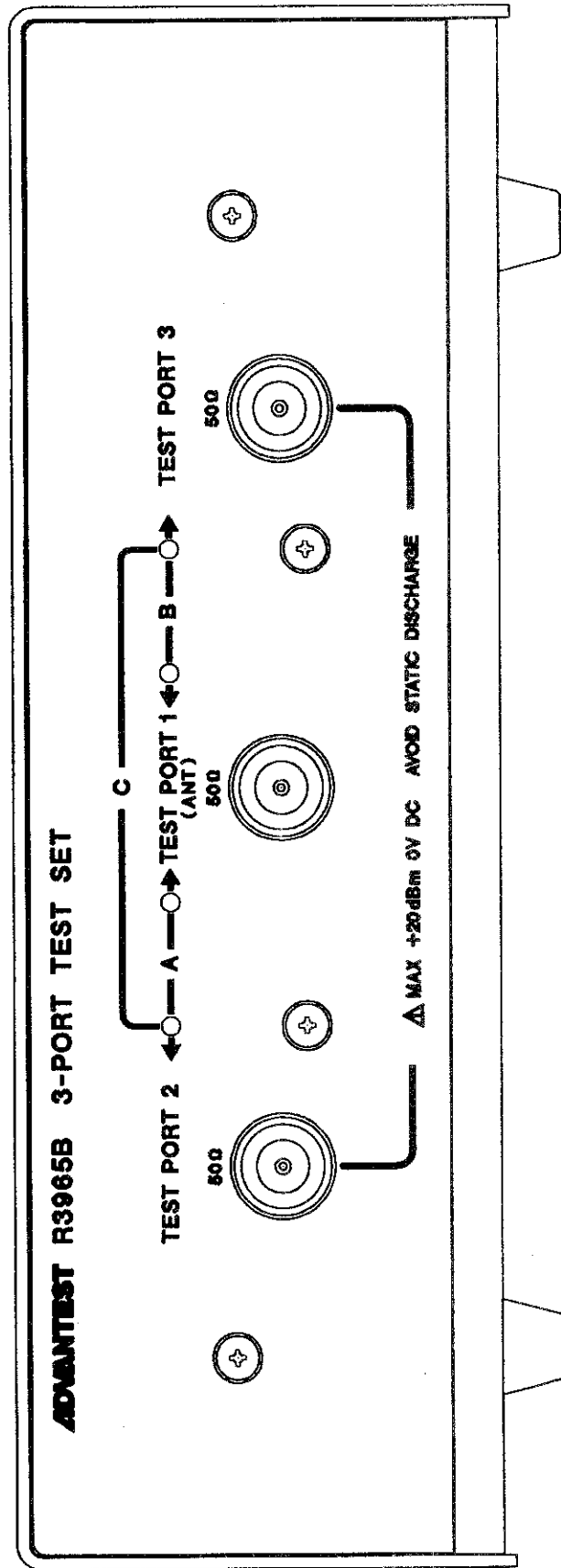

R3965B FRONT VIEW

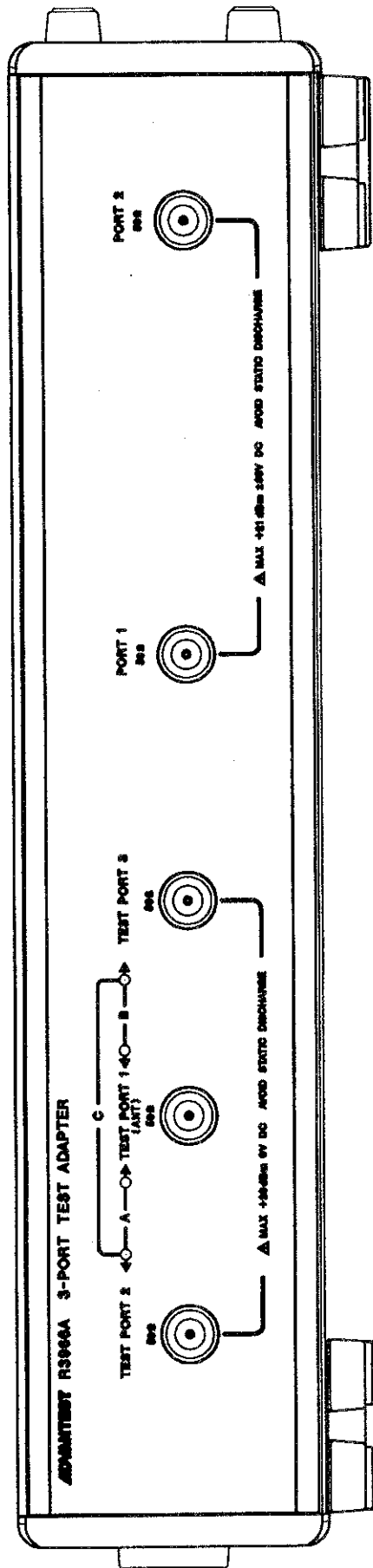

R3966A FRONT VIEW

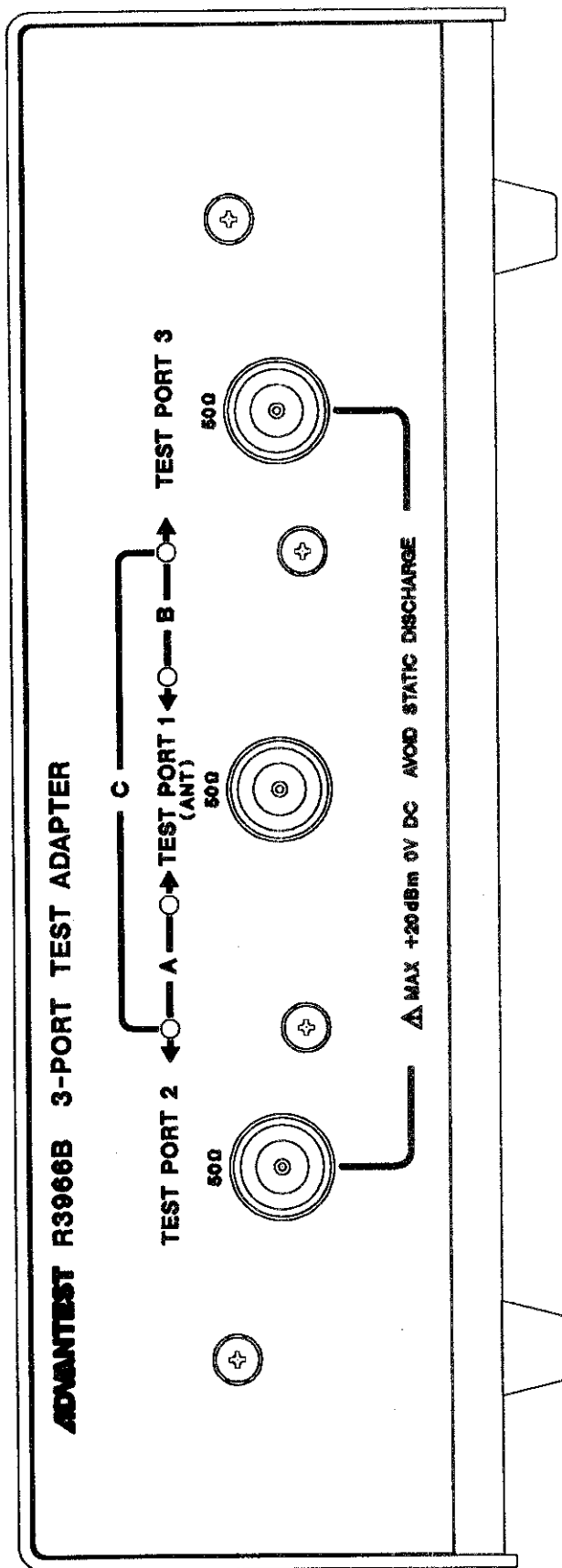

R3966B FRONT VIEW



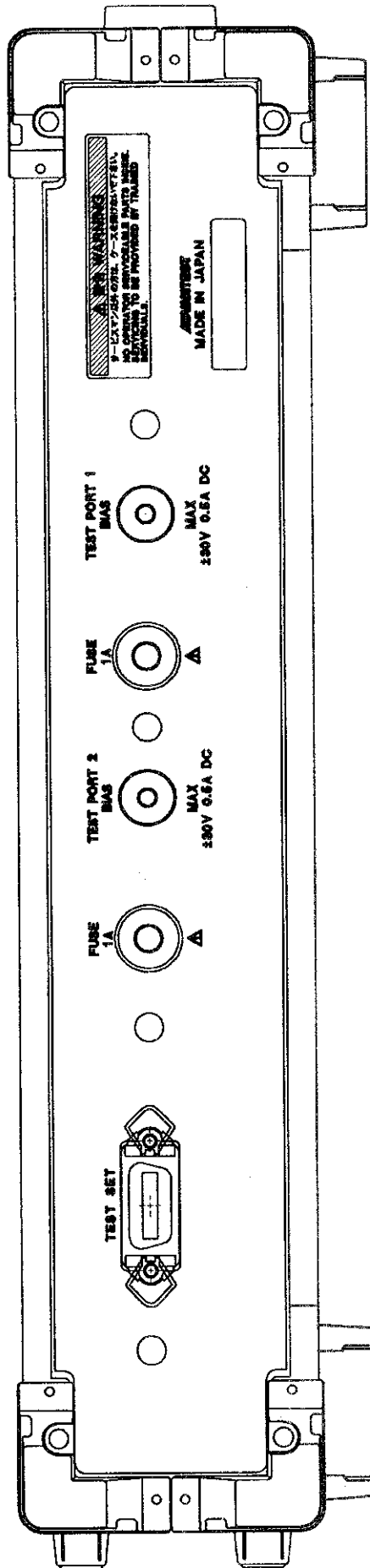

**R3965A/66A REAR VIEW**

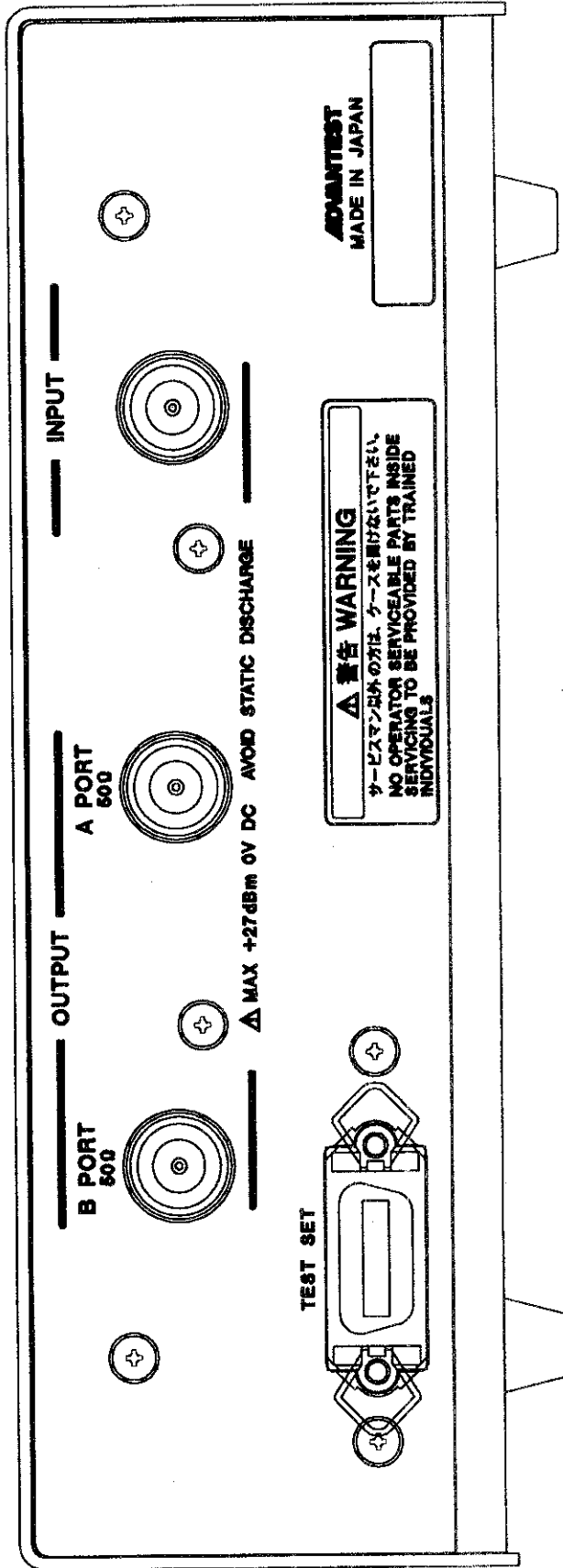

R3965B REAR VIEW

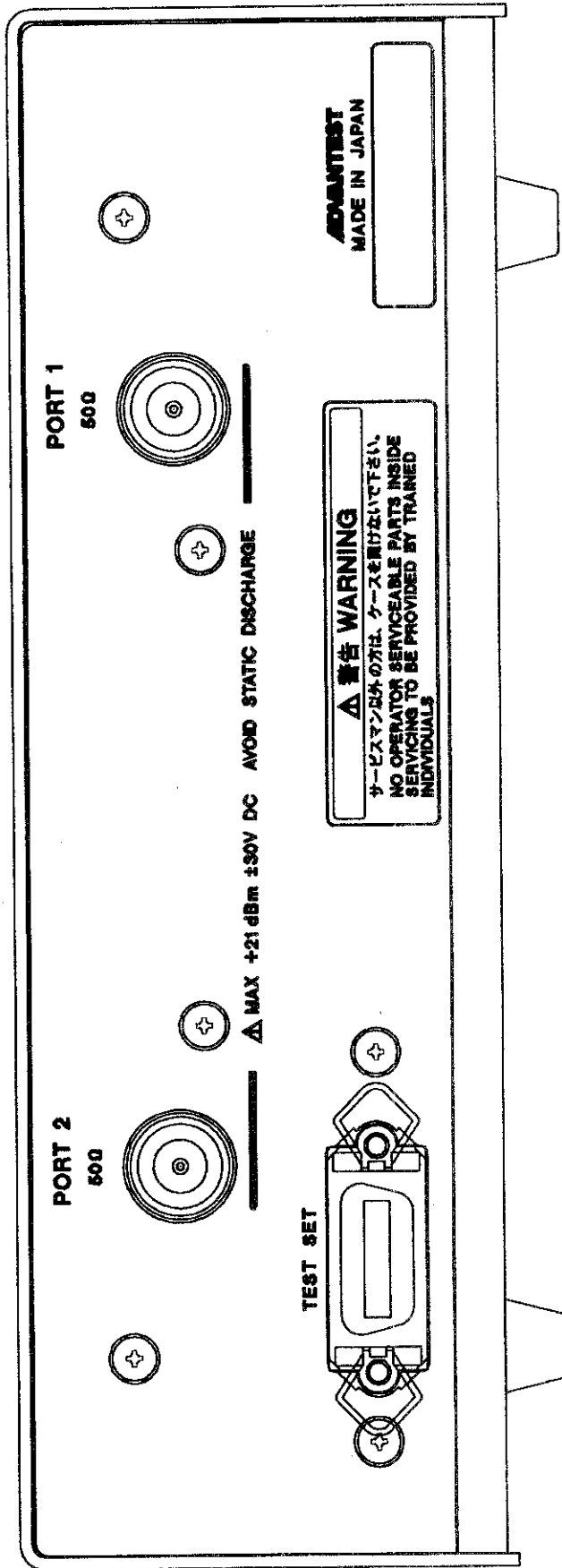

R3966B REAR VIEW



## ALPHABETICAL INDEX

<b>[A]</b>		<b>[P]</b>	
Accessories .....	1-3	PANEL DESCRIPTION .....	2-1
APPENDIX .....	A-1	PERFORMANCE TESTS .....	6-1
Attachments .....	1-2	PORT1 Reflection Calibration Using the Load Standard .....	4-3
<b>[B]</b>		PORT1 Reflection Calibration Using the Open Standard .....	4-2
BASIC MEASUREMENTS .....	4-1	PORT1 Reflection Calibration Using the Short Standard .....	4-3
<b>[C]</b>		Precautions .....	1-1
Calibration .....	4-2	Preparations for the Tests .....	6-1
Calibration function extension .....	A-2	Products Overview .....	1-1
CONNECTING THE R3965/66 TO A NETWORK ANALYZER .....	3-1	<b>[R]</b>	
Control Cable Connection .....	3-3	R3965A/B Operation Block Diagram .....	5-4
<b>[D]</b>		R3966A/B Operation Block Diagram .....	5-7
Directivity .....	6-2	Rear Panel Description .....	2-3
<b>[F]</b>		Reflection Magnitude .....	6-12
Frequency Characteristics .....	6-9	Relationship between the New and Previous MEAS Commands ..	A-6
Front Panel Description .....	2-1	Relationship between the Panel Menu and the STAN Command ..	A-9
FULL 3 PORT CAL .....	A-2	RF Cable Connection .....	3-1
<b>[G]</b>		<b>[S]</b>	
GPIB codes .....	A-5	SPECIFICATIONS .....	7-1
<b>[I]</b>		Specifications of R3965A/B .....	7-1
Insertion Loss .....	6-15	Specifications of R3966A/B .....	7-3
Instrument Preparation .....	6-1	Standard Attachments .....	1-2
Isolation .....	6-21	<b>[T]</b>	
<b>[M]</b>		Test Port Load Match .....	6-4
MEAS extension .....	A-1	Transmission Characteristics between TEST PORT1 and TEST PORT2 ..	4-11
Measurement Examples .....	4-10	Transmission Characteristics between TEST PORT1 and TEST PORT3 ..	4-12
Measurement Overview .....	4-1	Transmission Characteristics between TEST PORT2 and TEST PORT3 ..	4-13
method of measuring transmission Characteristics .....	4-10	Transmission Magnitude .....	6-9
<b>[O]</b>		TRIPLEX 2 PORT CAL .....	A-2
OPERATION DESCRIPTION .....	5-1	TRIPLEX 2PORT (PORT1 to PORT2) Isolation Calibration .....	4-7
Operation of R3965A/B .....	5-1	TRIPLEX 2PORT (PORT1 to PORT2) Transmission Characteristics .....	4-5
Operation of R3966A/B .....	5-5	TRIPLEX 2PORT (PORT1) Reflection Calibration .....	4-4
OUTLINE .....	1-1	TRIPLEX 2PORT CAL .....	4-2
		TRIPLEX 2PORT Calibration .....	4-9

Alphabetical Index

TRIPLEX 2PORT Isolation Calibration ..	4-8
TRIPLEX 2PORT Transmission Calibration	4-6

**[W]**

Warm-up .....	6-1
---------------	-----

## **IMPORTANT INFORMATION FOR ADVANTEST SOFTWARE**

PLEASE READ CAREFULLY: This is an important notice for the software defined herein. Computer programs including any additions, modifications and updates thereof, operation manuals, and related materials provided by Advantest (hereafter referred to as "SOFTWARE"), included in or used with hardware produced by Advantest (hereafter referred to as "PRODUCTS").

### **SOFTWARE License**

All rights in and to the SOFTWARE (including, but not limited to, copyright) shall be and remain vested in Advantest. Advantest hereby grants you a license to use the SOFTWARE only on or with Advantest PRODUCTS.

### **Restrictions**

- (1) You may not use the SOFTWARE for any purpose other than for the use of the PRODUCTS.
- (2) You may not copy, modify, or change, all or any part of, the SOFTWARE without permission from Advantest.
- (3) You may not reverse engineer, de-compile, or disassemble, all or any part of, the SOFTWARE.

### **Liability**

Advantest shall have no liability (1) for any PRODUCT failures, which may arise out of any misuse (misuse is deemed to be use of the SOFTWARE for purposes other than its intended use) of the SOFTWARE. (2) For any dispute between you and any third party for any reason whatsoever including, but not limited to, infringement of intellectual property rights.

## LIMITED WARRANTY

1. Unless otherwise specifically agreed by Seller and Purchaser in writing, Advantest will warrant to the Purchaser that during the Warranty Period this Product (other than consumables included in the Product) will be free from defects in material and workmanship and shall conform to the specifications set forth in this Operation Manual.
2. The warranty period for the Product (the "Warranty Period") will be a period of one year commencing on the delivery date of the Product.
3. If the Product is found to be defective during the Warranty Period, Advantest will, at its option and in its sole and absolute discretion, either (a) repair the defective Product or part or component thereof or (b) replace the defective Product or part or component thereof, in either case at Advantest's sole cost and expense.
4. This limited warranty will not apply to defects or damage to the Product or any part or component thereof resulting from any of the following:
  - (a) any modifications, maintenance or repairs other than modifications, maintenance or repairs (i) performed by Advantest or (ii) specifically recommended or authorized by Advantest and performed in accordance with Advantest's instructions;
  - (b) any improper or inadequate handling, carriage or storage of the Product by the Purchaser or any third party (other than Advantest or its agents);
  - (c) use of the Product under operating conditions or environments different than those specified in the Operation Manual or recommended by Advantest, including, without limitation, (i) instances where the Product has been subjected to physical stress or electrical voltage exceeding the permissible range and (ii) instances where the corrosion of electrical circuits or other deterioration was accelerated by exposure to corrosive gases or dusty environments;
  - (d) use of the Product in connection with software, interfaces, products or parts other than software, interfaces, products or parts supplied or recommended by Advantest;
  - (e) incorporation in the Product of any parts or components (i) provided by Purchaser or (ii) provided by a third party at the request or direction of Purchaser or due to specifications or designs supplied by Purchaser (including, without limitation, any degradation in performance of such parts or components);
  - (f) Advantest's incorporation or use of any specifications or designs supplied by Purchaser;
  - (g) the occurrence of an event of force majeure, including, without limitation, fire, explosion, geological change, storm, flood, earthquake, tidal wave, lightning or act of war; or
  - (h) any negligent act or omission of the Purchaser or any third party other than Advantest.
5. **EXCEPT TO THE EXTENT EXPRESSLY PROVIDED HEREIN, ADVANTEST HEREBY EXPRESSLY DISCLAIMS, AND THE PURCHASER HEREBY WAIVES, ALL WARRANTIES, WHETHER EXPRESS OR IMPLIED, STATUTORY OR OTHERWISE, INCLUDING, WITHOUT LIMITATION, (A) ANY WARRANTY OF MERCHANTABILITY OR FITNESS FOR A PARTICULAR PURPOSE AND (B) ANY WARRANTY OR REPRESENTATION AS TO THE VALIDITY, SCOPE, EFFECTIVENESS OR USEFULNESS OF ANY TECHNOLOGY OR ANY INVENTION.**
6. **THE REMEDY SET FORTH HEREIN SHALL BE THE SOLE AND EXCLUSIVE REMEDY OF THE PURCHASER FOR BREACH OF WARRANTY WITH RESPECT TO THE PRODUCT.**
7. **ADVANTEST WILL NOT HAVE ANY LIABILITY TO THE PURCHASER FOR ANY INDIRECT, INCIDENTAL, SPECIAL, CONSEQUENTIAL OR PUNITIVE DAMAGES, INCLUDING, WITHOUT LIMITATION, LOSS OF ANTICIPATED PROFITS OR REVENUES, IN ANY AND ALL CIRCUMSTANCES, EVEN IF ADVANTEST HAS BEEN ADVISED OF THE POSSIBILITY OF SUCH DAMAGES AND WHETHER ARISING OUT OF BREACH OF CONTRACT, WARRANTY, TORT (INCLUDING, WITHOUT LIMITATION, NEGLIGENCE), STRICT LIABILITY, INDEMNITY, CONTRIBUTION OR OTHERWISE. TORT (INCLUDING, WITHOUT LIMITATION, NEGLIGENCE), STRICT LIABILITY, INDEMNITY, CONTRIBUTION OR OTHERWISE.**
8. **OTHER THAN THE REMEDY FOR THE BREACH OF WARRANTY SET FORTH HEREIN, ADVANTEST SHALL NOT BE LIABLE FOR, AND HEREBY DISCLAIMS TO THE FULLEST EXTENT PERMITTED BY LAW ANY LIABILITY FOR, DAMAGES FOR PRODUCT FAILURE OR DEFECT, WHETHER ARISING OUT OF BREACH OF CONTRACT, TORT (INCLUDING, WITHOUT LIMITATION, NEGLIGENCE), STRICT LIABILITY, INDEMNITY, CONTRIBUTION OR OTHERWISE.**



## **CUSTOMER SERVICE DESCRIPTION**

In order to maintain safe and trouble-free operation of the Product and to prevent the incurrence of unnecessary costs and expenses, Advantest recommends a regular preventive maintenance program under its maintenance agreement.

Advantest's maintenance agreement provides the Purchaser on-site and off-site maintenance, parts, maintenance machinery, regular inspections, and telephone support and will last a maximum of ten years from the date the delivery of the Product. For specific details of the services provided under the maintenance agreement, please contact the nearest Advantest office listed at the end of this Operation Manual or Advantest's sales representatives.

Some of the components and parts of this Product have a limited operating life (such as, electrical and mechanical parts, fan motors, unit power supply, etc.). Accordingly, these components and parts will have to be replaced on a periodic basis. If the operating life of a component or part has expired and such component or part has not been replaced, there is a possibility that the Product will not perform properly. Additionally, if the operating life of a component or part has expired and continued use of such component or part damages the Product, the Product may not be repairable. Please contact the nearest Advantest office listed at the end of this Operation Manual or Advantest's sales representatives to determine the operating life of a specific component or part, as the operating life may vary depending on various factors such as operating condition and usage environment.

## SALES & SUPPORT OFFICES

Advantest Korea Co., Ltd.

22BF, Kyobo KangNam Tower,  
1303-22, Seocho-Dong, Seocho-Ku, Seoul #137-070, Korea  
Phone: +82-2-532-7071  
Fax: +82-2-532-7132

Advantest (Suzhou) Co., Ltd.

Shanghai Branch Office:  
Bldg. 6D, NO.1188 Gumei Road, Shanghai, China 201102 P.R.C.  
Phone: +86-21-6485-2725  
Fax: +86-21-6485-2726

Shanghai Branch Office:  
406/F, Ying Building, Quantum Plaza, No. 23 Zhi Chun Road,  
Hai Dian District, Beijing,  
China 100083  
Phone: +86-10-8235-3377  
Fax: +86-10-8235-6717

Advantest (Singapore) Pte. Ltd.

438A Alexandra Road, #08-03/06  
Alexandra Technopark Singapore 119967  
Phone: +65-6274-3100  
Fax: +65-6274-4055

Advantest America, Inc.

3201 Scott Boulevard, Suite, Santa Clara, CA 95054, U.S.A  
Phone: +1-408-988-7700  
Fax: +1-408-987-0691

ROHDE & SCHWARZ Europe GmbH

Mühldorfstraße 15 D-81671 München, Germany  
(P.O.B. 80 14 60 D-81614 München, Germany)  
Phone: +49-89-4129-13711  
Fax: +49-89-4129-13723

**ADVANTEST**<sup>®</sup>

<http://www.advantest.co.jp>