ADVANTEST[®]
ADVANTEST CORPORATION

Q8155
Tunable Light Source
Operation Manual

MANUAL NUMBER FOE-8370696B01

Safety Summary

To ensure thorough understanding of all functions and to ensure efficient use of this instrument, please read the manual carefully before using. Note that Advantest bears absolutely no responsibility for the result of operations caused due to incorrect or inappropriate use of this instrument.

If the equipment is used in a manner not specified by Advantest, the protection provided by the equipment may be impaired.

- **Warning Labels**

Warning labels are applied to Advantest products in locations where specific dangers exist. Pay careful attention to these labels during handling. Do not remove or tear these labels. If you have any questions regarding warning labels, please ask your nearest Advantest dealer. Our address and phone number are listed at the end of this manual.

Symbols of those warning labels are shown below together with their meaning.

DANGER: Indicates an imminently hazardous situation which will result in death or serious personal injury.

WARNING: Indicates a potentially hazardous situation which will result in death or serious personal injury.

CAUTION: Indicates a potentially hazardous situation which will result in personal injury or a damage to property including the product.

- **Basic Precautions**

Please observe the following precautions to prevent fire, burn, electric shock, and personal injury.

- Use a power cable rated for the voltage in question. Be sure however to use a power cable conforming to safety standards of your nation when using a product overseas.
- When inserting the plug into the electrical outlet, first turn the power switch OFF and then insert the plug as far as it will go.
- When removing the plug from the electrical outlet, first turn the power switch OFF and then pull it out by gripping the plug. Do not pull on the power cable itself. Make sure your hands are dry at this time.
- Before turning on the power, be sure to check that the supply voltage matches the voltage requirements of the instrument.
- Connect the power cable to a power outlet that is connected to a protected ground terminal. Grounding will be defeated if you use an extension cord which does not include a protected ground terminal.
- Be sure to use fuses rated for the voltage in question.
- Do not use this instrument with the case open.
- Do not place anything on the product and do not apply excessive pressure to the product. Also, do not place flower pots or other containers containing liquid such as chemicals near this

Safety Summary

product.

- When the product has ventilation outlets, do not stick or drop metal or easily flammable objects into the ventilation outlets.
- When using the product on a cart, fix it with belts to avoid its drop.
- When connecting the product to peripheral equipment, turn the power off.

- **Caution Symbols Used Within this Manual**

Symbols indicating items requiring caution which are used in this manual are shown below together with their meaning.

DANGER: Indicates an item where there is a danger of serious personal injury (death or serious injury).

WARNING: Indicates an item relating to personal safety or health.

CAUTION: Indicates an item relating to possible damage to the product or instrument or relating to a restriction on operation.

- **Safety Marks on the Product**

The following safety marks can be found on Advantest products.



: ATTENTION - Refer to manual.



: Protective ground (earth) terminal.



: DANGER - High voltage.



: CAUTION - Risk of electric shock.

- **Replacing Parts with Limited Life**

The following parts used in the instrument are main parts with limited life.

Replace the parts listed below before their expected lifespan has expired to maintain the performance and function of the instrument.

Note that the estimated lifespan for the parts listed below may be shortened by factors such as the environment where the instrument is stored or used, and how often the instrument is used.

The parts inside are not user-replaceable. For a part replacement, please contact the Advantest sales office for servicing.

Each product may use parts with limited life.

For more information, refer to the section in this document where the parts with limited life are described.

Main Parts with Limited Life

Part name	Life
Unit power supply	5 years
Fan motor	5 years
Electrolytic capacitor	5 years
LCD display	6 years
LCD backlight	2.5 years
Floppy disk drive	5 years
Memory backup battery	5 years

- **Hard Disk Mounted Products**

The operational warnings are listed below.

- Do not move, shock and vibrate the product while the power is turned on.
Reading or writing data in the hard disk unit is performed with the memory disk turning at a high speed. It is a very delicate process.
- Store and operate the products under the following environmental conditions.
An area with no sudden temperature changes.
An area away from shock or vibrations.
An area free from moisture, dirt, or dust.
An area away from magnets or an instrument which generates a magnetic field.
- Make back-ups of important data.
The data stored in the disk may become damaged if the product is mishandled. The hard disc has a limited life span which depends on the operational conditions. Note that there is no guarantee for any loss of data.

- **Precautions when Disposing of this Instrument**

When disposing of harmful substances, be sure dispose of them properly with abiding by the state-provided law.

Harmful substances: (1) PCB (polycarbon biphenyl)
(2) Mercury
(3) Ni-Cd (nickel cadmium)
(4) Other
Items possessing cyan, organic phosphorous and hexadic chromium and items which may leak cadmium or arsenic (excluding lead in solder).

Example: fluorescent tubes, batteries

Environmental Conditions

This instrument should be only be used in an area which satisfies the following conditions:

- An area free from corrosive gas
- An area away from direct sunlight
- A dust-free area
- An area free from vibrations
- Altitude of up to 2000 m

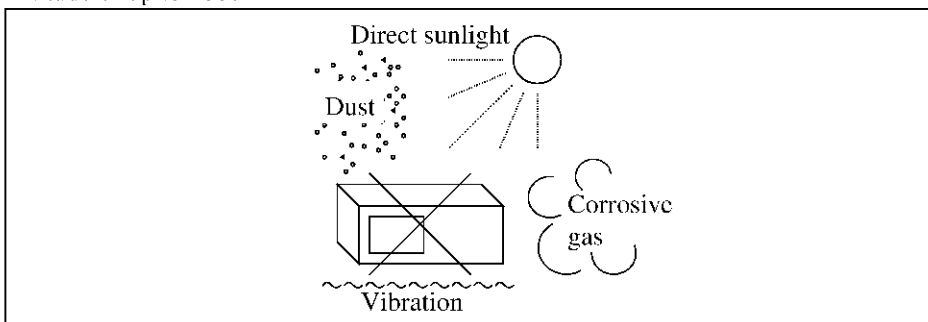

Figure-1 Environmental Conditions

- Operating position

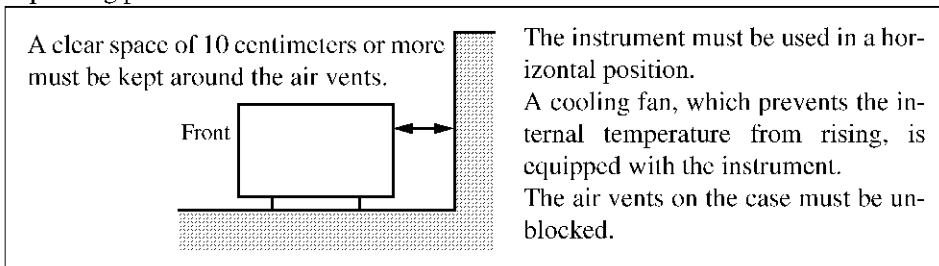

Figure-2 Operating Position

- Storage position

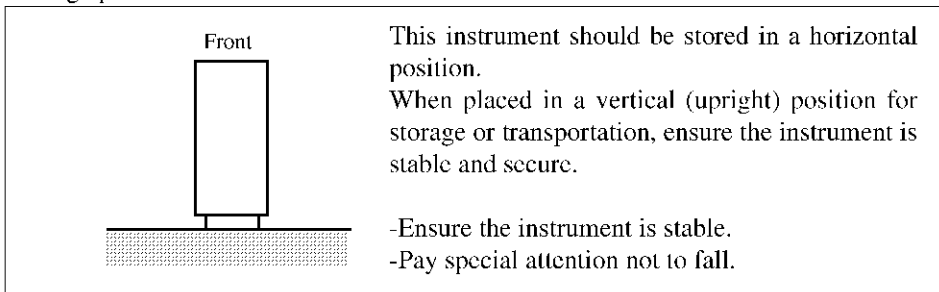

Figure-3 Storage Position

- The classification of the transient over-voltage, which exists typically in the main power supply, and the pollution degree is defined by IEC61010-1 and described below.

Impulse withstand voltage (over-voltage) category II defined by IEC60364-4-443

Pollution Degree 2

Types of Power Cable

Replace any references to the power cable type, according to the following table, with the appropriate power cable type for your country.

Plug configuration	Standards	Rating, color and length	Model number (Option number)
	PSE: Japan Electrical Appliance and Material Safety Law	125 V at 7 A Black 2 m (6 ft)	Straight: A01402 Angled: A01412
	UL: United States of America CSA: Canada	125 V at 7 A Black 2 m (6 ft)	Straight: A01403 (Option 95) Angled: A01413
	CEE: Europe DEMKO: Denmark NEMKO: Norway VDE: Germany KEMA: The Netherlands CEBEC: Belgium OVE: Austria FIMKO: Finland SEMKO: Sweden	250 V at 6 A Gray 2 m (6 ft)	Straight: A01404 (Option 96) Angled: A01414
	SEV: Switzerland	250 V at 6 A Gray 2 m (6 ft)	Straight: A01405 (Option 97) Angled: A01415
	SAA: Australia, New Zealand	250 V at 6 A Gray 2 m (6 ft)	Straight: A01406 (Option 98) Angled: -----
	BS: United Kingdom	250 V at 6 A Black 2 m (6 ft)	Straight: A01407 (Option 99) Angled: A01417
	CCC: China	250 V at 10 A Black 2 m (6 ft)	Straight: A114009 (Option 94) Angled: A114109

CAUTIONS ON USING THE Q8155

1. Information for the Safety of Laser Used in the Q8155

Laser Type	Fabry Perot-Laser InGaAsP
Laser Class	3A: IEC825-1, EN60825-1
Permissible Output Power	<10 mW
Beam Diameter	9 μm
Numerical Aperture	0.1
Wavelength	1525 nm to 1630 nm

2. Laser Warning Labels

The following laser warning labels are used on this instrument.



Warning label on the front panel of the instrument



Warning label on the top surface of the instrument



Warning label on the top surface of the instrument

Figure 1 Laser Product Label

CAUTIONS ON USING THE Q8155

3. CLASS 3A LASER PRODUCT Label

The Q8155 is a class 3A laser product. Class 3A laser product labels are provided as a standard accessory.

Attach the appropriate stickers from the label sheet for the country of use (see below).

Attach a label written in the appropriate language on the top surface of the instrument at the location indicated by "a" as shown in Figure 3.

INTERNATIONAL LASER WARNING LABELS

JAPANESE	FOR: JAPAN
<p style="text-align: center;">不可視レーザー放射</p> <p style="text-align: center;">ビームをのぞき込まないこと 光学機器で直接ビームを見ないこと</p> <p style="text-align: center;">最大出力: +10mW 波長: 1525 - 1630nm</p> <p style="text-align: center;">クラス3Aレーザー製品</p> <p style="text-align: center;">IEC825-1:1993; EN60825-1:1994</p>	
ENGLISH	FOR: UK NORWAY SWEDEN DENMARK BELGIUM NETHERLANDS
<p style="text-align: center;">INVISIBLE LASER RADIATION</p> <p style="text-align: center;">DO NOT STARE INTO BEAM OR VIEW DIRECTLY WITH OPTICAL INSTRUMENTS</p> <p style="text-align: center;">MAX. OUTPUT: +10mW WAVELENGTH: 1525 - 1630nm</p> <p style="text-align: center;">CLASS 3A LASER PRODUCT</p> <p style="text-align: center;">IEC825-1:1993; EN60825-1:1994</p>	
FRENCH	FOR: FRANCE BELGIUM SWITZERLAND
<p style="text-align: center;">INVISIBLE RAYONNEMENT LASER</p> <p style="text-align: center;">NE PAS REGARDER DANS LE FAISCEAU NI À L'ŒIL NU NI À L'AIDE D'UN INSTRUMENT D'OPTIQUE</p> <p style="text-align: center;">PUISSANCE MAX: +10mW LONGUEUR D'ONDE: 1525 - 1630nm</p> <p style="text-align: center;">APPAREIL À LASER DE CLASSE 3A</p> <p style="text-align: center;">IEC825-1:1993; EN60825-1:1994</p>	
GERMAN	FOR: GERMANY BELGIUM SWITZERLAND AUSTRIA
<p style="text-align: center;">UNSIICHTBAR LASERSTRAHLUNG</p> <p style="text-align: center;">NICHT IN DEN STRAHL BLICKEN ODER DIREKT MIT OPTISCHEN INSTRUMENTEN BETRACHTEN!</p> <p style="text-align: center;">MAX. LEISTUNG: +10mW WELLENLÄNGE: 1525 - 1630nm</p> <p style="text-align: center;">LASERKLASSE 3A</p> <p style="text-align: center;">IEC825-1:1993; EN60825-1:1994</p>	
SPANISH	FOR: SPAIN
<p style="text-align: center;">INVISIBLE RADIACION LASER</p> <p style="text-align: center;">NO FIJAR LA MIRADA EN EL HAZ DE RAYOS NI EXAMINARLO DIRECTAMENTE CON APARATOS OPTICOS</p> <p style="text-align: center;">MAX. POTENCIA: +10mW LONGITUD DE ONDA: 1525 - 1630nm</p> <p style="text-align: center;">PRODUCTO LASER DE CLASE 3A</p> <p style="text-align: center;">IEC825-1:1993; EN60825-1:1994</p>	
ITALIAN	FOR: ITALY SWITZERLAND
<p style="text-align: center;">INVISIBLE RADIAZIONE LASER</p> <p style="text-align: center;">NON GUARDARE DIRETTAMENTE NEL FASCIO AD OCCHIO NUDO O CON STRUMENTI OTTICI</p> <p style="text-align: center;">POTENZA MASSIMA: +10mW LUNGHEZZA D'ONDA: 1525 - 1630nm</p> <p style="text-align: center;">APPARECCHIO LASER DI CLASSE 3A</p> <p style="text-align: center;">IEC825-1:1993; EN60825-1:1994</p>	
FINNISH	FOR: FINLAND
<p style="text-align: center;">MÄKYMATÖN LASERSÄTELYÄ</p> <p style="text-align: center;">ÄLÄ TUJOTA SÄTEESEEN ÄLÄKÄ KATSO SITÄ OPTISEN LAITTEEN LÄPI</p> <p style="text-align: center;">SUURIMMÄINEN MAKS.: +10mW AALONPITUUS: 1525 - 1630nm</p> <p style="text-align: center;">LUOKAN 3A LASER</p> <p style="text-align: center;">IEC825-1:1993; EN60825-1:1994</p>	

PLEASE NOTE
SWITZERLAND MAY REQUIRE FRENCH, GERMAN, OR ITALIAN LABELING.
BELGIUM MAY REQUIRE ENGLISH, FRENCH, OR GERMAN LABELING.

MNS-L2872 001

Figure 2 CLASS 3A LASER PRODUCT Label

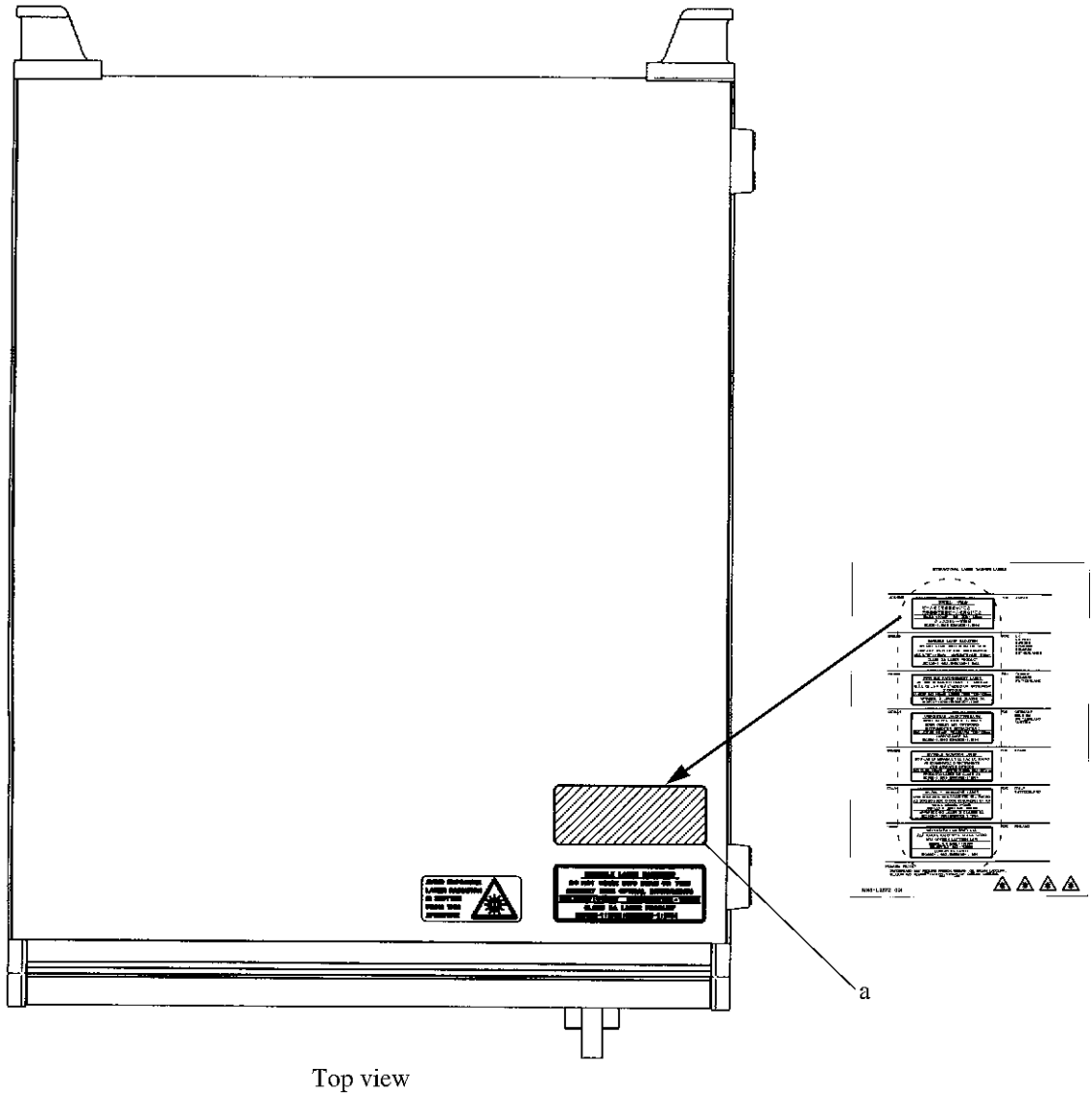
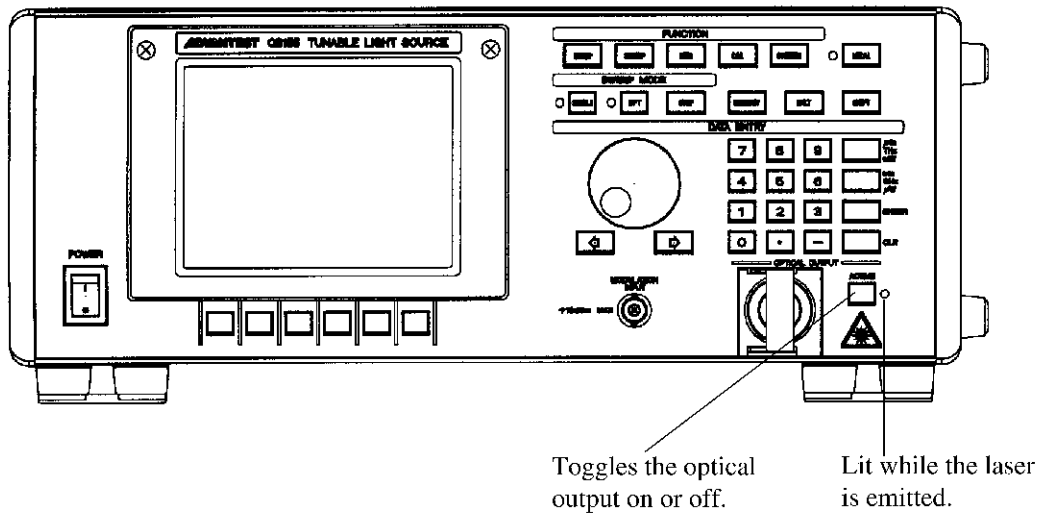

Figure 3 Where the Labels Are Affixed

CAUTIONS ON USING THE Q8155

4. Warnings on the Laser

1. Never attempt to emit a laser beam when no fiber is connected to the optical output connector on the front panel.



2. Never attempt to look into the optical output connector to observe the emitted laser beam. While the laser beam is emitted, never attempt to look into the optical fiber cord at the end, because an invisible light is emitted. The invisible light may seriously damage your eyesight.
3. Never attempt to look into the optical output connector or the end of optical fiber cord to observe the emitted laser beam using an optical instrument. Your eyesight may be seriously damaged.
4. Use of controls or adjustments or performance of procedures other than those specified herein may result in hazardous radiation exposure.
5. Do not attempt to open the unit. The unit should be serviced only by ADVANTEST representatives. ADVANTEST assumes no responsibility for any damage caused by unauthorized service.

TABLE OF CONTENTS

1.	INTRODUCTION	1-1
1.1	Product Description	1-1
1.2	Standard Accessories and Optional Accessories	1-2
1.2.1	Standard Accessories	1-2
1.2.2	Accessories	1-2
1.3	Operating Environment	1-4
1.3.1	Environmental Conditions	1-4
1.3.2	Power Supply Specifications	1-5
1.3.3	Power Fuse	1-5
1.3.4	Power Cable	1-6
1.4	Precautions in Use	1-7
1.5	System Checkout	1-8
1.5.1	Instruments Required for the System Checkout	1-8
1.5.2	Errors and Alarms	1-12
1.6	Cleaning, Storing and Transporting the Q8155	1-13
1.6.1	Cleaning and Replacement of Optical Connectors and Adapters	1-13
1.6.2	Cleaning	1-14
1.6.3	Storing	1-14
1.6.4	Transporting	1-14
1.7	Warming up	1-15
1.8	Calibration	1-15
1.9	Part Life Spans	1-15
2.	OPERATION	2-1
2.1	Description of Panels	2-1
2.1.1	Front Panel	2-1
2.1.1.1	FUNCTION Section	2-2
2.1.1.2	SWEEP Mode Section	2-2
2.1.1.3	DATA ENTRY Section	2-3
2.1.1.4	GPIB Section	2-4
2.1.1.5	Display Section	2-4
2.1.1.6	I/O Port Section	2-5
2.1.1.7	Power Switch Section	2-5
2.1.1.8	Other Sections	2-6
2.1.2	Rear Panel	2-7
2.1.3	Screen Annotation	2-8
2.2	Basic Operation	2-9
2.2.1	Menu Operation and Data Entry	2-9
2.2.2	FUNCTION Mode	2-11
2.3	CW Optical Output Power	2-15
2.4	Performing Sweeping in SWEEP Mode	2-17
2.4.1	Procedure Used with Single Sweep Mode	2-17
2.4.2	Procedure Used with Repeat Sweep Mode	2-18
2.4.3	Procedure Used with Single Step Mode	2-19
2.5	Modulated Signal Setup	2-20

Table of Contents

2.5.1	Setting the Low-frequency Modulation	2-20
2.5.2	Setting the High-frequency Modulation	2-20
2.6	Changing and Presetting the Start-up Parameters	2-21
2.6.1	Changing the Start-up Parameters	2-21
2.6.2	Resetting the Instrument to the Factory Presets	2-22
3.	REFERENCE	3-1
3.1	Menu Index	3-1
3.2	Menu Map	3-2
3.3	Functional Description	3-3
3.4	Initial Settings	3-5
4.	REMOTE PROGRAMMING	4-1
4.1	GPIB Command Index	4-1
4.3	GPIB Setup	4-3
4.4	Interface Functions	4-4
4.5	Service Request (SRQ)	4-5
4.6	Delimiter	4-5
4.7	Status Byte	4-6
4.8	Code Table	4-7
5.	SUPPLEMENTARY INFORMATION	5-1
5.1	Principle of Operation	5-1
5.2	APS Function	5-2
6.	SPECIFICATIONS	6-1
	DIMENSIONAL OUTLINE DRAWING	EXT-1
	ALPHABETICAL INDEX	I-1

LIST OF ILLUSTRATIONS

No.	Title	Page
1-1	Operating Environment	1-4
1-2	Replacing the Power Fuse	1-6
1-3	Power Cable	1-6
1-4	Start-up Screen	1-8
1-5	SETUP Mode Screen	1-9
1-6	Measurement System Used for Wavelength Test	1-10
1-7	Measurement System Used for Optical Power Output Test	1-10
1-8	Replacing/Cleaning Optical Connector-adapters for the Q8155	1-13
2-1	Description of the Front Panel	2-1
2-2	Description of the FUNCTION Section	2-2
2-3	Description of the SWEEP Mode Section	2-2
2-4	Description of the DATA ENTRY Section	2-3
2-5	Description of the GPIB Section	2-4
2-6	Description of the Display Section	2-4
2-7	Description of the I/O Port Section	2-5
2-8	Power Switch Section	2-5
2-9	Description of Other Sections	2-6
2-10	Description of the Rear Panel	2-7
2-11	Screen Annotation	2-8
2-12	Soft Menus	2-9
2-13	Soft Menu Hierarchy	2-9
2-14	SETUP Mode	2-11
2-15	SWEEP Mode	2-12
2-16	MODULATION Mode	2-13
2-17	CALIBRATION Mode	2-13
2-18	SYSTEM Mode	2-14
2-19	Measurement System Used for Optical Power Output Test	2-16
2-20	CHANGE MEMORY Display	2-21
2-21	INSTR PRESET! Display	2-22
5-1	Configuration of the Q8155	5-1

LIST OF TABLES

No.	Title	Page
1-1	Standard Accessories List	1-2
1-2	Accessories	1-2
1-3	Power Cable Options	1-3
1-4	Power Supply Specifications	1-5
1-5	Fuse	1-5
1-1	Recommended Instruments for the System Checkout	1-8
3-1	Initial Settings	3-5
4-1	Interface Functions	4-4
4-2	ACTIVE	4-7
4-3	BKLT	4-7
4-4	CAL	4-7
4-5	MOD	4-8
4-6	SETUP	4-9
4-7	SWEEP	4-10
4-8	SYSTEM	4-11
4-9	Controlling Data Output and Others	4-12

1. INTRODUCTION

This chapter provides the following information:

- Product description
- Standard accessories and optional accessories
- Operating environment
- Precautions in use
- System Checkout
- Cleaning, storing and transporting the Q8155
- Calibration
- Part life spans

1.1 Product Description

The Q8155, Tunable Light Source, provides excellent monochromatic high-output filtering by using a narrow-band, multilayer optical bandpass filter incorporated in the variable wavelength mechanism. The Q8155 is used to measure photoreceptor characteristics with high wavelength resolutions in a wide dynamic range.

The features of the Q8155 are as follows.

1. Permissible wavelength range: 1525 nm to 1630 nm
2. Wavelength resolution: 0.1 pm
3. Absolute wavelength accuracy: ± 10.0 pm
4. Relative intensity noise: -160 dB/Hz
5. Maximum optical output: +2.0 dBm (1540 nm to 1620 nm)
6. Remote control capabilities which allow you to setup an automatic measurement system. This remote control function complies with GPIB specifications.

NOTE: *Although optical output of the light source can be set to +2.8 dBm to allow you to finely adjust the output in proximity to +2.0 dBm, the maximum output is actually +2.0 dBm. In addition, the absolute power accuracy at the maximum optical output power may not be accurate because it is affected by factors such as the characteristics of the fiber or the state of matching.*

1.2 Standard Accessories and Optional Accessories

1.2 Standard Accessories and Optional Accessories

1.2.1 Standard Accessories

Table 1-1 lists the standard accessories shipped with the Tunable Light Source. If any of the accessories are damaged or missing or, to order additional accessories, contact a sales representative.

Table 1-1 Standard Accessories List

Name	Model name	Quantity	Remarks
Power cable	A01412	1	*1
AC adaptor	JCD-AL003EX03	1	
Angled polishing optical fiber code	DCB-HHD085X01	1	One end:Angled polishing (green connector) One end:PC polishing
CLASS 3A LASER PRODUCT label	MNS-L2872A001A	1	
Fuse	DFT-AA5A	2	
Operation manual	EQ8155	1	

* 1: The cable supplied with the Tunable Light Source depends on what type (specified by model number above) was ordered when the Tunable Light Source was purchased.
There are 11 types of power cable available (see Table 1-3).
To order another power cable, contact a sales representative. When ordering, refer to power cables by their option number or model number.

1.2.2 Accessories

Table 1-2 Accessories

Name	Model Name	Remarks
SC connector	A08162A	For the test port
ST connector	A08163	For the test port

Table 1-3 Power Cable Options

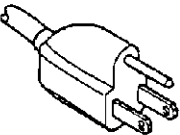
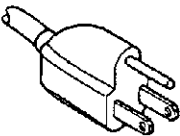
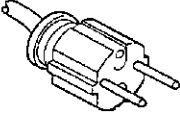
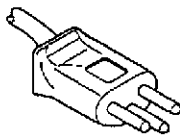
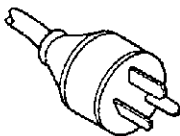
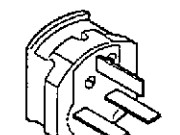
Plug configuration	Standards	Rating, color and length	Model number (Option number)
	JIS: Japan Law on Electrical Appliances	125 V at 7 A Black 2 m (6 ft)	Straight: A01402 Angled: A01412
	UL: United States of America CSA: Canada	125 V at 7 A Black 2 m (6 ft)	Straight: A01403 (Option 95) Angled: A01413
	CEE: Europe DEMKO: Denmark NEMKO: Norway VDE: Germany KEMA: The Netherlands CEBEC: Belgium OVE: Austria FIMKO: Finland SEMKO: Sweden	250 V at 6 A Gray 2 m (6 ft)	Straight: A01404 (Option 96) Angled: A01414
	SEV: Switzerland	250 V at 6 A Gray 2 m (6 ft)	Straight: A01405 (Option 97) Angled: A01415
	SAA: Australia, New Zealand	250 V at 6 A Gray 2 m (6 ft)	Straight: A01406 (Option 98) Angled: -----
	BS: United Kingdom	250 V at 6 A Black 2 m (6 ft)	Straight: A01407 (Option 99) Angled: A01417

1.3 Operating Environment

1.3 Operating Environment

This section describes the environmental conditions and power requirements necessary to use the Tunable Light Source.

1.3.1 Environmental Conditions

The Q8155 should be only be used in an area which satisfies the following conditions:

- Ambient temperature: +10°C to +35°C (operating temperature)
- Relative humidity: 85% or less (without condensation)
- An area free from corrosive gas
- An area away from direct sunlight
- A dust-free area
- An area free from vibrations
- A low noise area

Although the Q8155 has been designed to withstand a certain amount of noise riding on the AC power line, it should be used in an area of low noise. Use a noise cut filter when ambient noise is unavoidable.

- An area allowing unobstructed air flow

CAUTION: This analyzer should be used in a horizontal state.

An exhaust fan is installed on the rear panel. Additional vents are provided on both sides. Never block these areas as the resulting internal temperature rise will affect specifications.

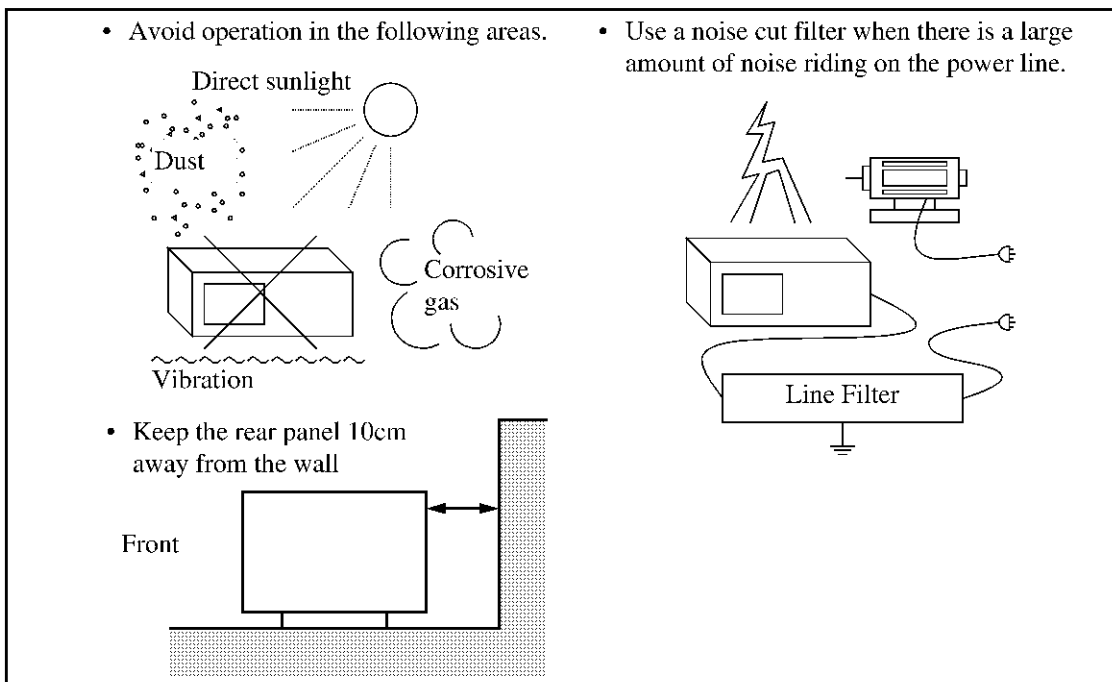

Figure 1-1 Operating Environment

The analyzer can be used safely under the following conditions:

- Altitude of up to 2000 m
- Installation Categories II
- Pollution Degree 2

1.3.2 Power Supply Specifications

The power supply specifications of the Tunable Light Source are listed in Table 1-4.

Table 1-4 Power Supply Specifications

	In operation under 100 VAC	In operation under 200 VAC
Input voltage	90V to 132V	198V to 250V
Frequency	50Hz/60Hz	
Power consumption	200VA or less.	

CAUTION: *To prevent damage, operate the Tunable Light Source within the specified input voltage and frequency ranges.*

During operation, the power supply automatically switches between input voltage levels of 100 VAC and 200 VAC. Be sure, however, to use a power cable that matches the input voltage and meets the related standard (see Table 1-3).

1.3.3 Power Fuse

CAUTION: *When a fuse blows, there may be some problem with the analyzer so contact a qualified ADVANTEST service representative before replacing the fuse.*

The power fuse is placed in the fuse holder which is mounted on the rear panel. To check or replace the power fuse, use the following procedure:

1. Press the **POWER** switch to the OFF position.
2. Disconnect the power cable from the AC power supply.
3. Remove the fuse holder on the rear panel.
4. Check (and replace if necessary) the power fuse and put it back in the fuse holder.

Table 1-5 Fuse

Part code	Rated current
DFT-AA5A	T5A

1.3.4 Power Cable

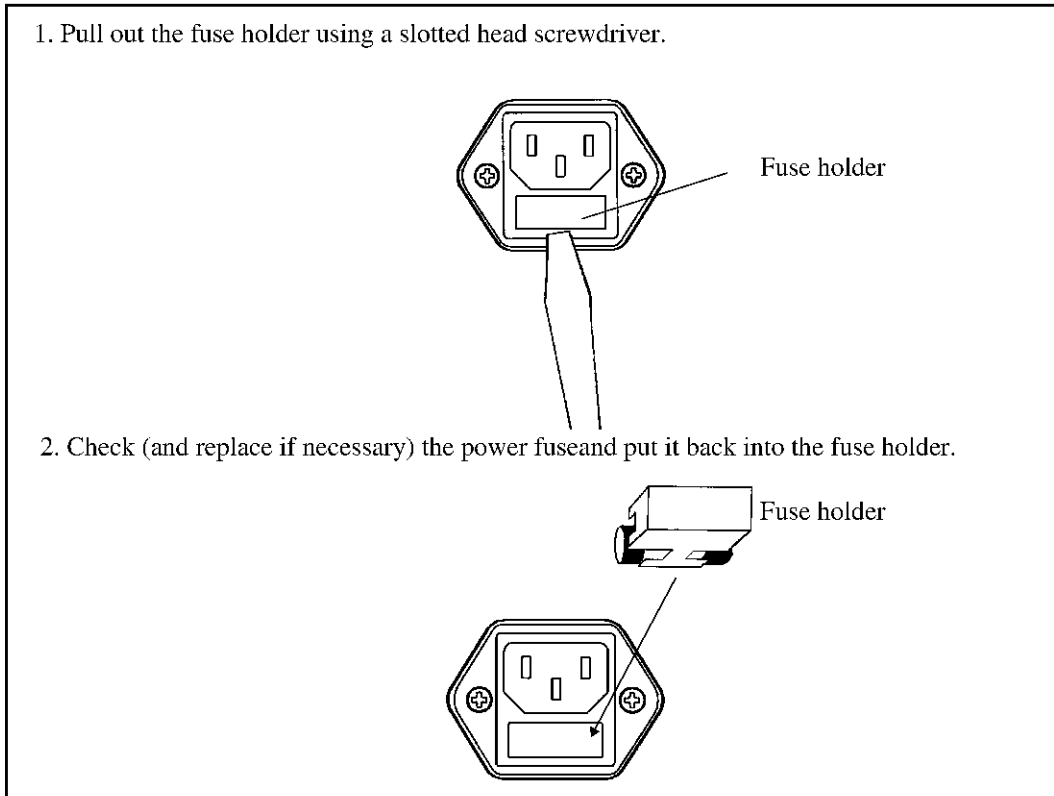

Figure 1-2 Replacing the Power Fuse

1.3.4 Power Cable

CAUTION:

1. Use a power cable rated for the voltage in question. Be sure however to use a power cable conforming to safety standards of your nation when using a product overseas (See Table 1-3).
2. Be sure to plug the power cable into an electrical outlet which has a safety ground terminal. Grounding will be defeated if you use an extension cord which dose not include a safety ground terminal.

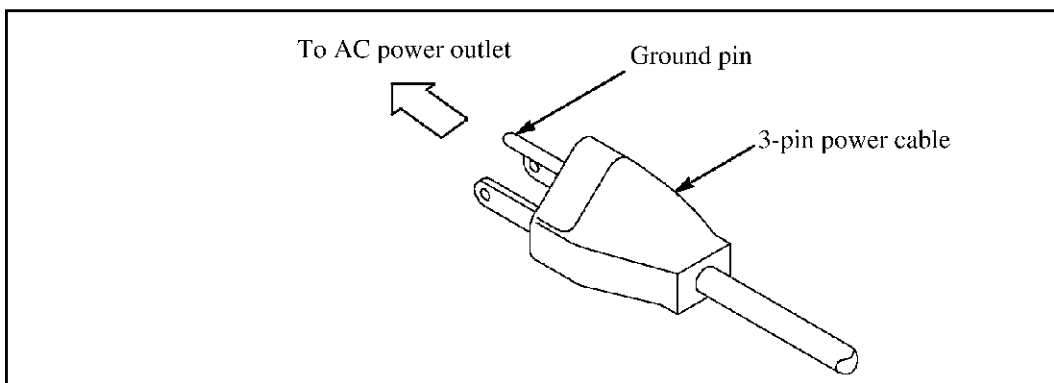

Figure 1-3 Power Cable

1.4 Precautions in Use

1. Before starting measurement

When turning power on, do not connect the DUT.

2. Opening the case

Only ADVANTEST authorized service personnel should open the cover.

This analyzer contains high-temperature and high-voltage components, as well as a laser radiation area.

3. If an abnormality occurs

If the analyzer issues smoke, a bad odor, or an unusual sound, turn off the power switch. Pull out the power cable from the outlet and contact a sales representative.

4. Electromagnetic interference

Electromagnetic interference may be caused to the television or the radio.

If the Q8155 power is turned off and the electromagnetic interference is reduced, then the Q8155 has caused the problem.

Prevent electromagnetic interference by the following procedure.

- Change the direction of the television or radio antenna to stop the electromagnetic interference.
- Place this analyzer on the other side of the television or the radio.
- Place this analyzer away from the television or radio.
- Use a different outlet for the television or radio.

1.5 System Checkout

1.5 System Checkout

This section describes a brief checkout used to verify the operation of the instrument which must be performed before using the instrument for the first time. To perform this checkout, follow the procedure below:

1.5.1 Instruments Required for the System Checkout

Table 1-1 lists the instruments recommended for the system checkout.

Instruments with capabilities equivalent to those listed in Table 1-1 can be used.

Table 1-1 Recommended Instruments for the System Checkout

Name	Type
Optical Wavelength Meter	Q8326
Optical Multi-power Meter	Q8221
Optical sensor	Q82208

Setup

1. Check to see if the **POWER** switch (on the front panel) is turned off.
2. Connect the provided power cable to the AC power supply connector on the rear panel.

CAUTION: To avoid damage to the instrument, operate it within the specified input voltage and frequency ranges.

3. Connect the power cable to the outlet.

Start-up screen

4. Turn the **POWER** switch on.
The product name, the message "SELFTEST IN PROGRESS" and the software version are displayed on the start-up screen. (It takes approximately three minutes to complete the self-test.)

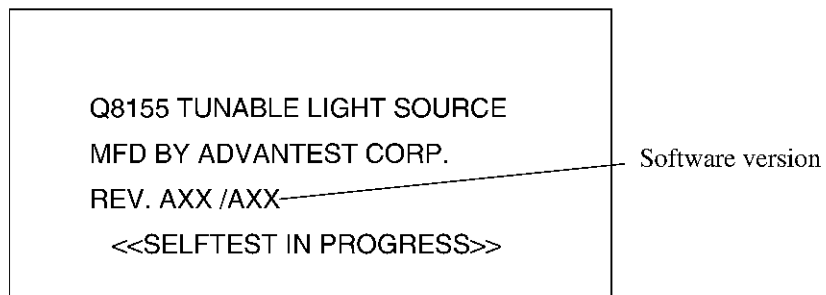

Figure 1-4 Start-up Screen

NOTE: The software version number begins with A01.
(Example: REV. A01)

The self-test (which takes approximately three minutes) is executed. When the self-test has been completed, the Setup mode screen shown in Figure 1-5 should be displayed.

NOTE: There is a possibility that the screen display is different from the Setup mode screen, depending on previously saved conditions.

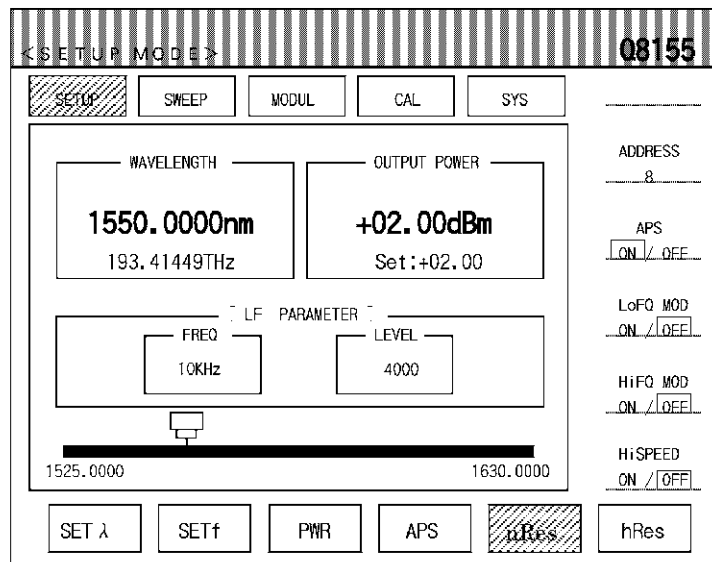

Figure 1-5 SETUP Mode Screen

- When an error occurs during the self-test, the corresponding error code is displayed.

CAUTION: When an error code is displayed, contact a sales representative.

- Press **SETUP, SET λ, 1, 5, 5, 0** and **nm**.
- Press **SETUP, PWR, 2, ., 8** and **ENTER**.
- Wait 60 minutes to allow the instrument to warm up.
- Press **SETUP, SET λ, 1, 5, 5, 0** and **nm**.

CAUTION: Reset the wavelength to the same value before using the light source because the wavelength may be unstable during warm-up.

- Connect the PC grinding side (not the green connector) of the optical fiber (provided as a standard accessory) to the optical output connector on the front panel.

1.5.1 Instruments Required for the System Checkout

CAUTION: *Be sure to clean the optical connector tip before connecting the optical fiber cord. (Refer to Section 1.6.1, "Cleaning and Replacement of Optical Connectors and Adapters.")*

Wavelength accuracy test

11. Connect the angled polishing side (the green connector) of the optical fiber (previously connected from the optical output connector on this instrument) to the Q8326, Optical Wavemeter.

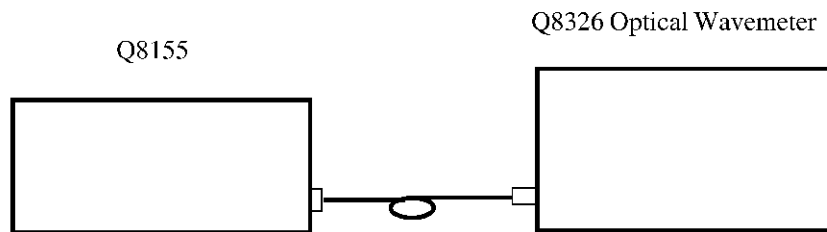

Figure 1-6 Measurement System Used for Wavelength Test

Setup for the Q8326

12. Set FUNCTION to LASER.
13. Set RANGE to 1000-1650nm.
14. Press the **ACTIVE** key on the right of the optical output connector.
15. Verify that the measured value is within $1550 \text{ nm} \pm 10 \text{ pm}$ (1549.990 nm to 1550.010 nm).

Optical output power test

16. Connect the angled polishing side (the green connector) of the optical fiber (previously connected from the optical output connector on this instrument) to the Q82208, Optical Sensor on the Q8221, Optical Power Meter.

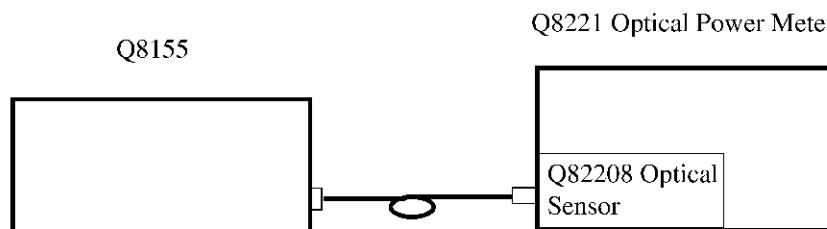

Figure 1-7 Measurement System Used for Optical Power Output Test

Setup for the Q8221 or Q82208

Set CW light mode.

17. Press the **CW/CHOP(CW)** key.

The CW indicator turns on when the CW light measurement mode is set.

NOTE: *The measurement mode toggles between the CW light and CHOP light modes each time you press the CW/CHOP key on the plug-in panel.*

The measurement wavelength is set to 1550 nm.

18. Press **λ**.

Wavelength setting mode is activated.

The previously set wavelength is displayed.

19. Make the digit you want to change its value blinking using the ◀ or ▶ key.
20. Increase or decrease the value using the ▲ or ▼ key.
21. Repeat Steps 19. and 20. until the target light wavelength is set to 1550 nm.

Setting the measurement range to 20 mW range

22. Press the **dBm/W** key to set the unit, W.
23. Press **AUTO** in the Q8221.

NOTE: *The measurement range toggles between the auto and manual modes each time you press the AUTO key on the plug-in panel.*

24. Set the measurement range to 20 mW using the △ or ▽ key.

Optical output

25. Press the **ACTIVE** key to output the optical power.
26. Verify that the measured value on the Q8221 is 1.5 mW or more.

If you encounter any problems with the system checkout, contact a sales representative.

1.5.2 Errors and Alarms

1.5.2 Errors and Alarms

1. System data errors

Contact an ADVANTEST sales representative for maintenance service or repair when any of the following error messages are displayed during startup.

- Err. 01: Data block 1 error
- Err. 02: Data block 2 error
- Err. 03: Data block 3 error
- Err. 04: Data block 4 error

2. System check errors

Contact an ADVANTEST sales representative for maintenance service or repair if a system check message indicating that the instrument has a problem in the control system is displayed and the self test is not completed.

- SYSTEM CHK01: Control block 1
- SYSTEM CHK02: Control block 2
- SYSTEM CHK03: Control block 3
- SYSTEM CHK04: Control block 4
- SYSTEM CHK05: Control block 5

3. Alarm

If an alarm message is displayed, follow the instructions in the Solution column shown below. In addition, note that Bit 5 of the GPIB status byte is set to 1 to indicate that an alarm has been detected.

Alarm message	Solution
Overheat Alarm! (Internal temperature has risen to an abnormal level)	Contact ADVANTEST for maintenance service or repair if this alarm occurs with under normal operating conditions.
Cooling FAN Alarm! (The cooling fan has stopped)	Contact ADVANTEST for maintenance service or repair if this alarm occurs but the cooling was not blocked in anyway.

1.6 Cleaning, Storing and Transporting the Q8155

1.6.1 Cleaning and Replacement of Optical Connectors and Adapters

Replacing optical connector-adapter

1. Remove the optical connector adapter and attach the optical fiber previously pulled out to the FC connector side of the new SC- or ST- type connector adapter.
2. Carefully replace the fiber back in its place.
3. Reattach the adapter using the adapter fixation cap.

NOTE: Although the Q8155 is equipped with FC-type connector-adapter as standard, SC-type and ST-type optical connector-adapters are also available.

Cleaning optical connector tip

1. Remove the adapter in the same manner as the optical connector adapter.
2. Clean the tip of the optical fiber with alcohol.
3. Carefully replace the fiber.
4. Affix the adapter using the adapter fixation cap.

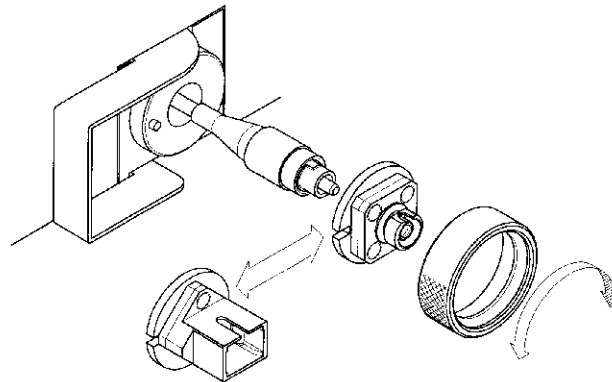

Figure 1-8 Replacing/Cleaning Optical Connector-adapters for the Q8155

CAUTION:

1. Be sure to tighten the adapter cap after replacing or cleaning the optical connector-adapter.
 2. Do not pull out the optical connection past the white marking on the cable when cleaning it.
-

1.6.2 Cleaning

1.6.2 Cleaning

Remove dust from the outside of the Tunable Light Source by wiping or brushing the surface with a soft cloth or small brush. Use a brush to remove dust from around the panel keys. Hardened dirt can be removed by using a cloth which has been dampened in water containing a mild detergent.

CAUTION:

1. *Do not allow water to get inside the Tunable Light Source.*
 2. *Do not use organic cleaning solvents, such as benzene, toluene, xylene, acetone or similar compounds, since these solvents may damage the plastic parts.*
 3. *Do not use abrasive cleaners.*
-

1.6.3 Storing

Store the Tunable Light Source in an area which has a temperature from -10°C to +50°C. If you plan to store the Tunable Light Source for a long period (more than 90 days), put the Tunable Light Source in a vapor-barrier bag with a drying agent and store the Tunable Light Source in a dust-free location out of direct sunlight.

1.6.4 Transporting

When you ship the Q8155, use the original container and packing material. If the original packaging is not available, pack the Q8155 using the following guidelines:

- To allow for cushioning, use a corrugated cardboard container with inner dimensions that are at least 15 centimeters more than those of the Q8155.
- Wrap the Q8155 in cushioning material, and put it into a corrugated cardboard container.
- Seal the container with shipping tape or a heavy-duty, industrial stapler.

If you are shipping the Q8155 to a service center for service or repair, attach a tag to the Q8155 that shows the following information:

- Owner and address
- Name of a contact person at your location
- Serial number of the Q8155 (located on the rear panel)
- Description of the service requested

1.7 Warming up

After the analyzer is at room temperature, turn the power on and allow it to warm up for approximately 60 minutes.

1.8 Calibration

Calibration work should be performed at an ADVANTEST CORPORATION site. When you want to calibrate the Q8155, please contact a sales representative.

Desirable Period	One year
------------------	----------

1.9 Part Life Spans

The Q8155 uses the following parts with limited life that are not listed in Safety Summary. Replace the parts listed below after their expected lifespan has expired.

Part name	Life
Soft key switch	Half million times operable
LCD back-light	An operating life of twenty thousand hours
Laser diode	An operating life of 100,000 hours
Stepping motor	An operating life of 60,000 hours

2. OPERATION

This chapter describes the following items.

- Description of panels
- Basic operation
- CW optical output power

2.1 Description of Panels

This section explains the names and functions of the parts on the front and rear panels and the screen annotation.

2.1.1 Front Panel

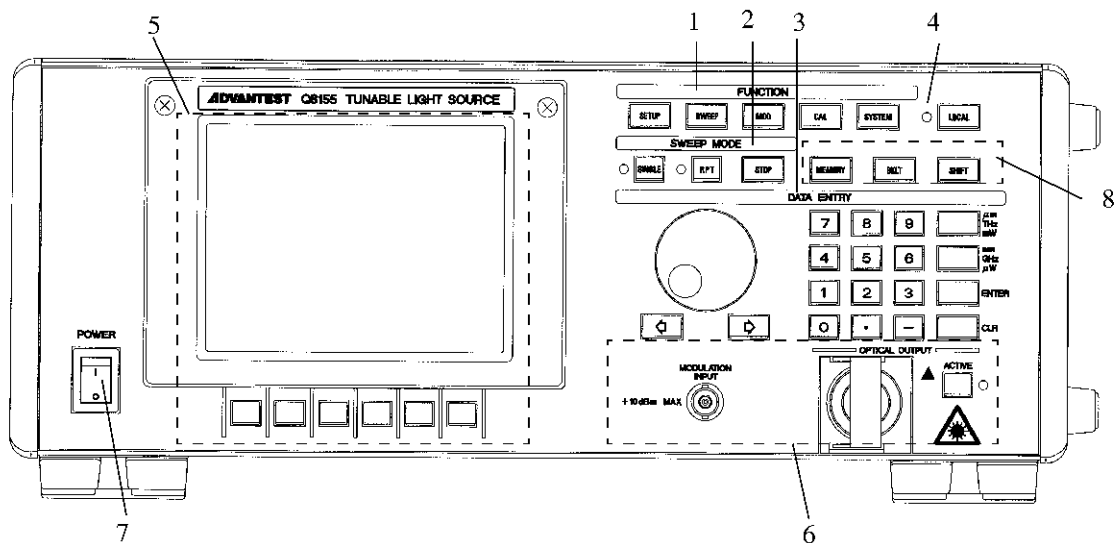

Figure 2-1 Description of the Front Panel

1. FUNCTION section
2. SWEEP mode section
3. DATA ENTRY section
4. GPIB section
5. Display section
6. I/O port section
7. POWER switch section
8. Other sections

2.1.1 Front Panel

2.1.1.1 FUNCTION Section

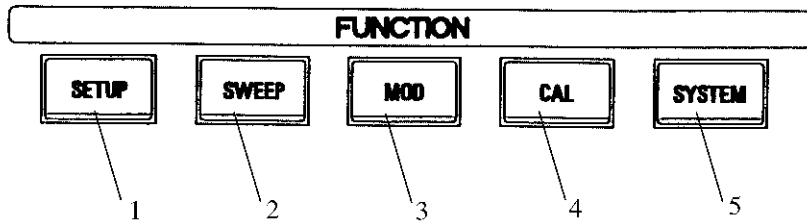

Figure 2-2 Description of the FUNCTION Section

- | | |
|---------------|---------------------------------------|
| 1. SETUP key | Displays the SETUP mode screen. |
| 2. SWEEP key | Displays the SWEEP mode screen. |
| 3. MOD key | Displays the MODULATION mode screen. |
| 4. CAL key | Displays the CALIBRATION mode screen. |
| 5. SYSTEM key | Displays the SYSTEM mode screen. |

2.1.1.2 SWEEP Mode Section

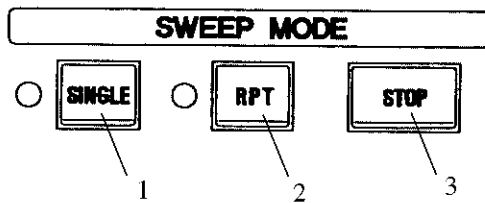

Figure 2-3 Description of the SWEEP Mode Section

- | | |
|---------------|--|
| 1. SINGLE key | Performs single mode sweeping.
Use the SHIFT-SINGLE key combination to enter the single step mode. |
| 2. RPT key | Performs repeat mode sweeping. |
| 3. STOP key | Stops sweeping. |

2.1.1.3 DATA ENTRY Section

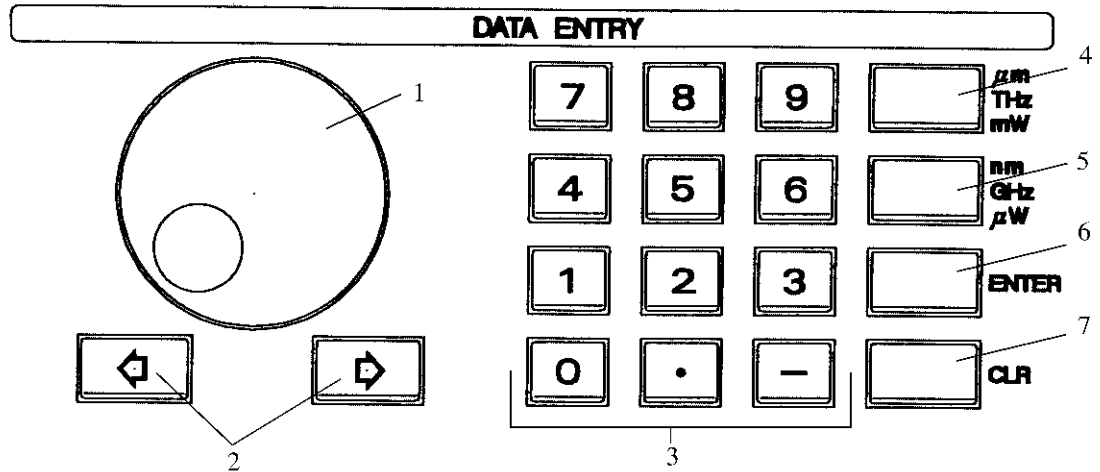

Figure 2-4 Description of the DATA ENTRY Section

- | | |
|-------------------|---|
| 1. Data knob | Used to make fine adjustments to the entered data. |
| 2. Step key | Used to enter data in predefined steps. |
| 3. Numeric keypad | Used to enter numeric values. The keypad consists of numeric keys (0 to 9), a decimal point (.) key and a minus sign (-) key. |
| 4. THz key | Sets the unit to μm , THz or mW. |
| 5. GHz key | Sets the unit to nm, GHz or μW . |
| 6. ENTER key | Sets any entered numeric values. |
| 7. CLR key | Cancels the input mode. |

2.1.1 Front Panel

2.1.1.4 GPIB Section

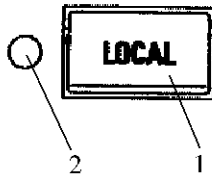

Figure 2-5 Description of the GPIB Section

- | | |
|---------------------|--|
| 1. LOCAL key | Sets the local mode so that the instrument can be operated from the panel. |
| 2. REMOTE indicator | Lit when the instrument is in the remote mode. |

2.1.1.5 Display Section

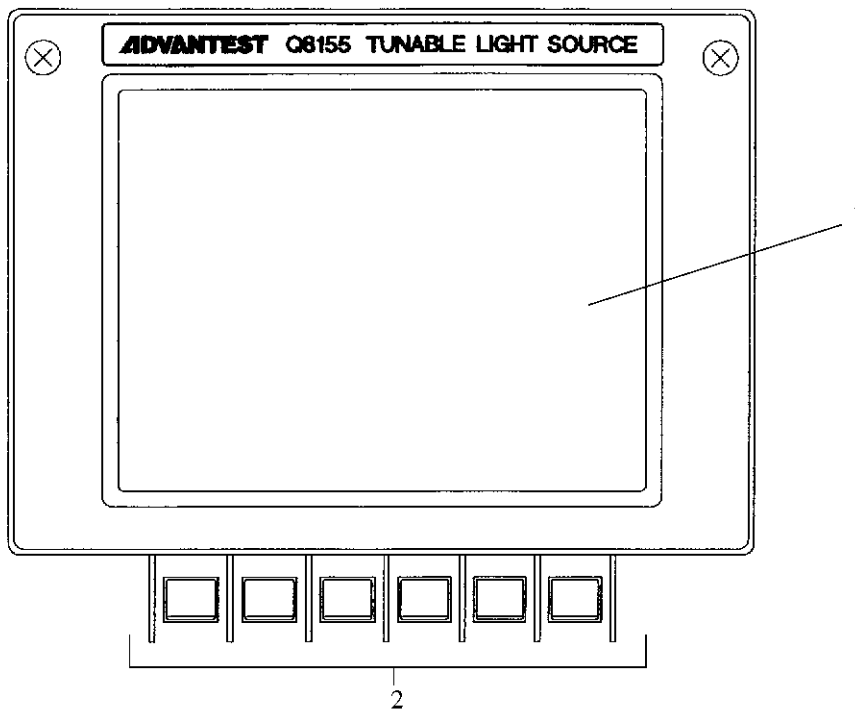

Figure 2-6 Description of the Display Section

- | | |
|---------------------------------|--|
| 1. Liquid crystal display (LCD) | Displays the five function modes, operation conditions etc. |
| 2. Soft keys | The six soft keys are used to select the functions displayed in the lower part of the LCD screen. Pressing a soft key displays the associated menu, or executes the associated function. |

2.1.1.6 I/O Port Section

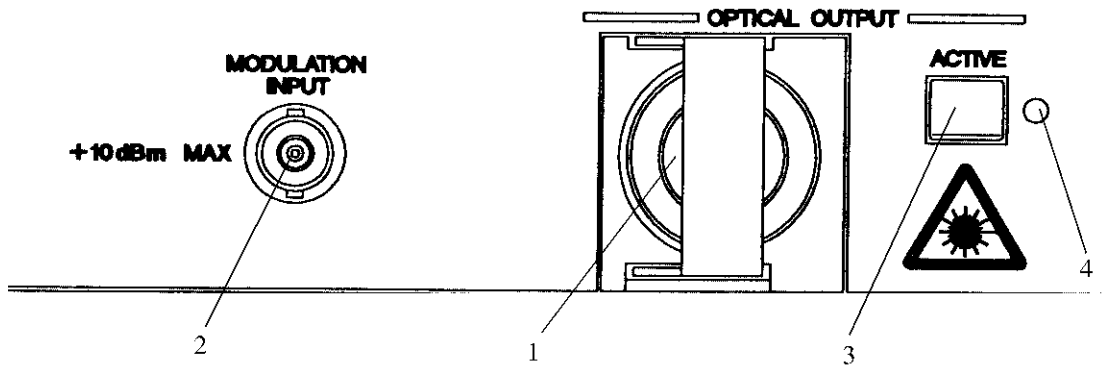

Figure 2-7 Description of the I/O Port Section

- | | | |
|----|--|---|
| 1. | Optical output (FC connector) | FC connector used for optical output. |
| 2. | External high-frequency modulation input (BNC connector, 50 Ω) | BNC connector used for an external high-frequency modulation input. |
| 3. | ACTIVE key | Activates the laser light output for the optical output connector. |

WARNING: This connector radiates laser radiation. Do not look into the optical connector or any attached cables when the connector is active or you may damage your eyes. For more information, refer the Q8155 precautions located at the front of the manual.

- | | | |
|----|--------------------------|---------------------------------|
| 4. | LED for the beam shutter | Lit when laser light is output. |
|----|--------------------------|---------------------------------|

2.1.1.7 Power Switch Section

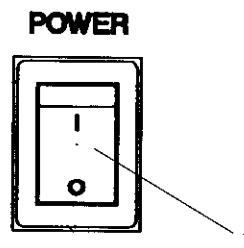

Figure 2-8 Power Switch Section

- | | | |
|----|--------------|----------------------------|
| 1. | Power switch | Turns the power on or off. |
|----|--------------|----------------------------|

2.1.1 Front Panel

2.1.1.8 Other Sections

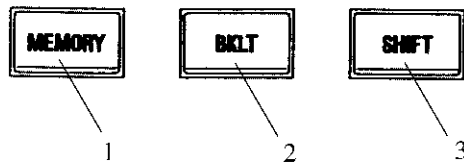

Figure 2-9 Description of Other Sections

- | | |
|---------------|--|
| 1. MEMORY key | Stores the start-up conditions. |
| 2. BKLT key | Turns the backlight on or off. |
| 3. SHIFT key | Use the SHIFT - SINGLE key combination to enter the single step mode. |

2.1.2 Rear Panel

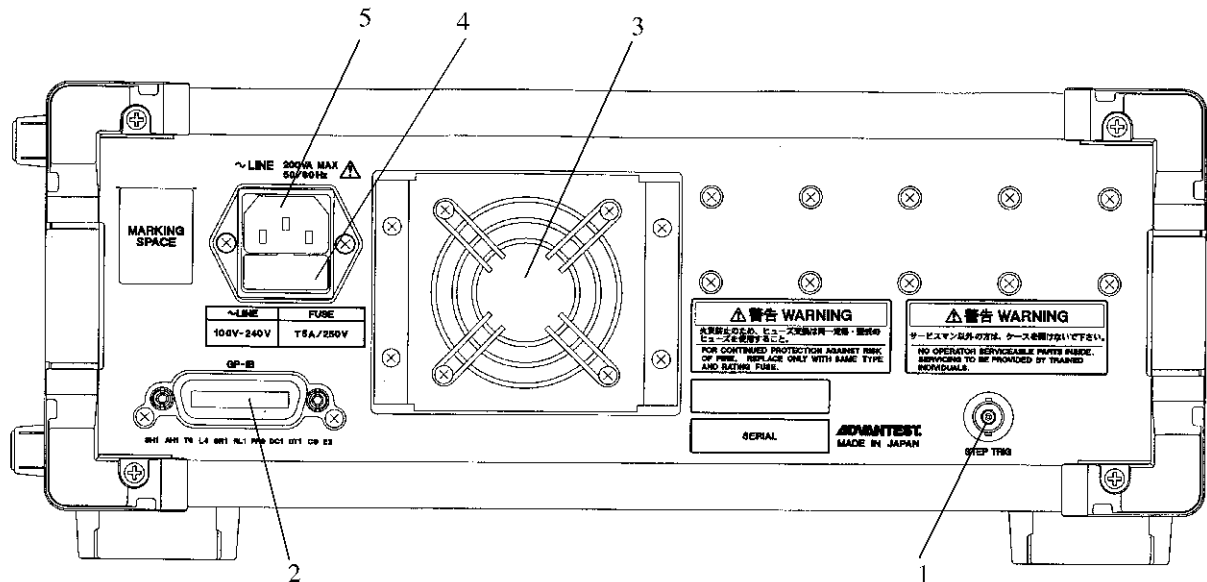

Figure 2-10 Description of the Rear Panel

- | | |
|----|--|
| 1. | Step-trigger signal output (BNC connector, TTL level)
Used to output pulse signals for each step operation during SWEEP mode. |
| 2. | GPIB connector
Used to connect the GPIB interface cable. |

CAUTION: Do not connect or disconnect the GPIB cable unless the POWER switch has been turned off and the power cord has been removed or AC leakage voltage may damage the circuits of the instrument.

- | | |
|----|---------------------|
| 3. | Fan
Cooling fan. |
|----|---------------------|

CAUTION: Do not let anything block the exhaust vent of the fan.

- | | |
|----|--|
| 4. | Fuse
Use a fuse conforming to the specifications. |
| 5. | AC connector
Used to connect the power cable. (Refer to Section 1.3.4.) |

2.1.3 Screen Annotation

2.1.3 Screen Annotation

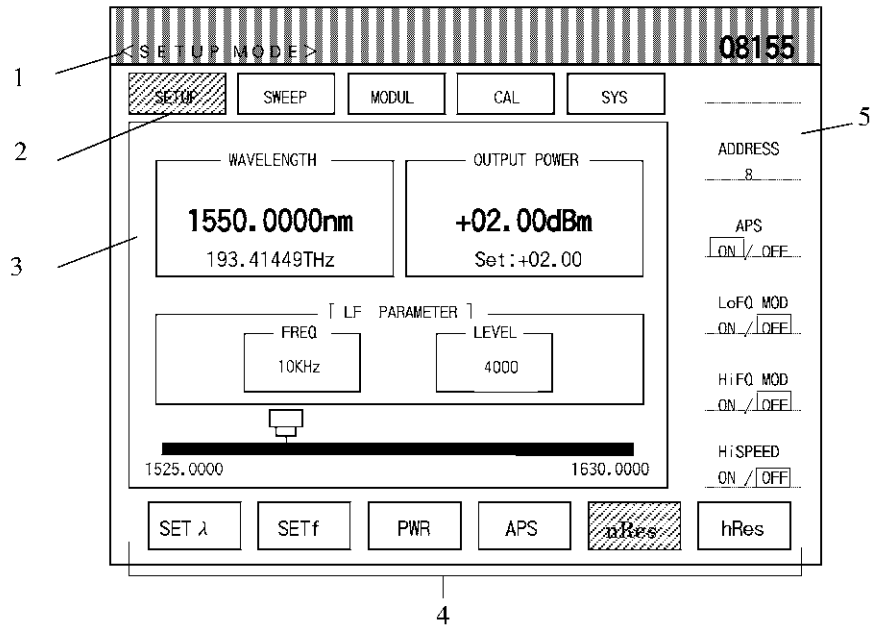

Figure 2-11 Screen Annotation

- | | |
|-----------------------------------|---|
| 1. Mode name | Displays five FUNCTION modes. |
| 2. Mode setting key | The key corresponding to the current FUNCTION mode name is selected. |
| 3. Parameters settings area | Displays the set values of various parameters. |
| 4. Soft menu display area | Displays soft menus. |
| 5. Setting condition display area | Displays the GPIB address, APS, low-frequency modulation, high-frequency modulation and high-speed setting. |

2.2 Basic Operation

2.2.1 Menu Operation and Data Entry

This section explains how to operate the panel keys and soft keys.

1. Menu Selection

Pressing the panel key in the FUNCTION section allows you to select one of the five FUNCTION modes. Soft menus are displayed in the soft menu display area on each mode display screen. For example, when the **SETUP** key is pressed, the following soft menus are displayed. To select the soft menu, press the soft key directly below the soft menu.

SET λ
SETf
PWR
APS
nRes
hRes

Figure 2-12 Soft Menus

2. Soft Menu Hierarchy

The soft menu has no submenus. Pressing a soft key allows you to change the settings of each key in the soft key item setting area.

Figure 2-13 shows the soft menu associated with the **SYSTEM** key as an example.

NOTE:  Represents a panel key.

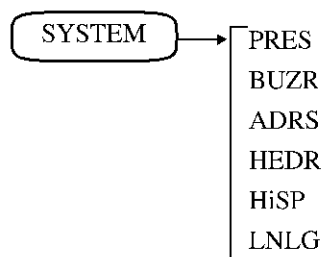

Figure 2-13 Soft Menu Hierarchy

3. Changing Settings

A soft menu with a toggle function such as λ/f changes every time you press the soft key. The current status of the function is highlighted.

2.2.1 Menu Operation and Data Entry

4. Entering Data

When set values are displayed in each parameter setting area, you can change the set values using the numeric keypad, step key or data knob.

5. Entering Data from the Numeric Keypad

Enter data using the numeric keys, decimal point (.) key, minus sign (-) key or **CLR** (clear) key. If you enter incorrect characters, press the **CLR** key to return to the previous state where the characters you entered are erased and the previous value is restored. Entering a numeric value and then pressing the unit key completes the data entry.

CAUTION: *Pressing another panel key prior to pressing the unit key will clear the entered data.*

Example 1:

Set the wavelength to 1600 nm from the numeric keypad.

Press **SETλ, 1, 6, 0, 0** and **nm**.

The wavelength setting is turned on and the entered data is displayed in each parameter setting area. The wavelength is set to 1600.000 nm.

6. Entering Data with the Step Key

The step keys are used to enter data in increments of a predetermined size.

Pressing the “→” key increases the data value; while pressing the “←” key decreases the data value.

7. Entering Data with the Data Knob

The data knob allows you to make fine adjustments to the entered data.

2.2.2 FUNCTION Mode

This instrument uses five modes to make the various settings.

1. SETUP mode

Sets the wavelength (frequency) and power of the optical output, and turns APS on or off.

This mode is set as the start-up mode when the instrument is shipped from the factory.

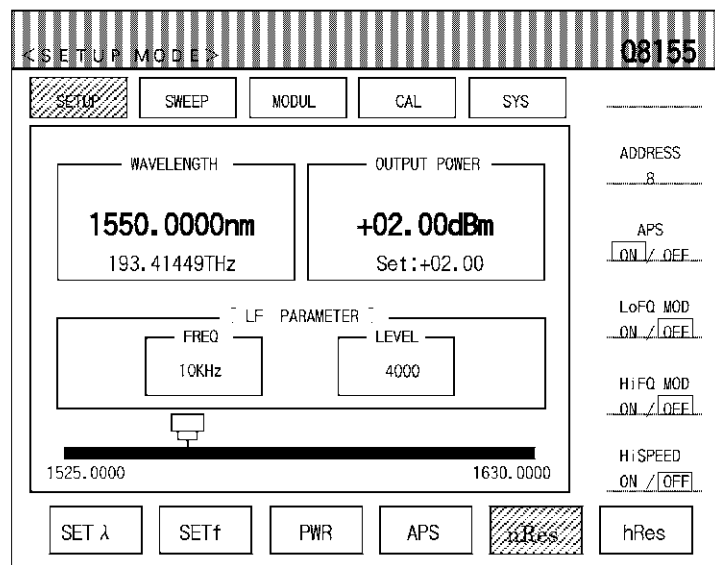

Figure 2-14 SETUP Mode

2.2.2 FUNCTION Mode

2. SWEEP Mode

Sets the start wavelength (frequency), stop wavelength (frequency), interval wavelength (frequency), setup time and power for the trace.

As a result, pressing **SINGLE** while this mode is turned on performs wavelength sweeping according to the settings.

Make sure that you set the units used for the sweep start, stop and interval to the wavelength or frequency (found in the soft menu).

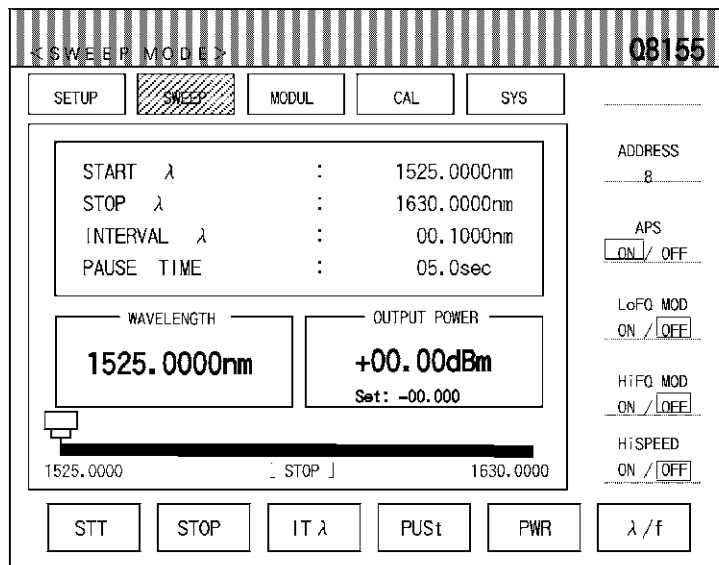

Figure 2-15 SWEEP Mode

3. MODULATION Mode

Turns the low-frequency modulation on or off, sets the modulation frequency and modulation factor of the low-frequency modulation, and turns the high-frequency modulation on or off.

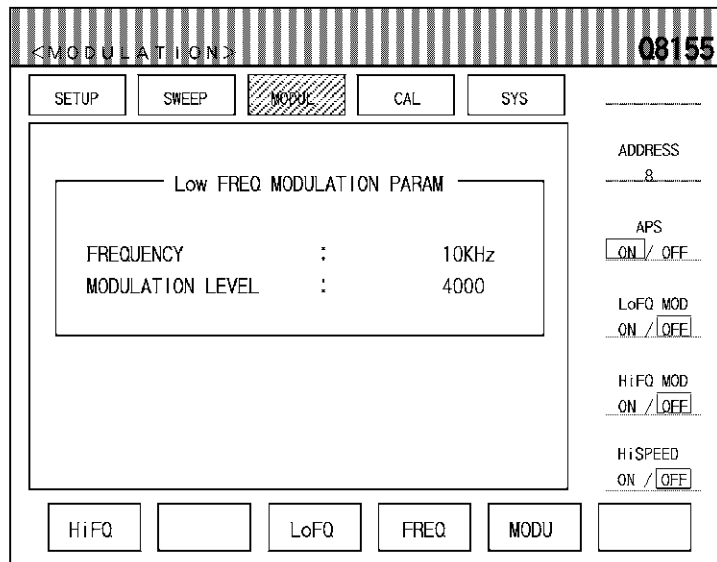

Figure 2-16 MODULATION Mode

4. CALIBRATION Mode

Makes a zero-adjustment to the offset of the photo diode used for optical output measurements.

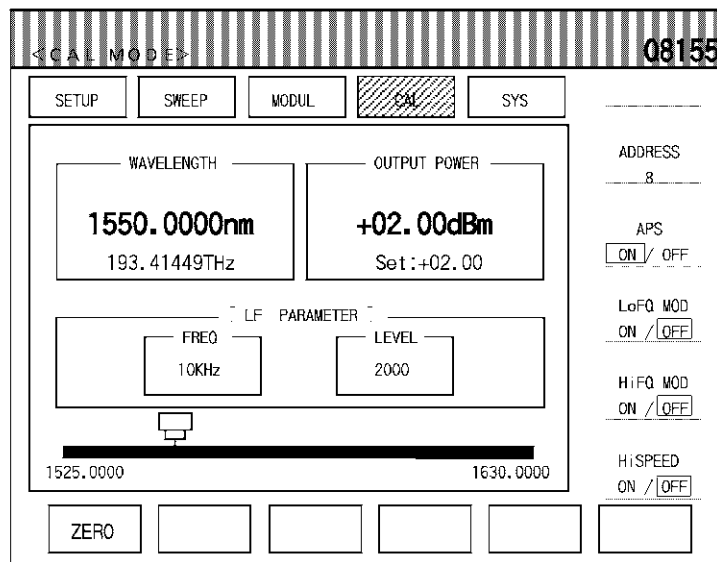

Figure 2-17 CALIBRATION Mode

2.2.2 FUNCTION Mode

5. SYSTEM Mode

Sets the buzzer to ON or OFF, sets the GPIB parameters (such as the address and the data item indicating whether or not a header is contained) and sets the power unit to LIN or LOG.

In addition, press **PRES** to reset the instrument to the factory default settings.

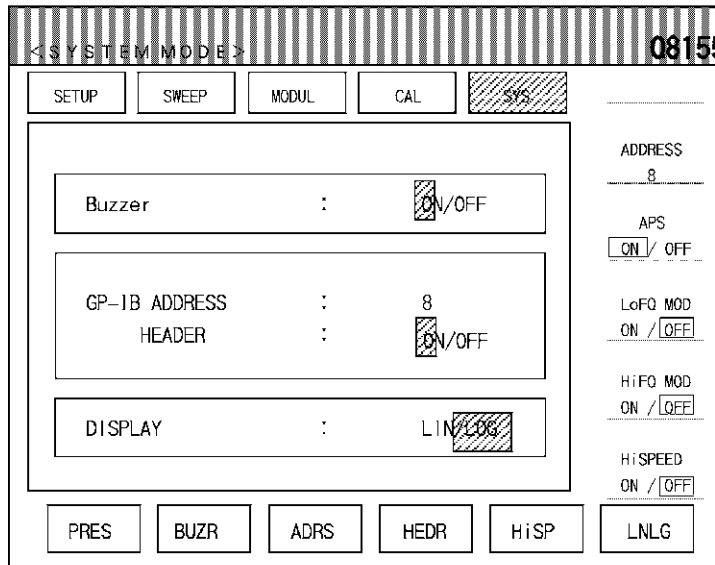

Figure 2-18 SYSTEM Mode

2.3 CW Optical Output Power

This section explains how to obtain the optical output under the following conditions.

Optical Power Meter:	Q8221
Optical Sensor:	Q82208
Measurement wavelength:	1550.00 nm
Optical output power:	+2.00 dBm

Setup

1. Check to see if the **POWER** switch (on the front panel) is turned off.
2. Connect the provided power cable to the AC power supply connector on the rear panel.

CAUTION: *To avoid damage to the instrument, operate it within the specified input voltage and frequency ranges.*

3. Connect the power cable to the outlet.

Performance Verification Procedure

4. Turn on the **POWER** switch (on the front panel).
When the initial test (which takes approximately three minutes) has been completed, the SETUP Mode screen is displayed as shown in Figure 1-5.
Wait 60 minutes to allow the instrument to warm up.
5. Connect the PC grinding side (not the green connector) of the optical fiber (provided as a standard accessory) to the optical output connector on the front panel.

CAUTION: *Be sure to clean the optical connector tip before connecting the optical fiber cord. (Refer to Section 1.6.1, "Cleaning and Replacement of Optical Connectors and Adapters.")*

Setup for the Q8155

6. Press **SETUP, SET λ , 1, 5, 5, 0** and **nm**.
The wavelength is set to 1550 nm.
7. Press **PWR, 2, ,, 0, 0** and **ENTER**.
The optical output is set.

2.3 CW Optical Output Power

8. Connect the angled polishing side (the green connector) of the optical fiber (previously connected from the optical output connector on this instrument) to the Q82208, Optical Sensor on the Q8221, Optical Power Meter.

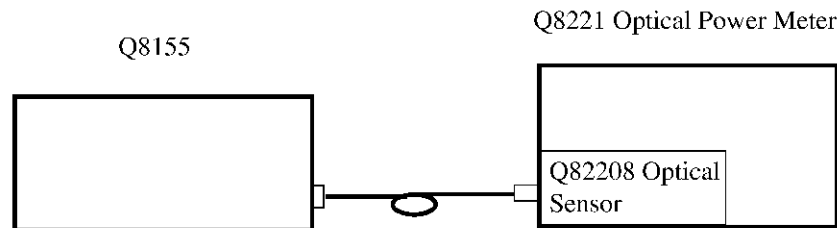

Figure 2-19 Measurement System Used for Optical Power Output Test

Setup for the Q8221 or Q82208

Set CW light mode.

9. Press the **CW/CHOP** key.
The CW indicator turns on when the CW light measurement mode is set.

NOTE: *The measurement mode toggles between the CW light and CHOP light modes each time you press the CW/CHOP key on the plug-in panel.*

The measurement wavelength is set to 1550 nm.

10. Press **λ**.
Wavelength setting mode is activated.
The previously set wavelength is displayed.
11. Make the digit you want to change its value blinking using the ◀ or ▶ key.
12. Increase or decrease the value using the ▲ or ▼ key.
13. Repeat Steps 11. and 12. until the target light wavelength is set to 1550 nm.

Optical output

14. Press the **ACTIVE** key to output the optical power.

2.4 Performing Sweeping in SWEEP Mode

This section shows the procedure used to perform wavelength sweeping under the following conditions.

Sweep start wavelength:	1540 nm
Sweep stop wavelength:	1575 nm
Sweep interval:	1 nm
Wavelength setup time:	0.5 sec
Power:	2.0 dBm

NOTE: *The procedure for frequency sweeping is almost the same as the above procedure.*

2.4.1 Procedure Used with Single Sweep Mode

Selecting the Sweep Mode screen

1. Press the **SWEEP** key.

Setting the sweep start wavelength

2. Press **STT, 1, 5, 4, 0** and **nm**.

Setting the sweep stop wavelength

3. Press **STOP, 1, 5, 7, 5** and **nm**.

Setting the sweep interval

4. Press **IT λ, 1** and **nm**.

Setting the wavelength setup time

5. Press **PUS_t, 0, ., 5** and **ENTER**.

Setting the optical power

6. Press **PWR**.
7. Set the power to 2.00 dBm using the step keys or data knob.
8. Press **ENTER**.

NOTE: *The numeric keys cannot be used to set the power when SWEEP Mode is used.*

2.4.2 Procedure Used with Repeat Sweep Mode

Performing sweeping

9. Press the **SINGLE** key.

Finishing the current sweep operation

10. Finishes sweeping when the optical output wavelength reaches the sweep stop wavelength.
However, when the next sweep wavelength exceeds the current sweep stop wavelength, the sweep is terminated at the sweep start wavelength.

Example

Sweep start wavelength: 1605 nm

Sweep stop wavelength: 1630 nm

Sweep interval: 10 nm

The sweep is terminated at an output wavelength of 1625 nm when the above conditions are used.

NOTE: *To forcibly terminate the current sweep, press and hold STOP until STOP is displayed on the screen.*

2.4.2 Procedure Used with Repeat Sweep Mode

Performing a single sweep

1. Perform the necessary settings according to steps 1. thru 6. in Section 2.4.1, "Procedure Used with Single Sweep Mode."

Performing repeated sweeping

2. Press **RPT**.
Sweeps are repeated until **STOP** is pressed.

Terminating repeated sweeping

3. Press and hold **STOP**.
Repeated sweeping is terminated when STOP is displayed on the screen.

2.4.3 Procedure Used with Single Step Mode

Performing a single sweep

1. Perform the necessary settings according to steps 1. thru 6. in Section 2.4.1, "Procedure Used with Single Sweep Mode."
2. Press **SINGLE** while pressing **SHIFT**.
3. Press **ENTER** to step up the wavelength.

NOTE: *To forcibly terminate the current sweep, press and hold STOP until STOP is displayed on the screen.*

2.5 Modulated Signal Setup

2.5 Modulated Signal Setup

The Modulation Mode screen must be set in order to set up the following.

Selecting the Modulation Mode screen

1. Press **MOD**.

2.5.1 Setting the Low-frequency Modulation

1. Press **FREQ**.
2. Use the data knob or step keys to set data.

NOTE: *The numeric keys cannot be used.*

3. Press **MODU**.
4. Use the data knob or step keys to set data.

NOTE: *The numeric keys cannot be used.*

5. Set **LoFQ** to on.

2.5.2 Setting the High-frequency Modulation

1. Turn **HiFQ** on.
The settings are displayed in HiFQ MOD which is on the right-hand side of the LCD.

NOTE: *Connect the proper cable from the external high-frequency modulation input connector to the MODULATION INPUT connector on the front panel.*

2.6 Changing and Presetting the Start-up Parameters

2.6.1 Changing the Start-up Parameters

It is possible to change the FUNCTION mode and various parameters used when the instrument is turned on.

The changed settings are effective unless the parameters are reset to the factory defaults using the procedure described in 3.4.

The changed parameters take affect the next time the instrument is started.

Changing the Start-up Parameters

1. Display the FUNCTION mode you wish to set.
2. Set the parameters.
3. Press **MEMORY**.
A message “<<CHANGE MEMORY>>” is displayed in the lower part of the LCD screen.

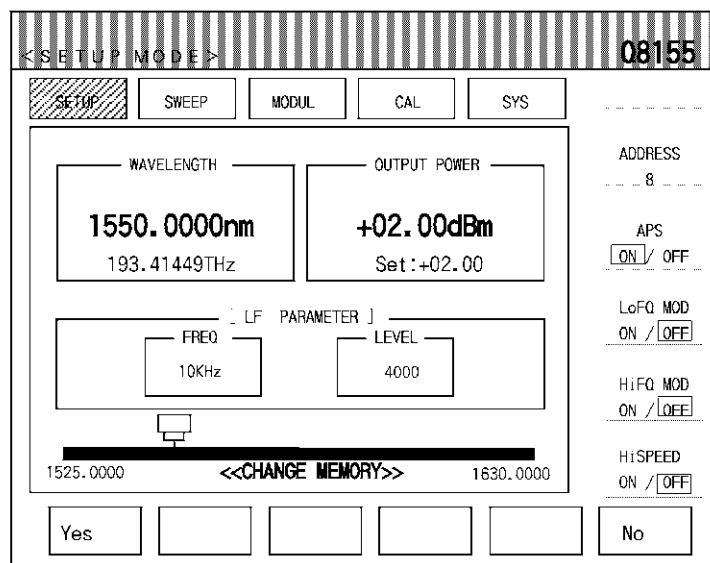

Figure 2-20 CHANGE MEMORY Display

4. Press *Yes*.
The parameters currently set are written to the start-up parameters.

NOTE: The start-up parameter that is going to be changed includes the ON/OFF setting of the optical output. The instrument is started with the optical output turned on, when a reset from the GPIB remote control is performed or when the instrument power is turned on again after a temporary power outage. As a result, be sure to check the optical output settings prior to changing the start-up parameter in order not to damage the instruments or devices which are connected on the other side.

2.6.2 Resetting the Instrument to the Factory Presets

2.6.2 Resetting the Instrument to the Factory Presets

Restores the FUNCTION mode and various parameters to the factory default settings.

NOTE: *Resetting the instrument to the default settings clears any settings you have made.*

Resetting the Instrument

1. Press the **SYSTEM** key.
The SYSTEM mode is set.
2. Press the **PRES** key.
A message “<<INSTR PRESET!>>” is displayed in the lower part of the LCD screen

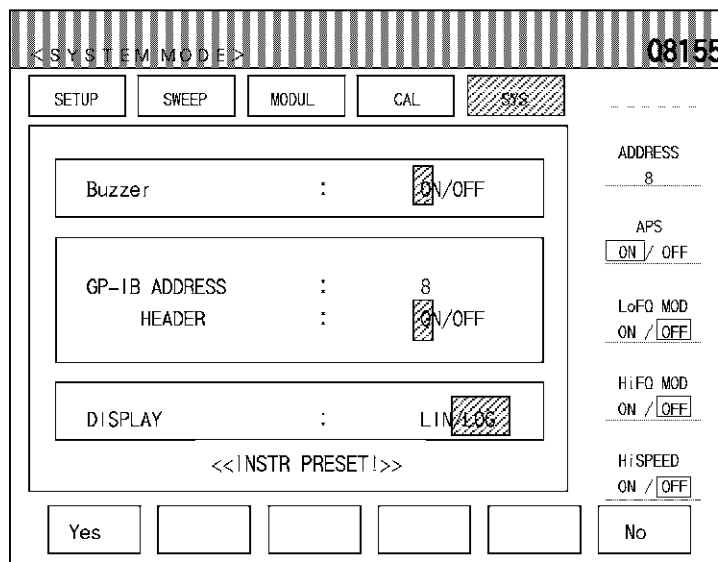

Figure 2-21 INSTR PRESET! Display

3. Press **Yes**.
Initializes the instrument to the default settings.

NOTE: *Press No to cancel this procedure.*

3. REFERENCE

This chapter describes the functions of all panel and soft keys.

- Menu index: Use this index as a key index to Chapter 3.
- Menu map: Shows a list of hierarchical menus on a panel key basis.
- Functional descriptions: Explains the functions of the panel and soft keys.

3.1 Menu Index

This menu index is used to easily find the keys described in Chapter 3.

Operation Key	Pages
λ/f	3-2, 3-3
ADRS.....	3-2, 3-4
APS.....	3-2, 3-3
BUZR.....	3-2, 3-4
CAL.....	3-2, 3-4
FREQ.....	3-2, 3-4
HEDR.....	3-2, 3-4
HiFQ.....	3-2, 3-3
HiSP.....	3-2, 3-4
hRES.....	3-2, 3-3
IT λ	3-2, 3-3
LNLG.....	3-2, 3-4
LoFQ.....	3-2, 3-3
MOD.....	3-2, 3-3
MODU.....	3-2, 3-4
nRES.....	3-2, 3-3
PRES.....	3-2, 3-4
PUS _t	3-2, 3-3
PWR.....	3-2, 3-3
SET f	3-2, 3-3
SET λ	3-2, 3-3
SETUP.....	3-2, 3-3
STOP.....	3-2, 3-3
STT.....	3-2, 3-3
SWEEP.....	3-2, 3-3
SYSTEM.....	3-2, 3-4
ZERO.....	3-2, 3-4

3.2 Menu Map

3.2 Menu Map

This section shows the hierarchical menu configuration on a panel key basis.

NOTE:  Represents a panel key.

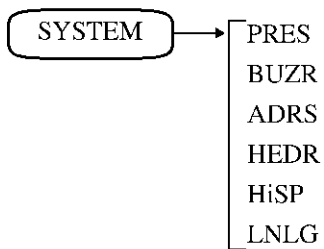
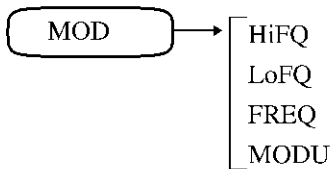
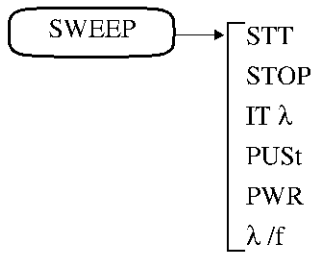
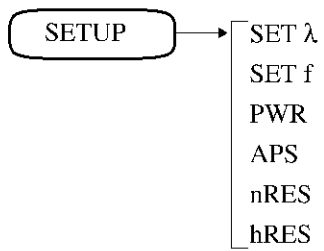

3.3 Functional Description

SETUP	Displays the SETUP mode that specifies the wavelength and optical output.
SET λ	Sets the wavelength. Wavelength range: 1525.0 nm to 1630.0 nm Set interval: Normal-resolution: 0.0001 nm High-resolution: 0.00001 nm
SET f	Sets the frequency. Frequency range: 183.92175 THz to 196.58522 THz Set interval: 0.00001 THz
PWR	Sets the optical output power.
APS	Toggles the APS (Auto Power Set) function on or off. ON Compensates for the fluctuation of the optical output due to wavelength characteristics each time you set the wavelength. OFF Disables the APS function.
<hr/>	
NOTE: <i>When the APS function is used, it takes a lot of time to set the wavelength.</i> <i>When speed is paramount, turn the APS function off.</i>	
<hr/>	
nRES	Sets the normal-resolution mode.
hRES	Sets the high-resolution mode.
SWEEP	
STT	Sets the sweep start wavelength.
STOP	Sets the sweep stop wavelength.
IT λ	Sets the sweep interval.
PUSt	Sets the wavelength (frequency) set time.
PWR	Sets the optical output power.
λ/f	Toggles between a wavelength sweep and a frequency sweep. Wavelength range: 1525.0 nm to 1630.0 nm Set interval: 0.0001 nm Frequency range: 183.92175 THz to 196.58522 THz Set interval: 0.00001 THz
MOD	Displays the MODULATION mode that turns the low-frequency modulation on or off, turns the high-frequency modulation on or off, and sets low-frequency modulation parameters.
HiFQ	Turns the high-frequency modulation on or off.
LoFQ	Turns the low-frequency modulation on or off.

3.3 Functional Description

NOTE: *Use the step keys or the data knob to enter data because the numeric keys cannot be used.*

<i>FREQ</i>	Sets the frequency for low-frequency modulation parameters.
<i>MODU</i>	Sets the modulation factor for low-frequency modulation parameters.
CAL	Displays the CAL mode used to perform zero-offset adjustments and wavelength positioning of the photo diode used for optical output measurements.
<i>ZERO</i>	Makes a zero-offset adjustment of the photo diode used for optical output measurement.
SYSTEM	
<i>PRES</i>	Presets various parameters.
<i>BUZR</i>	Enables or disables the buzzer.
<i>ADRS</i>	Sets the GPIB address.
<i>HEDR</i>	Turns the header display on or off.
<i>HiSP</i>	Turns the high-speed mode on or off.
<i>LNLG</i>	Sets the method of displaying the optical output.
LIN	Displays the optical output in μW .
LOG	Displays the optical output in dBm.

3.4 Initial Settings

Table 3-1 Initial Settings

Items	Initial values	GPIB command
Initial wavelength	1550.0 nm	WL1550.0
Initial optical output	+2.0 dBm	PW2.0
Initial ACTIVE state	CLOSE	ACT0
Initial operation mode	SETUP mode	---
Optical output display	LOG (dBm)	DW0
Optical output flatness function	ON	APS1
High speed mode	OFF	HIS0
Wavelength resolution mode	Normal mode	RES0
Delimiter	CR+LF (with EOI)	DL0
Buzzer	ON	BZ1
Low-frequency modulation	OFF	LFQ0
High-frequency modulation	OFF	HFQ0
LCD backlight	ON	LCD1
Internal low-frequency modulation Frequency	10 kHz	FLF103
Internal low-frequency modulation Modulation factor	4000	MLF14
Sweep start wavelength	1525.0 nm	STW1525.0
Sweep stop wavelength	1630.0 nm	SPW1630.0
Sweep step size in wavelengths	0.1 nm	ITW0.1
Pause time in each step	5.0 sec	PST5.0
Sweep start frequency	196.58522 THz	STF196.58522
Sweep stop frequency	183.92175 THz	SPF183.92175
Sweep step size in frequencies	0000.01 GHz	ITF0.01
Wavelength / frequency sweep mode	Wavelength sweep	DOM0

4. REMOTE PROGRAMMING

4.1 GPIB Command Index

This GPIB command index can be used as the index for Chapter 4.

<u>GPIB Command</u>	<u>Pages</u>
*RST	4-12
*TRG	4-10
ACT	4-7
APS	4-9
BZ	4-11
C	4-12
CS	4-12
DL	4-12
DOM	4-10
DW	4-11
E	4-10
FLF	4-8
H	4-12
HFQ	4-8
HIS	4-11
ITF	4-10
ITW	4-10
LCD	4-7
LFQ	4-8
MEM	4-12
MLF	4-8
MON	4-12
MSK	4-12
PST	4-10
PU	4-9
PW	4-9
REP	4-10
RES	4-9
S	4-12
SPF	4-10
SPW	4-10
STF	4-10
STP	4-10
STW	4-10
TRI	4-10
WF	4-9
WL	4-9
Z	4-12
ZR	4-7

4.1 GPIB Command Index

4.2 Overview of GPIB

The GPIB is an interface connected to the measurement device, controller, and peripheral units, etc., through a simple cable (bus line).

The GPIB is more expandable than conventional interfaces, is easy to use, and has electrical, mechanical, and functional compatibility with other manufacturers' products, making it applicable to system configurations from simple systems to automatic design systems with high-level functions using one bus cable.

To use the GPIB, first setting an "address" for each instrument connected to the bus line is required. Each instrument is assigned one or more roles from the following three roles: controller, talker (TALKER), or listener (LISTENER).

During system operation, only one "talker" can send data to the bus line, but plural "listeners" can receive it.

The controller specifies the addresses of "talker" and "listener" to transfer data from "talker" to "listener", and the controller sets setting conditions from "talker" to "listener".

Data is synchronously transferred synchronously bidirectionally between devices via eight data lines in the bit-parallel, byte-serial form. Because this is a synchronous system, using high-speed and low-speed devices together in the same system is possible.

Data (messages) transferred between devices include measurement data, measurement conditions (programs), and commands; they are in ASCII.

In addition to eight data lines, the GPIB has three handshake lines for controlling the synchronous data transmission between instruments, and five control lines for controlling the bus information flow.

4.3 GPIB Setup

1. Connecting the GPIB

The following figure shows the standard GPIB connector and how it can be connected in parallel, or “stacked” with other connectors. Attach the GPIB connectors and secure them by tightening the screws to prevent them from coming apart during use.

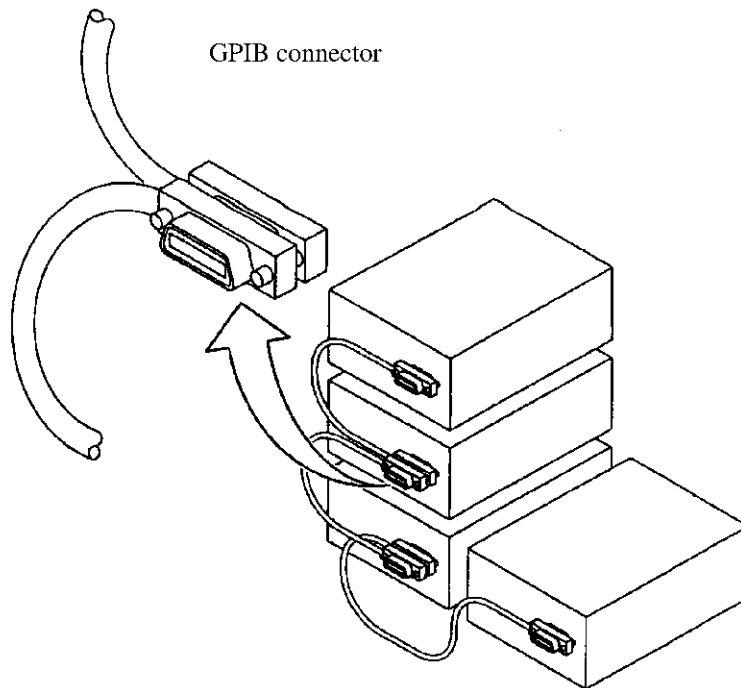

The following conditions should be observed when using a GPIB interface:

- The total GPIB cable length in a single bus system must not be more than 20 m (you can calculate the current cable length using the formula $\text{total length} = n \times 2 \text{ m}$, where, n is the number of devices to be connected, including the GPIB controller).
- No more than 15 devices can be connected to a single bus system.
- There are no restrictions concerning the method of connection between cables. However, no more than three GPIB connectors should be connected to a single device, since more than this may damage the connector mounting due to excessive strain.

(Example) The total cable length in a system with five devices should be 10 m or less ($2 \text{ m} \times 5 \text{ devices} = 10 \text{ m}$). There is no restriction on the length of the cables between the individual devices as long as the total length does not exceed 10 m. However, if you connect 10 devices or more, make sure that at least some of the cables attaching the devices are less than 2 m so that the total is less than 20 m.

2. Setting the GPIB Address

Set the GPIB address on the SYSTEM Mode screen.

The address 08 is set at the factory prior to shipment. Once the address is saved, it remains unchanged even if the power is turned on or off.

4.4 Interface Functions

4.4 Interface Functions

Table 4-1 shows the Q8155 interface functions.

Table 4-1 Interface Functions

Code	Function
SH1	Source handshake
AH1	Acceptor handshake
T6	Basic talker
L4	Basic listener
SR1	Service request
RL1	Remote or local
PP0	No parallel function
DC1	Device clear
DT1	Device trigger
C0	No controller function
E2	Three-state-bus-driver used

4.5 Service Request (SRQ)

This instrument sends a service request to the controller when the following conditions are met in S0 mode:

1. A service request generated when the operation has been completed
A service request is sent together with the operation completion bit (bit 2) in the status byte, when an operation corresponding to the Z, C (*RST), MEM, WL, WF, PW, PU or E (*TRG) command has been completed normally.
2. Service request due to an error
A service request is sent together with the error status bit (bit 1) and error type bit (bit 4) when any commands other than those previously defined are received or the specified values are out of their ranges.

4.6 Delimiter

The following four delimiters can be received by this instrument:

CR + LF (with EOI)

LF

EOI

LF (with EOI)

The delimiter, which is output when this instrument functions as talker, must be specified using the DL command.

4.7 Status Byte

4.7 Status Byte

The functions of each bit in the status byte (used for this light source) are shown below.

b7	b6	b5	b4	b3	b2	b1	b0
----	----	----	----	----	----	----	----

- b0: Command is being received. (0: Ready, 1: Busy)
- b1: Error status (0: No error, 1: Error)
*: This bit is cleared when the next program code is received.
- b2: Operation completion flag (“Z”, “C (*RST)”, “MEM”, “WL”, “WF”, “PW”, “PU” or “E (*TRG)” command operation only)
- b3: Sweep status (0: Not in sweep, 1: In sweep)
- b4: Error type (0: Syntax error, 1: Numeric range error)
- b5: Alarm detection (0: No alarms have been detected. 1: An alarm has been detected.)
- b6: RQS (0:Not Request, 1:Request)
- b7: Unused

4.8 Code Table

CAUTION: *Up to 64 characters can be set on a single line using a comma between two adjacent fields. (However, "Z", "C", "MEM", "E", "REP", "TRI", "STP" or query command can be used individually.)*
A command, which was entered after an error occurred, is invalid.

Table 4-2 ACTIVE

Item	Command		Query	Description
	Header	Parameter		
ACTIVE ACTIVE MODE	ACT	0, 1	ACT?	0: CLOSE (Optical output is off.) 1: OPEN (Optical output is on.)

Table 4-3 BKLT

Item	Command		Query	Description
	Header	Parameter		
BKLT LCD back-light	LCD	0, 1	LCD?	0: LCD backlight is turned off. 1: LCD backlight is turned on.

Table 4-4 CAL

Item	Command		Query	Description
	Header	Parameter		
CAL Compensation for ZERO	ZR	---	---	Compensation for photodetector offset

4.8 Code Table

Table 4-5 MOD

Item	Command		Query	Description																																				
	Header	Parameter																																						
MOD																																								
Low frequency modulation Frequency setting	FLF	201 to 304	FLF?	n = 201 to 304 (200 Hz to 300 kHz) The highest two digits are expressed as a real part (10 to 99) and the least significant digit is expressed as an exponent (1 to 4). For example, 200 Hz is expressed as 20 x 10 ¹ , then n is 201 and 300 kHz is expressed as 30 x 10 ⁴ , then n is 304.																																				
Modulation factor setting	MLF	0 to 15	MLF?	<table border="1"> <thead> <tr> <th>n</th> <th>Gain</th> <th>n</th> <th>Gain</th> </tr> </thead> <tbody> <tr> <td>0</td> <td>1</td> <td>8</td> <td>100</td> </tr> <tr> <td>1</td> <td>2</td> <td>9</td> <td>200</td> </tr> <tr> <td>2</td> <td>4</td> <td>10</td> <td>400</td> </tr> <tr> <td>3</td> <td>8</td> <td>11</td> <td>800</td> </tr> <tr> <td>4</td> <td>10</td> <td>12</td> <td>1000</td> </tr> <tr> <td>5</td> <td>20</td> <td>13</td> <td>2000</td> </tr> <tr> <td>6</td> <td>40</td> <td>14</td> <td>4000</td> </tr> <tr> <td>7</td> <td>80</td> <td>15</td> <td>8000</td> </tr> </tbody> </table>	n	Gain	n	Gain	0	1	8	100	1	2	9	200	2	4	10	400	3	8	11	800	4	10	12	1000	5	20	13	2000	6	40	14	4000	7	80	15	8000
n	Gain	n	Gain																																					
0	1	8	100																																					
1	2	9	200																																					
2	4	10	400																																					
3	8	11	800																																					
4	10	12	1000																																					
5	20	13	2000																																					
6	40	14	4000																																					
7	80	15	8000																																					
Internal low frequency modulation	LFQ	0, 1	LFQ?	0: Internal low frequency modulation is turned off. 1: Internal low frequency modulation is turned on.																																				
External high frequency modulation	HFQ	0, 1	HFQ?	0: External low frequency modulation is turned off. 1: External low frequency modulation is turned on.																																				

Table 4-6 SETUP

Item	Command		Query	Description
	Header	Parameter		
SETUP				
Wavelength setting	WL	Numeric value + unit	WL?	Unit : nm Acquires the wavelength. (WLnnnn.nnnn)
Frequency setting	WF	Numeric value + unit	WF?	Unit : THz Acquires the frequency. (WFnnn.nnnnn)
Optical output setting	PW	Numeric value + unit	PW?	Unit : dBm Acquires the optical output. (PW±nn.nn)
	PU	Numeric value + unit	PU?	Unit : μW Acquires the optical output. (PUnnnn.n)
	---	---	PS?	Acquires the optical output settings. (PS±nn.nn[dBm])
Wavelength resolution setting	RES	0, 1	RES?	0: Nomal mode 1: High resolution mode
Optical output flatness function	APS	0, 1	APS?	0: Optical output flatness function is turned off. 1: Optical output flatness function is turned on (see *1).

*1: Compensates for the wavelength characteristics to obtain a more even optical output.

4.8 Code Table

Table 4-7 SWEEP

Item	Command		Query	Description
	Header	Parameter		
SWEEP				
SINGLE	E *TRG	-	-	Sweeps once within the specified range.
REPEAT	REP	-	-	Sweeps repeatedly within the specified range.
TRIGGER	TRI	-	-	In 1 step mode when set to Trigger mode.
STOP	STP	-	-	Stops sweeping.
Sweep start wavelength	STW	Numeric value + unit	STW?	Unit : nm Acquires the sweep start wavelength. (STWnnnn.nnnn)
Sweep start frequency	STF	Numeric value + unit	STF?	Unit : THz Acquires the sweep start wavelength. (STFnnn.nnnnn)
Sweep stop wavelength	SPW	Numeric value + unit	SPW?	Unit : nm Acquires the sweep start frequency. (SPWnnnn.nnnn)
Sweep stop frequency	SPF	Numeric value + unit	SPF?	Unit : THz Acquires the sweep stop wavelength. (SPFnnn.nnnnn)
Wavelength settling time	PST	Numeric value + unit	PST?	Unit : sec Acquires the wavelength settling time. (PSTnn.n)
Sweep wavelength interval	ITW	Numeric value + unit	ITW?	Unit : nm Acquires the sweep wavelength interval. (ITWnn.nnnn)
Sweep frequency interval	ITF	Numeric value + unit	ITF?	Unit : GHz Acquires the sweep frequency interval. (ITFnnnn.nn)
Wavelength and frequency switching	DOM	0, 1	DOM?	0: Wavelength sweep operation 1: Frequency sweep operation

Table 4-8 SYSTEM

Item	Command		Query	Description
	Header	Parameter		
SYSTEM				
Optical output display setting	DW	0, 1	DW?	0: Optical output is displayed in dBm. 1: Optical output is displayed in μ W.
Buzzer	BZ	0, 1	BZ?	0: OFF 1: ON
High-speed mode setting	HIS	0, 1	HIS?	0: OFF 1: ON

4.8 Code Table

Table 4-9 Controlling Data Output and Others

Item	Command		Query	Description
	Header	Parameter		
Initialization	Z	---	---	Starts using the factory default settings. See Note 1.
	C *RST	---	---	Re-initializes the instrument. See Note 1.
Parameter memory	MEM	---	---	Updates the default parameters. See Note 1.
Monitor display control	MON	0, 1	MON?	0: Does not display wavelength, frequency and optical output. 1: Displays wavelength, frequency and optical output.
Delimiter specification	DL	0, 1, 2, 3	---	0: Sets the delimiter to CR + LF (with EOI). 1: Sets the delimiter to LF. 2: Sets the delimiter to EOI. 3: Sets the delimiter to LF (with EOI).
Service request	S	0, 1	S?	0: Sends the service request. 1: Does not send the service request.
Header mode index	H	0, 1	H?	0: Header OFF 1: Header ON
Clearing status byte	CS	---	---	
Masking status byte	MSK	0 to 255	MSK?	Sets "1" to the bit to be masked in the status byte. Reads the mask.
Output request for the unit ID	---	---	IDN? *IDN?	Output request for manufacturer name, product name, serial number and software revision.

Note 1: This command issues a service request when the operation has been completed if the SRQ is enabled.
However, when using the multi-command mode, this command is issued when the execution of the last command has been completed.

5. SUPPLEMENTARY INFORMATION

5.1 Principle of Operation

The Q8155 is a tunable light source that consists of a Fabry-Perot laser diode and external resonator using filter. The filter allows you to tune the wavelength as desired. Figure 5-1 shows the Q8155 configuration.

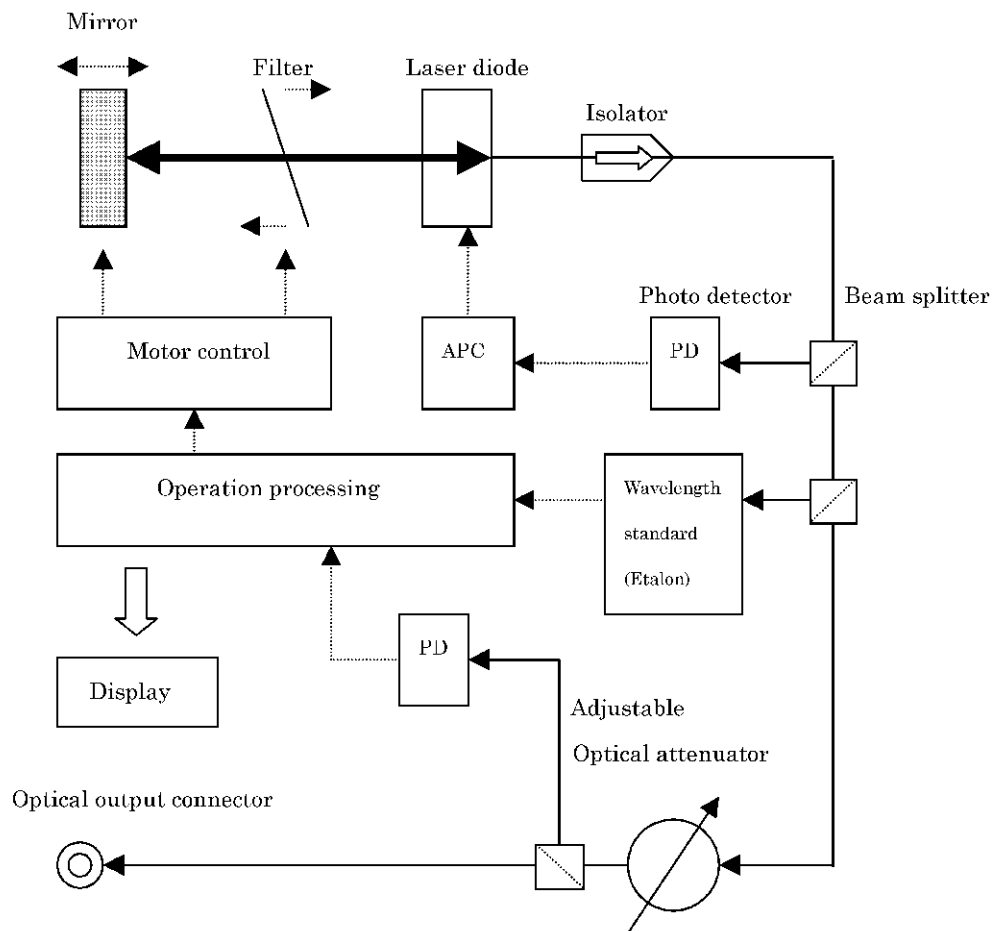

Figure 5-1 Configuration of the Q8155

The light emitted from the laser diode is amplified as it is repeatedly reflected between the laser diode end face and the mirror, and then output as an intensified and narrow beam of light. The laser resonator can maintain a steady oscillation, because the isolator allows the light to pass in one direction only, as indicated by the arrow. The light is then divided by the first beam splitter and sensed by the photo detector in the APC (automatic power control). The APC is used to control the optical output constant. The light divided by the second beam splitter is input to the etalon used to control the wavelength reference and comparison so that wavelength can be set with precision for a long period of time.

The main output light is adjusted with an adjustable optical attenuator to the specified optical output level. The light divided by the final beam splitter is monitored by the photo detector used for the compensating control. As a result, the optical output level can be set more precisely.

5.2 APS Function

5.2 APS Function

The Auto Power Set (APS) is designed to keep the optical output at a constant level by compensating for optical output variations which may occur when wavelength settings have been changed due to wavelength characteristics. We recommend that the APS function be turned off when a higher priority is given to making measurements without causing any unnecessary delays.

6. SPECIFICATIONS

Characteristics		Specification
Wavelength range		1525 nm ~ 1630 nm
Wavelength resolution		0.1 pm
Absolute wavelength accuracy		± 10.0 pm
Relative wavelength accuracy		± 7 pm
Repeatability of wavelength		± 5 pm
Stability of wavelength (1 hour at a constant ambient temperature)		$\leq \pm 0.8$ pm
Variable speed (typical in 1, 10 or 100 nm step)		600 ms/800 ms/2.8 s (*1)
Light width (typical)		100 kHz (*2)
Output power (*3)		$\geq +2$ dBm (1540 nm to 1620 nm) ≥ 0 dBm (1525 nm to 1630 nm)
Minimum settable output power		-30 dBm
Power stability (1 hour at a constant ambient temperature)		± 0.03 dB
Power repeatability (typical)		± 0.01 dB
Power linearity (typical)		± 0.1 dB
Power flatness (in reference to the wavelength)		± 0.2 dB (Typical value when the APS function is set) ± 0.4 dB (Typical value when the APS function is not set) (*4)
Side-mode suppression ratio (typical)		≥ 50 dBc (*5)
Relative intensity noise (RIN, typical)		-160 dB/Hz
Optical modulation function	Internal low frequency modulation	200 Hz to 300 kHz, a modulation factor of approximately 30%
	External high frequency modulation	10 MHz to 120 MHz
Optical output monitor function		The output power can be monitored on the screen.
Optical output variable attenuation function		Can be variable up to -30 dBm.

*1 : When High Speed is turned on, APS is turned off, and monitor display is turned off.

*2 : Approximately 10 MHz when High Speed is turned on. The frequency can be set to up to 50 MHz using the internal frequency modulation function.

*3 : The absolute power accuracy may not be accurate because measurement values are affected by factors such as the characteristics of the fiber or the state of matching.

*4 : When APS is set to OFF, an output power difference of approximately 2 dB occurs in the wavelength ranges 1540 nm to 1620 nm, and 1525 nm to 1630 nm. Therefore, when using the two wavelengths continuously, set APS to ON.

*5 : Measured using the heterodyne method.

6. SPECIFICATIONS

Characteristics		Specification
Optical output	Output fiber	Polarization-retention fiber (panda)
	Polarized status	Linearly polarized light, Output connector positioning key, Quenching ratio: 20 dB (typical)
	Connector	FC-type optical connector (standard) SC-type optical connector (option) ST-type optical connector (option)
Input/Output interface	GPIB	IEEE488-1978
	Step trigger signal output	BNC, TTL level
	External high frequency modulation input	BNC, input impedance 50Ω , Maximum input power +10dBm
General specifications	Operating environment range	Temperature range: +10°C to +35°C Relative humidity 85% or less (without condensation)
	Storage environment range	Temperature range: -10°C to +50°C Relative humidity 85% or less (without condensation)
	AC input power source	100 VAC to 240 VAC, 50 or 60 Hz, 200 VA or less
	Outer dimensions	Approximately 350 (W) × 132 (H) × 450 (D) mm
	Mass	16 kg or less

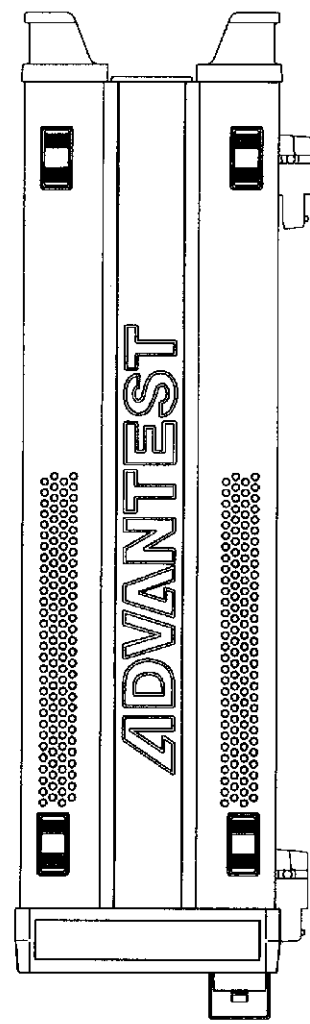
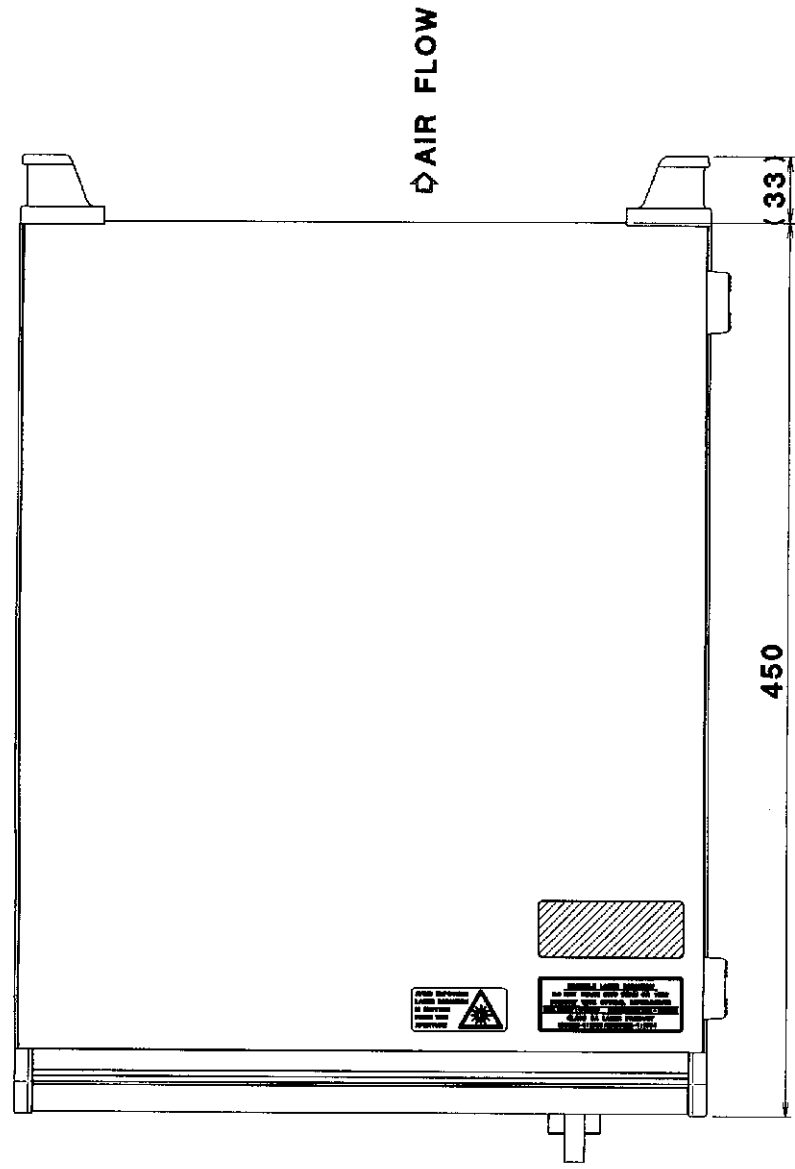
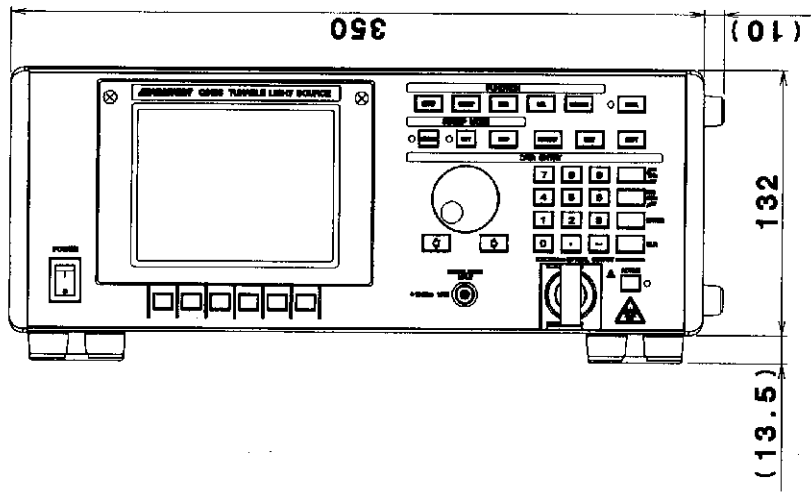

DIMENSIONAL OUTLINE DRAWING

Unit : mm

CAUTION

This drawing shows external dimensions of this instrument.
The difference in products and options used can cause a change in the appearance of the instrument.

ALPHABETICAL INDEX

[Symbol]		
λ/f	3-2, 3-3	
[A]		
Accessories	1-2	
ADRS	3-2, 3-4	
APS	3-2, 3-3	
APS Function	5-2	
[B]		
Basic Operation	2-9	
BUZR	3-2, 3-4	
[C]		
CAL	3-2, 3-4	
Calibration	1-15	
Changing the Start-up Parameters	2-21	
Cleaning	1-14	
Cleaning optical connector tip	1-13	
Cleaning, Storing and Transporting the Q8155	1-13	
Code Table	4-7	
CW Optical Output Power	2-15	
[D]		
DATA ENTRY Section	2-3	
Delimiter	4-5	
Display Section	2-4	
[E]		
Environmental Conditions	1-4	
Errors and Alarms	1-12	
[F]		
FREQ	3-2, 3-4	
Front Panel	2-1	
FUNCTION Mode	2-11	
FUNCTION Section	2-2	
Functional Description	3-3	
[G]		
GPIB Command Index	4-1	
GPIB Section	2-4	
GPIB Setup	4-3	
[H]		
HEDR	3-2, 3-4	
HiFQ	3-2, 3-3	
High-frequency Modulation	2-20	
HiSP	3-2, 3-4	
hRES	3-2, 3-3	
[I]		
I/O Port Section	2-5	
Initial Settings	3-5	
Instruments Required for the System Checkout	1-8	
Interface Functions	4-4	
IT λ	3-2, 3-3	
[L]		
LNLG	3-2, 3-4	
LoFQ	3-2, 3-3	
Low-frequency Modulation	2-20	
[M]		
Menu Index	3-1	
Menu Map	3-2	
Menu Operation and Data Entry	2-9	
MOD	3-2, 3-3	
MODU	3-2, 3-4	
Modulated Signal Setup	2-20	
[N]		
nRES	3-2, 3-3	
[O]		
OPERATION	2-1	
Other Sections	2-6	
Overview of GPIB	4-2	
[P]		
Part Life Spans	1-15	
Power Cable	1-6	
Power cable options	1-3	
Power Fuse	1-5	
Power Requirements	1-5	
Power Switch Section	2-5	
Precautions in Use	1-7	
PRES	3-2, 3-4	
Principle of Operation	5-1	
PUS _t	3-2, 3-3	
PWR	3-2, 3-3	

Alphabetical Index

[R]

Rear Panel 2-7
REFERENCE 3-1
REMOTE PROGRAMMING 4-1
Repeat Sweep Mode 2-18
Replacing optical connector-adapter 1-13
Resetting the Instrument
to the Factory Presets 2-22

[S]

Screen Annotation 2-8
Service Request 4-5
SET f 3-2, 3-3
SET λ 3-2, 3-3
SETUP 3-2, 3-3
Single Step Mode 2-19
Single Sweep Mode 2-17
SPECIFICATIONS 6-1
Standard Accessories 1-2
Start-up Parameters 2-21
Start-up Screen 1-8
Status Byte 4-6
STOP 3-2, 3-3
Storing 1-14
STT 3-2, 3-3
SUPPLEMENTARY INFORMATION . 5-1
SWEEP 3-2, 3-3
SWEEP Mode Section 2-2
SYSTEM 3-2, 3-4
System Checkout 1-8

[T]

Transporting 1-14

[W]

Warming up 1-15

[Z]

ZERO 3-2, 3-4

IMPORTANT INFORMATION FOR ADVANTEST SOFTWARE

PLEASE READ CAREFULLY: This is an important notice for the software defined herein. Computer programs including any additions, modifications and updates thereof, operation manuals, and related materials provided by Advantest (hereafter referred to as "SOFTWARE"), included in or used with hardware produced by Advantest (hereafter referred to as "PRODUCTS").

SOFTWARE License

All rights in and to the SOFTWARE (including, but not limited to, copyright) shall be and remain vested in Advantest. Advantest hereby grants you a license to use the SOFTWARE only on or with Advantest PRODUCTS.

Restrictions

- (1) You may not use the SOFTWARE for any purpose other than for the use of the PRODUCTS.
- (2) You may not copy, modify, or change, all or any part of, the SOFTWARE without permission from Advantest.
- (3) You may not reverse engineer, de-compile, or disassemble, all or any part of, the SOFTWARE.

Liability

Advantest shall have no liability (1) for any PRODUCT failures, which may arise out of any misuse (misuse is deemed to be use of the SOFTWARE for purposes other than its intended use) of the SOFTWARE. (2) For any dispute between you and any third party for any reason whatsoever including, but not limited to, infringement of intellectual property rights.

LIMITED WARRANTY

1. Unless otherwise specifically agreed by Seller and Purchaser in writing, Advantest will warrant to the Purchaser that during the Warranty Period this Product (other than consumables included in the Product) will be free from defects in material and workmanship and shall conform to the specifications set forth in this Operation Manual.
2. The warranty period for the Product (the "Warranty Period") will be a period of one year commencing on the delivery date of the Product.
3. If the Product is found to be defective during the Warranty Period, Advantest will, at its option and in its sole and absolute discretion, either (a) repair the defective Product or part or component thereof or (b) replace the defective Product or part or component thereof, in either case at Advantest's sole cost and expense.
4. This limited warranty will not apply to defects or damage to the Product or any part or component thereof resulting from any of the following:
 - (a) any modifications, maintenance or repairs other than modifications, maintenance or repairs (i) performed by Advantest or (ii) specifically recommended or authorized by Advantest and performed in accordance with Advantest's instructions;
 - (b) any improper or inadequate handling, carriage or storage of the Product by the Purchaser or any third party (other than Advantest or its agents);
 - (c) use of the Product under operating conditions or environments different than those specified in the Operation Manual or recommended by Advantest, including, without limitation, (i) instances where the Product has been subjected to physical stress or electrical voltage exceeding the permissible range and (ii) instances where the corrosion of electrical circuits or other deterioration was accelerated by exposure to corrosive gases or dusty environments;
 - (d) use of the Product in connection with software, interfaces, products or parts other than software, interfaces, products or parts supplied or recommended by Advantest;
 - (e) incorporation in the Product of any parts or components (i) provided by Purchaser or (ii) provided by a third party at the request or direction of Purchaser or due to specifications or designs supplied by Purchaser (including, without limitation, any degradation in performance of such parts or components);
 - (f) Advantest's incorporation or use of any specifications or designs supplied by Purchaser;
 - (g) the occurrence of an event of force majeure, including, without limitation, fire, explosion, geological change, storm, flood, earthquake, tidal wave, lightning or act of war; or
 - (h) any negligent act or omission of the Purchaser or any third party other than Advantest.
5. **EXCEPT TO THE EXTENT EXPRESSLY PROVIDED HEREIN, ADVANTEST HEREBY EXPRESSLY DISCLAIMS, AND THE PURCHASER HEREBY WAIVES, ALL WARRANTIES, WHETHER EXPRESS OR IMPLIED, STATUTORY OR OTHERWISE, INCLUDING, WITHOUT LIMITATION, (A) ANY WARRANTY OF MERCHANTABILITY OR FITNESS FOR A PARTICULAR PURPOSE AND (B) ANY WARRANTY OR REPRESENTATION AS TO THE VALIDITY, SCOPE, EFFECTIVENESS OR USEFULNESS OF ANY TECHNOLOGY OR ANY INVENTION.**
6. **THE REMEDY SET FORTH HEREIN SHALL BE THE SOLE AND EXCLUSIVE REMEDY OF THE PURCHASER FOR BREACH OF WARRANTY WITH RESPECT TO THE PRODUCT.**
7. **ADVANTEST WILL NOT HAVE ANY LIABILITY TO THE PURCHASER FOR ANY INDIRECT, INCIDENTAL, SPECIAL, CONSEQUENTIAL OR PUNITIVE DAMAGES, INCLUDING, WITHOUT LIMITATION, LOSS OF ANTICIPATED PROFITS OR REVENUES, IN ANY AND ALL CIRCUMSTANCES, EVEN IF ADVANTEST HAS BEEN ADVISED OF THE POSSIBILITY OF SUCH DAMAGES AND WHETHER ARISING OUT OF BREACH OF CONTRACT, WARRANTY, TORT (INCLUDING, WITHOUT LIMITATION, NEGLIGENCE), STRICT LIABILITY, INDEMNITY, CONTRIBUTION OR OTHERWISE. TORT (INCLUDING, WITHOUT LIMITATION, NEGLIGENCE), STRICT LIABILITY, INDEMNITY, CONTRIBUTION OR OTHERWISE.**
8. **OTHER THAN THE REMEDY FOR THE BREACH OF WARRANTY SET FORTH HEREIN, ADVANTEST SHALL NOT BE LIABLE FOR, AND HEREBY DISCLAIMS TO THE FULLEST EXTENT PERMITTED BY LAW ANY LIABILITY FOR, DAMAGES FOR PRODUCT FAILURE OR DEFECT, WHETHER ARISING OUT OF BREACH OF CONTRACT, TORT (INCLUDING, WITHOUT LIMITATION, NEGLIGENCE), STRICT LIABILITY, INDEMNITY, CONTRIBUTION OR OTHERWISE.**

CUSTOMER SERVICE DESCRIPTION

In order to maintain safe and trouble-free operation of the Product and to prevent the incurrence of unnecessary costs and expenses, Advantest recommends a regular preventive maintenance program under its maintenance agreement.

Advantest's maintenance agreement provides the Purchaser on-site and off-site maintenance, parts, maintenance machinery, regular inspections, and telephone support and will last a maximum of ten years from the date the delivery of the Product. For specific details of the services provided under the maintenance agreement, please contact the nearest Advantest office listed at the end of this Operation Manual or Advantest's sales representatives.

Some of the components and parts of this Product have a limited operating life (such as, electrical and mechanical parts, fan motors, unit power supply, etc.). Accordingly, these components and parts will have to be replaced on a periodic basis. If the operating life of a component or part has expired and such component or part has not been replaced, there is a possibility that the Product will not perform properly. Additionally, if the operating life of a component or part has expired and continued use of such component or part damages the Product, the Product may not be repairable. Please contact the nearest Advantest office listed at the end of this Operation Manual or Advantest's sales representatives to determine the operating life of a specific component or part, as the operating life may vary depending on various factors such as operating condition and usage environment.

SALES & SUPPORT OFFICES

Advantest Korea Co., Ltd.

22BF, Kyobo KangNam Tower,
1303-22, Seocho-Dong, Seocho-Ku, Seoul #137-070, Korea
Phone: +82-2-532-7071
Fax: +82-2-532-7132

Advantest (Suzhou) Co., Ltd.

Shanghai Branch Office:
Bldg. 6D, NO.1188 Gumei Road, Shanghai, China 201102 P.R.C.
Phone: +86-21-6485-2725
Fax: +86-21-6485-2726

Shanghai Branch Office:
406/F, Ying Building, Quantum Plaza, No. 23 Zhi Chun Road,
Hai Dian District, Beijing,
China 100083
Phone: +86-10-8235-3377
Fax: +86-10-8235-6717

Advantest (Singapore) Pte. Ltd.

438A Alexandra Road, #08-03/06
Alexandra Technopark Singapore 119967
Phone: +65-6274-3100
Fax: +65-6274-4055

Advantest America, Inc.

3201 Scott Boulevard, Suite, Santa Clara, CA 95054, U.S.A
Phone: +1-408-988-7700
Fax: +1-408-987-0691

ROHDE & SCHWARZ Europe GmbH

Mühldorfstraße 15 D-81671 München, Germany
(P.O.B. 80 14 60 D-81614 München, Germany)
Phone: +49-89-4129-13711
Fax: +49-89-4129-13723

ADVANTEST[®]

<http://www.advantest.co.jp>