

---

**ADVANTEST®**  
ADVANTEST CORPORATION

---

**Q8163**

***Optical Polarization Scrambler***

***Operation Manual***

MANUAL NUMBER FOE-8324191D02

---



---

## Safety Summary

To ensure thorough understanding of all functions and to ensure efficient use of this instrument, please read the manual carefully before using. Note that Advantest bears absolutely no responsibility for the result of operations caused due to incorrect or inappropriate use of this instrument.

If the equipment is used in a manner not specified by Advantest, the protection provided by the equipment may be impaired.

- **Warning Labels**

Warning labels are applied to Advantest products in locations where specific dangers exist. Pay careful attention to these labels during handling. Do not remove or tear these labels. If you have any questions regarding warning labels, please ask your nearest Advantest dealer. Our address and phone number are listed at the end of this manual.

Symbols of those warning labels are shown below together with their meaning.

**DANGER:** Indicates an imminently hazardous situation which will result in death or serious personal injury.

**WARNING:** Indicates a potentially hazardous situation which will result in death or serious personal injury.

**CAUTION:** Indicates a potentially hazardous situation which will result in personal injury or a damage to property including the product.

- **Basic Precautions**

Please observe the following precautions to prevent fire, burn, electric shock, and personal injury.

- Use a power cable rated for the voltage in question. Be sure however to use a power cable conforming to safety standards of your nation when using a product overseas.
- When inserting the plug into the electrical outlet, first turn the power switch OFF and then insert the plug as far as it will go.
- When removing the plug from the electrical outlet, first turn the power switch OFF and then pull it out by gripping the plug. Do not pull on the power cable itself. Make sure your hands are dry at this time.
- Before turning on the power, be sure to check that the supply voltage matches the voltage requirements of the instrument.
- Connect the power cable to a power outlet that is connected to a protected ground terminal. Grounding will be defeated if you use an extension cord which does not include a protected ground terminal.
- Be sure to use fuses rated for the voltage in question.
- Do not use this instrument with the case open.
- Do not place anything on the product and do not apply excessive pressure to the product. Also, do not place flower pots or other containers containing liquid such as chemicals near this

product.

- When the product has ventilation outlets, do not stick or drop metal or easily flammable objects into the ventilation outlets.
- When using the product on a cart, fix it with belts to avoid its drop.
- When connecting the product to peripheral equipment, turn the power off.

- **Caution Symbols Used Within this Manual**

Symbols indicating items requiring caution which are used in this manual are shown below together with their meaning.

**DANGER:** Indicates an item where there is a danger of serious personal injury (death or serious injury).

**WARNING:** Indicates an item relating to personal safety or health.

**CAUTION:** Indicates an item relating to possible damage to the product or instrument or relating to a restriction on operation.

- **Safety Marks on the Product**

The following safety marks can be found on Advantest products.



: ATTENTION - Refer to manual.



: Protective ground (earth) terminal.



: DANGER - High voltage.



: CAUTION - Risk of electric shock.

- **Replacing Parts with Limited Life**

The following parts used in the instrument are main parts with limited life.

Replace the parts listed below before their expected lifespan has expired to maintain the performance and function of the instrument.

Note that the estimated lifespan for the parts listed below may be shortened by factors such as the environment where the instrument is stored or used, and how often the instrument is used.

The parts inside are not user-replaceable. For a part replacement, please contact the Advantest sales office for servicing.

Each product may use parts with limited life.

For more information, refer to the section in this document where the parts with limited life are described.

## Main Parts with Limited Life

Part name	Life
Unit power supply	5 years
Fan motor	5 years
Electrolytic capacitor	5 years
LCD display	6 years
LCD backlight	2.5 years
Floppy disk drive	5 years
Memory backup battery	5 years

- **Hard Disk Mounted Products**

The operational warnings are listed below.

- Do not move, shock and vibrate the product while the power is turned on.  
Reading or writing data in the hard disk unit is performed with the memory disk turning at a high speed. It is a very delicate process.
- Store and operate the products under the following environmental conditions.  
An area with no sudden temperature changes.  
An area away from shock or vibrations.  
An area free from moisture, dirt, or dust.  
An area away from magnets or an instrument which generates a magnetic field.
- Make back-ups of important data.  
The data stored in the disk may become damaged if the product is mishandled. The hard disc has a limited life span which depends on the operational conditions. Note that there is no guarantee for any loss of data.

- **Precautions when Disposing of this Instrument**

When disposing of harmful substances, be sure dispose of them properly with abiding by the state-provided law.

Harmful substances: (1) PCB (polycarbon biphenyl)  
(2) Mercury  
(3) Ni-Cd (nickel cadmium)  
(4) Other  
Items possessing cyan, organic phosphorous and hexadic chromium and items which may leak cadmium or arsenic (excluding lead in solder).

Example: fluorescent tubes, batteries

# Environmental Conditions

This instrument should be only be used in an area which satisfies the following conditions:

- An area free from corrosive gas
- An area away from direct sunlight
- A dust-free area
- An area free from vibrations
- Altitude of up to 2000 m

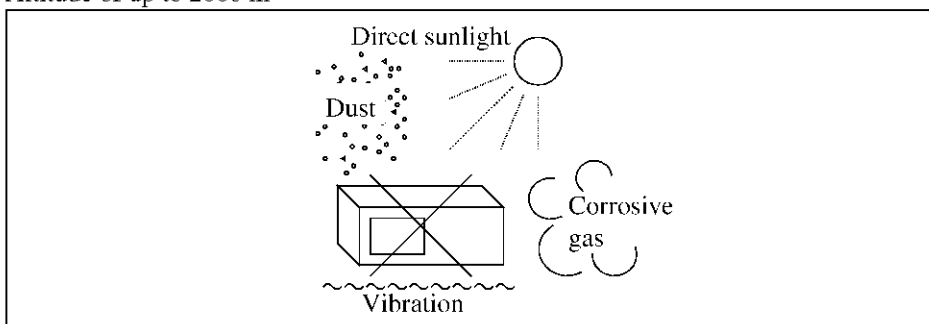

**Figure-1 Environmental Conditions**

- Operating position

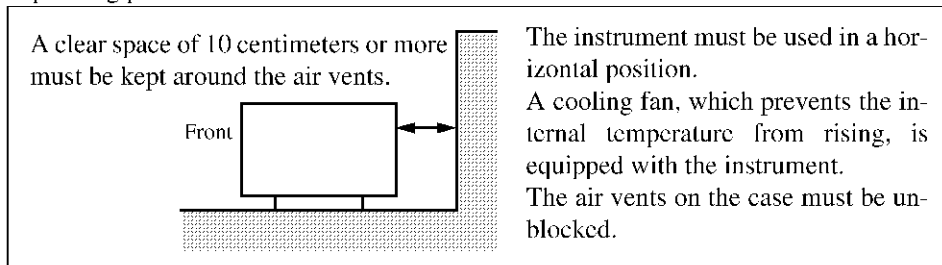

**Figure-2 Operating Position**

- Storage position

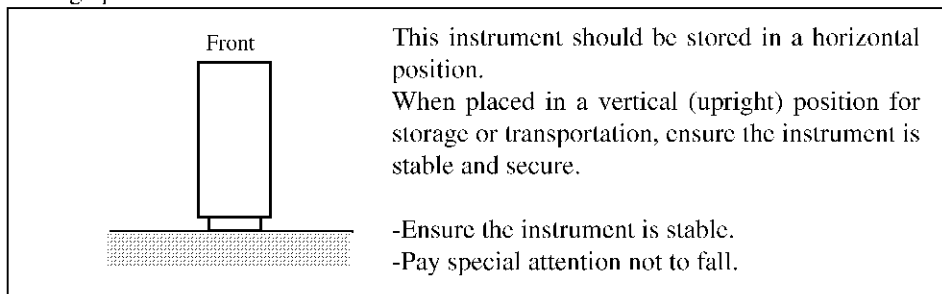

**Figure-3 Storage Position**

- The classification of the transient over-voltage, which exists typically in the main power supply, and the pollution degree is defined by IEC61010-1 and described below.

Impulse withstand voltage (over-voltage) category II defined by IEC60364-4-443

Pollution Degree 2

## Types of Power Cable

Replace any references to the power cable type, according to the following table, with the appropriate power cable type for your country.

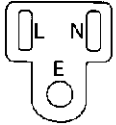
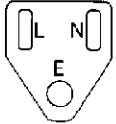
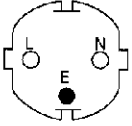
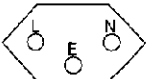
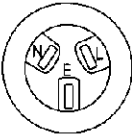
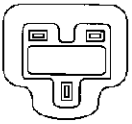
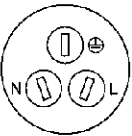
Plug configuration	Standards	Rating, color and length	Model number (Option number)
	PSE: Japan  Electrical Appliance and Material Safety Law	125 V at 7 A Black 2 m (6 ft)	Straight: A01402  Angled: A01412
	UL: United States of America  CSA: Canada	125 V at 7 A Black 2 m (6 ft)	Straight: A01403 (Option 95)  Angled: A01413
	CEE: Europe DEMKO: Denmark NEMKO: Norway VDE: Germany KEMA: The Netherlands CEBEC: Belgium OVE: Austria FIMKO: Finland SEMKO: Sweden	250 V at 6 A Gray 2 m (6 ft)	Straight: A01404 (Option 96)  Angled: A01414
	SEV: Switzerland	250 V at 6 A Gray 2 m (6 ft)	Straight: A01405 (Option 97)  Angled: A01415
	SAA: Australia, New Zealand	250 V at 6 A Gray 2 m (6 ft)	Straight: A01406 (Option 98)  Angled: -----
	BS: United Kingdom	250 V at 6 A Black 2 m (6 ft)	Straight: A01407 (Option 99)  Angled: A01417
	CCC: China	250 V at 10 A Black 2 m (6 ft)	Straight: A114009 (Option 94)  Angled: A114109





# Certificate of Conformity



This is to certify, that

**Optical Polarization Scrambler**

---

**Q8163**

---

instrument, type, designation

complies with the provisions of the EMC Directive 89/336/EEC in accordance with EN61326 and Low Voltage Directive 73/23/EEC in accordance with EN61010.

**ADVANTEST Corp.**

Tokyo, Japan

**ROHDE&SCHWARZ**

Engineering and Sales GmbH  
Munich, Germany



## Table of Power Cable Options

There are six power cable options (refer to following table).

Order power cable options by Model number.

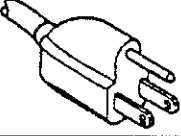
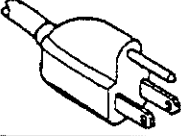
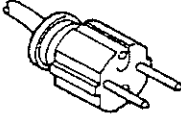
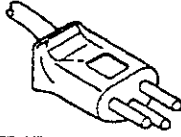
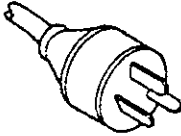
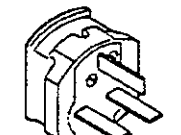
	Plug configuration	Standards	Rating, color and length	Model number (Option number)
1		JIS: Japan Law on Electrical Appliances	125 V at 7 A Black 2 m (6 ft)	Straight: A01402 Angled: A01412
2		UL: United States of America CSA: Canada	125 V at 7 A Black 2 m (6 ft)	Straight: A01403 (Option 95) Angled: A01413
3		CEE: Europe DEMKO: Denmark NEMKO: Norway VDE: Germany KEMA: The Netherlands CEBEC: Belgium OVE: Austria FIMKO: Finland SEMKO: Sweden	250 V at 6 A Gray 2 m (6 ft)	Straight: A01404 (Option 96) Angled: A01414
4		SEV: Switzerland	250 V at 6 A Gray 2 m (6 ft)	Straight: A01405 (Option 97) Angled: A01415
5		SAA: Australia, New Zealand	250 V at 6 A Gray 2 m (6 ft)	Straight: A01406 (Option 98) Angled: -----
6		BS: United Kingdom	250 V at 6 A Black 2 m (6 ft)	Straight: A01407 (Option 99) Angled: A01417



# TABLE OF CONTENTS

## CHAPTER 1 INTRODUCTION

1. Outline of Product .....	1-2
2. Before Using the Q8163 .....	1-3
3. Environment and Precautions .....	1-5
Operating environmental conditions .....	1-5
Precautions .....	1-6
4. Power Source and Fuse .....	1-7
Power Cable .....	1-7
Power source .....	1-8
Fuse .....	1-8
5. Damage to Circuit Element Due to Power Line CMV Loop .....	1-9
6. Cleaning the Input Optical Connector .....	1-10

## CHAPTER 2 Explanation of the panel surface

1. Front Panel .....	2-2
2. Rear Panel .....	2-3
3. Output and input of lightwave signal .....	2-4

## CHAPTER 3 PDL MEASUREMENT

1. PDL (Polarization Dependent Loss) measurement .....	3-2
2. PDL (Polarization Dependent Loss) measurement with Q8163 .....	3-3
3. Notes in measuring PDL with Q8163 .....	3-4
4. About the number of optical power sampling points required for PDL measurement .....	3-5

## CHAPTER 4 GPIB INTERFACE

1. GPIB .....	4-2
Outline of GPIB .....	4-2
2. GPIB Specification .....	4-4
3. Notes on Using GPIB .....	4-6
Connection to Peripheral Units .....	4-6
4. Remote Programming .....	4-7
Notes on Programming Commands .....	4-7
List of GPIB commands .....	4-7
Query Command .....	4-8
Service Request .....	4-8
Sample Programs (HP9000 series 300) .....	4-9
Sample Programs (PC9801 series) .....	4-9

## CHAPTER 5 SPECIFICATIONS

1. Q8163 Specifications ..... 5-2

## LIST OF ILLUSTRATIONS

<u>NO.</u>	<u>Title</u>	<u>Page</u>
1-1	Operating Environment .....	1-5
1-2	Power Cable .....	1-7
1-3	Power Line CMV Loop .....	1-9
2-1	Block Diagram of Optical Section .....	2-4
3-1	PDL Measurement .....	3-2
3-2	The system of PDL measurement with Q8163 .....	3-3
3-3	PDL Measurement Example of Optical Fiber Coupler .....	3-5
4-1	Outline of GPIB .....	4-3
4-2	Termination of Signal Conductors .....	4-4
4-3	GPIB Connector Pin Assignment .....	4-5





## LIST OF TABLES

<u>NO.</u>	<u>Title</u>	<u>Page</u>
1-1	Standard Accessories .....	1-3
1-2	Power Cable Options .....	1-4
1-3	Specifications of the Power Source Voltage and Fuse .....	1-8
3-1	Q8163 Optical Polarization Scramble Speed .....	3-4
4-1	Analyzer GPIB Interface Code .....	4-5
4-2	Standard Bus Cables(optional) .....	4-6



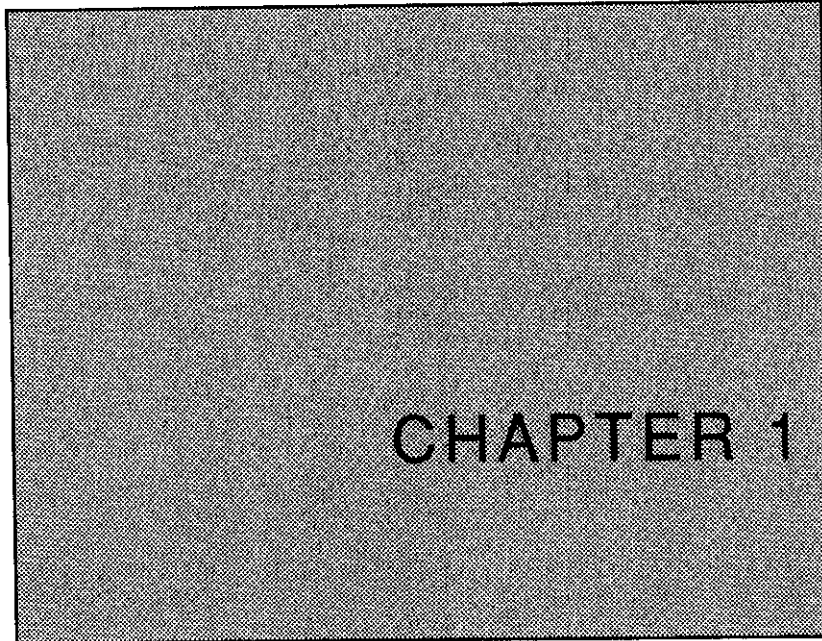

# INTRODUCTION

This chapter gives a brief explanation of product, its working environment and operational precautions. Read this chapter before you use the product.

---

## CONTENT

---

1. Outline of Product .....	1-2
2. Before Using the Q8163 .....	1-3
3. Environment and Precautions .....	1-5
Operating environmental conditions .....	1-5
Precautions .....	1-6
4. Power Source and Fuse .....	1-7
Power Cable .....	1-7
Power source .....	1-8
Fuse .....	1-8
5. Damage to Circuit Element Due to Power Line CMV Loop ..	1-9
6. Cleaning the Input Optical Connector .....	1-10

---

# 1. Outline of Product

Q8163 is a optical polarization scrambler which has a function to change the state of output light polarization with using a polarization element of optical fiber type. The strong points of Q8163 are as follows.

- **It is possible to change the polarized waves continuously.**

The state of output light polarization can be changed continuously by driving 3 polarization elements of optical fiber type. Therefore, all the states of polarized light (all the points on the Poincaré sphere.) can be output.

- **Fluctuation of insertion loss are  $\pm 0.005$  dB or less.**

As a polarization element of optical fiber type is used inside, the fluctuation of insertion loss are  $\pm 0.005$  dB or less when the state of polarized light changes. Therefore it provides the efficiency in evaluating various optics of small PDL (Polarization Dependent Loss).

- **Function to change high speed polarized wave**

By driving the polarization element of optical fiber type, the state of output light polarization can be changed at high speed.

It is possible to measure polarization dependability of various light components at high speed.

- **GPIB control**

As all functions can be controlled externally via GPIB, Q8163 is most suitable as a system component.

## 2. Before Using the Q8163

Upon taking delivery of Q8163, check whether any part of it has been broken during transportation. Especially, pay attention to the corners of Q8163 to check its exterior.

Then, check the quantity and specifications of the standard accessories according to Table 1-1.

If any part is broken or accessory is missing, contact the sales dealer or the support office.

The addresses and phone numbers of the support offices are given at the end of this manual.

Table1-1 Standard Accessories

Name	Type	Parts Code	Q`ty	Remarks
Power cable *1	A01402	—	1	
Power fuse	T2.5A 250V	DFT-AA2R5A	2	For 90 to 250VAC
Operation manual	EQ8163	FOE-Q8163-1	1	This manual

\*1: The cable supplied with Q8163 depends on what type (specified by model number above) was ordered when Q8163 was purchased.

There are 11 types of power cable available (see Table 1-2).

To order another power cable, contact an ADVANTEST Field Office or representative.

When ordering, refer to power cables by their option number or model number.

2. Before Using the Q8163

Table 1-2 Power Cable Options

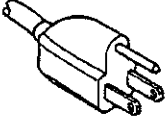
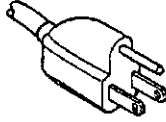
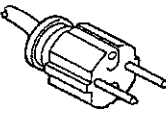
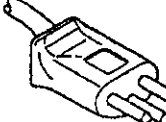
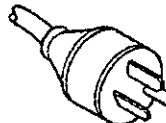
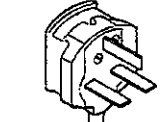
Plug	Standards	Rating, Color	Model Number
	JIS: Japan Law on Electrical Appliances	125V at 7A Black 2m (6ft)	Straight: A01402 Angled: A01412
	UL: United States of America CSA: Canada	125V at 7A Black 2m (6ft)	Straight: A01403 (Option 95) Angled: A01413
	*1	250V at 6A Gray 2m (6ft)	Straight: A01404 (Option 96) Angled: A01414
	SEV: Switzerland	250V at 6A Gray 2m (6ft)	Straight: A01405 (Option 97) Angled: A01415
	SAA: Australia, New Zealand	250V at 6A Gray 2m (6ft)	Straight: A01406 (Option 98) Angled: -----
	BS: United Kingdom	250V at 6A Black 2m (6ft)	Straight: A01407 (Option 99) Angled: A01417

\*1 : CEE: Europe, DEMKO: Denmark, NEMKO: Norway, VED: Germany,  
KEMA: The Netherlands, CBEC: Belgium, OVE: Austria, FIMKO: Finland,  
SEMKO: Sweden

### 3. Environment and Precautions

#### ■ Operating environmental conditions

● Q8163 must be set up in the place meeting the following conditions.

- Environmental temperature: +10°C to +40°C
- Relative humidity: 85% or less (Non-condensing)
- Place without corroded gas
- Place without exposed to direct sunshine
- Place without dust

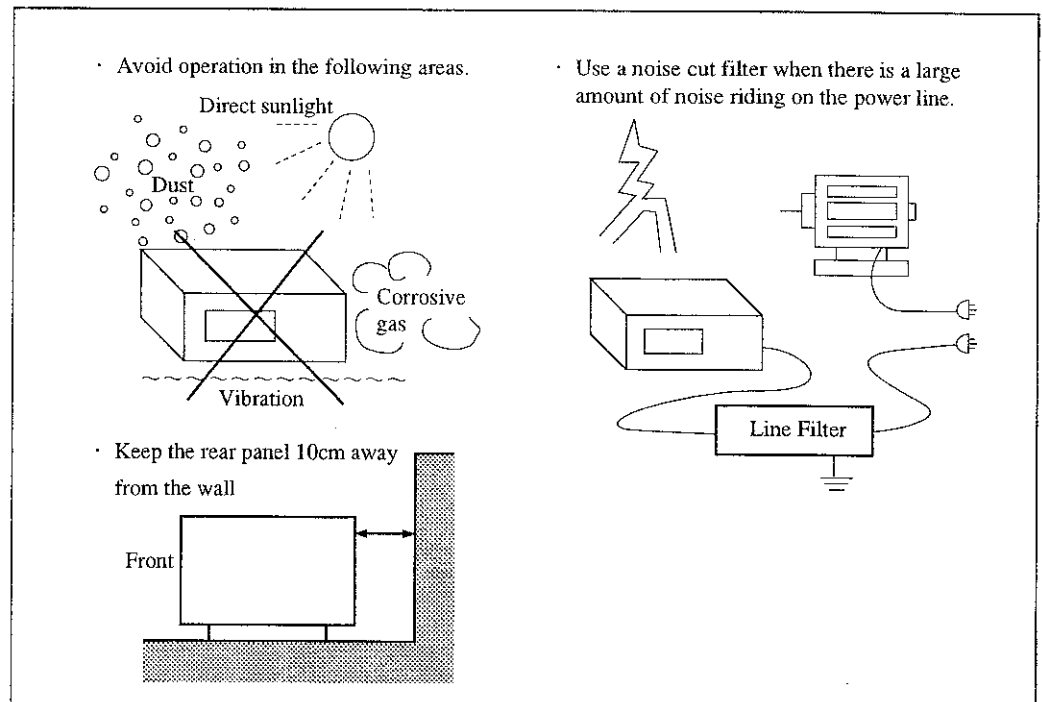

Figure 1-1 Operating Environment

● The cases in which Q8163 is not used for a long time, cover with the vinyl cover or put in the cardboard box and prevent dust. Keep it in a dry place where dust and direct sunshine were prevented.

- Storage temperature: -20°C to +60°C
- Relative humidity: 90% or less (Non-condensing)

● When transporting Q8163, use the box and shock-absorbing material used when shipped from the factory. If the box has been discarded, use another one 5 to 10 cm larger than Q8163 and pack it with a sufficient amount of shock-absorbing material.

● The Q8163 can be used safely under the following conditions :

- Altitude of up to 2000m
- Installation Categories II
- Pollution Degree 2

## ■ Precautions

- To eliminate the danger of electric shock, connect the power cord to a 3-pin socket. If no 3-pin socket is available, connect the GND terminal on the rear panel to the ground.
- Never connect the power cable to an AC line when the power switch is ON.
- Before using the power cable, confirm that the power source is within the voltage specified on the rear panel. Q8163 can be used without switching in the voltage range of 90 VAC to 250 VAC.
- High-voltage power source is used in Q8163. Never open the inside of Q8163 except specified service engineers.



## 4. Power Source and Fuse

### ■ Power Cable

#### **WARNING!**

- Use power cable of the attachment for the electric shock and the fire prevention.
- Use power cable in accordance with the safety standard of the country for use excluding Japan.
- When you connect power cable with the outlet, turn off the power switch.
- When you pull out power cable from the outlet, have the plug.

A detachable power cable with a three-contact plug is included with Q8163. The protective earth ground contact on the plug connects (through the power cable) to the accessible metal parts of the instrument. For protection against electrical shock, insert the plug into a power-source outlet that has a properly grounded, protective-ground contact.

The manufacturer ships a power cable, as ordered, with Q8163. A list of other available power cables is shown in Table 1-2. Contact your ADVANTEST representative or the local ADVANTEST Field Office for information on how to order these.

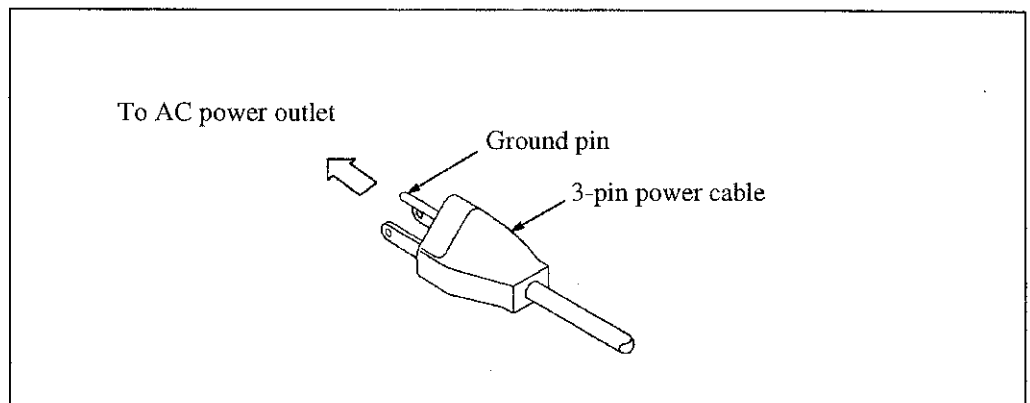

Figure 1-2 Power Cable

4. Power Source and Fuse

■ Power source

Before connecting the power cable, make sure that the scrambler power switch is OFF (set to the front position).

Q8163 operates within the range of 90 to 250VAC.

Q8163 can be used without switching in the voltage range of 90VAC to 250VAC.

■ Fuse

**WARNING !**

- Before replacing the power fuse, be sure to turn the power switch OFF and remove the power cable from the outlet.
- For continued protection against fire hazard, use a fuse of the type and rating which match the supply voltage.

Confirm that the power fuse is in the ACLINE connector on the rear panel.

● Fuse replacement



1 Remove the power cable from the AC line connector.

2 Remove the fuse holder from the AC line connector.

3 Confirm that the fuse has blown and replace it with a new one.  
(The fuse capacity is identical to the power voltage range which can be used.)

Table1-3 Specifications of the Power Source Voltage and Fuse

Input voltage	Automatically selects 100 or 220VAC 100VAC : Voltage 90V to 132V 220VAC : Voltage 198V to 250V
Frequency	48Hz to 66Hz
Fuse	2.5A250V
Power consumption	36VA or less

## 5. Damage to Circuit Element Due to Power Line CMV Loop

Q8163 can be used in combination with peripheral devices such as a desk-top computer and plotter.

When connecting a peripheral device, pay special attention to the CMV (common mode noise voltage) which may be caused by wiring failure of the power source grounding.

If a power line is used without grounding, an AC voltage (CMV) of about 50V is generated between terminals a1 and a2, and b1 and b2, by the loop illustrated in Figure 1-3.

In this case, if the a1 signal terminal is connected to a2, leaving ground terminals b1 and b2 open, the input/output circuit elements of circuits 1 and 2 may be damaged or deteriorated. To eliminate this, it is necessary to use a power line connected to ground wiring. CMV is instantaneous if the power is turned ON or OFF using the power source plug. The power source must be turned ON or OFF using the power source switch.

If the power source line is to be used without ground wiring, connect ground terminal GND1 to GND2 before connecting the signal cable. Then inset the power plug and turn the power switch ON.

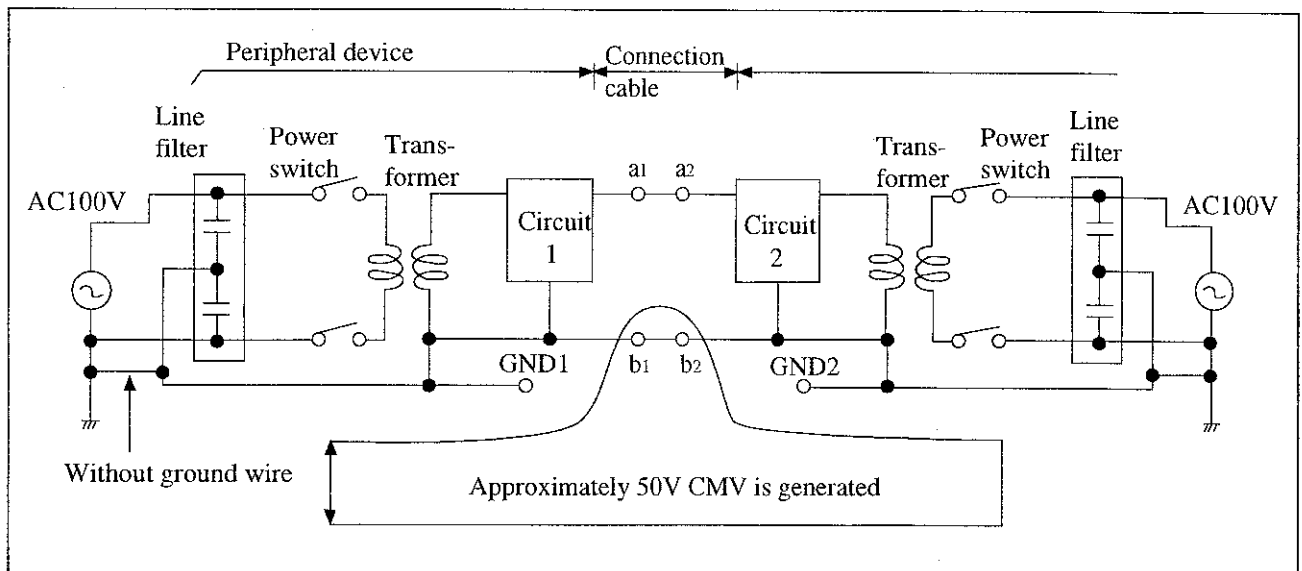

Figure 1-3 Power Line CMV Loop

## 6. Cleaning the Input Optical Connector

Dirt on the end of I/O optical connector in Q8163 sometimes makes insertion loss and level fluctuation larger. When connecting an optical connector to the analyzer, confirm that the end is sufficiently clean. Also, do not forget to clean the end of the internal optical connector in the optical input section of the analyzer.

### <Cleaning the end of the internal optical connector>



**●Removing the optical input section**

Remove screws 1 and 2 using a 2mm screwdriver.

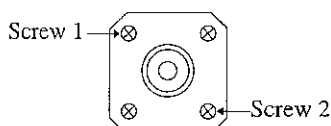

2

Pick the adapter and pull it out slowly. (Pull out about 3 to 5cm.)

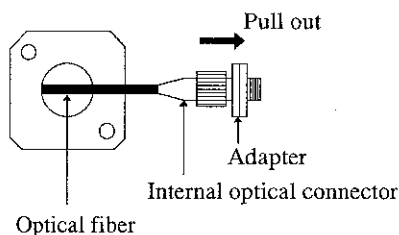

**NOTE:** Take care to not pull the fiber out forcibly to avoid breaking it.

**●Cleaning the end of the internal optical connector**

3

Remove the connector from the adapter and clean the end and sides of the connector ferrule using an absorbent gauze moistened with alcohol.

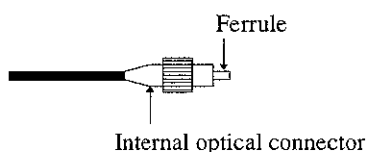

4

Lightly dab the end of the connector with the alcohol-moistened gauze and wipe off excess alcohol with a piece of dry gauze.

**NOTE:** Take care not to rub the fiber too vigorously to avoid scratching the surface.

**●After cleaning**

5

After drying the end of the fiber, mount the internal optical connector on the adapter and slowly set it in its original position. Fix the adapter with the two screws.

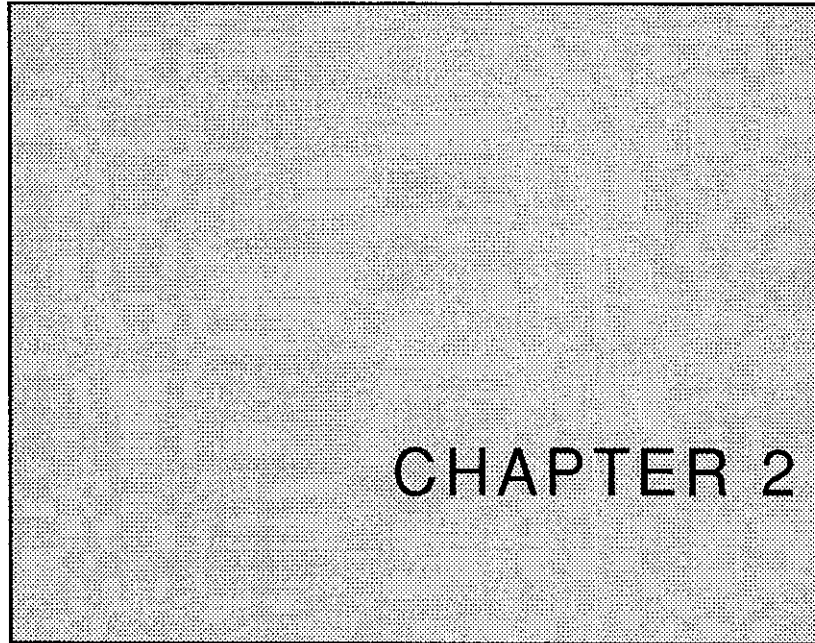

## Explanation of the panel surface

Names of each part on the panel surface of Q8163 and the functions are described in this chapter.

---

### CONTENTS

---

1. Front Panel .....	2-2
2. Rear Panel .....	2-3
3. Output and input of lightwave signal .....	2-4

---

# 1. Front Panel

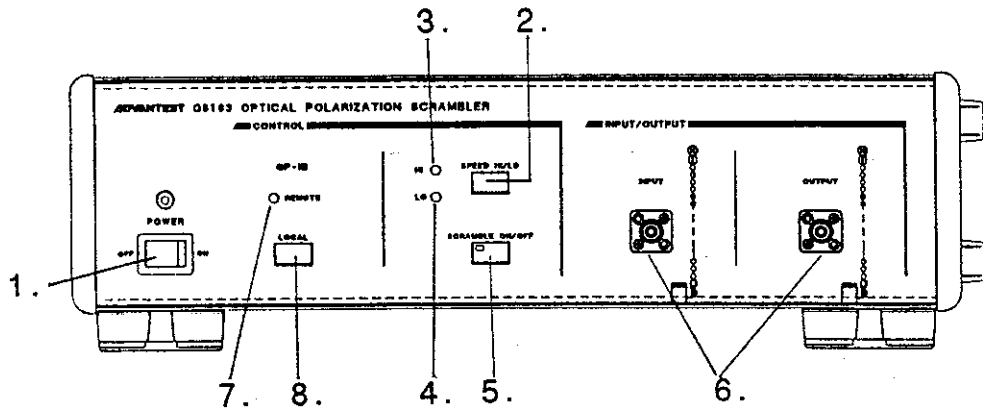

1. POWER ON/OFF switch

This is the Q8163's power ON/OFF switch. When the power is set to ON, the POWER lamp illuminates.

● Setup of optical polarization scrambler operation

2. SPEED HI/LO key

Switches the speed of Q8163 operation. Each time the key is pressed, HI speed and LOW speed are switched by turns.

3. HI lamp

It illuminates when Q8163 is set to HI speed.

4. LO lamp

It illuminates when Q8163 is set to LO speed.

5. SCRAMBLE ON/OFF key

It switches ON and OFF of polarized wave scramble operation of Q8163. During Q8163 is operating, the lamp illuminates.

6. Light input/output connector

It is Q8163's light input/light output connector. It is connected to Q8163's internal light circuit with FC connector (super PC polished). The connector which is connected to Q8163 must be super-PC-polished. When a connector is connected, use a connector which is cleaned thoroughly. When it is unused, attach the connector cap to it to keep out dust.

● GPIB setup

7. REMOTE lamp

This lamp illuminates when Q8163 is in the state of REMOTE by GPIB. During the REMOTE lamp illuminates, key input except LOCAL key is not accepted.

8. LOCAL key

REMOTE state of Q8163 is released and the REMOTE lamp goes out.

## 2. Rear Panel

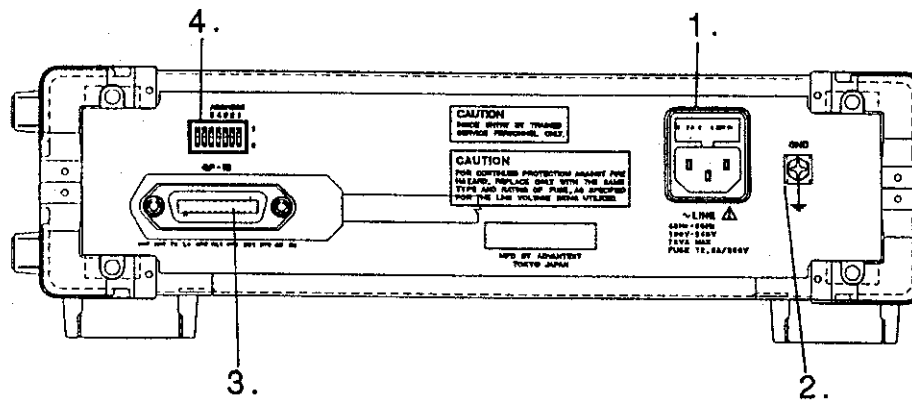

1. AC LINE outlet  
Connect the attached power source cable.
2. GND terminal  
When power source outlet to use does not have a ground terminal, use this terminal to earth-ground Q8163.
3. GPIB connector  
It is used to control Q8163 with the external controller which has GPIB interface.
4. ADDRESS switch  
Sets up GPIB address. It is set up in the GPIB address which has been set up at the Q8163 power on. When the GPIB address is changed in use, turn on the power again.

### 3. Output and input of lightwave signal

Block diagram of the optical section is shown in Figure 2-1.

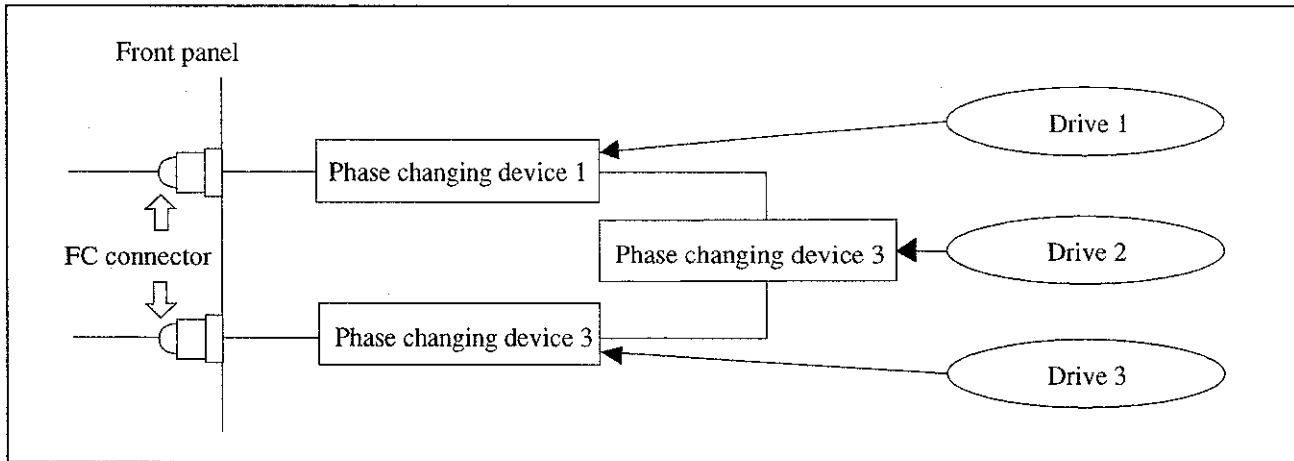

Figure 2-1 Block Diagram of Optical Section

A single-mode optical fiber of core diameter  $10 \mu\text{m}$  is used in Q8163 optical section. The input and output connector is FC connector, and the end of ferrule is SPC-polished.

#### Caution!

- Use a proper connector to connect to Q8163.
- Use a connecting optical fiber with cleaned end. If an optical fiber with dirty end is used, sometimes loss or level fluctuation becomes larger. Ditto for the optical fiber used in Q8163.
- Clean them periodically. High-voltage power is used in Q8163. Never open inside of the Q8163 except specified service engineers.



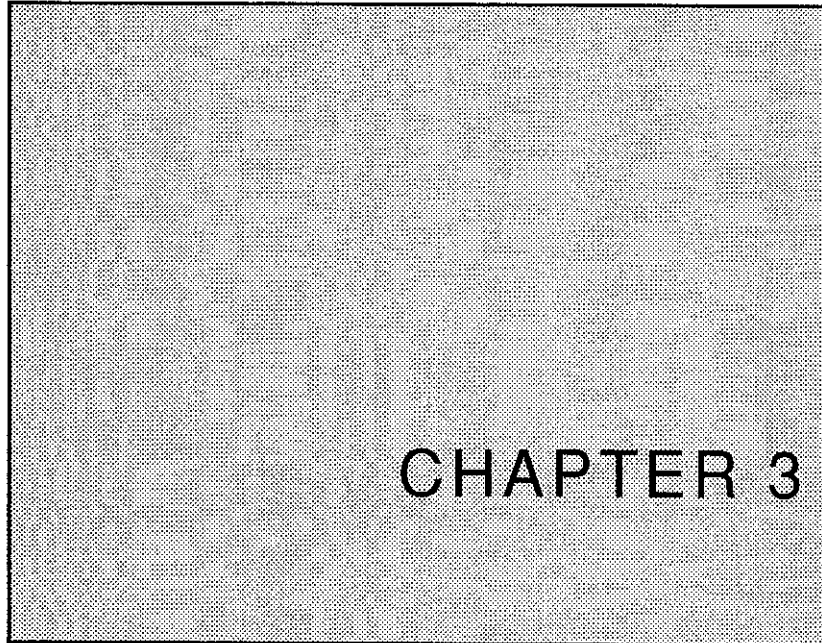

## PDL MEASUREMENT

This chapter is explained about PDL (Polarization Dependent Loss) Measurement.

---

### CONTENTS

---

1. PDL (Polarization Dependent Loss) measurement .....	3-2
2. PDL (Polarization Dependent Loss) measurement with Q8163	3-3
3. Notes in measuring PDL with Q8163 .....	3-4
4. About the number of optical power sampling points required for PDL measurement .....	3-5

---

# 1. PDL (Polarization Dependent Loss) measurement

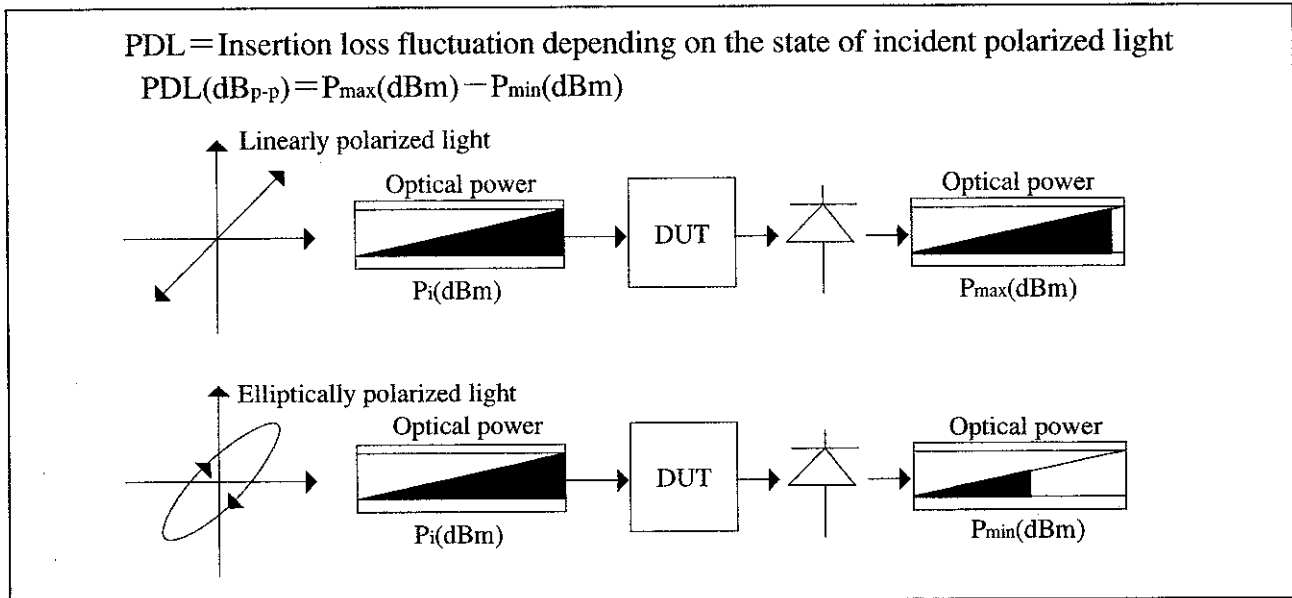

Figure 3-1 PDL Measurement

Generally, the light passed through optics is seen as outputting light attenuated by some insertion loss.

The changed portion of insertion loss which was changed depending on the state of input polarized light is called PDL. As shown in Figure 3-1, for example, let the maximum value of the outputting optical power when a linearly polarized light was input into DUT, be  $P_{\text{max}}(\text{dBm})$ , and the minimum value of outputting optical power when an elliptically polarized light was input into DUT, be  $P_{\text{min}}(\text{dBm})$ , then PDL of the DUT is as follows;

$$\text{PDL}(\text{dB}_{\text{p-p}}) = P_{\text{max}}(\text{dBm}) - P_{\text{min}}(\text{dBm})$$

## 2. PDL (Polarization Dependent Loss) measurement with Q8163

The following shows the system of PDL measurement with Q8163.

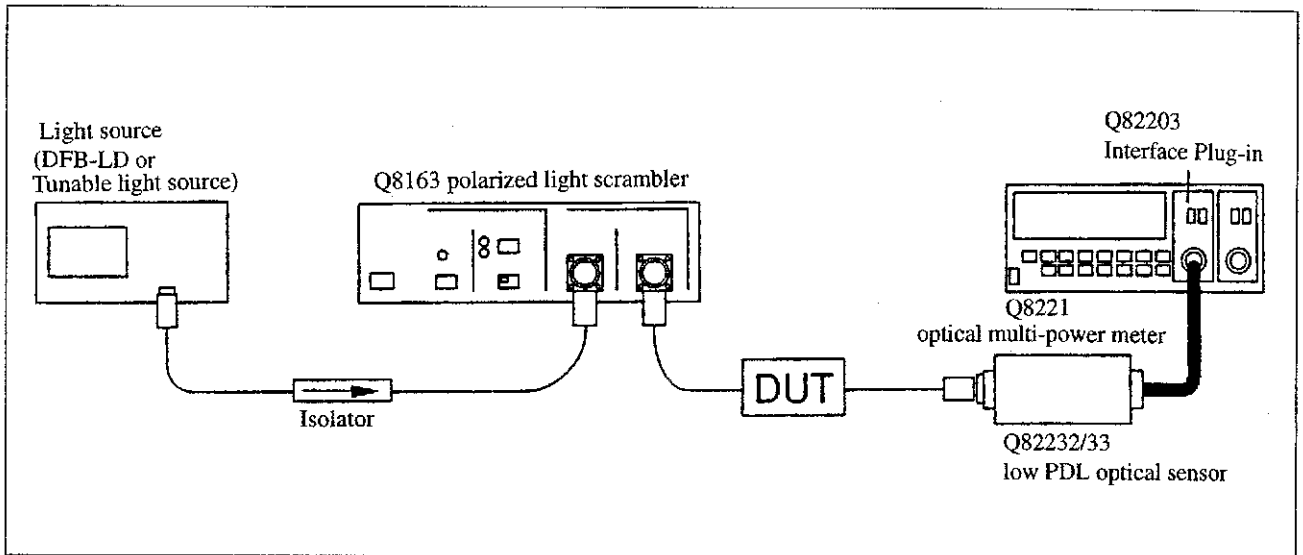

Figure 3-2 The system of PDL measurement with Q8163

Connect incident light from the light source to Q8163.

The state of this input polarized light changes depending on phase changing device (polarization variable device), and the incident light outputs from Q8163.

As the outputting light of Q8163 realizes all the states of polarization, PDL can be acquired by inputting this output light, of which the state of polarization changes every moment, into the DUT to measure the optical power output from the DUT, and obtaining the rate between maximum value and minimum value of the optical power.

### 3. Notes in measuring PDL with Q8163

In measuring PDL with Q8163, it is necessary to use an optical power meter with enough high speed compared with polarized wave scramble speed of Q8163. The following shows the polarized wave scramble speed of Q8163.

Table 3-1 Q8163 Optical Polarization Scramble Speed

Q8163 setup speed	Polarized light variable speed (Changed angle by Poincaré sphere)
HI-speed	180° /ms or more
LO-speed	3.6° /ms or more

When sampling of 1 point optical power is not sufficiently speedy compared with the polarization variable speed of Q8163, the state of polarization changes during measurement of the optical power. Therefore, PDL measurement value is measured smaller than the actual value. When polarization variable speed of Q8163 is set to LO-speed, the optical power sampling time must be about 2 ms or less.

#### 4. About the number of optical power sampling points required for PDL measurement

The number of optical power points (measuring time) used for PDL calculation is different depending on the amount of DUT's PDL, the kind of DUT, and required measurement accuracy. In PDL measurement, decide the number of optical power sampling points in the following way.

- Measure some PDLs while changing the measurement points and acquire the number of measurement points to measure with good repeatability and with the measurement accuracy needed for the measurement value.

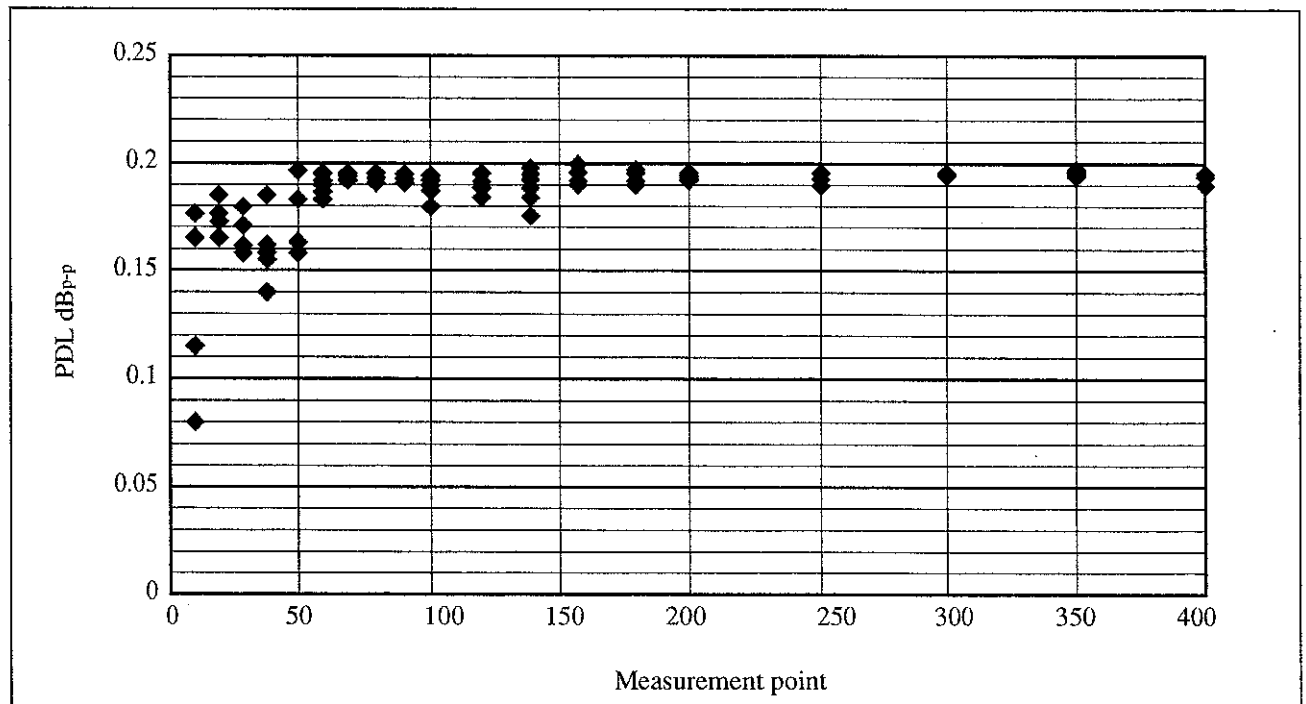
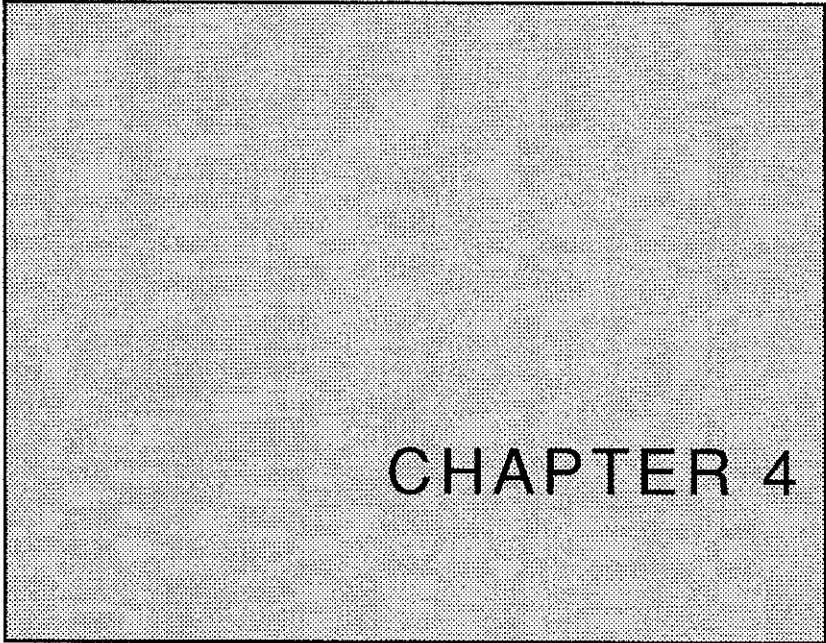

Figure 3-3 PDL Measurement Example of Optical Fiber Coupler

Figure 3-3 shows an example to decide measurement point number needed for PDL measurement. It shows the PDL value converges with increasing measurement point number. It is apparent that when optical fiber coupler of PDL value about 0.2 dB p-p is measured in this measurement system, measurement point number needed for the measurement is about 150 points.





# CHAPTER 4

## GPIB INTERFACE

This chapter explains external control via GPIB interface and GPIB command codes.

---

### CONTENTS

---

1. GPIB .....	4-2
Outline of GPIB .....	4-2
2. GPIB Specification .....	4-4
3. Notes on Using GPIB .....	4-6
Connection to Peripheral Units .....	4-6
4. Remote Programming .....	4-7
Notes on Programming Commands .....	4-7
List of GPIB commands .....	4-7
Query Command .....	4-8
Service Request .....	4-8
Sample Programs (HP9000 series 300) .....	4-9
Sample Programs (PC9801 series) .....	4-9

---

# 1. GPIB

Q8163 is equipped with the GPIB. By using the GPIB, enables to perform each setup for reading the measurement data, the measurement mode, the measurement range, etc.

## ■ Outline of GPIB

The GPIB is the interface system which connects the tester to the controller and the peripheral devices using a simple cable (bus line).

The GPIB is an easy-to-use interface system with higher expendability compared to other systems. In addition, it provides electrical, mechanical and functional compatibility with other manufacturers' products. Therefore, the GPIB can make up not only a simple system but an automatic instrumentation system using the single bus cabal.

In the GPIB system, it is necessary to set the address of each component connected to the bus line. Each component may play one or more roles of the controller, talker and listener.

During operation of the system, only one talker can transmit data on the bus line while the listeners receive the data.

The controller specifies the addresses of the talker and the listeners. It transfers data from the talker to the listeners and sets the measuring conditions from itself (or the talker) to the listeners.

For data transfer among components of the system, eight data lines of the bit parallel and byte serial are used for asynchronous two-way transmission. The asynchronous system allows high-speed and low-speed compound devices to be connected arbitrarily. A collection of data (messages) sent and received among devices includes measurement data, measuring conditions (programs) and commands. The ASCII code is mainly used.

Beside the above mentioned eight data lines, the system includes three handshaking lines to control asynchronous data transfer among devices and five control lines to control the information flow on the bus.

● The following signals are used for the handshaking lines.

- DAV (Data Valid) : Signal to indicate the data valid state
- NRFD (Not Ready For Data) : Signal to indicate the data reception enabled state
- NDAC (Not Data Accepted) : Signal to indicate the reception completion state



● The following signals are used for the control lines.

- ANT (Attention) : This signal identifies whether the signal on the data line is an address, command or other information.
- IFC (Interface Clear) : Signal to clear the interface
- EOI (End or Identify) : Signal to be used on the termination of information transfer
- SRQ (Service Request) : Signal to cause an arbitrary device to present a request for services from the controller
- REN (Remote Enable) : Signal to be used for remote control of a remote-programmable device

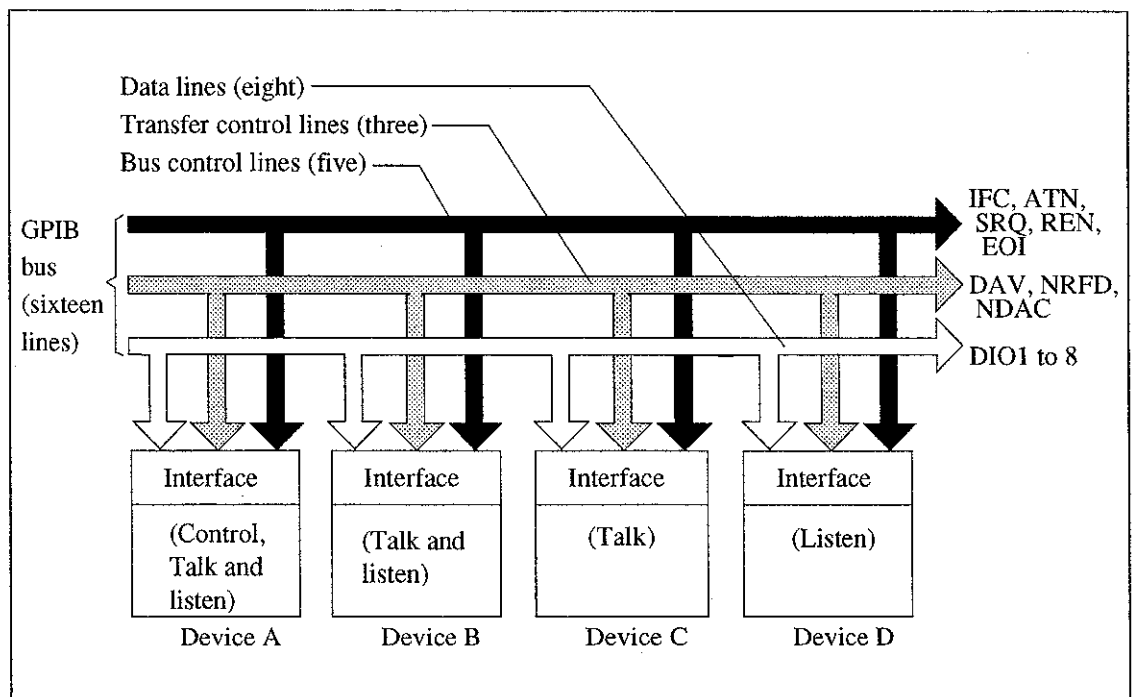

Figure 4-1 Outline of GPIB

## 2. GPIB Specification

- Governing specification : IEEE standard 488-1978
- Available code : ASCII code and binary code
- Logic level : Logic 0 "High" state +2.4 VDC or more  
Logic 1 "Low" state +0.4 VDC or less
- Termination of signal line : 16 bus lines are terminated as follows:

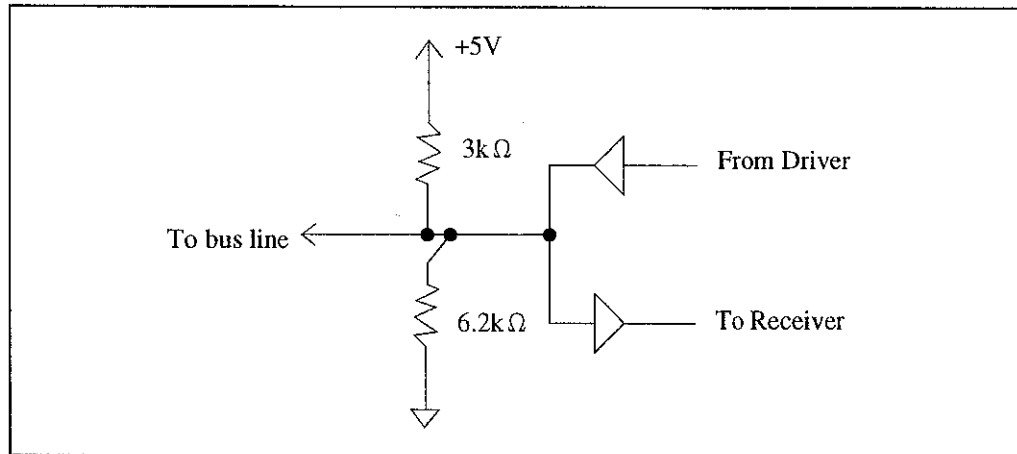

Figure 4-2 Termination of Signal Conductors

- Driver specification : Try-state method  
"Low" state output voltage ; +0.4 VDC or less, 4.8 mA  
"High" state output voltage ; +2.4 VDC or more, -5.2 mA
- Receiver specification : "Low" state at +0.6 VDC or less  
"High" state at +2.0 VDC or more
- Bus cable length : The length of each bus cable must not exceed : (the number of devices connected to the bus) × 2 m or 20 m in total.
- Addressing : The address selection switch on the front panel allows 31 types of talk/listen address to be selected.

- Connector : 24-pin GPIB connector, 57FE-20240-20SD35  
(Equivalent to the product manufactured by Daiich Denshi Kogyo)

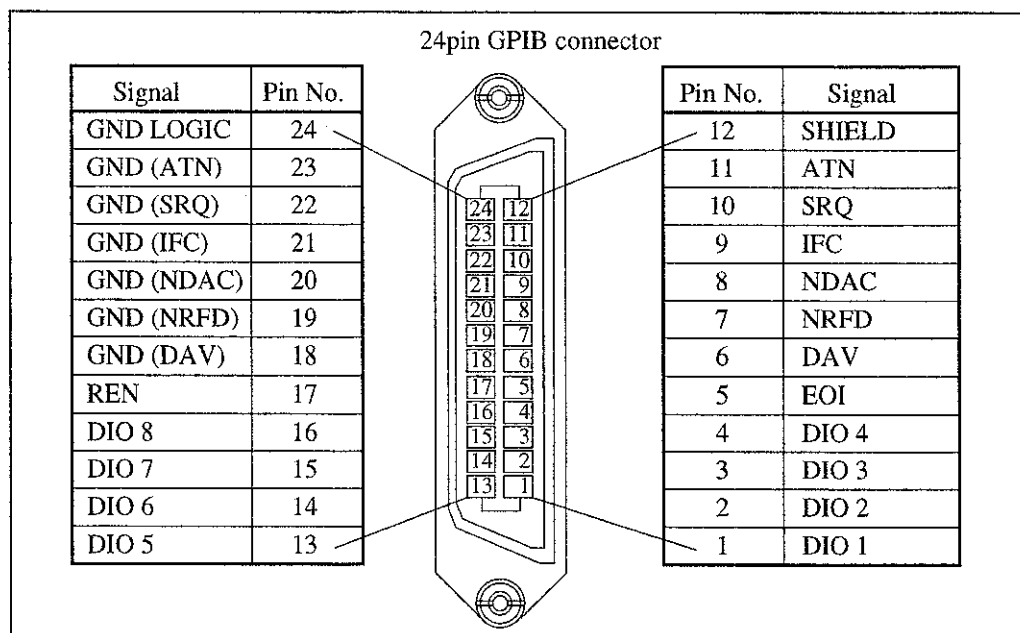

Figure 4-3 GPIB Connector Pin Assignment

- Interface functions: Refer to Table 4-1.

Table 4-1 Analyzer GPIB Interface Code

Code	Interface Functions
SH1	Source handshake function
AH1	Acceptor handshake function
T6	Basic talker function, Serialpolling function, No talk only mode function, Listener-specified talker cancel function
L4	Basic listener function, Talker-specified listener cancel function
SR1	Service request function
RL1	Remote/Local switching function
PP0	No parallel function
DC1	Device clear function (SDC and DCL commands are available.)
DT0	No device trigger function
C0	No controller function
E2	Use of three-state bus driver

## 3. Notes on Using GPIB

### ■ Connection to Peripheral Units

Because a GPIB system is built of multiple components, take notice of the following instructions in building one:

#### Caution!

- Prior to cabling, verify the correct status and operation of the Q8163, controller, peripheral equipment and so on as directed in their operation manuals.
- Do not extend the interconnecting cable and bus cable extensions longer than necessary. Make sure that they do not exceed standard length. Total length of whole bus cables is less than 2m (number of peripheral unit to be connected with bus)

Table 4-2 lists the standard bus cables available from ADVANTEST.

Table 4-2 Standard Bus Cables(optional)

Length	Name
0.5m	408JE-1P5
1m	408JE-101
2m	408JE-102
4m	408JE-104

- Bus cables have a piggyback connector; that is, a single connector assembly has both a male and a female connector, which can be used piled up. In connecting bus cables, do not pile up three or more connectors together. Be sure to clamp them firmly with connector mounting screws.
- Turn on the power to the components, but not before checking their input power requirements, grounding status and, when appropriate, their setup conditions. Be sure that you switch on all the components on the GPIB bus. Satisfactory system performance would be unpredictable if any component is left switched off.
- In connecting/removing bus cables, make sure to remove the power cable from the outlet.

## 4. Remote Programming

### ■ Notes on Programming Commands

When using the remote programming, keep the following in mind:

#### Caution!

- The command array that can be set in one line is up to 40 characters
- If the command is written continuously, the Q8163 may not operate correctly. To prevent malfunction, it is recommended to place (write) the delimiting characters (space or comma) among each command.

Example: When "Z" and "R\*" is used (written)  
PRINT @8;"ZR4"

In this case, the command is determined as "ZR", the Q8163 cannot operate normally with malfunction.

- The commands "C" and "Z" are used to initialize the currently set condition, so the Q8163 is required to re-set up the condition from the beginning. Therefore, the following commands may not be used, be sure to send these commands with a single-line signal.

### ■ List of GPIB commands

The following shows a list of GPIB commands.

Setting item	Code	Description	Initial value
Q8163 Reset	C	Initializes Q8163.	
Designation of block delimiter	DL0	Outputs EOI with CRLF and IF at the same time as a block delimiter.	*
	DL1	Outputs LF only as a block delimiter.	
	DL2	Outputs EOI with final bite.	
Specification of SRQ mode	S0	Outputs SRQ.	
	S1	Not output SRQ.	*
Setting of status byte masking	MS0-255	Masks the specified status byte. The bit where 1 is stood by a conversion into hexadecimal is masked. However, bit 6 cannot be masked.	
Clearing of status byte	CS	Clears the status byte to 0.	
Buzzer	BZ0	Not buzzer.	
	BZ1	Buzzers.	*
SPEED HI/LO	SP0	Sets to SPEED LO.	
	SP1	Sets to SPEED HI.	*
SCRAMBLE ON/OFF	SC0	Sets to SCRAMBLE OFF.	*
	SC1	Sets to SCRAMBLE ON.	

4. Remote Programming

■ Query Command

Using a query command (\* \* ?) enables Q8163 to read various set data through the GPIB.

Query command	Data	Description
SP?	0	SPEED LO
	1	SPEED HI
SC?	0	SCRAMBLE OFF
	1	SCRAMBLE ON
BZ?	0	Not buzzer.
	1	Buzzers.

■ Service Request

In the S0 mode specified, Q8163 outputs a service request signal (SRQ) to the controller when receiving an undefined code or detecting an abnormal inside temperature.

When Q8163 outputs a service request signal, the controller outputs a status byte by serial polling.

(1) Service Request by Detecting Abnormal Inside Temperature

When an abnormal inside temperature is detected, Q8163 stops the scramble operation and outputs a service request. The status byte is set once when the inside temperature turns to abnormal from normal. The status byte is cleared when the inside of Q8163 is returned to normal temperature, or when Q8163 receives a clear status command.

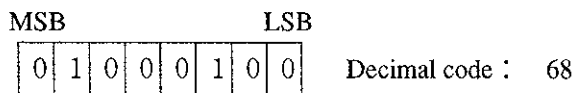

(2) Service Request by SYNTAX Error

In remote programming, when an undefined program code is received, Q8163 outputs a service request.

The service request is cleared when Q8163 receives a proper program code or a clear status command.

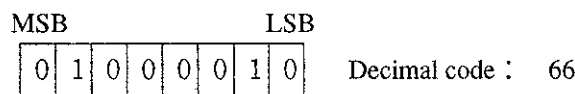

**■ Sample Programs (HP9000 series 300)**

```
100 *****
110 * Q8163 Optical Polarization Scrambler *
120 *****
200 Opm = 701           ! Sets GPIB address of Q8163.
300 OUTPUT Opm;"C"     ! Initializes Q8163.
310 OUTPUT Opm;"SP0"   ! Sets scramble speed of Q8163 to LO.
320 OUTPUT Opm;"SC1"   ! Starts scramble operation of Q8163.
330 END                ! Ends the program.
```

**■ Sample Programs (PC9801 series)**

```
100 *****
110 * Q8163 Optical Polarization Scrambler *
120 *****
200 ISET IFC           'send IFC signal
210 ISET REN           'send REN signal
220 OPM = 1           'Sets GPIB address of Q8163.
230 PRINT @OPM;"C"    'Initializes Q8163.
240 PRINT @OPM;"SP0"  'Sets scramble speed of Q8163 to LO.
250 PRINT @OPM;"SC1"  'Starts scramble operation of Q8163.
300 END               'Ends the program.
```





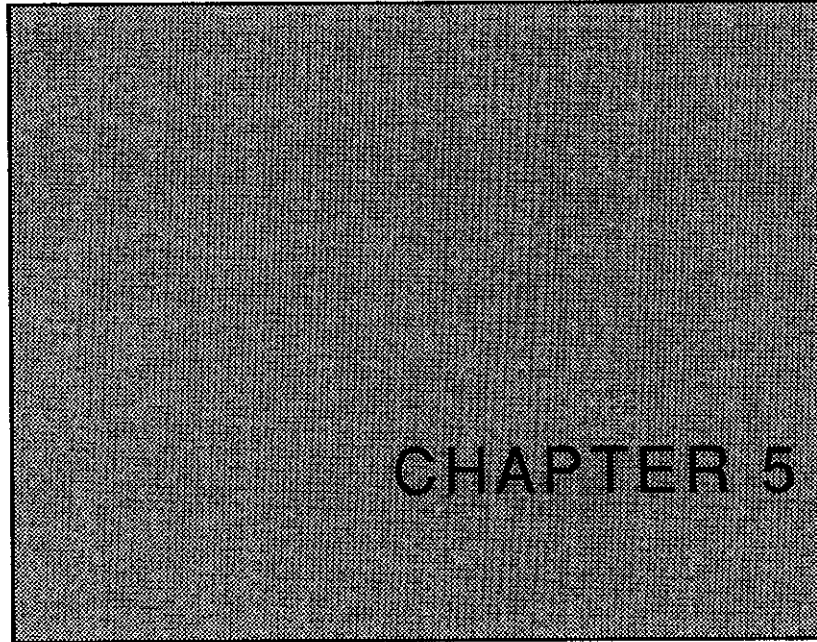

# SPECIFICATIONS

This chapter shows specifications for each component of the Q8163.

---

## CONTENTS

---

1. Q8163 Specifications .....	5-2
-------------------------------	-----

---

# 1. Q8163 Specifications

The following shows the specification of the Q8163 functions.

Wavelength	Range of used wavelength	1.29 $\mu$ m to 1.58 $\mu$ m
Level	Insertion loss Fluctuation of insertion loss Return loss	$\leq 3$ dB $\leq \pm 0.005$ dB $\geq 43$ dB
Polarized wave control	Variable speed Variable speed switch	$\geq$ Poincaré sphere of 500 revolutions/second (HI-speed) $\geq$ Poincaré sphere of 10 revolutions/second (LO-speed) Variable speed switch 2 levels, Hi and Lo
Output/Input	Output/Input connector External control	FC/SPC (Standard specification) GPIB standard equipment
Option 13	Optical fiber output with connector	Outputs using optical fiber with FC/SPC connector (fiber length: 2m)
General specification	Use environment Save environment Source power Dimensions Mass	Temperature: +10°C to +40°C, Relative humidity: 85% or less (non-condensing) Temperature: -20°C to +60°C, Relative humidity: 90% or less (non-condensing) Automatically selects 100 or 220VAC 100VAC : Voltage 100V to 120V 220VAC : Voltage 220V to 240V Frequency : 50/60Hz Power consumption : 36VA or less Approx. 88 (Height) $\times$ 330 (Width) $\times$ 450 (Depth) mm 10kg or less

## **IMPORTANT INFORMATION FOR ADVANTEST SOFTWARE**

PLEASE READ CAREFULLY: This is an important notice for the software defined herein. Computer programs including any additions, modifications and updates thereof, operation manuals, and related materials provided by Advantest (hereafter referred to as "SOFTWARE"), included in or used with hardware produced by Advantest (hereafter referred to as "PRODUCTS").

### **SOFTWARE License**

All rights in and to the SOFTWARE (including, but not limited to, copyright) shall be and remain vested in Advantest. Advantest hereby grants you a license to use the SOFTWARE only on or with Advantest PRODUCTS.

### **Restrictions**

- (1) You may not use the SOFTWARE for any purpose other than for the use of the PRODUCTS.
- (2) You may not copy, modify, or change, all or any part of, the SOFTWARE without permission from Advantest.
- (3) You may not reverse engineer, de-compile, or disassemble, all or any part of, the SOFTWARE.

### **Liability**

Advantest shall have no liability (1) for any PRODUCT failures, which may arise out of any misuse (misuse is deemed to be use of the SOFTWARE for purposes other than its intended use) of the SOFTWARE. (2) For any dispute between you and any third party for any reason whatsoever including, but not limited to, infringement of intellectual property rights.

## LIMITED WARRANTY

1. Unless otherwise specifically agreed by Seller and Purchaser in writing, Advantest will warrant to the Purchaser that during the Warranty Period this Product (other than consumables included in the Product) will be free from defects in material and workmanship and shall conform to the specifications set forth in this Operation Manual.
2. The warranty period for the Product (the "Warranty Period") will be a period of one year commencing on the delivery date of the Product.
3. If the Product is found to be defective during the Warranty Period, Advantest will, at its option and in its sole and absolute discretion, either (a) repair the defective Product or part or component thereof or (b) replace the defective Product or part or component thereof, in either case at Advantest's sole cost and expense.
4. This limited warranty will not apply to defects or damage to the Product or any part or component thereof resulting from any of the following:
  - (a) any modifications, maintenance or repairs other than modifications, maintenance or repairs (i) performed by Advantest or (ii) specifically recommended or authorized by Advantest and performed in accordance with Advantest's instructions;
  - (b) any improper or inadequate handling, carriage or storage of the Product by the Purchaser or any third party (other than Advantest or its agents);
  - (c) use of the Product under operating conditions or environments different than those specified in the Operation Manual or recommended by Advantest, including, without limitation, (i) instances where the Product has been subjected to physical stress or electrical voltage exceeding the permissible range and (ii) instances where the corrosion of electrical circuits or other deterioration was accelerated by exposure to corrosive gases or dusty environments;
  - (d) use of the Product in connection with software, interfaces, products or parts other than software, interfaces, products or parts supplied or recommended by Advantest;
  - (e) incorporation in the Product of any parts or components (i) provided by Purchaser or (ii) provided by a third party at the request or direction of Purchaser or due to specifications or designs supplied by Purchaser (including, without limitation, any degradation in performance of such parts or components);
  - (f) Advantest's incorporation or use of any specifications or designs supplied by Purchaser;
  - (g) the occurrence of an event of force majeure, including, without limitation, fire, explosion, geological change, storm, flood, earthquake, tidal wave, lightning or act of war; or
  - (h) any negligent act or omission of the Purchaser or any third party other than Advantest.
5. **EXCEPT TO THE EXTENT EXPRESSLY PROVIDED HEREIN, ADVANTEST HEREBY EXPRESSLY DISCLAIMS, AND THE PURCHASER HEREBY WAIVES, ALL WARRANTIES, WHETHER EXPRESS OR IMPLIED, STATUTORY OR OTHERWISE, INCLUDING, WITHOUT LIMITATION, (A) ANY WARRANTY OF MERCHANTABILITY OR FITNESS FOR A PARTICULAR PURPOSE AND (B) ANY WARRANTY OR REPRESENTATION AS TO THE VALIDITY, SCOPE, EFFECTIVENESS OR USEFULNESS OF ANY TECHNOLOGY OR ANY INVENTION.**
6. **THE REMEDY SET FORTH HEREIN SHALL BE THE SOLE AND EXCLUSIVE REMEDY OF THE PURCHASER FOR BREACH OF WARRANTY WITH RESPECT TO THE PRODUCT.**
7. **ADVANTEST WILL NOT HAVE ANY LIABILITY TO THE PURCHASER FOR ANY INDIRECT, INCIDENTAL, SPECIAL, CONSEQUENTIAL OR PUNITIVE DAMAGES, INCLUDING, WITHOUT LIMITATION, LOSS OF ANTICIPATED PROFITS OR REVENUES, IN ANY AND ALL CIRCUMSTANCES, EVEN IF ADVANTEST HAS BEEN ADVISED OF THE POSSIBILITY OF SUCH DAMAGES AND WHETHER ARISING OUT OF BREACH OF CONTRACT, WARRANTY, TORT (INCLUDING, WITHOUT LIMITATION, NEGLIGENCE), STRICT LIABILITY, INDEMNITY, CONTRIBUTION OR OTHERWISE. TORT (INCLUDING, WITHOUT LIMITATION, NEGLIGENCE), STRICT LIABILITY, INDEMNITY, CONTRIBUTION OR OTHERWISE.**
8. **OTHER THAN THE REMEDY FOR THE BREACH OF WARRANTY SET FORTH HEREIN, ADVANTEST SHALL NOT BE LIABLE FOR, AND HEREBY DISCLAIMS TO THE FULLEST EXTENT PERMITTED BY LAW ANY LIABILITY FOR, DAMAGES FOR PRODUCT FAILURE OR DEFECT, WHETHER ARISING OUT OF BREACH OF CONTRACT, TORT (INCLUDING, WITHOUT LIMITATION, NEGLIGENCE), STRICT LIABILITY, INDEMNITY, CONTRIBUTION OR OTHERWISE.**

## **CUSTOMER SERVICE DESCRIPTION**

In order to maintain safe and trouble-free operation of the Product and to prevent the incurrence of unnecessary costs and expenses, Advantest recommends a regular preventive maintenance program under its maintenance agreement.

Advantest's maintenance agreement provides the Purchaser on-site and off-site maintenance, parts, maintenance machinery, regular inspections, and telephone support and will last a maximum of ten years from the date the delivery of the Product. For specific details of the services provided under the maintenance agreement, please contact the nearest Advantest office listed at the end of this Operation Manual or Advantest's sales representatives.

Some of the components and parts of this Product have a limited operating life (such as, electrical and mechanical parts, fan motors, unit power supply, etc.). Accordingly, these components and parts will have to be replaced on a periodic basis. If the operating life of a component or part has expired and such component or part has not been replaced, there is a possibility that the Product will not perform properly. Additionally, if the operating life of a component or part has expired and continued use of such component or part damages the Product, the Product may not be repairable. Please contact the nearest Advantest office listed at the end of this Operation Manual or Advantest's sales representatives to determine the operating life of a specific component or part, as the operating life may vary depending on various factors such as operating condition and usage environment.

## SALES & SUPPORT OFFICES

Advantest Korea Co., Ltd.

22BF, Kyobo KangNam Tower,  
1303-22, Seocho-Dong, Seocho-Ku, Seoul #137-070, Korea  
Phone: +82-2-532-7071  
Fax: +82-2-532-7132

Advantest (Suzhou) Co., Ltd.

Shanghai Branch Office:  
Bldg. 6D, NO.1188 Gumei Road, Shanghai, China 201102 P.R.C.  
Phone: +86-21-6485-2725  
Fax: +86-21-6485-2726

Shanghai Branch Office:  
406/F, Ying Building, Quantum Plaza, No. 23 Zhi Chun Road,  
Hai Dian District, Beijing,  
China 100083  
Phone: +86-10-8235-3377  
Fax: +86-10-8235-6717

Advantest (Singapore) Pte. Ltd.

438A Alexandra Road, #08-03/06  
Alexandra Technopark Singapore 119967  
Phone: +65-6274-3100  
Fax: +65-6274-4055

Advantest America, Inc.

3201 Scott Boulevard, Suite, Santa Clara, CA 95054, U.S.A  
Phone: +1-408-988-7700  
Fax: +1-408-987-0691

ROHDE & SCHWARZ Europe GmbH

Mühldorfstraße 15 D-81671 München, Germany  
(P.O.B. 80 14 60 D-81614 München, Germany)  
Phone: +49-89-4129-13711  
Fax: +49-89-4129-13723

**ADVANTEST**<sup>®</sup>

<http://www.advantest.co.jp>