

---

---

**ADVANTEST®**

**ADVANTEST CORPORATION**

---

***R3267 Series OPT61***

***IS-95 Measurement Option***

***Operation Manual***

**MANUAL NUMBER FOE-8335218D00**

---

***Applicable Models***

***R3264***

***R3267***

***R3273***



---

## Safety Summary

To ensure thorough understanding of all functions and to ensure efficient use of this instrument, please read the manual carefully before using. Note that Advantest bears absolutely no responsibility for the result of operations caused due to incorrect or inappropriate use of this instrument.

If the equipment is used in a manner not specified by Advantest, the protection provided by the equipment may be impaired.

- **Warning Labels**

Warning labels are applied to Advantest products in locations where specific dangers exist. Pay careful attention to these labels during handling. Do not remove or tear these labels. If you have any questions regarding warning labels, please ask your nearest Advantest dealer. Our address and phone number are listed at the end of this manual.

Symbols of those warning labels are shown below together with their meaning.

**DANGER:** Indicates an imminently hazardous situation which will result in death or serious personal injury.

**WARNING:** Indicates a potentially hazardous situation which will result in death or serious personal injury.

**CAUTION:** Indicates a potentially hazardous situation which will result in personal injury or a damage to property including the product.

- **Basic Precautions**

Please observe the following precautions to prevent fire, burn, electric shock, and personal injury.

- Use a power cable rated for the voltage in question. Be sure however to use a power cable conforming to safety standards of your nation when using a product overseas.
- When inserting the plug into the electrical outlet, first turn the power switch OFF and then insert the plug as far as it will go.
- When removing the plug from the electrical outlet, first turn the power switch OFF and then pull it out by gripping the plug. Do not pull on the power cable itself. Make sure your hands are dry at this time.
- Before turning on the power, be sure to check that the supply voltage matches the voltage requirements of the instrument.
- Connect the power cable to a power outlet that is connected to a protected ground terminal. Grounding will be defeated if you use an extension cord which does not include a protected ground terminal.
- Be sure to use fuses rated for the voltage in question.
- Do not use this instrument with the case open.
- Do not place anything on the product and do not apply excessive pressure to the product. Also, do not place flower pots or other containers containing liquid such as chemicals near this

---

## Safety Summary

product.

- When the product has ventilation outlets, do not stick or drop metal or easily flammable objects into the ventilation outlets.
- When using the product on a cart, fix it with belts to avoid its drop.
- When connecting the product to peripheral equipment, turn the power off.

- **Caution Symbols Used Within this Manual**

Symbols indicating items requiring caution which are used in this manual are shown below together with their meaning.

**DANGER:** Indicates an item where there is a danger of serious personal injury (death or serious injury).

**WARNING:** Indicates an item relating to personal safety or health.

**CAUTION:** Indicates an item relating to possible damage to the product or instrument or relating to a restriction on operation.

- **Safety Marks on the Product**

The following safety marks can be found on Advantest products.



: ATTENTION - Refer to manual.



: Protective ground (earth) terminal.



: DANGER - High voltage.



: CAUTION - Risk of electric shock.

- **Replacing Parts with Limited Life**

The following parts used in the instrument are main parts with limited life.

Replace the parts listed below before their expected lifespan has expired to maintain the performance and function of the instrument.

Note that the estimated lifespan for the parts listed below may be shortened by factors such as the environment where the instrument is stored or used, and how often the instrument is used.

The parts inside are not user-replaceable. For a part replacement, please contact the Advantest sales office for servicing.

Each product may use parts with limited life.

For more information, refer to the section in this document where the parts with limited life are described.

## Main Parts with Limited Life

Part name	Life
Unit power supply	5 years
Fan motor	5 years
Electrolytic capacitor	5 years
LCD display	6 years
LCD backlight	2.5 years
Floppy disk drive	5 years
Memory backup battery	5 years

- **Hard Disk Mounted Products**

The operational warnings are listed below.

- Do not move, shock and vibrate the product while the power is turned on.  
Reading or writing data in the hard disk unit is performed with the memory disk turning at a high speed. It is a very delicate process.
- Store and operate the products under the following environmental conditions.  
An area with no sudden temperature changes.  
An area away from shock or vibrations.  
An area free from moisture, dirt, or dust.  
An area away from magnets or an instrument which generates a magnetic field.
- Make back-ups of important data.  
The data stored in the disk may become damaged if the product is mishandled. The hard disc has a limited life span which depends on the operational conditions. Note that there is no guarantee for any loss of data.

- **Precautions when Disposing of this Instrument**

When disposing of harmful substances, be sure dispose of them properly with abiding by the state-provided law.

Harmful substances: (1) PCB (polycarbon biphenyl)  
(2) Mercury  
(3) Ni-Cd (nickel cadmium)  
(4) Other  
Items possessing cyan, organic phosphorous and hexadic chromium and items which may leak cadmium or arsenic (excluding lead in solder).

Example: fluorescent tubes, batteries

# Environmental Conditions

This instrument should be only be used in an area which satisfies the following conditions:

- An area free from corrosive gas
- An area away from direct sunlight
- A dust-free area
- An area free from vibrations
- Altitude of up to 2000 m

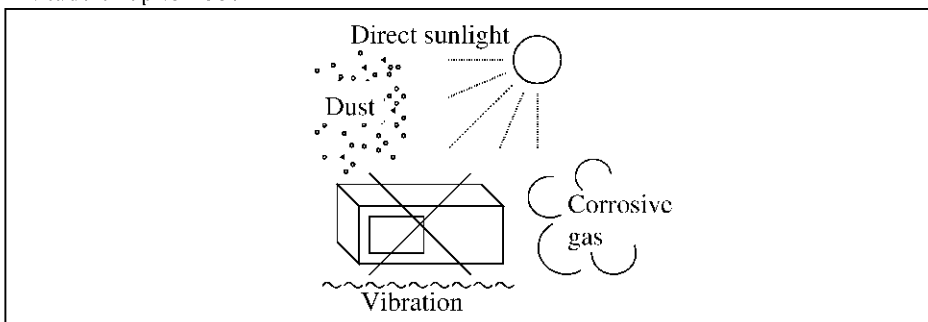

**Figure-1 Environmental Conditions**

- Operating position

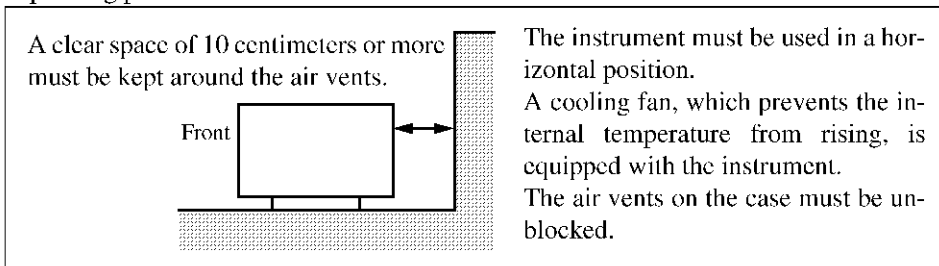

**Figure-2 Operating Position**

- Storage position

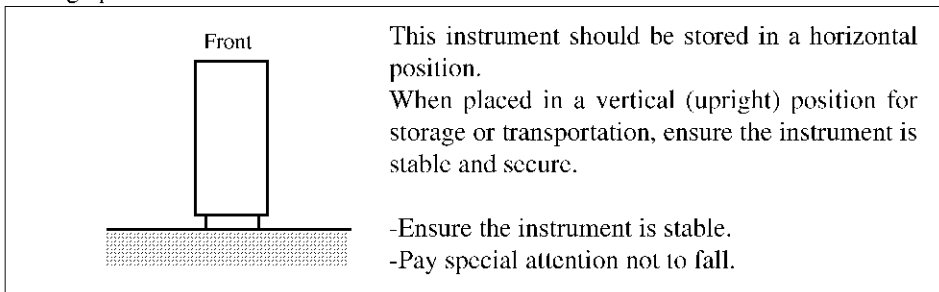

**Figure-3 Storage Position**





- The classification of the transient over-voltage, which exists typically in the main power supply, and the pollution degree is defined by IEC61010-1 and described below.

Impulse withstand voltage (over-voltage) category II defined by IEC60364-4-443

Pollution Degree 2

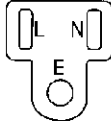
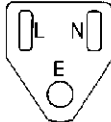
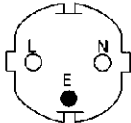
## Types of Power Cable

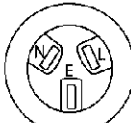
Replace any references to the power cable type, according to the following table, with the appropriate power cable type for your country.

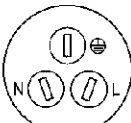
Plug configuration	Standards	Rating, color and length	Model number (Option number)
	PSE: Japan  Electrical Appliance and Material Safety Law	125 V at 7 A Black 2 m (6 ft)	Straight: A01402  Angled: A01412
	UL: United States of America  CSA: Canada	125 V at 7 A Black 2 m (6 ft)	Straight: A01403 (Option 95)  Angled: A01413
	CEE: Europe DEMKO: Denmark NEMKO: Norway VDE: Germany KEMA: The Netherlands CEBEC: Belgium OVE: Austria FIMKO: Finland SEMKO: Sweden	250 V at 6 A Gray 2 m (6 ft)	Straight: A01404 (Option 96)  Angled: A01414
	SEV: Switzerland	250 V at 6 A Gray 2 m (6 ft)	Straight: A01405 (Option 97)  Angled: A01415
	SAA: Australia, New Zealand	250 V at 6 A Gray 2 m (6 ft)	Straight: A01406 (Option 98)  Angled: -----
	BS: United Kingdom	250 V at 6 A Black 2 m (6 ft)	Straight: A01407 (Option 99)  Angled: A01417
	CCC: China	250 V at 10 A Black 2 m (6 ft)	Straight: A114009 (Option 94)  Angled: A114109





## PREFACE

This manual provides the information necessary to check functionality, operate and program the R3267 Series Option 61, IS-95 measurement.

### (1) Organization of this manual

This manual consists of the following chapters:

Safety Summary	To use the analyzer safely, be sure to read this manual first.
1. Introduction <ul style="list-style-type: none"> <li>• Product Description (Option)</li> <li>• Standard Accessories</li> <li>• Self Test Error</li> <li>• Connectors on the rear Panel</li> </ul>	Includes a description of the option and its' parts and a self test error.
2. Operation	You can learn the basic operations of the option through the examples shown in this chapter.
3. Reference <ul style="list-style-type: none"> <li>• Menu Index</li> <li>• Menu Map</li> <li>• Functional Description</li> </ul>	Shows a list of operation keys, and describes the function of each key.
4. Remote Control <ul style="list-style-type: none"> <li>• GPIB</li> </ul>	Included are a list of commands necessary for programming.
5. Technical Notes <ul style="list-style-type: none"> <li>• BTS, MS signals</li> <li>• Equalizing filter</li> <li>• Code Domain Power</li> <li>• Tx Power</li> <li>• Trigger Source</li> </ul>	Describes the principle of operation necessary for taking measurements more accurately.
6. Performance Verification Test	Describes how to test performance.
7. Specifications	Shows the specifications of the option.
APPENDIX <ul style="list-style-type: none"> <li>• Messages</li> </ul>	If an error occurs during operation, an error number and its corresponding error message are displayed. The meaning of each error is explained in this section.

(2) Typeface conventions used in this manual

- Panel keys and soft keys are printed in a contrasting typeface to make them stand out from the text as follows:

Panel keys: Boldface type

Example: **FREQ, TRANSIENT**

Soft keys: Boldface and italic type

Example: ***Center, Detector***

- When a series of key operations are described using a comma between two keys.
- There are various soft menus used to switch between two states such as ON/OFF and AUTO/MNL. For example, when turning off the ***Average Times ON/OFF*** function, the annotation “***Average Times ON/OFF(OFF)***” is used. When switching the ***RBW AUTO/MNL*** function to MNL, the annotation “***RBW AUTO/MNL(MNL)***” is used.

## TABLE OF CONTENTS

1	INTRODUCTION .....	1-1
1.1	Product Overview .....	1-1
1.2	Accessories .....	1-2
1.3	Self Test Function .....	1-3
1.4	About Calibration .....	1-3
1.5	Explanation of the Connectors .....	1-4
2	OPERATION .....	2-1
2.1	A measurement Example of BTS (base station) Code Domain Power .....	2-1
2.2	Code Domain Power on the Base Station (BTS) .....	2-11
2.3	ACP Measurement on the Base Station (BTS) .....	2-22
3	REFERENCE .....	3-1
3.1	Menu Index .....	3-1
3.2	Menu Map .....	3-5
3.3	Function Description .....	3-19
3.3.1	SWITCHING BETWEEN COMMUNICATION SYSTEMS .....	3-20
3.3.2	T-Domain .....	3-21
3.3.2.1	Power (T-Domain) .....	3-21
3.3.2.2	ON/OFF Ratio .....	3-24
3.3.2.3	Spurious (T-Domain) .....	3-26
3.3.3	F-Domain .....	3-29
3.3.3.1	Power (F-Domain) .....	3-29
3.3.3.2	OBW .....	3-32
3.3.3.3	Due to Transient .....	3-32
3.3.3.4	Due to Modulation .....	3-35
3.3.3.5	Inband Spurious .....	3-38
3.3.3.6	Outband Spurious .....	3-40
3.3.4	Modulation .....	3-42
3.3.4.1	Waveform Quality .....	3-42
3.3.4.2	Code Domain Power .....	3-45
3.3.4.3	Tx Power .....	3-49
3.3.5	STD .....	3-51
3.3.5.1	Setup STD .....	3-51
3.3.5.2	Channel Setting .....	3-53
3.3.5.3	DC CAL .....	3-53
4	REMOTE CONTROL .....	4-1
4.1	GPIB Command Index .....	4-1
4.2	GPIB Command Codes .....	4-7

Table of Contents

<b>5</b>	<b>TECHNICAL NOTES</b>	<b>5-1</b>
5.1	Waveform Quality measurement of Modulation Signal	5-1
5.2	About Equalizing Filter	5-2
5.3	Null Offset Graph	5-3
5.4	Displaying the Absolute Power	5-4
5.5	Estimated $r$ in the Code Domain Power Measurement	5-4
5.6	Peak Factor of Tx Power	5-4
5.7	Trigger Source INTVL (EXT) and INTVL	5-5
5.8	Template Edit Function	5-5
5.8.1	Template Setting in the T-Domain Measuring Mode	5-5
5.8.2	Template Setting in the F-Domain Measuring Mode	5-7
5.9	Measurement Parameter Settings in Due to Transient, Due to Modulation and Inband Spurious	5-8
5.9.1	Marker Edit Function	5-8
5.9.2	Measurement results Using Due to Modulation, Due to Transient and Inband Spurious Modes	5-9
5.9.3	Measurement Result of Inband Spurious	5-10
5.10	Mag Error (Magnitude Error)	5-11
5.11	Phase Error	5-11
5.12	E.V.M. (Error Vector Magnitude)	5-12
5.13	Block Diagram	5-13
<b>6</b>	<b>PERFORMANCE VERIFICATION TEST</b>	<b>6-1</b>
6.1	General	6-1
6.1.1	Introduction	6-1
6.1.2	Test Equipment	6-1
6.1.3	Specifications Required for Test Signals	6-3
6.1.4	Calibration Cycle	6-4
6.1.5	Performance Verification Test Record Sheet	6-4
6.1.6	Performance Verification Procedures	6-4
6.2	Performance Verification Tests Procedure	6-5
6.2.1	Waveform Quality Accuracy (Forward Link)	6-5
6.2.2	Waveform Quality Accuracy (Reverse Link)	6-6
6.2.3	Code Domain Power	6-8
6.2.4	Simplified Performance Check by Using Calibration Signal	6-10
6.3	Performance Verification Test Record Sheet	6-12
6.4	Simplified Performance Check Record Sheet	6-14
<b>7</b>	<b>SPECIFICATIONS</b>	<b>7-1</b>
<b>APPENDIX</b>		<b>A-1</b>
A.1	Messages	A-1

ALPHABETICAL INDEX ..... I-1



## LIST OF ILLUSTRATIONS

No.	Title	Page
2-1	Setup for Code Domain Power Measurement .....	2-1
2-2	STD Setup .....	2-1
2-3	Parameter Setup .....	2-3
2-4	Auto Level Completed .....	2-4
2-5	Scale Setup .....	2-5
2-6	Measurement Results .....	2-6
2-7	Parameter Setup (PN Offset Search Mode OFF) .....	2-6
2-8	PRECISE Mode .....	2-7
2-9	Graphics Display Setting Example of Scale Setup t .....	2-8
2-10	Display Example of t Graph .....	2-9
2-11	Setting Example of Display .....	2-9
2-12	Display Example .....	2-10
2-13	Setup for Code Domain Power Measurement .....	2-11
2-14	Setting Example of STD Setup .....	2-11
2-15	Setting Example of Parameter Setup .....	2-13
2-16	Setting Example of Scale Setup .....	2-15
2-17	Display Example of Measurement Results .....	2-16
2-18	Setting Example of Parameter Setup (PN Offset Search Mode OFF) .....	2-17
2-19	Setting Parameter Setup PRECISE Mode .....	2-18
2-20	Graphics Display Setting Example of Scale Setup t .....	2-19
2-21	Display Example of t Graph .....	2-20
2-22	Setting Example of Display .....	2-20
2-23	Display Example .....	2-21
2-24	Setup for ACP Measurement .....	2-22
2-25	STD Setup Setting .....	2-22
2-26	Marker Edit Setting .....	2-24
2-27	Parameter Setup Setting for the ACP Measurement .....	2-25
2-28	Measurement Results .....	2-25
3-1	Dialog Box Used for the Communication Systems .....	3-20
3-2	Trigger Setup Dialog Box .....	3-21
3-3	Parameter Setup Dialog Box .....	3-23
3-4	Trigger Setup Dialog Box .....	3-24
3-5	Parameter Setup Dialog Box .....	3-25
3-6	Trigger Setup Dialog Box .....	3-26
3-7	Parameter Setup Dialog Box .....	3-27
3-8	Trigger Setup Dialog Box .....	3-29
3-9	Detector Dialog Box .....	3-30
3-10	Parameter Setup Dialog Box .....	3-31
3-11	Parameter Setup Dialog Box .....	3-32
3-12	Parameter Setup Dialog Box .....	3-33
3-13	Trigger Setup Dialog Box .....	3-35
3-14	Detector Dialog Box .....	3-36
3-15	Parameter Setup Dialog Box .....	3-37
3-16	Parameter Setup Dialog Box .....	3-39
3-17	Parameter Setup Dialog Box .....	3-41

List of Illustrations

No.	Title	Page
3-18	Select Type Dialog Box .....	3-42
3-19	Parameter Setup Dialog Box .....	3-43
3-20	Scale Setup Dialog Box .....	3-45
3-21	Parameter Setup Dialog Box .....	3-46
3-22	Parameter Setup Dialog Box .....	3-49
3-23	STD Set Dialog Box .....	3-51
5-1	Foward Link .....	5-1
5-2	Reverse Link .....	5-2
5-3	Reverse Link Constellation .....	5-3
5-4	Null Offset Constellation .....	5-3
5-5	Template to Be Set .....	5-5
5-6	Template settings .....	5-6
5-7	Template Shifted Using the Shift Y Function .....	5-6
5-8	Template with the Set Values .....	5-7
5-9	Template with Margin Delta X .....	5-7
5-10	Example of Marker Edit Setting .....	5-8
5-11	Marker Edit Setting .....	5-9
5-12	Example of Peak Marker Y Delta .....	5-9
5-13	Mag Error, Phase Error, E.V.M. ....	5-12
5-14	Block Diagram .....	5-13
6-1	Timing Chart .....	6-3
6-2	Setup of Waveform Quality Test for Forward Link .....	6-5
6-3	Setting of Measurement Parameter for Forward Link Waveform Quality Test .....	6-6
6-4	Setup of Waveform Quality Test for Reverse Link .....	6-7
6-5	Setting of Measurement Parameter for Reverse Link Waveform Quality Test .....	6-8
6-6	Setup of Code Domain Power Test .....	6-9
6-7	Setting of Measurement Parameter for Code Domain Power Test .....	6-10
6-8	Setup of Simplified Performance Check .....	6-11
6-9	Setting of Measurement Parameter for Simplified Performance Check .....	6-11



## LIST OF TABLES

No.	Title	Page
4-1	Operating Mode .....	4-7
4-2	ATT Key (Attenuator) .....	4-7
4-3	COPY Key (Hard Copy) .....	4-7
4-4	COUPLE Key (Couple Function) .....	4-8
4-5	FREQ Key (Frequency) .....	4-8
4-6	LEVEL Key .....	4-8
4-7	MKR key .....	4-9
4-8	PRESET Key(Initialization) .....	4-9
4-9	RCL Key (Reading Data) .....	4-9
4-10	SAVE Key (Saving Data) .....	4-9
4-11	SPAN Key (Frequency Span) .....	4-9
4-12	TRANSIENT Key .....	4-10
4-13	Numeric keys/Step keys/Data knob/Unit keys (Entering data) .....	4-40
4-14	Miscellaneous .....	4-41
6-1	Performance Verification Items .....	6-1
6-2	Equipment List .....	6-2
6-3	Specifications Required for Test Signals .....	6-3



## **1 INTRODUCTION**

### **1.1 Product Overview**

This IS-95 analysis option software (Option 61) allows you to measure the waveform quality and modulation accuracy of a IS-95 signal.

This option is a factory option which is incorporated into the R3267 Series Spectrum Analyzer prior to shipment.

This option includes the following features:

- For the Cellular and PCS base station (BTS) or the mobile station (MS), this option use to measure the modulation accuracy, waveform quality, frequency error.
- Used to measure the code domain power of the BTS signals.
- Use to measure the channel power, spurious and gated output power specified by the communication standard using a simple key operation.

1.2 Accessories

**1.2 Accessories**

Name of accesories	Type of name	Quantity	Remarks
R3267 Series OPT61 Operation manual	ER3267/73OPT61	1	English

### 1.3 Self Test Function

The self test also checks the Option 61 for correct operation when the spectrum analyzer power is turned on. The message shown below will be displayed when an error related to Option 61 occurs. Contact ADVANTEST Corp. for repair.

Error Message
Handshake error occurred to DSP

### 1.4 About Calibration

When you want to calibrate the R3267 Series, please contact a sales representative.

Desirable Period	One year
------------------	----------

## 1.5 Explanation of the Connectors

### 1.5 Explanation of the Connectors

Connectors used for this option are described as follows:

- ① EXT TRIG terminal Connector for inputting the external trigger signal.
- ② I channel terminal Connector for inputting the I channel signal (Baseband).
- ③ Q channel terminal Connector for inputting the Q channel signal (Baseband).

## 2 OPERATION

This chapter describes how to use this option using practical measurement examples.

### 2.1 A measurement Example of BTS (base station) Code Domain Power

When connecting Even Second Clock from the BTS to the instrument:

A measurement example of the BTS code domain power is shown below.

It is assumed that a reference signal of 10 MHz, Even Second Clock, and a signal to be measured is received from the BTS and that the signal corresponds to one channel of the US Cellular system.

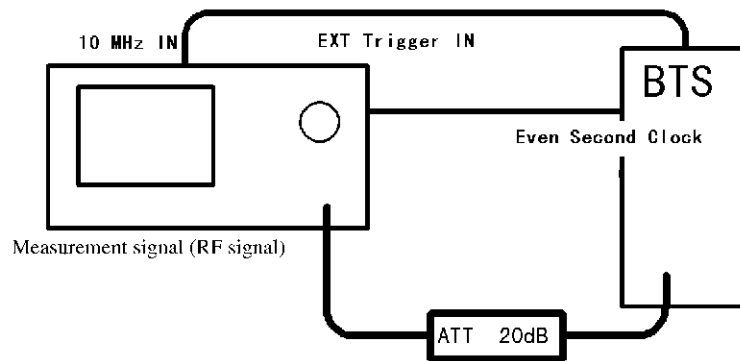

Figure 2-1 Setup for Code Domain Power Measurement

Set the STD menu

Set measurement parameters. Select a parameter using the data knob, then press the data knob (or ENTR) to register the parameter. Set parameters as shown below.

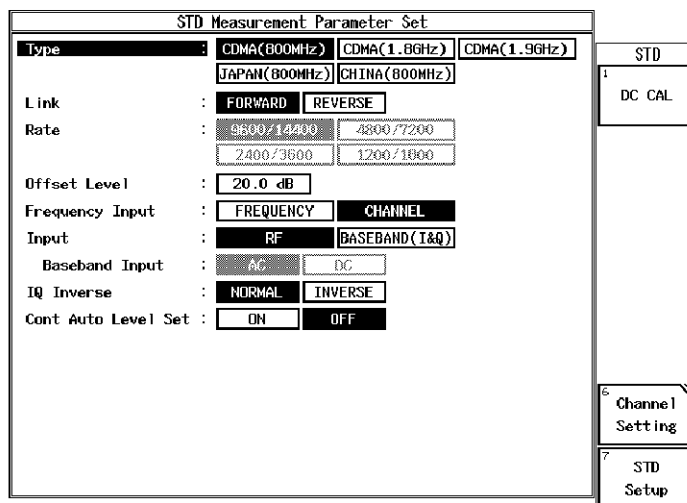

Figure 2-2 STD Setup

## 2.1 A measurement Example of BTS (base station) Code Domain Power

1. Press **TRANSIENT** , **STD and STD Setup** to open the STD Setup window.
2. Select **CDMA (800 MHz)** for **Type** using the data knob since the measurement target is a US Cellular system signal, then press the data knob (or **ENTR**) to register the parameter.
3. Select **FORWARD** using the data knob to measure the BTS signal, then press the data knob (or **ENTR**) to register the parameter.
4. Enter **2, 0**, and **+dBm** using the numeric keys since the signal is attenuated by the ATT of 20 dB.
5. Select **CHANNEL** for **Frequency Input** using the data knob to set a center frequency using a channel number, then press the data knob (or **ENTR**) to register the parameter.
6. Select RF for **Input** using the data knob since an **RF** signal is input, then press the data knob (or **ENTR**) to register the parameter.
7. Select **NORMAL** for **IQ Inverse** using the data knob when the phase of the input signal is not inverted, then press the data knob (or **ENTR**) to register the parameter.
8. Select **OFF** for **Cont. Auto Level Set** using the data knob when the auto ranging function is not used, then press the data knob (or **ENTR**) to register the parameter.
9. Press **RETURN** to exit the STD Setup window.



## 2.1 A measurement Example of BTS (base station) Code Domain Power

## Parameter Setup

10. Press **Modulation** and **Code Domain Power** to enter the Code Domain Power measurement menu.

Start measurement, when the PN Offset number is unknown.

When the PN Offset number is unknown, it is necessary to search for the PN Offset number by setting PN Offset Search Mode to ON.

To connect Even Second Clock to the instrument as a trigger signal, set parameters as shown below. Proceed with the following procedure.

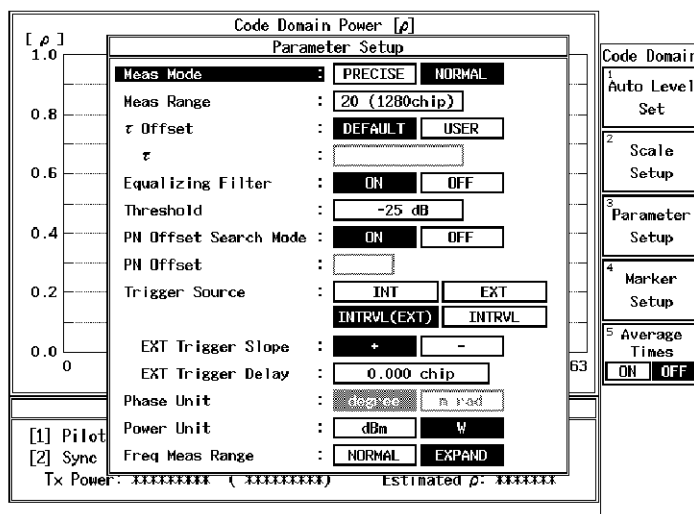

Figure 2-3 Parameter Setup

11. Press **Parameter Setup** to open the Parameter Setup window.
12. Select **NORMAL** for **Meas Mode** using the data knob, then press the data knob (or **ENTR**) to register the parameter.
13. **Meas Range** is set to 20 by default. Pressing the data knob (or **ENTR**) moves the cursor to the next item.
14. **τ Offset** is set to **DEFAULT** by default. Pressing the data knob (or **ENTR**) moves the cursor to the next item.
15. Select **ON** for **Equalizing Filter** using the data knob when a signal to be measured is filtered by an equalizing filter, then press the data knob (or **ENTR**) to register the parameter.
16. **Threshold** is set to -25 dB by default. Pressing  $\nabla$  key moves the cursor to the next item.
17. Select **ON** for **PN Offset Search Mode** using the data knob, then press the data knob (or **ENTR**) to register the parameter.

2.1 A measurement Example of BTS (base station) Code Domain Power

18. Select *INTRVL (EXT)* using the data knob to connect Even Clock to the instrument as Trigger, then press the data knob (or **ENTR**) to register the parameter.
19. *EXT Trigger Slope* is set to + by default. Pressing the data knob (or **ENTR**) moves the cursor to the next item.
20. *EXT Trigger Delay* is set to 0.000 by default. Pressing the data knob (or **ENTR**) moves the cursor to the next item.
21. Set the display unit of the absolute power for each channel to W. W is set by default. Pressing the data knob (or **ENTR**) moves the cursor to the next item.
22. Set *EXPAND* to widen the measurement range of frequency errors. *EXPAND* is set by default.  
Then press the data knob (or **ENTR**) to register the parameter.
23. Press *Parameter Setup* to close the Parameter Setup window.

Setting the Frequency and Reference Level

Press **FREQ, 1** and **ENTR** to set the frequency using the channel number.

24. Press **RETURN** to change the soft menu to the measurement menu.  
Press *Auto Level Set*.

Wait until the following message is displayed:

Auto Level Completed !

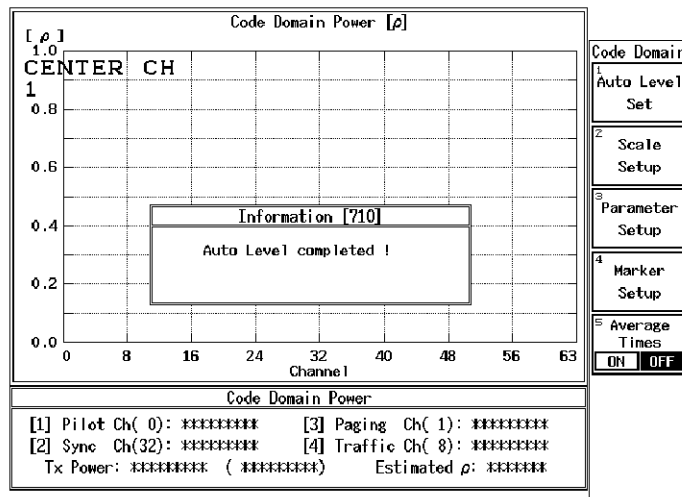

Figure 2-4 Auto Level Completed

The reference level is automatically set.

## 2.1 A measurement Example of BTS (base station) Code Domain Power

## Measurement Result Display

25. Press the **SINGLE** key to carry out measurement.

Set parameters as shown below to display the power ratios of each channel to the total power on the upper part of the screen and the time alignment error, frequency error, and PN Offset on the lower part of the screen.

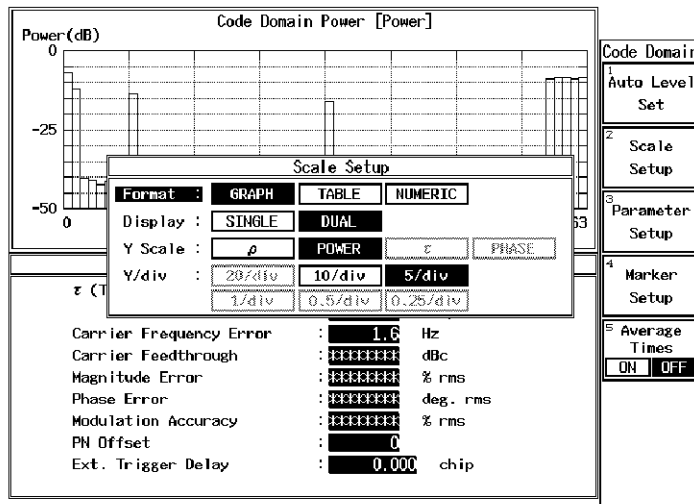

Figure 2-5 Scale Setup

26. Press *Scale Setup* to open the Scale Setup window.
27. Select **GRAPH** from *Format* using the data knob, then press the data knob (or **ENTR**) to register the parameter.
28. Select **DUAL** from Display using the data knob, then press the data knob (or **ENTR**) to register the parameter.
29. Select **POWER** from Y Scale using the data knob, then press the data knob (or **ENTR**) to register the parameter.
30. Select **5/div** from Y/div using the data knob, then press the data knob (or **ENTR**) to register the parameter.

2.1 A measurement Example of BTS (base station) Code Domain Power

31. Press **Scale Setup** to close the Scale Setup window.

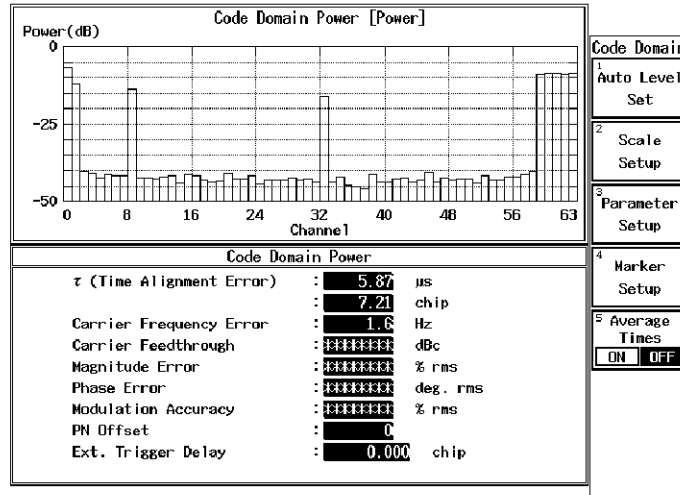

Figure 2-6 Measurement Results

Setting PN Offset

PN Offset of the signal can be determined when PN Offset Search Mode is set to ON. Next, set PN Offset Search Mode to OFF using the PN Offset value to make the repetition time shorter.

Read the PN Offset value from the measurement results.

In this example, the PN Offset value is 0.

Set parameters as shown below.

(Set PN Offset Search Mode to OFF and PN offset to 0.)

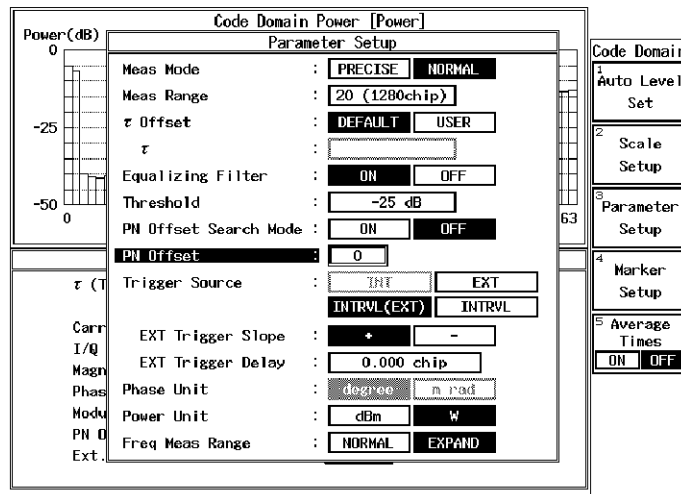

Figure 2-7 Parameter Setup (PN Offset Search Mode OFF)

2.1 A measurement Example of BTS (base station) Code Domain Power

32. Press **Parameter Setup** to open the Parameter Setup window.
33. Press  $\nabla$  key to align the cursor with the selected item in **PN Offset Search Mode**.
34. Turn the data knob to switch the cursor to **OFF**, then press the data knob (or **ENTR**) to register the parameter.
35. Enter **0** and **ENTR** to **PN Offset**.
36. Press **Parameter Setup** to close the Parameter Setup window.
37. Press the **REPEAT** or **SINGLE** key to start measurement.  
Press the **STOP** key to stop measurement.

Marker

38. Pressing the **MKR** key displays a marker.  
Moving the marker using the data knob allows you to read Code Power,  $\rho$ , and Power together with the channel number.
39. Press **SHIFT** and **MKR** to turn the marker **OFF**.  
Press **RETURN** to change the soft menu to the measurement menu.

Measuring the Tau and Phase

Measure time alignment errors and phase errors for each channel based on the Pilot signal.  
Change Meas Mode to PRECISE.

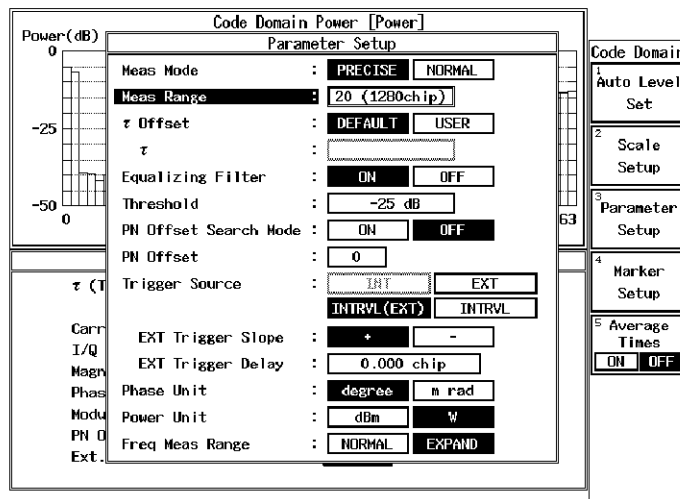

Figure 2-8 PRECISE Mode

2.1 A measurement Example of BTS (base station) Code Domain Power

40. Press **Parameter Setup** to open the Parameter Setup window.
41. Used to set **Meas Mode** to **PRECISE** using the data knob, then press the data knob (or **ENTR**) to register the parameter.
42. Press **Parameter Setup** to close the Parameter Setup window.
43. Press the **REPEAT** or **SINGLE** key to start measurement.  
Press the **STOP** key to stop measurement.

Displaying a  $\tau$  Graph

Set parameters to display a graph with a time alignment error (Tau) set to the vertical axis.

Set parameters as shown below.

A single screen display can show a graph with a time alignment error on the vertical axis and a channel on the horizontal axis.

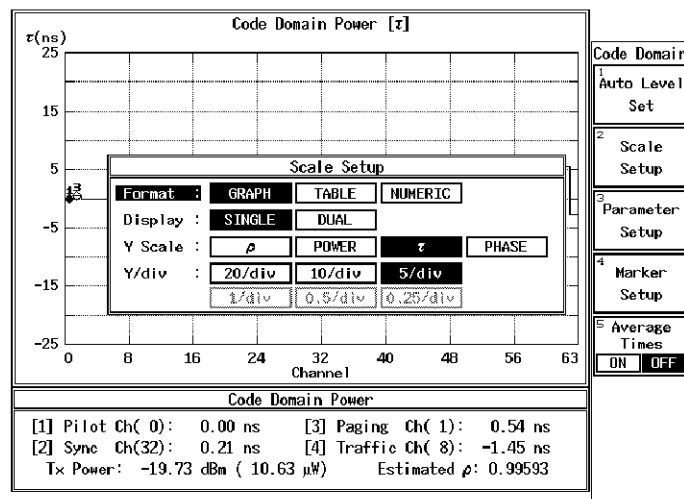

Figure 2-9 Graphics Display Setting Example of Scale Setup  $\tau$

44. Press **Scale Setup** to open the Scale Setup window.
45. Select **GRAPH** from **Format** using the data knob, then press the data knob (or **ENTR**) to register the parameter.
46. Select **SINGLE** from **Display** using the data knob, then press the data knob (or **ENTR**) to register the parameter.
47. Select  $\tau$  from **Y Scale** using the data knob, then press the data knob (or **ENTR**) to register the parameter.
48. Select **5/div** from **Y/div** using the data knob, then press the data knob (or **ENTR**) to register the parameter.

2.1 A measurement Example of BTS (base station) Code Domain Power

49. Press **Scale Setup** to close the Scale Setup window.

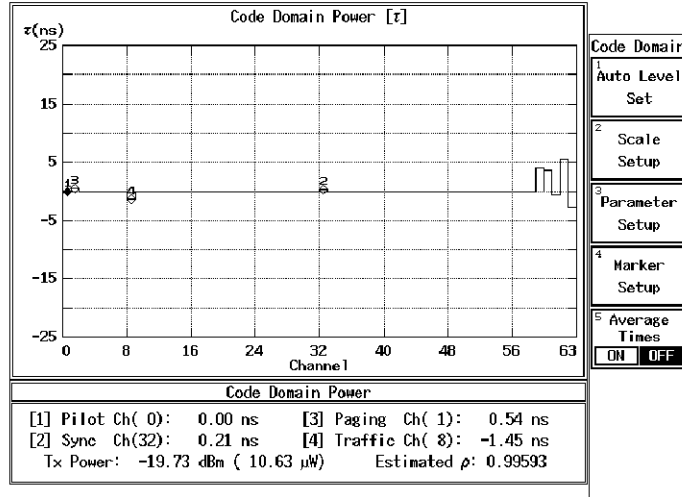

Figure 2-10 Display Example of  $\tau$  Graph

Displaying a  $\theta$  Table

A Phase difference based on the Pilot signal is displayed in table format. Set parameters as shown below.

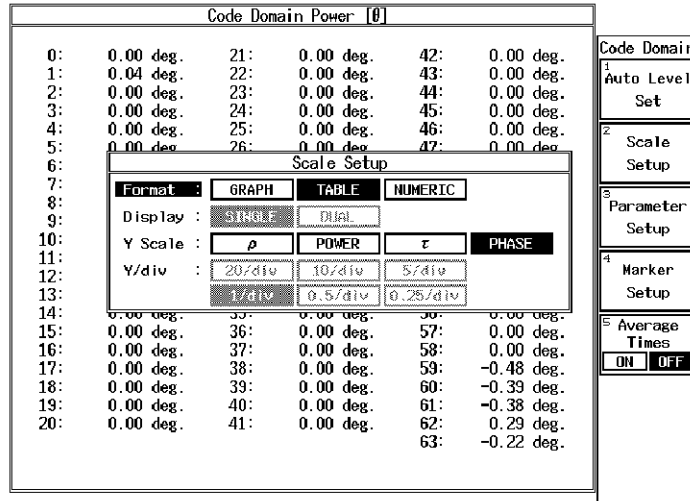

Figure 2-11 Setting Example of Display

50. Press **Scale Setup** to open the Scale Setup window.

51. Select **TABLE** from **Format** using the data knob, then press the data knob (or **ENTR**) to register the parameter.

52. Select **PHASE** from **Y Scale** using the data knob, then press the data knob (or

2.1 A measurement Example of BTS (base station) Code Domain Power

ENTR) to register the parameter.

53. Press *Scale Setup* to close the Scale Setup window.

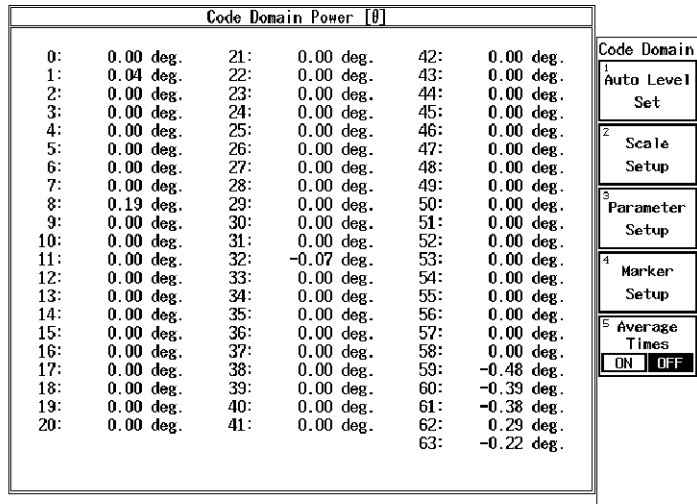

Figure 2-12 Display Example



## 2.2 Code Domain Power on the Base Station (BTS)

A measurement example of BTS (base station) code domain power

When Even Second Clock cannot be received from the BTS a measurement example of the BTS code domain power is given below.

The signal is one channel of US Cellular system.

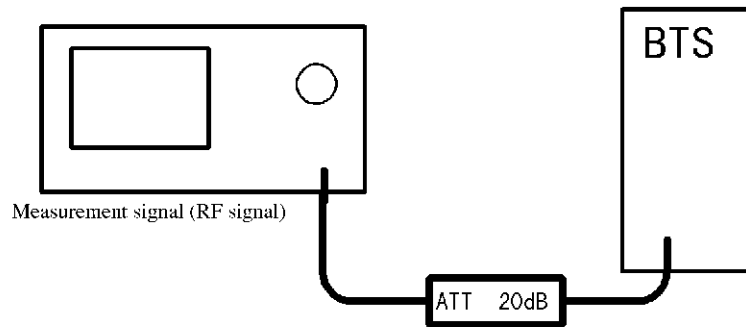

Figure 2-13 Setup for Code Domain Power Measurement

Set the STD menu

STD Measurement Parameter Set			STD
Type	CDMA(800MHz)   CDMA(1.8GHz)   CDMA(1.9GHz)		1 STD
	JAPAN(800MHz)   CHINA(800MHz)		DC CAL
Link	FORWARD   REVERSE		
Rate	9600/14400   4800/7200		
	2400/3600   1200/1800		
Offset Level	20.0 dB		
Frequency Input	FREQUENCY   CHANNEL		
Input	RF   BASEBAND(I&Q)		
Baseband Input	AC   DC		
IQ Inverse	NORMAL   INVERSE		
Cont Auto Level Set	ON   OFF		
			6 Channel Setting
			7 STD Setup

Figure 2-14 Setting Example of STD Setup

## 2.2 Code Domain Power on the Base Station (BTS)

1. Press **TRANSIENT**, **STD** and **STD Setup** to open the STD Setup window.
2. Select **CDMA (800 MHz)** for Type using the data knob since a measurement target is a US Cellular, then press the data knob (or **ENTR**) to register the parameter.
3. Select **FORWARD** using the data knob to measure the BTS signal, then press the data knob (or **ENTR**) to register the parameter.
4. Enter **2,0** using the numeric keys, and **+dBm** since the signal is attenuated by the ATT of 20 dB.
5. Select **CHANNEL** for **Frequency Input** using the data knob to set a center frequency using a channel number, then press the data knob (or **ENTR**) to register the parameter.
6. Select RF for **Input** using the data knob since an **RF** signal is input, then press the data knob (or **ENTR**) to register the parameter.
7. Select **NORMAL** for **IQ Inverse** using the data knob when the phase of the input signal is not inverted, then press the data knob (or **ENTR**) to register the parameter.
8. Select **OFF** for **Cont Auto Level Set** using the data knob when the auto ranging function is not used, then press the data knob (or **ENTR**) to register the parameter.
9. Press **RETURN** to exit from the STD Setup window.

## Parameter Setup

10. Press **Modulation** and **Code Domain Power** to enter the Code Domain Power measurement menu.
11. Set parameters as shown below. Proceed with the following procedure.

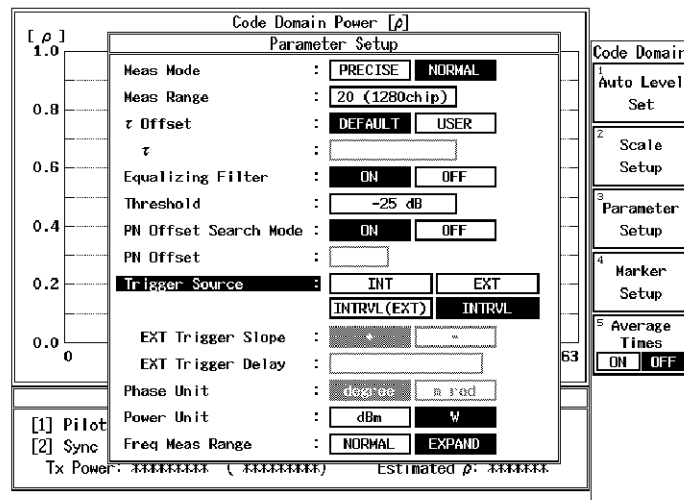

Figure 2-15 Setting Example of Parameter Setup

12. Press **Parameter Setup** to open the Parameter Setup window.
13. Select **NORMAL** for **Meas Mode** using the data knob, then press the data knob (or **ENTR**) to register the parameter.
14. **Meas Range** is set to 20 by default. Pressing the data knob (or **ENTR**) moves the cursor to the next item.
15. **τ Offset** is set to **DEFAULT** by default. Pressing the data knob (or **ENTR**) moves the cursor to the next item.
16. Select **ON** for **Equalizing Filter** using the data knob when a signal to be measured is filtered by an equalizing filter, then press the data knob (or **ENTR**) to register the parameter.
17. **Threshold** is set to -25 dB by default. Pressing  $\nabla$  key moves the cursor to the next item.
18. Select **ON** for **PN Offset Search Mode** using the data knob, then press the data knob (or **ENTR**) to register the parameter.
19. Select **INTRVL** using the data knob, then press the data knob (or **ENTR**) to register the parameter. (Because nothing is connected as the external trigger.)

## 2.2 Code Domain Power on the Base Station (BTS)

20. Set the display unit of the absolute power for each channel to W. W is set by default. Pressing the data knob (or **ENTR**) moves the cursor to the next item.
21. Set **EXPAND** to widen the measurement range of frequency errors. **EXPAND** is set by default.  
And press the data knob (or **ENTR**) to resister the parameter.
22. Press **Parameter Setup** to close the Parameter Setup window.

### Setting the Frequency and Reference Level

23. Press **FREQ, 1** and **ENTR** to set the frequency using the channel number.  
Press **RETURN** to change the soft menu to the measurement menu.
24. Press **Auto Level Set**.

Wait until the following message is displayed:

Auto Level Completed !

The reference level is automatically set.

Measurement Result Display.

25. Press the **SINGLE** key to carry out measurement.

Set parameters as shown below to display the power ratios of each channel to the total power on the upper part of the screen and the time alignment error, frequency error, and PN Offset on the lower part of the screen.

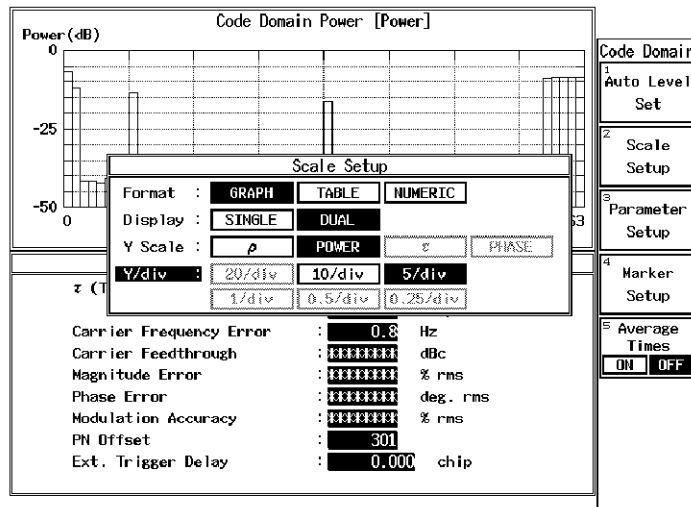

Figure 2-16 Setting Example of Scale Setup

26. Press *Scale Setup* to open the Scale Setup window.
27. Select **GRAPH** from *Format* using the data knob, then press the data knob (or **ENTR**) to register the parameter.
28. Select **DUAL** from *Display* using the data knob, then press the data knob (or **ENTR**) to register the parameter.
29. Select **POWER** from *Y Scale* using the data knob, then press the data knob (or **ENTR**) to register the parameter.
30. Select **5/div** from *Y/div* using the data knob, then press the data knob (or **ENTR**) to register the parameter.

2.2 Code Domain Power on the Base Station (BTS)

31. Press **Scale Setup** to close the Scale Setup window.

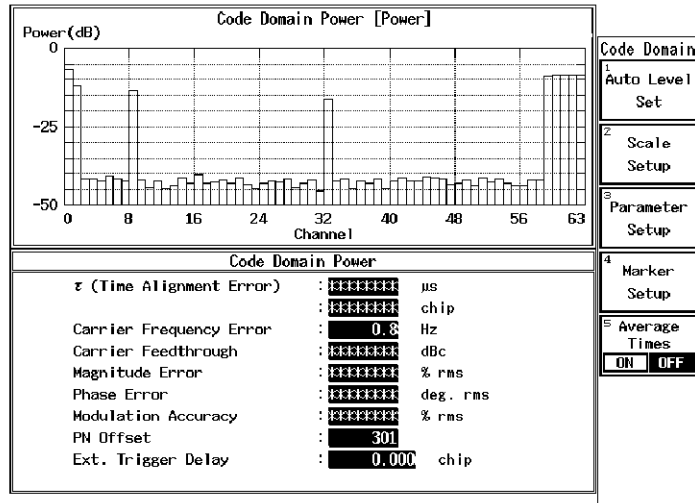

Figure 2-17 Display Example of Measurement Results

## Setting PN Offset

PN Offset of the signal has been determined by measuring the signal with PN Offset Search Mode set to ON.

Next, set PN Offset Search Mode to OFF using the PN Offset value to make the repetition time faster.

Read the PN Offset value from the measurement results.

In this example, the PN Offset value is 301.

32. Set parameters as shown below.  
(Set PN Offset Search Mode to OFF and PN offset to 301.)

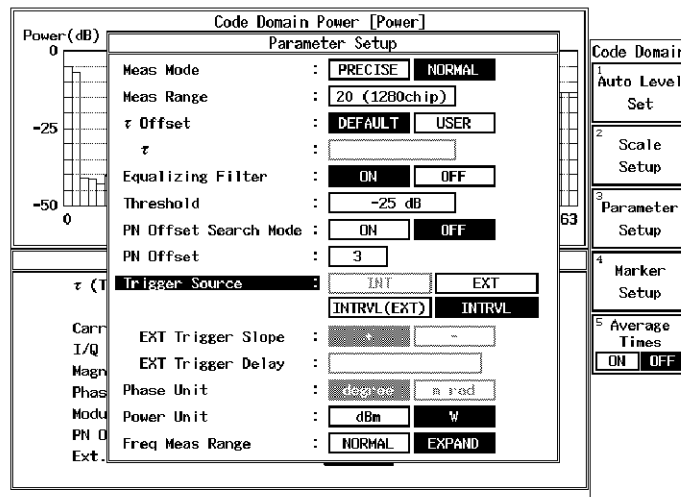

Figure 2-18 Setting Example of Parameter Setup (PN Offset Search Mode OFF)

33. Press *Parameter Setup* to open the Parameter Setup window.
34. Press  $\nabla$  key to align the cursor with the selection item of *PN Offset Search Mode*.
35. Turn the data knob to move the cursor to *OFF*, then press the data knob (or **ENTR**) to register the parameter.
36. Enter **3, 0, 1** and **ENTR** to *PN Offset*.
37. Press *Parameter Setup* to close the Parameter Setup window.
38. Press the **REPEAT** or **SINGLE** key to start measurement.  
Press the **STOP** key to stop measurement.

2.2 Code Domain Power on the Base Station (BTS)

**CAUTION:** When making a measurement for long hours, PN Offset may drift and the measurement may not be successful, because the 10 MHz reference signal of this instrument is not in synchronization with the BTS 10 MHz.

Marker

39. Pressing the **MKR** key displays a marker.  
Moving the marker using the data knob allows you to read Code Power,  $\rho$ , and Power together with the channel number.
40. Press **SHIFT** and **MKR** to turn the marker OFF.  
Press **RETURN** to change the soft menu to the measurement menu.

Measuring Tau and Phase

Measure time alignment errors and phase errors for each channel based on the Pilot signal. Change *Meas Mode* to **PRECISE**.

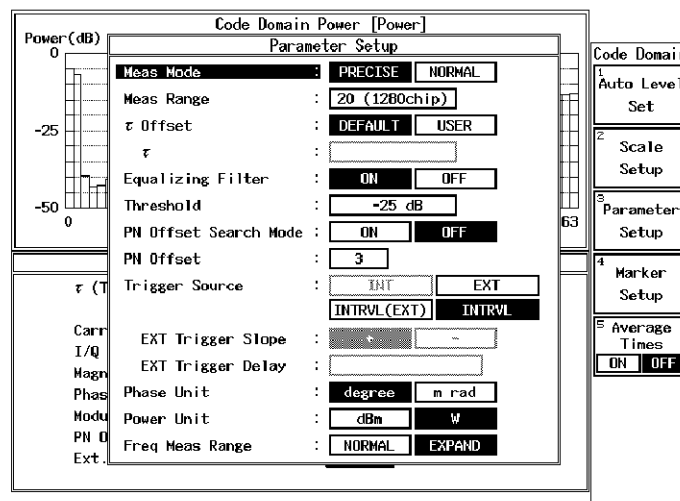

Figure 2-19 Setting Parameter Setup PRECISE Mode

41. Press *Parameter Setup* to open the Parameter Setup window.
42. Used to set *Meas Mode* to **PRECISE** using the data knob, then press the data knob (or **ENTR**) to register the parameter.
43. Press *Parameter Setup* to close the Parameter Setup window.
44. Press the **REPEAT** or **SINGLE** key to start measurement.  
Press the **STOP** key to stop measurement.



Displaying a  $\tau$  Graph

Set parameters to display a graph with a time alignment error (Tau) set to the vertical axis.

45. Set parameters as shown below. Proceed with the following procedure.  
A single screen display can show a graph with an time alignment error on the vertical axis and a channel on the horizontal axis.

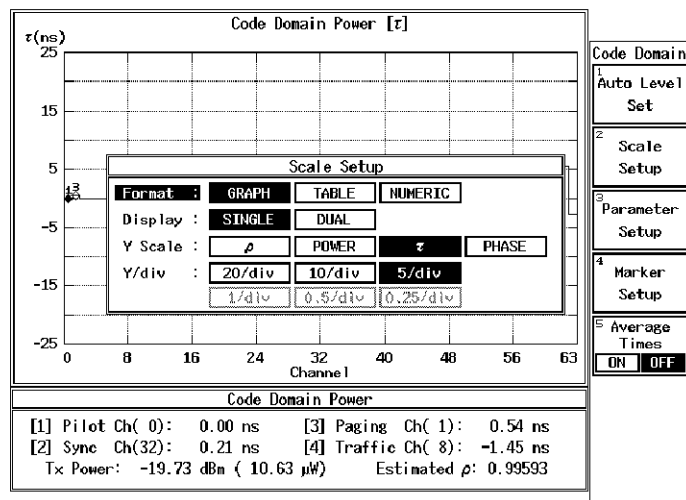

Figure 2-20 Graphics Display Setting Example of Scale Setup  $\tau$

46. Press *Scale Setup* to open the Scale Setup window.
47. Select **GRAPH** from *Format* using the data knob, then press the data knob (or **ENTR**) to register the parameter.
48. Select **SINGLE** from *Display* using the data knob, then press the data knob (or **ENTR**) to register the parameter.
49. Select  $\tau$  from the *Y Scale* using the data knob, then press the data knob (or **ENTR**) to register the parameter.
50. Select **5/div** from *Y/div* using the data knob, then press the data knob (or **ENTR**) to register the parameter.

2.2 Code Domain Power on the Base Station (BTS)

51. Press **Scale Setup** to close the Scale Setup window.

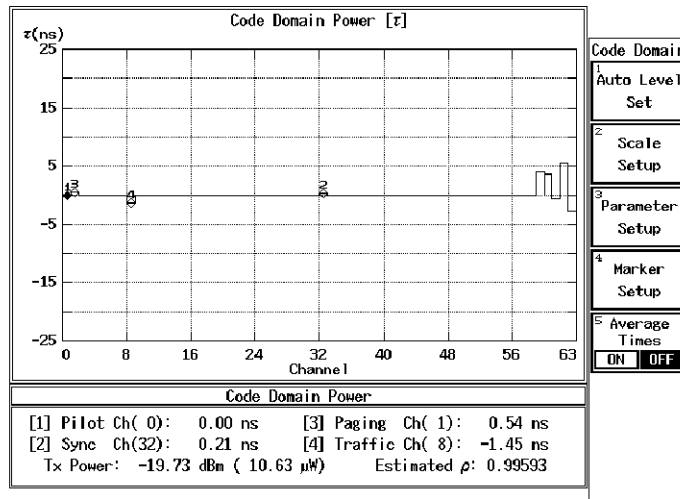

Figure 2-21 Display Example of  $\tau$  Graph

Displaying a  $\theta$  Table

A Phase difference based on the Pilot signal is displayed in table format.

52. Set parameters as shown below. Proceed with the following procedure.

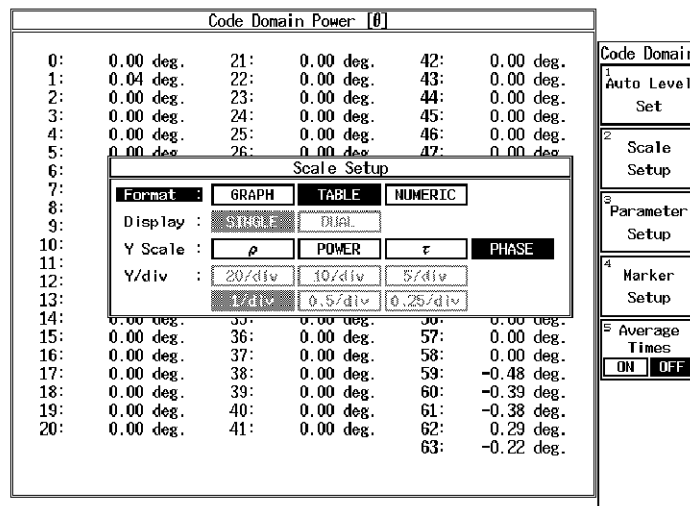

Figure 2-22 Setting Example of Display

53. Press **Scale Setup** to open the Scale Setup window.

54. Select **TABLE** from **Format** using the data knob (or **ENTR**) to register the parameter.

2.2 Code Domain Power on the Base Station (BTS)

55. Select **PHASE** from **Y Scale** using the data knob, then press the data knob (or **ENTR**) to register the parameter.
56. Press **Scale Setup** to close the Scale Setup window.

Code Domain Power [0]					
0:	0.00 deg.	21:	0.00 deg.	42:	0.00 deg.
1:	0.04 deg.	22:	0.00 deg.	43:	0.00 deg.
2:	0.00 deg.	23:	0.00 deg.	44:	0.00 deg.
3:	0.00 deg.	24:	0.00 deg.	45:	0.00 deg.
4:	0.00 deg.	25:	0.00 deg.	46:	0.00 deg.
5:	0.00 deg.	26:	0.00 deg.	47:	0.00 deg.
6:	0.00 deg.	27:	0.00 deg.	48:	0.00 deg.
7:	0.00 deg.	28:	0.00 deg.	49:	0.00 deg.
8:	0.19 deg.	29:	0.00 deg.	50:	0.00 deg.
9:	0.00 deg.	30:	0.00 deg.	51:	0.00 deg.
10:	0.00 deg.	31:	0.00 deg.	52:	0.00 deg.
11:	0.00 deg.	32:	-0.07 deg.	53:	0.00 deg.
12:	0.00 deg.	33:	0.00 deg.	54:	0.00 deg.
13:	0.00 deg.	34:	0.00 deg.	55:	0.00 deg.
14:	0.00 deg.	35:	0.00 deg.	56:	0.00 deg.
15:	0.00 deg.	36:	0.00 deg.	57:	0.00 deg.
16:	0.00 deg.	37:	0.00 deg.	58:	0.00 deg.
17:	0.00 deg.	38:	0.00 deg.	59:	-0.48 deg.
18:	0.00 deg.	39:	0.00 deg.	60:	-0.39 deg.
19:	0.00 deg.	40:	0.00 deg.	61:	-0.38 deg.
20:	0.00 deg.	41:	0.00 deg.	62:	0.29 deg.
				63:	-0.22 deg.

Code Domain
1 Auto Level Set
2 Scale Setup
3 Parameter Setup
4 Marker Setup
5 Average Times
ON OFF

Figure 2-23 Display Example

2.3 ACP Measurement on the Base Station (BTS)

2.3 ACP Measurement on the Base Station (BTS)

This section describes how to measure the ACP of the signal (continuous wave) received from the base station assign to US Cellular channel 5, which has a carrier frequency of 1.98 MHz, an output level of 0 dBm, an ACP offset of 3.125 MHz.

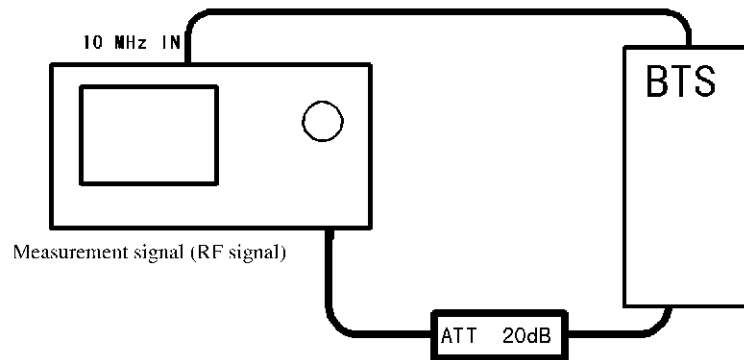

Figure 2-24 Setup for ACP Measurement

STD menu settings

Set measurement parameters as follows. To set each parameter, turn the data knob, and press the data knob (or **ENTR**) to register the parameter.

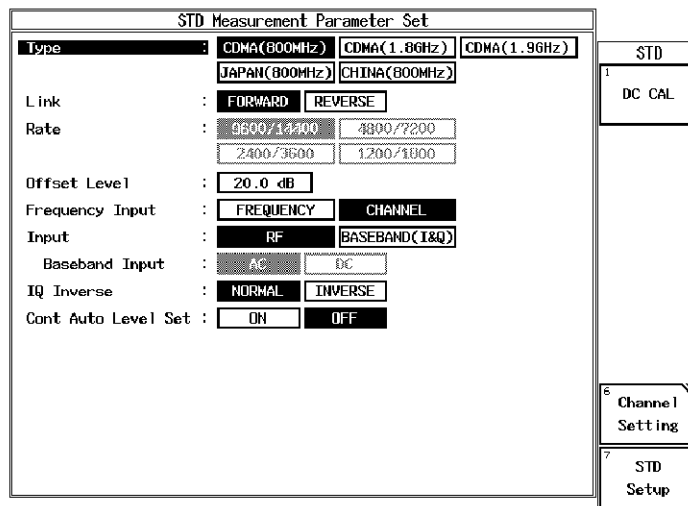

Figure 2-25 STD Setup Setting

1. Press **TRANSIENT**, **STD** and **STD Setup** to open the STD Setup window.

2. As a measurement target is a US cellular signal, select **CDMA (800 MHz)** in **Type** using the data knob, and press the data knob (or **ENTR**) to register the parameter.
3. To measure the BTS signal, select **FORWARD** using the data knob, and press the data knob (or **ENTR**) to register the parameter.
4. As the signal is attenuated by the 20 dB ATT, enter **2, 0**, and **+dBm** using the numeric keys.
5. To set the center frequency of a channel, select **CHANNEL** in **Frequency Input** using the data knob, and press the data knob (or **ENTR**) to register the parameter.
6. As an RF signal is input, select **RF** in **Input** using the data knob, and press the data knob (or **ENTR**) to register the parameter.
7. Assuming that the phase of the input signal is not inverted, select **NORMAL** in **IQ Inverse** using the data knob, and press the data knob (or **ENTR**) to register the parameter.
8. Assuming that the auto ranging function is not used, select **OFF** in **Cont Auto Level Set** using the data knob, and press the data knob (or **ENTR**) to register the parameter.
9. Press **RETURN** to exit from the STD Setup window.
10. Press **F-Domain** and **Due to Transient** to enter the Due to Transient measurement menu.
11. As the template is not used, turn off the setting. Select the **Template OFF** in the Template menu using the data knob, and press the data knob (or **ENTR**) to register the parameter.  
Press **RETURN** to exit from the menu.
12. Setting the channel and channel bandwidth to measure the ACP.  
Press **Marker Edit** to open the marker setting menu.
13. Press **Table Init** to initialize the table.
14. Select **INTEGRAL** in **Reference MKR Type** using the data knob, and press the data knob (or **ENTR**) to register the parameter.
15. Enter **1, ,, 2, 2, 8, 8** and **MHz** using the numeric keys in **Band Width**.
16. Select **INTEGRAL** in **Offset MKR Type** using the data knob, and press the data knob (or **ENTR**) to register the parameter.
17. Enter **1, ,, 9, 8** and **MHz** using the numeric keys in **Offset Freq**.
18. Enter **1, ,, 2, 2, 8, 8** and **MHz** using the numeric keys in **Band Width**.
19. Enter **6, 0** and **-dBm** using the numeric keys in **Limit**.

2.3 ACP Measurement on the Base Station (BTS)

20. Enter **3, ,, 1, ,, 2, 5** and **MHz** using the numeric keys in *Offset Freq.*
21. Enter **1, ,, 2, 2, 8, 8** and **MHz** using the numeric keys in *Band Width.*
22. Enter **6, 0** and **-dBm** using the numeric keys in *Limit.*
23. Press **RETURN** to exit from the editor.

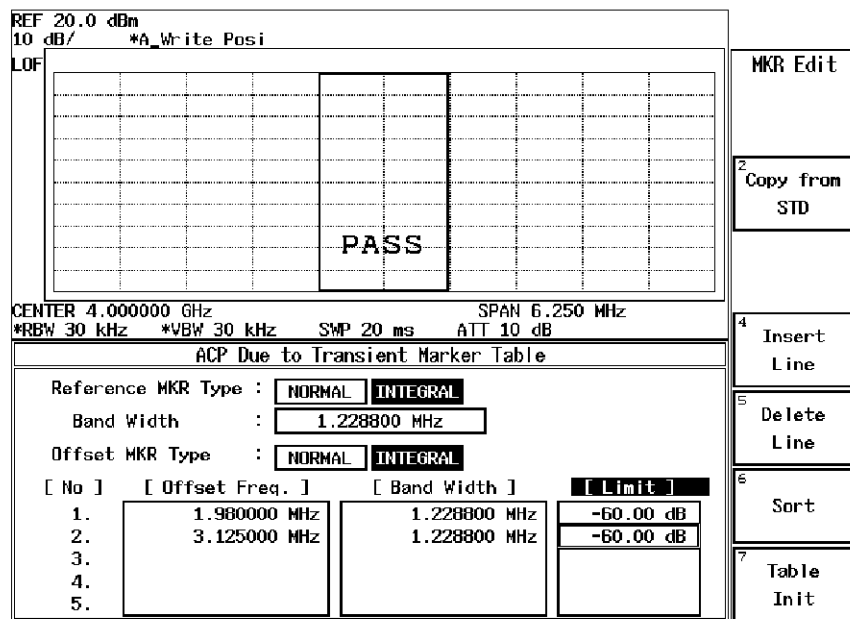

Figure 2-26 Marker Edit Setting

24. Press **Config** and **Parameter Setup** to open the Parameter Setup window.
25. Select **SPAN** in **Freq. Settings** using the data knob, and press the data knob (or **ENTR**) to register the parameter.
26. Select **SAMPLE** in **Detector** using the data knob, and press the data knob (or **ENTR**) to register the parameter.
27. Set the unit so that the result can be displayed in dBc.  
Select **RELATIVE** in **Result** using the data knob, and press the data knob (or **ENTR**) to register the parameter.
28. Set the base value to the Ref MKR to calculate the result in dBc.  
Select **REF MARKER** in **Ref Power** using the data knob, and press the data knob (or **ENTR**) to register the parameter.
29. Select **OFF** in **Judgment** using the data knob, and press the data knob (or **ENTR**) to register the parameter.

30. Press **RETURN** to exit the Parameter Setup menu.

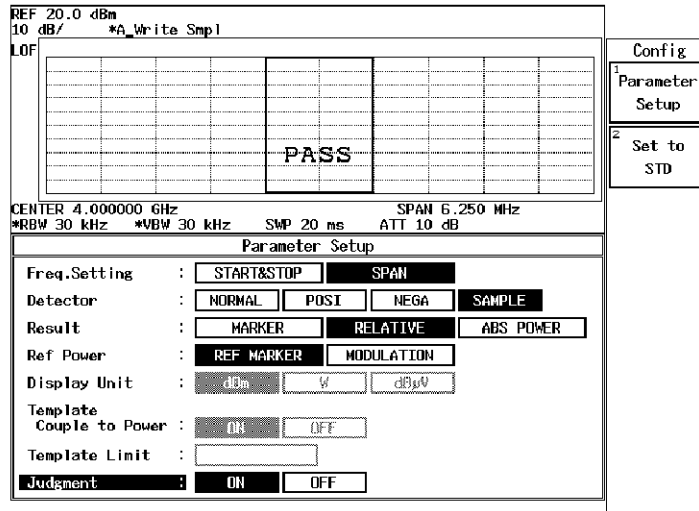

Figure 2-27 Parameter Setup Setting for the ACP Measurement

31. As the signal power is 0 dBm, the reference level is set to 0 dBm. Press **LEVEL**, **0** and **+dBm**.
32. The frequency span is set to 8 MHz. Press **SPAN**, **8** and **MHz**.
33. Press **FREQ**, **5** and **ENTR** to assign the channel to 5.
34. Press **RETURN** to change the soft menu to the measurement menu.
35. Press **SINGLE** or **REPEAT** to start the measurement.

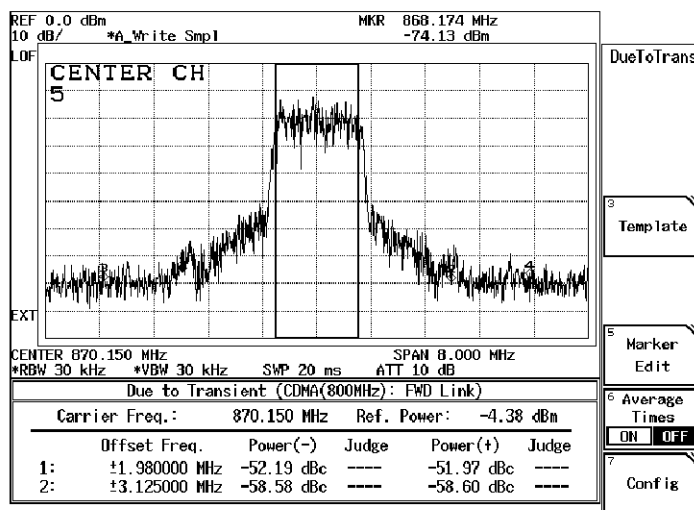

Figure 2-28 Measurement Results





### 3 REFERENCE

This chapter describes the functions of the panel and soft keys for option 61 software.

#### 3.1 Menu Index

This menu index is used to easily find the keys described in Chapter 3.

Auto Level Set .....	3-6, 3-7, 3-8, 3-15, 3-16, 3-17, 3-21, 3-24, 3-26, 3-42, 3-45, 3-49	Delay Time .....	3-6, 3-7, 3-8, 3-9, 3-12, 3-22, 3-25, 3-27, 3-30, 3-35
Average Times ON/OFF.....	3-6, 3-7, 3-8, 3-9, 3-10, 3-11, 3-12, 3-13, 3-14, 3-15, 3-16, 3-17, 3-23, 3-25, 3-27, 3-31, 3-32, 3-33, 3-37, 3-39, 3-41, 3-44, 3-48, 3-50	Delete .....	3-14
Baseband Input.....	3-18, 3-52	Delete Line.....	3-6, 3-8, 3-11, 3-12, 3-13, 3-23, 3-27, 3-33, 3-36, 3-37, 3-39, 3-41
Channel Setting .....	3-5	Detector.....	3-6, 3-7, 3-8, 3-9, 3-10, 3-11, 3-12, 3-13, 3-14, 3-23, 3-25, 3-27, 3-30, 3-31, 3-32, 3-33, 3-36, 3-37, 3-39, 3-41
Code Domain Power .....	3-5	Display .....	3-16, 3-45
Config .....	3-6, 3-7, 3-8, 3-9, 3-10, 3-11, 3-12, 3-13, 3-14, 3-23, 3-25, 3-27, 3-31, 3-32, 3-33, 3-37, 3-39, 3-41	Display Start .....	3-15, 3-42
Constellation .....	3-15	Display Unit .....	3-6, 3-7, 3-8, 3-9, 3-11, 3-12, 3-13, 3-14, 3-23, 3-25, 3-28, 3-31, 3-34, 3-38, 3-40, 3-41
Constellation(Dot).....	3-15	Due to Modulation .....	3-5
Constellation(Line & Dot) .....	3-15	Due to Transient.....	3-5
Constellation(Line) .....	3-15	E.V.M. vs Chip .....	3-15
Cont Auto Level Set.....	3-18, 3-52	Equalizing Filter .....	3-15, 3-16, 3-43, 3-46
Copy from STD.....	3-6, 3-11, 3-12, 3-13, 3-22, 3-33, 3-36, 3-37, 3-38, 3-39	EXT Gate .....	3-9, 3-12, 3-30, 3-36
DC CAL.....	3-5	EXT Trigger Delay .....	3-15, 3-16, 3-17, 3-44,

3.1 Menu Index

EXT Trigger Slope.....	3-15, 3-16, 3-17, 3-44, 3-47	Mag Error vs Chip.....	3-31, 3-32
F-Domain .....	3-5	Margin ΔX ON/OFF.....	3-11, 3-12, 3-13, 3-32, 3-36, 3-38
Format .....	3-16, 3-45	Marker Edit.....	3-11, 3-12, 3-13, 3-33, 3-37, 3-39
Freq Meas Range .....	3-15, 3-16, 3-44, 3-48	Marker Setup .....	3-16, 3-48
Freq. Setting.....	3-11, 3-12, 3-13, 3-33, 3-37, 3-39	Meas Filter.....	3-17, 3-49
Frequency Input .....	3-18, 3-52	Meas Mode .....	3-15, 3-16, 3-43, 3-46
Gate Position.....	3-9, 3-12, 3-30, 3-36	Meas Range .....	3-15, 3-16, 3-43, 3-46
Gate Setup.....	3-9, 3-12, 3-29, 3-30, 3-35, 3-36	Modulation .....	3-5
Gate Source.....	3-9, 3-12, 3-30, 3-35	Multiplier.....	3-8, 3-28
Gate Width .....	3-9, 3-12, 3-30, 3-36	Null Offset Constellation.....	3-15
Gated Sweep .....	3-9, 3-31	Null Offset Constellation(Dot).....	3-15
Gated Sweep ON/OFF.....	3-9, 3-12, 3-30, 3-36	Null Offset Constellation(Line & Dot) ...	3-15
Graphics .....	3-15, 3-42	Null Offset Constellation(Line).....	3-15
I EYE Diagram .....	3-15	Null Offset I EYE Diagram.....	3-15
I/Q EYE Diagram .....	3-15	Null Offset I/Q EYE Diagram.....	3-15
Inband Spurious .....	3-5	Null Offset Q EYE Diagram .....	3-15
Input .....	3-18, 3-52	OBW.....	3-5
Insert .....	3-14, 3-36	OBW% .....	3-10, 3-32
Insert Line.....	3-6, 3-8, 3-11, 3-12, 3-13, 3-23, 3-27, 3-33, 3-36, 3-37, 3-39, 3-41	OFF Position.....	3-7, 3-25
IQ Inverse .....	3-18, 3-52	OFF Width.....	3-7, 3-25
Judgment.....	3-6, 3-7, 3-8, 3-9, 3-10, 3-11, 3-12, 3-13, 3-14, 3-24, 3-26, 3-28, 3-31, 3-32, 3-34, 3-38, 3-40, 3-41	Offset Level.....	3-18, 3-51
Link.....	3-18, 3-51	ON Position .....	3-7, 3-25
Load Table .....	3-8, 3-14, 3-27, 3-40	ON Width .....	3-7, 3-25
Lower Limit .....	3-6, 3-9, 3-10, 3-24,	ON/OFF Ratio .....	3-5
		Outband Spurious .....	3-5
		Paging Ch .....	3-16
		Parameter Setup.....	3-6, 3-7, 3-8, 3-9, 3-10, 3-11, 3-12, 3-13, 3-14, 3-15, 3-16, 3-17, 3-23, 3-25, 3-27, 3-31, 3-32, 3-33, 3-37, 3-39, 3-41, 3-43, 3-46, 3-49
		Peak MKR Y Delta.....	3-8, 3-13, 3-14, 3-28, 3-39, 3-41
		Phase Error vs Chip.....	3-15
		Phase Unit.....	3-16, 3-47
		PN Offset.....	3-15, 3-16,

PN Offset Search Mode .....	3-15, 3-16, 3-43, 3-47	$\tau$ .....	3-16, 3-43, 3-46
Power .....	3-5	$\tau$ Offset .....	3-16, 3-43, 3-46
Power Unit .....	3-16, 3-47	Table Edit .....	3-8, 3-14, 3-27, 3-40
Preselector .....	3-8, 3-14, 3-28, 3-41	Table Init .....	3-6, 3-8, 3-11, 3-12, 3-13, 3-14, 3-23, 3-27, 3-33, 3-37, 3-39, 3-41
Q EYE Diagram .....	3-15	Table No. 1/2/3 .....	3-8, 3-14, 3-27, 3-40
Rate .....	3-18, 3-51	T-Domain .....	3-5, 3-21
Ref Power .....	3-11, 3-12, 3-13, 3-34, 3-38, 3-40	Template .....	3-6, 3-11, 3-12, 3-13, 3-22, 3-32, 3-36, 3-38
Result .....	3-8, 3-11, 3-12, 3-13, 3-27, 3-34, 3-37, 3-39	Template Couple to Power .....	3-6, 3-11, 3-12, 3-13, 3-23, 3-34, 3-38, 3-40
Save Table .....	3-8, 3-14, 3-27, 3-41	Template Edit .....	3-6, 3-11, 3-12, 3-13, 3-22, 3-32, 3-36, 3-38
Scale Setup .....	3-16, 3-45	Template Limit .....	3-6, 3-11, 3-12, 3-13, 3-23, 3-34, 3-38, 3-40
Select Type .....	3-15, 3-42	Template ON/OFF .....	3-6, 3-11, 3-12, 3-13, 3-22, 3-32, 3-36, 3-38
Set to Default .....	3-8, 3-14, 3-28, 3-41	Template UP/LOW .....	3-6, 3-22
Set to STD .....	3-6, 3-7, 3-9, 3-10, 3-11, 3-12, 3-13, 3-22, 3-24, 3-25, 3-26, 3-30, 3-31, 3-32, 3-34, 3-36, 3-38, 3-40	Threshold .....	3-16, 3-46
Shift X .....	3-6, 3-11, 3-12, 3-13, 3-22, 3-32, 3-36, 3-38	Traffic Ch .....	3-16
Shift Y .....	3-6, 3-11, 3-12, 3-13, 3-22, 3-32, 3-36, 3-38	Trigger .....	3-9, 3-12, 3-30, 3-35
Slope .....	3-6, 3-7, 3-8, 3-9, 3-12, 3-21, 3-24, 3-26, 3-29, 3-35	Trigger Delay .....	3-49
Sort .....	3-6, 3-11, 3-12, 3-13, 3-23, 3-33, 3-37, 3-39	Trigger Level .....	3-6, 3-7, 3-9, 3-12, 3-22, 3-24, 3-29, 3-35
Spurious .....	3-5	Trigger Position .....	3-6, 3-7, 3-8, 3-9, 3-12, 3-22, 3-25, 3-27, 3-29, 3-35
STD .....	3-5	Trigger Setup .....	3-6, 3-7,
STD Setup .....	3-5		

3.1 Menu Index

	3-8, 3-9, 3-12, 3-21, 3-24, 3-26, 3-29, 3-35
Trigger Slope .....	3-49
Trigger Source .....	3-6, 3-7, 3-8, 3-9, 3-12, 3-15, 3-16, 3-17, 3-21, 3-24, 3-26, 3-29, 3-35, 3-44, 3-47, 3-49
Tx Power.....	3-5
Type .....	3-18, 3-51
Upper Limit.....	3-6, 3-7, 3-9, 3-10, 3-24, 3-26, 3-31, 3-32
Waveform Quality .....	3-5
Window ON/OFF .....	3-6, 3-7, 3-9, 3-22, 3-25, 3-30
Window Position.....	3-6, 3-9, 3-22, 3-30
Window Setup.....	3-6, 3-7, 3-9, 3-22, 3-25, 3-30
Window Width.....	3-6, 3-9, 3-22, 3-31
Y.....	3-25
Y Scale .....	3-16, 3-45
Y Scale [dB/div] 10/5/2 .....	3-6, 3-7, 3-9, 3-23, 3-25, 3-31
Y/div .....	3-16, 3-45

### 3.2 Menu Map

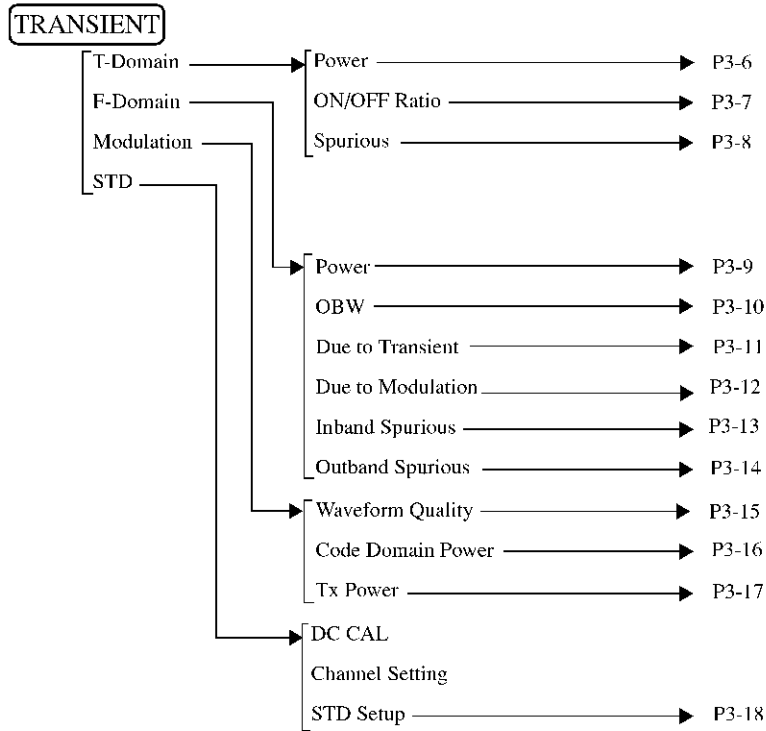

3.2 Menu Map

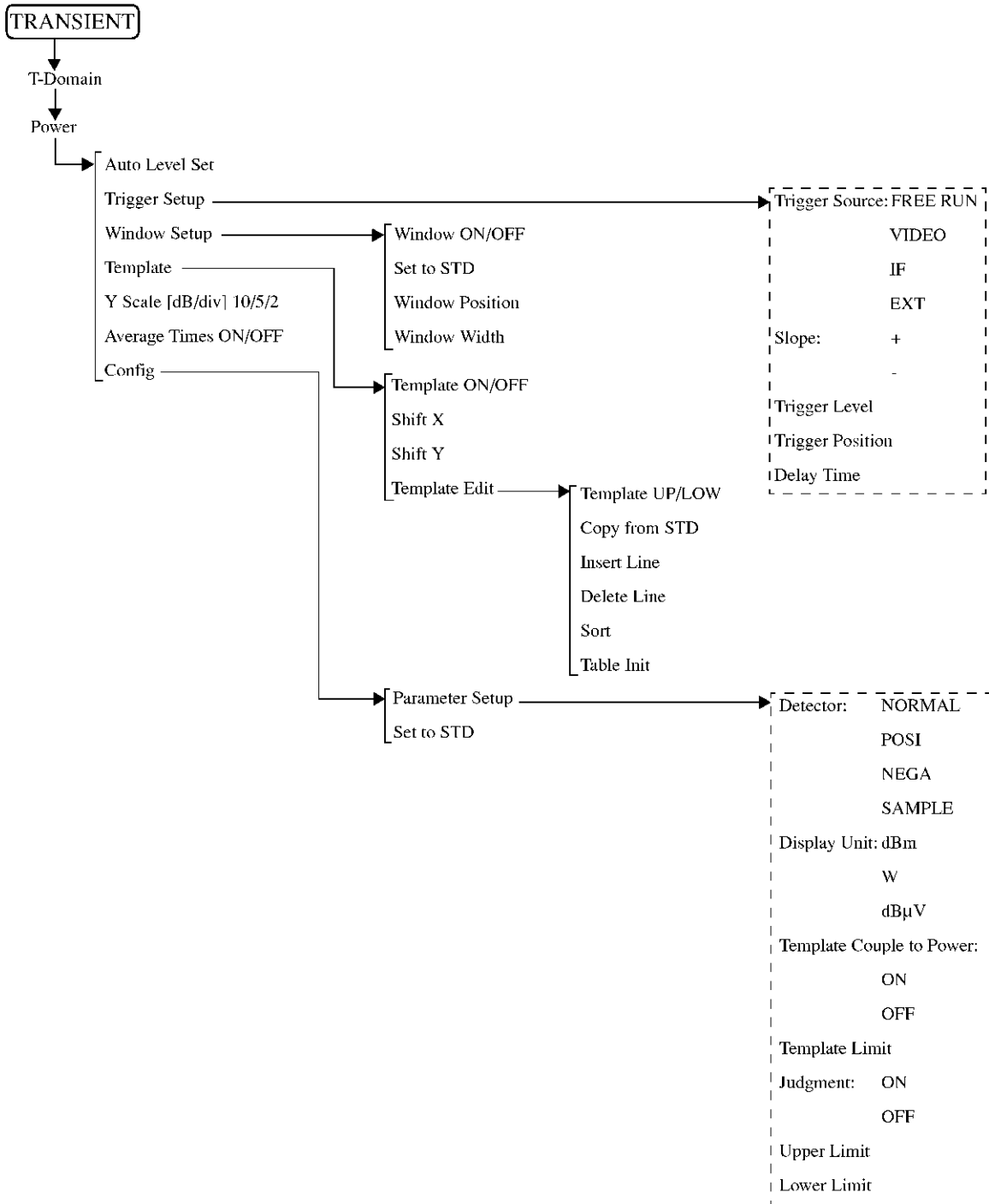

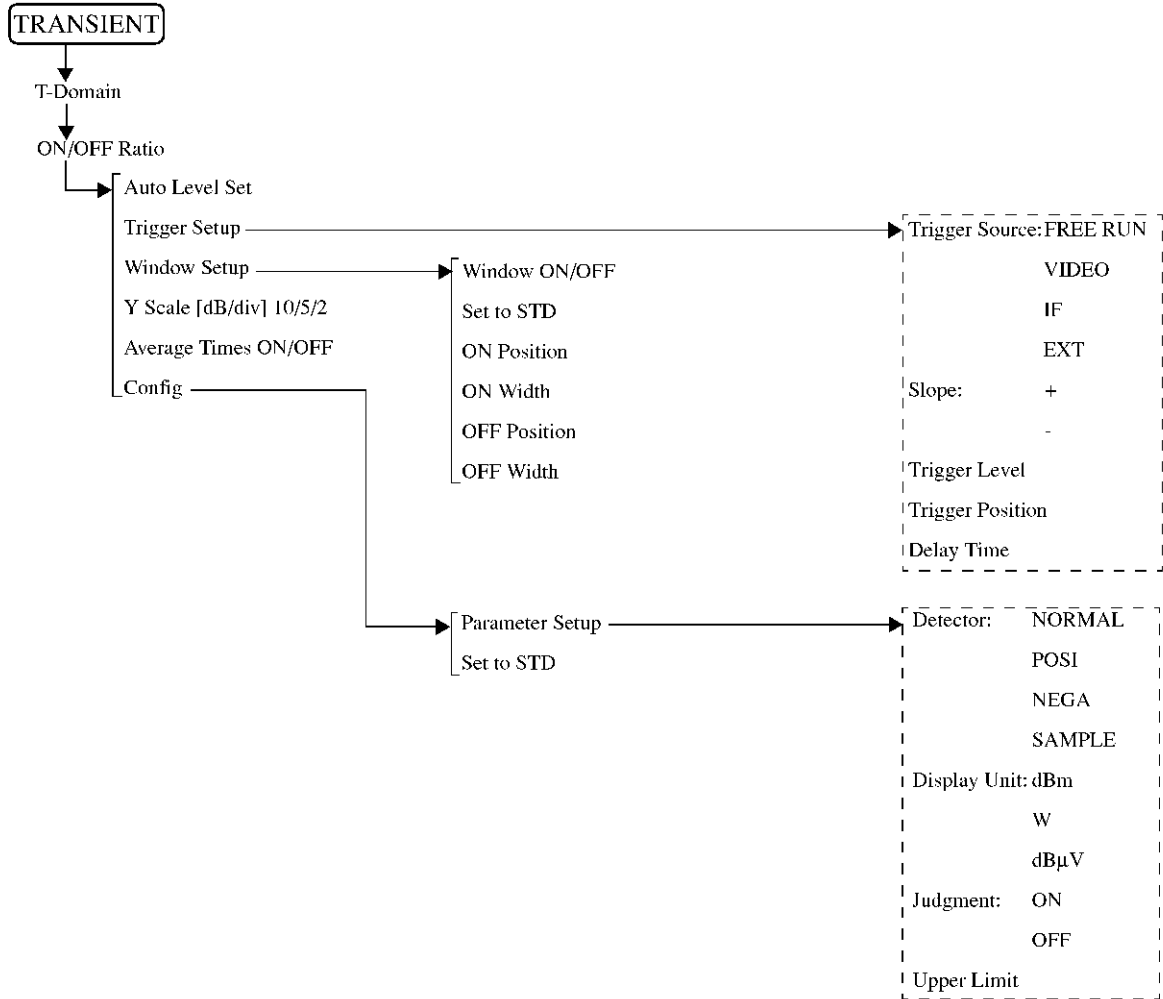

3.2 Menu Map





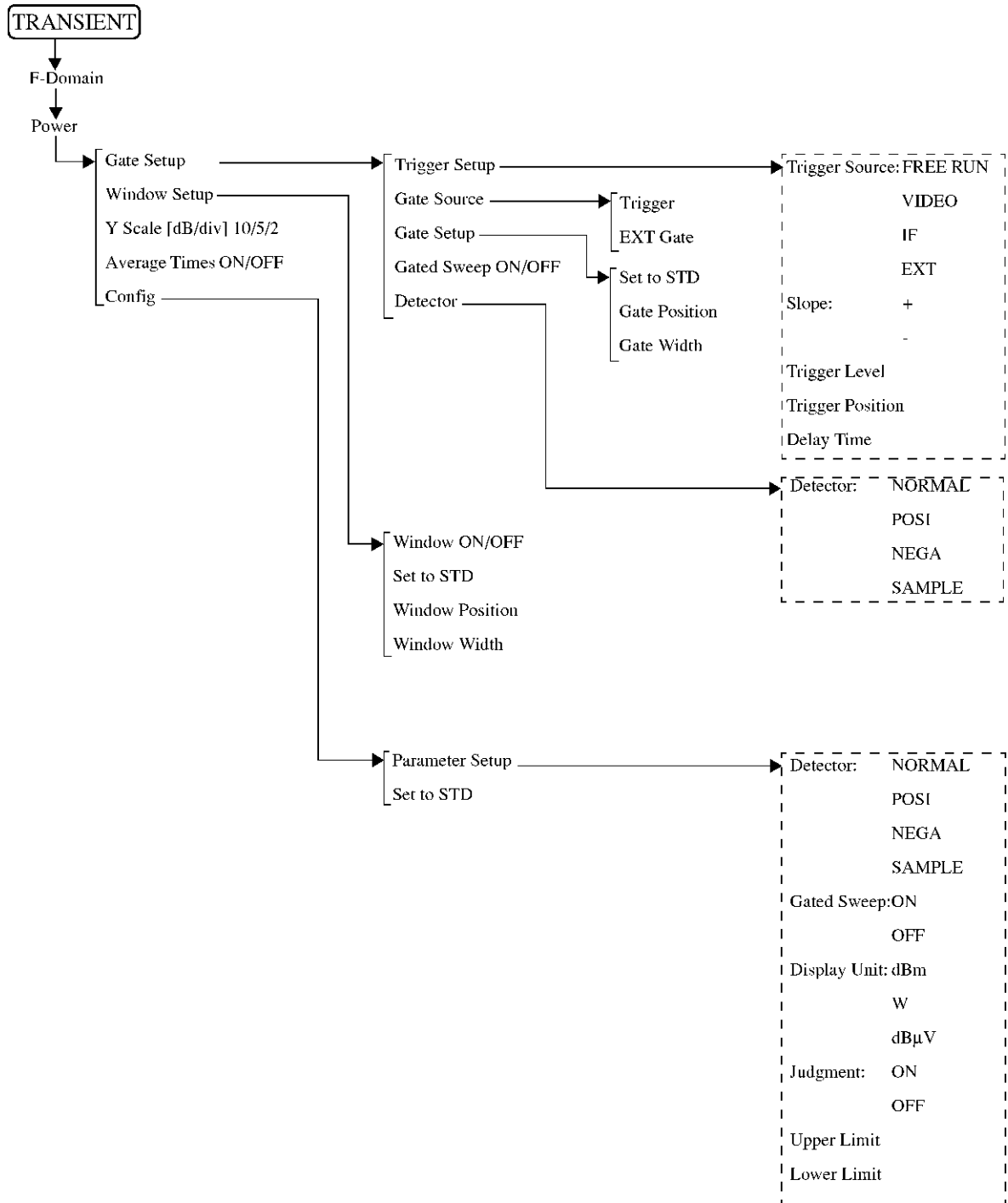

3.2 Menu Map

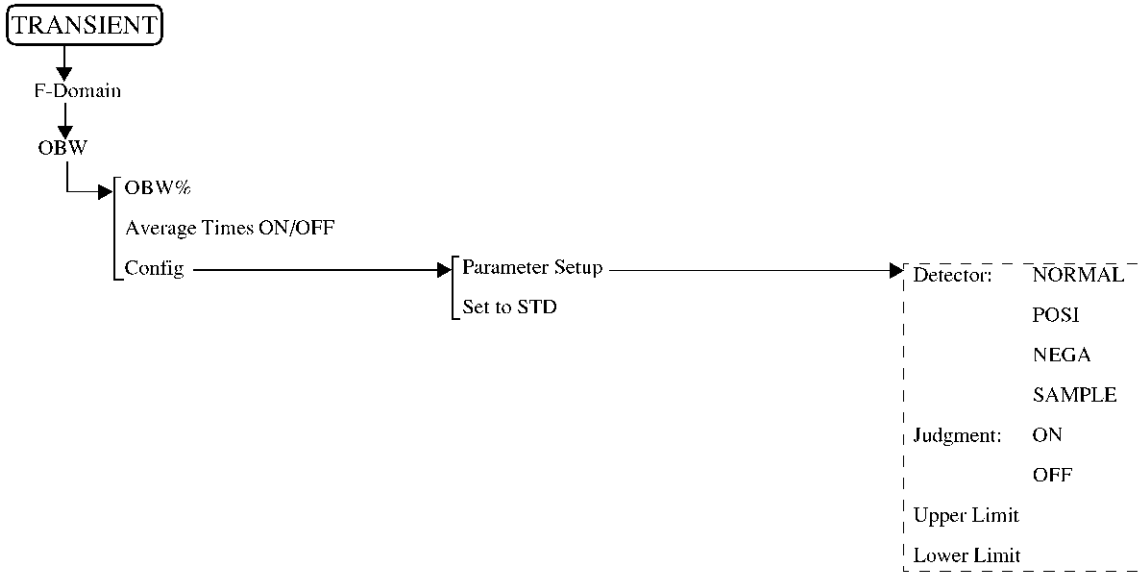

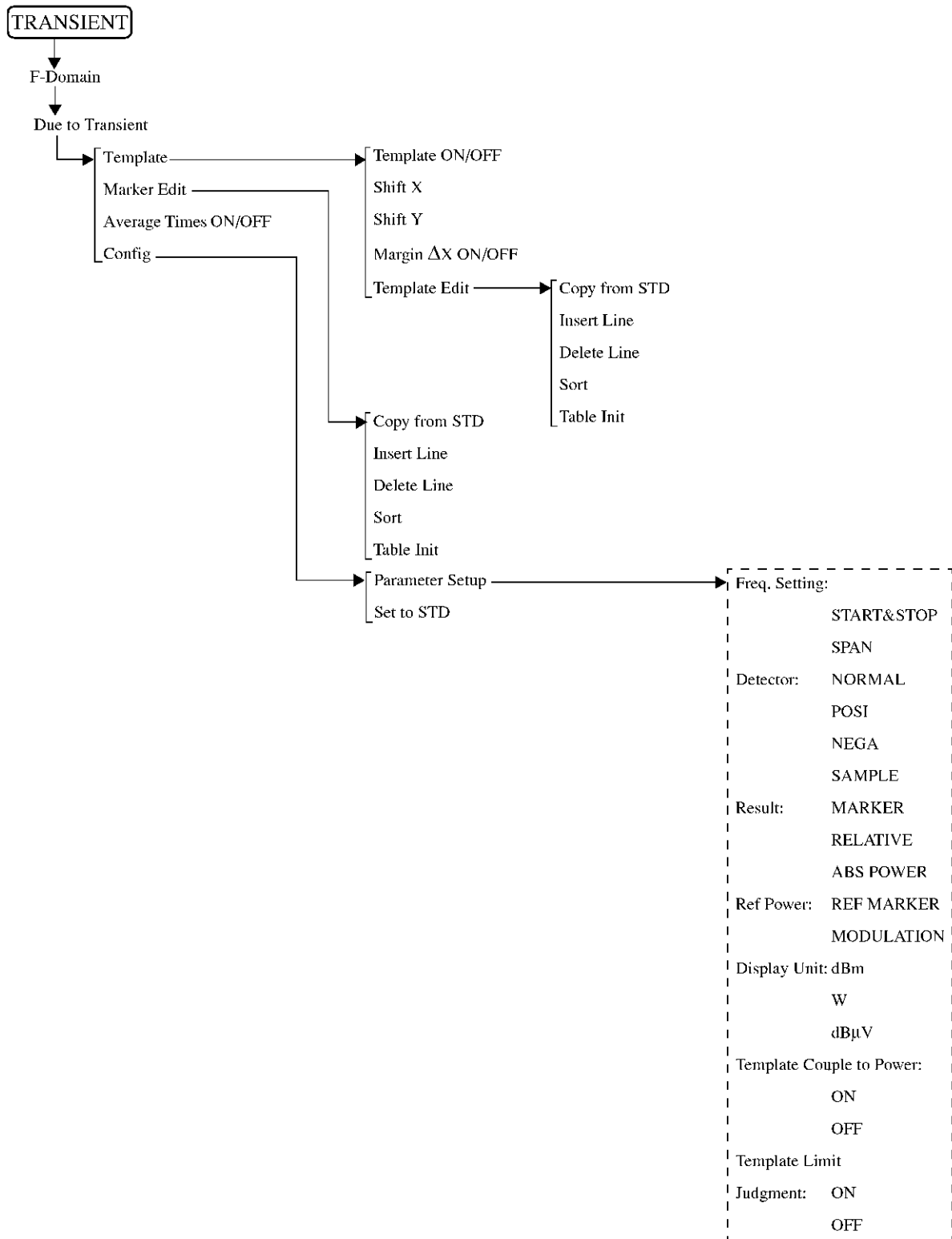

3.2 Menu Map

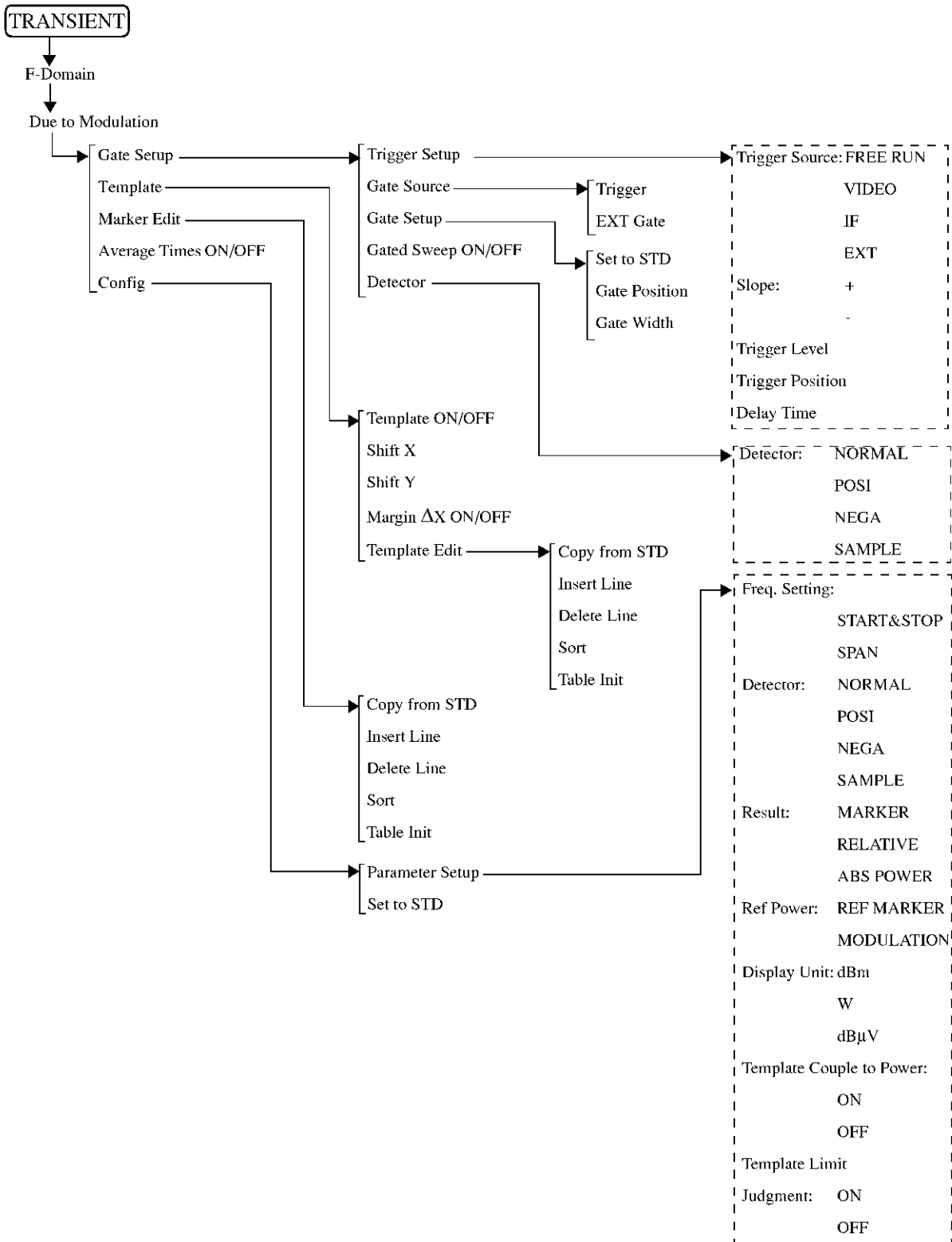

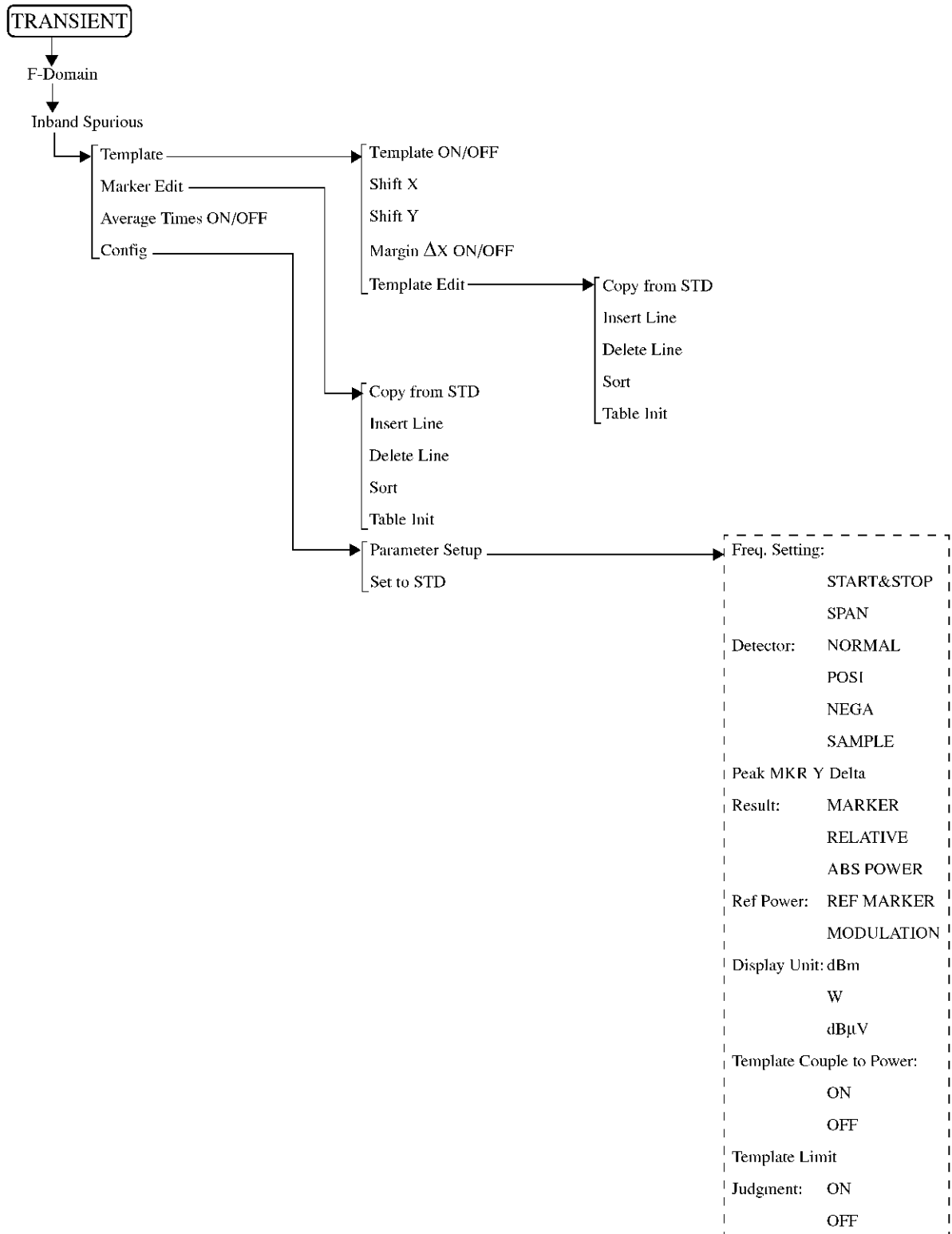

3.2 Menu Map

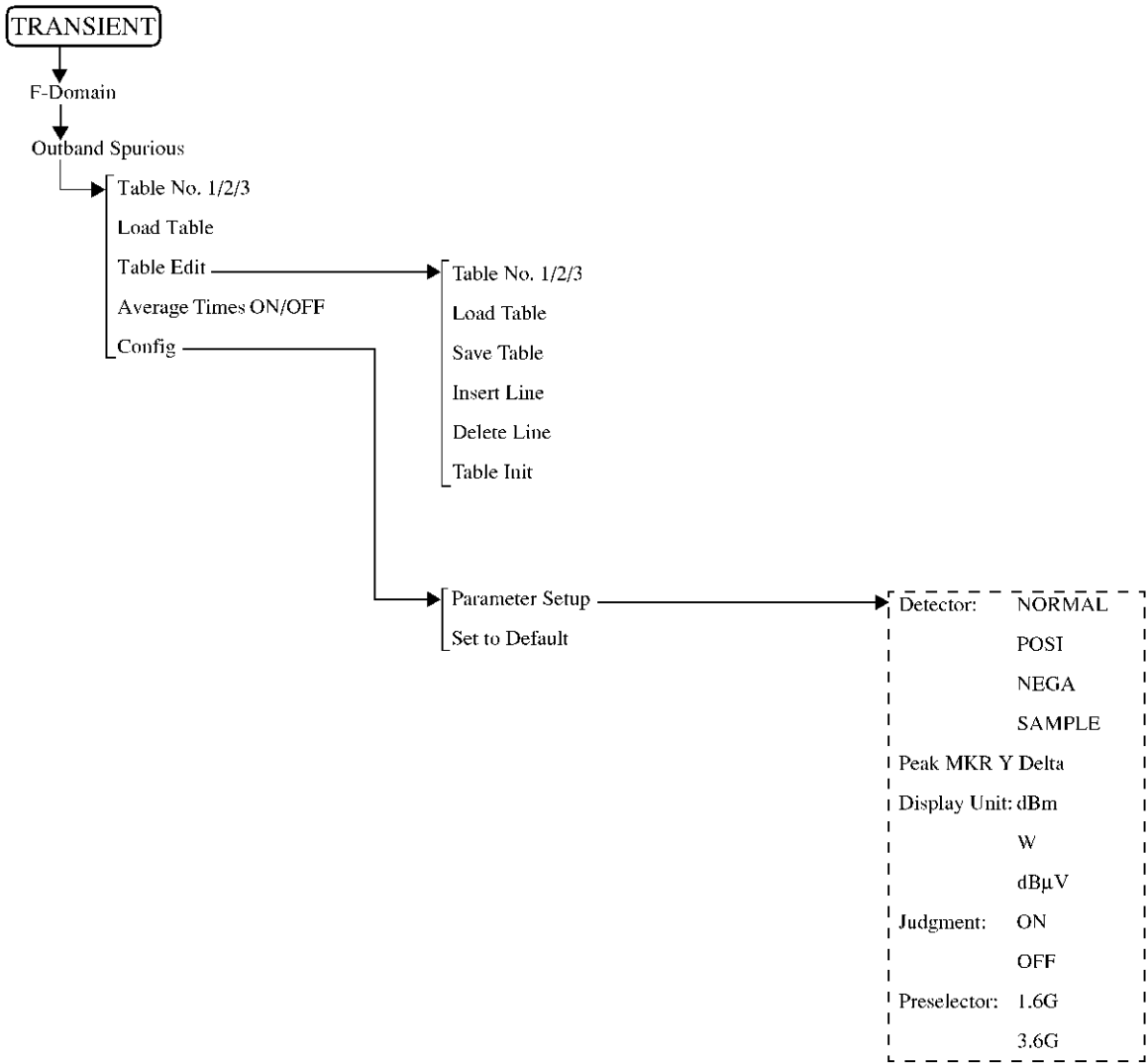

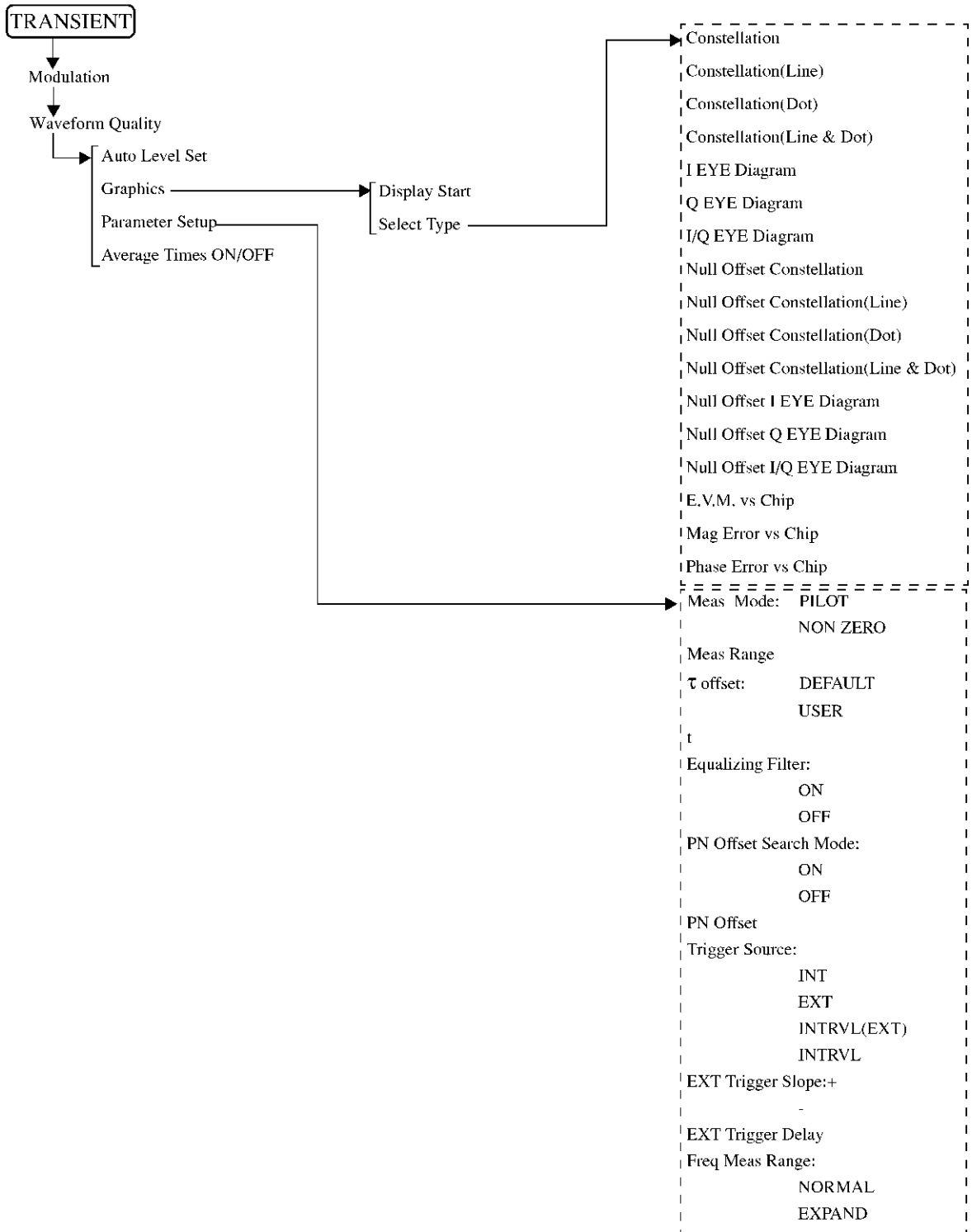

3.2 Menu Map

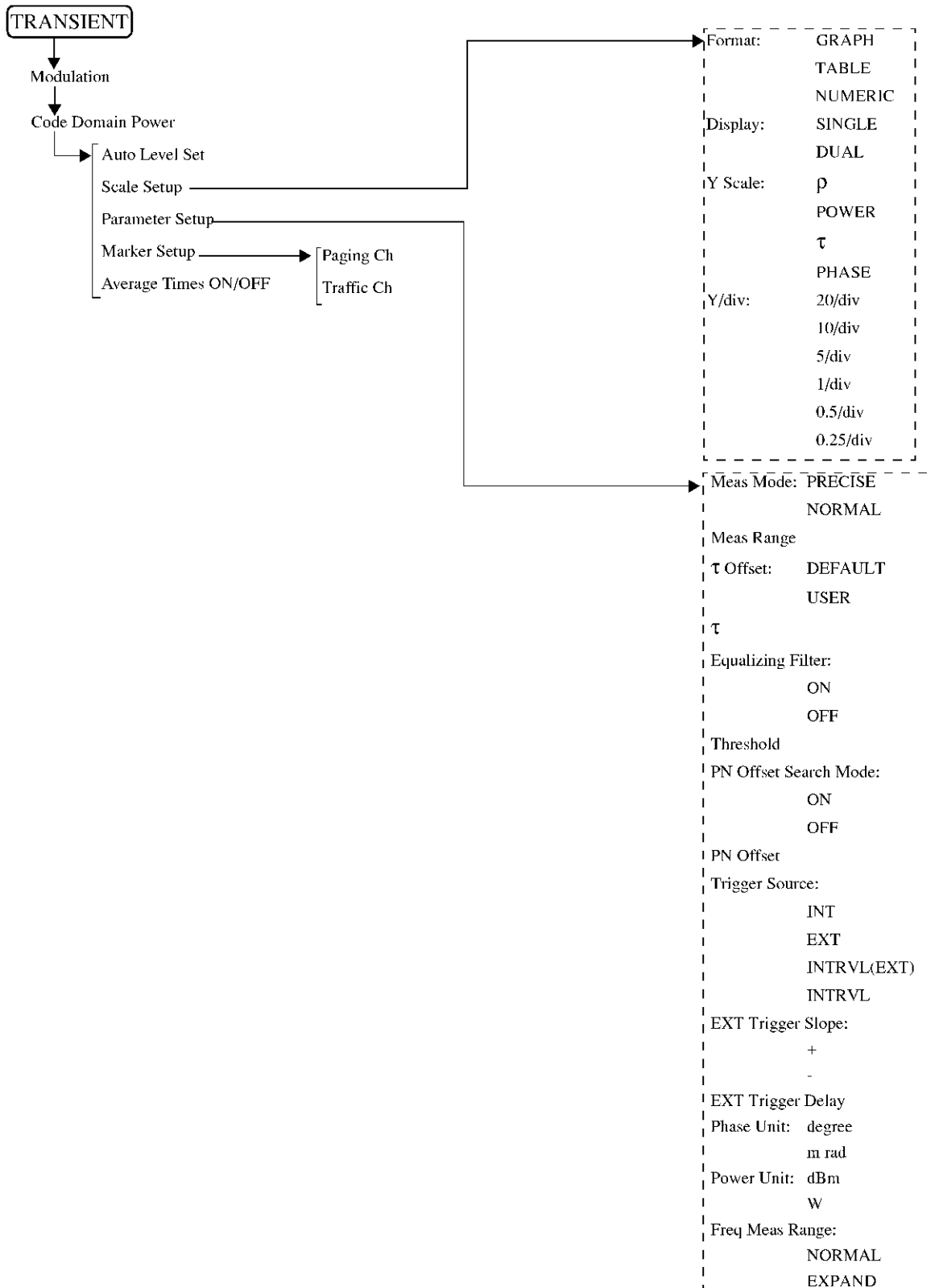



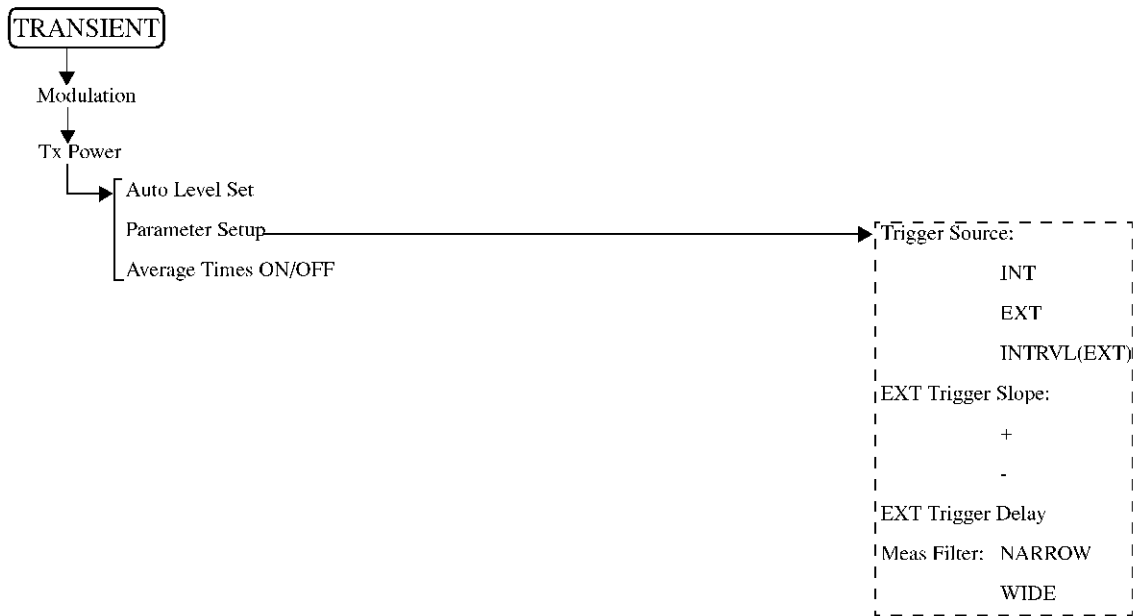

3.2 Menu Map

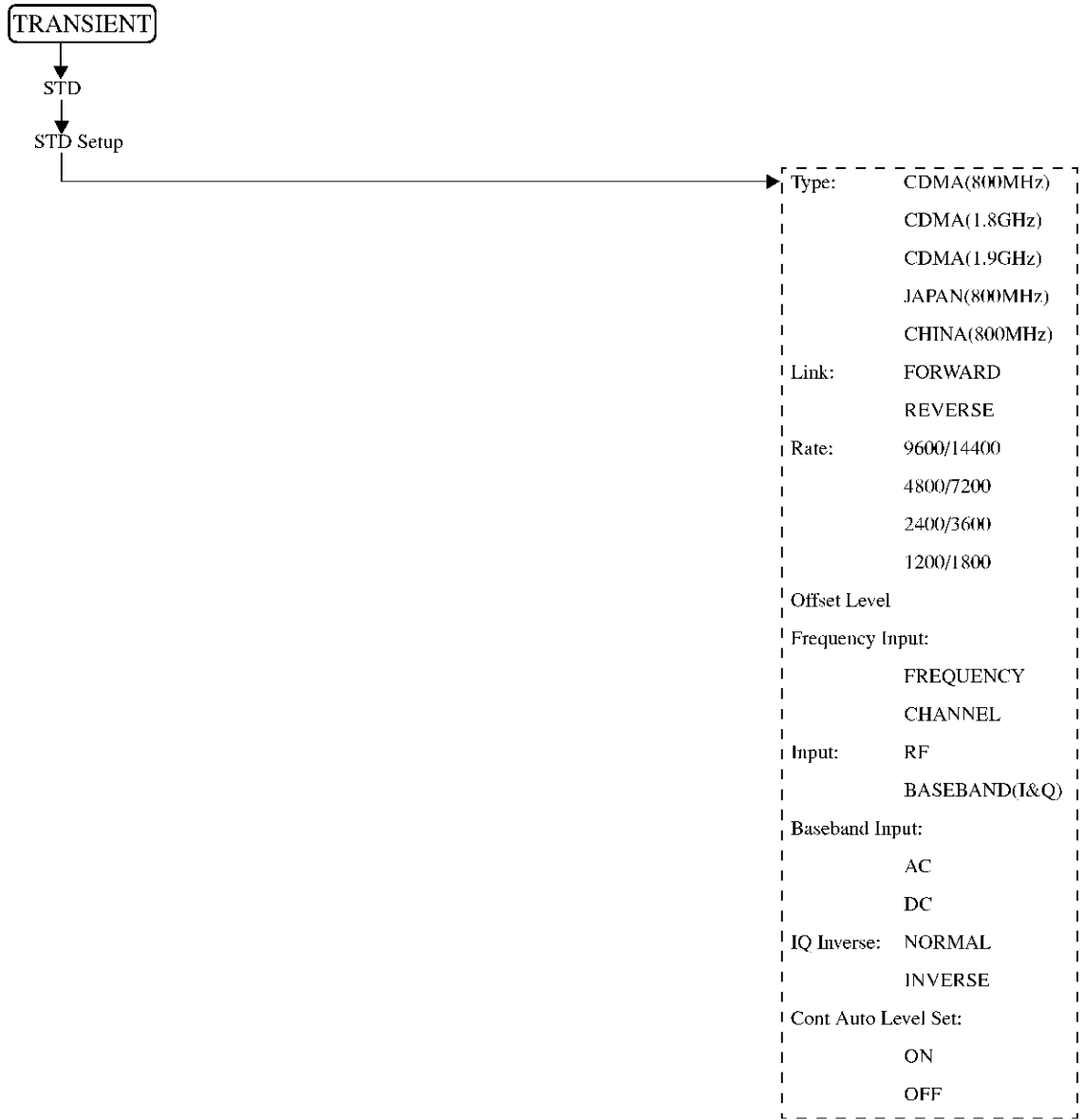

### 3.3 Function Description

When modulation analysis hardware and software are installed, the following menus are assigned to the **TRANSIENT** key.

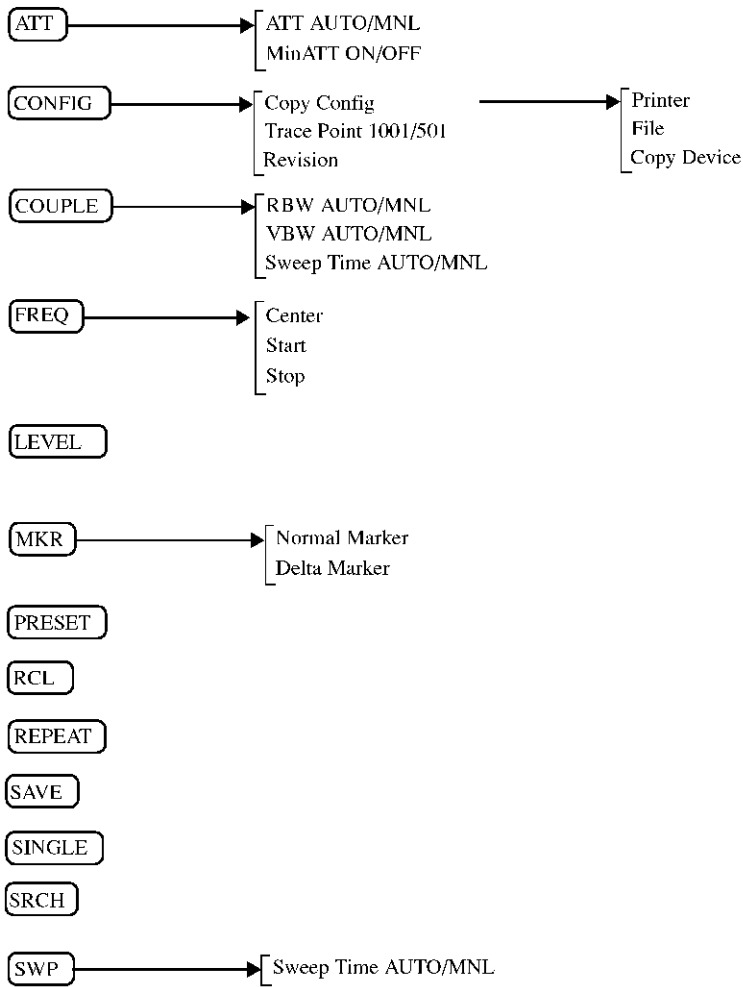

### 3.3 Function Description

#### 3.3.1 SWITCHING BETWEEN COMMUNICATION SYSTEMS

This section describes how to switch the communication systems. The analyzer must be set to the SPA mode to switch between the communication systems.

1. Press the **POWER** key to enter the SPA mode.
2. Press **CONFIG**.
3. Press *more 1/2*.  
If there are other communication systems installed, with which this instrument can communicate, "Comm.System" is displayed in the soft menu. Press **Comm.System**.  
Select the communication system you wish using the data knob, and press the knob (or **ENTR**).

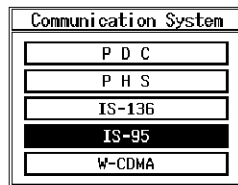

**Figure 3-1 Dialog Box Used for the Communication Systems**

4. When the data knob (or **ENTR**) is pressed, the message "LOADING" is displayed. After the message disappears, the switchover to another system is complete.
5. Press the **TRANSIENT** key to confirm that the menu has been changed.

---

**NOTE:** *After the communication system has been switched, the parameters previously set for the former communication system will be cleared.*

---

If necessary, save the old parameters, before switching the communication system to another.

1. To save the parameters, press **SHIFT** and **RCL**.
2. Set the SAVE FILE number and press **Save**.

### 3.3.2 T-Domain

Carries out a measurement according to the standard using the zero span of the spectrum analyzer. Measurement items include power, ON/OFF ratio of a burst signal, and spurious measurements in the time domain with a specified frequency.

In the T-Domain measurement, the setting for the RBW, VBW, Sweep Time, or Detector is saved when exiting from each measurement and recalled when entering each measurement again. To return the setting to the value specified by the standard, press *Config* and *Set to STD*.

#### 3.3.2.1 Power (T-Domain)

This is a function to measure power in the time domain (zero span).

There are two Pass/Fail judgment functions: a judgment function for the template and a judgment function for power.

---

**NOTE:** The RBW must be set wider than the modulation band.

---

#### *Auto Level Set*

Used to set the internal reference level to an optimum value in accordance with the measurement signal. The reference level is automatically adjusted when this key is pressed.

---

**NOTE:** The input signal level must be constant while *Auto Level Set* is being carried out.

---

#### *Trigger Setup*

Used to set a trigger.

Trigger Setup	
Trigger Source :	<input type="radio"/> FREE RUN <input checked="" type="radio"/> VIDEO <input type="radio"/> IF <input type="radio"/> EXT
Slope :	<input checked="" type="radio"/> + <input type="radio"/> -
Trigger Level :	<input type="text" value="30 %"/>
Trigger Position :	<input type="text" value="8 %"/>
Delay Time :	<input type="text" value="0.000 ns"/>

**Figure 3-2 Trigger Setup Dialog Box**

#### *Trigger Source*

Used to select a trigger.

- FREE RUN:** Used to capture the signal using internal timing.
- VIDEO:** Used to trigger the signal using the video signal.
- IF:** Used to trigger the signal using the IF signal (approximately 6 MHz band).
- EXT:** Used to trigger the signal using the external signal, which is input from the EXT TRIG terminal on the rear panel.

#### *Slope*

Used to select the edge when triggering.

3.3 Function Description

+: Used to trigger at the leading edge.

-: Used to trigger at the trailing edge.

**Trigger Level** Used to set the level to trigger.

**Trigger Position** Used to set the trigger position where it is displayed on the screen.

**Delay Time** Used to set a delay time from the time a trigger signal is detected to the time the signal is captured.

---

*NOTE: When Delay Time is a negative value, signals before the trigger can be captured.*

---

**Window Setup** Used to set the window used for power measurement.

**Window ON/OFF** Used to display a window showing the range for power measurement. When OFF is set, the power measurement range covers all points on the display screen.

**Set to STD** Used to set the window specified by the communication standard.

**Window Position** Used to set the position of the window.

**Window Width** Used to set the width of the window.

---

*NOTE: When the window is partially outside the display, an arrow is shown next to Posi, Width or both in the area indicating the window conditions.*

---

**Template** Used to set the template.

**Template ON/OFF** Used to set whether to display the template or to toggle the Pass/Fail judgment function on or off.

**Shift X** Used to set the amount of template movement in the X-axis direction.

**Shift Y** Used to set the amount of template movement in the Y-axis direction.

**Template Edit** Edits the template.

**Template UP/LOW** Used to select the upper template or the lower template.

**Copy from STD** Used to copy the template specified by the communication standard.

<b><i>Insert Line</i></b>	Used to insert a line.
<b><i>Delete Line</i></b>	Used to delete a line.
<b><i>Sort</i></b>	Used to sort template data in ascending order.
<b><i>Table Init</i></b>	Used to initialize the table.
<b><i>Y Scale [dB/div] 10/5/2</i></b>	Switches the display screen scale to 10, 5 or 2 dB/div.
<b><i>Average Times ON/OFF</i></b>	Used to set the averaging count. Used to perform averaging of both display screen and power at the same time. (This is because a large error results when calculating power from the averaged display screen, since the display screen is logarithmically compressed.)

**Config*****Parameter Setup***

Used to set the method of measurement, edits the template, and so forth.

Parameter Setup				
<b>Detector</b>	: <input type="radio"/> NORMAL	<input type="radio"/> POSI	<input type="radio"/> NEGA	<input checked="" type="radio"/> SAMPLE
Display Unit	: <input type="radio"/> dBm	<input type="radio"/> W	<input type="radio"/> dBμV	
Template				
Couple to Power	: <input type="radio"/> ON	<input checked="" type="radio"/> OFF		
Template Limit	: <input type="text" value="-200.00 dBm"/>			
Judgment	: <input checked="" type="radio"/> ON	<input type="radio"/> OFF		
Upper Limit	: <input type="text" value="100.00 dBm"/>			
Lower Limit	: <input type="text" value="-200.00 dBm"/>			

**Figure 3-3 Parameter Setup Dialog Box**

<b><i>Detector</i></b>	NORMAL/POSI/NEGA/SAMPLE Used to set the detector.
<b><i>Display Unit</i></b>	dBm/W/dBμV Used to set the display unit of power.
<b><i>Template Couple to Power</i></b>	Used to display the template that is connected to the measured power.  ON: Used to display the template that is connected to the measured power. On the template edit screen, set the template level to the portion linked with the power value set to 0 dB.  OFF: Used to display the template regarding the Y-axis value edited by the template as an absolute value.
<b><i>Template Limit</i></b>	If the absolute value of the template is smaller than the this value when Template Couple to Power is set to ON, clip the template at this value.

### 3.3 Function Description

**Judgment** Used to set ON/OFF for Pass/Fail judgments.

**Upper Limit** Used to enter the upper limit value of power.

**Lower Limit** Used to enter the lower limit value of power.

**Set to STD** Used to return measurement parameters to the values specified by the communication standard.

#### 3.3.2.2 ON/OFF Ratio

Calculates the power while the burst signal is on and off, then displays the ratio of power.

**Auto Level Set** Used to set the internal reference level to an optimum value in accordance with the measurement signal. The reference level is automatically adjusted when this key is pressed.

---

**NOTE:** The signal level must remain constant while Auto Level Set is being carried out.

---

**Trigger Setup** Used to set a trigger.

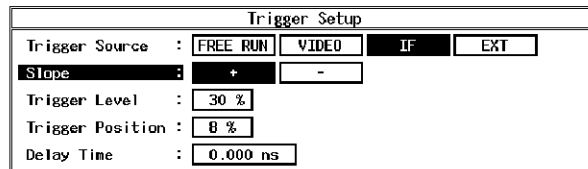

**Figure 3-4 Trigger Setup Dialog Box**

**Trigger Source** Used to select a trigger

**FREE RUN:** Used to capture the signal using internal timing.

**VIDEO:** Used to trigger the signal using the video signal.

**IF:** Used to trigger the signal using the IF signal (approximately 6 MHz band).

**EXT:** Selected when triggering an external signal which is input from the EXT TRIG terminal on the rear panel.

**Slope** Used to select the edge when triggering.

**+:** Used to trigger at the leading edge.

**-:** Used to trigger at the trailing edge.

**Trigger Level** Used to set the level to trigger.



<i>Trigger Position</i>	Used to set where the trigger position is displayed on the screen.
<i>Delay Time</i>	Used to set a delay time from the time a trigger signal is detected to the time the signal is captured.
<hr/>	
<i>NOTE: When Delay Time is a negative value, signals before the trigger can be captured.</i>	
<hr/>	
<i>Window Setup</i>	Used to set the burst ON and OFF periods.
<i>Window ON/OFF</i>	Used to display a window showing the range for power measurement.
<i>Set to STD</i>	Used to set the value that is specified by or complies with the communication standard.
<i>ON Position</i>	Used to set the desired position when the burst is on.
<i>ON Width</i>	Used to set the desired width when the burst is on.
<i>OFF Position</i>	Used to set the position when the burst is off.
<i>OFF Width</i>	Used to set the width when the burst is off.

*NOTE: When the window is partially outside the display, an arrow is shown next to Posi, Width or both in the area indicating the window conditions.*

<i>Y Scale [dB/div] 10/5/2</i>	Switches the display screen scale to 10, 5 or 2 dB/div.
<i>Average Times ON/OFF</i>	Used to set the averaging count.
<i>Config</i>	
<i>Parameter Setup</i>	Used to set the measurement parameters.

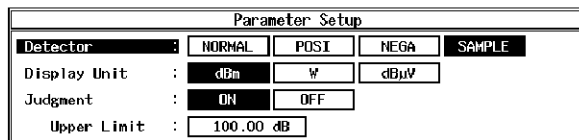

**Figure 3-5 Parameter Setup Dialog Box**

<i>Detector</i>	NORMAL/POSI/NEGA/SAMPLE Used to select the detector.
<i>Display Unit</i>	dBm/W/dBµV Used to set the display unit of power.

3.3 Function Description

---

*NOTE: The ON/OFF ratio is displayed in units of dB (fixed).*

---

**Judgment** Used to set ON/OFF of the Pass/Fail judgment for the ON/OFF ratio.

**Upper Limit** Enters the upper limit value.

**Set to STD** Used to set measurement parameters to the values specified by the communication standard.

**3.3.2.3 Spurious (T-Domain)**

Used to measure power (or peak power) according to the frequency specified in the table by sweeping in the zero span mode.

**Auto Level Set** Used to set the internal reference level to an optimum value in accordance with the measurement signal. The reference level is automatically adjusted when this key is pressed.

---

*NOTE: The signal level must be constant while Auto Level Set is being carried out.*

---

**Trigger Setup** Used to set a trigger.

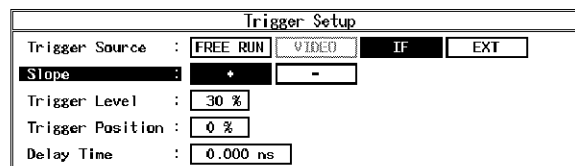

**Figure 3-6 Trigger Setup Dialog Box**

**Trigger Source** Used to select a trigger

FREE RUN: Used to capture the signal using internal timing.

IF: Triggers the signal using the IF signal (approximately 6 MHz band).

EXT: Selected when triggering with the external signal, which is input from the EXT TRIG terminal on the rear panel.

**Slope** Used to select the edge when triggering.

+: Used to trigger at the leading edge.

-: Used to trigger at the trailing edge.

<b>Trigger Position</b>	Used to set where the trigger position is displayed on the screen.
<b>Delay Time</b>	Used to set a delay time from the time a trigger signal is detected to the time the signal is captured.
<hr/> <i>NOTE: When Delay Time is a negative value, signals before the trigger can be captured.</i> <hr/>	
<b>Table No. 1/2/3</b>	Used to select the measurement table.
<b>Load Table</b>	Loads the measurement table.
<b>Table Edit</b>	Edits the measurement table.
<b>Table No. 1/2/3</b>	Used to select the table to be edited.
<b>Load Table</b>	Loads the measurement table.
<b>Save Table</b>	Saves the measurement table.
<b>Insert Line</b>	Used to insert additional frequency data before the selected frequency number.
<b>Delete Line</b>	Used to delete the selected line.
<b>Table Init</b>	Used to initialize the table
<b>Average Times ON/OFF</b>	Used to set the averaging count. Max Hold is set when the detector is set to Posi.
<b>Config</b>	
<b>Parameter Setup</b>	Used to set measurement conditions.

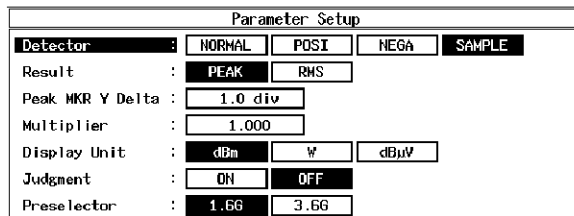

Figure 3-7 Parameter Setup Dialog Box

<b>Detector</b>	NORMAL/POSI/NEGA/SAMPLE Used to set the detector.
<b>Result</b>	PEAK/RMS Used to set whether to display the result using average power or peak power.

### 3.3 Function Description

***Peak MKR Y Delta***

Used to set the Y delta of the peak marker.

***Multiplier***

Multiplies the measurement result by the set value, then displays the resultant value.

***Display Unit***

dBm/W/dB $\mu$ V Used to set the display units.

***Judgment***

Used to set ON/OFF of the Pass/Fail judgment for the limit value.

***Preselector***

Used to set the preselector.

---

***NOTE: This selection is displayed on R3267 only.***

---

1.6G: Used to measure harmonics of more than 1.6 GHz or spurious signals when the carrier frequency is lower than 1.6 GHz.

3.6G: Used to set this parameter for cases other than that above.

***Set to Default***

Returns the set value to the default.

### 3.3.3 F-Domain

Used to perform measurements according to the communication standard using the spectrum analyzer's sweep measurement method. Measurement items include power, occupied bandwidth, ACP Due to Switching, ACP Due to Modulation, In Band Spurious, and Out Bang Spurious measurements in the frequency domain.

In F-Domain measurement, the setting for the RBW, VBW, Sweep Time, or Detector is saved when exiting each measurement and recalled when entering each measurement again. To return the setting to the value specified by the standard, press *Config* and *Set to STD*.

#### 3.3.3.1 Power (F-Domain)

Used to measure power in the frequency domain using the spectrum analyzer.

##### *Gate Setup*

Used to set the gated sweep.

This setting is required when the input signal is a burst signal and Sample Detector is used.

##### *Trigger Setup*

Used to set a trigger.

Trigger Setup	
Trigger Source :	FREE RUN VIDEO <b>IF</b> EXT
Slope :	+ -
Trigger Level :	30 %
Trigger Position :	8 %
Delay Time :	0.000 ns

Figure 3-8 Trigger Setup Dialog Box

##### *Trigger Source*

Used to select a trigger

FREE RUN: Used to capture the signal using internal timing.

VIDEO: Used to trigger the signal using the video signal (displayed signal).

IF: Used to trigger the signal using the IF signal (approximately 6 MHz band).

EXT: Selected when triggering the signal using the external signal, which is input from the EXT TRIG terminal on the rear panel.

##### *Slope*

Used to select the edge when triggering.

+: Used to trigger at the leading edge.

-: Used to trigger at the trailing edge.

##### *Trigger Level*

Used to set the level to trigger.

##### *Trigger Position*

Used to set where the trigger position is displayed on the screen.

3.3 Function Description

**Delay Time** Used to set a delay time from the time a trigger signal is detected to the time the signal is captured.

---

*NOTE: When Delay Time is a negative value, signals before the trigger can be captured.*

---

**Gate Source**

**Trigger** Used to set Trigger Source specified by Trigger Setup as Gate Source.

---

*NOTE: When Trigger Source is set to IF and SPAN is set to a frequency higher than 6 MHz, the sweeping seems to be stopped, because the IF trigger bandwidth is approximately 6 MHz and the gate trigger is failing.*

---

**EXT Gate** Used to perform the gated sweep using the gate signal input from the EXT GATE terminal on the rear panel.

**Gate Setup** Used to set the gated sweep range when Trigger is selected for Gate Source.

**Set to STD** Used to set the gate position and width to the values specified by the communication standard.

**Gate Position** Used to set the gate position.

**Gate Width** Used to set the gate width.

**Gated Sweep ON/OFF** Starts the gated sweep.

**Detector** NORMAL/POSI/NEGA/SAMPLE Used to select the detector.

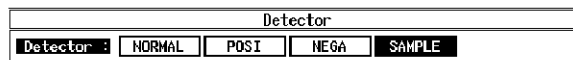

**Figure 3-9 Detector Dialog Box**

**Window Setup** Used to set the frequency range used for power measurement.

**Window ON/OFF** Used to set the window to ON or OFF. When the window is set to OFF, the power measurement range becomes a sweep band.

**Set to STD** Used to set the value determined by the communication standard.

**Window Position** Used to set the position of the window.

**Window Width** Used to set the width of the window.

---

*NOTE: When the window is partially outside the display, an arrow is shown next to Posi, Width or both in the area indicating the window conditions.*

---

**Y Scale [dB/div] 10/5/2** Used to set the display scale.

**Average Times ON/OFF** Used to set the averaging count.

**Config**

**Parameter Setup** Used to set measurement conditions.

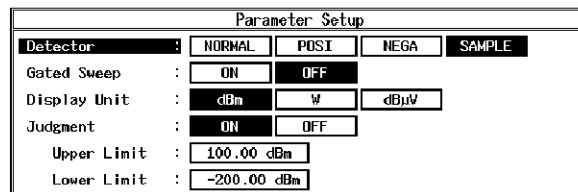

**Figure 3-10 Parameter Setup Dialog Box**

**Detector** NORMAL/POSI/NEGA/SAMPLE Used to select the detector.

**Gated Sweep** Used to set the gated sweep to ON or OFF.

**Display Unit** dBm/W/dBμV Used to select the display unit.

**Judgment** Used to set ON/OFF of the Pass/Fail judgment for measured power.

**Upper Limit** Used to set the upper limit for Pass/Fail judgment.

**Lower Limit** Used to set the lower limit for Pass/Fail judgment.

**Set to STD** Used to set the measurement parameters to the values specified by the communication standard.

3.3 Function Description

3.3.3.2 OBW

Used to measure an occupied bandwidth.

**OBW%** Used to set the frequency, including the percentage of the total power as an occupied bandwidth, when calculating the occupied bandwidth.

**Average Times ON/OFF** Used to set the averaging count.

**Config**

**Parameter Setup**

Used to set measurement conditions and so on.

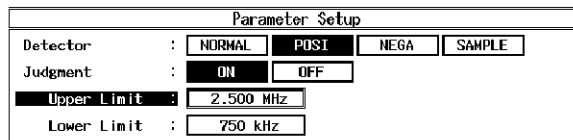

Figure 3-11 Parameter Setup Dialog Box

**Detector** NORMAL/POSI/NEGA/SAMPLE Used to select the detector.

**Judgment** Used to set ON/OFF of the Pass/Fail judgment for the occupied bandwidth.

**Upper Limit** Used to set the upper limit for Pass/Fail judgment.

**Lower Limit** Used to set the lower limit for Pass/Fail judgment.

**Set to STD**

Used to set the measurement parameters to the values specified by the communication standard.

3.3.3.3 Due to Transient

Used to measure the spectrum, including the rise and fall times of the burst.

**Template** Used to set and edits the template.

**Template ON/OFF** Used to set ON/OFF of the template display. When Template is set to ON, the Pass/Fail judgment for the template is displayed under the sweep screen.

**Shift X** Used to shift the set template in the frequency direction (X-axis).

**Shift Y** Used to shift the set template in the level direction (Y-axis).

**Margin ΔX ON/OFF** Magnifies the template in the X-axis direction with a set template frequency 0 as the center.

**Template Edit** Opens the template edit menu.



<i>Copy from STD</i>	Used to copy the template of the communication standard.
<i>Insert Line</i>	Used to insert a line before the selected line.
<i>Delete Line</i>	Used to delete the selected line.
<i>Sort</i>	Used to sort the tables in order of frequency.
<i>Table Init</i>	Used to initialize the table.
<i>Marker Edit</i>	Used to set the measurement frequency (frequency offset) and measurement band.
<i>Copy from STD</i>	Used to set to the parameters specified by the communication standard.
<i>Insert Line</i>	Used to insert a line before the selected line.
<i>Delete Line</i>	Used to delete the selected line.
<i>Sort</i>	Used to sort data in order of frequency.
<i>Table Init</i>	Used to initialize the table.
<i>Average Times ON/OFF</i>	Used to set the averaging count.
<i>Config</i>	
<i>Parameter Setup</i>	

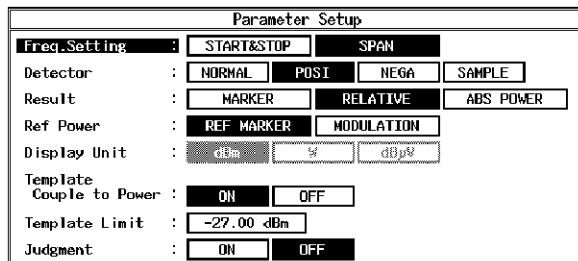

Figure 3-12 Parameter Setup Dialog Box

***Freq. Setting***

START&STOP/SPAN  
Used to select the measurement mode.

***Detector*** NORMAL/POSI/NEGA/SAMPLE

Used to select the detector.

### 3.3 Function Description

**Result** Specifies how to display the result.

**MARKER:** Used to display the marker read value. The position of the marker is set by Marker Edit.

**RELATIVE:** Used to display the marker read value using a relative value.

**ABS POWER:** Converts the value displayed by RELATIVE into the absolute value using carrier power and displays it.

**Ref Power**

When RELATIVE is selected for Result, this selects which relative value to use to display the marker read value.

**REF MARKER:** Used to display a relative value to Ref Marker set by Marker Edit.

**MODULATION:** Display a relative value to the measurement result of Tx power in Modulation.

**Display Unit**

dBm/W/dB $\mu$ V Specifies the unit of the result displayed.

---

*NOTE: When RELATIVE is selected for Result, the unit is dB.*

---

**Template Couple to Power**

Set whether to raise or lower the template with the power set by Ref Power.

**Template Limit**

If the absolute value of the template is smaller than the this value when Template Couple to Power is set to ON, clip the template at this value.

**Judgment**

Used to make the Pass/fail judgment for the limit value set by Marker edit. The Pass/Fail judgment result is displayed under the display screen together with the marker list.

**Set to STD**

Returns the measurement parameters to the values specified by the standard.

### 3.3.3.4 Due to Modulation

Measure the modulation spectrum excluding the rise and fall of the burst.

#### *Gate Setup*

Used to set the gated sweep.

#### *Trigger Setup*

Used to set a trigger.

Trigger Setup	
Trigger Source :	FREE RUN VIDEO <b>IF</b> EXT
Slope :	<b>+</b> -
Trigger Level :	30 %
Trigger Position :	8 %
Delay Time :	0.000 ns

Figure 3-13 Trigger Setup Dialog Box

#### *Trigger Source*

Used to select a trigger.

FREE RUN: Used to capture the signal using internal timing.

VIDEO: Used to trigger the signal using the video signal.

IF: Used to trigger the signal using the IF signal (approximately 6 MHz band).

EXT: Selected when triggering the signal using the external signal, which is input from the EXT TRIG terminal on the rear panel.

#### *Slope*

Used to select the edge when triggering.

+: Used to trigger at the leading edge.

-: Used to trigger at the trailing edge.

#### *Trigger Level*

Used to set the level to trigger.

#### *Trigger Position*

Used to set where the trigger position is displayed on the screen.

#### *Delay Time*

Used to set a delay time from the time a trigger signal is detected to the time the signal is captured.

---

**NOTE:** When Delay Time is a negative value, signals before the trigger can be captured.

---

#### *Gate Source*

#### *Trigger*

Used to set Trigger Source specified by Trigger Setup as Gate Source.

3.3 Function Description

---

*NOTE: When Trigger Source is set to IF and SPAN is set to a frequency higher than 6 MHz, the sweeping seems to be stopped, because the IF trigger bandwidth is approximately 6 MHz and the gate trigger is failing.*

---

<i><b>EXT Gate</b></i>	Used to perform the gated sweep using the gate signal input from the EXT Gate terminal on the rear panel.
<i><b>Gate Setup</b></i>	Used to set the gated sweep range when Trigger is selected for Gate Source.
<i><b>Set to STD</b></i>	Used to set the gate position and width to the values specified by the communication standard.
<i><b>Gate Position</b></i>	Set the gate position.
<i><b>Gate Width</b></i>	Used to set the gate width.
<i><b>Gated Sweep ON/OFF</b></i>	Starts the gated sweep.
<i><b>Detector</b></i>	NORMAL/POSI/NEGA/SAMPLE Used to select the detector.

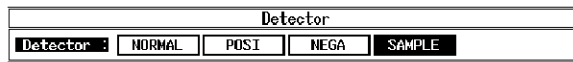

**Figure 3-14 Detector Dialog Box**

<i><b>Template</b></i>	Used to set and edits the template.
<i><b>Template ON/OFF</b></i>	Used to set the template display to ON or OFF. When Template is set to ON, the Pass/Fail judgment for the template is displayed under the sweep screen.
<i><b>Shift X</b></i>	Used to shift the set template in the frequency direction (X-axis).
<i><b>Shift Y</b></i>	Used to shift the set template in the level direction (Y-axis).
<i><b>Margin ΔX ON/OFF</b></i>	Magnifies the template in the X-axis direction with a set template frequency 0 as the center.
<i><b>Template Edit</b></i>	
<i><b>Copy from STD</b></i>	Used to copy the template specified by the communication standard.
<i><b>Insert Line</b></i>	Used to insert a line before the selected line.
<i><b>Delete Line</b></i>	Used to delete the selected line.

**Sort** Used to sort the tables in frequency order.

**Table Init** Used to initialize the table.

#### Marker Edit

**Copy from STD** Used to set to the parameters specified by the communication standard.

**Insert Line** Used to insert a line before the selected line.

**Delete Line** Used to delete the selected line.

**Sort** Used to sort data in order of frequency.

**Table Init** Used to initialize the table.

**Average Times ON/OFF** Used to set the averaging count.

#### Config

##### Parameter Setup

Parameter Setup	
Freq. Setting :	<input type="radio"/> START&STOP <input type="radio"/> SPAN
Detector :	<input type="radio"/> NORMAL <input type="radio"/> POSI <input type="radio"/> NEGA <input type="radio"/> SAMPLE
Result :	<input type="radio"/> MARKER <input type="radio"/> RELATIVE <input type="radio"/> ABS POWER
Ref Power :	<input type="radio"/> REF MARKER <input type="radio"/> MODULATION
Display Unit :	<input type="radio"/> dBm <input type="radio"/> $\mu$ <input type="radio"/> dB $\mu$ V
Template Couple to Power :	<input type="radio"/> ON <input type="radio"/> OFF
Template Limit :	<input type="text" value="-27.00 dBm"/>
Judgment :	<input type="radio"/> ON <input type="radio"/> OFF

Figure 3-15 Parameter Setup Dialog Box

**Freq. Setting** START&STOP/SPAN Used to select the measurement mode.

**Detector** NORMAL/POSI/NEGA/SAMPLE Used to select the detector.

**Result** Specifies how to display the results.

**MARKER:** Used to display the marker read value. The position of the marker is set by Marker Edit.

**RELATIVE:** Used to display the marker read value using a relative value.

**ABS POWER:** Converts the value displayed by RELATIVE into the absolute value using carrier power and displays it.

3.3 Function Description

<b><i>Ref Power</i></b>	When RELATIVE is selected for Result, this selects which relative value to use to display the marker read value.  REF MARKER: Used to display a relative value to Ref Marker set by Marker Edit.  MODULATION: Used to display a relative value to the measurement result of Tx power in Modulation.
<b><i>Display Unit</i></b>	dBm/W/dB $\mu$ V Used to select the display unit.

---

***NOTE: When RELATIVE is selected for Result, the unit is dB.***

---

<b><i>Template Couple to Power</i></b>	Sets whether or not to raise or lower the template with the power set by Ref Power.
<b><i>Template Limit</i></b>	If the absolute value of the template is smaller than the this value when Template Couple to Power is set to ON, clip the template at this value.
<b><i>Judgment</i></b>	Used to make the Pass/Fail judgment for the limit value set by Marker edit. The Pass/Fail judgment result is displayed under the display screen together with the marker list.
<b><i>Set to STD</i></b>	Returns the measurement parameters to the values specified by the standard.

**3.3.3.5 Inband Spurious**

Used to search for a peak by sweeping the set frequency.

***Template***

<b><i>Template ON/OFF</i></b>	Used to set the template display to ON or OFF. When Template is set to ON, the Pass/Fail judgment for the template is displayed under the sweep screen.
<b><i>Shift X</i></b>	Used to shift the set template in the frequency direction (X-axis).
<b><i>Shift Y</i></b>	Used to shift the set template in the level direction (Y-axis).
<b><i>Margin <math>\Delta</math>X ON/OFF</i></b>	Magnifies the template in the X-axis direction with a set template frequency 0 as the center.

***Template Edit***

<b><i>Copy from STD</i></b>	Used to copy the template specified by the communication standard.
-----------------------------	--

<i>Insert Line</i>	Used to insert a line before the selected line.
<i>Delete Line</i>	Used to delete the selected line.
<i>Sort</i>	Used to sort the tables in frequency order.
<i>Table Init</i>	Used to initialize the table.

**Marker Edit**

<i>Copy from STD</i>	Used to set the measurement parameters specified by the communication standard.
<i>Insert Line</i>	Used to insert a line before the selected line.
<i>Delete Line</i>	Used to delete the selected line.
<i>Sort</i>	Used to sort data in order of frequency.
<i>Table Init</i>	Used to initialize the table.

*Average Times ON/OFF* Used to set the averaging count.

**Config****Parameter Setup**

Parameter Setup	
Freq. Setting :	START&STOP SPAN
Detector :	NORMAL POSI NEGA SAMPLE
Peak MKR Y Delta :	1.0 div
Result :	MARKER RELATIVE ABS POWER
Ref Power :	REF MARKER MODULATION
Display Unit :	dBm W dBμV
Template Couple to Power :	ON OFF
Template Limit :	-13.00 dBm
Judgment :	ON OFF

Figure 3-16 Parameter Setup Dialog Box

<i>Freq. Setting</i>	START&STOP/SPAN Used to select the measurement mode.
<i>Detector</i>	NORMAL/POSI/NEGA/SAMPLE Used to select the detector.
<i>Peak MKR Y Delta</i>	Used to set the Y delta of the peak marker.
<i>Result</i>	Specifies how to display the results.  MARKER: Used to display the marker read value. The position of the marker is set by Marker Edit.

3.3 Function Description

RELATIVE: Used to display the marker read value using a relative value.

ABS POWER: Converts the value displayed by RELATIVE into the absolute value using carrier power and displays it.

**Ref Power** When RELATIVE is selected for Result, this selects which relative value is used to display the marker read value.

REF MARKER: Used to display a relative value to Ref Marker set by Marker Edit.

MODULATION: Used to display a relative value to the measurement result of Tx power in Modulation.

**Display Unit** dBm/W/dBμV Used to select the display unit.

---

*NOTE: When RELATIVE is selected for Result, the unit is dB.*

---

**Template Couple to Power** Sets whether or not to raise or lower the template with the power set by Ref Power.

**Template Limit** If the absolute value of the template is smaller than the this value when Template Couple to Power is set to ON, clip the template at this value.

**Judgment** Used to make the Pass/Fail judgment for the limit value set by Marker edit. The Pass/Fail judgment result is displayed under the display screen together with the marker list.

**Set to STD** Returns the measurement parameters to the values specified by the standard.

**3.3.3.6 Outband Spurious**

Used to search for a peak by sweeping the frequency according to the table.

**Table No. 1/2/3** Used to select the table number.

**Load Table** Loads the table.

**Table Edit** Edits the table.

**Table No. 1/2/3** Used to select the table number.

**Load Table** Loads the table.



<b>Save Table</b>	Saves the table.
<b>Insert Line</b>	Used to insert a line before the selected line.
<b>Delete Line</b>	Used to delete the selected line.
<b>Table Init</b>	Used to initialize the table
<b>Average Times ON/OFF</b>	Used to set the averaging count
<b>Config</b>	
<b>Parameter Setup</b>	Used to set measurement parameters.

Parameter Setup			
Detector	:	<input type="button" value="NORMAL"/>	<input type="button" value="POSI"/>
		<input type="button" value="NEGA"/>	<input type="button" value="SAMPLE"/>
Peak MKR Y Delta	:	<input type="text" value="1.0 div"/>	
Display Unit	:	<input type="button" value="dBm"/>	<input type="button" value="W"/>
		<input type="button" value="dBμV"/>	
Judgment	:	<input type="button" value="ON"/>	<input type="button" value="OFF"/>
Preselector	:	<input type="button" value="1.6G"/>	<input type="button" value="3.6G"/>

Figure 3-17 Parameter Setup Dialog Box

<b>Detector</b>	NORMAL/POSI/NEGA/SAMPLE Used to set the detector.
<b>Peak MKR Y Delta</b>	Used to set the Y delta of a peak marker.
<b>Display Unit</b>	dBm/W/dBμV Used to set the display unit.
<b>Judgment</b>	Makes the Pass/Fail judgment using the limit values set by Table Edit.
<b>Preselector</b>	Used to set the preselector.

---

**NOTE:** This selection is displayed on R3267 only.

---

1.6G: Used to measure harmonics of more than 1.6 GHz or spurious signals when the carrier frequency is lower than 1.6 GHz.

3.6G: Set this parameter for cases other than that above.

<b>Set to Default</b>	Returns the set value to the default.
-----------------------	---------------------------------------

### 3.3 Function Description

#### 3.3.4 Modulation

Describes the modulation analysis menu using a DSP.

##### 3.3.4.1 Waveform Quality

Used to measure the waveform quality ( $\rho$ ), frequency error, and modulation accuracy of non-code-multiplexed signals.

**Auto Level Set**

This is used to automatically set the reference level. Level adjustment is made only when this key is pressed.

*NOTE: The signal level must remain constant while Auto level Set is being executed.*

**Graphics**

Used to display the menu associated with graphics display.

**Display Start**

Used to set the starting chip to execute the graphics display. Used to display a graph of 128 chips from the set chip.

**Select Type**

Open the graphics selection window.

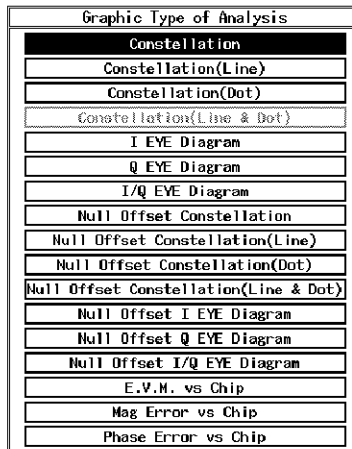

Figure 3-18 Select Type Dialog Box

**Parameter Setup**

Used to set parameters used for measuring.

Parameter Setup	
Meas Mode	: PILOT   NON ZERO
Meas Range	: 615 chip
$\tau$ Offset	: DEFAULT   USER
$\tau$	: [ ]
Equalizing Filter	: ON   OFF
PN Offset Search Mode	: ON   OFF
PN Offset	: 0
Trigger Source	: INT   EXT
	: INTRVL(EXT)   INTRVL
EXT Trigger Slope	: +   -
EXT Trigger Delay	: 0.000 chip
Freq Meas Range	: NORMAL   EXPAND

Figure 3-19 Parameter Setup Dialog Box

**Meas Mode**

Used to select the measurement mode.

PILOT: Used to measure a signal with data of all zeros (pilot signal).

NON ZERO: This mode can measure a signal with data of non-zeros, but cannot measure a  $\tau$ .

**Meas Range**

Enters the measurement range in chips.

When link is set to Forward in the Setup STD menu, set 64×N, and when link is set to Reverse, set the range in chips.

 **$\tau$  Offset**

Corrects the delay between the external trigger and the head of the PN signal in the measurement path.

DEFAULT: Used to set internal correction values.

USER: Enters the correction value.

 **$\tau$** 

Used to set the correction value.

**Equalizing Filter**

Used to set the equalizing filter to ON or OFF. Set this parameter to ON while the BTS output is passing through the equalizing filter.

**PN Offset Search Mode**

ON: Used to search the captured signal for PN Offset when the relationship between the external trigger and PN Offset of the input signal is undetermined.

OFF: Used to set the PN Offset when the relationship between the external trigger and PN Offset of the input signal is determined in advance.

**PN Offset**

Used to set the synchronization position of PN.

3.3 Function Description

---

*NOTE: This parameter can be set only when PN Offset Search Mode is set to OFF.*

---

**Trigger Source**

**INT:** Used to capture data using internal timing.

**EXT:** Used to capture data in sync with the external trigger.

**INTRVL (EXT):** The built-in counter generates triggers every 26.6 milliseconds. The built-in counter is in sync with the external trigger.

**INTRVL:** The built-in counter generates triggers every 26.6 milliseconds. The built-in counter is not in sync with the external trigger.

**EXT Trigger Slope**

Used to set the rise and fall times of the external trigger.

**EXT Trigger Delay**

Corrects the delay time when the signal (the head of PN) lags behind the external trigger.

**Freq Meas Range**

Set whether or not to expand the estimated frequency range for measurement.

**NORMAL:** Does not expand the measurement range of a frequency error.

---

*NOTE: Use this mode when signals exist in the adjacent channels, or when measuring a signal including a large number of noise components.*

---

**EXPAND:** Expands the estimated range of a frequency error.

**Average Times ON/OFF**

Used to set the averaging count.

### 3.3.4.2 Code Domain Power

Used to measure power, a time alignment error ( $\tau$ ), and a phase difference for each Walsh channel.

**Auto Level Set**

Used to automatically set the reference level. Level adjustment is made only when this key is pressed.

---

**NOTE:** The signal level must be constant while Auto Level Set is being executed.

---

**Scale Setup**

Used to set the display screen.

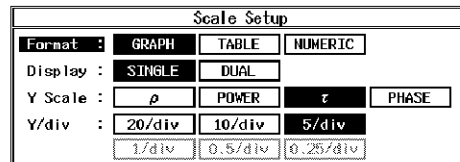

Figure 3-20 Scale Setup Dialog Box

**Format**

- GRAPH: Used to display data using a bar graph.
- TABLE: Used to display data in table format.
- NUMERIC: Used to display a frequency error and others in numeric values.

**Display**

- SINGLE: Used to display a single screen.
- DUAL: Used to display two screens: a graph screen and a numeric screen.

**Y Scale**

$\rho$ /POWER/ $\tau$ /PHASE Used to select which data to display. When the NORMAL mode is selected in Parameter Setup, only  $\rho$  and POWER can be selected.

**Y/div**

Used to select the vertical axis scale of graphic display.

3.3 Function Description

**Parameter Setup**

Used to set parameters for measurement.

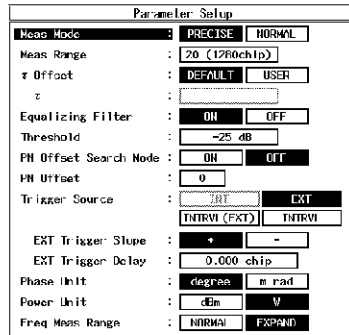

**Figure 3-21 Parameter Setup Dialog Box**

**Meas Mode**

Used to select the measurement mode.

**PRECISE:** Used to measure the time alignment error and phase error in addition to the  $\rho$  and power ratio for each channel at the same time.

**NORMAL:** Used to measure the  $\rho$  and power ratio for each channel.

**Meas Range**

Enters the measurement range in chips. Enters the range using  $64 \times N$ .

**$\tau$  Offset**

Corrects the delay between the external trigger and the head of the PN signal in the measurement path.

**DEFAULT:** Used to set internal correction values.

**USER:** Enters the correction value.

**$\tau$**

Used to set the correction value.

**Equalizing Filter**

Used to set the equalizing filter to ON or OFF. Set this parameter to ON while the BTS output is passing through the equalizing filter.

**Threshold**

Used to set the threshold of demodulation during measurement in the PRECISE mode. Set the threshold higher than a noise floor and lower than the signal. In addition, this parameter is used as a reference for judging whether or not there is a signal or a noise in the  $\tau$  measurement.

***PN Offset Search Mode***

ON: Used to search the captured signal for PN Offset when the relationship between the external trigger and PN Offset of the input signal is undetermined.

OFF: Used to set the PN Offset when the relationship between the external trigger and PN Offset of the input signal is determined in advance.

***PN Offset***

Used to set the synchronization position of PN.

---

*NOTE: This parameter can be set only when PN Offset Search Mode is set to OFF.*

---

***Trigger Source***

INT: Used to capture data using internal timing.

EXT: Used to capture data in synchronization with the external trigger.

INTRVL (EXT): The built-in counter generates triggers every 26.6 milliseconds. The built-in counter is in sync with the external trigger.

INTRVL: The built-in counter generates triggers every 26.6 milliseconds. The built-in counter is not in sync with the external trigger.

***EXT Trigger Slope***

Used to set the rise and fall times of the external trigger.

***EXT Trigger Delay***

Corrects the delay time when the signal (the head of PN) lags behind the external trigger.

***Phase Unit***

Used to set a unit when measuring the phase differences between the pilot signal and other channels.

degree: Used to display a phase difference in degrees.

m rad: Used to display a phase difference in milliradians.

***Power Unit***

Used to set a unit of dBm or W when displaying power for each channel.

### 3.3 Function Description

***Freq Meas Range***

Set whether or not to expand the estimated frequency range for measurement.

NORMAL: Does not expand the measurement range for a frequency error.

---

*NOTE: Use this mode when signals exist in the adjacent channels, or when measuring a signal including a large number of noise components.*

---

EXPAND: Expands the estimated range of a frequency error.

***Marker Setup***

Paging Ch / Traffic Ch Used to display the pilot signal and relative values of paging channel and traffic channel under the graph screen. Used to select which channel to display.

***Average Times ON/OFF***

Used to set the averaging count.



### 3.3.4.3 Tx Power

Used to measure power and a peak factor.

#### *Auto Level Set*

Used to automatically set the reference level.  
Level adjustment is made only when this key is pressed.

---

**NOTE:** *The signal level must be constant while Auto level Set is being executed.*

---

#### *Parameter Setup*

Used to set parameters used for measuring.

Parameter Setup	
Trigger Source :	<input type="button" value="INT"/> <input type="button" value="EXT"/> <input type="button" value="INTRVL(EXT)"/>
EXT Trigger Slope :	<input type="button" value="+"/> <input type="button" value="-"/>
EXT Trigger Delay :	<input type="text" value="0.000 chip"/>
Meas Filter :	<input type="button" value="NARROW"/> <input type="button" value="WIDE"/>

**Figure 3-22 Parameter Setup Dialog Box**

#### *Trigger Source*

- INT: Used to capture data using internal timing.
- EXT: Used to capture data in sync with the external trigger.
- INTRVL (EXT): The built-in counter generates triggers every 26.6 milliseconds. The built-in counter is in sync with the external trigger.

#### *Trigger Slope*

Used to set the rise and fall times with the external trigger.

#### *Trigger Delay*

Corrects the signal delay time to the external trigger.

#### *Meas Filter*

Used to select the band of the receiving filter.  
This selection is possible only when Link is set to Forward in Set-up STD. When Link is set to REVERSE, the filter band is fixed to WIDE.

- NARROW: Select the receiving filter whose pass bandwidth is almost the same as that of the transmitted signal.

---

**NOTE:** *Select this parameter when signals exist in the adjacent channels.*

---

### 3.3 Function Description

Since the band of the filter is narrow, the measured value of power is less than the measured value of the power meter.

WIDE:

Used to select a filter band wider than the transmission signal band.

Even when the transmission signal includes a frequency error, the value close to that measured by the power meter can be measured.

*Average Times ON/OFF*

Used to set the averaging count.

### 3.3.5 STD

Used to display menus used for setting signals and channel numbers.

#### 3.3.5.1 Setup STD

Used to set the frequency band, direction, chip rate of the measurement signal.

STD Measurement Parameter Set	
Type	CDMA(800MHz)   CDMA(1.8GHz)   CDMA(1.9GHz) JAPAN(800MHz)   CHINA(800MHz)
Link	FORWARD   REVERSE
Rate	9600/14400   4800/7200 2400/3600   1200/1800
Offset Level	0.0 dB
Frequency Input	FREQUENCY   CHANNEL
Input	RF   BASEBAND(I&Q)
Baseband Input	AC   DC
IQ Inverse	NORMAL   INVERSE
Cont Auto Level Set	ON   OFF

Figure 3-23 STD Set Dialog Box

#### Type

CDMA (800 MHz)/CDMA (1.8 GHz)/CDMA (1.9 GHz)/JAPAN (800 MHz)/CHINA (800 MHz):

Used to select the frequency band of the measurement signal.

The standard value and the band for spurious measurement are determined by this selection.

In addition, this selection is used to calculate the frequency using the channel number.

#### Link

Used to set the direction of the measurement signal.

FORWARD: Used to measure the signal from the BTS.

REVERSE: Used to measure the signal from the MS (terminal).

#### Rate

The transfer rate must be set, when Link is set to REVERSE. The analyzer determines whether or not the measured signal is burst. When the measured signal is a burst, the analyzer starts the gated sweep in the F-Domain Power measurement mode. In the Tx Power measurement mode, the analyzer measures the Tx Power, after searching for a burst.

#### Offset Level

This parameter can set the offset value of the reference level within the range of  $\pm 100$  dB. Used to display the power to which the

### 3.3 Function Description

	offset value is added.
<b><i>Frequency Input</i></b>	Sets whether or not a frequency or a channel number is used to input the center frequency of the instrument.
<b><i>Input</i></b>	Set the input path of a signal.  RF:                   Used to set the RF connector to Input.  BASEBAND (I & Q): Used to set the I and Q connectors on the rear panel to Input. Code Domain Power, Waveform Quality, and Tx Power can be analyzed using the Baseband IQ input. For Tx Power, only relative power is displayed.
<b><i>Baseband Input</i></b>	Selects the coupling of signals. Effective for BASEBAND(I & Q) only  AC:                   Sets an alternate current coupling. (A cutoff frequency is approx. 15 Hz)  DC:                   Sets a direct current coupling.
<b><i>IQ Inverse</i></b>	Used to set the phases I and Q.  NORMAL: The phases I and Q do not change.  INVERSE: The phases I and Q are inverted.
<b><i>Cont Auto Level Set</i></b>	Used to select ON or OFF from the mode which automatically sets the internal reference level (REF LEVEL) to an optimum value in accordance with the measurement signal.  ON:                   Used to automatically set the reference level to an optimum value. Always check the level before starting measurement and set an optimum value.  OFF:                  The reference level is fixed at the set level. Set the level manually or using "Auto Level Set" soft key.

---

***NOTE: The input signal level must remain constant while executing the auto ranging.***

---

### 3.3.5.2 Channel Setting

Used to set the relationship between the channel number and frequency.

*Copy from STD*

Used to copy the values specified by the standard to the channel number and frequency editor.

### 3.3.5.3 DC CAL

Corrects direct current components inside the circuit.



## 4 REMOTE CONTROL

### 4.1 GPIB Command Index

This GPIB command index can be used as the index for Chapter 4.

<u>GPIB Command Key</u>	<u>Reference Pages</u>		
*CLS .....	4-41	CDPPNOFS.....	4-35
*ESE .....	4-41	CDPRES.....	4-35
*ESR .....	4-41	CDPRHO.....	4-36
*IDN .....	4-41	CDPTAU.....	4-35
*RST.....	4-41	CDPUNT DBM.....	4-35
*SRE.....	4-41	CDPUNT W.....	4-35
*STB.....	4-41	CEQFLT OFF.....	4-34
. .....	4-40	CEQFLT ON.....	4-34
0 to 9.....	4-40	CF.....	4-8
AA.....	4-7	CFMT GRP.....	4-33
AD.....	4-41	CFMT NUM.....	4-33
ALS OFF.....	4-11	CFMT TBL.....	4-33
ALS ON.....	4-11	CFRRNG EXP.....	4-35
AS.....	4-8	CFRRNG NORM.....	4-35
AT.....	4-7	CH.....	4-10
ATMIN.....	4-7	CHEDFR1.....	4-10
ATMIN OFF.....	4-7	CHEDFR2.....	4-10
ATMIN ON.....	4-7	CHEDFR3.....	4-10
AUTOLVL.....	4-31, 4-33, 4-36	CHEDRV1.....	4-10
AUTOWFL.....	4-11, 4-15	CHEDRV2.....	4-10
BA.....	4-8	CHEDRV3.....	4-10
BBINPUT AC.....	4-11	CHSETSTD.....	4-11
BBINPUT DC.....	4-11	CHTBL1 DSBL.....	4-11
CAVGAT.....	4-13	CHTBL1 ENBL.....	4-11
CAVGCDP.....	4-35	CHTBL2 DSBL.....	4-11
CAVGCHP.....	4-20	CHTBL2 ENBL.....	4-11
CAVGOBW.....	4-21	CHTBL3 DSBL.....	4-11
CAVGRAT.....	4-16	CHTBL3 ENBL.....	4-11
CAVGSPR.....	4-26, 4-28	CINBMAX.....	4-30
CAVGWF.....	4-32	CINBSPR.....	4-29
CCHPOW.....	4-21	CLDC.....	4-11
CDISP DUAL.....	4-33	CMKLVL.....	4-36
CDISP SNGL.....	4-33	CMMOD NORM.....	4-34
CDMAJAPAN CDMAJAPAN.....	4-10	CMMOD PREC.....	4-34
CDPCFER.....	4-35	CMRNG.....	4-34
CDPGPH.....	4-35	COBW.....	4-22
CDPIQOFS.....	4-35	COBWCP.....	4-24
CDPMAG.....	4-35	COBWDET NEG.....	4-21
CDPMOD.....	4-35	COBWDET NRM.....	4-21
CDPPHSE.....	4-35	COBWDET POS.....	4-21
		COBWDET SMP.....	4-22
		COBWPER.....	4-21

4.1 GPIB Command Index

COMMSYS IS136.....	4-7	DTMFRMD STSP.....	4-27
COMMSYS IS95.....	4-7	DTMJDG OFF.....	4-27
COMMSYS PDC.....	4-7	DTMJDG ON.....	4-27
COMMSYS PHS.....	4-7	DTMMEAS.....	4-27
COMMSYS WCDMA.....	4-7	DTMMKRCLR.....	4-26
CPDIV P025DB.....	4-33	DTMMKRCP.....	4-26
CPDIV P05DB.....	4-33	DTMMKRED.....	4-26
CPDIV P10DB.....	4-33	DTMREF MKR.....	4-27
CPDIV P1DB.....	4-33	DTMREF MOD.....	4-27
CPDIV P20DB.....	4-33	DTMRES ABS.....	4-27
CPDIV P5DB.....	4-33	DTMRES MKR.....	4-27
CPHUNT DEG.....	4-34	DTMRES REL.....	4-27
CPHUNT RAD.....	4-34	DTMSETSTD.....	4-27
CPNMOD OFF.....	4-34	DTMTMPL OFF.....	4-25
CPNMOD ON.....	4-34	DTMTMPL ON.....	4-25
CPNOFS.....	4-34	DTMTMPLBTM.....	4-27
CPWDIV P10DB.....	4-20	DTMTMPLCLR.....	4-26
CPWDIV P5DB.....	4-20	DTMTMPLCP.....	4-26
CPWDX.....	4-20	DTMTMPLDX.....	4-26
CPWLX.....	4-20	DTMTMPLED.....	4-26
CTHRSH.....	4-34	DTMTMPLPW OFF.....	4-26
CTOFS DFLT.....	4-34	DTMTMPLPW ON.....	4-26
CTOFS USER.....	4-34	DTMTMPLSX.....	4-25
CTOFSDT.....	4-34	DTMTMPLSY.....	4-25
CTRGDLY.....	4-34	DTMUNIT DBM.....	4-26
CTRGSLP FALL.....	4-34	DTMUNIT DBUV.....	4-26
CTRGSLP RISE.....	4-34	DTMUNIT W.....	4-26
CTRGSRC EXT.....	4-34	DTS AVG.....	4-23
CTRGSRC INT.....	4-34	DTSDET NEG.....	4-23
CTRGSRC INTRVL1.....	4-34	DTSDET NRM.....	4-23
CTRGSRC INTRVL2.....	4-34	DTSDET POS.....	4-23
CTXAVG.....	4-36	DTSDET SMP.....	4-23
CTXPOW.....	4-36	DTSFRMD CFSP.....	4-24
CYSCL PHA.....	4-33	DTSFRMD STSP.....	4-24
CYSCL POW.....	4-33	DTSJDG OFF.....	4-24
CYSCL RHO.....	4-33	DTSJDG ON.....	4-24
CYSCL TAU.....	4-33	DTSMEAS.....	4-24
DB.....	4-40	DTSMKRCLR.....	4-23
DEL REG_nm.....	4-9	DTSMKRCP.....	4-23
DELSTBL.....	4-17	DTSMKRED.....	4-23
DL0.....	4-41	DTSREF MKR.....	4-24
DL1.....	4-41	DTSREF MOD.....	4-24
DL2.....	4-41	DTSRES ABS.....	4-24
DL3.....	4-41	DTSRES MKR.....	4-24
DL4.....	4-41	DTSRES REL.....	4-24
DTMAVG.....	4-26	DTSSETSTD.....	4-24
DTMDET NEG.....	4-26	DTSTMPL OFF.....	4-22
DTMDET NRM.....	4-26	DTSTMPL ON.....	4-22
DTMDET POS.....	4-26	DTSTMPLBTM.....	4-23
DTMDET SMP.....	4-26	DTSTMPLCLR.....	4-23
DTMFRMD CFSP.....	4-27	DTSTMPLCP.....	4-22



DTSTMPLDX .....	4-22	FDSUNIT DBM .....	4-30
DTSTMPLD .....	4-23	FDSUNIT DBUV .....	4-30
DTSTMPLPW OFF .....	4-23	FDSUNIT W .....	4-30
DTSTMPLPW ON .....	4-23	FINPMD CHL .....	4-10
DTSTMPLSX .....	4-22	FINPMD FREQ .....	4-10
DTSTMPLSY .....	4-22	GATEPOW .....	4-14
DTSUNIT DBM .....	4-23	GPHCH .....	4-38
DTSUNIT DBUV .....	4-23	GPHCHIP .....	4-38
DTSUNIT W .....	4-23	GPHI .....	4-37
ENT .....	4-40	GPHPHA .....	4-39
ERRNO? .....	4-41	GPHPOW .....	4-39
FA .....	4-8	GPHQ .....	4-38
FB .....	4-8	GPHRHO .....	4-39
FDPAVG .....	4-20	GPHTAU .....	4-39
FDPDET NEG .....	4-20	GPHX .....	4-38
FDPDET NRM .....	4-20	GPHY .....	4-38
FDPDET POS .....	4-20	GZ .....	4-40
FDPDET SMP .....	4-20	HCOPY .....	4-7
FDPDIV P10DB .....	4-20	HZ .....	4-40
FDPDIV P2DB .....	4-20	INPUT IQ .....	4-11
FDPDIV P5DB .....	4-20	INPUT RF .....	4-11
FDPJDG OFF .....	4-21	IP .....	4-9
FDPJDG ON .....	4-21	IQMD INV .....	4-11
FDPJDGLOW .....	4-21	IQMD NORM .....	4-11
FDPJDGUP .....	4-21	KZ .....	4-40
FDPMEAS .....	4-21	LC .....	4-41
FDPSETSTD .....	4-21	LINK FWD .....	4-10
FDPUNIT DBM .....	4-20	LINK REV .....	4-10
FDPUNIT DBUV .....	4-20	LMCPSL STD .....	4-13
FDPUNIT W .....	4-20	MA .....	4-40
FDPWDO OFF .....	4-20	MF .....	4-9
FDPWDO ON .....	4-20	MFL .....	4-9
FDPWPOS .....	4-20	MK .....	4-9
FDPWWID .....	4-20	MKD .....	4-9
FDSAVG .....	4-30	MKN .....	4-9
FDSCLR .....	4-30	MKOFF .....	4-9
FDSDET NEG .....	4-30	ML .....	4-9
FDSDET NRM .....	4-30	MO .....	4-9
FDSDET POS .....	4-30	MODTYP CDMA 800M .....	4-10
FDSDET SMP .....	4-30	MODTYP CDMA1700M .....	4-10
FDSJDG OFF .....	4-31	MODTYP CDMA1900M .....	4-10
FDSJDG ON .....	4-31	MODTYP CDMACHINA .....	4-10
FDSL .....	4-30	MS .....	4-40
FDSMEAS .....	4-31	MV .....	4-40
FDSPKMKY .....	4-31	MW .....	4-40
FDSPRE 16G .....	4-31	MZ .....	4-40
FDSPRE 36G .....	4-31	OBWAVG .....	4-21
FDSSETSTD .....	4-31	OBWDET NEG .....	4-21
FDSSV .....	4-30	OBWDET NRM .....	4-21
FDSTBL .....	4-30	OBWDET POS .....	4-21
FDSTBLED .....	4-30	OBWDET SMP .....	4-22

4.1 GPIB Command Index

OBWJDG OFF .....	4-22	RL .....	4-8
OBWJDG ON .....	4-22	RO .....	4-10
OBWJDGLOW .....	4-22	RQS .....	4-41
OBWJDGUP .....	4-22	S0 .....	4-41
OBWMEAS .....	4-22	S1 .....	4-41
OBWPER .....	4-21	S2 .....	4-41
OBWSETSTD .....	4-22	SC .....	4-40
OORAUTOLVL .....	4-15	SETFUNC CW .....	4-7
OORAVG .....	4-15	SETFUNC TRAN .....	4-7
OORDET NEG .....	4-16	SI .....	4-14, 4-16,
OORDET NRM .....	4-16		4-18, 4-21,
OORDET POS .....	4-16		4-22, 4-24,
OORDET SMP .....	4-16		4-27, 4-29,
OORDIV P10DB .....	4-15		4-31, 4-32,
OORDIV P2DB .....	4-15		4-35, 4-36
OORDIV P5DB .....	4-15	SP .....	4-9
OORJDG OFF .....	4-16	SPRAVG .....	4-28
OORJDG ON .....	4-16	SPRDET NEG .....	4-28
OORJDGUP .....	4-16	SPRDET NRM .....	4-28
OORMEAS .....	4-16	SPRDET POS .....	4-28
OORSETSTD .....	4-16	SPRDET SMP .....	4-28
OORTRGDT .....	4-15	SPRFRMD CFSP .....	4-29
OORTRGLVL .....	4-15	SPRFRMD STSP .....	4-29
OORTRGPOS .....	4-15	SPRJDG OFF .....	4-29
OORTRGSLP FALL .....	4-15	SPRJDG ON .....	4-29
OORTRGSLP RISE .....	4-15	SPRMEAS .....	4-29
OORTRGSRC EXT .....	4-15	SPRMKRCLR .....	4-28
OORTRGSRC FREE .....	4-15	SPRMKRCP .....	4-28
OORTRGSRC IF .....	4-15	SPRMKRED .....	4-28
OORTRGSRC VIDEO .....	4-15	SPRMOD ABS .....	4-29
OORUNIT DBM .....	4-16	SPRMOD MKR .....	4-29
OORUNIT DBUV .....	4-16	SPRMOD REL .....	4-29
OORUNIT W .....	4-16	SPRPKMKY .....	4-29
OORWDO OFF .....	4-15	SPRREF DSP .....	4-29
OORWDO ON .....	4-15	SPRREF MKR .....	4-29
OORWOFPOS .....	4-15	SPRREF MOD .....	4-29
OORWOFWID .....	4-15	SPRREF SWP .....	4-29
OORWONPOS .....	4-15	SPRRES ABS .....	4-29
OORWONWID .....	4-15	SPRRES MKR .....	4-29
OPR .....	4-41	SPRRES REL .....	4-29
PAGECH .....	4-35	SPRSETSTD .....	4-29
PS .....	4-9	SPRTMPL OFF .....	4-27
RATE1200 .....	4-10	SPRTMPL ON .....	4-27
RATE2400 .....	4-10	SPRTMPLBTM .....	4-29
RATE4800 .....	4-10	SPRTMPLCLR .....	4-28
RATE9600 .....	4-10	SPRTMPLCP .....	4-28
RATIO .....	4-16	SPRTMPLDX .....	4-28
RB .....	4-8	SPRTMPLED .....	4-28
RC file name .....	4-9	SPRTMPLPW OFF .....	4-29
RC REG_nn .....	4-9	SPRTMPLPW ON .....	4-29
RCLTBL .....	4-17	SPRTMPLSX .....	4-27

SPRTMPLSY.....	4-27	TDPWDO ON .....	4-12
SPRUNIT DBM.....	4-28	TDPWPOS.....	4-12
SPRUNIT DBUV .....	4-28	TDPWWID.....	4-12
SPRUNIT W .....	4-28	TDSAUTOLVL.....	4-17
SPULVL .....	4-19	TDSAVG .....	4-18
SPUR .....	4-18	TDSCLR .....	4-17
ST.....	4-8	TDSDET NEG.....	4-18
SV file name .....	4-9	TDSDET NRM.....	4-18
SV REG_mn .....	4-9	TDSDET POS.....	4-18
SVSTBL.....	4-17	TDSDET SMP.....	4-18
SW .....	4-8	TDSJDG OFF .....	4-18
TDPAUTOLVL .....	4-11	TDSJDG ON.....	4-18
TDPAVG .....	4-13	TDSL D .....	4-17
TDPDET NEG.....	4-14	TDSMEAS.....	4-18
TDPDET NRM.....	4-13	TDSMULTI .....	4-18
TDPDET POS.....	4-13	TDSPKMKY .....	4-18
TDPDET SMP .....	4-14	TDSPRE 16G.....	4-18
TDPDIV P10DB .....	4-12	TDSPRE 36G.....	4-18
TDPDIV P2DB .....	4-12	TDSRES PK .....	4-18
TDPDIV P5DB .....	4-12	TDSRES RMS .....	4-18
TDPJDG OFF .....	4-14	TDSSETSTD .....	4-18
TDPJDG ON.....	4-14	TDSSV.....	4-17
TDPJDGLOW .....	4-14	TDSTBL .....	4-17
TDPJDGUP .....	4-14	TDSTBLE D.....	4-17
TDPMEAS.....	4-14	TDSTBLF ABS .....	4-17
TDPSETSTD .....	4-14	TDSTBLF REL .....	4-17
TDPTMPL OFF.....	4-13	TDSTRGDT .....	4-17
TDPTMPL ON .....	4-13	TDSTRGLVL .....	4-17
TDPTMPLBTM.....	4-14	TDSTRGPOS .....	4-17
TDPTMPLCLR .....	4-13	TDSTRGSLP FALL.....	4-17
TDPTMPLCP .....	4-13	TDSTRGSLP RISE .....	4-17
TDPTMPLED.....	4-13	TDSTRGSRC EXT .....	4-17
TDPTMPLPW OFF.....	4-14	TDSTRGSRC FREE .....	4-17
TDPTMPLPW ON .....	4-14	TDSTRGSRC IF.....	4-17
TDPTMPLSEL LOW .....	4-13	TDSUNIT DBM .....	4-18
TDPTMPLSEL UP.....	4-13	TDSUNIT DBUV .....	4-18
TDPTMPLSX .....	4-13	TDSUNIT W .....	4-18
TDPTMPLSY .....	4-13	TGTDET NEG.....	4-19, 4-25
TDPTRGDT.....	4-12	TGTDET NRM.....	4-19, 4-25
TDPTRGLVL .....	4-12	TGTDET POS .....	4-19, 4-25
TDPTRGPOS.....	4-12	TGTDET SMP.....	4-19, 4-25
TDPTRGSLP FALL .....	4-12	TGTPOS .....	4-19, 4-25
TDPTRGSLP RISE .....	4-12	TGTSETUP OFF .....	4-19, 4-24
TDPTRGSRC EXT.....	4-12	TGTSETUP ON.....	4-19, 4-24
TDPTRGSRC FREE.....	4-11	TGTSRC EXT .....	4-19, 4-25
TDPTRGSRC IF.....	4-12	TGTSRC TRG .....	4-19, 4-25
TDPTRGSRC VIDEO.....	4-12	TGTSWP OFF .....	4-20, 4-25
TDPUNIT DBM .....	4-14	TGTSWP ON.....	4-20, 4-25
TDPUNIT DBUV .....	4-14	TGTTRG EXT.....	4-19, 4-25
TDPUNIT W.....	4-14	TGTTRG FREE.....	4-19, 4-24
TDPWDO OFF .....	4-12	TGTTRG IF .....	4-19, 4-25

4.1 GPIB Command Index

TGTTRG VIDEO .....	4-19, 4-25	WFGTYP ICHEYE .....	4-37
TGTTRGDT .....	4-19, 4-25	WFGTYP IQCHEYE .....	4-37
TGTTRGLVL .....	4-19, 4-25	WFGTYP ME.....	4-37
TGTTRGPOS .....	4-19, 4-25	WFGTYP NCON .....	4-37
TGTTRGSLP FALL.....	4-19, 4-25	WFGTYP NCONDOT .....	4-37
TGTTRGSLP RISE .....	4-19, 4-25	WFGTYP NCONLIN.....	4-37
TGTWID.....	4-19, 4-25	WFGTYP NCONLINDOT.....	4-37
TLMASFT .....	4-13	WFGTYP NICHEYE .....	4-37
TLMDEL .....	4-13	WFGTYP NIQCHEYE .....	4-37
TLMIN.....	4-13	WFGTYP NQCHEYE.....	4-37
TLMSFT .....	4-13	WFGTYP PHAERR .....	4-37
TLMT OFF .....	4-13	WFGTYP QCHEYE.....	4-37
TLMT ON.....	4-13	WFIQOFS.....	4-32
TMESFLT NARW .....	4-36	WFMAG .....	4-32
TMESFLT WIDE .....	4-36	WFMOD .....	4-33
TRFCCH.....	4-35	WFPHSE .....	4-32
TRGDT .....	4-12	WFPNOFS .....	4-33
TRGLVL.....	4-12	WFQUA.....	4-32
TRGPOS .....	4-12	WFRHO.....	4-32
TRGSLP FALL.....	4-12	WFRNG EXP.....	4-32
TRGSLP RISE.....	4-12	WFRNG NORM .....	4-32
TRGSRC EXT .....	4-12	WFTAU .....	4-32
TRGSRC FREE .....	4-11	WMMOD NZERO .....	4-31
TRGSRC IF .....	4-12	WMMOD PILOT .....	4-31
TRGSRC VIDEO .....	4-12	WMRNG .....	4-31
TRSPMD EXT.....	4-17	WPNMOD OFF.....	4-32
TRSPMD FREE.....	4-17	WPNMOD ON .....	4-32
TRSPMD IF .....	4-17	WPNOFS .....	4-32
TRSPSLP FALL .....	4-17	WTOFS DFLT.....	4-31
TRSPSLP RISE .....	4-17	WTOFS USER .....	4-31
TTRGDLY .....	4-36	WTOFSDT .....	4-31
TTRGSLP FALL .....	4-36	WTRGDLY .....	4-32
TTRGSLP RISE .....	4-36	WTRGSLP FALL.....	4-32
TTRGSRC EXT.....	4-36	WTRGSLP RISE.....	4-32
TTRGSRC INT .....	4-36	WTRGSRC EXT .....	4-32
TTRGSRC INTRVL1.....	4-36	WTRGSRC INT .....	4-32
TWDO OFF .....	4-12	WTRGSRC INTRVL1 .....	4-32
TWDO ON.....	4-12	WTRGSRC INTRVL2 .....	4-32
TWDX .....	4-12		
TWLX.....	4-12		
US .....	4-40		
VA.....	4-8		
VB.....	4-8		
WEQFLT OFF.....	4-32		
WEQFLT ON .....	4-32		
WFCFER .....	4-32		
WFGTYP CON.....	4-36		
WFGTYP CONDOT .....	4-37		
WFGTYP CONLIN .....	4-37		
WFGTYP CONLINDOT.....	4-37		
WFGTYP EVM .....	4-37		

## 4.2 GPIB Command Codes

The following table list the GPIB commands by function.

**Table 4-1 Operating Mode**

Function		Listener Code	Talker Request	
			Code	Output Format
Operating mode	Spectrum analyzer mode	SETFUNC CW	SETFUNC?	0: Spectrum analyzer 1: TRANSIENT
	TRANSIENT mode	SETFUNC TRAN		
Communication system *1	WCDMA mode	COMMSYS WCDMA	COMMSYS?	1:WCDMA
	IS-95 mode	COMMSYS IS95		2:IS-95
	PDC mode	COMMSYS PDC		3:PDC
	PHS mode	COMMSYS PHS		4:PHS
	IS-136 mode	COMMSYS IS136		5:IS-136

\*1: Lisnter code is available only when the analyzer is set to the CW mode. The codes within the talker request are available for both the CW and TRANSIENT modes.

**Table 4-2 ATT Key (Attenuator)**

Function		Listener Code	Talker Request	
			Code	Output Format
Attenuator	AT	AT *	AT?	Level
	ATT AUTO	AA	AA?	0: MNL 1: AUTO
	Min. ATT Min. ATT ON OFF	ATMIN * ATMIN ON [*] ATMIN OFF	ATMIN? ATMINON?	Level 0: OFF 1: ON

**Table 4-3 COPY Key (Hard Copy)**

Function		Listener Code	Talker Request	
			Code	Output Format
Printer or file output	Execution of the command	HCOPY	-	-

4.2 GPIB Command Codes

**Table 4-4 COUPLE Key (Couple Function)**

Function		Listener Code	Talker Request	
			Code	Output Format
Couple function	RBW	RB *	RB?	Frequency
	RBW AUTO	BA	BA?	0: MNL 1: AUTO
	VBW	VB *	VB?	Frequency
	VBW AUTO	VA	VA?	0: MNL 1: AUTO
	Sweep Time	SW * ST *	SW? ST?	Time
	Sweep Time Auto	AS	AS?	0: MNL 1: AUTO

**Table 4-5 FREQ Key (Frequency)**

Function		Listener Code	Talker Request	
			Code	Output Format
Frequency	Center frequency	CF *	CF?	Frequency
	Start frequency	FA *	FA?	Frequency
	Stop frequency	FB *	FB?	Frequency

**Table 4-6 LEVEL Key**

Function		Listener Code	Talker Request	
			Code	Output Format
Reference level	Reference level	RL *	RL?	Level

**Table 4-7 MKR key**

Function		Listener Code	Talker Request	
			Code	Output Format
Marker	ΔMarker ON	MKD [*]	-	Frequency (Time)
	OFF	MKOFF MO	- -	- -
	Reading marker frequency (time)	-	MF?	Frequency (Time)
	Reading marker level	-	ML?	Level
	Reading marker frequency (time) and marker level	-	MFL?	Frequency (Time), Level
	Normal marker	MK [*] MKN [*]	- -	Frequency (Time)
	Peak search	PS	-	-

**Table 4-8 PRESET Key(Initialization)**

Function		Listener Code	Talker Request	
			Code	Output Format
Preset	Instrument preset	IP	-	-

**Table 4-9 RCL Key (Reading Data)**

Function		Listener Code	Talker Request	
			Code	Output Format
Recall		RC REG_nn	-	nn: 01 to 10
		RC file name	-	file name:Max 8 strings

**Table 4-10 SAVE Key (Saving Data)**

Function		Listener Code	Talker Request	
			Code	Output Format
Save	Save	SV REG_nn	-	nn: 01 to 10
		SV file name	-	file name:Max 8 strings
	Deletion	DEL REG_nn	-	nn: 01 to 10
		DEL file name	-	file name:Max 8 strings

**Table 4-11 SPAN Key (Frequency Span)**

Function		Listener Code	Talker Request	
			Code	Output Format
Frequency span		SP *	SP?	Frequency

4.2 GPIB Command Codes

**Table 4-12 TRANSIENT Key**

Function		Listener Code	Talker Request		Remarks
			Code	Output Format	
STD Setup	Communication System				
	800MHz band	MODTYP CDMA800M	MODTYP?	0:CDMA (800MHz band)	
	1.8GHz band	MODTYP CDMA1700M		1:CDMA (1.8GHz band)	
	1.9GHz band	MODTYP CDMA1900M		2:CDMA (1.9GHz band)	
	Japan	MODTYP CDMAJA- PAN		3:CDMA (JAPAN)	
	China	MODTYP CDMACHINA		4:CDMA (CHINA)	
	Link				
	FORWARD REVERSE	LINK FWD LINK REV	LINK?	0:FORWARD 1:REVERSE	
Transfer rate					
9600/14400	RATE9600	RATE?	0:9600/14400		
4800/7200	RATE4800		1:4800/7200		
2400/3600	RATE2400		2:2400/3600		
1200/1800	RATE1200		3:1200/1800		
Offset Level	RO *	RO?	Level		
Frequency setting mode					
Frequency entry mode	FINPMD FREQ	FINPMD?	0:Frequency		
Channel entry mode	FINPMD CHL		1:Channel input		
Channel setting	CH *	CH?	Integer (Channel number)		
Channel Edit					
Input #1 (FORWARD )	CHEDFR1 *,*,*,*	CHEDFR1?	ch1,ch2,f1,f2,chof		
Input #2 (FORWARD )	CHEDFR2 *,*,*,*	CHEDFR2?	ch1,ch2,f1,f2,chof		
Input #3 (FORWARD )	CHEDFR3 *,*,*,*	CHEDFR3?	ch1,ch2,f1,f2,chof		
Input #1 (REVERSE )	CHEDRV1 *,*,*,*	CHEDRV1?	ch1,ch2,f1,f2,chof		
Input #2 (REVERSE )	CHEDRV2 *,*,*,*	CHEDRV2?	ch1,ch2,f1,f2,chof		
Input #3 (REVERSE )	CHEDRV3 *,*,*,*	CHEDRV3?	ch1,ch2,f1,f2,chof		



Table 4-12 TRANSIENT Key

Function	Listener Code	Talker Request		Remarks	
		Code	Output Format		
STD Setup			ch1:Start channel no. ch2:Stop channel no. f1:Base frequency(Hz) f2:Channel space(Hz) chof:Channel offset	Units of frequency are necessary for f1 and f2.	
	Selection of ENABLE or DISABLE for channel table				
	#1 ENABLE	CHTBL1 ENBL	CHTBL1?		0:Disable
	DISABLE	CHTBL1 DSBL			1:Enable
	#2 ENABLE	CHTBL2 ENBL	CHTBL2?		0:Disable
	DISABLE	CHTBL2 DSBL			1:Enable
	#3 ENABLE	CHTBL3 ENBL	CHTBL3?		0:Disable
	DISABLE	CHTBL3 DSBL			1:Enable
	Channel Copy from STD	CHSETSTD			
	Input				
RF	INPUT RF	INPUT?	0:RF		
Baseband(I&Q)	INPUT IQ		1:Baseband(I&Q)		
BaseBand Input					
AC	BBINPUT AC	BBINPUT?	0:AC		
DC	BBINPUT DC		1:DC		
IQ Inverse					
NORMAL	IQMD NORM	IQMD?	0:NORMAL		
INVERSE	IQMD INV		1:INVERSE		
Auto Level setting					
Auto Level OFF	ALS OFF	ALS?	0:OFF		
Auto Level ON	ALS ON		1:ON		
DC CAL	CLDC				
T-Domain Power	Auto Level Set	AUTOWFL TDPAUTOLVL			
	Trigger Setup				
Trigger Source					
FREERUN	TRGSRC FREE	TRGSRC?	0:FREERUN		
	TDPTRGSRC FREE	TDPTRGSRC?	1:VIDEO		

4.2 GPIB Command Codes

**Table 4-12 TRANSIENT Key**

Function	Listener Code	Talker Request		Remarks	
		Code	Output Format		
T-Domain Power	VIDEO	TRGSRC VIDEO TDPTRGSRC VIDEO		2:IF 3:EXT	
	IF	TRGSRC IF TDPTRGSRC IF			
	EXT	TRGSRC EXT TDPTRGSRC EXT			
	Trigger Slope				
	+	TRGSLP RISE TDPTRGSLP RISE	TRGSLP? TDPTRGSLP?	0:- 1:+	
	-	TRGSLP FALL TDPTRGSLP FALL			
	Trigger Level	TRGLVL * TDPTRGLVL *	TRGLVL? TDPTRGLVL?	Integer (0 to 100)	
	Trigger Position	TRGPOS * TDPTRGPOS *	TRGPOS? TDPTRGPOS?	Integer (0 to 100)	
	Trigger Delay	TRGDT * TDPTRGDT *	TRGDT? TDPTRGDT?	Time	
	Window Setup				
Window					
ON	TDPWDO ON TWDO ON	TDPWDO? TWDO?	0:OFF 1:ON		
OFF	TDPWDO OFF TWDO OFF				
Window Position	TDPWPOS * TWLX *	TDPWPOS? TWLX?	Time		
Window Width	TDPWWID * TWDX *	TDPWWID? TWDX?	Time		
Y Scale					
10dB/div	TDPDIV P10DB	TDPDIV?	0:10dB/div		
5dB/div	TDPDIV P5DB		1: 5dB/div		
2dB/div	TDPDIV P2DB		2: 2dB/div		

Table 4-12 TRANSIENT Key

Function	Listener Code	Talker Request		Remarks	
		Code	Output Format		
T-Domain Power	Average Times	TDPAVG *	TDPAVG?	Integer (1:OFF,2 to 999)	
		CAVGAT *	CAVGAT?	Integer (1:OFF,2 to 999)	
	Template				
	Template				
	ON	TDPTMPL ON TLMT ON	TDPTMPL? TLMT?	0:OFF 1:ON	
	OFF	TDPTMPL OFF TLMT OFF			
	Template Shift				
	Shift X	TDPTMPLSX * TLMSFT *	TDPTMPLSX? TLMSFT?	Time Time	
	Shift Y	TDPTMPLSY * TLMASFT *	TDPTMPLSY? TLMASFT?	Level Level	
	Template Edit				
Template UP/LOW select	TDPTMPLSEL UP TDPTMPLSEL LOW	TDPTMPLSEL?	0:UP 1:LOW		
Copy from STD	TDPTMPLCP LMCPSL STD				
Data entry	TDPTMPLED *,* TLMIN *,*		t1,l1 t1:Time l1:Level (dBm/W/dBμV)		
Init Table	TDPTMPLCLR TLMDEL				
Parameter Setup					
Detector					
Normal	TDPDET NRM	TDPDET?	0:Normal		
Posi	TDPDET POS		1:Posi		

4.2 GPIB Command Codes

**Table 4-12 TRANSIENT Key**

Function	Listener Code	Talker Request		Remarks	
		Code	Output Format		
T-Domain Power	Nega	TDPDET NEG		2:Nega	
	Sample	TDPDET SMP		3:Sample	
	Display Unit				
	dBm	TDPUNIT DBM	TDPUNIT?	0:dBm	
	W	TDPUNIT W		1:W	
	dBμV	TDPUNIT DBUV		2:dBμV	
	Template Couple to Power				
	ON	TDPTMPLPW ON	TDPTMPLPW?	0:OFF	
	OFF	TDPTMPLPW OFF		1:ON	
	Template Limit	TDPTMPLBTM *	TDPTMPLBTM?	Level (dBm/W/dBμV)	
	Judgement				
	ON	TDPJDG ON	TDPJDG?	0:OFF	
OFF	TDPJDG OFF		1:ON		
Upper Limit	TDPJDGUP *	TDPJDGUP?	Level		
Lower Limit	TDPJDGLOW *	TDPJDGLOW?	Level		
Set toSTD	TDPSETSTD				
Starts measurement					
T-Domain Power	GATEPOW TDPMEAS				
Starts measurement in the same mode	SI				
Measurement results					
T-Domain Power		TDPMEAS?	11,j1 11:Level (dBm/W/dBmV) j1:Integer (0:FAIL,1:PASS, -1:Judgement OFF)		
		GATEPOW?	11:Level (dBm)		

Table 4-12 TRANSIENT Key

Function	Listener Code	Talker Request		Remarks	
		Code	Output Format		
ON/OFF Ratio	Auto Level Set	OORAUTOLVL AUTOWFL			
	Trigger Setup				
	Trigger Source				
	FREERUN	OORTRGSRC FREE	OORTRGSRC?	0:FREERUN	
	VIDEO	OORTRGSRC VIDEO		1:VIDEO	
	IF	OORTRGSRC IF		2:IF	
	EXT	OORTRGSRC EXT		3:EXT	
	Trigger Slope				
	+	OORTRGSLP RISE	OORTRGSLP?	0:-	
	-	OORTRGSLP FALL		1:+	
	Trigger Level	OORTRGLVL *	OORTRGLVL?	Integer (0 to 100)	
	Trigger Position	OORTRGPOS *	OORTRGPOS?	Integer (0 to 100)	
	Trigger Delay	OORTRGDT *	OORTRGDT?	Time	
	Window Setup				
	Window				
ON	OORWDO ON	OORWDO?	0:OFF		
OFF	OORWDO OFF		1:ON		
ON Position	OORWONPOS *	OORWONPOS?	Time		
ON Width	OORWONWID *	OORWONWID?	Time		
OFF Position	OORWOFPOS *	OORWOFPOS?	Time		
OFF Width	OORWOFWID *	OORWOFWID?	Time		
Y Scale					
10dB/div	OORDIV P10DB	OORDIV?	0:10dB/div		
5dB/div	OORDIV P5DB		1:5dB/div		
2dB/div	OORDIV P2DB		2:2dB/div		
Average Times	OORAVG *	OORAVG?	Integer (1:OFF,2 to 999)		

4.2 GPIB Command Codes

**Table 4-12 TRANSIENT Key**

Function	Listener Code	Talker Request		Remarks	
		Code	Output Format		
ON/OFF Ratio		CAVGRAT *	CAVGRAT?	Integer (1:OFF,2 to 999)	
	Parameter Setup				
	Detector				
	Normal	OORDET NRM	OORDET?	0:Normal	
	Posi	OORDET POS		1:Posi	
	Nega	OORDET NEG		2:Nega	
	Sample	OORDET SMP		3:Sample	
	Display Unit				
	dBm	OORUNIT DBM	OORUNIT?	0:dBm	
	W	OORUNIT W		1:W	
dBμV	OORUNIT DBUV		2:dBμV		
Judgement					
ON	OORJDG ON	OORJDG?	0:OFF		
OFF	OORJDG OFF		1:ON		
Upper Limit	OORJDGUP *	OORJDGUP?	Level		
Set to STD	OORSETSTD				
Starts measurement					
ON/OFF Ratio	OORMEAS RATIO				
Starts measurement in the same mode	SI				
Measurement results					
ON/OFF Ratio		OORMEAS?          RATIO?	i1,i2,d1,j1 i1:ON Level (dBm/W/dBμV) i2:OFF Level (dBm/W/dBμV) d1:ON/OFF Ratio (dB) j1:Integer (0:FAIL,1:PASS, -1:Judgement OFF)		
			d1,i1		

Table 4-12 TRANSIENT Key

Function		Listener Code	Talker Request		Remarks
			Code	Output Format	
ON/OFF Ratio				d1:ON/OFF Ratio (dB) l1:Gated Power (dBm)	
T-Domain Spurious	Auto Level Set	TDSAUTOLVL			
	Trigger Setup				
	Trigger Source				
	FREERUN	TDSTRGSRC FREE TRSPMD FREE	TDSTRGSRC? TRSPMD?	0:FREERUN 2:IF	
	IF	TDSTRGSRC IF TRSPMD IF		3:EXT	
	EXT	TDSTRGSRC EXT TRSPMD EXT			
	Trigger Slope				
	+	TDSTRGSLP RISE TRSPSLP RISE	TDSTRGSLP? TRSPSLP?	0:- 1:+	
	-	TDSTRGSLP FALL TRSPSLP FALL			
	Trigger Level	TDSTRGLVL *	TDSTRGLVL?	Integer (0 to 100)	
	Trigger Position	TDSTRGPOS *	TDSTRGPOS?	Integer (0 to 100)	
	Trigger Delay	TDSTRGDT *	TDSTRGDT?	Time	
Table					
Table No. 1/2/3	TDSTBL *	TDSTBL?	Integer (1 to 3)		
Table Edit	TDSTBLED *,*		f1,l1 f1:Frequency l1:Limit Level		
Load Table	TDSL RCLTBL *		Integer (1 to 3)		
Save Table	TDSSV SVSTBL *		Integer (1 to 3)		
Init Table	TDSCLR DELSTBL				
Table Freq. Input					
ABS	TDSTBLF ABS	TDSTBLF?	0:ABS		
REL	TDSTBLF REL		1:REL		

4.2 GPIB Command Codes

**Table 4-12 TRANSIENT Key**

Function	Listener Code	Talker Request		Remarks
		Code	Output Format	
T-Domain Spurious	Average Times	TDSAVG *	TDSAVG?	Integer (1:OFF,2 to 999)
	Parameter Setup			
	Detector			
	Normal	TDSDET NRM	TDSDET?	0:Normal
	Posi	TDSDET POS		1:Posi
	Nega	TDSDET NEG		2:Nega
	Sample	TDSDET SMP		3:Sample
	Display Unit			
	dBm	TDSUNIT DBM	TDSUNIT?	
	W	TDSUNIT W		
	dBμV	TDSUNIT DBUV		
	Judgement			
	ON	TDSJDG ON	TDSJDG?	0:OFF
	OFF	TDSJDG OFF		1:ON
Result				
Peak	TDSRES PK	TDSRES?	0:Peak	
RMS	TDSRES RMS		1:RMS	
Multiplier	TDSMULTI *	TDSMULTI?	Real number	
Peak Marker Y-Delta	TDSPKMKY *	TDSPKMKY?	Real number	
Preselector 1.6G	TDSPRE 16G	TDSPRE?	0:1.6G	
3.6G	TDSPRE 36G		1:3.6G	
Set to Default	TDSSETSTD			
Starts measurement				
Spurious	TDSMEAS SPUR			
Starts measurement in the same mode	SI			
Measurement results				
Spurious		TDSMEAS?	n<CR+LF>+f1,11,j1<CR+LF> ..... +fn,ln,jn<CR+LF> n:Amount (Integer) fn:Frequency ln:Level (dBm/W/dBμV)	



Table 4-12 TRANSIENT Key

Function	Listener Code	Talker Request		Remarks	
		Code	Output Format		
T-Domain Spurious			jn:Integer (0:FAIL,1:PASS, -1:Judgement OFF)  SPULVL? n<CR+LF>+f1,l1<CR+ LF> ..... +fn,ln<CR+LF>  n:Amount (Integer) fn:Frequency ln:Level (dBm)		
F-Domain Power	Gate Setup  ON OFF  Trigger Source  FREERUN VIDEO IF EXT  Trigger Slope  - +  Trigger Level Trigger Position Trigger Delay  Gate Source Trigger Ext Gate  Gate Position Gate Width  Detector  Normal Posi Nega Sample	TGTSETUP ON TGTSETUP OFF  TGTTRG FREE TGTTRG VIDEO TGTTRG IF TGTTRG EXT  TGTTRGSLP FALL TGTTRGSLP RISE  TGTTRGLVL * TGTTRGPOS * TGTTRGDT *  TGTSRC TRG TGTSRC EXT  TGTPOS * TGTWID *  TGTDET NRM TGTDET POS TGTDET NEG TGTDET SMP	TGTSETUP?  TGTTRG?  TGTTRGSLP?  TGTTRGLVL? TGTTRGPOS? TGTTRGDT?  TGTSRC?  TGTPOS? TGTWID?  TGTDET?  TGTDET?  TGTDET?  TGTDET?	0:OFF 1:ON  0:FREERUN 1:VIDEO 2:IF 3:EXT  0:- 1:+  Integer (0 to 100) Integer (0 to 100) Time  0:Trigger 1:EXT  Time Time  0:Normal 1:Posi 2:Nega 3:Sample	

4.2 GPIB Command Codes

**Table 4-12 TRANSIENT Key**

Function		Listener Code	Talker Request		Remarks
			Code	Output Format	
F-Domain Power	Gated Sweep ON/OFF				
	ON	TGTSWP ON	TGTSWP?	0:OFF	
	OFF	TGTSWP OFF		1:ON	
	Window Setup				
	Window				
	ON	FDPWDO ON	FDPWDO?	0:OFF	
	OFF	FDPWDO OFF		1:ON	
	Window Position	FDPWPOS *	FDPWPOS?	Frequency	
		CPWLX *	CPWLX?		
	Window Width	FDPWWID *	FDPWWID?	Frequency	
		CPWDX *	CPWDX?		
	Y Scale				
	10dB/div	FDPDIV P10DB CPWDIV P10DB	FDPDIV? CPWDIV?	0:10dB/div 1:5dB/div	
	5dB/div	FDPDIV P5DB CPWDIV P5DB		2:2dB/div	
2dB/div	FDPDIV P2DB CPWDIV P2DB				
Average Times	FDPAVG *	FDPAVG?	Integer (1:OFF,2 to 999)		
	CAVGCHP *	CAVGCHP?	Integer (1:OFF,2 to 999)		
Parameter Setup					
Detector					
Normal	FDPDET NRM	FDPDET?	0:Normal		
Posi	FDPDET POS		1:Posi		
Nega	FDPDET NEG		2:Nega		
Sample	FDPDET SMP		3:Sample		
Display Unit					
dBm	FDPUNIT DBM	FDPUNIT?	0:dBm		
W	FDPUNIT W		1:W		
dBμV	FDPUNIT DBUV		2:dBμV		
Judgement					

**Table 4-12 TRANSIENT Key**

Function	Listener Code	Talker Request		Remarks	
		Code	Output Format		
F-Domain Power	ON	FDPJDG ON	FDPJDG?	0:OFF	
	OFF	FDPJDG OFF		1:ON	
	Upper Limit	FDPJDGUP *	FDPJDGUP?	Level (dBm/W/dBμV)	
	Lower Limit	FDPJDGLOW *	FDPJDGLOW?	Level (dBm/W/dBμV)	
	Set to STD	FDPSETSTD			
Starts measurement F-Domain Power	FDPMEAS				
Starts measurement in the same mode	CCHPOW				
Measurement results F-Domain Power	SI				
		FDPMEAS?	11,j1 11:Level (dBm/W/dBmV) j1:Integer (0:FAIL,1:PASS, -1:Judgement OFF)		
			CCHPOW?	11,12 11:Level (dBm) 12:Level (dBm/Hz)	
OBW	OBW%	OBWPER *	OBWPER?	Real number (0.5 to 99.5)	
		COBWPER *	COBWPER?		
	Average Times	OBWAVG *	OBWAVG?	Integer (1:OFF,2 to 999)	
		CAVGOBW *	CAVGOBW?	Integer (1:OFF,2 to 999)	
Parameter Setup					
Detector					
Normal	OBWDET NRM	OBWDET?	0:Normal		
	COBWDET NRM	COBWDET?	1:Posi		
Posi	OBWDET POS		2:Nega		
	COBWDET POS		3:Sample		
Nega	OBWDET NEG				
	COBWDET NEG				

4.2 GPIB Command Codes

Table 4-12 TRANSIENT Key

Function	Listener Code	Talker Request		Remarks	
		Code	Output Format		
OBW	Sample	OBWDET SMP COBWDET SMP			
	Judgement				
	ON	OBWJDG ON	OBWJDG?	0:OFF	
	OFF	OBWJDG OFF		1:ON	
	Upper Limit	OBWJDGUP *	OBWJDGUP?	Frequency	
	Lower Limit	OBWJDGLOW *	OBWJDG- LOW?	Frequency	
	Set to STD	OBWSETSTD			
	Starts measurement				
	OBW	OBWMEAS COBW			
	Starts measurement in the same mode	SI			
Measurement results					
OBW		OBWMEAS?	f1,f2,f3,j1 f1:OBW Frequency f2:Lower side frequency f3:Higher side frequency j1: Frequency (0: FAIL, 1: PASS,-1: Judgement OFF)		
		COBW?	f1,f2,f3 f1:OBW Frequency f2:Lower side frequency f3:Higher side frequency		
Due to Transient	Template				
	Template				
	ON	DTSTMPL ON	DTSTMPL?	0: OFF	
	OFF	DTSTMPL OFF		1: ON	
	Template Shift				
	Shift X	DTSTMPLSX *	DTSTMPLSX?	Frequency	
	Shift Y	DTSTMPLSY *	DTSTMPLSY?	Level	
Margin delta X	DTSTMPLDX *	DTSTMPLDX?	Frequency (0:OFF)		
Copy from STD	DTSTMPLCP				

Table 4-12 TRANSIENT Key

Function	Listener Code	Talker Request		Remarks	
		Code	Output Format		
Due to Transient	Data entry	DTSTMPLED *,*		f1,l1 f1: Frequency l1: Level (dBm/W/dB $\mu$ V)	Set the reference bandwidth to f2, after initializing the table.
	Init Table	DTSTMPLCLR			
	Marker Edit				
	Copy from STD	DTSMKRCP			
	Data entry	DTSMKRED *,*,*,*		d1,f1,f2,l1 d1: (0:Normal 1: Integral) f1: Off set Frequency f2: Band width l1: Limit level	
	Init Table	DTSMKRCLR			
Average Times	DTSAVG *	DTSAVG?	Integer (1:OFF, 2 to 999)		
Parameter Setup					
Detector					
Normal	DTSEDET NRM	DTSEDET?	0: Normal		
Posi	DTSEDET POS		1: Posi		
Nega	DTSEDET NEG		2: Nega		
Sample	DTSEDET SMP		3: Sample		
Display Unit					
dBm	DTSUNIT DBM	DTSUNIT?	0: dBm		
W	DTSUNIT W		1: W		
dB $\mu$ V	DTSUNIT DBUV		2: dB $\mu$ V		
Template Couple to Power					
ON	DTSTMPLPW ON	DTSTMPLPW?	0: OFF		
OFF	DTSTMPLPW OFF		1: ON		
Template Limit	DTSTMPLBTM *	DTSTMPLBTM?	Level (dBm/W/dB $\mu$ V)		

4.2 GPIB Command Codes

Table 4-12 TRANSIENT Key

Function	Listener Code	Talker Request		Remarks	
		Code	Output Format		
Due to Transient	Judgement ON OFF	DTSJDG ON DTSJDG OFF	DTSJDG?	0: OFF 1: ON	
	Frcq. Setting CFSP STSP	DTSFRMD CFSP DTSFRMD STSP	DTSFRMD?	0: Center/Span mode 1: Start/Stop mode	
	Result Type ABS REL MKR	DTSRES ABS DTSRES REL DTSRES MKR	DTSRES?	0: Absolute 1: Relative 2: Marker	
	Reference Power MKR MOD	DTSREF MKR DTSREF MOD	DTSREF?	0: Reference Marker 1: Modulation	
	Set to STD	DTSSETSTD			
	Starts measurement Due to Transient Starts measurement in the same mode	DTSMEAS SI			
	Measurement results Due to Transient		DTSMEAS?  COBWCP?	n<CR+LF>+d1,j1<CR+LF>" ..... +dn,jn<CR+LF> n: Amount (Integer) dn: Power jn: Integer (0: FAIL, 1: PASS,-1: Judgement OFF)  11,i2,d1,d2,d3,d4 11: Level (dBm: Refer- ence power) 12: Level (W: Reference power) d1: -1st ACP(dBc) d2: +1st ACP(dBc) d3: -2nd ACP(dBc) d4: +2nd ACP(dBc)	
Due to Modulation	Gate Setup ON OFF	TGTSETUP ON TGTSETUP OFF	TGTSETUP?	0: OFF 1: ON	
	Trigger Source FREERUN	TGTRG FREE	TGTRG?	0: FREERUN	

Table 4-12 TRANSIENT Key

Function	Listener Code	Talker Request		Remarks
		Code	Output Format	
Due to Modulation	VIDEO	TGTTRG VIDEO		1: VIDEO
	IF	TGTTRG IF		2: IF
	EXT	TGTTRG EXT		3: EXT
	Trigger Slope			
	-	TGTTRGSLP FALL	TGTTRGSLP?	0: -
	+	TGTTRGSLP RISE		1: +
	Trigger Level	TGTTRGLVL *	TGTTRGLVL?	Integer (0 to 100)
	Trigger Position	TGTTRGPOS *	TGTTRGPOS?	Integer (0 to 100)
	Trigger Delay	TGTTRGDT *	TGTTRGDT?	Time
	Gate Source			
	Trigger	TGTSRC TRG	TGTSRC?	0: Trigger
	Ext Gate	TGTSRC EXT		1: EXT
	Gate Position	TGTPOS *	TGTPOS?	Time
	Gate Width	TGTWID *	TGTWID?	Time
	Detector			
	Normal	TGTDET NRM	TGTDET?	0: Normal
	Posi	TGTDET POS		1: Posi
	Nega	TGTDET NEG		2: Nega
	Sample	TGTDET SMP		3: Sample
	Gated Sweep ON/OFF			
ON	TGTSWP ON	TGTSWP?	0: OFF	
OFF	TGTSWP OFF		1: ON	
Template				
Template				
ON	DTMTMPL ON	DTMTMPL?	0: OFF	
OFF	DTMTMPL OFF		1: ON	
Template Shift				
Shift X	DTMTMPLSX *	DTMTMPLSX?	Frequency	
Shift Y	DTMTMPLSY *	DTMTMPLSY?	Level	

4.2 GPIB Command Codes

**Table 4-12 TRANSIENT Key**

Function	Listener Code	Talker Request		Remarks	
		Code	Output Format		
Due to Modulation	Margin delta X	DTMTMPLDX *	DTMTMPLDX?	Frequency (0:OFF)	
	Copy from STD	DTMTMPLCP			
	Data entry	DTMTMPLED *,*		f1,l1 f1: frequency l1: Level (dBm/W/dBμV)	
	Init Table	DTMTMPLCLR			
Marker Edit	Copy from STD	DTMMKRCP			
	Data entry	DTMMKRED *,*,*,*		d1,f1,f2,l1 d1: (0:Normal 1: Integral) f1: Offset Frequency f2: Bandwidth l1: Limit Level	Set the reference bandwidth to f2, after initializing the table.
	Init Table	DTMMKRCLR			
Average Times	DTMAVG *	DTMAVG?	Integer (1:OFF, 2 to 999)		
	CAVGSPR *	CAVGSPR?	Integer (1:OFF, 2 to 999)		
Parameter Setup	Detector				
	Normal	DTMDET NRM	DTMDET?	0: Normal	
	Posi	DTMDET POS		1: Posi	
	Nega	DTMDET NEG		2: Nega	
	Sample	DTMDET SMP		3: Sample	
	Display Unit				
	dBm	DTMUNIT DBM	DTMUNIT?	0: dBm	
	W	DTMUNIT W		1: W	
	dBμV	DTMUNIT DBUV		2: dBμV	
	Template Couple to Power				
ON	DTMTMPLPW ON	DTMTMPLPW?	0: OFF		
OFF	DTMTMPLPW OFF		1: ON		



Table 4-12 TRANSIENT Key

Function	Listener Code	Talker Request		Remarks	
		Code	Output Format		
Due to Modulation	Template Limit	DTMTMPLBTM *	DTMTMPLBTM?	Level (dBm/W/dBμV)	
	Judgement				
	ON	DTMJJDG ON	DTMJJDG?	0: OFF	
	OFF	DTMJJDG OFF		1: ON	
	Freq. Setting				
	CFSP	DTMFRMD CFSP	DTMFRMD?	0: Center/Span mode	
	STSP	DTMFRMD STSP		1: Start/Stop mode	
	Result Type				
	ABS	DTMRES ABS	DTMRES?	0: Absolute	
	REL	DTMRES REL		1: Relative	
MKR	DTMRES MKR		2: Marker		
Reference Power					
MKR	DTMREF MKR	DTMREF?	0: Reference Marker		
MOD	DTMREF MOD		1: Modulation		
Set to STD	DTMSETSTD				
Starts measurement Due to Modulation	DTMMEAS				
Starts measurement in the same mode	SI				
Measurement results Due to Modulation		DTMMEAS?	n<CR+LF>+d1, j1<CR+LF> .....+dn,jn<CR+LF> n:Amount (Integer) dn: Power jn: Integer(0: FAIL, 1: PASS, -1: Judgement OFF)		
Inband Spurious	Template				
	ON	SPRTMPL ON	SPRTMPL?	0: OFF	
	OFF	SPRTMPL OFF		1: ON	
	Template Shift				
Shift X	SPRTMPLSX *	SPRTMPLSX?	Frequency		
Shift Y	SPRTMPLSY *	SPRTMPLSY?	Level		

4.2 GPIB Command Codes

Table 4-12 TRANSIENT Key

Function	Listener Code	Talker Request		Remarks	
		Code	Output Format		
Inband Spurious	Margin delta X	SPRTMPLDX *	SPRTMPLDX?	Frequency (0:OFF)	
	Copy from STD	SPRTMPLCP			
	Data entry	SPRTMPLED *,*		f1,l1 f1: Frequency l1: Level (dBm/W/dBμV)	
	Init Table	SPRTMPLCLR			
	Marker Edit				Set the reference bandwidth to f2, after initializing the table.
	Copy from STD	SPRMKRCP			
	Data entry	SPRMKRED *,*,*,*		d1,f1,f2,l1 d1:(0:Peak, 1:Integral) f1: Start Frequency f2: Stop Frequency l1: Limit Level	
	Init Table	SPRMKRCLR			
	Average Times	SPRAVG *	SPRAVG?	Integer (1:OFF, 2 to 999)	
		CAVGSPR *	CAVGSPR?	Integer (1:OFF, 2 to 999)	
Parameter Setup					
Detector					
Normal	SPRDET NRM	SPRDET?	0: Normal		
Posi	SPRDET POS		1: Posi		
Nega	SPRDET NEG		2: Nega		
Sample	SPRDET SMP		3: Sample		
Display Unit					
dBm	SPRUNIT DBM	SPRUNIT?	0: dBm		
W	SPRUNIT W		1: W		
dBμV	SPRUNIT DBUV		2: dBμV		

**Table 4-12 TRANSIENT Key**

Function	Listener Code	Talker Request		Remarks	
		Code	Output Format		
Inband Spurious	Template Couple to Power ON OFF	SPRTMPLPW ON SPRTMPLPW OFF	SPRTMPLPW?	0: OFF 1: ON	
	Template Limit	SPRTMPLBTM *	SPRTMPLBTM?	Level (dBm/W/dBµV)	
	Judgement ON OFF	SPRJGDG ON SPRJGDG OFF	SPRJGDG?	0: OFF 1: ON	
	Freq. Setting CFSP STSP	SPRFRMD CFSP SPRFRMD STSP	SPRFRMD?	0: Center/Span mode 1: Start/Stop mode	
	Result Type ABS REL MKR	SPRRES ABS SPRMOD ABS SPRRES REL SPRMOD REL SPRRES MKR SPRMOD MKR	SPRRES? SPRMOD?	0: Absolute 1: Relative 2: Marker	
	Reference Power MKR MOD	SPRREF MKR SPRREF SWP SPRREF MOD SPRREF DSP	SPRREF?	0: Reference Marker 1: Modulation	
	Peak Marker Y-Delta	SPRPKMKY *	SPRPKMKY?	Real number	
	Set to STD	SPRSETSTD			
Starts measurement Inband Spurious	SPRMEAS CINBSPR				
Starts measurement in the same mode	SI				
Measurement results Inband Spurious		SPRMEAS?	n<CR+LF>+f1,i1,j1<CR+LF> ..... +fn,ln,jn<CR+LF> n:Amount (Integer)		

4.2 GPIB Command Codes

**Table 4-12 TRANSIENT Key**

Function		Listener Code	Talker Request		Remarks
			Code	Output Format	
Inband Spurious	max.value output on the each period		CINBMAX?	fn: Frequency ln: Level (dBm/W/dBμV) jn: Integer (0: FAIL, 1: PASS, -1: Judgement OFF) n1,f1,l1...n4,f4,l4 (4set output) nn: 0;Disable (Without data) 1: Enable (With data) fn: Frequency ln: Level (dBm)	
Outband Spurious	Table				
	Table No.1/2/3	FDSTBL *	FDSTBL?	Integer (1 to 3)	
	Table Edit	FDSTBLED *,*,*,*,*,*		f1,f2,f3,f4,d1,l1 f1: Start frequency f2: Stop frequency f3: RBW f4: VBW d1: Sweep time l1: Limit Level	
	Load Table	FDSL D			
	Save Table	FDSSV			
	Init Table	FDSCLR			
	Average Times	FDSAVG *	FDSAVG?	Integer (1:OFF, 2 to 999)	
	Parameter Setup				
	Detector				
	Normal	FDSDET NRM	FDSDET?	0: Normal	
Posi	FDSDET POS		1: Posi		
Nega	FDSDET NEG		2: Nega		
Sample	FDSDET SMP		3: Sample		
Display Unit					
dBm	FDSUNIT DBM	FDSUNIT?	0: dBm		
W	FDSUNIT W		1: W		
dBμV	FDSUNIT DBUV		2: dBμV		

Table 4-12 TRANSIENT Key

Function	Listener Code	Talker Request		Remarks
		Code	Output Format	
Outband Spurious	Judgement			
	ON	FDSJDG ON	FDSJDG?	0: OFF
	OFF	FDSJDG OFF		1: ON
	Peak Marker Y-Delta	FDSPKMKY *	FDSPKMKY?	Real number
	Preselector 1.6G	FDSPRE 16G	FDSPRE?	0: 1.6G
	3.6G	FDSPRE 36G		1: 3.6G
Set to Default	FDSSETSTD			
Starts measurement				
Outband Spurious	FDSMEAS			
Starts measurement in the same mode	SI			
Measurement results				
Outband Spurious		FDSMEAS?	n<CR+LF>+f1,l1,j1<CR+LF> +LF> ..... +fn,ln,jn<CR+LF> n:Amount (Integer) fn: Frequency ln: Level (dBm/W/ dBmV) jn: Integer(0: FAIL, 1: PASS,-1: Judgement OFF)	
Wave- form Quality	Auto Level Set	AUTOLVL		
	Parameter Setup			
	Meas Mode			
	Pilot	WMMOD PILOT	WMMOD?	0: Pilot
	Non Zero	WMMOD NZERO		1: Non Zero
	Meas Range	WMRNG *	WMRNG?	Integer 5 to 25 (REVERSE LINK) 615 to 800 (FORWARD LINK)
	$\tau$ Offset			
	Default	WTOFS DFLT	WTOFS?	0: DEFAULT
User	WTOFS USER		1: USER	
$\tau$ offset value	WTOFSDT *	WTOFSDT?	Time (-100.0 to 100.0 $\mu$ sec)	
Equalizing Filter				

4.2 GPIB Command Codes

**Table 4-12 TRANSIENT Key**

Function	Listener Code	Talker Request		Remarks	
		Code	Output Format		
Wave- form Quality	Filter OFF	WEQFLT OFF	WEQFLT?	0: OFF	
	Filter ON	WEQFLT ON		1: ON	
	PN Offset Search mode				
	Search mode OFF	WPNMOD OFF	WPNMOD?	0: OFF	
	Search mode ON	WPNMOD ON		1: ON	
	PN Offset	WPNOFS *	WPNOFS?	Integer (0 to 511)	
	Trigger Source				
	INT	WTRGSRC INT	WTRGSRC?	0: INT	
	EXT	WTRGSRC EXT		1: EXT	
	Interval(EXT)	WTRGSRC INTRVL1		2: Interval(EXT)	
	Interval	WTRGSRC INTRVL2		3: Interval	
	Trigger Slope				
	+	WTRGSLP RISE	WTRGSLP?	0: -	
	-	WTRGSLP FALL		1: +	
	Trigger Delay	WTRGDLY *	WTRGDLY?	Real number (Chip)Å@ -16384 to 16384 Resolution : 0.125	
Freq. Meas. Mode	WFRRNG NORM WFRRNG EXP	WFRRNG?	0: NORM 1: EXP		
Average Times	CAVGWF *	CAVGWF?	Integer (1:OFF, 2 to 32)		
Starts measurement					
Waveform Quality	WFQUA				
Starts measurement in the same mode	SI				
Measurement results					
All result		WFQUA?	d1,d2,d3,d4,d5,d6,d7, d8,d9		
$\rho$		WFRHO?	d1		
$\tau$		WFTAU?	d2,d3		
Carrier Freq. Error		WFCFER?	d4		
Carrier Feedthrough		WFIQOFS?	d5		
Magnitude Error		WFMAG?	d6		
Phase Error		WFPHSE?	d7		

Table 4-12 TRANSIENT Key

Function	Listener Code	Talker Request		Remarks	
		Code	Output Format		
Wave- form Quality	Error Vector Magnitude		WFMOD?	d8	
	PN Offset		WFPNOFS?	d9 d1: $\rho$ d2: Time (sec) d3: Integer (chip) d4: Frequency (chip) d5: Level (dBc) d6: %rms d7: degree rms d8: %rms d9: chip	
Code Domain Power	Auto Level Set	AUTOLVL			
	Scale Setup				
	Format Graph	CFMT GRP	CFMT?	0: Graph	
	Table	CFMT TBL		1: Table	
	Numeric	CFMT NUM		2: Numeric	
	Display				
	Single	CDISP SNGL	CDISP?	0: Single	
	Dual	CDISP DUAL		1: Dual	
	Y Scale				
	Rho	CYSCL RHO	CYSCL?	0: Rho	
Power	CYSCL POW		1: Power		
Tau	CYSCL TAU		2: Tau		
Phase	CYSCL PHA		3: Phase		
Y Scale/div					
20/div	CPDIV P20DB	CPDIV?	0: 20/div		
10/div	CPDIV P10DB		1: 10/div		
5/div	CPDIV P5DB		2: 5/div		
1/div	CPDIV P1DB		3: 1/div		
0.5/div	CPDIV P05DB		4: 0.5/div		
0.25/div	CPDIV P025DB		5: 0.25/div		

4.2 GPIB Command Codes

**Table 4-12 TRANSIENT Key**

Function	Listener Code	Talker Request		Remarks
		Code	Output Format	
Code Domain Power	Parameter Setup			
	Meas Mode			
	PRECISE	CMMOD PREC	CMMOD?	0: Precise
	NORMAL	CMMOD NORM		1: Normal
	Meas Range	CMRNG *	CMRNG?	Integer 5 to 25
	$\tau$ Offset			
	Default	CTOFS DFLT	CTOFS?	0: DEFAULT
	User	CTOFS USER		1: USER
	$\tau$ offset value	CTOFSDT *	CTOFSDT?	Time (-100.0 to 100.0 $\mu$ sec)
	Equalizing Filter			
	Filter OFF	CEQFLT OFF	CEQFLT?	0: OFF
	Filter ON	CEQFLT ON		1: ON
	Threshold	CTHRSH *	CTHRSH?	Level (-40 to -10dB)
	PN Offset Search mode			
	Search mode OFF	CPNMOD OFF	CPNMOD?	0: OFF
	Search mode ON	CPNMOD ON		1: ON
	PN Offset	CPNOFS *	CPNOFS?	Integer (0 to 511)
	Trigger Source			
	INT	CTRGSRC INT	CTRGSRC?	0: INT
	EXT	CTRGSRC EXT		1: EXT
	Interval(EXT)	CTRGSRC INTRVL1		2: Interval(EXT)
	Interval	CTRGSRC INTRVL2		3: Interval
	Trigger Slope			
	+	CTRGSLP RISE	CTRGSLP?	0: -
	-	CTRGSLP FALL		1: +
	Trigger Delay	CTRGDLY *	CTRGDLY?	Real number (Chip) $\hat{A}$ @ -16384 to 16384 Resolution : 0.125
	Phase Unit			
	Degree	CPHUNT DEG	CPHUNT?	0: degree
	Radian	CPHUNT RAD		1: m radian

Unit of level, dB, is necessary.



Table 4-12 TRANSIENT Key

Function	Listener Code	Talker Request		Remarks
		Code	Output Format	
Code Domain Power	Power Unit			
	W	CDPUNT W	CDPUNT?	0: W
	dBm	CDPUNT DBM		1: dBm
	Freq. Meas. Mode	CFRRNG NORM	CFRRNG?	0: NORM
		CFRRNG EXP		1: EXP
	Marker Setup			
Paging Channel	PAGECH *	PAGECH?	Integer (Channel 0 to 63)	
Traffic Channel	TRFCCH *	TRFCCH?	Integer (Channel 0 to 63)	
Average Times	CAVGCDP *	CAVGCDP?	Integer (1:OFF, 2 to 32)	
Starts measurement				
Code Domain Power(Graph)	CDPGPH			
Code Domain Power(Total Result)	CDPRES			
Starts measurement in the same mode	SI			
Measurement results				
All result		CDPRES?	d1,d2,d3,d4,d5,d6,d7,d8	
$\tau$		CDPTAU?	d1,d2	
Carrier Freq. Error		CDPCFER?	d3	
Carrier Feedthrough		CDPIQOFS?	d4	
Magnitude Error		CDPMAG?	d5	
Phase Error		CDPPHSE?	d6	
Error Vector Magnitude		CDPMOD?	d7	
PN Offset		CDPPNOFS?	d8	
			d1: Time (sec)	
			d2: Integer (chip)	
			d3: Frequency (chip)	
			d4: Level (dBc)	
			d5: %rms	
			d6: degree rms	

4.2 GPIB Command Codes

**Table 4-12 TRANSIENT Key**

Function		Listener Code	Talker Request		Remarks
			Code	Output Format	
Code Domain Power	Estimated Rho		CDPRHO?	d7: %rms d8: chip Real number (ρ)	
	Channel maker output		CMKLV?	d1,d2,d3,d4 d1: Pilot channel(dB) d2: Sync. channel(dB) d3: Paging channel(dB) d4: Traffic Channel(dB)	
Tx Power	Auto Level Set	AUTOLVL			
	Parameter Setup				
	Trigger Source				
	INT	TTRGSRC INT	TTRGSRC?	0: INT	
	EXT	TTRGSRC EXT		1: EXT	
	Interval(EXT)	TTRGSRC INTRVL1		2: Interval(EXT)	
	Trigger Slope				
	+	TTRGSLP RISE	TTRGSLP?	0: -	
	-	TTRGSLP FALL		1: +	
	Trigger Delay	TTRGDLY *	TTRGDLY?	Real number (Chip) -16384 to 16384 Resolution : 0.125 chip	
Meas. Filter					
Narrow	TMESFLT NARW	TMESFLT?	0: Narrow		
Wide	TMESFLT WIDE		1: Wide		
Average Times	CTXAVG *	CTXAVG?	Integer (1:OFF, 2 to 32)		
Starts measurement					
Tx Power	CTXPOW				
Starts measurement in the same mode	SI				
Measurement results					
Tx Power		CTXPOW?	d1,d2,d3 d1: Level (dBm) d2: Level (W) d3: Level (dB)		
Graphics Select	Constellation	WFGTYP CON	WFGTYP?	0: Constellation	

Table 4-12 TRANSIENT Key

Function	Listener Code	Talker Request		Remarks	
		Code	Output Format		
Graphics select	Constellation(Line)	WFGTYP CONLIN		1: Constellation(Line)	
	Constellation(Dot)	WFGTYP CONDOT		2: Constellation(Dot)	
	Constellation(Line&Dot)	WFGTYP CONLINDOT		3: Constellation (Line&Dot)	
	I EYE Diagram	WFGTYP ICHEYE		4: I EYE Diagram	
	Q EYE Diagram	WFGTYP QCHEYE		5: Q EYE Diagram	
	I/Q EYE Diagram	WFGTYP IQCHEYE		6: I/Q EYE Diagram	
	E.V.M. vs Chip	WFGTYP EVM		7: E.V.M. vs Symbol	
	Mag. Error vs Chip	WFGTYP MAGERR		8: Mag. Error vs Symbol	
	Phase Error vs Chip	WFGTYP PHAERR		9: Phase Error vs Symbol	
	Null Offset Constellation	WFGTYP NCON		10: Null offset Constellation	
	Null Offset Constellation(Line)	WFGTYP NCONLIN		11: Null offset Constellation(Line)	
	Null Offset Constellation(Dot)	WFGTYP NCONDOT		12: Null offset Constellation(Dot)	
	Null Offset Constellation(Line&Dot)	WFGTYP NCONLINDOT		13: Null offset Constellation(Line&Dot)	
	Null Offset I EYE Diagram	WFGTYP NICHEYE		14: Null offset I EYE Diagram	
	Null Offset Q EYE Diagram	WFGTYP NQCHEYE		15: Null offset Q EYE Diagram	
Null Offset I/Q EYE Diagram	WFGTYP NIQCHEYE		16: Null offset I/Q EYE Diagram		
Data output					
Constellation	I-channel data output		GPHI?	n<CR+LF>+d1 <CR+LF>+ .....+dn<CR+LF>	
Constellation(Line)				n: Amount of output data (Integer)	
Constellation(Dot)				dn: Data (Real number)	

4.2 GPIB Command Codes

Table 4-12 TRANSIENT Key

Function		Listener Code	Talker Request		Remarks
			Code	Output Format	
Constellation(Line & Dot)	Q-channel data output		GPHQ?	n<CR+LF>+d1 <CR+LF>+ .....+dn<CR+LF>	
I EYE Diagram				n: Amount of output data (Integer)	
Q EYE Diagram				dn: Data (Real number)	
I/Q EYE Diagram					
I EYE Diagram	X data (Chip)		GPHCHIP?	n<CR+LF>+d1 <CR+LF>+ .....+dn<CR+LF>	
Q EYE Diagram			GPHX?	n: Amount of output data (Integer)	
I/Q EYE Diagram			dn: Chip data (Integer)		
E.V.M. vs Symbol	X data (Chip)		GPHCHIP?	n<CR+LF>+d1 <CR+LF>+ .....+dn<CR+LF>	
Mag. Error vs Symbol			GPHX?	n: Amount of output data (Integer)	
Phase Error vs Symbol			dn: Chip data (Integer)		
	Y data (Chip)		GPHY?	n<CR+LF>+d1 <CR+LF>+ .....+dn<CR+LF>	
			n: Amount of output data (Integer)		
	dn: Data (Integer)				
Code Domain Power	X data (Channel)		GPHCH?	n<CR+LF>+d1 <CR+LF>+ .....+dn<CR+LF>	
				n: Amount of output data (Integer)	
				dn: Channel $\hat{\Lambda}$ @(Integer)	

Table 4-12 TRANSIENT Key

Function	Listener Code	Talker Request		Remarks
		Code	Output Format	
Code Doman Power	Y data (Rho)		GPHRHO?	n<CR+LF>+d1 <CR+LF>+ .....+dn<CR+LF>  n: Amount of output data (Integer)  dn: Rho (Real number)
	Y data (Power)		GPHPOW?	n<CR+LF>+d1 <CR+LF>+ .....+dn<CR+LF>  n: Amount of output data (Integer)  dn: Level (dB) (Real number)
	Y data (Tau)		GPHTAU?	n<CR+LF>+d1 <CR+LF>+ .....+dn<CR+LF>  n: Amount of output data (Integer)  dn: Tau(sec) (Real number)
	Y data (Phase)		GPHPHA?	n<CR+LF>+d1 <CR+LF>+ .....+dn<CR+LF>  n: Amount of output data (Integer)  dn: $\theta$ (degree/m rad)(Real number)
	Y data (Walsh Power)		GPHWSH?	n<CR+LF>+d1 <CR+LF>+ .....+dn<CR+LF>  n: Amount of output data (Integer)  dn: Level (W/dBm) (Real number)

4.2 GPIB Command Codes

**Table 4-13 Numeric keys/Step keys/Data knob/Unit keys (Entering data)**

Function	Listener Code	Talker Request		
		Code	Output Format	
Entering data	0 to 9	0 to 9	---	---
	. (Decimal point)	.	---	---
	GHz	GZ	---	---
	MHz	MZ	---	---
	kHz	KZ	---	---
	Hz	HZ	---	---
	mV	MV	---	---
	mW	MW	---	---
	dB	DB	---	---
	mA	MA	---	---
	sec	SC	---	---
	ms	MS	---	---
	μs	US	---	---
	ENTER	ENT	---	---

Table 4-14 Miscellaneous

Function	Listener Code	Talker Request		
		Code	Output Format	
Miscellaneous	Outputting error number	—	ERRNO?	Integer
	Local	LC	—	—
	Reading GPIB address	—	AD?	Integer (0 to 30)
	Specification of the delimiter CR LF <EOI>	DL0	—	—
	LF	DL1	—	—
	<EOI>	DL2	—	—
	CR LF	DL3	—	—
	LF <EOI>	DL4	—	—
	Service request interruption ON	S0	—	—
	OFF	S1	—	—
	Status clear	S2	—	—
	Service request mask	RQS *	RQS?	Decimal number corresponding to the SRQ bit
	Outputting ID of the instrument	—	*IDN?	Manufacturer name (character string), instrument type (character string), 0 and revision (character string)
	Initializing the instrument	*RST	—	—
	Clearing the queues related to the status byte	*CLS	—	—
	Accessing the standard event enable register	*ESE	*ESE?	Decimal number corresponding to the register bits
	Reading or clearing the standard event enable register	—	*ESR?	Decimal number corresponding to the register bits
	Accessing the service request enable register	*SRE	*SRE?	Decimal number corresponding to the register bits
	Reading the status byte and MSS bit	—	*STB?	Decimal number corresponding to the status byte
	Accessing the operation status enable register	OPR *	OPR?	Decimal number corresponding to the register bits
	Reading or clearing the operation status register	—	OPREVT?	Decimal number corresponding to the register bits





## 5 TECHNICAL NOTES

### 5.1 Waveform Quality measurement of Modulation Signal

The signal to be measured in Pilot mode assumes the following signals.

- (1) In Forward Link mode

The Pilot signal output from the BTS is assumed to be the object.

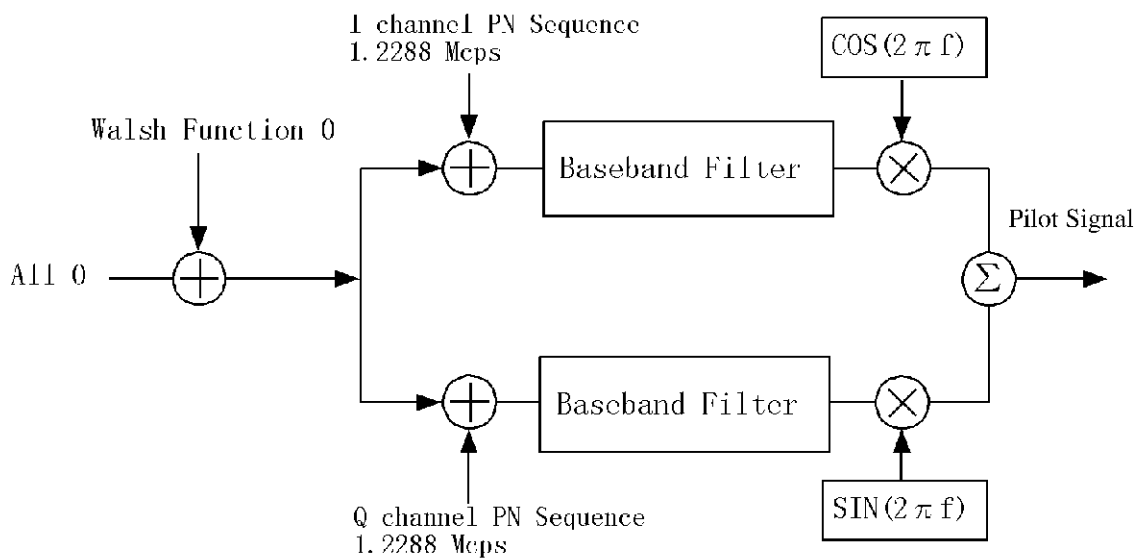

Figure 5-1 Forward Link

The trigger signal placed at the head of I/Q Channel Pilot PN Sequence is input to R3267 Series as the external trigger signal.

The time drift between the trigger signal and the head of I/Q Channel Pilot PN Sequence, Obtained from the Pilot signal input to R3267 Series, is calculated as  $\tau$ .

5 TECHNICAL NOTES

(2) In Reverse Link mode

The test signal output from the MS is assumed to be the object.

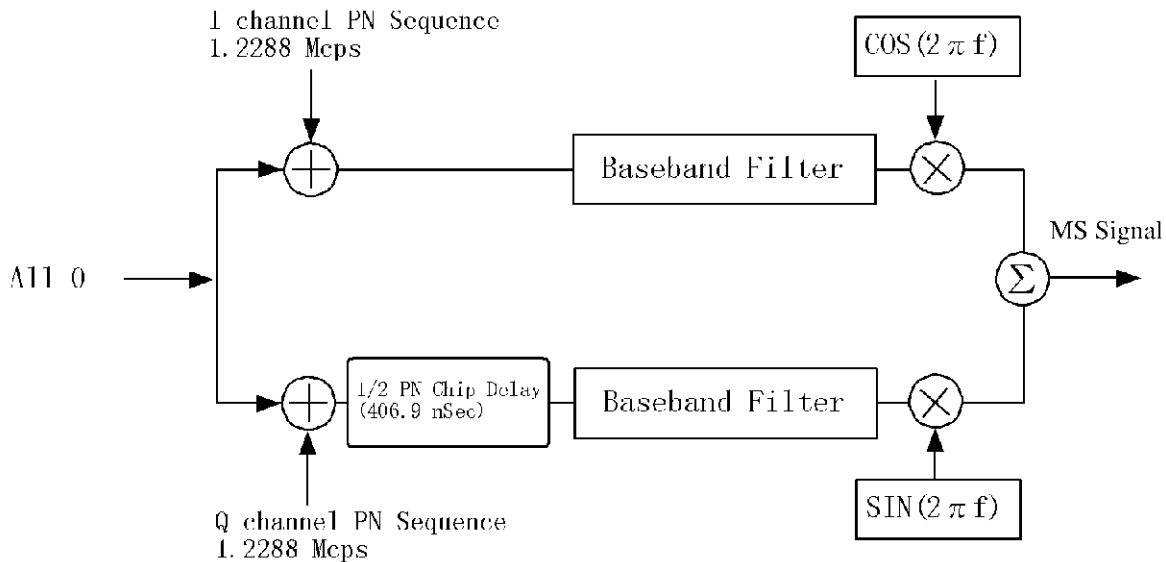

Figure 5-2 Reverse Link

The trigger signal placed at the head of I/Q Channel Pilot PN Sequence is input to R3267 Series as external trigger signal.

The time drift between the trigger signal and the head of I/Q Channel Pilot PN Sequence, obtained from the Pilot signal input to R3267 Series, is calculated as  $\tau$ .

5.2 About Equalizing Filter

According to IS-95 7.1.3.1.11.2 Phase Characteristics, the base station must equalize the signal phase outputs using the Equalizing Filter. This is defined by the following formula.

$$H(\omega) = k \frac{\omega^2 + j \alpha \omega \omega_0 - \omega_0^2}{\omega^2 - j \alpha \omega \omega_0 - \omega_0^2}$$

$k$	: Arbitrary gain
$j$	: $\sqrt{-1}$
$\alpha$	: 1.36
$\omega_0$	: $2\pi \times 3.15 \times 10^5$
$\omega$	: Radian frequency

When a signal sent from the base station passes through the Equalizing Filter, the R3267 Series can analyze the waveform using a filter with the inverted characteristics of the Equalizing Filter.

To do this, set the Equalizing Filter setting in the Parameter Setup soft menu to ON.

To analyze a signal which is not passing through the Equaling Filter, set the Filter to OFF.

### 5.3 Null Offset Graph

In Reverse Link mode, the analyzer has graph display functions, such as a Null Offset Constellation and Null Offset I(Q) Eye to display graphs obtained in Waveform Quality measurement mode.

In this mode, Constellation graphs do not converge to a point, because Offset QPSK modulation method is used.

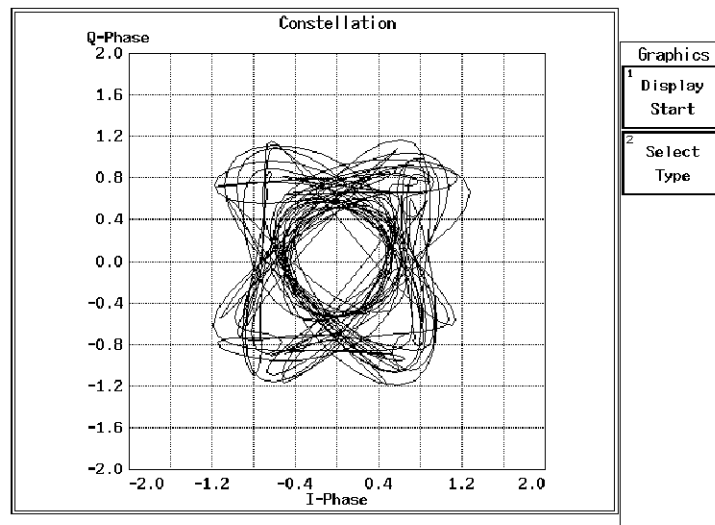

Figure 5-3 Reverse Link Constellation

QPSK Constellation graph can be converged to a point as shown in Figure 5-4 after the effect of the Offset QPSK function has been cancelled and the signal is then passed through a baseband filter whose characteristics are inverse to the filter compliant with IS-95. The graph obtained through this method is referred to as Null Offset Constellation.

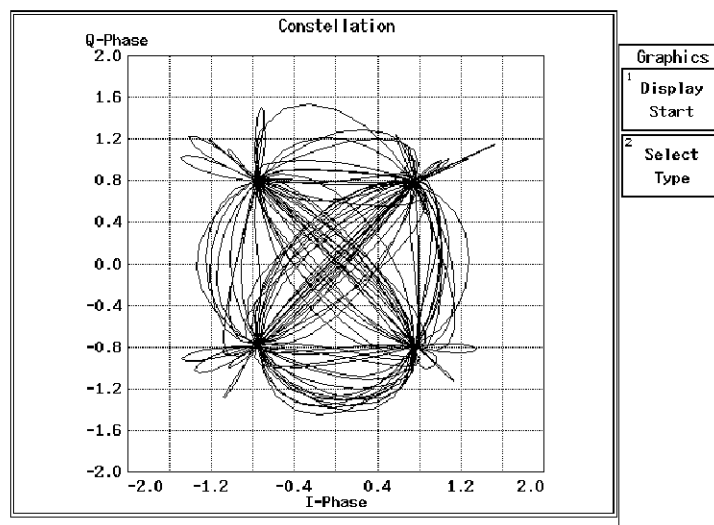

Figure 5-4 Null Offset Constellation

---

5 TECHNICAL NOTES

---

*NOTE: Because of the interference between two adjacent symbols, the constellation graph cannot be converged to a point, even if the offset value is shifted using the Offset QPSK function*

---

#### **5.4 Displaying the Absolute Power**

The Absolute power which is displayed in the code domain power measurement function is the power of the symbol point, and does not necessarily coincide with the power measured by the power meter or the Tx power measurement mode.

The code domain power is defined at symbol points, therefore, the absolute power displayed on this measurement is the power of the symbol points

#### **5.5 Estimated $\rho$ in the Code Domain Power Measurement**

For the estimated  $\rho$  measurement, the instrument sum each the  $\rho$  of the Walsh channel that is greater than the threshold level set by Parameter Setup.

#### **5.6 Peak Factor of Tx Power**

The calculation of a peak factor is made using the following equation:

Peak Factor = Peak power/Average power.

The peak power and average power are obtained from the envelope after down-converting the input signal into the base band.

Make sure the RF status of the input signal is not the peak power of IF.

## 5.7 Trigger Source INTVL (EXT) and INTVL

The instrument has the internal trigger generated every 26.6 milliseconds (PN Sequence repetition rate). For this internal trigger, there are two modes: one sets the trigger to Free Run state and the other makes the signal synchronize with the external trigger.

In the Waveform Quality and Code Domain Power measurements, the Even Second signals generated every 2 seconds are normally used as the external trigger, while the measurement refresh rate can be made faster than 2 seconds when Trigger Source is set to INTVL (EXT).

In addition, measurement is possible without using the external trigger signal if you measure the PN Offset in INTRVL trigger mode and set the measured value. If this happens, however, the PN Offset drift occurs in a long measurement because of the frequency reference error.

It is possible to prevent the drift from occurring by applying the 10 MHz reference signal in synchronization with the DUT signal to the instrument. (For more information, refer to Chapter 2 "Measurement Example 2.")

## 5.8 Template Edit Function

In TRANSIENT mode, the user can change template. It is necessary to pay attention when entering template, because the data can be interpreted as a relative or absolute value, depending on the setting of Template Couple to Power ON/OFF in the Config menu.

The PASS/FAIL judgment is performed and then the result is displayed on the screen, when Template ON/OFF in the Template menu is set to ON.

### 5.8.1 Template Setting in the T-Domain Measuring Mode

When Template Couple to Power is set to OFF, template (Y axis data) is interpreted as an absolute value. As a result, the template consists of the data you entered.

Use the Shift X/Y keys to adjust the template position over the measured value.

When Template Couple to Power is set to ON, template (Y axis data) is interpreted as a relative value to the average power.

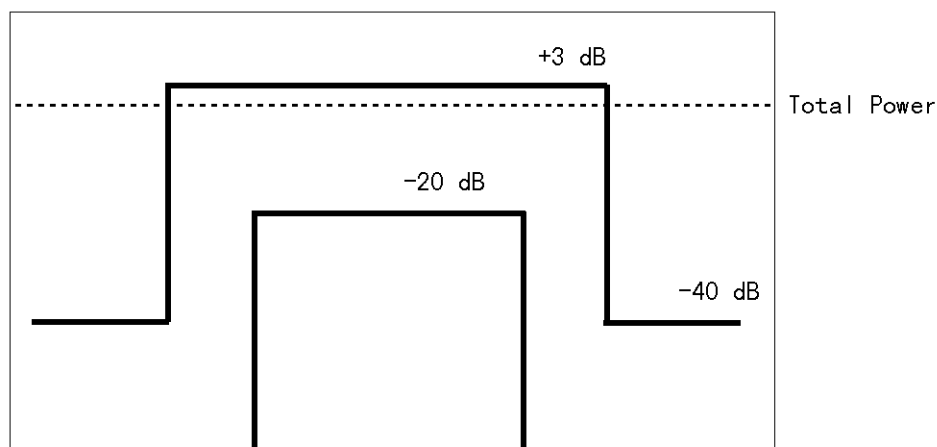

Figure 5-5 Template to Be Set

5 TECHNICAL NOTES

For example, the above template gives +3 dB and -40 dB of the power during the burst period of the signal. To prepare this template, follow the procedure shown below.

Set the template using the relative value to the average power.

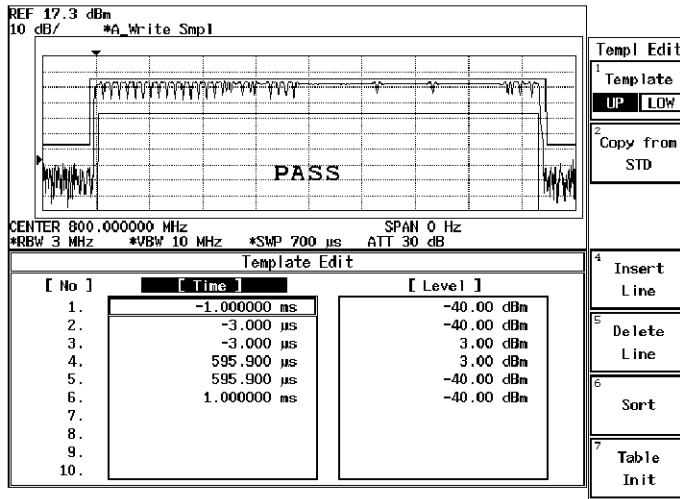

Figure 5-6 Template settings

When you shift the template to the direction of Y axis using Shift X/Y function while the Template Couple to Power is set to ON, the relative value to the average power is: Relative value (set on the template) + Shifted data on Y axis.

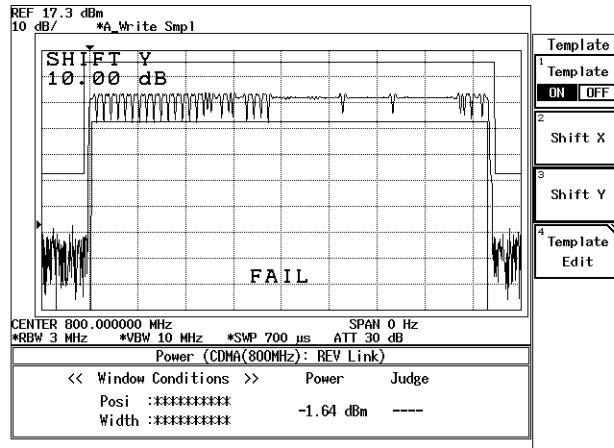

Figure 5-7 Template Shifted Using the Shift Y Function

### 5.8.2 Template Setting in the F-Domain Measuring Mode

In F-Domain measurement mode, the carrier frequencies depend on the channel numbers. As a result, use the offset frequency from the carrier frequency for template's X axis data.

Set the carrier frequency on the template to 0 Hz so that you can use plus or minus values for the offset frequencies.

The analyzer sets the template by adding the center frequency currently used to X value.

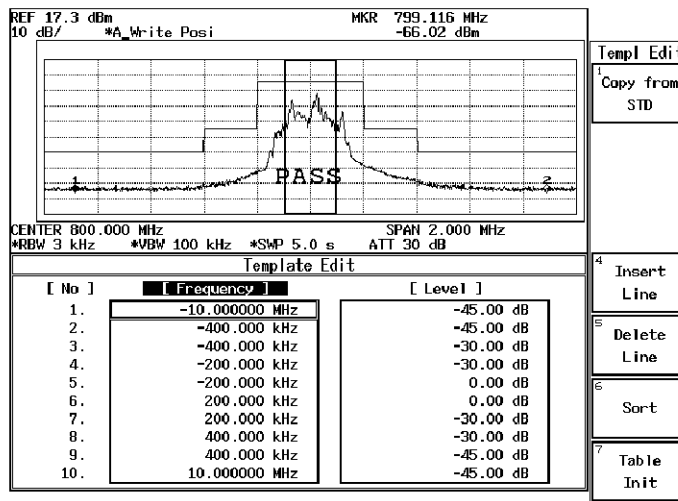

Figure 5-8 Template with the Set Values

Soft menu Margin delta X expands the template frequency by  $\Delta X/2$  to both sides (toward plus and minus frequency directions) from the 0 Hz on the template.

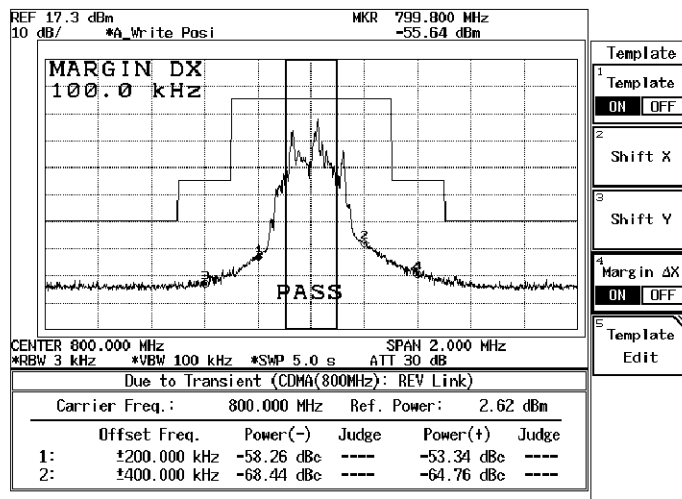

Figure 5-9 Template with Margin Delta X

5 TECHNICAL NOTES

When Template Couple to Power is set to OFF, template (Y axis data) is interpreted as an absolute value. As a result, the template is made up of the data you entered.

Use the Shift X/Y keys to adjust the template position over the measured value.

When Template Couple to Power is set to ON, template (Y axis data) is interpreted as a relative value to the average power.

When the template is shifted on Y axis using the Shift X/Y function, the relative value to the average power is: Relative value (set on the template) + Shifted data on Y axis.

**5.9 Measurement Parameter Settings in Due to Transient, Due to Modulation and In-band Spurious**

In TRANSIENT mode, any parameters are compliant with the communication standard when you specify the communication standard. You can also change the measuring frequency and the secondary processing of the measured results.

For the method of changing these, refer to the following.

**5.9.1 Marker Edit Function**

Measurement frequency can be set using Marker Edit in Due to Transient, Due to Modulation or Inband Spurious function (these three functions are found within the Transient mode). In addition, each limit level can be set using Marker Edit.

- (1) Marker Edit used in the Due to Transient and Due to Modulation

The measuring frequency is set using the offset frequency from a carrier frequency. If you set the offset frequency to 200 kHz, the offset frequencies (+200 kHz and -200 kHz) can be measured. In addition, two types of marker are available: the Normal marker and the Integral marker.

Normal marker is used to read the level of the frequency previously set, and the Integral marker is used to calculate the power of the bandwidth whose center frequency is specified by Marker Edit.

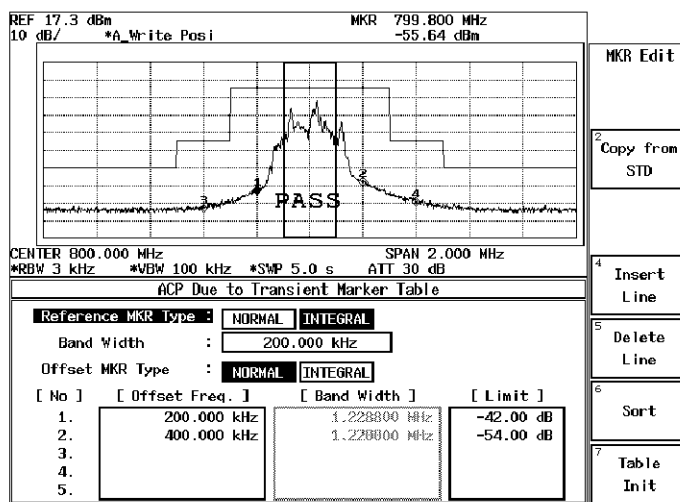

Figure 5-10 Example of Marker Edit Setting



(2) Marker Edit used in the Inband Spurious

Measuring frequency range is set using the offset frequency from the carrier frequency. If you set 3 MHz and 10 MHz, the peak search is performed for two ranges: one of the two offset frequency range is between -3 MHz and -10 MHz; another range is between +3 MHz and +10 MHz.

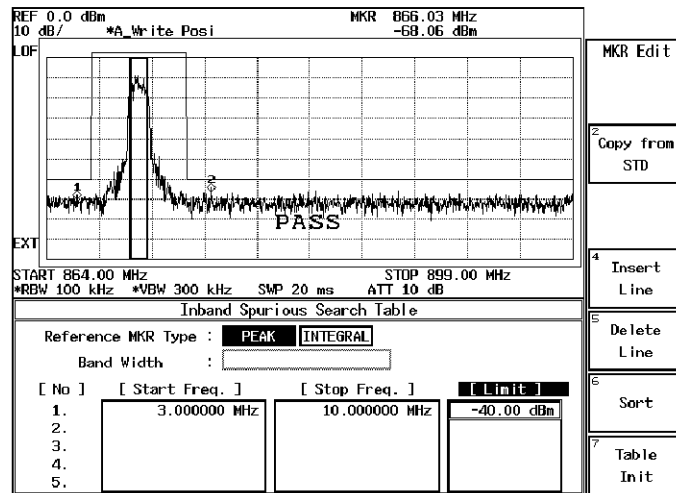

Figure 5-11 Marker Edit Setting

Peak marker is set using the Peak Marker Y Delta soft key in the Config menu.

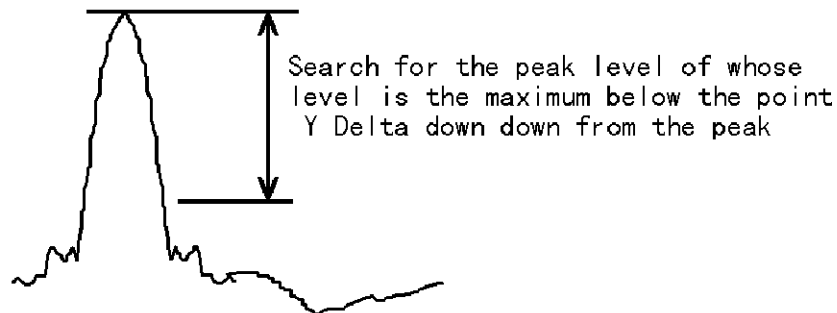

Figure 5-12 Example of Peak Marker Y Delta

### 5.9.2 Measurement results Using Due to Modulation, Due to Transient and Inband Spurious Modes

In spectrum measurements, there are three methods for displaying results of adjacent or alternate adjacent channel leakage power measurements.

---

## 5 TECHNICAL NOTES

---

**NOTE:** *As for the absolute level of adjacent channel power and the absolute level of carrier frequency, each of these can be defined in two modes:*

- *Level at a specific frequency where the marker is located (the marker level is read in such a case)*
  - *Level calculated from integration to the specified frequency band*
- 

- (1) The measured value displays the absolute level of the marker, which is located at an offset frequency from the carrier frequency.
- (2) The ratio of the absolute level of the marker to the absolute level of the carrier is displayed. The marker point is located at an offset frequency from the carrier frequency.
- (3) The value obtained in (2) is multiplied by the level by the power meter. The calculated value is then displayed.

This method is used when the absolute value of the adjacent channel power cannot be measured., The ratio of the adjacent channel power to the carrier power can be measured only when Detector is set to Posi. However, the absolute level cannot be measured.

To display a measured value in (1), select MARKER on the Result : MARKER/RELATIVE/ABS POWER menu in the Parameter Setup dialog box.

To display the measured value in (2), select RELATIVE.

To display a measured value in (3), select ABS POWER. In addition, use the Marker Edit menu to set up measurement conditions for the carrier power. Set the MKR Type to NORMAL or INTEGRAL in the Reference Marker in order to measure the carrier power.

To measure the power of the bandwidth by integration, Reference MKR Type must be set to INTEGRAL.

To measure a point level (marker reading), Reference MKR Type must set to NORMAL.

To measure adjacent channel power, set Offset MKR Type to NORMAL or INTEGRAL. To measure the carrier power in (2) or (3), there are two methods: one is by setting the Marker Edit to the Reference MKR type (set the Ref Power to REF MARKER. Ref Power is in the Parameter Setup dialog box on the config menu); another is to measure power using the DSP (set the Ref Power to MODULATION. Ref Power is in the Parameter Setup dialog box on the config menu) .

When REF MARKER is selected, the carrier power is measured by setting Reference MKR Type in the Marker Edit menu.

When MODULATION is selected, the carrier power is measured by Tx Power (Modulation, Tx Power).

When ABS POWER of the Result is selected from the Parameter Setup dialog box in the Config Menu, the ratio of Offset MKR to Reference MKR is calculated, the measurement value from Tx Power is multiplied by this ratio. Then, the result will be displayed.

### 5.9.3 Measurement Result of Inband Spurious

In Spurious measurements, there are two methods:

- (1) After searching for the peak on the trace, the frequency and level at the marker are displayed.
- (2) After searching for the peak on the trace, the ratio of the marker level to the carrier level is displayed.
- (3) The calculated level, which is calculated using the result obtained in (2) and the level on the power meter is displayed.

To display the measured value in (1), select MARKER on the Result : MARKER/RELATIVE/ABS POWER menu in the Parameter Setup dialog box. And also, to display the measured value in (2), select RELATIVE; for the (3), select ABS POWER. The measurement conditions for the carrier power is set up using the Marker Edit menu. To measure the carrier power, set Reference MKR Type to PEAK or NORMAL.

To measure the carrier power at the specified frequency, NORMAL is set; and to measure the carrier power at the peak on the trace, PEAK is set.

To measure the carrier power in (2) or (3), there are two methods: one is by setting the instrument to the Reference MKR type in the Marker Edit menu; another is by the DSP.

When Ref Power is set to REF MARKER, the carrier power is measured by Reference MKR Type in the Marker Edit menu.

When Ref Power is set to MODULATION, the carrier power is measured by the Tx Power (Modulation, Tx Power).

### 5.10 Mag Error (Magnitude Error)

Mag Error is defined as shown in Figure 5-13, and the value is calculated using the following formula.

$$\text{Magnitude Error (i)} = \left( \frac{\sqrt{I_m(i)^2 + Q_m(i)^2}}{\sqrt{I_r(i)^2 + Q_r(i)^2}} - 1 \right) \times 100$$

$I_m(i)$ ,  $Q_m(i)$  : Measured Value  
 $I_r(i)$ ,  $Q_r(i)$  : Reference Value  
*i* : Symbol Number

### 5.11 Phase Error

Phase Error is defined as shown in Figure 5-13, and the value is calculated using the following formula.

$$\text{Phase Error (i)} = \tan^{-1}(Q_m(i)/I_m(i)) - \tan^{-1}(Q_r(i)/I_r(i))$$

$I_m(i)$ ,  $Q_m(i)$  : Measured Value  
 $I_r(i)$ ,  $Q_r(i)$  : Reference Value  
*i* : Symbol Number

5 TECHNICAL NOTES

**5.12 E.V.M.(Error Vector Magnitude)**

E.V.M. is defined as shown in Figure 5-13, and the value is calculated using the following formula.

$$\text{Error Vector Magnitude}(i) = \frac{\sqrt{(\text{Im}(i) - \text{Ir}(i))^2 + (\text{Qm}(i) - \text{Qr}(i))^2}}{\text{Reference Value}} \times 100$$

Im(i), Qm(i) : Measured Value  
 Ir(i), Qr(i) : Reference Value  
 i : Symbol Number

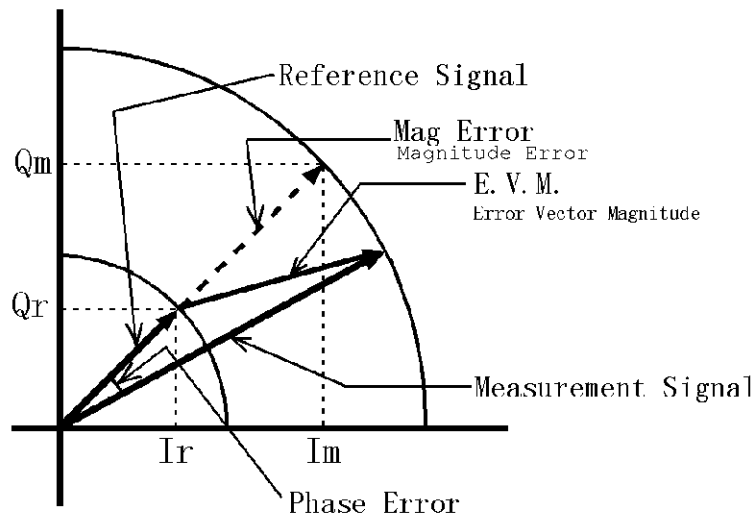

**Figure 5-13 Mag Error, Phase Error, E.V.M.**

### 5.13 Block Diagram

This section shows the block diagram for the modulation analysis hardware.

The Figure 5-14 shows the modulation analysis part. Therefore the spectrum analyzer part is simplified. The area inside the double lines is the block diagram for the spectrum analyzer, and the part outside that area represents the modulation analysis hardware.

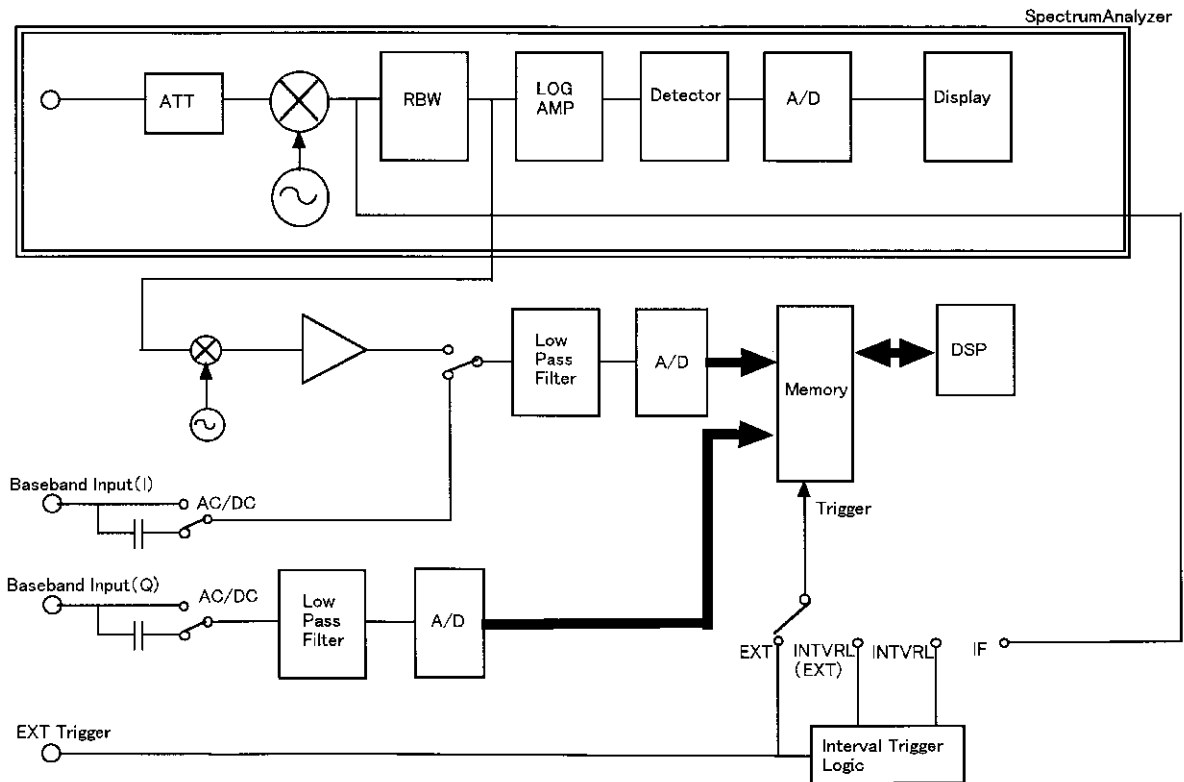

Figure 5-14 Block Diagram



## 6 PERFORMANCE VERIFICATION TEST

### 6.1 General

#### 6.1.1 Introduction

This chapter provides R3267 Series performance verification test procedures, item by item as listed in Table 6-1.

Performance verification test will be carried out under following condition.

Temperature range: 20°C to 30°C

Relative Humidity: 85% or less

**Table 6-1 Performance Verification Items**

No.	Test Items
6.2.1	Waveform Quality in Forward Link
6.2.2	Waveform Quality in Reverse Link
6.2.3	Code Domain Power
6.2.4	Simplified Performance Check

#### 6.1.2 Test Equipment

The Table 6-2 lists recommended test equipment.

The equipment needed to perform all of the performance test.

Equipment lists for individual tests are provided in each performance verification test.

In the table, PV is abbreviation of performance verification.

- 
- NOTE:**
1. *The R3267 Series with OPT61 to be tested should be warm up for at least 30 minutes before starting test.*
  2. *Make sure that the test equipment used meets its own published specifications.*
  3. *Any equipment that meets the critical specifications given in the table can be substituted for recommended models.*
-

6.1 General

**Table 6-2 Equipment List**

No.	Description	Critical Specification	Recommended Model	Manufacturer	Usage	Notes
1	Arbitrary Waveform Generator	Output Channels: 3 channel required Capable to assign the output signal I-CH signal at CH1 Q-CH signal at CH2 Trigger signal(TTL) at CH3	AWG2021	Tektronix	PV	SG1*
2	I/Q Modulation Signal Generator	Comply with IS-95,IS-97 and IS-98 Standard Frequency Range: 30 MHz to 3 GHz IQ Modulation Bandwidth: > 5 MHz $\rho : >0.999$	SMIQ03	Rohde &Schwartz	PV	SG2*
3	RF Cable	BNC(m)-BNC(m), 50 $\Omega$	MI-09	Advantest	PV	-
4	Adapter	Type N(m)-BNC(f), 50 $\Omega$	JUG-201-U	Advantest	PV	-

NOTE: \*The IQ level and DC offset of both SG1 and SG2 must be matched.  
Total performance of SG1 with SG2 must cover the R3267 Series tested specification.



### 6.1.3 Specifications Required for Test Signals

Table 6-3 provides the specifications required for performance verification test signals based on IS-95, IS-97 and IS-98 standard.

**Table 6-3 Specifications Required for Test Signals**

No.	Name of test Signal	Specification Required	Usage
1	Base Station	Pilot Channel	Waveform Quality Accuracy (Forward Link)
2	Mobile Station	Comply with IS-98 Standard Reverse Traffic Channel Information Bits: All 0 9.6 kbps Long Code Mask: All 0	Waveform Quality Accuracy (Reverse Link)
3	Base Station	Comply with the Chapter 12 of IS-97, and IS-98 Standard: Base Station Test Model, Normal	
		Channel No.	Amplitude
		0 (Pilot)	-6.99 dB
		1 (Paging)	-7.25 dB
		6 (Traffic)	-10.26 dB
		17 (Traffic)	-10.26 dB
		20 (Traffic)	-10.26 dB
		32 (Sync)	-13.27 dB
		41 (Traffic)	-10.26 dB
		49 (Traffic)	-10.26 dB
58 (Traffic)	-10.26 dB		
4	CW	CAL OUT Signal of R3267 Series Frequency: 30 MHz, Level: -10 dBm)	Simplified Performance Check

Figure 6-1 shows the timing chart of trigger signal with No.1, N0.2 and No.3 listed in Table 6-3.

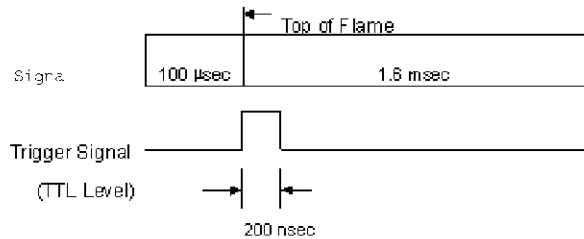

**Figure 6-1 Timing Chart**

## 6.1 General

### 6.1.4 Calibration Cycle

The performance verifications test should be used to check the spectrum analyzer against its specifications once a year recommended.

### 6.1.5 Performance Verification Test Record Sheet

The performance verification test record sheet and performance check record sheet are provided at the end of this chapter.

The test record lists test specification and acceptable limits.

Recommend that make a copy of this table, record the complete test results on the copy, and keep the copy for calibration test record.

This record could prove invaluable in tracking gradual changes in test result over long periods of the time.

### 6.1.6 Performance Verification Procedures

Typeface conventions used in this manual.

- Panel keys and soft keys are printed in a contrasting typestyle to make them stand out from the text as follows:

Panel keys: Boldface type

Example: **FREQ, FORMAT**

Soft keys: Boldface and Italic

Example: ***Center, Trace Detector***

- When a series of key operations are described using a comma between two keys.
- There are various soft menus used to switch between two states such as ON/OFF and AUTO/MNL.

For example, when turning off the *Display ON/OFF* function, the annotation "*Display ON/OFF (OFF)*" is used.

When switching the *RBW AUTO/MNL* function to MNL, the annotation "*RBW AUTO/MNL (MNL)*" is used.

## 6.2 Performance Verification Tests Procedure

### 6.2.1 Waveform Quality Accuracy (Forward Link)

(1) Description

Test waveform quality in Forward Link Mode.

(2) Specification

Waveform Quality Accuracy( $\rho$ ) :  $> 0.9985$   
 Time Alignment Accuracy( $\tau$ ) :  $< \pm 300$  ns  
 Carrier Frequency Accuracy :  $< \pm 34$  Hz

(3) Equipment used

Arbitrary Waveform Generator : SG1  
 IQ Modulation Signal Generator : SG2  
 RF Cable : BNC(m)-BNC(m)  
 Adapter : N(m)-BNC(f)

(4) Setup

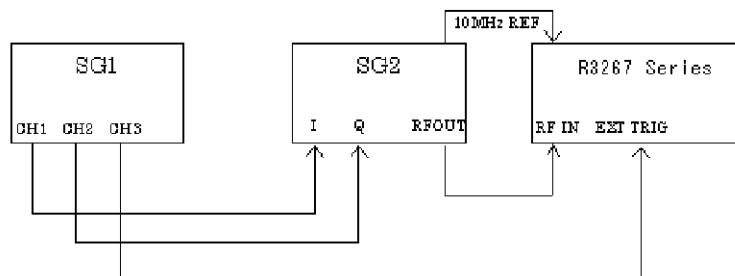

Figure 6-2 Setup of Waveform Quality Test for Forward Link

(5) Procedure

1. Connect equipment as shown in Figure 6-2.
2. On the SG1, set controls to generate the signal complied with No.1 signal listed in Table 6-3 at CH1 and CH2.
3. On the SG1, set controls to generate trigger signal at CH3.
4. On the SG2, set controls as follows;
 

Modulation	: External IQ Modulation
Frequency	: 800 MHz
Output Level	: 0 dBm
5. On the R3267 Series, set controls as follows;

6.2 Performance Verification Tests Procedure

Center Frequency : 800 MHz  
 Input : RF  
 Link : Forward Link

- On the R3267 Series, set the measurement parameter as shown in Figure 6-3.

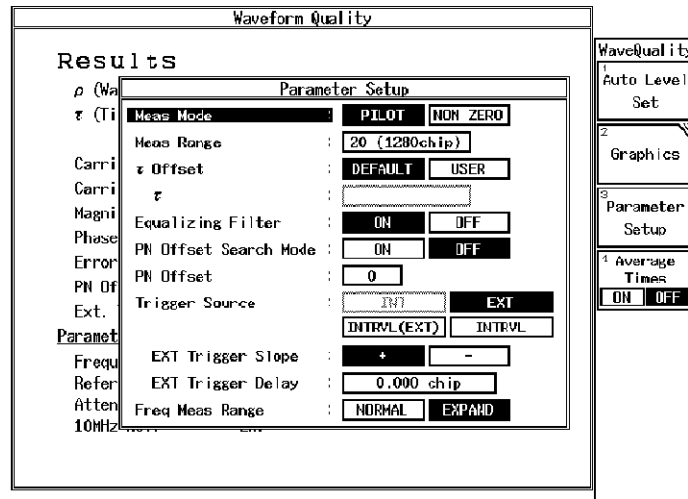

Figure 6-3 Setting of Measurement Parameter for Forward Link Waveform Quality Test

- On the R3267 Series, press **DC CAL** and **AUTO LEVEL** to perform dc calibration and auto level.
- On the R3267 Series, press **SINGLE** for single sweep.
- After single sweep has completed, record the measurement result in the performance verification test record sheet.

6.2.2 Waveform Quality Accuracy (Reverse Link)

- Description

Test waveform quality in reverse link

- Specification

Waveform Quality ( $\rho$ ) : > 0.997  
 Time Alignment Accuracy ( $\tau$ ) : <  $\pm 300$  ns  
 Carrier Frequency Accuracy: : <  $\pm 34$  Hz

- Equipment used

Arbitrary Waveform Generator : SG1  
 IQ Modulation Signal Generator : SG2  
 RF Cable : BNC(m)-BNC(m)  
 Adapter : N(m)-BNC(f)

## (4) Setup

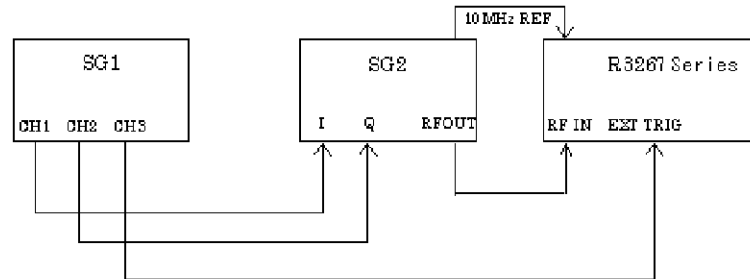

Figure 6-4 Setup of Waveform Quality Test for Reverse Link

## (5) Procedure

1. Connect equipment as shown in Figure 6-4.
2. On the SG1, set controls to generate the signal complied with No.2 signal listed in Table 6-3 at CH1 and CH2.
3. On the SG1, set controls to generate trigger signal at CH3.
4. After single sweep has completed, record the measurement result in the performance verification test record sheet.

5. On the SG2, set controls as follows;

Modulation	: External IQ Modulation
Frequency	: 800 MHz
Output Level	: 0 dBm

6. On the R3267 Series, set controls as follows;

Center Frequency	: 800 MHz
Input	: RF
Link	: Reverse Link

6.2 Performance Verification Tests Procedure

7. On the R3267 Series, set the measurement parameter as shown in Figure 6-5.

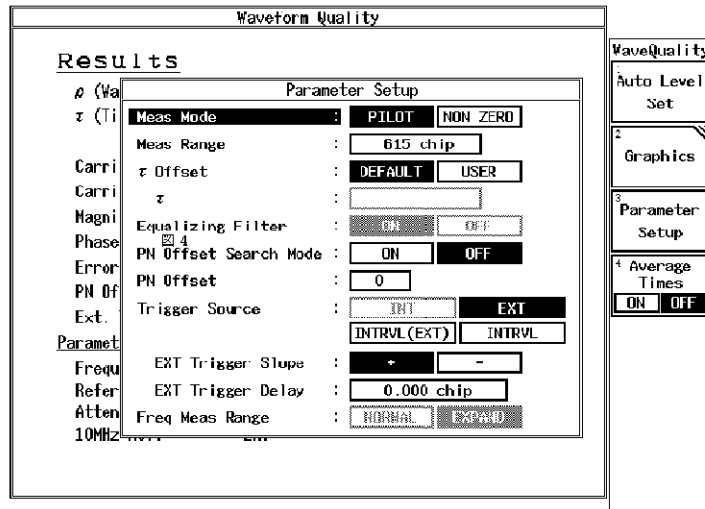

Figure 6-5 Setting of Measurement Parameter for Reverse Link Waveform Quality Test

8. On the R3267 Series, press **DC CAL** and **AUTO LEVEL** to perform dc calibration and auto level.
9. On the R3267 Series, press **SINGLE** for single sweep.
10. After single sweep has completed, record the measurement result in the performance verification test record sheet.

6.2.3 Code Domain Power

- (1) Description

Test code domain power accuracy.

Test signal in used should be complied with IS-97 and IS-98 standard

- (2) Specification

Carrier Frequency Accuracy : < ±34 Hz  
 Code Domain Power : < ±0.1 dB  
 Time Alignment Accuracy(τ) : < ±10 ns  
 Phase Accuracy: ( Δθ ) : < ±10 mrad

- (3) Equipment used

Arbitrary Waveform Generator : SG1  
 IQ Modulation Signal Generator : SG2  
 RF Cable : BNC(m)-BNC(m)  
 Adapter : N(m)-BNC(f)

## (4) Setup

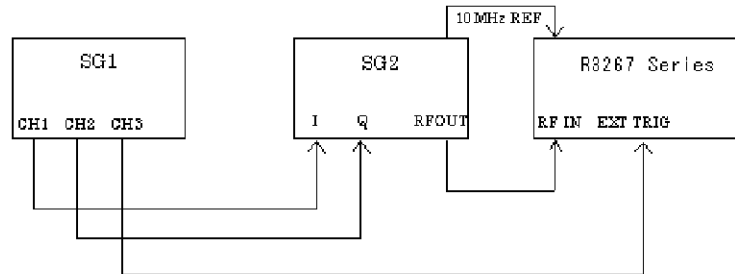

Figure 6-6 Setup of Code Domain Power Test

## (5) Procedure

1. Connect equipment as shown in Figure 6-6.
2. On the SG1, set controls to generate the signal complied with No.3 signal listed in Table 6-3.
3. On the SG1, set controls to generate trigger signal at CH3.

4. On the SG2, set controls as follows;

Modulation	: External IQ Modulation
Frequency	: 800 MHz
Output Level	: 0 dBm

5. On the R3267 Series, set controls as follows;

Center Frequency	: 800 MHz
Input	: RF
Link	: Forward Link

6.2 Performance Verification Tests Procedure

6. On the R3267 Series, set the measurement parameter as shown in Figure 6-7.

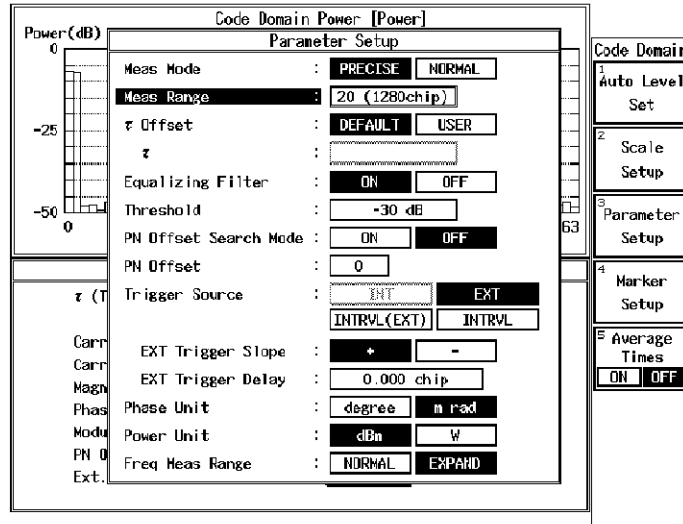

Figure 6-7 Setting of Measurement Parameter for Code Domain Power Test

7. On the R3267 Series, press *DC CAL* and *AUTO LEVEL* to perform dc calibration and auto level.
8. On the R3267 Series, press *SINGLE* for single sweep.
9. After single sweep has completed, record the measurement result in the performance verification test record sheet.

6.2.4 Simplified Performance Check by Using Calibration Signal

(1) Description

This section provides performance check procedure for OPT61 by using built-in calibration signal. Measure carrier frequency accuracy and waveform quality.

(2) Specification

Carrier Frequency Accuracy : < ±34 Hz  
 Waveform Quality (p) : > 0.9985

(3) Equipment used

RF Cable : BNC(m)-BNC(m)  
 Adapter : N(m)-BNC(f)



(4) Setup

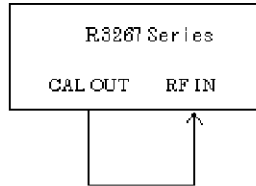

Figure 6-8 Setup of Simplified Performance Check

(5) Procedure

1. Connect equipment as shown in Figure 6-8.
2. On the R3267 Series, set controls as follows;

Center Frequency : 30.3072 MHz  
 Input : RF  
 Link : Forward Link

3. On the R3267 Series, set the measurement parameter as shown in Figure 6-9.

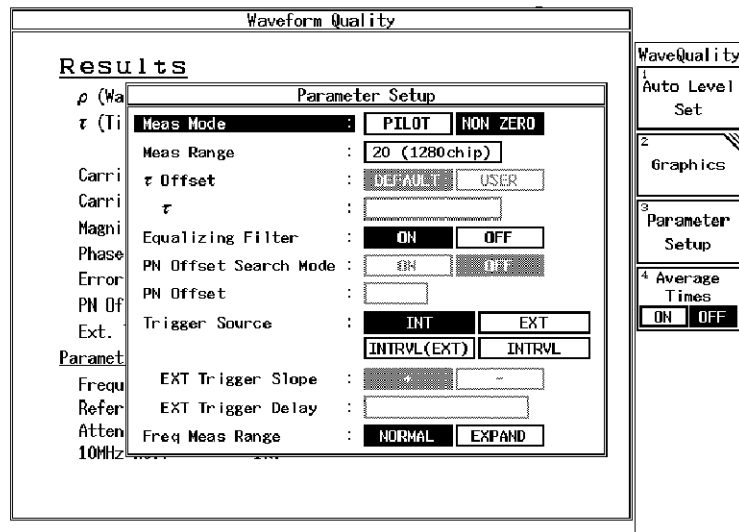

Figure 6-9 Setting of Measurement Parameter for Simplified Performance Check

4. On the R3267 Series, press **DC CAL** and **AUTO LEVEL** to perform dc calibration and auto level.
5. On the R3267 Series, press **SINGLE** for single sweep.
6. After single sweep has completed, record the result in the performance check record sheet.

6.3 Performance Verification Test Record Sheet

**6.3 Performance Verification Test Record Sheet**

Model : OPT3264/67/73+61

S/N :

(1) Waveform Quality (Forward Link)

Test Items	Specification			Result
	Min.	Measured Value	Max.	Pass/Fail
Waveform Quality Accuracy( $\rho$ )	0.9985		N/A	
Time Alignment Accuracy( $\tau$ )	-300 ns		+300 ns	
Carrier Frequency Accuracy	-10 Hz		+10 Hz	

(2) Waveform Quality (Reverse Link)

Test Items	Specification			Result
	Min.	Measured Value	Max.	Pass/Fail
Waveform Quality Accuracy( $\rho$ )	0.997		N/A	
Time Alignment Accuracy( $\tau$ )	-300 ns		+300 ns	
Carrier Frequency Accuracy	-10 Hz		+10 Hz	

## (3) Code Domain Power

Test Items		Specification			Result
		Min.	Measured Value	Max.	Pass/Fail
Carrier Frequency Accuracy		-10 Hz		+10 Hz	
Code Domain Power Accuracy (POWER <sub>i</sub> )	Ch No.				
	0	-0.1 dB		+0.1 dB	
	1	-0.1 dB		+0.1 dB	
	6	-0.1 dB		+0.1 dB	
	17	-0.1 dB		+0.1 dB	
	20	-0.1 dB		+0.1 dB	
	32	-0.1 dB		+0.1 dB	
	41	-0.1 dB		+0.1 dB	
	49	-0.1 dB		+0.1 dB	
58	-0.1 dB		+0.1 dB		
Time Alignment Accuracy ( $\tau_i$ )	Ch No.				
	0	-10 ns		+10 ns	
	1	-10 ns		+10 ns	
	6	-10 ns		+10 ns	
	17	-10 ns		+10 ns	
	20	-10 ns		+10 ns	
	32	-10 ns		+10 ns	
	41	-10 ns		+10 ns	
	49	-10 ns		+10 ns	
58	-10 ns		+10 ns		
Phase Accuracy ( $\Delta\theta_i$ )	Ch No.				
	0	+10 mrad		+10 mrad	
	1	+10 mrad		+10 mrad	
	6	+10 mrad		+10 mrad	
	17	+10 mrad		+10 mrad	
	20	+10 mrad		+10 mrad	
	32	+10 mrad		+10 mrad	
	41	+10 mrad		+10 mrad	
	49	+10 mrad		+10 mrad	
58	+10 mrad		+10 mrad		

6.4 Simplified Performance Check Record Sheet

**6.4 Simplified Performance Check Record Sheet**

Model : OPT3264/67/73+61

S/N :

Test Items	Specification			Result
	Min.	Measured Value	Max.	Pass/Fail
Waveform Quality Accuracy( $\rho$ )	0.9985		N/A	
Carrier Frequency Accuracy	-10 Hz		+10 Hz	

## 7 SPECIFICATIONS

### RF input

- Waveform quality measurement

Characteristics	Specification
Measurement frequency range	30 MHz to 3.0 GHz
Input level range	-30dBm to +30 dBm (Total power at ATT:AUTO)
Forward Link	
Waveform quality( $\rho$ )	Measurement accuracy : $<\pm 0.0015$
Time alignment Error( $\tau$ )	Measurement accuracy : $<\pm 300$ nsec
Carrier frequency Error	$<\pm(\text{Reference frequency accuracy} \times \text{Carrier frequency} + 10 \text{ Hz})$ (Expand mode:carrier frequency $\pm 4$ kHz)
Reverse Link	
Waveform quality( $\rho$ )	Measurement accuracy : $<\pm 0.003$
Time alignment Error( $\tau$ )	Measurement accuracy : $<\pm 300$ nsec
Carrier frequency Error	$<\pm(\text{Reference frequency accuracy} \times \text{Carrier frequency} + 10 \text{ Hz})$ (Carrier frequency $\pm 4$ kHz)

- Code Domain Power

Characteristics	Specification
Measurement frequency range	30 MHz to 3.0 GHz
Input level range	-30dBm to +30 dBm (Total power at ATT:AUTO)
Precise Mode	measure at $64 \times 20$ chip
POWER <sub>i</sub>	Measurement accuracy : $<\pm 0.1$ dB(at $\tau_i=0$ )
Carrier frequency Error	Measurement accuracy : $<\pm 300$ nsec $<\pm(\text{Reference frequency accuracy} \times \text{Carrier frequency} + 10 \text{ Hz})$
$\tau_i$	Measurement accuracy : $<\pm 10$ nsec
$\Delta\theta_i$	Measurement accuracy : $<\pm 10$ mrad
Normal Mode	measure at $64 \times 20$ chip
POWER <sub>i</sub>	Measurement accuracy : $<\pm 0.1$ dB(at $\tau_i=0$ )
Carrier frequency Error	Measurement accuracy : $<\pm 300$ nsec $<\pm(\text{Reference frequency accuracy} \times \text{Carrier frequency} + 10 \text{ Hz})$ (Expand mode:carrier frequency $\pm 4$ kHz)

Note: The measurement signal is specified by IS-97 "Base Station Test Model".



## APPENDIX

### A.1 Messages

In this section, the messages that are displayed while the analyzer is being used are described.

Code	Messages	Description
700	System Error. Cannot allocate the required memory.	Fatal Error occurred. Data area for the calculation is insufficient on the memory. Contact a sales representative.
701	System Error. Clock is not operational.	Fatal Error occurred. System clock is not in operation. Contact a sales representative.
702	Modulation Gain CAL error. Check 30 MHz CAL signal for connection.	
703	Modulation DC CAL error. Remove input signals and try again.	
704	Time Out! No Trigger Detected	Time out error on the trigger signal occurred. Check the trigger settings.
705	Input Level is out of Range. Check the Ref. level.	
706	No graph data. Execute measurement.	
708	System Error. Contact qualified engineer.	
710	Auto Level completed !	
711	Auto Level Set can not be succeed. Signal level is not stable.	
712	Cannot execute measurement. Because is too low.	
713	Cannot synchronize to Pilot. Adjust PN Offset.	
714	Cannot converge equation. Adjust threshold.	
715	Frequency Error is out of Meas. Range.	

A.1 Messages

Code	Messages	Description
719	Burst signal is not detected. Check Burst length or Ref. level.	
721	Frequency Error is out of Meas. Range.	
722	Modulation Gain CAL error!(#200) Check 30 MHz CAL signal for connection.	
723	Modulation Gain CAL error!(#300) Check 30 MHz CAL signal for connection.	
724	Modulation Gain CAL error!(#110) Check 30 MHz CAL signal for connection.	
725	Modulation Gain CAL error!(#120) Check 30 MHz CAL signal for connection.	
726	Modulation Gain CAL error!(#210) Check 30 MHz CAL signal for connection.	
727	Modulation Gain CAL error!(#220) Check 30 MHz CAL signal for connection.	
728	Handshake error occurred to DSP. Contact qualified engineer.	
729	Cannot Detect Mod. DSP board. Contact qualified engineer.	
750	Handshake error occurred to DSP. Contact qualified engineer.	
751	Cannot Detect Mod. DSP board. Contact qualified engineer.	



## ALPHABETICAL INDEX

- [A]**
- About Equalizing Filter ..... 5-2
  - Accessories ..... 1-2
  - ACP Measurement ..... 2-22
  - Auto Level Set ..... 3-6, 3-7,  
3-8, 3-15,  
3-16, 3-17,  
3-21, 3-24,  
3-26, 3-42,  
3-45, 3-49
  - Average Times ON/OFF ..... 3-6, 3-7,  
3-8, 3-9,  
3-10, 3-11,  
3-12, 3-13,  
3-14, 3-15,  
3-16, 3-17,  
3-23, 3-25,  
3-27, 3-31,  
3-32, 3-33,  
3-37, 3-39,  
3-41, 3-44,  
3-48, 3-50
- [B]**
- Baseband Input ..... 3-18, 3-52
  - Block Diagram ..... 5-13
  - BTS (base station) Code Domain Power 2-1
- [C]**
- Calibration ..... 1-3
  - Calibration Cycle ..... 6-4
  - CCHPOW ..... 4-21
  - Channel Setting ..... 3-5, 3-53
  - Code ..... A-1, A-2
  - Code Domain Power ..... 2-11, 3-5,  
3-45, 6-8
  - Config ..... 3-6, 3-7,  
3-8, 3-9,  
3-10, 3-11,  
3-12, 3-13,  
3-14, 3-23,  
3-25, 3-27,  
3-31, 3-32,  
3-33, 3-37,  
3-39, 3-41
  - Connectors ..... 1-4
  - Constellation ..... 3-15
  - Constellation(Dot) ..... 3-15
  - Constellation(Line & Dot) ..... 3-15
  - Constellation(Line) ..... 3-15
  - Cont Auto Level Set ..... 3-18, 3-52
  - Copy from STD ..... 3-6, 3-11,  
3-12, 3-13,  
3-22, 3-33,  
3-36, 3-37,  
3-38, 3-39
- [D]**
- DC CAL ..... 3-5, 3-53
  - DEL ..... 4-9
  - Delay Time ..... 3-6, 3-7,  
3-8, 3-9,  
3-12, 3-22,  
3-25, 3-27,  
3-30, 3-35
  - Delete ..... 3-14
  - Delete Line ..... 3-6, 3-8,  
3-11, 3-12,  
3-13, 3-23,  
3-27, 3-33,  
3-36, 3-37,  
3-39, 3-41
  - Detector ..... 3-6, 3-7,  
3-8, 3-9,  
3-10, 3-11,  
3-12, 3-13,  
3-14, 3-23,  
3-25, 3-27,  
3-30, 3-31,  
3-32, 3-33,  
3-36, 3-37,  
3-39, 3-41
  - Display ..... 3-16, 3-45
  - Display Start ..... 3-15, 3-42
  - Display Unit ..... 3-6, 3-7,  
3-8, 3-9,  
3-11, 3-12,  
3-13, 3-14,  
3-23, 3-25,  
3-28, 3-31,  
3-34, 3-38,  
3-40, 3-41
  - Displaying the Absolute Power ..... 5-4
  - Due to Modulation ..... 3-5, 3-35,  
5-9
  - Due to Transient ..... 3-5, 3-32,  
5-9
- [E]**
- E ..... 5-12

Alphabetical Index

E.V.M (Error Vector Magnitude) ..... 5-12  
 E.V.M. vs Chip ..... 3-15  
 Equalizing Filter ..... 3-15, 3-16,  
 3-43, 3-46  
 Estimated  $p$  in the Code Domain Power  
 Measurement ..... 5-4  
 EXT Gate ..... 3-9, 3-12,  
 3-30, 3-36  
 EXT Trigger Delay ..... 3-15, 3-16,  
 3-17, 3-44,  
 3-47  
 EXT Trigger Slope ..... 3-15, 3-16,  
 3-17, 3-44,  
 3-47

**[F]**

F-Domain ..... 3-5, 3-29  
 Format ..... 3-16, 3-45  
 Forward Link ..... 6-5  
 Freq Meas Range ..... 3-15, 3-16,  
 3-44, 3-48  
 Freq. Setting ..... 3-11, 3-12,  
 3-13, 3-33,  
 3-37, 3-39  
 Frequency Input ..... 3-18, 3-52  
 Function Description ..... 3-19

**[G]**

Gate Position ..... 3-9, 3-12,  
 3-30, 3-36  
 Gate Setup ..... 3-9, 3-12,  
 3-29, 3-30,  
 3-35, 3-36  
 Gate Source ..... 3-9, 3-12,  
 3-30, 3-35  
 Gate Width ..... 3-9, 3-12,  
 3-30, 3-36  
 Gated Sweep ..... 3-9, 3-31  
 Gated Sweep ON/OFF ..... 3-9, 3-12,  
 3-30, 3-36  
 GPHWSH ..... 4-39  
 GPIB Command Codes ..... 4-7  
 GPIB Command Index ..... 4-1  
 Graphics ..... 3-15, 3-42

**[I]**

I EYE Diagram ..... 3-15  
 I/Q EYE Diagram ..... 3-15  
 Inband Spurious ..... 3-5, 3-38,  
 5-10  
 Inband Spurious Modes ..... 5-9  
 Input ..... 3-18, 3-52

Insert ..... 3-14, 3-36  
 Insert Line ..... 3-6, 3-8,  
 3-11, 3-12,  
 3-13, 3-23,  
 3-27, 3-33,  
 3-36, 3-37,  
 3-39, 3-41  
 INTRODUCTION ..... 1-1  
 IQ Inverse ..... 3-18, 3-52

**[J]**

Judgment ..... 3-6, 3-7,  
 3-8, 3-9,  
 3-10, 3-11,  
 3-12, 3-13,  
 3-14, 3-24,  
 3-26, 3-28,  
 3-31, 3-32,  
 3-34, 3-38,  
 3-40, 3-41

**[L]**

Link ..... 3-18, 3-51  
 Load Table ..... 3-8, 3-14,  
 3-27, 3-40  
 Lower Limit ..... 3-6, 3-9,  
 3-10, 3-24,  
 3-31, 3-32

**[M]**

Mag Error ..... 5-11  
 Mag Error vs Chip ..... 3-15  
 Margin  $\Delta X$  ON/OFF ..... 3-11, 3-12,  
 3-13, 3-32,  
 3-36, 3-38  
 Marker Edit ..... 3-11, 3-12,  
 3-13, 3-33,  
 3-37, 3-39  
 Marker Setup ..... 3-16, 3-48  
 Meas Filter ..... 3-17, 3-49  
 Meas Mode ..... 3-15, 3-16,  
 3-43, 3-46  
 Meas Range ..... 3-15, 3-16,  
 3-43, 3-46  
 Menu Index ..... 3-1  
 Menu Map ..... 3-5  
 Messages ..... A-1  
 Modulation ..... 3-5, 3-42  
 Multiplier ..... 3-8, 3-28

<b>[N]</b>		Preselector .....	3-8, 3-14, 3-28, 3-41
Null Offset Constellation .....	3-15	Product Overview .....	1-1
Null Offset Constellation(Dot) .....	3-15	<b>[Q]</b>	
Null Offset Constellation(Line & Dot) ...	3-15	Q EYE Diagram .....	3-15
Null Offset Constellation(Line) .....	3-15	<b>[R]</b>	
Null Offset I EYE Diagram .....	3-15	Rate .....	3-18, 3-51
Null Offset I/Q EYE Diagram .....	3-15	Record Sheet .....	6-12, 6-14
Null Offset Q EYE Diagram .....	3-15	Ref Power .....	3-11, 3-12, 3-13, 3-34, 3-38, 3-40
<b>[O]</b>		REFERENCE .....	3-1
OBW .....	3-5, 3-32	REMOTE CONTROL .....	4-1
OBW% .....	3-10, 3-32	Result .....	3-8, 3-11, 3-12, 3-13, 3-27, 3-34, 3-37, 3-39
OFF Position .....	3-7, 3-25	Reverse Link .....	6-6
OFF Width .....	3-7, 3-25	<b>[S]</b>	
Offset Level .....	3-18, 3-51	Save Table .....	3-8, 3-14, 3-27, 3-41
ON Position .....	3-7, 3-25	Scale Setup .....	3-16, 3-45
ON Width .....	3-7, 3-25	Select Type .....	3-15, 3-42
ON/OFF Ratio .....	3-5, 3-24	Self Test Function .....	1-3
OPERATION .....	2-1	Set to Default .....	3-8, 3-14, 3-28, 3-41
Outband Spurious .....	3-5, 3-40	Set to STD .....	3-6, 3-7, 3-9, 3-10, 3-11, 3-12, 3-13, 3-22, 3-24, 3-25, 3-26, 3-30, 3-31, 3-32, 3-34, 3-36, 3-38, 3-40
<b>[P]</b>		Setup STD .....	3-51
Paging Ch .....	3-16	Shift X .....	3-6, 3-11, 3-12, 3-13, 3-22, 3-32, 3-36, 3-38
Parameter Setup .....	3-6, 3-7, 3-8, 3-9, 3-10, 3-11, 3-12, 3-13, 3-14, 3-15, 3-16, 3-17, 3-23, 3-25, 3-27, 3-31, 3-32, 3-33, 3-37, 3-39, 3-41, 3-43, 3-46, 3-49	Shift Y .....	3-6, 3-11, 3-12, 3-13, 3-22, 3-32, 3-36, 3-38
Peak Factor of Tx Power .....	5-4	Simplified Performance Check .....	6-10, 6-14
Peak MKR Y Delta .....	3-8, 3-13, 3-14, 3-28, 3-39, 3-41	Slope .....	3-6, 3-7, 3-8, 3-9, 3-12, 3-21, 3-24, 3-26,
PERFORMANCE VERIFICATION			
TEST .....	6-1		
Phase Error .....	5-11		
Phase Error vs Chip .....	3-15		
Phase Unit .....	3-16, 3-47		
PN Offset .....	3-15, 3-16, 3-43, 3-47		
PN Offset Search Mode .....	3-15, 3-16, 3-43, 3-47		
Power .....	3-5		
Power (F-Domain) .....	3-29		
Power (T-Domain) .....	3-21		
Power Unit .....	3-16, 3-47		

Alphabetical Index

Sort .....	3-29, 3-35 3-6, 3-11, 3-12, 3-13, 3-23, 3-33, 3-37, 3-39	Threshold .....	3-16, 3-46
SPECIFICATIONS .....	7-1	Traffic Ch .....	3-16
Spurious .....	3-5	Trigger .....	3-9, 3-12, 3-30, 3-35
Spurious (T-Domain) .....	3-26	Trigger Delay .....	3-49
STD .....	3-5, 3-51	Trigger Level .....	3-6, 3-7, 3-9, 3-12, 3-22, 3-24, 3-29, 3-35
STD Setup .....	3-5	Trigger Position .....	3-6, 3-7, 3-8, 3-9, 3-12, 3-22, 3-25, 3-27, 3-29, 3-35
<b>[T]</b>			
$\tau$ .....	3-16, 3-43, 3-46	Trigger Setup .....	3-6, 3-7, 3-8, 3-9, 3-12, 3-21, 3-24, 3-26, 3-29, 3-35
$\tau$ Offset .....	3-16, 3-43, 3-46	Trigger Slope .....	3-49
Table Edit .....	3-8, 3-14, 3-27, 3-40	Trigger Source .....	3-6, 3-7, 3-8, 3-9, 3-12, 3-15, 3-16, 3-17, 3-21, 3-24, 3-26, 3-29, 3-35, 3-44, 3-47, 3-49
Table Init .....	3-6, 3-8, 3-11, 3-12, 3-13, 3-14, 3-23, 3-27, 3-33, 3-37, 3-39, 3-41	Trigger Source INTVL (EXT) and INTVL .....	5-5
Table No. 1/2/3 .....	3-8, 3-14, 3-27, 3-40	Tx Power .....	3-5, 3-49
T-Domain .....	3-5, 3-21	Type .....	3-18, 3-51
TECHNICAL NOTES .....	5-1	<b>[U]</b>	
Template .....	3-6, 3-11, 3-12, 3-13, 3-22, 3-32, 3-36, 3-38	Upper Limit .....	3-6, 3-7, 3-9, 3-10, 3-24, 3-26, 3-31, 3-32
Template Couple to Power .....	3-6, 3-11, 3-12, 3-13, 3-23, 3-34, 3-38, 3-40	<b>[W]</b>	
Template Edit .....	3-6, 3-11, 3-12, 3-13, 3-22, 3-32, 3-36, 3-38	Waveform Quality .....	3-5, 3-42
Template Edit Function .....	5-5	Waveform Quality Accuracy .....	6-5, 6-6
Template Limit .....	3-6, 3-11, 3-12, 3-13, 3-23, 3-34, 3-38, 3-40	Waveform Quality measurement of Modulation Signal .....	5-1
Template ON/OFF .....	3-6, 3-11, 3-12, 3-13, 3-22, 3-32, 3-36, 3-38	Window ON/OFF .....	3-6, 3-7, 3-9, 3-22, 3-25, 3-30
Template Setting in the T-Domain Measuring Mode .....	5-5	Window Position .....	3-6, 3-9, 3-22, 3-30
Template UP/LOW .....	3-6, 3-22	Window Setup .....	3-6, 3-7, 3-9, 3-22, 3-25, 3-30
Test Equipment .....	6-1		

Window Width ..... 3-6, 3-9,  
3-22, 3-31

**[Y]**

Y ..... 3-25  
Y Scale ..... 3-16, 3-45  
Y Scale [dB/div] 10/5/2 ..... 3-6, 3-7,  
3-9, 3-23,  
3-25, 3-31  
Y/div ..... 3-16, 3-45



## **IMPORTANT INFORMATION FOR ADVANTEST SOFTWARE**

PLEASE READ CAREFULLY: This is an important notice for the software defined herein. Computer programs including any additions, modifications and updates thereof, operation manuals, and related materials provided by Advantest (hereafter referred to as "SOFTWARE"), included in or used with hardware produced by Advantest (hereafter referred to as "PRODUCTS").

### **SOFTWARE License**

All rights in and to the SOFTWARE (including, but not limited to, copyright) shall be and remain vested in Advantest. Advantest hereby grants you a license to use the SOFTWARE only on or with Advantest PRODUCTS.

### **Restrictions**

- (1) You may not use the SOFTWARE for any purpose other than for the use of the PRODUCTS.
- (2) You may not copy, modify, or change, all or any part of, the SOFTWARE without permission from Advantest.
- (3) You may not reverse engineer, de-compile, or disassemble, all or any part of, the SOFTWARE.

### **Liability**

Advantest shall have no liability (1) for any PRODUCT failures, which may arise out of any misuse (misuse is deemed to be use of the SOFTWARE for purposes other than its intended use) of the SOFTWARE. (2) For any dispute between you and any third party for any reason whatsoever including, but not limited to, infringement of intellectual property rights.

## LIMITED WARRANTY

1. Unless otherwise specifically agreed by Seller and Purchaser in writing, Advantest will warrant to the Purchaser that during the Warranty Period this Product (other than consumables included in the Product) will be free from defects in material and workmanship and shall conform to the specifications set forth in this Operation Manual.
2. The warranty period for the Product (the "Warranty Period") will be a period of one year commencing on the delivery date of the Product.
3. If the Product is found to be defective during the Warranty Period, Advantest will, at its option and in its sole and absolute discretion, either (a) repair the defective Product or part or component thereof or (b) replace the defective Product or part or component thereof, in either case at Advantest's sole cost and expense.
4. This limited warranty will not apply to defects or damage to the Product or any part or component thereof resulting from any of the following:
  - (a) any modifications, maintenance or repairs other than modifications, maintenance or repairs (i) performed by Advantest or (ii) specifically recommended or authorized by Advantest and performed in accordance with Advantest's instructions;
  - (b) any improper or inadequate handling, carriage or storage of the Product by the Purchaser or any third party (other than Advantest or its agents);
  - (c) use of the Product under operating conditions or environments different than those specified in the Operation Manual or recommended by Advantest, including, without limitation, (i) instances where the Product has been subjected to physical stress or electrical voltage exceeding the permissible range and (ii) instances where the corrosion of electrical circuits or other deterioration was accelerated by exposure to corrosive gases or dusty environments;
  - (d) use of the Product in connection with software, interfaces, products or parts other than software, interfaces, products or parts supplied or recommended by Advantest;
  - (e) incorporation in the Product of any parts or components (i) provided by Purchaser or (ii) provided by a third party at the request or direction of Purchaser or due to specifications or designs supplied by Purchaser (including, without limitation, any degradation in performance of such parts or components);
  - (f) Advantest's incorporation or use of any specifications or designs supplied by Purchaser;
  - (g) the occurrence of an event of force majeure, including, without limitation, fire, explosion, geological change, storm, flood, earthquake, tidal wave, lightning or act of war; or
  - (h) any negligent act or omission of the Purchaser or any third party other than Advantest.
5. **EXCEPT TO THE EXTENT EXPRESSLY PROVIDED HEREIN, ADVANTEST HEREBY EXPRESSLY DISCLAIMS, AND THE PURCHASER HEREBY WAIVES, ALL WARRANTIES, WHETHER EXPRESS OR IMPLIED, STATUTORY OR OTHERWISE, INCLUDING, WITHOUT LIMITATION, (A) ANY WARRANTY OF MERCHANTABILITY OR FITNESS FOR A PARTICULAR PURPOSE AND (B) ANY WARRANTY OR REPRESENTATION AS TO THE VALIDITY, SCOPE, EFFECTIVENESS OR USEFULNESS OF ANY TECHNOLOGY OR ANY INVENTION.**
6. **THE REMEDY SET FORTH HEREIN SHALL BE THE SOLE AND EXCLUSIVE REMEDY OF THE PURCHASER FOR BREACH OF WARRANTY WITH RESPECT TO THE PRODUCT.**
7. **ADVANTEST WILL NOT HAVE ANY LIABILITY TO THE PURCHASER FOR ANY INDIRECT, INCIDENTAL, SPECIAL, CONSEQUENTIAL OR PUNITIVE DAMAGES, INCLUDING, WITHOUT LIMITATION, LOSS OF ANTICIPATED PROFITS OR REVENUES, IN ANY AND ALL CIRCUMSTANCES, EVEN IF ADVANTEST HAS BEEN ADVISED OF THE POSSIBILITY OF SUCH DAMAGES AND WHETHER ARISING OUT OF BREACH OF CONTRACT, WARRANTY, TORT (INCLUDING, WITHOUT LIMITATION, NEGLIGENCE), STRICT LIABILITY, INDEMNITY, CONTRIBUTION OR OTHERWISE. TORT (INCLUDING, WITHOUT LIMITATION, NEGLIGENCE), STRICT LIABILITY, INDEMNITY, CONTRIBUTION OR OTHERWISE.**
8. **OTHER THAN THE REMEDY FOR THE BREACH OF WARRANTY SET FORTH HEREIN, ADVANTEST SHALL NOT BE LIABLE FOR, AND HEREBY DISCLAIMS TO THE FULLEST EXTENT PERMITTED BY LAW ANY LIABILITY FOR, DAMAGES FOR PRODUCT FAILURE OR DEFECT, WHETHER ARISING OUT OF BREACH OF CONTRACT, TORT (INCLUDING, WITHOUT LIMITATION, NEGLIGENCE), STRICT LIABILITY, INDEMNITY, CONTRIBUTION OR OTHERWISE.**



## **CUSTOMER SERVICE DESCRIPTION**

In order to maintain safe and trouble-free operation of the Product and to prevent the incurrence of unnecessary costs and expenses, Advantest recommends a regular preventive maintenance program under its maintenance agreement.

Advantest's maintenance agreement provides the Purchaser on-site and off-site maintenance, parts, maintenance machinery, regular inspections, and telephone support and will last a maximum of ten years from the date the delivery of the Product. For specific details of the services provided under the maintenance agreement, please contact the nearest Advantest office listed at the end of this Operation Manual or Advantest's sales representatives.

Some of the components and parts of this Product have a limited operating life (such as, electrical and mechanical parts, fan motors, unit power supply, etc.). Accordingly, these components and parts will have to be replaced on a periodic basis. If the operating life of a component or part has expired and such component or part has not been replaced, there is a possibility that the Product will not perform properly. Additionally, if the operating life of a component or part has expired and continued use of such component or part damages the Product, the Product may not be repairable. Please contact the nearest Advantest office listed at the end of this Operation Manual or Advantest's sales representatives to determine the operating life of a specific component or part, as the operating life may vary depending on various factors such as operating condition and usage environment.

## SALES & SUPPORT OFFICES

Advantest Korea Co., Ltd.

22BF, Kyobo KangNam Tower,  
1303-22, Seocho-Dong, Seocho-Ku, Seoul #137-070, Korea  
Phone: +82-2-532-7071  
Fax: +82-2-532-7132

Advantest (Suzhou) Co., Ltd.

Shanghai Branch Office:  
Bldg. 6D, NO.1188 Gumei Road, Shanghai, China 201102 P.R.C.  
Phone: +86-21-6485-2725  
Fax: +86-21-6485-2726

Shanghai Branch Office:  
406/F, Ying Building, Quantum Plaza, No. 23 Zhi Chun Road,  
Hai Dian District, Beijing,  
China 100083  
Phone: +86-10-8235-3377  
Fax: +86-10-8235-6717

Advantest (Singapore) Pte. Ltd.

438A Alexandra Road, #08-03/06  
Alexandra Technopark Singapore 119967  
Phone: +65-6274-3100  
Fax: +65-6274-4055

Advantest America, Inc.

3201 Scott Boulevard, Suite, Santa Clara, CA 95054, U.S.A  
Phone: +1-408-988-7700  
Fax: +1-408-987-0691

ROHDE & SCHWARZ Europe GmbH

Mühldorfstraße 15 D-81671 München, Germany  
(P.O.B. 80 14 60 D-81614 München, Germany)  
Phone: +49-89-4129-13711  
Fax: +49-89-4129-13723

**ADVANTEST®**

<http://www.advantest.co.jp>