ADVANTEST[®]

ADVANTEST CORPORATION

R3967 OPT10/11

Multiport Test Adapter

Operation Manual

MANUAL NUMBER FOE-8339657C00

Safety Summary

To ensure thorough understanding of all functions and to ensure efficient use of this instrument, please read the manual carefully before using. Note that Advantest bears absolutely no responsibility for the result of operations caused due to incorrect or inappropriate use of this instrument.

If the equipment is used in a manner not specified by Advantest, the protection provided by the equipment may be impaired.

- **Warning Labels**

Warning labels are applied to Advantest products in locations where specific dangers exist. Pay careful attention to these labels during handling. Do not remove or tear these labels. If you have any questions regarding warning labels, please ask your nearest Advantest dealer. Our address and phone number are listed at the end of this manual.

Symbols of those warning labels are shown below together with their meaning.

DANGER: Indicates an imminently hazardous situation which will result in death or serious personal injury.

WARNING: Indicates a potentially hazardous situation which will result in death or serious personal injury.

CAUTION: Indicates a potentially hazardous situation which will result in personal injury or a damage to property including the product.

- **Basic Precautions**

Please observe the following precautions to prevent fire, burn, electric shock, and personal injury.

- Use a power cable rated for the voltage in question. Be sure however to use a power cable conforming to safety standards of your nation when using a product overseas.
- When inserting the plug into the electrical outlet, first turn the power switch OFF and then insert the plug as far as it will go.
- When removing the plug from the electrical outlet, first turn the power switch OFF and then pull it out by gripping the plug. Do not pull on the power cable itself. Make sure your hands are dry at this time.
- Before turning on the power, be sure to check that the supply voltage matches the voltage requirements of the instrument.
- Connect the power cable to a power outlet that is connected to a protected ground terminal. Grounding will be defeated if you use an extension cord which does not include a protected ground terminal.
- Be sure to use fuses rated for the voltage in question.
- Do not use this instrument with the case open.
- Do not place anything on the product and do not apply excessive pressure to the product. Also, do not place flower pots or other containers containing liquid such as chemicals near this

product.

- When the product has ventilation outlets, do not stick or drop metal or easily flammable objects into the ventilation outlets.
- When using the product on a cart, fix it with belts to avoid its drop.
- When connecting the product to peripheral equipment, turn the power off.

- **Caution Symbols Used Within this Manual**

Symbols indicating items requiring caution which are used in this manual are shown below together with their meaning.

DANGER: Indicates an item where there is a danger of serious personal injury (death or serious injury).

WARNING: Indicates an item relating to personal safety or health.

CAUTION: Indicates an item relating to possible damage to the product or instrument or relating to a restriction on operation.

- **Safety Marks on the Product**

The following safety marks can be found on Advantest products.



: ATTENTION - Refer to manual.



: Protective ground (earth) terminal.



: DANGER - High voltage.



: CAUTION - Risk of electric shock.

- **Replacing Parts with Limited Life**

The following parts used in the instrument are main parts with limited life.

Replace the parts listed below before their expected lifespan has expired to maintain the performance and function of the instrument.

Note that the estimated lifespan for the parts listed below may be shortened by factors such as the environment where the instrument is stored or used, and how often the instrument is used. The parts inside are not user-replaceable. For a part replacement, please contact the Advantest sales office for servicing.

Each product may use parts with limited life.

For more information, refer to the section in this document where the parts with limited life are described.

Main Parts with Limited Life

Part name	Life
Unit power supply	5 years
Fan motor	5 years
Electrolytic capacitor	5 years
LCD display	6 years
LCD backlight	2.5 years
Floppy disk drive	5 years
Memory backup battery	5 years

- **Hard Disk Mounted Products**

The operational warnings are listed below.

- Do not move, shock and vibrate the product while the power is turned on.
Reading or writing data in the hard disk unit is performed with the memory disk turning at a high speed. It is a very delicate process.
- Store and operate the products under the following environmental conditions.
An area with no sudden temperature changes.
An area away from shock or vibrations.
An area free from moisture, dirt, or dust.
An area away from magnets or an instrument which generates a magnetic field.
- Make back-ups of important data.
The data stored in the disk may become damaged if the product is mishandled. The hard disc has a limited life span which depends on the operational conditions. Note that there is no guarantee for any loss of data.

- **Precautions when Disposing of this Instrument**

When disposing of harmful substances, be sure dispose of them properly with abiding by the state-provided law.

Harmful substances: (1) PCB (polycarbon biphenyl)
(2) Mercury
(3) Ni-Cd (nickel cadmium)
(4) Other
Items possessing cyan, organic phosphorous and hexadic chromium and items which may leak cadmium or arsenic (excluding lead in solder).

Example: fluorescent tubes, batteries

Environmental Conditions

This instrument should be only be used in an area which satisfies the following conditions:

- An area free from corrosive gas
- An area away from direct sunlight
- A dust-free area
- An area free from vibrations
- Altitude of up to 2000 m

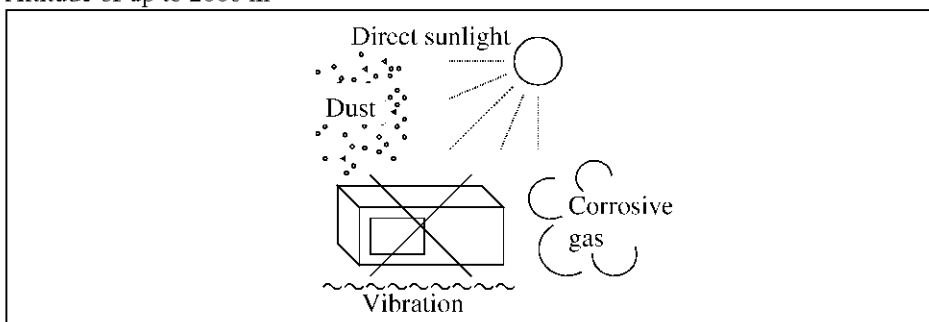

Figure-1 Environmental Conditions

- Operating position

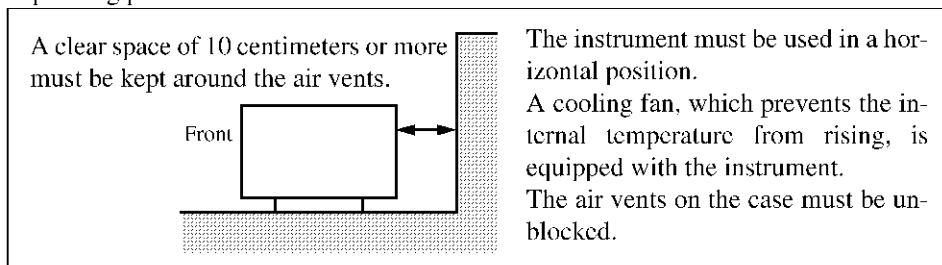

Figure-2 Operating Position

- Storage position

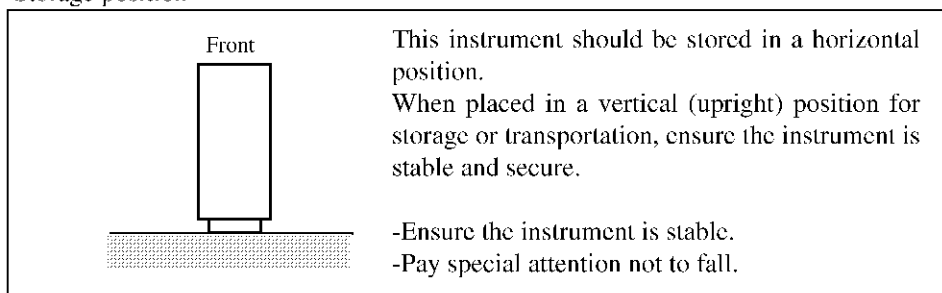

Figure-3 Storage Position

- The classification of the transient over-voltage, which exists typically in the main power supply, and the pollution degree is defined by IEC61010-1 and described below.

Impulse withstand voltage (over-voltage) category II defined by IEC60364-4-443

Pollution Degree 2

Types of Power Cable

Replace any references to the power cable type, according to the following table, with the appropriate power cable type for your country.

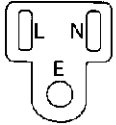
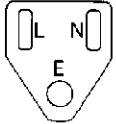
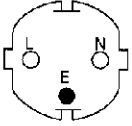
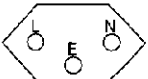
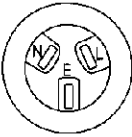
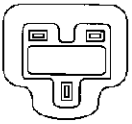
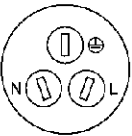
Plug configuration	Standards	Rating, color and length	Model number (Option number)
	PSE: Japan Electrical Appliance and Material Safety Law	125 V at 7 A Black 2 m (6 ft)	Straight: A01402 Angled: A01412
	UL: United States of America CSA: Canada	125 V at 7 A Black 2 m (6 ft)	Straight: A01403 (Option 95) Angled: A01413
	CEE: Europe DEMKO: Denmark NEMKO: Norway VDE: Germany KEMA: The Netherlands CEBEC: Belgium OVE: Austria FIMKO: Finland SEMKO: Sweden	250 V at 6 A Gray 2 m (6 ft)	Straight: A01404 (Option 96) Angled: A01414
	SEV: Switzerland	250 V at 6 A Gray 2 m (6 ft)	Straight: A01405 (Option 97) Angled: A01415
	SAA: Australia, New Zealand	250 V at 6 A Gray 2 m (6 ft)	Straight: A01406 (Option 98) Angled: -----
	BS: United Kingdom	250 V at 6 A Black 2 m (6 ft)	Straight: A01407 (Option 99) Angled: A01417
	CCC: China	250 V at 10 A Black 2 m (6 ft)	Straight: A114009 (Option 94) Angled: A114109

Certificate of Conformity



This is to certify, that

Multiport Test Adapter

R3967 Series

instrument, type, designation

complies with the provisions of the EMC Directive 89/336/EEC in accordance with EN50081-1 and EN50082-1 and Low Voltage Directive 73/23/EEC in accordance with EN61010.

ADVANTEST Corp.

Tokyo, Japan

ROHDE&SCHWARZ

Engineering and Sales GmbH
Munich, Germany

PREFACE

- This manual describes the following test adapters:

Five-port test adapter: The R3967 OPT10

Six-port test adapter: The R3967 OPT 11

TABLE OF CONTENTS

1.	INTRODUCTION	1-1
1.1	Products Overview	1-1
1.2	Master Instrument	1-1
1.3	Accessories	1-1
1.4	Operating Environment	1-2
1.4.1	Environmental Conditions	1-2
1.5	Notes on Use	1-3
1.6	Cleaning, Storage and Transportation	1-5
1.6.1	Cleaning	1-5
1.6.2	Storage	1-5
1.6.3	Transportation	1-6
1.7	Warm-up	1-6
1.8	Calibration	1-6
2.	PANEL DESCRIPTION	2-1
2.1	Front Panel Description	2-1
2.2	Rear Panel Description	2-3
3.	NETWORK ANALYZER SETUP	3-1
3.1	RF cable connections	3-1
3.2	Control Cable Connections	3-2
4.	BASIC MEASUREMENTS	4-1
4.1	Measurement Overview	4-1
4.2	Measurement Examples	4-3
4.2.1	R3967 OPT10 (Five-port Test Adapter) Measurement Example	4-3
4.2.2	R3967 OPT11 (Six-port Test Adapter) Measurement Example	4-7
5.	OPERATION DESCRIPTION	5-1
5.1	Operation of the R3967 OPT10	5-1
5.2	Operation of the R3967 OPT11	5-3
6.	PERFORMANCE TESTS	6-1
6.1	Preparations for the Tests	6-1
6.1.1	Warm-up	6-1
6.1.2	Instrument Preparation	6-1
6.1.3	General Note	6-1
6.2	Test Port Load Match	6-2
6.2.1	For the R3967 OPT10	6-2
6.2.2	For the R3967 OPT11	6-8
6.3	Insertion Loss	6-16
6.3.1	For the R3967 OPT10	6-16

Table of Contents

6.3.2	For the R3967 OPT11	6-23
7.	SPECIFICATIONS	7-1
7.1	Specifications for the R3967 OPT10	7-1
7.2	Specifications for the R3967 OPT11	7-2
	APPENDIX	A-1
A.1	Function Extension and Configuration Extension Function	A-1
A.1.1	FUNCTION extension (to choose between the test adapter measurement paths)	A-1
A.1.2	Calibration function extension (to save calibration data and measurement conditions temporarily)	A-1
A.1.3	Soft Menu Key	A-2
A.1.4	GPIB COMMAND LIST	A-3
A.1.5	GPIB Program EXAMPLE	A-4
	DIMENSIONAL OUTLINE DRAWING	EXT-1
	ALPHABETICAL INDEX	I-1

LIST OF ILLUSTRATIONS

No.	Title	Page
1-1	Operating Environment	1-2
1-2	Human body	1-4
1-3	Floor in the work area	1-4
1-4	Benchboard	1-5
2-1	R3967 OPT10 Front Panel	2-1
2-2	R3967 OPT11 Front Panel	2-2
2-3	R3967 OPT10 / R3967 OPT11 Rear Panel	2-3
3-1	RF Cable Connections (R3967 OPT10)	3-1
3-2	RF Cable Connections (R3967 OPT11)	3-1
3-3	Control Cable Connections	3-2
4-1	R3967 OPT10 Setup Diagram	4-3
4-2	Example Using ANT1 Tx1 Rx1	4-5
4-3	Example Using ANT1 Tx2 Rx2	4-6
4-4	R3967 OPT11 Setup Diagram	4-7
4-5	Example Using ANT1 Tx1 Rx1	4-9
4-6	Example Using ANT2 Tx2 Rx2	4-9
5-1	R3967 OPT10 Block Diagram	5-2
5-2	R3967 OPT11 Block Diagram	5-4

LIST OF TABLES

No.	Title	Page
1-1	List of R3967 OPT10 / R3967 OPT11 Standard Accessories	1-1
2-1	Front Panel Description (R3967 OPT10)	2-1
2-2	Front Panel Description (R3967 OPT11)	2-2
2-3	Rear Panel Description	2-3
4-1	Combinations of Measurement Paths (For R3967 OPT10 (Five-port Test Adapter))	4-1
4-2	Combinations of Measurement Paths (For R3967 OPT11 (Six-port Test Adapter))	4-2
6-1	Required Measurement Instrument for Performance Test	6-1

1. INTRODUCTION

This chapter provides the following information:

- Product description
- Accessories
- Operating environment
- How to clean, store, and transport the R3967 OPT10 / R3967 OPT11

1.1 Products Overview

The R3967 OPT10 is a five-port test adapter which is connected to the R3767CG OPT11 network analyzer to measure transmission and reflection characteristics of five-port devices. The test adapter allows you to measure S parameters of five-port devices without changing the device connections.

The R3967 OPT11 is a six-port test adapter which is connected to the R3767CG OPT11 network analyzer to measure transmission and reflection characteristics of two sets of duplexers. The test adapter allows you to measure S parameters of two duplexer devices without changing the device connections.

In addition, when this instrument is connected to the R3767CG OPT11 network analyzer, the expansion and calibration expansion functions are enabled.

Any of these functions allows a high-speed switching much faster than those used in earlier Save/Call functions because the data to be saved are limited only to calibration data and measurement conditions (RESPONSE and STIMULUS).

1.2 Master Instrument

The master instrument for this test adapter is used is listed below:

R3767 CG OPT11 Network Analyzer (Firmware revision SYS B00 or later).

1.3 Accessories

Table 1-1 list the standard accessories that come with the instrument. If any of the accessories are damaged or missing, contact a sales representative. Order new accessories by type name.

Table 1-1 List of R3967 OPT10 / R3967 OPT11 Standard Accessories

Part name	Type name	Remarks
N -to-N cable	A01247	3
Control cable	A01293	1
Operation manual	ER3967	1

1.4 Operating Environment

1.4 Operating Environment

This section describes the environmental conditions and power requirements necessary to use the R3967 OPT10 / R3967 OPT11.

1.4.1 Environmental Conditions

The R3967 OPT10 / R3967 OPT11 should be only be used in an area which satisfies the following conditions:

- Ambient temperature: +5°C to +40°C (Operating temperature range: When the floppy disk drive is used)
0°C to +50°C (Operating temperature range: When the floppy disk drive is used)
-20°C to +60°C (Storage temperature range)
- Relative humidity: 80% or less (without condensation)
- An area free from corrosive gas
- An area away from direct sunlight
- A dust-free area
- An area free from vibrations
- A low noise area

Although the R3967 OPT10 / R3967 OPT11 has been designed to withstand a certain amount of noise riding on the AC power line, it should be used in an area of low noise. Use a noise cut filter when ambient noise is unavoidable.

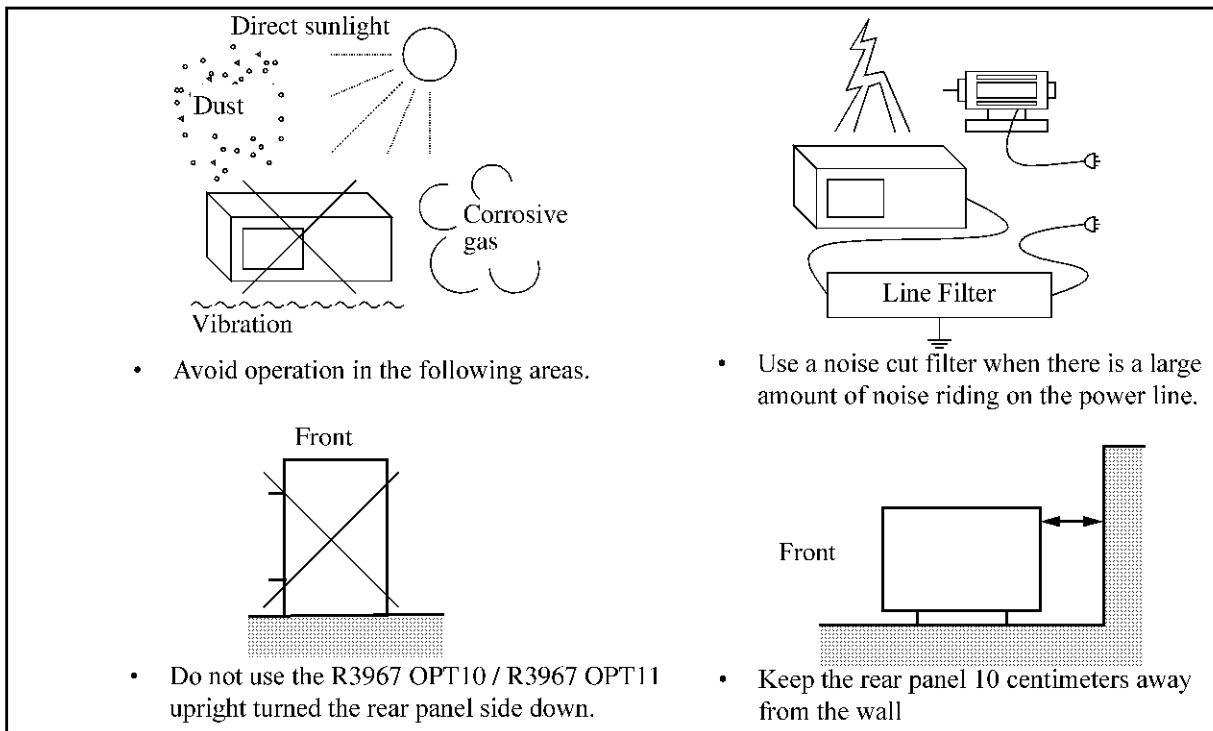

Figure 1-1 Operating Environment

The R3967 OPT10 / R3967 OPT11 can be used safely under the following conditions:

- Altitude of up to 2000 m
- Installation Categories II
- Pollution Degree 2

1.5 Notes on Use

1. Before starting the measurement

Prior to turning the network analyzer power, connect the cable from the network analyzer to the R3967 OPT10 / R3967 OPT11 on the rear panel sides.

NOTE: *When the network analyzer power is turned on, the R3967 OPT10 / R3967 OPT11 automatically recognizes the the R3967 OPT10 / R3967 OPT11 so that the network analyzer can control the the R3967 OPT10 / R3967 OPT11. As a result, when the the R3967 OPT10 / R3967 OPT11 is connected to the network analyzer after the network analyzer power has been turned on, no functions to control the R3967 OPT10 / R3967 OPT11 are available.*

2. Removing of case

Do not open the case to one except service man of our company. The R3967 OPT10 / R3967 OPT11 has a high temperature part and a high pressure part.

3. When abnormality occurs

When smoke rises from the R3967 OPT10 / R3967 OPT11, smell nastily, or rear unusual sound feel, turn off the power switch. Pull out power cable from the outlet. And contact to our company.

The address and the telephone number of our company are in the end of this manual.

4. Electromagnetic interference.

Electromagnetic interference may be caused to the television or the radio.

If the R3967 OPT10 / R3967 OPT11 power is turned off and the electromagnetic interference is reduced, then the R3967 OPT10 / R3967 OPT11 has caused the problem.

Prevent electromagnetic interference by the following procedure.

- Change the direction of antenna of the television or the radio.
- Place the R3967 OPT10 / R3967 OPT11 the other side of the television or the radio.
- Place the R3967 OPT10 / R3967 OPT11 away from the television or the radio.
- Use another line of power source for the television or the radio than the R3967 OPT10 / R3967 OPT11.

1.5 Notes on Use

5. Prevention of Electrostatic Buildup

To prevent damages to semiconductor parts from electrostatic discharge (ESD), the precautions shown below should be taken. We recommend that two or more measures be combined to provide adequate protection from ESD. (Static electricity can easily be built up when a person moves or an insulator is rubbed.)

Countermeasure example

Human body: Use of a wrist strap (see Figure 1-2).

Floor in the work area: Installation of a conductive mat, the use of conductive shoes, and grounding (see Figure 1-3).

Benchboard: Installation of a conductive mat and grounding (see Figure 1-4).

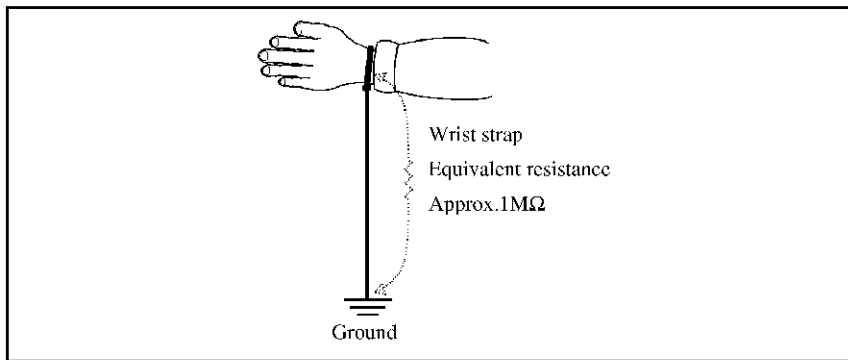

Figure 1-2 Human body

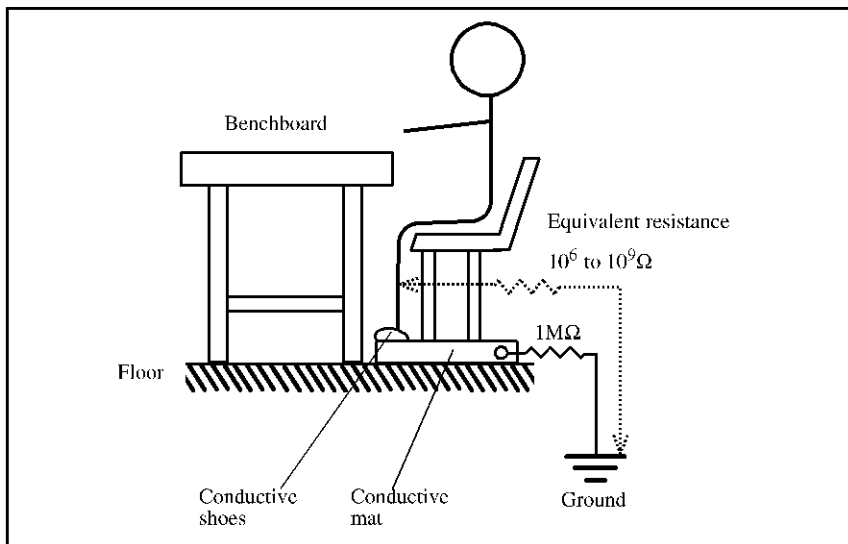

Figure 1-3 Floor in the work area

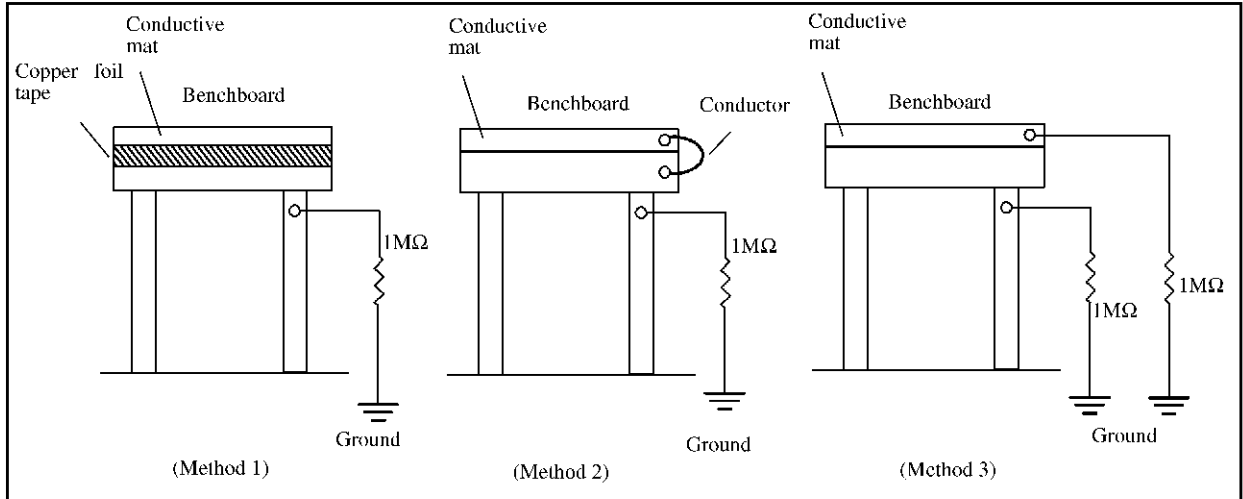

Figure 1-4 Benchboard

1.6 Cleaning, Storage and Transportation

1.6.1 Cleaning

Wipe the dirt of the R3967 OPT10 / R3967 OPT11 off with a soft cloth (or wet cloth). At this time, attend to the following points.

- Do not remain the fluff of the cloth and do not soak water into the internal of the R3967 OPT10 / R3967 OPT11.
- Do not use an organic solvent (for example, benzene and acetone, etc.) which changes plastics in quality.

1.6.2 Storage

Storage temperature of the R3967 OPT10 / R3967 OPT11 is from -20°C to $+60^{\circ}\text{C}$. Do not store it out of this temperature range.

The cases in which the R3967 OPT10 / R3967 OPT11 is not used for a long time, cover with the vinyl cover or put in the cardboard box and prevent dust. Keep it in a dry place where dust and direct sunshine are prevented.

1.6.3 Transportation

1.6.3 Transportation

When you ship the R3967 OPT10 / R3967 OPT11, use the original container and packing material. If the original packaging is not available, use the following repackaging guidelines:

1. To allow for cushioning, use a corrugated cardboard container that is at least 15 centimeters larger than those of the R3967 OPT10 / R3967 OPT11.
2. Surround the R3967 OPT10 / R3967 OPT11 with protective sheeting.
3. Cushion the R3967 OPT10 / R3967 OPT11 on all sides with packing material.
4. Seal the corrugated cardboard container with shipping tape or an industrial stapler.

If you are shipping the R3967 OPT10 / R3967 OPT11 to a sales representative for service or repair, attach a tag to the R3967 OPT10 / R3967 OPT11 that shows the following information:

- Owner and address
- Name of a contact person at your location
- Serial number of the R3967 OPT10 / R3967 OPT11 (located on the rear panel)
- Description of the service requested

1.7 Warm-up

After the R3967 OPT10 / R3967 OPT11 temperature has reached the room temperature level, turn the power switch ON and warm it up for 30 minutes.

1.8 Calibration

Calibration work should be performed at an ADVANTEST CORPORATION site. When you want to calibrate the R3967 OPT10 / R3967 OPT11, please contact a sales representative.

Desirable Period	One year
------------------	----------

2. PANEL DESCRIPTION

2.1 Front Panel Description

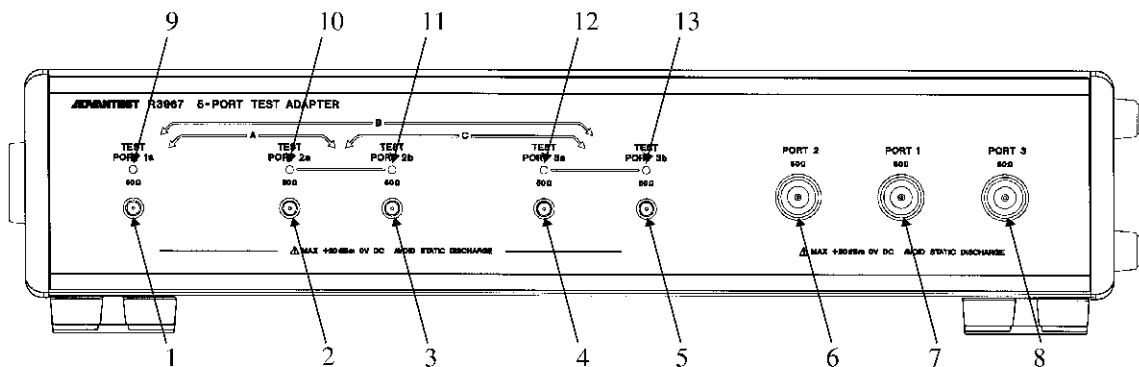

Figure 2-1 R3967 OPT10 Front Panel

Table 2-1 Front Panel Description (R3967 OPT10)

No.	Name of accessory	Description
1	TEST PORT 1a Connector	Measurements of TEST PORT 1a
2	TEST PORT 2a Connector	Measurements of TEST PORT 2a
3	TEST PORT 2b Connector	Measurements of TEST PORT 2b
4	TEST PORT 3a Connector	Measurements of TEST PORT 3a
5	TEST PORT 3b Connector	Measurements of TEST PORT 3b
6	PORT 2 Connector	Connected to TEST PORT 2 of the R3767CG OPT11.
7	PORT 1 Connector	Connected to TEST PORT 1 of the R3767CG OPT11.
8	PORT 3 Connector	Connected to TEST PORT 3 of the R3767CG OPT11.
9	TEST PORT 1a LED	Lit when TEST PORT 1a is connected to the signal source of the R3767CG OPT11.
10	TEST PORT 2a LED	Lit when TEST PORT 2a is connected to the signal source of the R3767CG OPT11.
11	TEST PORT 2b LED	Lit when TEST PORT 2b is connected to the signal source of the R3767CG OPT11.
12	TEST PORT 3a LED	Lit when TEST PORT 3a is connected to the signal source of the R3767CG OPT11.
13	TEST PORT 3b LED	Lit when TEST PORT 3b is connected to the signal source of the R3767CG OPT11.

2.1 Front Panel Description

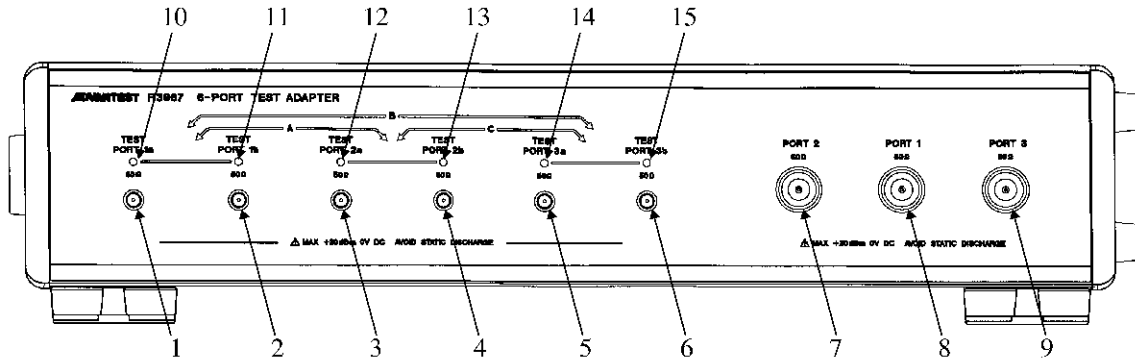

Figure 2-2 R3967 OPT11 Front Panel

Table 2-2 Front Panel Description (R3967 OPT11)

No.	Name of accessory	Description
1	TEST PORT 1a Connector	Measurements of TEST PORT 1a
2	TEST PORT 1b Connector	Measurements of TEST PORT 1b
3	TEST PORT 2a Connector	Measurements of TEST PORT 2a
4	TEST PORT 2b Connector	Measurements of TEST PORT 2b
5	TEST PORT 3a Connector	Measurements of TEST PORT 3a
6	TEST PORT 3b Connector	Measurements of TEST PORT 3b
7	PORT 2 Connector	Connected to TEST PORT 2 of the R3767CG OPT11.
8	PORT 1 Connector	Connected to TEST PORT 1 of the R3767CG OPT11.
9	PORT 3 Connector	Connected to TEST PORT 3 of the R3767CG OPT11.
10	TEST PORT 1a LED	Lit when TEST PORT 1a is connected to the signal source of the R3767CG OPT11.
11	TEST PORT 1b LED	Lit when TEST PORT 1b is connected to the signal source of the R3767CG OPT11.
12	TEST PORT 2a LED	Lit when TEST PORT 2a is connected to the signal source of the R3767CG OPT11.
13	TEST PORT 2b LED	Lit when TEST PORT 2b is connected to the signal source of the R3767CG OPT11.
14	TEST PORT 3a LED	Lit when TEST PORT 3a is connected to the signal source of the R3767CG OPT11.
15	TEST PORT 3b LED	Lit when TEST PORT 3b is connected to the signal source of the R3767CG OPT11.

2.2 Rear Panel Description

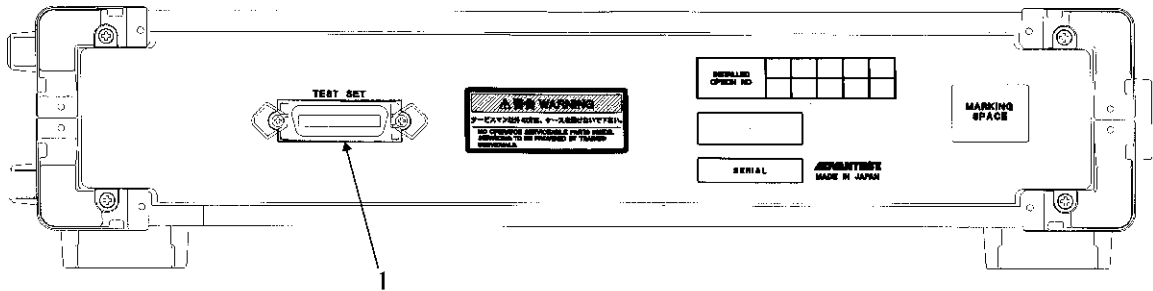

Figure 2-3 R3967 OPT10 / R3967 OPT11 Rear Panel

Table 2-3 Rear Panel Description

No.	Name of accessory	Description
1	TEST SET Connector	Connected to the TEST SET connector on the R3767CG OPT11.

3. NETWORK ANALYZER SETUP

The R3967 OPT10 / R3967 OPT11 can be connected to the R3767CG OPT11.

3.1 RF cable connections

Connect the N-N cables, which are supplied as standard accessories, from the R3967 OPT10 or R3967 OPT11 port to the R3767CG OPT11 port.

R3967 OPT10 / R3967 OPT11	R3767CG OPT11	Cable used
PORT 1	TEST PORT 1	A01247
PORT 2	TEST PORT 2	A01247
PORT 3	TEST PORT 3	A01247

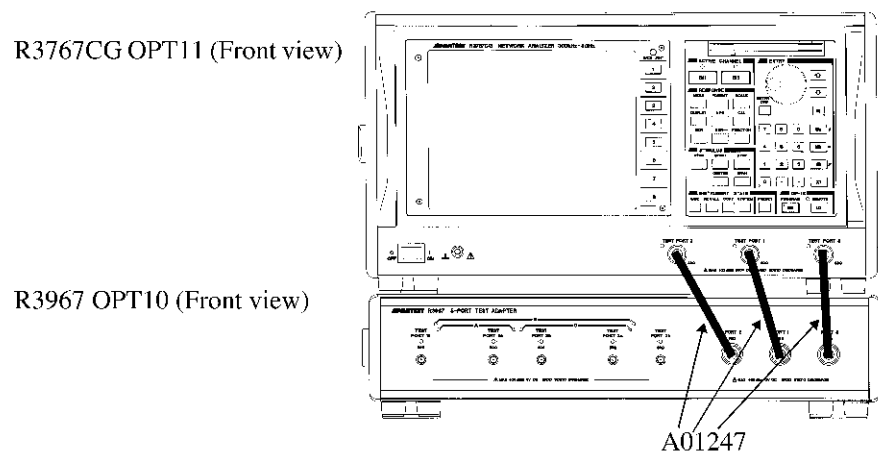

Figure 3-1 RF Cable Connections (R3967 OPT10)

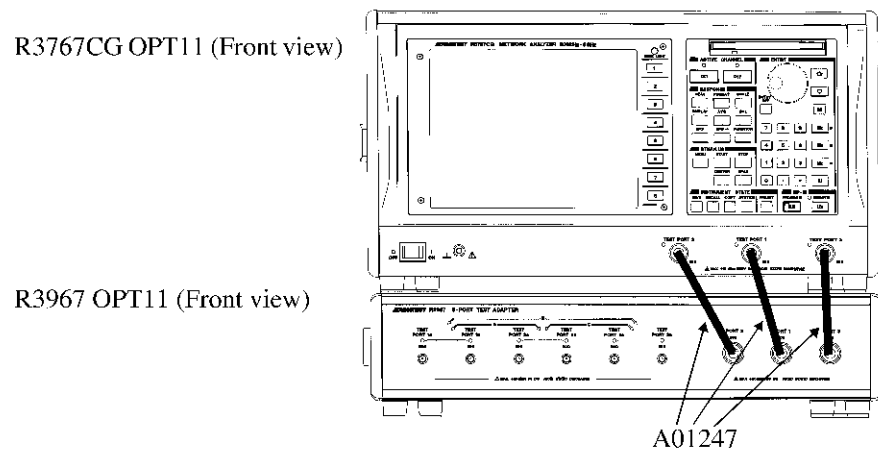

Figure 3-2 RF Cable Connections (R3967 OPT11)

3.2 Control Cable Connections

3.2 Control Cable Connections

Connect the N-N cables, which are supplied as standard accessories, from the R3967 OPT10 or R3967 OPT11 port to the R3767CG OPT11 port.

R3967 OPT10 / R3967 OPT11	R3767CG OPT11	Cable used
TEST SET	TEST SET	A01293

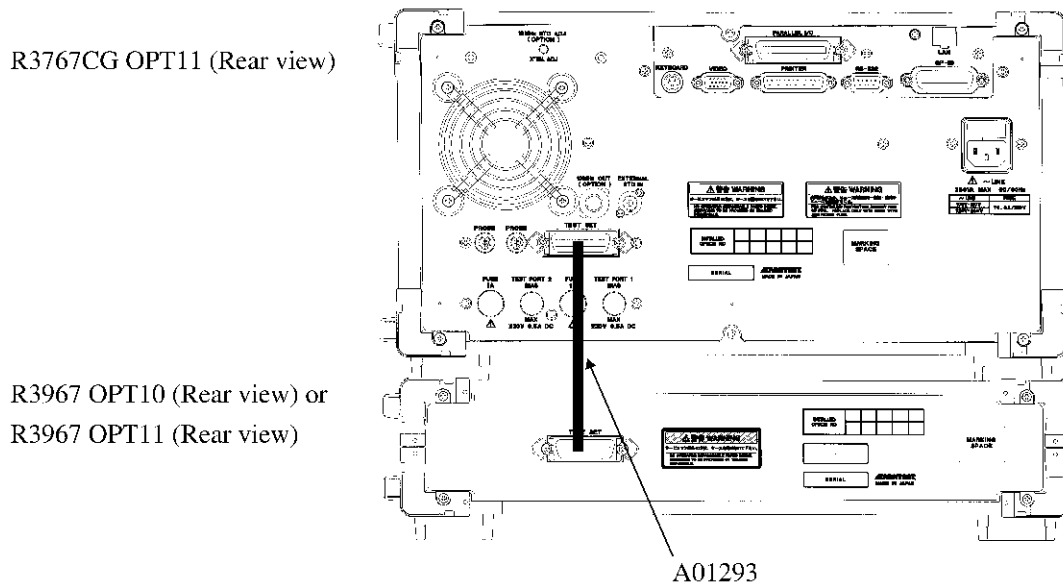

Figure 3-3 Control Cable Connections

4. BASIC MEASUREMENTS

4.1 Measurement Overview

CAUTION: Use the 50 Ω -system CAL kit and cables appropriate for the instrument being used. When calibrating the instrument, set the CAL kit type and FEMAL/MAL (polarity) according to the connector terminals used before making measurements.

Select a measurement path from the keys in the Port menu so that S parameters can be measured using the [MEAS] key.

The combinations of measurement paths to measure S parameters are listed in Table 4-1 and Table 4-2.

Table 4-1 Combinations of Measurement Paths (For R3967 OPT10 (Five-port Test Adapter))

	ANT1 Tx1 Rx1	ANT1 Tx1 Rx2	ANT1 Tx2 Rx1	ANT1 Tx2 Rx2
S11	Reflection characteristics of TEST PORT 1a	Reflection characteristics of TEST PORT 1a	Reflection characteristics of TEST PORT 1a	Reflection characteristics of TEST PORT 1a
S22	Reflection characteristics of TEST PORT 2a	Reflection characteristics of TEST PORT 2a	Reflection characteristics of TEST PORT 2b	Reflection characteristics of TEST PORT 2b
S33	Reflection characteristics of TEST PORT 3a	Reflection characteristics of TEST PORT 3b	Reflection characteristics of TEST PORT 3a	Reflection characteristics of TEST PORT 3b
S21	Transmission characteristics of TEST PORT 1a to 2a	Transmission characteristics of TEST PORT 1a to 2a	Transmission characteristics of TEST PORT 1a to 2b	Transmission characteristics of TEST PORT 1a to 2b
S12	Transmission characteristics of TEST PORT 2a to 1a	Transmission characteristics of TEST PORT 2a to 1a	Transmission characteristics of TEST PORT 2b to 1a	Transmission characteristics of TEST PORT 2b to 1a
S31	Transmission characteristics of TEST PORT 1a to 3a	Transmission characteristics of TEST PORT 1a to 3b	Transmission characteristics of TEST PORT 1a to 3a	Transmission characteristics of TEST PORT 1a to 3b
S13	Transmission characteristics of TEST PORT 3a to 1a	Transmission characteristics of TEST PORT 3b to 1a	Transmission characteristics of TEST PORT 3a to 1a	Transmission characteristics of TEST PORT 3b to 1a
S23	Transmission characteristics of TEST PORT 3a to 2a	Transmission characteristics of TEST PORT 3b to 2a	Transmission characteristics of TEST PORT 3a to 2b	Transmission characteristics of TEST PORT 3b to 2b
S32	Transmission characteristics of TEST PORT 2a to 3a	Transmission characteristics of TEST PORT 2a to 3b	Transmission characteristics of TEST PORT 2b to 3a	Transmission characteristics of TEST PORT 2b to 3b

4.1 Measurement Overview

Table 4-2 Combinations of Measurement Paths (For R3967 OPT11 (Six-port Test Adapter))

	ANT1 Tx1 Rx1	ANT1 Tx1 Rx2	ANT1 Tx2 Rx1	ANT1 Tx2 Rx2
S11	Reflection characteristics of TEST PORT 1a	Reflection characteristics of TEST PORT 1a	Reflection characteristics of TEST PORT 1a	Reflection characteristics of TEST PORT 1a
S22	Reflection characteristics of TEST PORT 2a	Reflection characteristics of TEST PORT 2a	Reflection characteristics of TEST PORT 2b	Reflection characteristics of TEST PORT 2b
S33	Reflection characteristics of TEST PORT 3a	Reflection characteristics of TEST PORT 3b	Reflection characteristics of TEST PORT 3a	Reflection characteristics of TEST PORT 3b
S21	Transmission characteristics of TEST PORT 1a to 2a	Transmission characteristics of TEST PORT 1a to 2a	Transmission characteristics of TEST PORT 1a to 2b	Transmission characteristics of TEST PORT 1a to 2b
S12	Transmission characteristics of TEST PORT 2a to 1a	Transmission characteristics of TEST PORT 2a to 1a	Transmission characteristics of TEST PORT 2b to 1a	Transmission characteristics of TEST PORT 2b to 1a
S31	Transmission characteristics of TEST PORT 1a to 3a	Transmission characteristics of TEST PORT 1a to 3b	Transmission characteristics of TEST PORT 1a to 3a	Transmission characteristics of TEST PORT 1a to 3b
S13	Transmission characteristics of TEST PORT 3a to 1a	Transmission characteristics of TEST PORT 3b to 1a	Transmission characteristics of TEST PORT 3a to 1a	Transmission characteristics of TEST PORT 3b to 1a
S23	Transmission characteristics of TEST PORT 3a to 2a	Transmission characteristics of TEST PORT 3b to 2a	Transmission characteristics of TEST PORT 3a to 2b	Transmission characteristics of TEST PORT 3b to 2b
S32	Transmission characteristics of TEST PORT 2a to 3a	Transmission characteristics of TEST PORT 2a to 3b	Transmission characteristics of TEST PORT 2b to 3a	Transmission characteristics of TEST PORT 2b to 3b

	ANT2 Tx1 Rx1	ANT2 Tx1 Rx2	ANT2 Tx2 Rx1	ANT2 Tx2 Rx2
S11	Reflection characteristics of TEST PORT 1b	Reflection characteristics of TEST PORT 1b	Reflection characteristics of TEST PORT 1b	Reflection characteristics of TEST PORT 1b
S22	Reflection characteristics of TEST PORT 2a	Reflection characteristics of TEST PORT 2a	Reflection characteristics of TEST PORT 2b	Reflection characteristics of TEST PORT 2b
S33	Reflection characteristics of TEST PORT 3a	Reflection characteristics of TEST PORT 3b	Reflection characteristics of TEST PORT 3a	Reflection characteristics of TEST PORT 3b
S21	Transmission characteristics of TEST PORT 1b to 2a	Transmission characteristics of TEST PORT 1b to 2a	Transmission characteristics of TEST PORT 1b to 2b	Transmission characteristics of TEST PORT 1b to 2b
S12	Transmission characteristics of TEST PORT 2a to 1b	Transmission characteristics of TEST PORT 2a to 1b	Transmission characteristics of TEST PORT 2b to 1b	Transmission characteristics of TEST PORT 2b to 1b
S31	Transmission characteristics of TEST PORT 1b to 3a	Transmission characteristics of TEST PORT 1b to 3b	Transmission characteristics of TEST PORT 1b to 3a	Transmission characteristics of TEST PORT 1b to 3b
S13	Transmission characteristics of TEST PORT 3a to 1b	Transmission characteristics of TEST PORT 3b to 1b	Transmission characteristics of TEST PORT 3a to 1b	Transmission characteristics of TEST PORT 3b to 1b
S23	Transmission characteristics of TEST PORT 3a to 2a	Transmission characteristics of TEST PORT 3b to 2a	Transmission characteristics of TEST PORT 3a to 2b	Transmission characteristics of TEST PORT 3b to 2b
S32	Transmission characteristics of TEST PORT 2a to 3a	Transmission characteristics of TEST PORT 2a to 3b	Transmission characteristics of TEST PORT 2b to 3a	Transmission characteristics of TEST PORT 2b to 3b

4.2 Measurement Examples

4.2.1 R3967 OPT10 (Five-port Test Adapter) Measurement Example

This example shows how to measure the transmission and reflection characteristics in four-screen display mode.

A five-port device (common use of the ANT terminal) with frequencies of 880 MHz /1.6 GHz is used.

1. Figure 4-1 shows the setup.

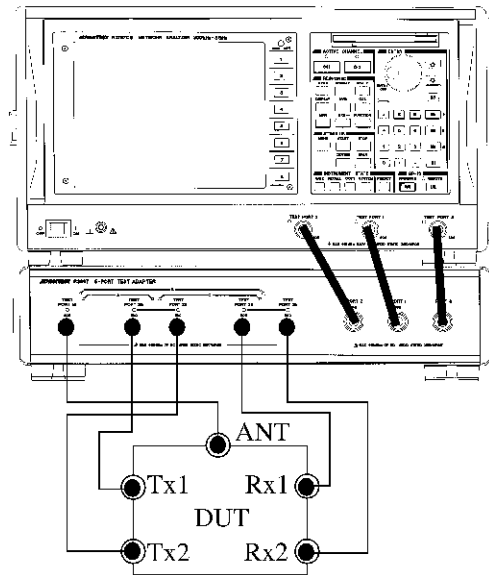

Figure 4-1 R3967 OPT10 Setup Diagram

2. Press **[PRESET]**.

4.2.1 R3967 OPT10 (Five-port Test Adapter) Measurement Example

3. Set up the network analyzer to measure ANT1 Tx1 Rx1 of the device.

Block name	Setting	Key operation
ACTIVE CHANNEL	Sets channel 1.	[CH]
RESPONSE	Sets the display.	[DISPLAY] → {DUAL ON} → {SPLIT ON}
	Sets the input port of the receiving section.	[MEAS] → {TWIN MEAS P1-P2 ON} → {S22&I2(P2→P1)}
	Sets measurement format.	[FORMAT] → {LOGMAG}
	Sets the scale.	[SCALE] → {/DEV} → [1] → [0] → [×1] → {TRACE 2nd} → {/DEV} → [1] → [0] → [×1]
	Sets the RBW.	[AVG] → {IF RBW} → [3] → [kHz]
	Sets the test adapter path.	[FUNCTION] → {MULTI PORT} → {ANTI Tx1 Rx1}
STIMULUS	Sets the coupled CH.	[MENU] → {COUPLED CH OFF}
	Center frequency	[CENTER] → [8] → [8] → [0] → [.] → [2] → [5] → [MHz]
	Span frequency	[SPAN] → [3] → [0] → [0] → [MHz]
ACTIVE CHANNEL	Sets Channel 2.	[CH2]
RESPONSE	Sets the input port of the receiving section.	[MEAS] → {TWIN MEAS P1-P3 ON} → {S33&I3(P1←P3)}
	Sets measurement format.	[FORMAT] → {LOGMAG}
	Sets the scale.	[SCALE] → {/DEV} → [1] → [0] → [×1] → {TRACE 2nd} → {/DEV} → [1] → [0] → [×1]
	Sets the RBW.	[AVG] → {IF RBW} → [3] → [kHz]
STIMULUS	Center frequency	[CENTER] → [8] → [3] → [8] → [MHz]
	Span frequency	[SPAN] → [3] → [0] → [0] → [MHz]

4. Perform the calibration (two-port full calibration).
(Perform a two-port full calibration between TEST PORT 1a and TEST PORT 2a, and between TEST PORT 1a and TEST PORT 3a for a five-port test adapter.)
5. Temporarily save the calibration data and measurement conditions previously used successfully.
[FUNCTION] → {MULTI PORT} → {CORRECTION COPY}

4.2.1 R3967 OPT10 (Five-port Test Adapter) Measurement Example

- Set up the analyzer as follows to measure ANT1 Tx2 Rx2 of the device.

Block name	Setting	Key operation
ACTIVE CHANNEL	Sets channel 1.	[CH1]
RESPONSE	Sets the test adapter path.	[FUNCTION] → {MULTI PORT} → {ANT1 Tx2 Rx2}
STIMULUS	Center frequency	[CENTER] → [1] → [8] → [5] → [0] → [MHz]
	Span frequency	[SPAN] → [7] → [5] → [0] → [MHz]
ACTIVE CHANNEL	Sets Channel 2.	[CH2]
STIMULUS	Center frequency	[CENTER] → [1] → [6] → [5] → [0] → [MHz]
	Span frequency	[SPAN] → [7] → [5] → [0] → [MHz]

- Perform a two-port full calibration.
(Perform a two-port full calibration between TEST PORT 1a and TEST PORT 2b, and between TEST PORT 1a and TEST PORT 3b for a five-port test adapter.)
- Temporarily save the calibration data and measurement conditions previously obtained.
[FUNCTION] → {MULTI PORT} → {CORRECTION COPY}
- Make measurements using the path exchange key in the MULTI PORT menu.
An example is shown below (Exchange key: {ANT1 Tx1 Rx1} and {ANT1 Tx2 Rx2}).

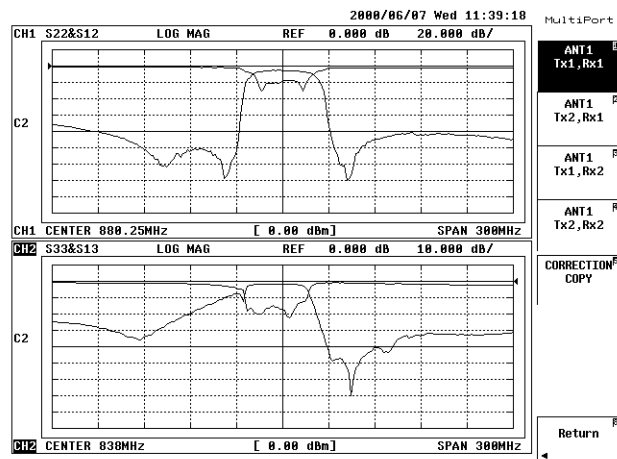

Figure 4-2 Example Using ANT1 Tx1 Rx1

4.2.1 R3967 OPT10 (Five-port Test Adapter) Measurement Example

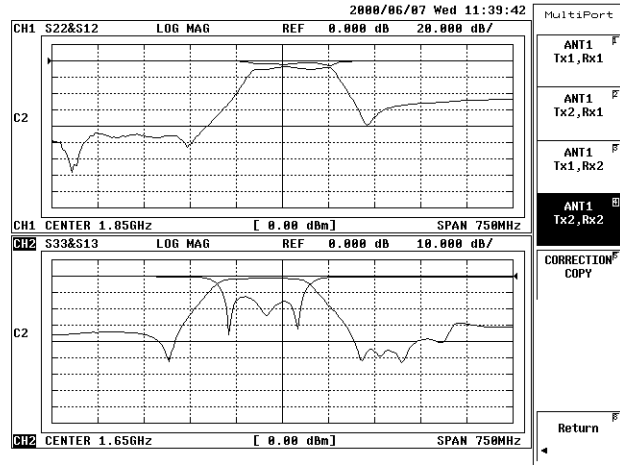

Figure 4-3 Example Using ANT1 Tx2 Rx2

4.2.2 R3967 OPT11 (Six-port Test Adapter) Measurement Example

This example shows how to measure the transmission and reflection characteristics in four-screen display mode.

Two sets of three-port devices with frequencies of 880 MHz are used.

1. Figure 4-4 shows the setup.

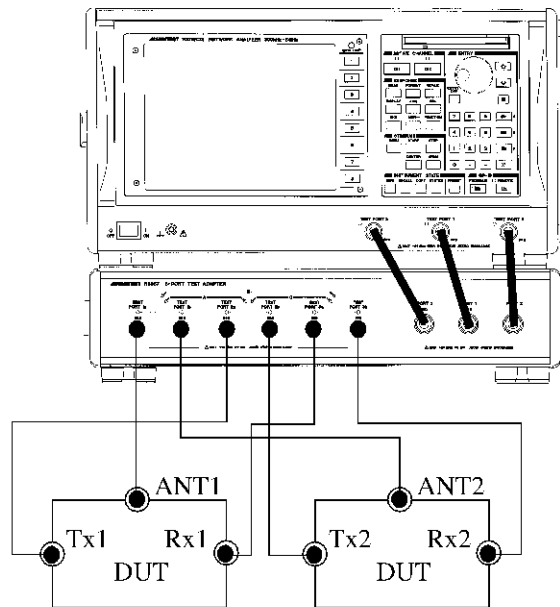

Figure 4-4 R3967 OPT11 Setup Diagram

2. Press **[PRESET]**.
3. Set up the network analyzer to measure ANT1 Tx1 Rx1 of the device.

Block name	Setting	Key operation
ACTIVE CHANNEL	Sets channel 1.	[CH1]
RESPONSE	Sets the display.	[DISPLAY] → {DUAL ON} → {SPLIT ON}
	Sets the input port of the receiving section.	[MEAS] → {TWIN MEAS P1-P2 ON} → {S22&I2(P2→P1)}
	Sets measurement format.	[FORMAT] → {LOGMAG}
	Sets the scale.	[SCALE] → {/DEV} → [1] → [0] → [×1] → {TRACE 2nd} → {/DEV} → [1] → [0] → [×1]
	Sets the RBW.	[AVG] → {IF RBW} → [3] → [kHz]
	Sets the test adapter path.	[FUNCTION] → {MULTI PORT} → {ANT1 Tx1 Rx1}

4.2.2 R3967 OPT11 (Six-port Test Adapter) Measurement Example

Block name	Setting	Key operation
STIMULUS	Sets the coupled CH.	[MENU] → {COUPLED CH OFF}
	Center frequency	[CENTER] → [8] → [8] → [0] → [.] → [2] → [5] → [MHz]
	Span frequency	[SPAN] → [3] → [0] → [0] → [MHz]
ACTIVE CHANNEL	Sets Channel 2.	[CH2]
RESPONSE	Sets the input port of the receiving section.	[MEAS] → {TEST-PORT CONNECTION(P1-P2)} → {TEST-PORT CONNECTION(P1-P3)} → {TWIN MEAS P1-P3 ON} → {S33&13(P1←P3)}
	Sets measurement format.	[FORMAT] → {LOGMAG}
	Sets the scale.	[SCALE] → {/DEV} → [1] → [0] → [×1] → {TRACE 2nd} → {/DEV} → [1] → [0] → [×1]
	Sets the RBW.	[AVG] → {1F RBW} → [3] → [kHz]
STIMULUS	Center frequency	[CENTER] → [8] → [3] → [8] → [MHz]
	Span frequency	[SPAN] → [3] → [0] → [0] → [MHz]

4. Perform the calibration (two-port full calibration).
(Perform a two-port full calibration between TEST PORT 1a and TEST PORT 2a, and between TEST PORT 1a and TEST PORT 3a for a six-port test adapter.)
5. Temporarily save the calibration data and measurement conditions previously used successfully.
[FUNCTION] → {MULTI PORT} → {CORRECTION COPY}
6. Set up the analyzer as follows to measure ANT2 Tx2 Rx2 of the device.

Block name	Setting	Key operation
ACTIVE CHANNEL	Sets channel 1.	[CH1]
RESPONSE	Sets the test adapter path.	[FUNCTION] → {MULTI PORT} → {ANT2 Tx2 Rx2}
STIMULUS	Center frequency	[CENTER] → [8] → [8] → [0] → [.] → [2] → [5] → [MHz]
	Span frequency	[SPAN] → [3] → [0] → [0] → [MHz]
ACTIVE CHANNEL	Sets Channel 2.	[CH2]
STIMULUS	Center frequency	[CENTER] → [8] → [3] → [8] → [MHz]
	Span frequency	[SPAN] → [3] → [0] → [0] → [MHz]

7. Perform a two-port full calibration.
(Perform a two-port full calibration between TEST PORT 1b and TEST PORT 2b, and between TEST PORT 1b and TEST PORT 3b for a six-port test adapter.)

4.2.2 R3967 OPT11 (Six-port Test Adapter) Measurement Example

8. Temporarily save the calibration data and measurement conditions previously obtained.

[FUNCTION] → {MULTI PORT} → {CORRECTION COPY}

9. Make measurements using the path exchange key in the MULTI PORT menu.
An example is shown below (Exchange key: {ANT1 Tx1 Rx1} and {ANT2 Tx2 Rx2}).

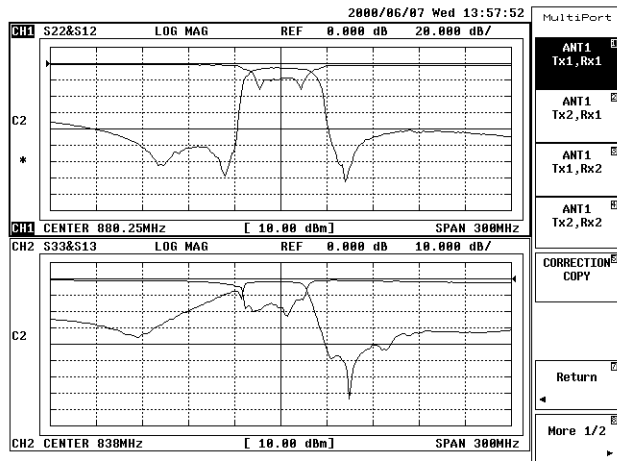

Figure 4-5 Example Using ANT1 Tx1 Rx1

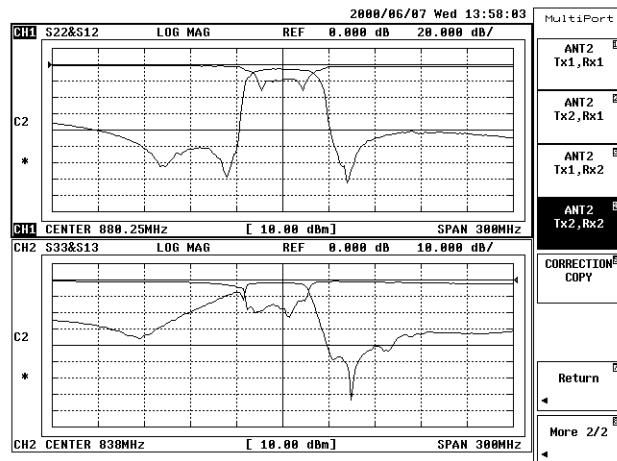

Figure 4-6 Example Using ANT2 Tx2 Rx2

5. OPERATION DESCRIPTION

5.1 Operation of the R3967 OPT10

1. Reflection characteristics

- S11 (TEST PORT 1a)

The signal from the network analyzer is input to PORT 1 and then output from TEST PORT 1a. Reflected components from the DUT are input to TEST PORT 1a and then output from PORT 1 so that it can be analyzed in the network analyzer.

- S22 (TEST PORT 2a/2b)

The signal from the network analyzer is input to PORT 2, and output from TEST PORT 2a/2b after the signal has passed through J0 thru J2 of the SW1.

Reflected components are input to TEST PORT 2a/2b, and output from TEST PORT 2 after the signal has passed through J0 thru J2 of the SW1 so that it can be analyzed in the network analyzer.

- S33 (TEST PORT 3a/3b)

The signal from the network analyzer is input to PORT 3, and output from TEST PORT 3a/3b after the signal has passed through J0 thru J2 of the SW2.

Reflected components are input to TEST PORT 2a/2b, and output from TEST PORT 3 after the signal has passed through J0 thru J2 of the SW2 so that it can be analyzed in the network analyzer.

2. Transmission characteristics

- S21 (PORT 1 → TEST PORT 1a → TEST PORT 2a/2b → PORT 2)

The signal from the network analyzer is input to PORT 1, output from TEST PORT 1a and then input to the DUT.

Transmitted components from the DUT are input to TEST PORT 2a/2b and then output from PORT 2 after the signal has passed through J0 thru J2 of the SW1 so that it can be analyzed in the network analyzer.

- S12 (PORT 2 → TEST PORT 2a/2b → TEST PORT 1a → PORT 1)

The signal from the network analyzer is input to PORT 2, output from TEST PORT 2a/2b after the signal has passed through J0 thru J2 of the SW1 and then input to the DUT.

Transmitted components from the DUT are input to TEST PORT 1a, and output from TEST PORT 1 so that it can be analyzed in the network analyzer.

- S31 (PORT 1 → TEST PORT 1a → TEST PORT 3a/3b → PORT 3)

The signal from the network analyzer is input to PORT 1, output from TEST PORT 1a and then input to the DUT.

Transmitted components from the DUT are input to TEST PORT 3a/3b, and output from TEST PORT 3 after the signal has passed through J0 thru J2 of the SW2 so that it can be analyzed in the network analyzer.

- S13 (PORT 3 → TEST PORT 3a/3b → TEST PORT 1a → PORT 1)

The signal from the network analyzer is input to PORT 3, output from TEST PORT 3a/3b after the signal has passed through J0 thru J2 of the SW2 and then input to the DUT.

Transmitted components from the DUT are input to TEST PORT 1a, and output from TEST PORT 1 so that they can be analyzed in the network analyzer.

5.1 Operation of the R3967 OPT10

- S32 (PORT 2 → TEST PORT 2a/2b → TEST PORT 3a/3b → PORT 3)

The signal from the network analyzer is input to PORT 2, output from TEST PORT 2a/2b after the signal has passed through J0 thru J2 of the SW1 and then input to the DUT. Transmitted components from the DUT are input to TEST PORT 3a/3b, and output from TEST PORT 3 after the signal has passed through J0 thru J2 of the SW2 so that it can be analyzed in the network analyzer.

- S23 (PORT 3 → TEST PORT 3a/3b → TEST PORT 2a/2b → PORT 2)

The signal from the network analyzer is input to PORT 3, output from TEST PORT 3a/3b after the signal has passed through J0 thru J2 of the SW2 and then input to the DUT. Transmitted components from the DUT are input to TEST PORT 2a/2b, and output from TEST PORT 1 after the signal has passed through J0 thru J2 of the SW2 so that it can be analyzed in the network analyzer.

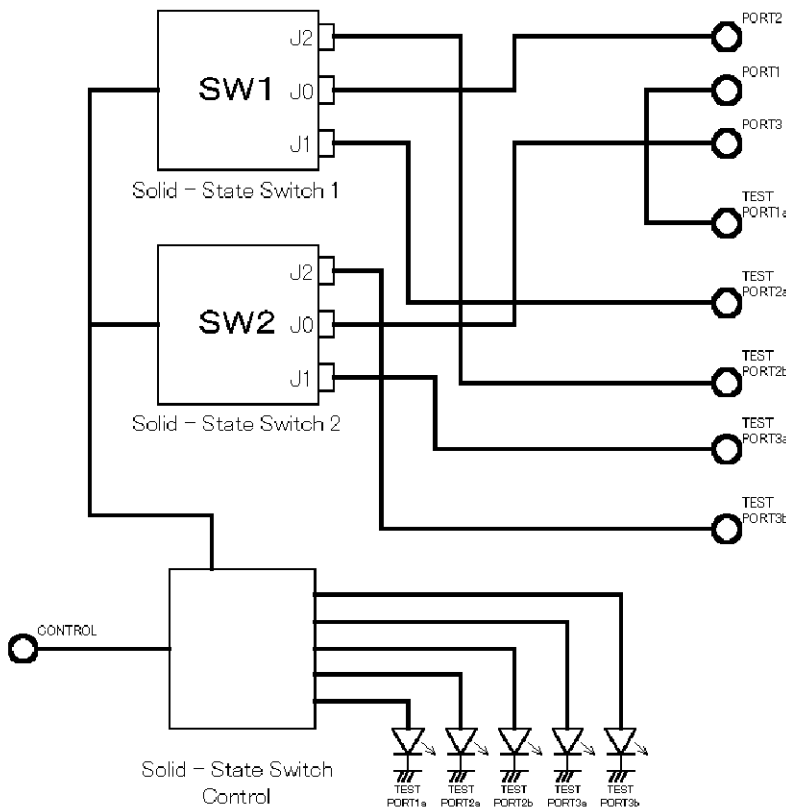

Figure 5-1 R3967 OPT10 Block Diagram

5.2 Operation of the R3967 OPT11

1. Reflection characteristics

- S11 (TEST PORT 1a/1b)

The signal from the network analyzer is input to PORT 1 and then output from TEST PORT 1a/1b after the signal has passed through J0 thru J2 of the SW1.

Reflected components from the DUT are input to TEST PORT 1a/1b and then output from PORT 1 after the signal has passed through J0 thru J2 of the SW1 so that it can be analyzed in the network analyzer.

- S22 (TEST PORT 2a/2b)

The signal from the network analyzer is input to PORT 2, and output from TEST PORT 2a/2b after the signal has passed through J0 thru J2 of the SW2.

Reflected components are input to TEST PORT 2a/2b, and output from TEST PORT 2 after the signal has passed through J0 thru J2 of the SW2 so that it can be analyzed in the network analyzer.

- S33 (TEST PORT 3a/3b)

The signal from the network analyzer is input to PORT 3, and output from TEST PORT 3a/3b after the signal has passed through J0 thru J2 of the SW3.

Reflected components are input to TEST PORT 3a/3b, and output from TEST PORT 3 after the signal has passed through J0 thru J2 of the SW3 so that it can be analyzed in the network analyzer.

2. Transmission characteristics

- S21 (PORT 1 → TEST PORT 1a/1b → TEST PORT 2a/2b → PORT 2)

The signal from the network analyzer is input to PORT 1, output from TEST PORT 1a and then input to the DUT.

Transmitted components from the DUT are input to TEST PORT 2a/2b and then output from PORT 2 after the signal has passed through J0 thru J2 of the SW1 so that it can be analyzed in the network analyzer.

- S12 (PORT 2 → TEST PORT 2a/2b → TEST PORT 1a/1b → PORT 1)

The signal from the network analyzer is input to PORT 2, output from TEST PORT 2a/2b after the signal has passed through J0 thru J2 of the SW2 and then input to the DUT.

Transmitted components from the DUT are input to TEST PORT 1a/1b, and output from TEST PORT 1 after the signal has passed through J0 thru J2 of the SW1 so that it can be analyzed in the network analyzer.

- S31 (PORT 1 → TEST PORT 1a/1b → TEST PORT 3a/3b → PORT 3)

The signal from the network analyzer is input to PORT 1, output from TEST PORT 1a after the signal has passed through J0 thru J2 of the SW1 and then input to the DUT.

Transmitted components from the DUT are input to TEST PORT 3a/3b, and output from TEST PORT 3 after the signal has passed through J0 thru J2 of the SW3 so that it can be analyzed in the network analyzer.

- S13 (PORT 3 → TEST PORT 3a/3b → TEST PORT 1a/1b → PORT 1)

The signal from the network analyzer is input to PORT 3, output from TEST PORT 3a/3b after the signal has passed through J0 thru J2 of the SW3 and then input to the DUT.

Transmitted components from the DUT are input to TEST PORT 1a/1b, and output from TEST PORT 1 after the signal has passed through J0 thru J2 of the SW1 so that it can be analyzed in the network analyzer.

- S32 (PORT 2 → TEST PORT 2a/2b → TEST PORT 3a/3b → PORT 3)

The signal from the network analyzer is input to PORT 2, output from TEST PORT 2a/2b after the signal has passed through J0 thru J2 of the SW2 and then input to the DUT.

Transmitted components from the DUT are input to TEST PORT 3a/3b, and output from TEST PORT 3 after the signal has passed through J0 thru J2 of the SW3 so that it can be analyzed in the network analyzer.

5.2 Operation of the R3967 OPT11

- S23 (PORT 3 → TEST PORT 3a/3b → TEST PORT 2a/2b → PORT 2)

The signal from the network analyzer is input to PORT 3, output from TEST PORT 3a/3b after the signal has passed through J0 thru J2 of the SW3 and then input to the DUT. Transmitted components from the DUT are input to TEST PORT 2a/2b, and output from TEST PORT 2 after the signal has passed through J0 thru J2 of the SW2 so that it can be analyzed in the network analyzer.

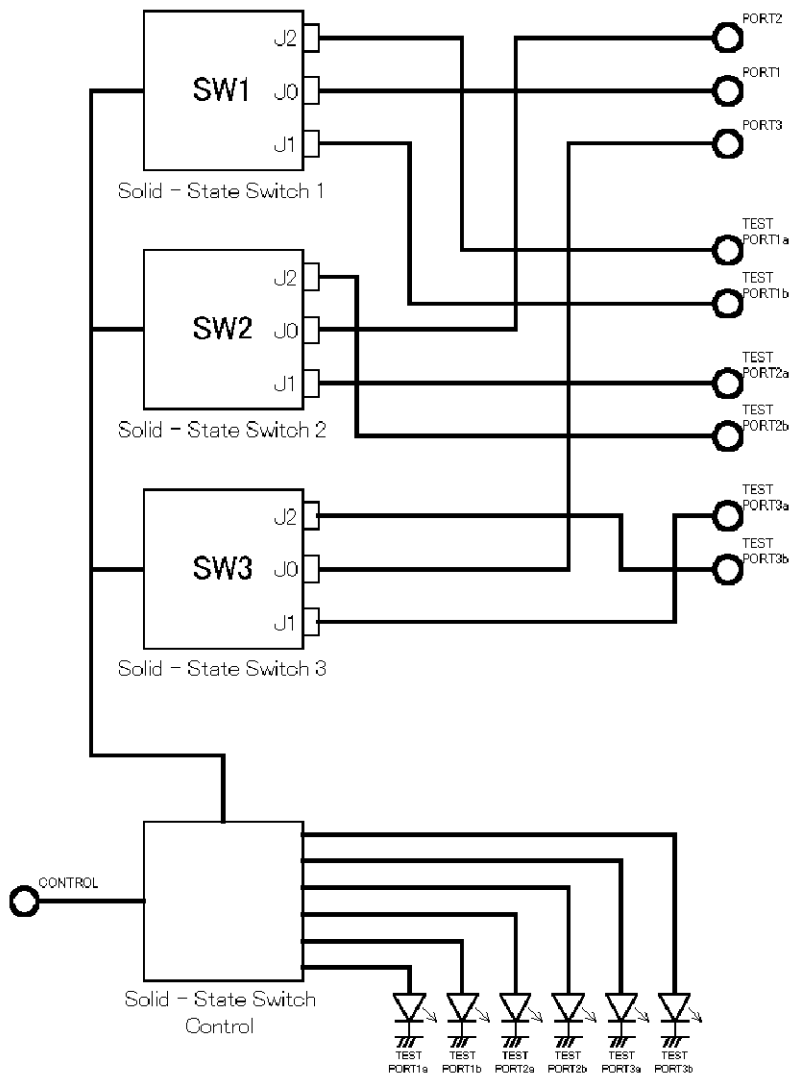

Figure 5-2 R3967 OPT11 Block Diagram

6. PERFORMANCE TESTS

This chapter describes the test method to keep the performance of the R3967 OPT10 / R3967 OPT11. Contact ADVANTEST for other test methods than the items described in this chapter.

6.1 Preparations for the Tests

6.1.1 Warm-up

Warm up the instrument at least 60 minutes before starting the performance tests. Press the [PRESET] key to initialize the instrument before the start of every test item.

6.1.2 Instrument Preparation

Make certain you have all necessary instrument and materials on hand for the tests listed in Table 6-1.

Table 6-1 Required Measurement Instrument for Performance Test

Test	Instrument used	Remarks
Test port load match	Calibration kit RF cable (TEST CABLE)	Refer to Section 6.2
Insertion loss	Calibration kit RF cable (TEST CABLE)	Refer to Section 6.3

Calibration kit: Model 9617F3 (18 GHz, 3.5 mm connector)

RF cable: Use cables with SMA connectors and good frequency characteristics (approx. 0.25dB/GHz).

6.1.3 General Note

- Use an AC power source having a voltage of 90V to 250V and a frequency of 48Hz to 66Hz.
- When connecting the power supply cable, turn OFF the POWER switch.
- The R3967 OPT10 / R3967 OPT11 must be tested under the following conditions:
 - Temperature: +25°C to ±5°C
 - Relative humidity: 80% or less (without condensation)
 - Free from dust, vibration and noise.

6.2 Test Port Load Match

6.2 Test Port Load Match

6.2.1 For the R3967 OPT10

Testing procedure

1. Connect the control cable from the instrument to the network analyzer.
2. Connect TEST CABLE 1 to TEST PORT 1 on the network analyzer, and connect TEST CABLE 2 to TEST PORT 2 on the network analyzer in order to perform a two-port full calibration.

Test Port setup

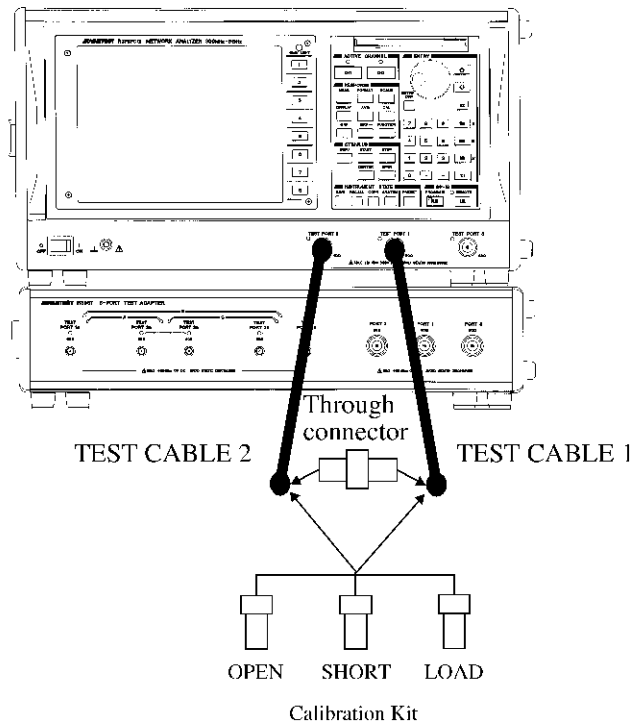

3. Connect the open standard to the TEST CABLE 1 end.
Use the following procedure to obtain open calibration data.
[CAL] → {**CAL MENU**} → {**2PORT CAL MENU**} → {**2PORT FULL CAL**} → {**REFLECTⁿN**} → {**S11:(PORT 1) FWD:OPEN**}
4. Connect the short standard to the TEST CABLE 1 end.
Use the following procedure to obtain short calibration data.
{**S11:(PORT 1) FWD:SHORT**}

5. Connect the load standard to the TEST CABLE 1 end.
Use the following procedure to obtain load calibration data.
{S11:(PORT 1) FWD:LOAD}
6. Connect the open standard to the TEST CABLE 2 end.
Use the following procedure to obtain open calibration data.
{S22:(PORT 2) REV:OPEN}
7. Connect the short standard to the TEST CABLE 2 end.
Use the following procedure to obtain short calibration data.
{S22:(PORT 2) REV:SHORT}
8. Connect the load standard to the TEST CABLE 2 end.
Use the following procedure to obtain load calibration data.
{S22:(PORT 2) REV:LOAD}
9. Perform REFLECTION.
{DONE REFLECT'N}
10. Connect the through connector between the TEST CABLE 1 end and TEST CABLE 2 end.
Use the following procedure to obtain through calibration data.
{TRANS-MISSION} → {GROUP THRU} → {DONE TRANS}
11. Remove the through connector between the TEST CABLE 1 end and TEST CABLE 2 end.
Use the following procedure to obtain through calibration data.
{ISOLATION} → {OMIT ISOLATION} → {DONE ISOLATION}
12. Use the following procedure to complete a two-port full calibration.
{DONE 2-PORT}

Load Match for TEST PORT 2a

13. Set the network analyzer to S11.
[MEAS] → {S11 (PORT 1)}
14. Terminate TEST PORT 2a using the following procedure.
[FUNCTION] → {MULTI PORT} → {ANT1 Tx2 Rx1}
15. Connect TEST CABLE 1 to TEST PORT 2a on the R3967 OPT10 to read the test port load match using the marker on the trace data. (The TEST CABLE 2 is not used.)

6.2.1 For the R3967 OPT10

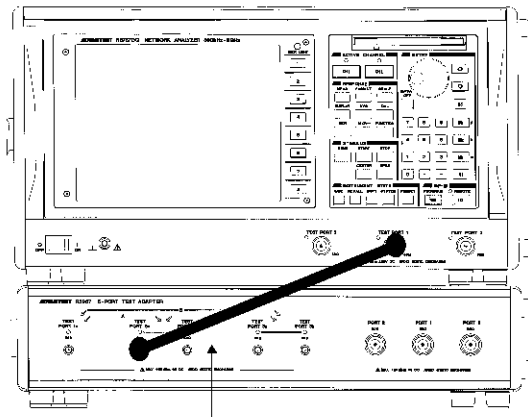

TEST CABLE 1

16. Check that the load match on TESTPORT 2a is appropriate.

Marker 1 shows the maximum response measured in a frequency range of 300 kHz to 500 MHz: 10dB or higher

Marker 2 shows the maximum response measured in a frequency range of 500 MHz to 3 GHz: 15dB or higher

Marker 3 shows the maximum response measured in a frequency range of 3 GHz to 8 GHz: 12dB or higher

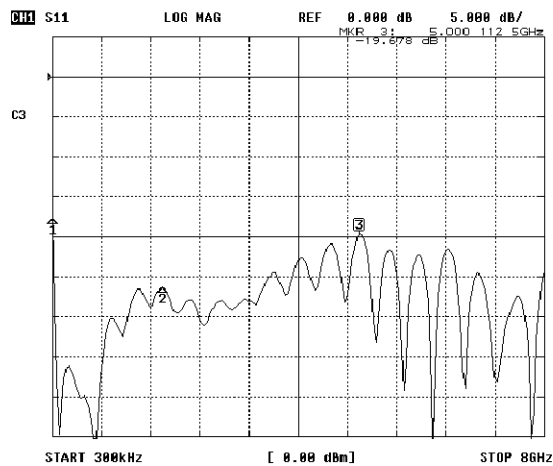

Load Match for TEST PORT 2b

17. Terminate TEST PORT 2b using the following procedure.

[FUNCTION] → {MULTI PORT} → {ANTI Tx| Rx|}

18. Connect TEST CABLE 1 to TEST PORT 2a on the R3967 OPT10 to read the test port load match using the marker on the trace data. (The TEST CABLE 2 is not used.)

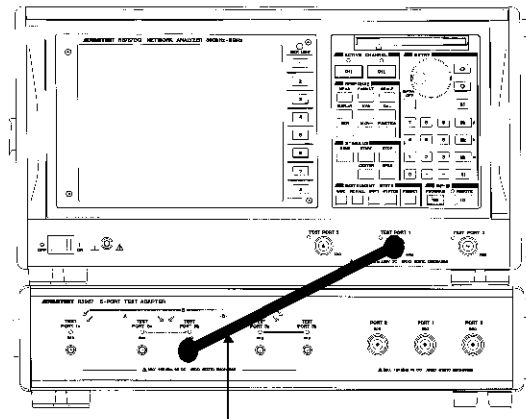

TEST CABLE 1

19. Check that the load match on TESTPORT 2b is appropriate.

Marker 1 shows the maximum response measured in a frequency range of 300 kHz to 500 MHz: 10dB or higher

Marker 2 shows the maximum response measured in a frequency range of 500 MHz to 3 GHz: 15dB or higher

Marker 3 shows the maximum response measured in a frequency range of 3 GHz to 8 GHz: 12dB or higher

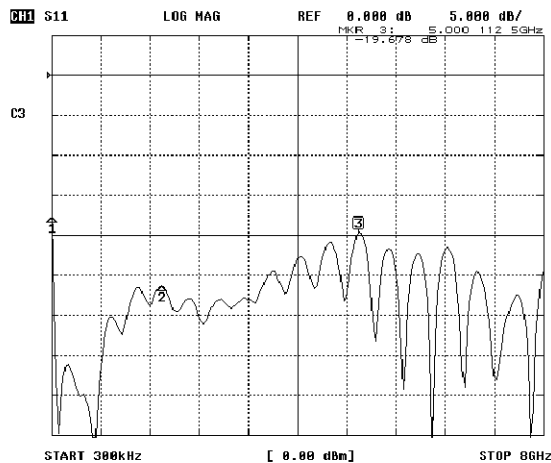

20. Set the network analyzer to S11.

[MEAS] → {TEST-PORT CONECTION P1-P3} → {S11 (PORT 1)}

Load Match for TEST PORT 3a

21. Terminate TEST PORT 2b using the following procedure.

[FUNCTION] → {MULTI PORT} → {ANTI Tx1 Rx2}

6.2.1 For the R3967 OPT10

22. Connect TEST CABLE 1 to TEST PORT 3a on the R3967 OPT10 to read the test port load match using the marker on the trace data. (The TEST CABLE 2 is not used.)

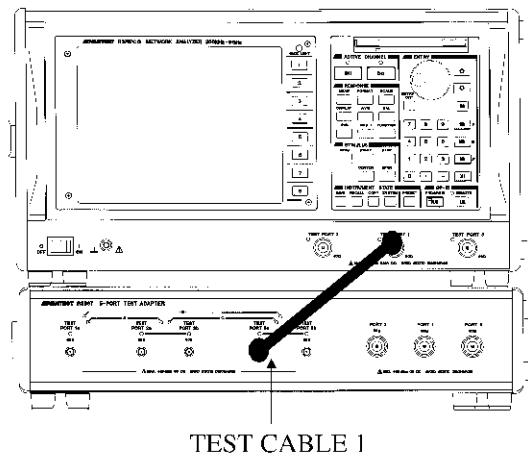

23. Check that the load match on TESTPORT 3a is appropriate.
 - Marker 1 shows the maximum response measured in a frequency range of 300 kHz to 500 MHz: 10dB or higher
 - Marker 2 shows the maximum response measured in a frequency range of 500 MHz to 3 GHz: 15dB or higher
 - Marker 3 shows the maximum response measured in a frequency range of 3 GHz to 8 GHz: 12dB or higher

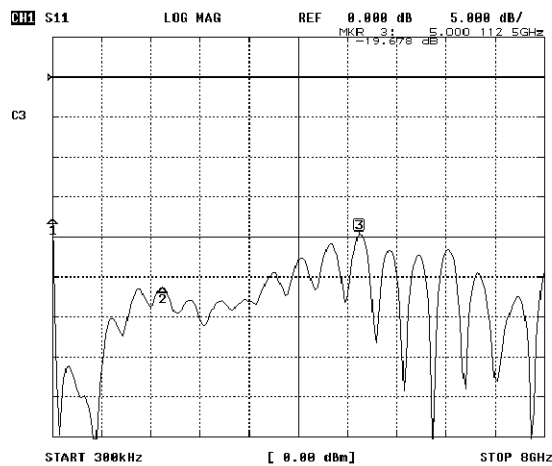

Load Match for TEST PORT 3b

24. Terminate TEST PORT 3b using the following procedure.
 - [FUNCTION] → {MULTI PORT} → {ANTI Tx1 Rx1}

25. Connect TEST CABLE 1 to TEST PORT 3b on the R3967 OPT10 to read the test port load match using the marker on the trace data. (The TEST CABLE 2 is not used.)

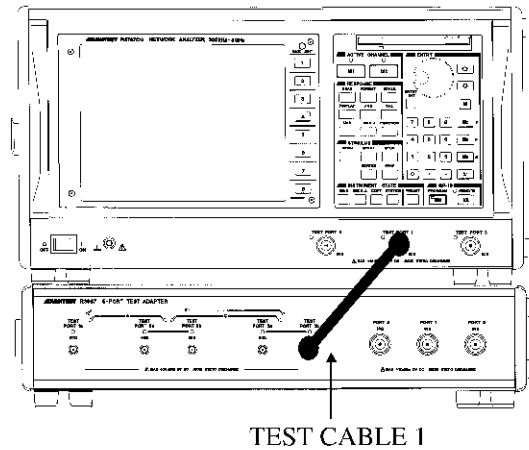

26. Check that the load match on TESTPORT 3b is appropriate.
 - Marker 1 shows the maximum response measured in a frequency range of 300 kHz to 500 MHz: 10dB or higher
 - Marker 2 shows the maximum response measured in a frequency range of 500 MHz to 3 GHz: 15dB or higher
 - Marker 3 shows the maximum response measured in a frequency range of 3 GHz to 8 GHz: 12dB or higher

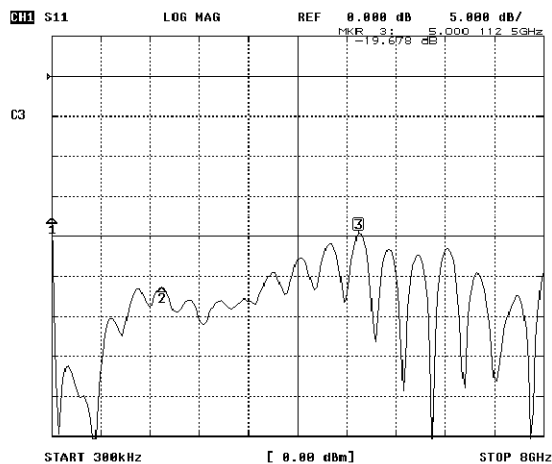

6.2.2 For the R3967 OPT11

6.2.2 For the R3967 OPT11

Testing procedure

1. Connect the control cable from the instrument to the network analyzer.
2. Connect TEST CABLE 1 to TEST PORT 1 on the network analyzer, and connect TEST CABLE 2 to TEST PORT 2 on the network analyzer in order to perform a two-port full calibration.

Test Port setup

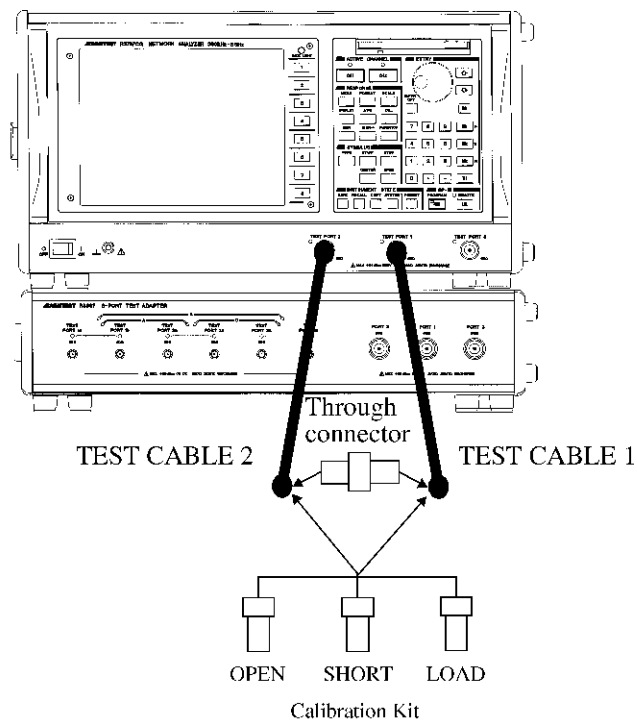

3. Connect the open standard to the TEST CABLE 1 end.
Use the following procedure to obtain open calibration data.
[CAL] → {CAL MENU} → {2PORT CAL MENU} → {2PORT FULL CAL} → {REFLECT'N} → {S11:(PORT 1) FWD:OPEN}
4. Connect the short standard to the TEST CABLE 1 end.
Use the following procedure to obtain short calibration data.
{S11:(PORT 1) FWD:SHORT}

5. Connect the load standard to the TEST CABLE 1 end.
Use the following procedure to obtain load calibration data.
{S11:(PORT 1) FWD:LOAD}
6. Connect the open standard to the TEST CABLE 2 end.
Use the following procedure to obtain open calibration data.
{S22:(PORT 2) REV:OPEN}

Load Match for TEST PORT 1a

7. Set the network analyzer to S11.
[MEAS] → *{S11 (PORT 1)}*
8. Terminate TEST PORT 1a using the following procedure.
[FUNCTION] → *{MULTI PORT}* → *{ANTI Tx1 Rx1}*
9. Connect TEST CABLE 1 to TEST PORT 1a on the R3967 OPT11 to read the test port load match using the marker on the trace data. (The TEST CABLE 2 is not used.)

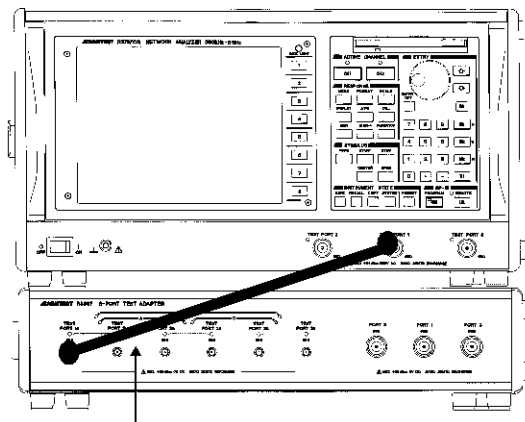

TEST CABLE 1

10. Check that the load match on TESTPORT 1a is appropriate.
 - Marker 1 shows the maximum response measured in a frequency range of 300 kHz to 500 MHz: 10dB or higher
 - Marker 2 shows the maximum response measured in a frequency range of 500 MHz to 3 GHz: 15dB or higher
 - Marker 3 shows the maximum response measured in a frequency range of 3 GHz to 8 GHz: 12dB or higher

6.2.2 For the R3967 OPT11

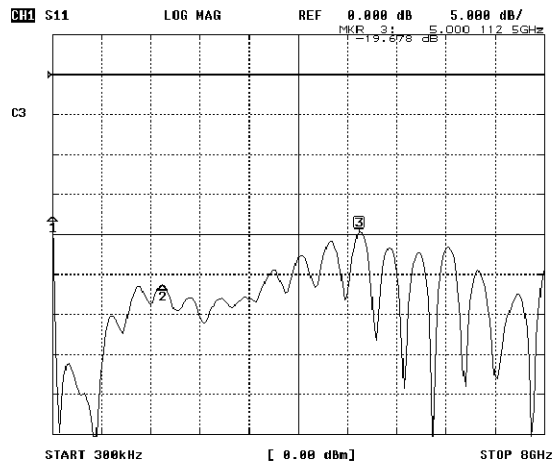

Load Match for TEST PORT 1b

11. Terminate TEST PORT 1b using the following procedure.
{ANT2 Tx1 Rx1}
12. Connect TEST CABLE 1 to TEST PORT 1b on the R3967 OPT11 to read the test port load match using the marker on the trace data. (The TEST CABLE 2 is not used.)

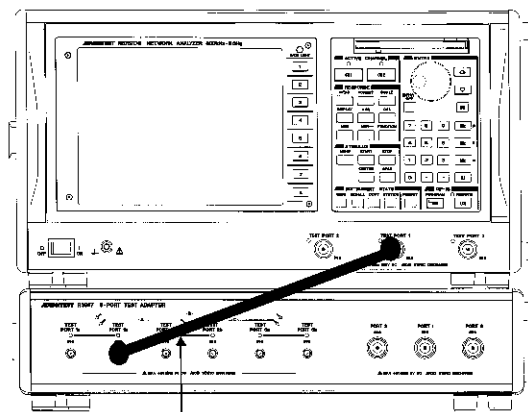

TEST CABLE 1

13. Check that the load match on TESTPORT 1b is appropriate.
 - Marker 1 shows the maximum response measured in a frequency range of 300 kHz to 500 MHz: 10dB or higher
 - Marker 2 shows the maximum response measured in a frequency range of 500 MHz to 3 GHz: 15dB or higher
 - Marker 3 shows the maximum response measured in a frequency range of 3 GHz to 8 GHz: 12dB or higher

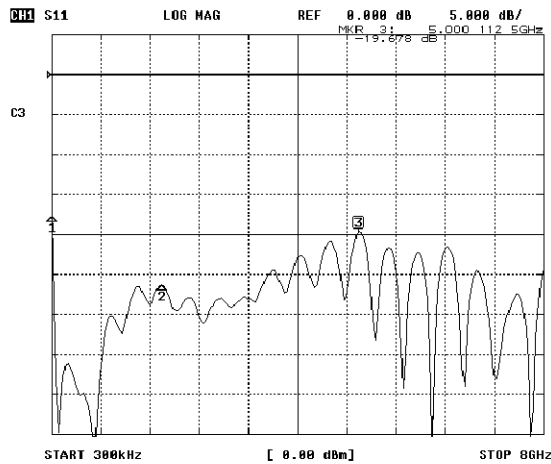

Load Match for TEST PORT 2a

14. Terminate TEST PORT 1b using the following procedure.
{ANTI Tx2 Rx1}
15. Connect TEST CABLE 1 to TEST PORT 2a on the R3967 OPT11 to read the test port load match using the marker on the trace data. (The TEST CABLE 2 is not used.)

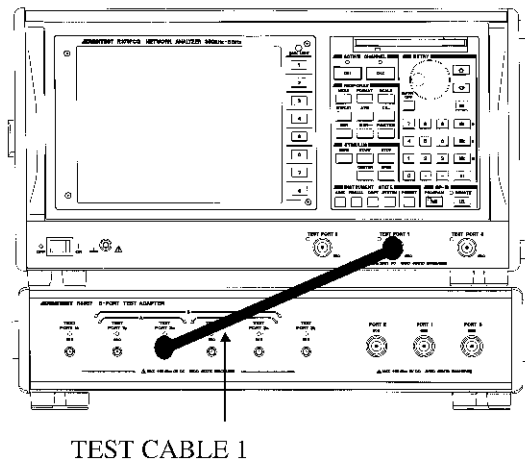

16. Check that the test results are as shown below.
 - Marker 1 shows the maximum response measured in a frequency range of 300 kHz to 500 MHz: 10dB or higher
 - Marker 2 shows the maximum response measured in a frequency range of 500 MHz to 3 GHz: 15dB or higher
 - Marker 3 shows the maximum response measured in a frequency range of 3 GHz to 8 GHz: 12dB or higher

6.2.2 For the R3967 OPT11

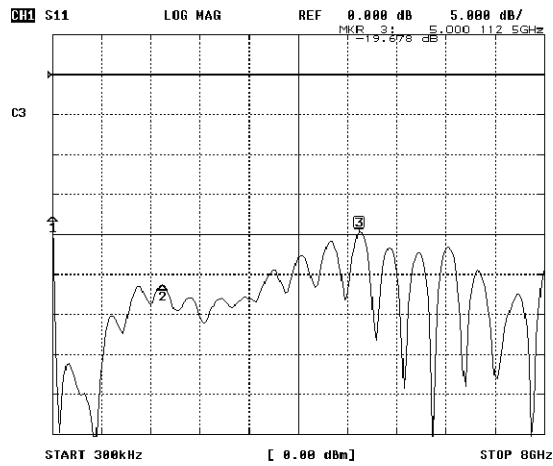

Load Match for TEST PORT 2b

17. Terminate TEST PORT 2b using the following procedure.
{ANTI Tx1 Rx2}
18. Connect TEST CABLE 1 to TEST PORT 2b on the R3967 OPT11 to read the test port load match using the marker on the trace data. (The TEST CABLE 2 is not used.)

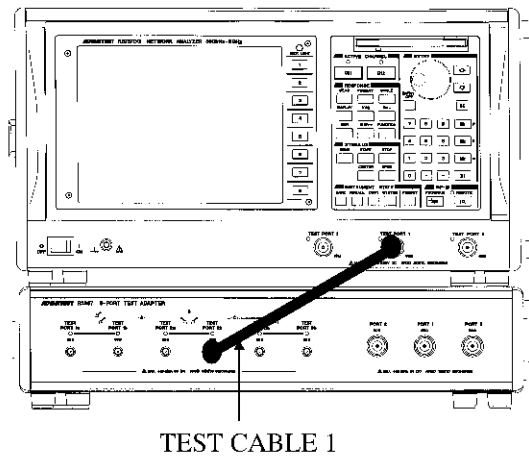

19. Check that the load match on TESTPORT 2b is appropriate.
 Marker 1 shows the maximum response measured in a frequency range of 300 kHz to 500 MHz: 10dB or higher
 Marker 2 shows the maximum response measured in a frequency range of 500 MHz to 3 GHz: 15dB or higher
 Marker 3 shows the maximum response measured in a frequency range of 3 GHz to 8 GHz: 12dB or higher

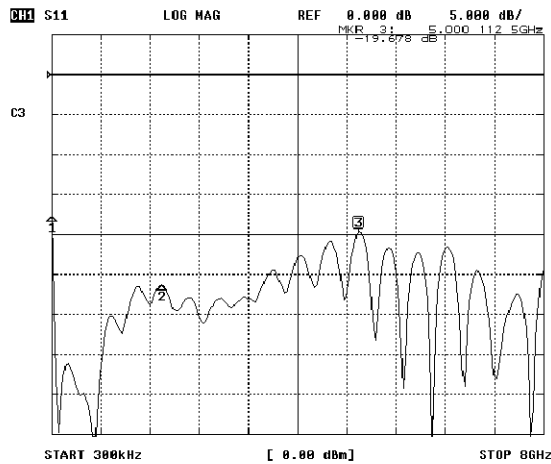

Load Match for TEST PORT 3a

20. Terminate TEST PORT 3a using the following procedure.
{ANTI Tx| Rx|}
21. Connect TEST CABLE 1 to TEST PORT 3a on the R3967 OPT11 to read the test port load match using the marker on the trace data. (The TEST CABLE 2 is not used.)

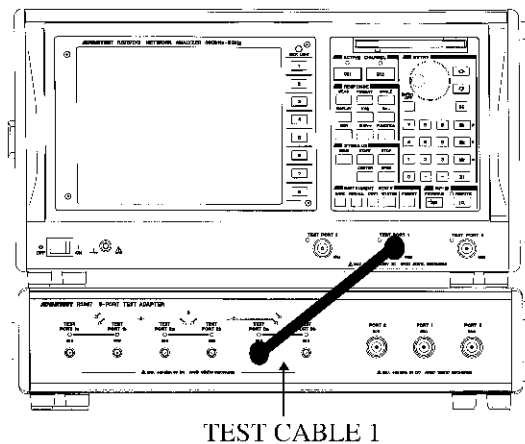

22. Check that the load match on TESTPORT 3a is appropriate.
 - Marker 1 shows the maximum response measured in a frequency range of 300 kHz to 500 MHz: 10dB or higher
 - Marker 2 shows the maximum response measured in a frequency range of 500 MHz to 3 GHz: 15dB or higher
 - Marker 3 shows the maximum response measured in a frequency range of 3 GHz to 8 GHz: 12dB or higher

6.2.2 For the R3967 OPT11

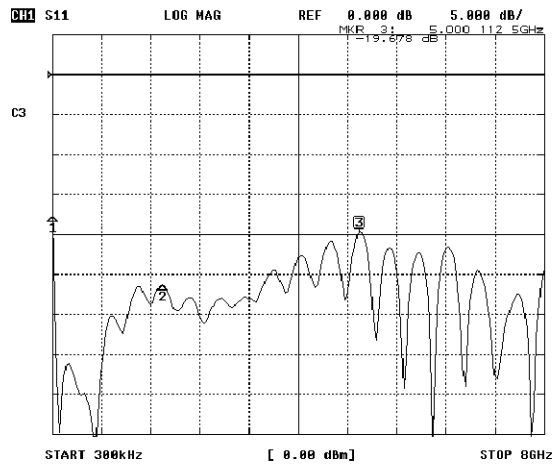

Load Match for TEST PORT 3b

23. Terminate TEST PORT 3b using the following procedure.
{ANTI Tx1 Rx2}
24. Connect TEST CABLE 1 to TEST PORT 3b on the R3967 OPT11 to read the test port load match using the marker on the trace data. (The TEST CABLE 2 is not used.)

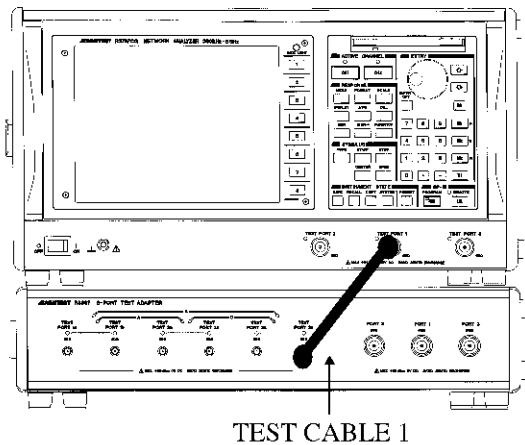

25. Check that the load match on TESTPORT 3b is appropriate.
 Marker 1 shows the maximum response measured in a frequency range of 300 kHz to 500 MHz: 10dB or higher
 Marker 2 shows the maximum response measured in a frequency range of 500 MHz to 3 GHz: 15dB or higher
 Marker 3 shows the maximum response measured in a frequency range of 3 GHz to 8 GHz: 12dB or higher

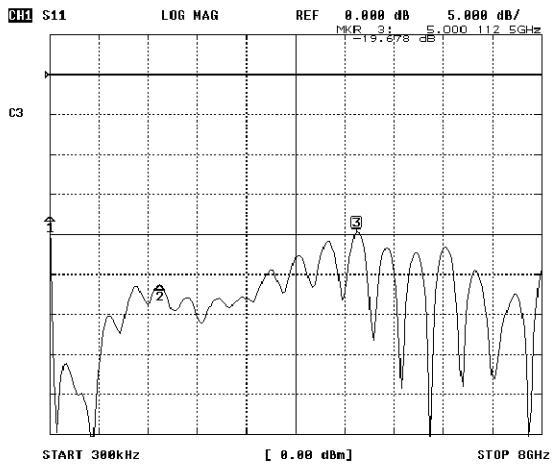

6.3 Insertion Loss

6.3 Insertion Loss

6.3.1 For the R3967 OPT10

Testing procedure

1. Connect the control cable from the instrument to the network analyzer.
2. Connect TEST CABLE 1 to TEST PORT 1 on the network analyzer, and connect TEST CABLE 2 to TEST PORT 2 on the network analyzer in order to perform a two-port full calibration.

Test Port setup

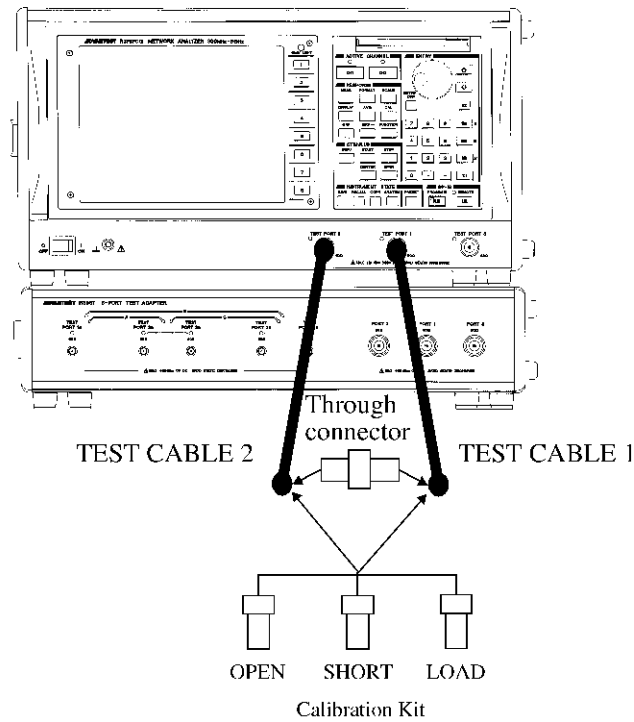

3. Connect the open standard to the TEST CABLE 1 end.
Use the following procedure to obtain open calibration data.
[CAL] → {CAL MENU} → {2PORT CAL MENU} → {2PORT FULL CAL} → {REFLECT*N} → {S11:(PORT 1) FWD:OPEN}
4. Connect the short standard to the TEST CABLE 1 end.
Use the following procedure to obtain short calibration data.
{S11:(PORT 1) FWD:SHORT}

5. Connect the load standard to the TEST CABLE 1 end.
Use the following procedure to obtain load calibration data.
{S11:(PORT 1) FWD:LOAD}
6. Connect the open standard to the TEST CABLE 2 end.
Use the following procedure to obtain open calibration data.
{S22:(PORT 2) REV:OPEN}
7. Connect the short standard to the TEST CABLE 2 end.
Use the following procedure to obtain short calibration data.
{S22:(PORT 2) REV:SHORT}
8. Connect the load standard to the TEST CABLE 2 end.
Use the following procedure to obtain load calibration data.
{S22:(PORT 2) REV:LOAD}
9. Perform REFLECTION.
{DONE REFLECT'N}
10. Connect the through connector between the TEST CABLE 1 end and TEST CABLE 2 end.
Use the following procedure to obtain through calibration data.
{TRANS-MISSION} → {GROUP THRU} → {DONE TRANS}
11. Remove the through connector between the TEST CABLE 1 end and TEST CABLE 2 end.
Use the following procedure to obtain through calibration data.
{ISOLATION} → {OMIT ISOLATION} → {DONE ISOLATION}
12. Use the following procedure to complete a two-port full calibration.
{DONE 2-PORT}

Insertion Loss from TEST PORT 1 to TEST PORT 1a

13. Set the network analyzer to S21.
[MEAS] → {S21 P1-P2}
14. Set the path from PORT 1 to TEST PORT 1a using the following procedure.
[FUNCTION] → {MULTI PORT} → {ANT1 Tx1 Rx1}
15. Connect TEST CABLE 1 to PORT 1 on the R3967 OPT10, and then connect TEST CABLE 2 to TEST PORT 1a on the R3967 OPT10 to read the insertion loss using the marker on the trace data.

6.3.1 For the R3967 OPT10

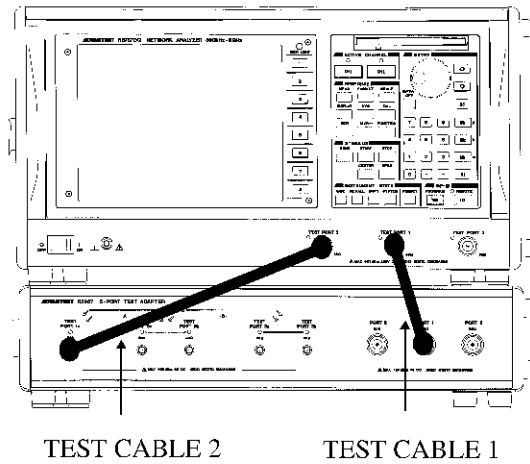

16. Confirm the insertion loss from TEST PORT 1 to TEST PORT 1a.
 Marker 1 shows the minimum response measured in a frequency range of 300 kHz to 8 GHz: 5 dB or less

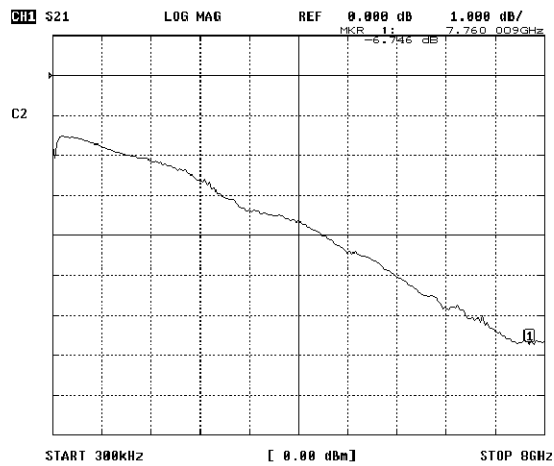

Insertion Loss from TEST PORT 2 to TEST PORT 2a

17. Connect TEST CABLE 1 to PORT 2 on the R3967 OPT10, and then connect TEST CABLE 2 to TEST PORT 2a on the R3967 OPT10 to read the insertion loss using the marker on the trace data.

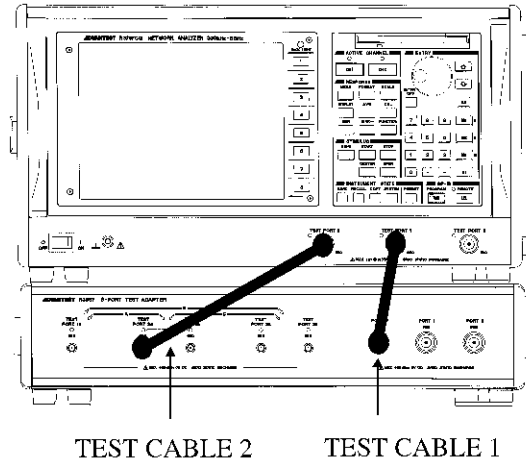

18. Confirm the insertion loss from TEST PORT 2 to TEST PORT 2a.
 Marker 1 shows the minimum response measured in a frequency range of 300 kHz to 8 GHz: 10dB or less

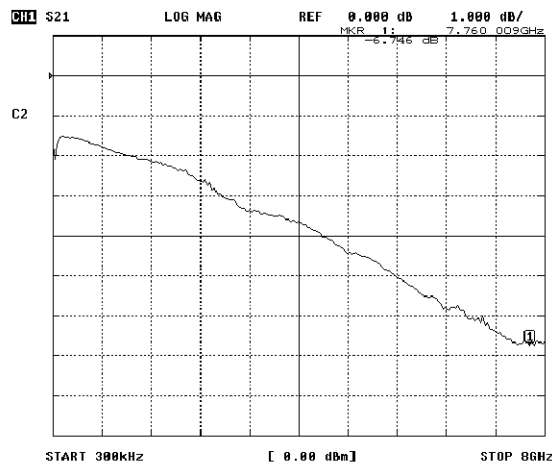

Insertion Loss from TEST PORT 2 to TEST PORT 2b

19. Set the path from PORT 2 to TEST PORT 2b using the following procedure.
 {ANT1 Tx2 Rx1}
20. Connect TEST CABLE 1 to PORT 2 on the R3967 OPT10, and then connect TEST CABLE 2 to TEST PORT 2b on the R3967 OPT10 to read the insertion loss using the marker on the trace data.

6.3.1 For the R3967 OPT10

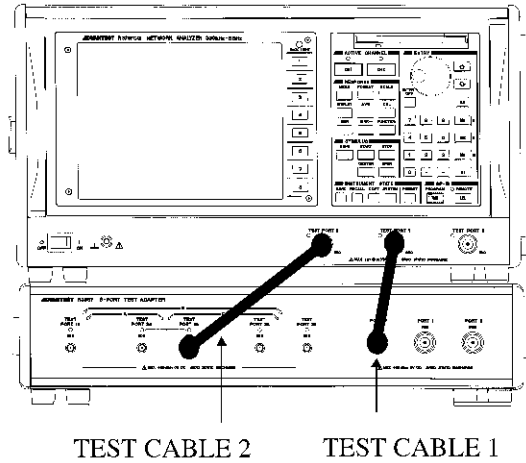

21. Confirm the insertion loss from TEST PORT 2 to TEST PORT 2b.

Marker 1 shows the minimum response measured in a frequency range of 300 kHz to 8 GHz: 10dB or less

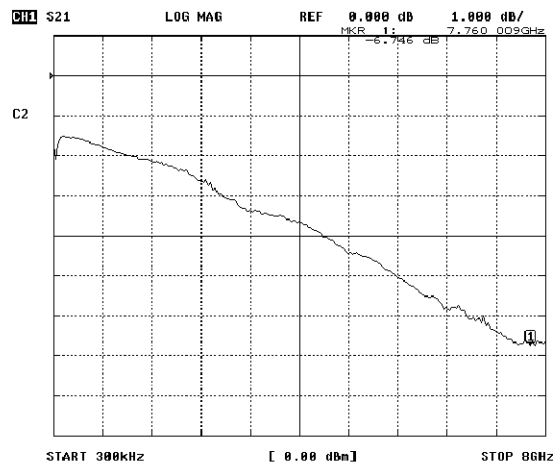

Insertion Loss from TEST PORT 3 to TEST PORT 3a

22. Set the path from PORT 3 to TEST PORT 3a using the following procedure.
{ANT1 Tx1 Rx1}
23. Connect TEST CABLE 1 to PORT 3 on the R3967 OPT10, and then connect TEST CABLE 2 to TEST PORT 3a on the R3967 OPT10 to read the insertion loss using the marker on the trace data.

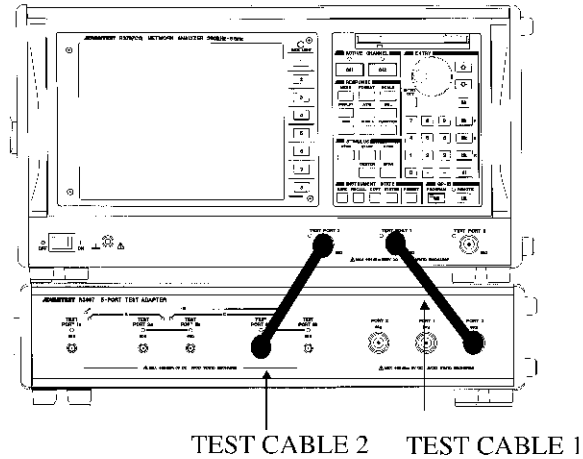

24. Confirm the insertion loss from TEST PORT 3 to TEST PORT 3a.
Marker 1 shows the minimum response measured in a frequency range of 300 kHz to 8 GHz: 10dB or less

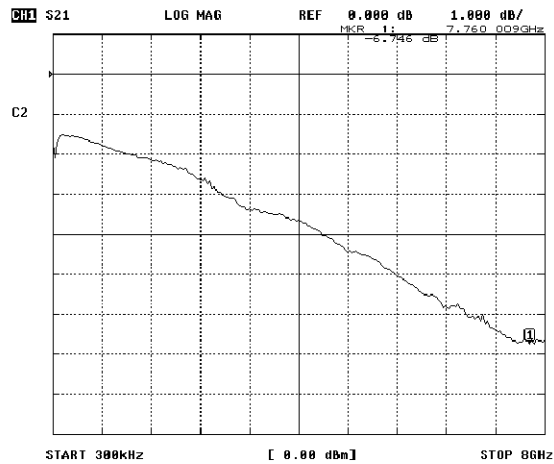

Insertion Loss from TEST PORT 3 to TEST PORT 3b

25. Set the path from PORT 3 to TEST PORT 3b using the following procedure.
{ANTI Tx1 Rx2}
26. Connect TEST CABLE 1 to PORT 3 on the R3967 OPT10, and then connect TEST CABLE 2 to TEST PORT 3b on the R3967 OPT10 to read the insertion loss using the marker on the trace data.

6.3.1 For the R3967 OPT10

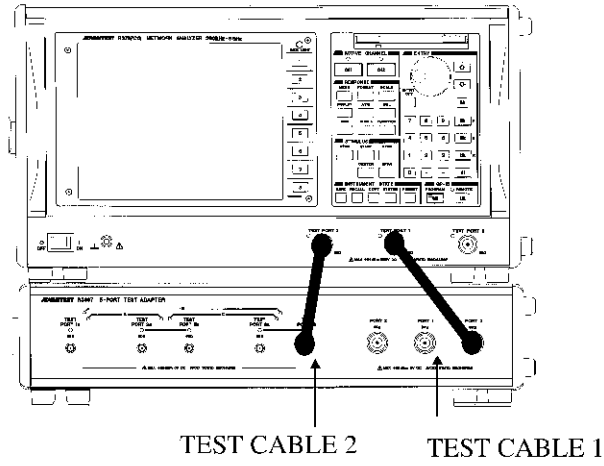

27. Confirm the insertion loss from TEST PORT 3 to TEST PORT 3b.
 Marker 1 shows the minimum response measured in a frequency range of 300 kHz to 8 GHz: 10dB or less

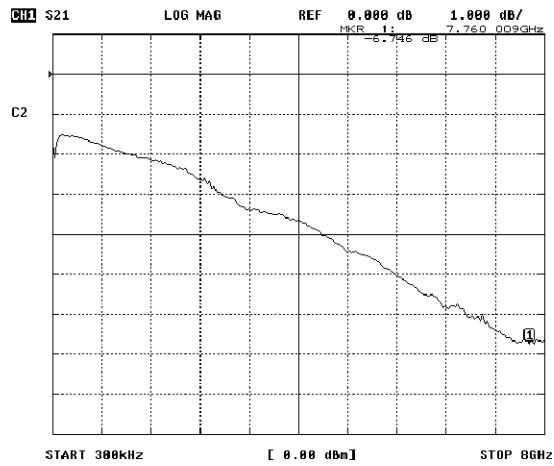

6.3.2 For the R3967 OPT11

Testing procedure

1. Connect the control cable from the instrument to the network analyzer.
2. Connect TEST CABLE 1 to TEST PORT 1 on the network analyzer, and connect TEST CABLE 2 to TEST PORT 2 on the network analyzer in order to perform a two-port full calibration.

Test Port setup

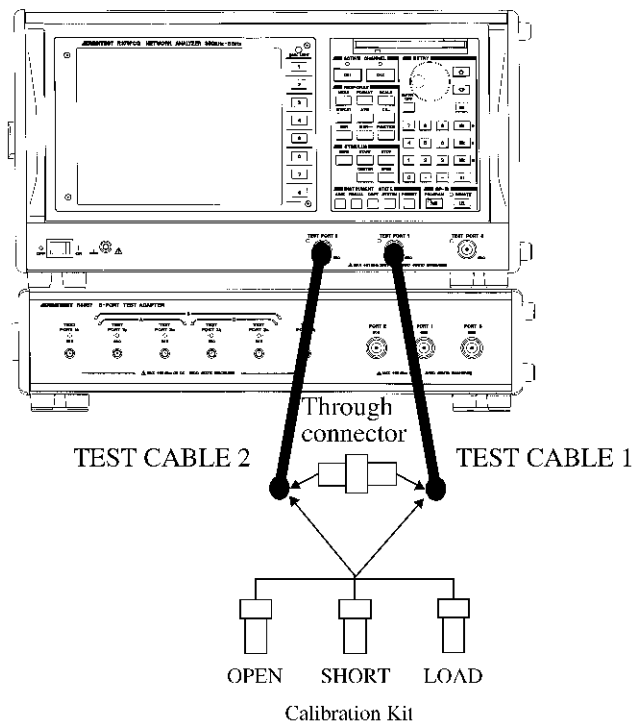

3. Connect the open standard to the TEST CABLE 1 end.
Use the following procedure to obtain open calibration data.
[CAL] → {CAL MENU} → {2PORT CAL MENU} → {2PORT FULL CAL} → {REFLECT'N} → {S11:(PORT 1) FWD:OPEN}
4. Connect the short standard to the TEST CABLE 1 end.
Use the following procedure to obtain short calibration data.
{S11:(PORT 1) FWD:SHORT}

6.3.2 For the R3967 OPT11

5. Connect the load standard to the TEST CABLE 1 end.
Use the following procedure to obtain load calibration data.
{S11:(PORT 1) FWD:LOAD}
6. Connect the open standard to the TEST CABLE 2 end.
Use the following procedure to obtain open calibration data.
{S22:(PORT 2) REV:OPEN}
7. Connect the short standard to the TEST CABLE 2 end.
Use the following procedure to obtain short calibration data.
{S22:(PORT 2) REV:SHORT}
8. Connect the load standard to the TEST CABLE 2 end.
Use the following procedure to obtain load calibration data.
{S22:(PORT 2) REV:LOAD}
9. Perform REFLECTION.
{DONE REFLECT'N}
10. Connect the through connector between the TEST CABLE 1 end and TEST CABLE 2 end.
Use the following procedure to obtain through calibration data.
{TRANS-MISSION} → {GROUP THRU} → {DONE TRANS}
11. Remove the through connector between the TEST CABLE 1 end and TEST CABLE 2 end.
Use the following procedure to obtain through calibration data.
{ISOLATION} → {OMIT ISOLATION} → {DONE ISOLATION}
12. Use the following procedure to complete a two-port full calibration.
{DONE 2-PORT}

Insertion Loss from TEST PORT 1 to TEST PORT 1a

13. Set the network analyzer to S21.
[MEAS] → {S21 P1-P2}
14. Set the path from PORT 1 to TEST PORT 1a using the following procedure.
[FUNCTION] → {MULTI PORT} → {ANTI Tx1 Rx1}
15. Connect TEST CABLE 1 to PORT 1 on the R3967 OPT11, and then connect TEST CABLE 2 to TEST PORT 1a on the R3967 OPT11 to read the insertion loss using the marker on the trace data.

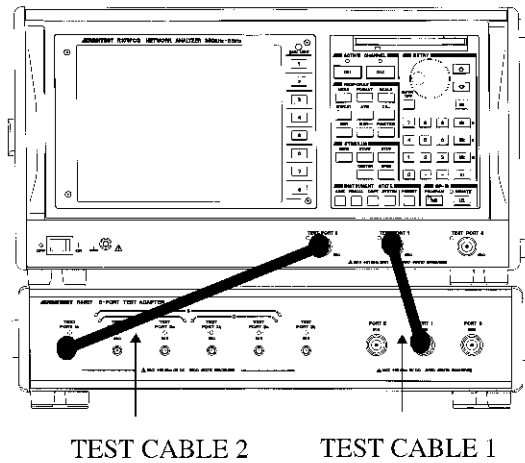

16. Confirm the insertion loss from TEST PORT 1 to TEST PORT 1a.
Marker 1 shows the minimum response measured in a frequency range of 300 kHz to 8 GHz: 10dB or less

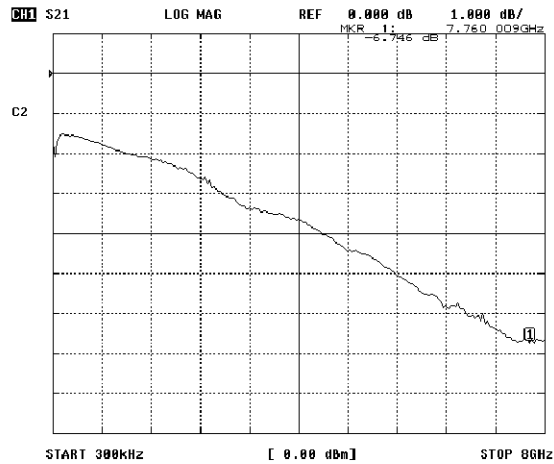

Insertion Loss from TEST PORT 1 to TEST PORT 1b

17. Set the path from PORT 1 to TEST PORT 1b using the following procedure.
{ANT2 Tx1 Rx1}
18. Connect TEST CABLE 1 to PORT 1 on the R3967 OPT11, and then connect TEST CABLE 2 to TEST PORT 1b on the R3967 OPT11 to read the insertion loss using the marker on the trace data.

6.3.2 For the R3967 OPT11

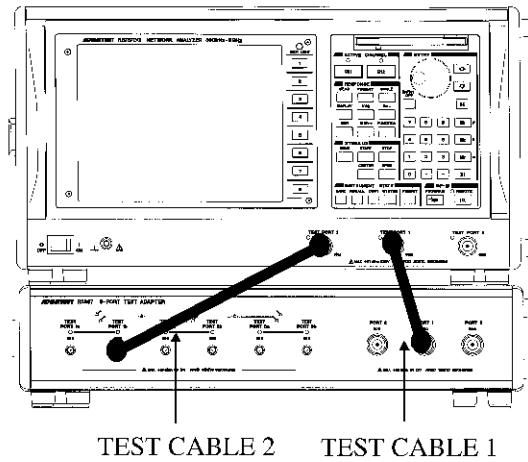

19. Confirm the insertion loss from TEST PORT 1 to TEST PORT 1b.
 Marker 1 shows the minimum response measured in a frequency range of 300 kHz to 8 GHz: 10dB or less

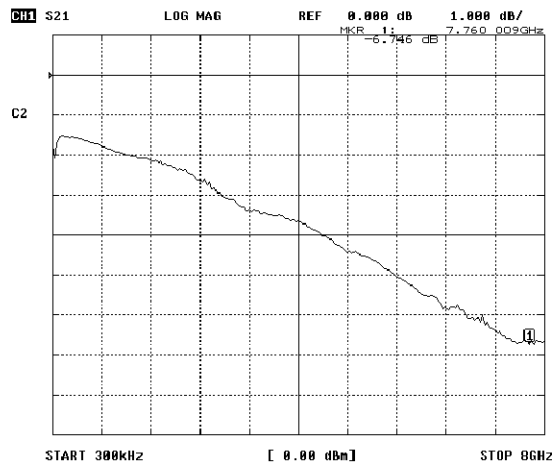

Insertion Loss from TEST PORT 2 to TEST PORT 2a

20. Set the path from PORT 2 to TEST PORT 2a using the following procedure.
{ANTI Tx1 Rx1}
21. Connect TEST CABLE 1 to PORT 2 on the R3967 OPT11, and then connect TEST CABLE 2 to TEST PORT 2a on the R3967 OPT11 to read the insertion loss using the marker on the trace data.

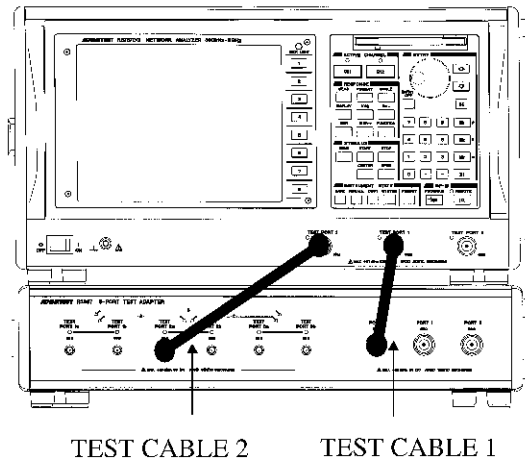

22. Confirm the insertion loss from TEST PORT 2 to TEST PORT 2a.
Marker 1 shows the minimum response measured in a frequency range of 300 kHz to 8 GHz: 10dB or less

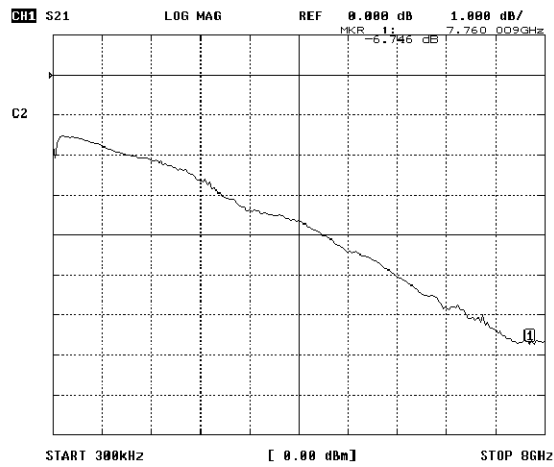

Insertion Loss from TEST PORT 2 to TEST PORT 2b

23. Set the path from PORT 2 to TEST PORT 2b using the following procedure.
{ANTI Tx2 Rx1}
24. Connect TEST CABLE 1 to PORT 2 on the R3967 OPT11, and then connect TEST CABLE 2 to TEST PORT 2b on the R3967 OPT11 to read the insertion loss using the marker on the trace data.

6.3.2 For the R3967 OPT11

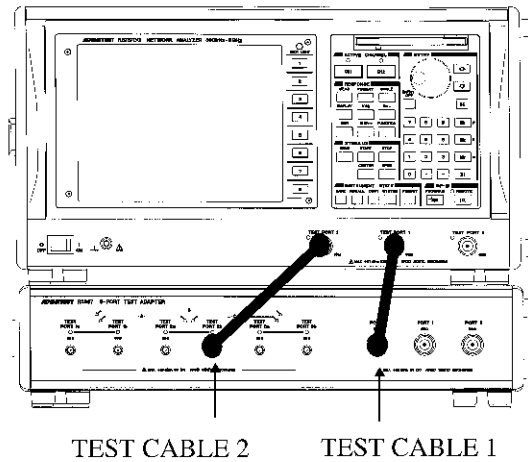

25. Confirm the insertion loss from TEST PORT 2 to TEST PORT 2b.
 Marker 1 shows the minimum response measured in a frequency range of 300 kHz to 8 GHz: 10dB or less

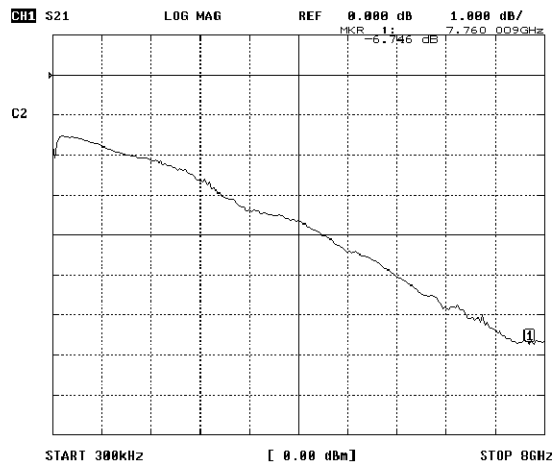

Insertion Loss from TEST PORT 3 to TEST PORT 3a

26. Set the path from PORT 3 to TEST PORT 3a using the following procedure.
 {ANTI Tx1 Rx1}
27. Connect TEST CABLE 1 to PORT 3 on the R3967 OPT11, and then connect TEST CABLE 2 to TEST PORT 3a on the R3967 OPT11 to read the insertion loss using the marker on the trace data.

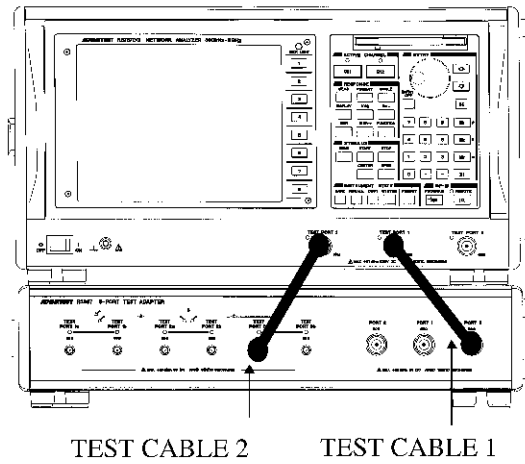

28. Confirm the insertion loss from TEST PORT 3 to TEST PORT 3a.
 Marker 1 shows the minimum response measured in a frequency range of 300 kHz to 8 GHz: 10dB or less

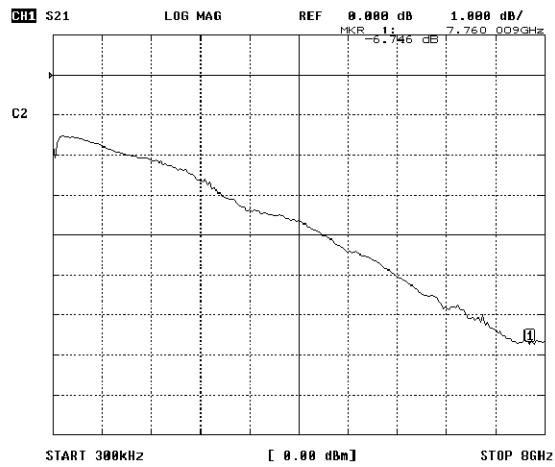

6.3.2 For the R3967 OPT11

Insertion Loss from TEST PORT 3 to TEST PORT 3b

- 29. Set the path from PORT 3 to TEST PORT 3b using the following procedure.
{ANT1 Tx1 Rx2}
- 30. Connect TEST CABLE 1 to PORT 3 on the R3967 OPT11, and then connect TEST CABLE 2 to TEST PORT 3b on the R3967 OPT11 to read the insertion loss using the marker on the trace data.

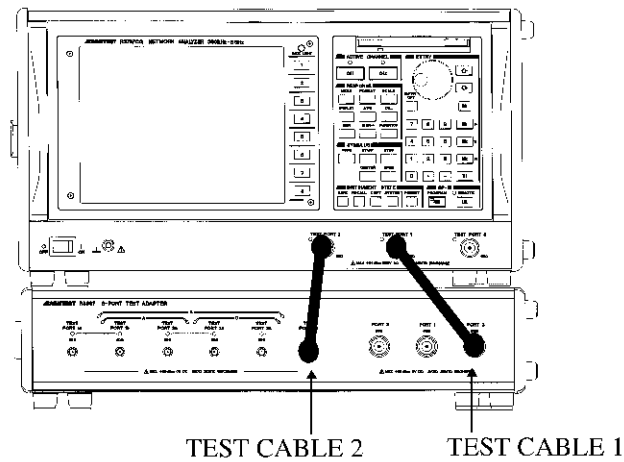

- 31. Confirm the insertion loss from TEST PORT 3 to TEST PORT 3b.
Marker 1 shows the minimum response measured in a frequency range of 300 kHz to 8 GHz: 10dB or less

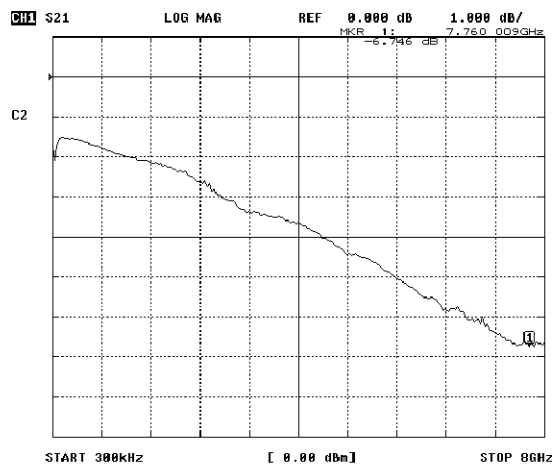

7. SPECIFICATIONS

7.1 Specifications for the R3967 OPT10

Characteristics		Description
1.	Characteristic impedance	50 Ω
2.	Frequency range	300 kHz to 8 GHz
3.	Insertion Loss	
	PORT 1 to TEST PORT 1a	5 dB or less
	PORT 2 to TEST PORT 2a	10 dB or less
	PORT 2 to TEST PORT 2b	10 dB or less
	PORT 3 to TEST PORT 3a	10 dB or less
	PORT 3 to TEST PORT 3b	10 dB or less
4.	Test port load match	
TEST PORT 2a	300 kHz to 500 MHz	10 dB or higher (23°C \pm 5°C)
	500 MHz to 3 GHz	15 dB or higher (23°C \pm 5°C)
	3 GHz to 8 GHz	12 dB or higher (23°C \pm 5°C)
TEST PORT 2b	300 kHz to 500 MHz	10 dB or higher (23°C \pm 5°C)
	500 MHz to 3 GHz	15 dB or higher (23°C \pm 5°C)
	3 GHz to 8 GHz	12 dB or higher (23°C \pm 5°C)
TEST PORT 3a	300 kHz to 500 MHz	10 dB or higher (23°C \pm 5°C)
	500 MHz to 3 GHz	15 dB or higher (23°C \pm 5°C)
	3 GHz to 8 GHz	12 dB or higher (23°C \pm 5°C)
TEST PORT 3b	300 kHz to 500 MHz	10 dB or higher (23°C \pm 5°C)
	500 MHz to 3 GHz	15 dB or higher (23°C \pm 5°C)
	3 GHz to 8 GHz	12 dB or higher (23°C \pm 5°C)
5.	Operating environment	Temperature range: 0°C to 50°C Relative humidity: 80% or lower (without condensation)
6.	Programming	All functions can be controlled from the R3767CG OPT11. The GPIB interface installed in the R3767CG OPT11 is also used when using remote control.
7.	Storage temperature range	-20°C to +60°C
8.	External dimensions	Approximately 424 (W) \times 88 (H) \times 400 (D) mm
9.	Mass	5 kg or less

7.2 Specifications for the R3967 OPT11

7.2 Specifications for the R3967 OPT11

Characteristics		Description
1. Characteristic impedance		50 Ω
2. Frequency range		300 kHz to 8 GHz
3. Insertion Loss	PORT 1 to TEST PORT 1a	10 dB or less
	PORT 1 to TEST PORT 1b	10 dB or less
	PORT 2 to TEST PORT 2a	10 dB or less
	PORT 2 to TEST PORT 2b	10 dB or less
	PORT 3 to TEST PORT 3a	10 dB or less
	PORT 3 to TEST PORT 3b	10 dB or less
4. Test port load match		
TEST PORT 1a	300 kHz to 500 MHz	10 dB or higher (23°C \pm 5°C)
	500 MHz to 3 GHz	15 dB or higher (23°C \pm 5°C)
	3 GHz to 8 GHz	12 dB or higher (23°C \pm 5°C)
TEST PORT 1b	300 kHz to 500 MHz	10 dB or higher (23°C \pm 5°C)
	500 MHz to 3 GHz	15 dB or higher (23°C \pm 5°C)
	3 GHz to 8 GHz	12 dB or higher (23°C \pm 5°C)
TEST PORT 2a	300 kHz to 500 MHz	10 dB or higher (23°C \pm 5°C)
	500 MHz to 3 GHz	15 dB or higher (23°C \pm 5°C)
	3 GHz to 8 GHz	12 dB or higher (23°C \pm 5°C)
TEST PORT 2b	300 kHz to 500 MHz	10 dB or higher (23°C \pm 5°C)
	500 MHz to 3 GHz	15 dB or higher (23°C \pm 5°C)
	3 GHz to 8 GHz	12 dB or higher (23°C \pm 5°C)
TEST PORT 3a	300 kHz to 500 MHz	10 dB or higher (23°C \pm 5°C)
	500 MHz to 3 GHz	15 dB or higher (23°C \pm 5°C)
	3 GHz to 8 GHz	12 dB or higher (23°C \pm 5°C)
TEST PORT 3b	300 kHz to 500 MHz	10 dB or higher (23°C \pm 5°C)
	500 MHz to 3 GHz	15 dB or higher (23°C \pm 5°C)
	3 GHz to 8 GHz	12 dB or higher (23°C \pm 5°C)
5. Operating environment		Temperature range: 0°C to 50°C Relative humidity: 80% or lower (without condensation)
6. Programming		All functions can be controlled from the R3767CG OPT11. The GPIB interface installed in the R3767CG OPT11 is also used when using remote control.
7. Storage temperature range		-20°C to +60°C

Characteristics	Description
8. External dimensions	Approximately 424 (W) × 88 (H) × 400 (D) mm
9. Mass	5 kg or less

APPENDIX

A.1 Function Extension and Configuration Extension Function

When this instrument is connected to the R3767CG OPT11, the following two functions are enabled.

- FUNCTION extension (to exchanging among the measurement paths in the test adapter)
- Calibration function extension (to save calibration data and measurement conditions temporarily)

The above functions are capable of choosing between the measurement paths much faster than the conventional Save/Call function.

These new functions can save only calibration data and measurement conditions (RESPONSE and STIMULUS).

NOTE: *The Save/Recall function installed in the network analyzer does not include the above two items (calibration data and measurement conditions (RESPONSE and STIMULUS)).*

This section explains new functions as follows.

A.1.1 FUNCTION extension (to choose between the test adapter measurement paths)

This function is designed to choose between the measurement paths in the multi-port test adapter. This function is also executed to choose between calibration data or among measurement conditions for each path at high speeds using the Soft Menu key or GPIB commands when this function is used together with the calibration function explained in paragraph A.1.2.

(Refer to paragraph A.1.3 for the soft key menu, or paragraph A.1.4 for the GPIB commands.)

A.1.2 Calibration function extension (to save calibration data and measurement conditions temporarily)

This function is designed to save calibration data and measurement conditions temporarily so that the high-speed exchanging function for calibration can be used when the multi-port test adapter is used.

This function can be executed using the Soft Menu key or GPIB commands.

(Refer to paragraph A.1.3 for the soft key menu, or paragraph A.1.4 for the GPIB commands.)

NOTE: *Measurement conditions will not match the calibration when measurement conditions are changed after a calibration has been performed and then "CORR:COLL:COPY" has been performed. (Be aware that no error messages are displayed if this is done.)*

A.1.3 Soft Menu Key

A.1.3 Soft Menu Key

1. R3767CG OPT11 soft key menu when connected to the R3967 OPT10

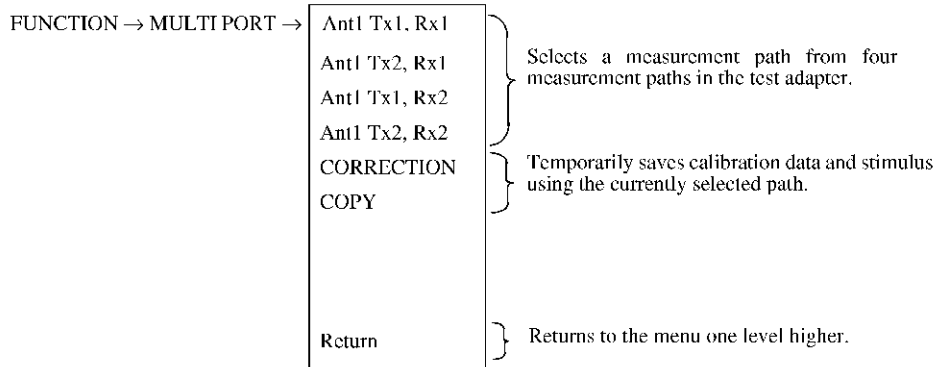

2. R3767CG OPT11 soft key menu when connected to the R3967 OPT11

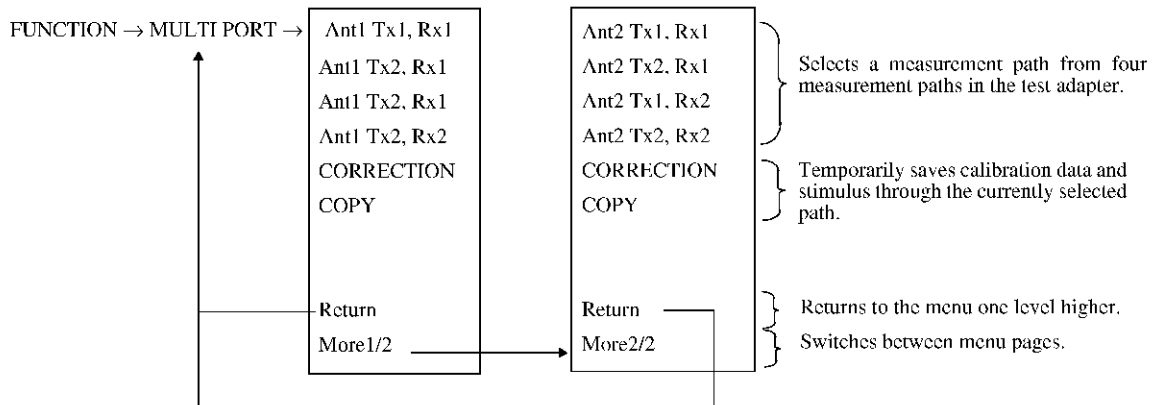

A.1.4 GPIB COMMAND LIST

1. FUNCTION extension (to choose between the measurement paths in the test adapter)

- **Function** Exchanging among the measurement paths in the multi-port test adapter
Exchanging among calibration data at high speeds and exchanging among measurement conditions at high speeds.

Sets measurement paths, calibration data and measurement conditions for a multi-port test adapter simultaneously.

Calibration data and measurement conditions for the extension memory area are automatically reproduced. However, calibration data and measurement conditions must temporarily be saved in the extension memory area using the calibration function extension that is explained later.

If this command specifies a measurement mode which has not been saved temporarily, the current calibration data and measurement data are used.

NOTE: *When the measurement mode is not saved temporarily, only the measurement path in the test adapter is changed.*

- **Presence of command and query**
Command/Query
- **New command**
Command [SENSe:]FUNctIon[<chno>]:SELEct MPAh<path>
Parameter <path>={11|12|1112|122|211|221|212|222} (*Note)
(*Note): For the R3967 OPT10 (Five-port test adapter), only "11|12|1112|122" must be used.
Response type MPAT11|MPAT12|MPAT112|MPAT122|MPAT21|MPAT22|MPAT212|MPAT222|
- **Previous command**
Command MPATH{11|12|1112|122|211|221|212|222}
Response type 1|0

2. Calibration function extension (to save calibration data and measurement conditions temporarily)

- **Function** Functions to temporarily saves calibration data and measurement conditions in extension memory area

This command temporarily saves calibration data and measurement conditions in extension memory area which is used to save calibration data and measurement conditions for each mode temporarily

Issue this command after measurement conditions and calibration data have been temporarily saved because the command uses the data currently set in the memory area.

Note that calibration data and measurement data which are temporarily saved in the extension memory area using this command are held as long as a power-down or preset is not performed. Perform a preset to clear the memory.

- **Presence of command and query**
Command only
- **New command**
Command [SENSe:]CORRection[<chno>]:COLLect:COpy
Parameter None
Response type None

A.1.5 GPIB Program EXAMPLE

- Previous command

Command	CXCOPY
Parameter	None
Response type	None

A.1.5 GPIB Program EXAMPLE

A five-port device measurement program using the R3967 OPT10.

There is no specific order in which CMPATH111 and CMPATH122 are performed.

```

OUTPUT 31;" SENS:FUNC:SEL CMPAT111"      ' Sets the measurement mode of the test adapter to "ANT1 Tx1 Rx1"
                                           mode.
OUTPUT 31;" SOUR:FREQ:STAR xx"           ' Sets the start frequency used for this path.
OUTPUT 31;" SOUR:FREQ:STOP xx"           ' Sets the stop frequency used for this path.
OUTPUT 31;" SOUR:SWE:POIN xx"            ' Sets the number of measurement points in this path.
OUTPUT 31;" SENS:CORR:COLL:METH F3P"     ' Performs a 3-port full calibration.
OUTPUT 31;" SENS:CORR:COLL STAN1;*WAI"
    
```

```

OUTPUT 31;" SENS:CORR:COLL:SAVE"         ' The 3-port full calibration is completed.
OUTPUT 31;" SENS:CORR:COLL:COPY"         ' Saves calibration data to the extension memory.
    
```

```

OUTPUT 31;" SENS:FUNC:SEL CMPAT122"     ' Sets the measurement mode of the test adapter to "ANT1 Tx2 Rx2"
                                           mode.
OUTPUT 31;" SOUR:FREQ:STAR xx"           ' Sets the start frequency used for this path. (See Note.)
OUTPUT 31;" SOUR:FREQ:STOP xx"           ' Sets the stop frequency used for this path. (See Note.)
OUTPUT 31;" SOUR:SWE:POIN xx"            ' Sets the number of measurement points in this path. (See Note.)
OUTPUT 31;" SENS:CORR:COLL:METH F3P"     ' Performs a 3-port full calibration.
OUTPUT 31;" SENS:CORR:COLL STAN1;*WAI"
    
```

```

OUTPUT 31;" SENS:CORR:COLL:SAVE"         ' The 3-port full calibration is completed.
OUTPUT 31;" SENS:CORR:COLL:COPY"         ' Saves calibration data to the extension memory.
    
```

Note: If CMPATH111 and CMPATH122 have the same measurement conditions, skip this step.

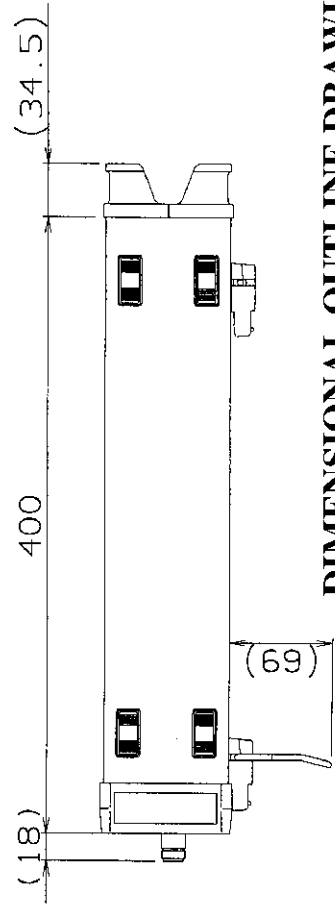
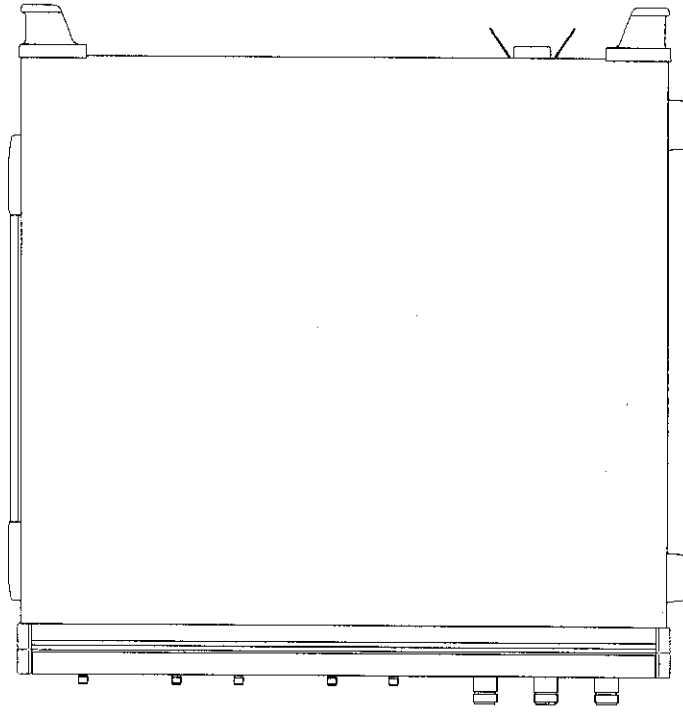
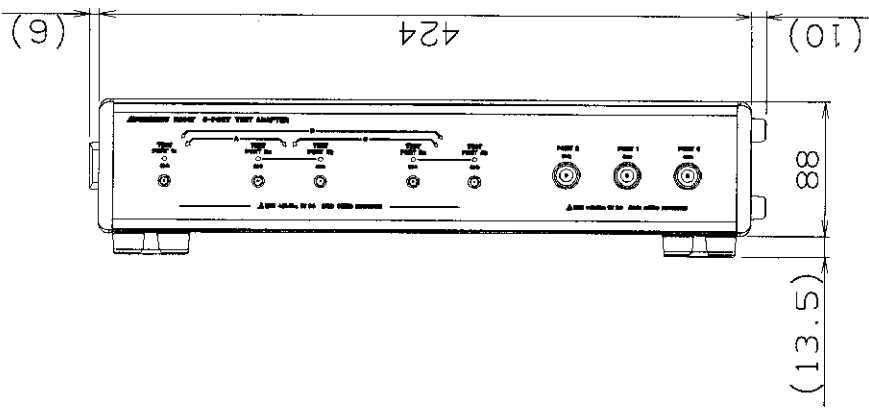

Unit : mm

CAUTION

This drawing shows external dimensions of this instrument.

The difference in products and options used can cause a change in the appearance of the instrument.

DIMENSIONAL OUTLINE DRAWING

ALPHABETICAL INDEX

	[A]			[O]
Accessories		1-1	Operating Environment	1-2
	[B]		OPERATION DESCRIPTION	5-1
BASIC MEASUREMENTS		4-1	Operation of the R3967 OPT10	5-1
	[C]		Operation of the R3967 OPT11	5-3
Calibration		1-6		[P]
Calibration function extension		A-1	PANEL DESCRIPTION	2-1
Cleaning		1-5	PERFORMANCE TESTS	6-1
Control Cable Connections		3-2	Preparations for the Tests	6-1
	[E]		Products Overview	1-1
Environmental Conditions		1-2		[R]
	[F]		R3967 OPT10 (Five-port Test Adapter)	
For the R3967 OPT10 (Insertion Loss) ..		6-16	Measurement Example	4-3
For the R3967 OPT10			R3967 OPT11 (Six-port Test Adapter)	
(Test Port Load Match)		6-2	Measurement Example	4-7
For the R3967 OPT11 (Insertion Loss) ..		6-23	Rear Panel Description	2-3
For the R3967 OPT11			RF cable connections	3-1
(Test Port Load Match)		6-8		[S]
Front Panel Description		2-1	Soft Menu Key	A-2
FUNCTION extension		A-1	SPECIFICATIONS	7-1
Function Extension and Configuration			Specifications for the R3967 OPT10	7-1
Extension Function		A-1	Specifications for the R3967 OPT11	7-2
	[G]		Storage	1-5
General Note		6-1		[T]
GPIB COMMAND LIST		A-3	Test Port Load Match	6-2
GPIB Program EXAMPLE		A-4	Transportation	1-6
	[I]			[W]
Insertion Loss		6-16	Warm-up	1-6, 6-1
Instrument Preparation		6-1		
INTRODUCTION		1-1		
	[M]			
Master Instrument		1-1		
Measurement Examples		4-3		
Measurement Overview		4-1		
	[N]			
NETWORK ANALYZER SETUP		3-1		
Notes on Use		1-3		

IMPORTANT INFORMATION FOR ADVANTEST SOFTWARE

PLEASE READ CAREFULLY: This is an important notice for the software defined herein. Computer programs including any additions, modifications and updates thereof, operation manuals, and related materials provided by Advantest (hereafter referred to as "SOFTWARE"), included in or used with hardware produced by Advantest (hereafter referred to as "PRODUCTS").

SOFTWARE License

All rights in and to the SOFTWARE (including, but not limited to, copyright) shall be and remain vested in Advantest. Advantest hereby grants you a license to use the SOFTWARE only on or with Advantest PRODUCTS.

Restrictions

- (1) You may not use the SOFTWARE for any purpose other than for the use of the PRODUCTS.
- (2) You may not copy, modify, or change, all or any part of, the SOFTWARE without permission from Advantest.
- (3) You may not reverse engineer, de-compile, or disassemble, all or any part of, the SOFTWARE.

Liability

Advantest shall have no liability (1) for any PRODUCT failures, which may arise out of any misuse (misuse is deemed to be use of the SOFTWARE for purposes other than its intended use) of the SOFTWARE. (2) For any dispute between you and any third party for any reason whatsoever including, but not limited to, infringement of intellectual property rights.

LIMITED WARRANTY

1. Unless otherwise specifically agreed by Seller and Purchaser in writing, Advantest will warrant to the Purchaser that during the Warranty Period this Product (other than consumables included in the Product) will be free from defects in material and workmanship and shall conform to the specifications set forth in this Operation Manual.
2. The warranty period for the Product (the "Warranty Period") will be a period of one year commencing on the delivery date of the Product.
3. If the Product is found to be defective during the Warranty Period, Advantest will, at its option and in its sole and absolute discretion, either (a) repair the defective Product or part or component thereof or (b) replace the defective Product or part or component thereof, in either case at Advantest's sole cost and expense.
4. This limited warranty will not apply to defects or damage to the Product or any part or component thereof resulting from any of the following:
 - (a) any modifications, maintenance or repairs other than modifications, maintenance or repairs (i) performed by Advantest or (ii) specifically recommended or authorized by Advantest and performed in accordance with Advantest's instructions;
 - (b) any improper or inadequate handling, carriage or storage of the Product by the Purchaser or any third party (other than Advantest or its agents);
 - (c) use of the Product under operating conditions or environments different than those specified in the Operation Manual or recommended by Advantest, including, without limitation, (i) instances where the Product has been subjected to physical stress or electrical voltage exceeding the permissible range and (ii) instances where the corrosion of electrical circuits or other deterioration was accelerated by exposure to corrosive gases or dusty environments;
 - (d) use of the Product in connection with software, interfaces, products or parts other than software, interfaces, products or parts supplied or recommended by Advantest;
 - (e) incorporation in the Product of any parts or components (i) provided by Purchaser or (ii) provided by a third party at the request or direction of Purchaser or due to specifications or designs supplied by Purchaser (including, without limitation, any degradation in performance of such parts or components);
 - (f) Advantest's incorporation or use of any specifications or designs supplied by Purchaser;
 - (g) the occurrence of an event of force majeure, including, without limitation, fire, explosion, geological change, storm, flood, earthquake, tidal wave, lightning or act of war; or
 - (h) any negligent act or omission of the Purchaser or any third party other than Advantest.
5. **EXCEPT TO THE EXTENT EXPRESSLY PROVIDED HEREIN, ADVANTEST HEREBY EXPRESSLY DISCLAIMS, AND THE PURCHASER HEREBY WAIVES, ALL WARRANTIES, WHETHER EXPRESS OR IMPLIED, STATUTORY OR OTHERWISE, INCLUDING, WITHOUT LIMITATION, (A) ANY WARRANTY OF MERCHANTABILITY OR FITNESS FOR A PARTICULAR PURPOSE AND (B) ANY WARRANTY OR REPRESENTATION AS TO THE VALIDITY, SCOPE, EFFECTIVENESS OR USEFULNESS OF ANY TECHNOLOGY OR ANY INVENTION.**
6. **THE REMEDY SET FORTH HEREIN SHALL BE THE SOLE AND EXCLUSIVE REMEDY OF THE PURCHASER FOR BREACH OF WARRANTY WITH RESPECT TO THE PRODUCT.**
7. **ADVANTEST WILL NOT HAVE ANY LIABILITY TO THE PURCHASER FOR ANY INDIRECT, INCIDENTAL, SPECIAL, CONSEQUENTIAL OR PUNITIVE DAMAGES, INCLUDING, WITHOUT LIMITATION, LOSS OF ANTICIPATED PROFITS OR REVENUES, IN ANY AND ALL CIRCUMSTANCES, EVEN IF ADVANTEST HAS BEEN ADVISED OF THE POSSIBILITY OF SUCH DAMAGES AND WHETHER ARISING OUT OF BREACH OF CONTRACT, WARRANTY, TORT (INCLUDING, WITHOUT LIMITATION, NEGLIGENCE), STRICT LIABILITY, INDEMNITY, CONTRIBUTION OR OTHERWISE. TORT (INCLUDING, WITHOUT LIMITATION, NEGLIGENCE), STRICT LIABILITY, INDEMNITY, CONTRIBUTION OR OTHERWISE.**
8. **OTHER THAN THE REMEDY FOR THE BREACH OF WARRANTY SET FORTH HEREIN, ADVANTEST SHALL NOT BE LIABLE FOR, AND HEREBY DISCLAIMS TO THE FULLEST EXTENT PERMITTED BY LAW ANY LIABILITY FOR, DAMAGES FOR PRODUCT FAILURE OR DEFECT, WHETHER ARISING OUT OF BREACH OF CONTRACT, TORT (INCLUDING, WITHOUT LIMITATION, NEGLIGENCE), STRICT LIABILITY, INDEMNITY, CONTRIBUTION OR OTHERWISE.**

CUSTOMER SERVICE DESCRIPTION

In order to maintain safe and trouble-free operation of the Product and to prevent the incurrence of unnecessary costs and expenses, Advantest recommends a regular preventive maintenance program under its maintenance agreement.

Advantest's maintenance agreement provides the Purchaser on-site and off-site maintenance, parts, maintenance machinery, regular inspections, and telephone support and will last a maximum of ten years from the date the delivery of the Product. For specific details of the services provided under the maintenance agreement, please contact the nearest Advantest office listed at the end of this Operation Manual or Advantest's sales representatives.

Some of the components and parts of this Product have a limited operating life (such as, electrical and mechanical parts, fan motors, unit power supply, etc.). Accordingly, these components and parts will have to be replaced on a periodic basis. If the operating life of a component or part has expired and such component or part has not been replaced, there is a possibility that the Product will not perform properly. Additionally, if the operating life of a component or part has expired and continued use of such component or part damages the Product, the Product may not be repairable. Please contact the nearest Advantest office listed at the end of this Operation Manual or Advantest's sales representatives to determine the operating life of a specific component or part, as the operating life may vary depending on various factors such as operating condition and usage environment.

SALES & SUPPORT OFFICES

Advantest Korea Co., Ltd.

22BF, Kyobo KangNam Tower,
1303-22, Seocho-Dong, Seocho-Ku, Seoul #137-070, Korea
Phone: +82-2-532-7071
Fax: +82-2-532-7132

Advantest (Suzhou) Co., Ltd.

Shanghai Branch Office:
Bldg. 6D, NO.1188 Gumei Road, Shanghai, China 201102 P.R.C.
Phone: +86-21-6485-2725
Fax: +86-21-6485-2726

Shanghai Branch Office:
406/F, Ying Building, Quantum Plaza, No. 23 Zhi Chun Road,
Hai Dian District, Beijing,
China 100083
Phone: +86-10-8235-3377
Fax: +86-10-8235-6717

Advantest (Singapore) Pte. Ltd.

438A Alexandra Road, #08-03/06
Alexandra Technopark Singapore 119967
Phone: +65-6274-3100
Fax: +65-6274-4055

Advantest America, Inc.

3201 Scott Boulevard, Suite, Santa Clara, CA 95054, U.S.A
Phone: +1-408-988-7700
Fax: +1-408-987-0691

ROHDE & SCHWARZ Europe GmbH

Mühldorfstraße 15 D-81671 München, Germany
(P.O.B. 80 14 60 D-81614 München, Germany)
Phone: +49-89-4129-13711
Fax: +49-89-4129-13723

ADVANTEST[®]

<http://www.advantest.co.jp>