ADVANTEST[®]
ADVANTEST CORPORATION

R4870 OPT01

GPIB-Master

Operation Manual

MANUAL NUMBER FOE-8440105D00

Safety Summary

To ensure thorough understanding of all functions and to ensure efficient use of this instrument, please read the manual carefully before using. Note that Advantest bears absolutely no responsibility for the result of operations caused due to incorrect or inappropriate use of this instrument.

If the equipment is used in a manner not specified by Advantest, the protection provided by the equipment may be impaired.

- **Warning Labels**

Warning labels are applied to Advantest products in locations where specific dangers exist. Pay careful attention to these labels during handling. Do not remove or tear these labels. If you have any questions regarding warning labels, please ask your nearest Advantest dealer. Our address and phone number are listed at the end of this manual.

Symbols of those warning labels are shown below together with their meaning.

DANGER: Indicates an imminently hazardous situation which will result in death or serious personal injury.

WARNING: Indicates a potentially hazardous situation which will result in death or serious personal injury.

CAUTION: Indicates a potentially hazardous situation which will result in personal injury or a damage to property including the product.

- **Basic Precautions**

Please observe the following precautions to prevent fire, burn, electric shock, and personal injury.

- Use a power cable rated for the voltage in question. Be sure however to use a power cable conforming to safety standards of your nation when using a product overseas.
- When inserting the plug into the electrical outlet, first turn the power switch OFF and then insert the plug as far as it will go.
- When removing the plug from the electrical outlet, first turn the power switch OFF and then pull it out by gripping the plug. Do not pull on the power cable itself. Make sure your hands are dry at this time.
- Before turning on the power, be sure to check that the supply voltage matches the voltage requirements of the instrument.
- Connect the power cable to a power outlet that is connected to a protected ground terminal. Grounding will be defeated if you use an extension cord which does not include a protected ground terminal.
- Be sure to use fuses rated for the voltage in question.
- Do not use this instrument with the case open.
- Do not place anything on the product and do not apply excessive pressure to the product. Also, do not place flower pots or other containers containing liquid such as chemicals near this

Safety Summary

product.

- When the product has ventilation outlets, do not stick or drop metal or easily flammable objects into the ventilation outlets.
- When using the product on a cart, fix it with belts to avoid its drop.
- When connecting the product to peripheral equipment, turn the power off.

- **Caution Symbols Used Within this Manual**

Symbols indicating items requiring caution which are used in this manual are shown below together with their meaning.

DANGER: Indicates an item where there is a danger of serious personal injury (death or serious injury).

WARNING: Indicates an item relating to personal safety or health.

CAUTION: Indicates an item relating to possible damage to the product or instrument or relating to a restriction on operation.

- **Safety Marks on the Product**

The following safety marks can be found on Advantest products.



: ATTENTION - Refer to manual.



: Protective ground (earth) terminal.



: DANGER - High voltage.



: CAUTION - Risk of electric shock.

- **Replacing Parts with Limited Life**

The following parts used in the instrument are main parts with limited life.

Replace the parts listed below before their expected lifespan has expired to maintain the performance and function of the instrument.

Note that the estimated lifespan for the parts listed below may be shortened by factors such as the environment where the instrument is stored or used, and how often the instrument is used.

The parts inside are not user-replaceable. For a part replacement, please contact the Advantest sales office for servicing.

Each product may use parts with limited life.

For more information, refer to the section in this document where the parts with limited life are described.

Main Parts with Limited Life

Part name	Life
Unit power supply	5 years
Fan motor	5 years
Electrolytic capacitor	5 years
LCD display	6 years
LCD backlight	2.5 years
Floppy disk drive	5 years
Memory backup battery	5 years

- **Hard Disk Mounted Products**

The operational warnings are listed below.

- Do not move, shock and vibrate the product while the power is turned on.
Reading or writing data in the hard disk unit is performed with the memory disk turning at a high speed. It is a very delicate process.
- Store and operate the products under the following environmental conditions.
An area with no sudden temperature changes.
An area away from shock or vibrations.
An area free from moisture, dirt, or dust.
An area away from magnets or an instrument which generates a magnetic field.
- Make back-ups of important data.
The data stored in the disk may become damaged if the product is mishandled. The hard disc has a limited life span which depends on the operational conditions. Note that there is no guarantee for any loss of data.

- **Precautions when Disposing of this Instrument**

When disposing of harmful substances, be sure dispose of them properly with abiding by the state-provided law.

Harmful substances: (1) PCB (polycarbon biphenyl)
(2) Mercury
(3) Ni-Cd (nickel cadmium)
(4) Other
Items possessing cyan, organic phosphorous and hexadic chromium and items which may leak cadmium or arsenic (excluding lead in solder).

Example: fluorescent tubes, batteries

Environmental Conditions

This instrument should be only be used in an area which satisfies the following conditions:

- An area free from corrosive gas
- An area away from direct sunlight
- A dust-free area
- An area free from vibrations
- Altitude of up to 2000 m



Figure-1 Environmental Conditions

- Operating position



Figure-2 Operating Position

- Storage position



Figure-3 Storage Position

- The classification of the transient over-voltage, which exists typically in the main power supply, and the pollution degree is defined by IEC61010-1 and described below.

Impulse withstand voltage (over-voltage) category II defined by IEC60364-4-443

Pollution Degree 2

Types of Power Cable

Replace any references to the power cable type, according to the following table, with the appropriate power cable type for your country.

Plug configuration	Standards	Rating, color and length	Model number (Option number)
	PSE: Japan Electrical Appliance and Material Safety Law	125 V at 7 A Black 2 m (6 ft)	Straight: A01402 Angled: A01412
	UL: United States of America CSA: Canada	125 V at 7 A Black 2 m (6 ft)	Straight: A01403 (Option 95) Angled: A01413
	CEE: Europe DEMKO: Denmark NEMKO: Norway VDE: Germany KEMA: The Netherlands CEBEC: Belgium OVE: Austria FIMKO: Finland SEMKO: Sweden	250 V at 6 A Gray 2 m (6 ft)	Straight: A01404 (Option 96) Angled: A01414
	SEV: Switzerland	250 V at 6 A Gray 2 m (6 ft)	Straight: A01405 (Option 97) Angled: A01415
	SAA: Australia, New Zealand	250 V at 6 A Gray 2 m (6 ft)	Straight: A01406 (Option 98) Angled: -----
	BS: United Kingdom	250 V at 6 A Black 2 m (6 ft)	Straight: A01407 (Option 99) Angled: A01417
	CCC: China	250 V at 10 A Black 2 m (6 ft)	Straight: A114009 (Option 94) Angled: A114109

CAUTIONS ON USING THE R4870

1. HANDLING TEST RESULTS

- Test results are displayed on the system screen.
- Test results include test data and a PASS or FAIL evaluation result.
If the test parameter is changed in the test result display after the test is completed, the change is reflected only in the test data. In this situation, the test data does not match the PASS or FAIL evaluation result, and the test data and evaluation result become invalid.
- The test data includes errors due to the measurement accuracy described in Chapter 7, "SPECIFICATIONS." Note that errors may also occur because the R4870 is not from an authorized institution.

2. SAFETY PRECAUTIONS

The R4870 Component Analyzer has Microsoft Windows NT Embedded pre-installed.

The measuring function of the R4870 is dependent on the Windows environment. Do not alter the Windows operating environment in any way other than described in this manual.

Furthermore, the R4870 is not a data processor. Operate it only as described in this manual.

1. Non-permitted actions:

- Installing other application programs.
- Changing or deleting items in the control panel (except for A.4, "Network Setting").
- Opening or operating the existing files in C drive.
- Operating other application programs during the measurement.
- Upgrading the Windows operating system.
- If the R4870 does not function correctly due to any of the above, reinstall the system using the system recovery disk.

For information on system recovery method, see section A.3, "R4870 System Recovery Procedure").

2. Computer viruses

Depending on the operating environment and method, the system can be contaminated by a computer virus. To use the system securely, it is recommended to take the following counter measures:

- Run a virus check before loading a file or media from an outside source.
- Make sure that any network has safety measures against computer viruses before connecting.
- If infected with a computer virus:

Delete all files in the D drive. Re-install the system using the recovery disk.

For information on system recovery method, see section A.3, "R4870 System Recovery Procedure").

CAUTIONS ON USING THE R4870

3. Application software:

When executing application programs on R4870, some operations may differ due to the Windows environment.

The R4870 has Windows NT (English) preinstalled. Create application software programs using the same operation environment.

4. If trouble occurs and the cooling fan in the rear side of the unit stops, the alarm sounds continuously. When the alarm goes off, immediately check what is causing the fan to stop and remove the obstruction. If the fan still does not move, turn off the R4870, following the normal procedure, and contact the ADVANTEST Sales Office.

5. Trigger output:

The trigger output function is unavailable in the R4870. The trigger timing is different depending on the measuring item.

3. Limitations Imposed when Using Windows NT

END-USER LICENSE AGREEMENT FOR MICROSOFT SOFTWARE

- **IMPORTANT-READ CAREFULLY:**
 - ❖ You have acquired a device ("INSTRUMENT") that includes software licensed by [ADVANTEST] from Microsoft Licensing Inc. or its affiliates ("MS"). Those installed software products of MS origin, as well as associated media, printed materials, and "online" or electronic documentation ("SOFTWARE") are protected by international intellectual property laws and treaties. The SOFTWARE is licensed, not sold. All rights reserved.
- **IF YOU DO NOT AGREE TO THIS END USER LICENSE AGREEMENT ("EULA"), DO NOT USE THE INSTRUMENT OR COPY THE SOFTWARE. INSTEAD, PROMPTLY CONTACT [ADVANTEST] FOR INSTRUCTIONS ON RETURN OF THE UNUSED "INSTRUMENT (S)" FOR A REFUND. ANY USE OF THE SOFTWARE, INCLUDING BUT NOT LIMITED TO USE ON THE INSTRUMENT, WILL CONSTITUTE YOUR AGREEMENT TO THIS EULA (OR RATIFICATION OF ANY PREVIOUS CONSENT).**
- **GRANT OF SOFTWARE LICENSE.** This EULA grants you the following license:
 - You may use the SOFTWARE only on the INSTRUMENT.
 - **NOT FAULT TOLERANT.** THE SOFTWARE IS NOT FAULT TOLERANT. [ADVANTEST] HAS INDEPENDENTLY DETERMINED HOW TO USE THE SOFTWARE IN THE INSTRUMENT, AND "MS" HAS RELIED UPON [ADVANTEST] TO CONDUCT SUFFICIENT TESTING TO DETERMINE THAT THE SOFTWARE IS SUITABLE FOR SUCH USE.
 - **NO WARRANTIES FOR THE SOFTWARE. THE SOFTWARE is provided "AS IS" and with all faults. THE ENTIRE RISK AS TO SATISFACTORY QUALITY, PERFORMANCE, ACCURACY, AND EFFORT (INCLUDING LACK OF NEGLIGENCE) IS WITH YOU. ALSO, THERE IS NO WARRANTY AGAINST INTERFERENCE WITH YOUR ENJOYMENT OF THE SOFTWARE OR AGAINST INFRINGEMENT. IF YOU HAVE RECEIVED ANY WARRANTIES REGARDING THE INSTRUMENT OR THE SOFTWARE, THOSE WARRANTIES DO NOT ORIGINATE FROM, AND ARE NOT BINDING ON, "MS".**
 - **Note on Java Support.** The SOFTWARE may contain support for programs written in Java. Java technology is not fault tolerant and is not designed, manufactured, or intended for use or resale as online control equipment in hazardous environments requiring fail-safe performance, such as in the operation of nuclear facilities, aircraft navigation or communication systems, air traffic control, direct life support machines, or weapons systems, in which the failure of Java technology could lead directly to death, personal injury, or severe physical or environmental damage. Sun Microsystems, Inc. has contractually obligated MS to make this disclaimer.
 - **No Liability for Certain Damages. EXCEPT AS PROHIBITED BY LAW, MS SHALL HAVE NO LIABILITY FOR ANY INDIRECT, SPECIAL, CONSEQUENTIAL OR INCIDENTAL DAMAGES ARISING FROM OR IN CONNECTION WITH THE USE OR PERFORMANCE OF THE SOFTWARE. THIS LIMITATION SHALL APPLY EVEN IF ANY REMEDY FAILS OF ITS ESSENTIAL PURPOSE. IN NO EVENT SHALL MS BE LIABLE FOR ANY AMOUNT IN EXCESS OF U.S. TWO HUNDRED FIFTY DOLLARS (U.S.\$250.00).**
 - **Limitations on Reverse Engineering, Decompilation, and Disassembly.** You may not reverse engineer, decompile, or disassemble the SOFTWARE, except and only to the extent that such activity is expressly permitted by applicable law notwithstanding this limitation.
 - **SOFTWARE TRANSFER ALLOWED BUT WITH RESTRICTIONS.** You may permanently transfer rights under this EULA only as part of a permanent sale or transfer of the INSTRUMENT, and only if the recipient agrees to this EULA. If the SOFTWARE is an upgrade, any transfer must also include all prior versions of the SOFTWARE.
 - **EXPORT RESTRICTIONS.** You acknowledge that SOFTWARE is of US-origin. You agree to comply with all applicable international and national laws that apply to the SOFTWARE, including the U.S. Export Administration Regulations, as well as end-user, end-use and country destination restrictions issued by U.S. and other governments. For additional information on exporting the SOFTWARE, see <http://www.microsoft.com/exporting/>.
 - If you use the INSTRUMENT to access or utilize the services or functionality of Microsoft Windows NT Server 4.0 (all editions) or Microsoft Windows 2000 Server (all editions), or use the INSTRUMENT to permit workstation or computing devices to access or utilize the services or functionality of Microsoft Windows NT Server 4.0 or Microsoft Windows 2000 Server, you may be required to obtain a Client Access License for the INSTRUMENT and/or each such workstation or computing device. Please refer to the end user license agreement for Microsoft Windows NT Server 4.0 or Microsoft Windows 2000 Server for additional information.

Certificate of Conformity



This is to certify, that

Radio Communication Tester

R4870 Series

instrument, type, designation

complies with the provisions of the EMC Directive 89/336/EEC in accordance with EN61326 and Low Voltage Directive 73/23/EEC in accordance with EN61010.

ADVANTEST Corp.

Tokyo, Japan

ROHDE&SCHWARZ

Engineering and Sales GmbH
Munich, Germany

PREFACE

The R4870 OPT01 GPIB Master (this equipment) Operation Manuals consist of the following two manuals:

R4870 OPT01 GPIB-Master Operation Manual

This manual describes the basic operations and functions of this equipment when used in a system. Basic operations and functions when used as an individual device are either omitted or abbreviated. Read before using the R4870. (This manual)

R4870 Radio Communication Tester Operation Manual

This manual describes the basic operations and functions of this equipment when used as an individual device. Functions that are supported by the system are not described in the manual. Read before using the R4870, if necessary. (Separate manual)

1. This manual consists of the following chapters and sections.

Safety Summary	Safety precautions. Read before using the R4870.
CAUTIONS ON USING THE R4870	
1. INTRODUCTION	This chapter describes the R4870 operational environment and accessories, and explains how to run the system initialization check.
2. OPERATIONS	System operations can be learned using the basic operations and test examples in this chapter.
3. REFERENCE	This chapter describes the listed operation menus, structures, and functions.
4. TEST METHODS	This chapter describes the test setting conditions and results.
5. CALIBRATION	This chapter describes how to calibrate this equipment to decrease the number of errors in tests performed by this equipment.
6. REMOTE CONTROL	This chapter describes how to control the R4870 by using a remote PC.
7. SPECIFICATIONS	This chapter describes the system specifications.
APPENDIX A.1 Troubleshooting	Read if a problem occurs.
A.2 Error Messages	Error numbers and messages are listed and explained.
IMPORTANT INFORMATION FOR ADVANTEST SOFTWARE	Be sure to read before using the R4870.
LIMITED WARRANTY	
CUSTOMER SERVICE DESCRIPTION	

PREFACE

2. Notation rule

- The panel keys and soft keys are noted in this manual as described below.

The panel keys include buttons and numeric keys on the front panel.

The soft keys include menus, drop down menus, side menus, and tabs displayed on the screen.

Panel key: example: **A1**, **POWER**

Soft key: example: **SIG RF**, **Mode**

- A → separates successive keystrokes in key operations.

3. Trademarks

- Bluetooth and the Bluetooth logos are trademarks owned by the Bluetooth SIG, Inc.
- Windows NT is trademark or registered trademark of Microsoft Corporation.
- VisualBasic6.0 is trademark of Microsoft Corporation.
- VisualC++6.0 is trademark of Microsoft Corporation.

TABLE OF CONTENTS

1.	INTRODUCTION	1-1
1.1	System Overview	1-1
1.2	Accessories	1-2
1.3	Connection and Operation Test	1-3
1.3.1	Connection between System Devices	1-3
1.3.2	List of Connections between Devices	1-4
1.3.2.1	Connection of 2303 Power Supply Output Cable	1-4
1.3.3	Connection Cable Options	1-5
1.3.4	Procedures for Turning on Power	1-5
1.4	Warm up	1-7
1.5	Calibration	1-7
1.6	Peripheral Device Option	1-8
2.	OPERATIONS	2-1
2.1	Basic Operation	2-1
2.1.1	Turning on Power	2-1
2.2	Standards Compliance Test Items and Settings	2-3
2.2.1	RF Test Items	2-3
2.2.2	Items for Measurement Settings	2-4
2.2.2.1	SIG Measurement Setting	2-4
2.2.2.2	TELEC Test Setting	2-5
2.2.3	Setting Pass and Fail Limits	2-7
2.2.3.1	SIG RF Settings	2-7
2.2.3.2	TELEC RF Settings	2-8
2.3	Setting Procedures before Measurement	2-9
2.3.1	IUT Connection	2-9
2.3.2	Procedures for Turning on Power	2-9
2.3.3	Recognition of Peripheral Devices	2-9
2.3.4	Measurement-Related Settings	2-10
2.3.4.1	SIG Item Select	2-10
2.3.4.2	PASS/FAIL Limit	2-12
2.3.4.3	Test Parameter	2-13
2.3.4.3.1	Output Power (Power Control): Power Range	2-13
2.3.4.3.2	Power Density: Sweep Time	2-14
2.3.4.3.3	Power Control: Minimum Power	2-15
2.3.4.3.4	Frequency Range: Power Level	2-16
2.3.4.3.5	20 dB Bandwidth: Bandwidth Level	2-17
2.3.4.3.6	ACP: Number of Adjacent Channel	2-17
2.3.4.3.7	Modulation Characteristics: Sample Packet	2-18
2.3.4.3.8	Frequency Tolerance: Sample Packet,etc.../ Frequency Drift: Sample Packet,etc...	2-18
2.3.4.3.9	Spurious Emissions (ETS)/(FCC): Test Frequency	2-19
2.3.4.3.10	Receiver Test: (BER,PER)	2-20
2.3.4.3.11	Sensitivity - single/multi: Dirty ON/OFF, TX Level	2-20
2.3.4.3.12	C/I Performance: Image Frequency	2-21
2.3.4.3.13	Blocking performance: Signal Level	2-22

 Table of Contents

2.3.4.3.14	Intermodulation Performance: Signal Level	2-23
2.3.4.3.15	Maximum Input Level: Tx Level	2-23
2.3.4.4	Setting LMP_test_control	2-23
2.3.4.5	System Setup	2-24
2.3.4.5.1	DC Power Source	2-24
2.3.4.5.2	Setting RS-232 (HCI)	2-26
2.3.4.5.3	Setting IUT Information	2-27
2.3.4.5.4	Setting System Configuration	2-27
2.3.4.5.5	Setting Comment Edit	2-27
2.4	Measurement Execution Method	2-28
2.4.1	SIG RF Test	2-28
2.4.2	TELEC Test	2-31
2.4.2.1	Preparation for Measurement	2-31
2.5	Method to Identify Malfunctioning	2-38
2.5.1	Setting Measurement Parameters	2-38
2.5.2	Faults in the Connection Cable	2-38
2.5.3	Faults in Measuring Instruments	2-38
3.	REFERENCE	3-1
3.1	Menu Index	3-1
3.2	Menu Map	3-5
3.2.1	Main Menu and Drop Down Menu	3-5
3.2.2	Side Menu	3-6
3.2.3	Tab	3-14
3.2.3.1	SIG RF tab	3-14
3.2.3.2	RF Measurement	3-20
3.2.3.3	TELEC tab	3-21
3.3	Functional Descriptions	3-23
3.3.1	Main Menu	3-23
3.3.2	Side Menu	3-24
3.4	Bluetooth SIG RF Test Items and Passing Ranges	3-33
3.5	Pass/Fail Evaluation of the Bluetooth SIG RF Test	3-35
4.	TEST METHODS	4-1
4.1	SIG RF	4-2
4.1.1	Output Power	4-2
4.1.2	Power Density	4-3
4.1.3	Power Control	4-3
4.1.4	TX Output Spectrum - Frequency Range	4-4
4.1.5	TX Output Spectrum - 20dB Bandwidth	4-4
4.1.6	TX Output Spectrum - Adjacent Channel Power	4-5
4.1.7	Modulation Characteristics	4-5
4.1.8	Initial Carrier Frequency Tolerance	4-5
4.1.9	Carrier Frequency Drift	4-5
4.1.10	Out-of-Band Spurious Emissions	4-6
4.1.11	Sensitivity (single slot packets)	4-6
4.1.12	Sensitivity (multi-slot packets)	4-6
4.1.13	C/I performance	4-7

4.1.14	Blocking performance	4-8
4.1.15	Intermodulation performance	4-9
4.1.16	Maximum Input Level	4-9
4.2	Telec Test	4-10
4.2.1	Frequency Tolerance	4-10
4.2.2	Occupied Frequency Bandwidth / Spread Bandwidth	4-10
4.2.3	Tolerance of Antenna Power	4-11
4.2.4	Spurious Emission Strength	4-11
4.2.5	Staying Time	4-11
4.2.6	Secondarily Emitted Radio Wave Strength	4-12
5.	CALIBRATION	5-1
5.1	Calibration Setting Procedure	5-1
5.2	Power Splitter Calibration	5-3
5.3	Monitor2 Port Calibration	5-5
5.4	Monitor1 Port Calibration	5-6
5.5	CH1-Input Calibration	5-7
5.6	CH1-Output Calibration	5-8
5.7	Interfere1 Port Calibration	5-9
5.8	Interfere2 Port Calibration	5-10
5.9	Continuous Calibration	5-11
6.	REMOTE CONTROL	6-1
6.1	Function Specifications	6-1
6.1.1	CONFigure Subsystem - SIG RF	6-8
6.1.1.1	WmtConfSigPowDens	6-8
6.1.1.2	QryConfSigPowDens	6-8
6.1.1.3	WmtConfSigPowCont	6-8
6.1.1.4	QryConfSigPowCont	6-9
6.1.1.5	WmtConfSigFreqRang	6-9
6.1.1.6	QryConfSigFreqRang	6-9
6.1.1.7	WmtConfSig20dBBwid	6-10
6.1.1.8	QryConfSig20dBBwid	6-10
6.1.1.9	WmtConfSigACP	6-11
6.1.1.10	QryConfSigACP	6-11
6.1.1.11	WmtConfSigSpurEmis	6-12
6.1.1.12	QryConfSigSpurEmis	6-12
6.1.1.13	WmtConfSigCIPerf	6-13
6.1.1.14	QryConfSigCIPerf	6-13
6.1.1.15	WmtConfSigBlocPerf	6-14
6.1.1.16	QryConfSigBlocPerf	6-14
6.1.1.17	WmtConfSigIModPerf	6-14
6.1.1.18	QryConfSigIModPerf	6-15
6.1.1.19	WmtConfSigOutpPowTestType	6-15
6.1.1.20	QryConfSigOutpPowTestType	6-15
6.1.1.21	WmtConfSigPowDensTestType	6-16
6.1.1.22	QryConfSigPowDensTestType	6-16
6.1.1.23	WmtConfSigPowContTestType	6-16

Table of Contents

6.1.1.24	QryConfSigPowContTestType	6-17
6.1.1.25	WmtConfSigFreqRangTestType	6-17
6.1.1.26	QryConfSigFreqRangTestType	6-17
6.1.1.27	WmtConfSig20dBBwidTestType	6-18
6.1.1.28	QryConfSig20dBBwidTestType	6-18
6.1.1.29	WmtConfSigACPTestType	6-18
6.1.1.30	QryConfSigACPTestType	6-19
6.1.1.31	WmtConfSigSpurEmisTestType	6-19
6.1.1.32	QryConfSigSpurEmisTestType	6-19
6.1.1.33	WmtConfSigCIPerfTestType	6-20
6.1.1.34	QryConfSigCIPerfTestType	6-20
6.1.1.35	WmtConfSigBlocPerfTestType	6-20
6.1.1.36	QryConfSigBlocPerfTestType	6-21
6.1.1.37	WmtConfSigIModPerfTestType	6-21
6.1.1.38	QryConfSigIModPerfTestType	6-21
6.1.1.39	WmtConfSigPowDensUp	6-22
6.1.1.40	QryConfSigPowDensUp	6-22
6.1.1.41	WmtConfSigPowContClas1Lo	6-22
6.1.1.42	QryConfSigPowContClas1Lo	6-23
6.1.1.43	WmtConfSigPowContStepUp	6-23
6.1.1.44	QryConfSigPowContStepUp	6-23
6.1.1.45	WmtConfSigPowContStepLo	6-24
6.1.1.46	QryConfSigPowContStepLo	6-24
6.1.1.47	WmtConfSigFreqRangUp	6-24
6.1.1.48	QryConfSigFreqRangUp	6-25
6.1.1.49	WmtConfSigFreqRangLo	6-25
6.1.1.50	QryConfSigFreqRangLo	6-25
6.1.1.51	WmtConfSigFreqRangFranUp	6-26
6.1.1.52	QryConfSigFreqRangFranUp	6-26
6.1.1.53	WmtConfSigFreqRangFranLo	6-26
6.1.1.54	QryConfSigFreqRangFranLo	6-27
6.1.1.55	WmtConfSig20dBBwidUp	6-27
6.1.1.56	QryConfSig20dBBwidUp	6-27
6.1.1.57	WmtConfSigACPMN2Up	6-28
6.1.1.58	QryConfSigACPMN2Up	6-28
6.1.1.59	WmtConfSigACPMN3Up	6-28
6.1.1.60	QryConfSigACPMN3Up	6-29
6.1.1.61	WmtConfSigSpurEmisEtsUp	6-30
6.1.1.62	QryConfSigSpurEmisEtsUp	6-31
6.1.1.63	WmtConfSigSpurEmisFccUp	6-31
6.1.1.64	QryConfSigSpurEmisFccUp	6-31
6.1.1.65	WmtConfSigSpurEmisSele	6-32
6.1.1.66	QryConfSigSpurEmisSele	6-32
6.1.1.67	WmtConfSigCIPerfBerUp	6-32
6.1.1.68	QryConfSigCIPerfBerUp	6-33
6.1.1.69	WmtConfSigBlocPerfBerUp	6-33
6.1.1.70	QryConfSigBlocPerfBerUp	6-33
6.1.1.71	WmtConfSigIModPerfBerUp	6-34
6.1.1.72	QryConfSigIModPerfBerUp	6-34
6.1.1.73	WmtConfSigOutpPowBursLo	6-34
6.1.1.74	QryConfSigOutpPowBursLo	6-35

6.1.1.75	WmtConfSigOutpPowBursUp	6-35
6.1.1.76	QryConfSigOutpPowBursUp	6-35
6.1.1.77	WmtConfSigOutpPowLeadTrad	6-36
6.1.1.78	QryConfSigOutpPowLeadTrad	6-36
6.1.1.79	WmtConfSigOutpPowAvgCnt	6-36
6.1.1.80	QryConfSigOutpPowAvgCnt	6-37
6.1.1.81	WmtConfSigPowDensStdPkPowSweeTime	6-37
6.1.1.82	QryConfSigPowDensStdPkPowSweeTime	6-37
6.1.1.83	WmtConfSigPowDensStdPkFreqSweeTime	6-38
6.1.1.84	QryConfSigPowDensStdPkFreqSweeTime	6-38
6.1.1.85	WmtConfSigPowDensHspdPkPowSweeTime	6-39
6.1.1.86	QryConfSigPowDensHspdPkPowSweeTime	6-39
6.1.1.87	WmtConfSigPowDensHspdPkFreqSweeTime	6-39
6.1.1.88	QryConfSigPowDensHspdPkFreqSweeTime	6-40
6.1.1.89	WmtConfSigPowContStepNum	6-40
6.1.1.90	QryConfSigPowContStepNum	6-40
6.1.1.91	WmtConfSigPowContStdMinPowUp	6-41
6.1.1.92	QryConfSigPowContStdMinPowUp	6-41
6.1.1.93	WmtConfSigPowContHspdMinPowUp	6-41
6.1.1.94	QryConfSigPowContHspdMinPowUp	6-42
6.1.1.95	WmtConfSigPowContWaitTout	6-42
6.1.1.96	QryConfSigPowContWaitTout	6-42
6.1.1.97	WmtConfSigPowContJudgStepNum	6-43
6.1.1.98	QryConfSigPowContJudgStepNum	6-43
6.1.1.99	WmtConfSigPowContJudgMinPow	6-44
6.1.1.100	QryConfSigPowContJudgMinPow	6-44
6.1.1.101	WmtConfSigFreqRangLev	6-44
6.1.1.102	QryConfSigFreqRangLev	6-45
6.1.1.103	WmtConfSigFreqRangSweeCnt	6-45
6.1.1.104	QryConfSigFreqRangSweeCnt	6-45
6.1.1.105	WmtConfSig20dBBwidLev	6-46
6.1.1.106	QryConfSig20dBBwidLev	6-46
6.1.1.107	WmtConfSigACPNumAdCh	6-46
6.1.1.108	QryConfSigACPNumAdCh	6-47
6.1.1.109	WmtConfSigSpurEmisEtsHspdFreq	6-47
6.1.1.110	QryConfSigSpurEmisEtsHspdFreq	6-47
6.1.1.111	WmtConfSigSpurEmisEtsStdFreqLo	6-48
6.1.1.112	QryConfSigSpurEmisEtsStdFreqLo	6-48
6.1.1.113	WmtConfSigSpurEmisEtsStdFreqUp	6-49
6.1.1.114	QryConfSigSpurEmisEtsStdFreqUp	6-49
6.1.1.115	WmtConfSigSpurEmisFccHspdFreq	6-49
6.1.1.116	QryConfSigSpurEmisFccHspdFreq	6-50
6.1.1.117	WmtConfSigSpurEmisFccStdFreqLo	6-50
6.1.1.118	QryConfSigSpurEmisFccStdFreqLo	6-50
6.1.1.119	WmtConfSigSpurEmisFccStdFreqUp	6-51
6.1.1.120	QryConfSigSpurEmisFccStdFreqUp	6-51
6.1.1.121	WmtConfSigCIPerfImagFreq	6-51
6.1.1.122	QryConfSigCIPerfImagFreq	6-52
6.1.1.123	WmtConfSigCIPerfWantLev	6-52
6.1.1.124	QryConfSigCIPerfWantLev	6-53
6.1.1.125	WmtConfSigCIPerfInteLev	6-53

Table of Contents

6.1.1.126	QryConfSigCIPerfInteLev	6-54
6.1.1.127	WmtConfSigCIPerfInteRelaLev	6-54
6.1.1.128	QryConfSigCIPerfInteRelaLev	6-55
6.1.1.129	WmtConfSigBlocPerfWantLev	6-55
6.1.1.130	QryConfSigBlocPerfWantLev	6-56
6.1.1.131	WmtConfSigBlocPerfInteLev	6-56
6.1.1.132	QryConfSigBlocPerfInteLev	6-57
6.1.1.133	WmtConfSigIModPerfWantLev	6-57
6.1.1.134	QryConfSigIModPerfWantLev	6-58
6.1.1.135	WmtConfSigIModPerfF1Lev	6-58
6.1.1.136	QryConfSigIModPerfF1Lev	6-58
6.1.1.137	WmtConfSigIModPerfF2Lev	6-59
6.1.1.138	QryConfSigIModPerfF2Lev	6-59
6.1.1.139	WmtConfSigBlocPerfSmpAlc	6-59
6.1.1.140	QryConfSigBlocPerfSmpAlc	6-60
6.1.1.141	WmtConfSigPowDensTestPack	6-60
6.1.1.142	QryConfSigPowDensTestPack	6-60
6.1.1.143	WmtConfSigPowContTestPack	6-61
6.1.1.144	QryConfSigPowContTestPack	6-61
6.1.1.145	WmtConfSigFreqRangTestPack	6-61
6.1.1.146	QryConfSigFreqRangTestPack	6-62
6.1.1.147	WmtConfSig20dBBwidTestPack	6-62
6.1.1.148	QryConfSig20dBBwidTestPack	6-62
6.1.1.149	WmtConfSigACPTestPack	6-63
6.1.1.150	QryConfSigACPTestPack	6-63
6.1.1.151	WmtConfSigSpurEmisTestPack	6-63
6.1.1.152	QryConfSigSpurEmisTestPack	6-64
6.1.1.153	WmtConfSigCIPerfTestPack	6-64
6.1.1.154	QryConfSigCIPerfTestPack	6-64
6.1.1.155	WmtConfSigBlocPerfTestPack	6-65
6.1.1.156	QryConfSigBlocPerfTestPack	6-65
6.1.1.157	WmtConfSigIModPerfTestPack	6-65
6.1.1.158	QryConfSigIModPerfTestPack	6-66
6.1.2	PROCedure Subsystem - SIG RF	6-67
6.1.2.1	WmtProcSigPowDens	6-67
6.1.2.2	WmtProcSigPowCont	6-67
6.1.2.3	WmtProcSigFreqRang	6-67
6.1.2.4	WmtProcSig20dBBwid	6-68
6.1.2.5	WmtProcSigACP	6-68
6.1.2.6	WmtProcSigSpurEmis	6-69
6.1.2.7	WmtProcSigCIPerf	6-69
6.1.2.8	WmtProcSigBlocPerf	6-70
6.1.2.9	WmtProcSigIModPerf	6-70
6.1.3	FETCh Subsystem - SIG RF	6-71
6.1.3.1	QryFetcSigPowDens	6-71
6.1.3.2	QryFetcSigPowContNumDown	6-71
6.1.3.3	QryFetcSigPowContPavDown	6-72
6.1.3.4	QryFetcSigPowContNumUp	6-72
6.1.3.5	QryFetcSigPowContPavUp	6-73
6.1.3.6	QryFetcSigPowContPavMin	6-73
6.1.3.7	QryFetcSigFreqRangLowFreq	6-74

6.1.3.8	QryFetcSigFreqRangHiFreq	6-74
6.1.3.9	QryFetcSig20dBBwid	6-74
6.1.3.10	QryFetcSigACPMN2Lo	6-75
6.1.3.11	QryFetcSigACPMN2Hi	6-75
6.1.3.12	QryFetcSigACPMN3Lo	6-76
6.1.3.13	QryFetcSigACPMN3Hi	6-76
6.1.3.14	QryFetcSigACPNum	6-77
6.1.3.15	QryFetcSigACPACP	6-77
6.1.3.16	QryFetcSigACPCH	6-78
6.1.3.17	QryFetcSigSpurEmisSele	6-78
6.1.3.18	QryFetcSigSpurEmisFreq	6-79
6.1.3.19	QryFetcSigSpurEmisPow	6-80
6.1.3.20	QryFetcSigSpurEmisFccRefPow	6-81
6.1.3.21	QryFetcSigCIPerfSumErr	6-81
6.1.3.22	QryFetcSigCIPerfCh	6-82
6.1.3.23	QryFetcSigCIPerfBer	6-82
6.1.3.24	QryFetcSigCIPerfPer	6-83
6.1.3.25	QryFetcSigCIPerfSumErrRela	6-83
6.1.3.26	QryFetcSigCIPerfBerRela	6-84
6.1.3.27	QryFetcSigCIPerfPerRela	6-84
6.1.3.28	QryFetcSigBlocPerfSumErr	6-85
6.1.3.29	QryFetcSigBlocPerfFreq	6-85
6.1.3.30	QryFetcSigBlocPerfBer	6-86
6.1.3.31	QryFetcSigBlocPerfPer	6-86
6.1.3.32	QryFetcSigIModPerfN3LoBer	6-87
6.1.3.33	QryFetcSigIModPerfN3HiBer	6-87
6.1.3.34	QryFetcSigIModPerfN3LoPer	6-88
6.1.3.35	QryFetcSigIModPerfN3HiPer	6-88
6.1.3.36	QryFetcSigIModPerfN4LoBer	6-89
6.1.3.37	QryFetcSigIModPerfN4HiBer	6-89
6.1.3.38	QryFetcSigIModPerfN4LoPer	6-90
6.1.3.39	QryFetcSigIModPerfN4HiPer	6-90
6.1.3.40	QryFetcSigIModPerfN5LoBer	6-91
6.1.3.41	QryFetcSigIModPerfN5HiBer	6-91
6.1.3.42	QryFetcSigIModPerfN5LoPer	6-92
6.1.3.43	QryFetcSigIModPerfN5HiPer	6-92
6.1.4	CONFigure Subsystem - Telec	6-93
6.1.4.1	WmtConfTeleFreqTole	6-93
6.1.4.2	QryConfTeleFreqTole	6-93
6.1.4.3	WmtConfTeleOBW	6-94
6.1.4.4	QryConfTeleOBW	6-94
6.1.4.5	WmtConfTeleAntPow	6-94
6.1.4.6	QryConfTeleAntPow	6-95
6.1.4.7	WmtConfTeleSpurEmis	6-95
6.1.4.8	QryConfTeleSpurEmis	6-96
6.1.4.9	WmtConfTeleSecoEmit	6-96
6.1.4.10	QryConfTeleSecoEmit	6-96
6.1.4.11	WmtConfTeleStayTime	6-97
6.1.4.12	QryConfTeleStayTime	6-97
6.1.4.13	WmtConfTeleToleToleUp	6-98
6.1.4.14	QryConfTeleToleToleUp	6-98

Table of Contents

6.1.4.15	WmtConfTeleFreqToleSampNum	6-98
6.1.4.16	QryConfTeleFreqToleSampNum	6-99
6.1.4.17	WmtConfTeleOBWBwidUp	6-99
6.1.4.18	QryConfTeleOBWBwidUp	6-99
6.1.4.19	WmtConfTeleOBWSpreBwidLo	6-100
6.1.4.20	QryConfTeleOBWSpreBwidLo	6-100
6.1.4.21	WmtConfTeleAntPowToleUp	6-100
6.1.4.22	QryConfTeleAntPowToleUp	6-101
6.1.4.23	WmtConfTeleAntPowToleLo	6-101
6.1.4.24	QryConfTeleAntPowToleLo	6-101
6.1.4.25	WmtConfTeleAntPowRefPow	6-102
6.1.4.26	QryConfTeleAntPowRefPow	6-102
6.1.4.27	WmtConfTeleAntPowBursRati	6-102
6.1.4.28	QryConfTeleAntPowBursRati	6-103
6.1.4.29	WmtConfTeleSpurEmisLevUp	6-103
6.1.4.30	QryConfTeleSpurEmisLevUp	6-104
6.1.4.31	WmtConfTeleSecoEmitLevLowUp	6-104
6.1.4.32	QryConfTeleSecoEmitLevLowUp	6-104
6.1.4.33	WmtConfTeleSecoEmitLevUppUp	6-105
6.1.4.34	QryConfTeleSecoEmitLevUppUp	6-105
6.1.4.35	WmtConfTeleStayTimeTimeUp	6-105
6.1.4.36	QryConfTeleStayTimeTimeUp	6-106
6.1.5	PROCedure Subsystem - Telec	6-107
6.1.5.1	WmtProcTeleFreqTole	6-107
6.1.5.2	WmtProcTeleOBW	6-107
6.1.5.3	WmtProcTeleAntPowPow	6-107
6.1.5.4	WmtProcTeleAntPow	6-108
6.1.5.5	WmtProcTeleSpurEmis	6-108
6.1.5.6	WmtProcTeleSecoEmit	6-108
6.1.5.7	WmtProcTeleStayTime	6-109
6.1.5.8	WmtProcTeleAll	6-109
6.1.6	FETCh Subsystem - Telec	6-110
6.1.6.1	QryFetcTeleFreqToleTole	6-110
6.1.6.2	QryFetcTeleFreqToleFreq	6-110
6.1.6.3	QryFetcTeleOBWBwid	6-111
6.1.6.4	QryFetcTeleOBWFreqHi	6-111
6.1.6.5	QryFetcTeleOBWFreqLow	6-111
6.1.6.6	QryFetcTeleOBWSpreBwid	6-112
6.1.6.7	QryFetcTeleOBWSpreBwidHopOff	6-112
6.1.6.8	QryFetcTeleAntPowTole	6-112
6.1.6.9	QryFetcTeleAntPowOutpPow	6-113
6.1.6.10	QryFetcTeleAntPowAntPow	6-113
6.1.6.11	QryFetcTeleSpurEmisLev	6-114
6.1.6.12	QryFetcTeleSpurEmisFreq	6-114
6.1.6.13	QryFetcTeleSecoEmitLevLow	6-115
6.1.6.14	QryFetcTeleSecoEmitLevUpp	6-115
6.1.6.15	QryFetcTeleSecoEmitFreqLow	6-116
6.1.6.16	QryFetcTeleSecoEmitFreqUpp	6-116
6.1.6.17	QryFetcTeleStayTimeTime	6-117
6.1.7	SOURce Subsystem - DC Power Source	6-118
6.1.7.1	WmtSourVsimBattType	6-118

6.1.7.2	QrySourVsimBattType	6-118
6.1.7.3	WmtSourVsimBattTypeStd	6-118
6.1.7.4	QrySourVsimBattTypeStd	6-119
6.1.7.5	WmtSourVsimVoltType	6-119
6.1.7.6	QrySourVsimVoltType	6-119
6.1.7.7	WmtSourVsimVoltNomi	6-120
6.1.7.8	QrySourVsimVoltNomi	6-120
6.1.7.9	WmtSourVsimVoltUp	6-121
6.1.7.10	QrySourVsimVoltUp	6-121
6.1.7.11	WmtSourVsimVoltLo	6-121
6.1.7.12	QrySourVsimVoltLo	6-122
6.1.7.13	WmtSourVsimCurrLim	6-122
6.1.7.14	QrySourVsimCurrLim	6-122
6.1.7.15	WmtSourVsimCurrLimType	6-123
6.1.7.16	QrySourVsimCurrLimType	6-123
6.1.7.17	QrySourVsimCurrStat	6-123
6.1.7.18	WmtOutpVsimStatType	6-124
6.1.7.19	QryOutpVsimStatType	6-124
6.1.7.20	WmtOutpVsimStat	6-124
6.1.7.21	QryOutpVsimStat	6-125
7.	SPECIFICATIONS	7-1
7.1	Transmitter Measurement	7-1
7.2	Receiver Measurement	7-3
7.3	Peripheral Devices	7-6
7.4	Connection with External Unit	7-7
7.5	General Specification	7-7
	APPENDIX	A-1
A.1	Troubleshooting	A-1
A.2	Error Messages	A-2
	ALPHABETICAL INDEX	I-1

LIST OF ILLUSTRATIONS

No.	Title	Page
1-1	Test System Connection Diagram	1-3
1-2	Connection Diagram of DC Output of the 2303 (Rear Side)	1-4
1-3	Sequence of Turning On the Power to Each Device in the System	1-6
1-4	Display on the Screen for the R4870 after Turning on the Power	1-7
2-1	Startup Screen	2-2
2-2	Switching from the Measure Screen to the Setup Screen	2-4
2-3	SIG RF Item Select Screen	2-4
2-4	Switching from SIG RF Measurement to TELEC Measurement	2-5
2-5	Telec Test Screen	2-5
2-6	Telec Item Select Screen	2-6
2-7	SIG Limit Setting (Output Power)	2-7
2-8	Telec Limit Setting (Frequency Tolerance)	2-8
2-9	PRESET Menu	2-10
2-10	Item Selection Screen	2-11
2-11	Channel Setting	2-11
2-12	PASS/FAIL Limit Setting	2-12
2-13	Output Power (Power Control) Conditions Setting	2-13
2-14	Power Density Conditions Setting	2-14
2-15	Power Control Conditions Setting	2-15
2-16	Frequency Range Conditions Setting	2-16
2-17	20 dB Bandwidth Conditions Setting	2-17
2-18	ACP Conditions Setting	2-17
2-19	Spurious Emissions Measurement Frequency Setting	2-19
2-20	C/I Performance	2-21
2-21	Blocking performance Conditions Setting	2-22
2-22	Intermodulation Performance Conditions Setting	2-23
2-23	DC Power Source Setting	2-24
2-24	Display of Information on the Operation Menu and DC Power Supply on the Measurement Screen	2-25
2-25	Display of Information on DC Power Supply (2303 not detected)	2-26
2-26	Display of Information on DC Power Supply (2303 detected)	2-26
2-27	System Configuration Setting	2-27
2-28	SIG Item Select Screen	2-28
2-29	Measurement Start Screen	2-29
2-30	Positions of START and SINGLE Keys	2-29
2-31	Output Power Measuring PASS	2-30
2-32	All Test Items PASS	2-30
2-33	Telec Test Setting	2-31
2-34	Telec Item Select Screen	2-32
2-35	Frequency Tolerance Limit Setting	2-32
2-36	OBW Limit Setting	2-33
2-37	Antenna Power Setting	2-33
2-38	Spurious Emission Limit Setting	2-34
2-39	Staying Time Limit Setting	2-35
2-40	Spurious Emission (Rx) Limit Setting	2-35

List of Illustrations

No.	Title	Page
2-41	Switching from the Setup Mode to the Measure Mode	2-36
2-42	Telec Measurement Screen	2-36
2-43	Screen at the Time of Completion of All TELEC Test Items	2-37
5-1	Shifting to Calibration Setting	5-1
5-2	Shifting to the Calibration Setup Screen	5-2
5-3	Calibration Setup	5-2
5-4	Power Splitter Calibration	5-3
5-5	Message Confirming the Completion of Connection	5-4
5-6	Monitor2 Port Calibration	5-5
5-7	Monitor1 Port Calibration	5-6
5-8	CH1-Input Calibration	5-7
5-9	CH1-Output Calibration	5-8
5-10	Interfere1 Port Calibration	5-9
5-11	Interfere2 Port Calibration	5-10
5-12	Procedures for Performing Continuous Calibration	5-11

LIST OF TABLES

No.	Title	Page
1-1	List of Standard Accessories	1-2
3-1	Bluetooth SIG RF Test Items and Passing Ranges - CH 1	3-33
3-2	Bluetooth SIG RF Test Items and Passing Ranges - CH 2	3-34
3-3	Pass/Fail Evaluation of the Bluetooth SIG RF Test	3-35
7-1	Dirty Transmitter Slot Packets	7-5
A-1	Troubleshooting	A-1
A-2	R4870 OPT01 Error Messages	A-2

1. INTRODUCTION

This chapter provides the following information:

- System Overview
- Accessories
- Connection and Operation Test
- Warm up
- Calibration
- Peripheral Device Option

1.1 System Overview

Because the R4870 has a built-in GPIB controller, the R4870 OPT01 GPIB-Master is able to evaluate the RF performance and communication test performance of products, which conform to Bluetooth™ SIG Core, and evaluate the RF performance of products, which conform to TELEC, while controlling peripheral equipment which measure interference signals and spurious signals.

(For more information on the basic operations and communication tests, refer to R4870 Operation Manual.)

- Main RF (SIG Standards) items
 - Transmitter evaluation
 - Output Power
 - Power Density
 - Power Control
 - TX Output Spectrum- Frequency Range
 - TX Output Spectrum- 20dB Bandwidth
 - TX Output Spectrum- Adjacent Channel Power
 - Modulation Characteristics
 - Initial Carrier Frequency Tolerance
 - Carrier Frequency Drift
 - Out-of-Band Spurious Emissions
 - Receiver evaluation
 - Sensitivity- Single Slot Packets
 - Sensitivity- Multi Slot Packets
 - C/I performance
 - Blocking performance
 - Intermodulation performance
 - Maximum Input Level
- Communication test evaluations
 - Communication test equivalent to the Blue Unit Test Cases
- Main items of RF (TELEC Standards)
 - Frequency deviation
 - Occupied bandwidth and diffused bandwidth
 - Deviation of antenna power

1.2 Accessories

Intensity of spurious emission
 Hopping frequency retention time
 Limit of secondarily generated radio waves, etc.

1.2 Accessories

The table below lists the standard accessories.

Table 1-1 List of Standard Accessories

Name	Model name	Quantity
Power splitter	MODEL1593	1
SMA-SMA through connector	FLA-H-SA3	1
N-SMA connector	HRM-554S	1
SMA-SMA cable (0.7 m)	DGM224-00700A	1
SMA-SMA cable (1 m)	DGM224-01000A	3
BNC-BNC cable	81-001-0101-004	2
GPIB cable	408JE-102	5
R4870 OPT01 Operation Manual	ER4870OPT01	1

1.3 Connection and Operation Test

1.3.1 Connection between System Devices

Connections between system devices are shown in Figure 1-1. For cable numbers, refer to Section 1.3.2, "List of Connections between Devices."

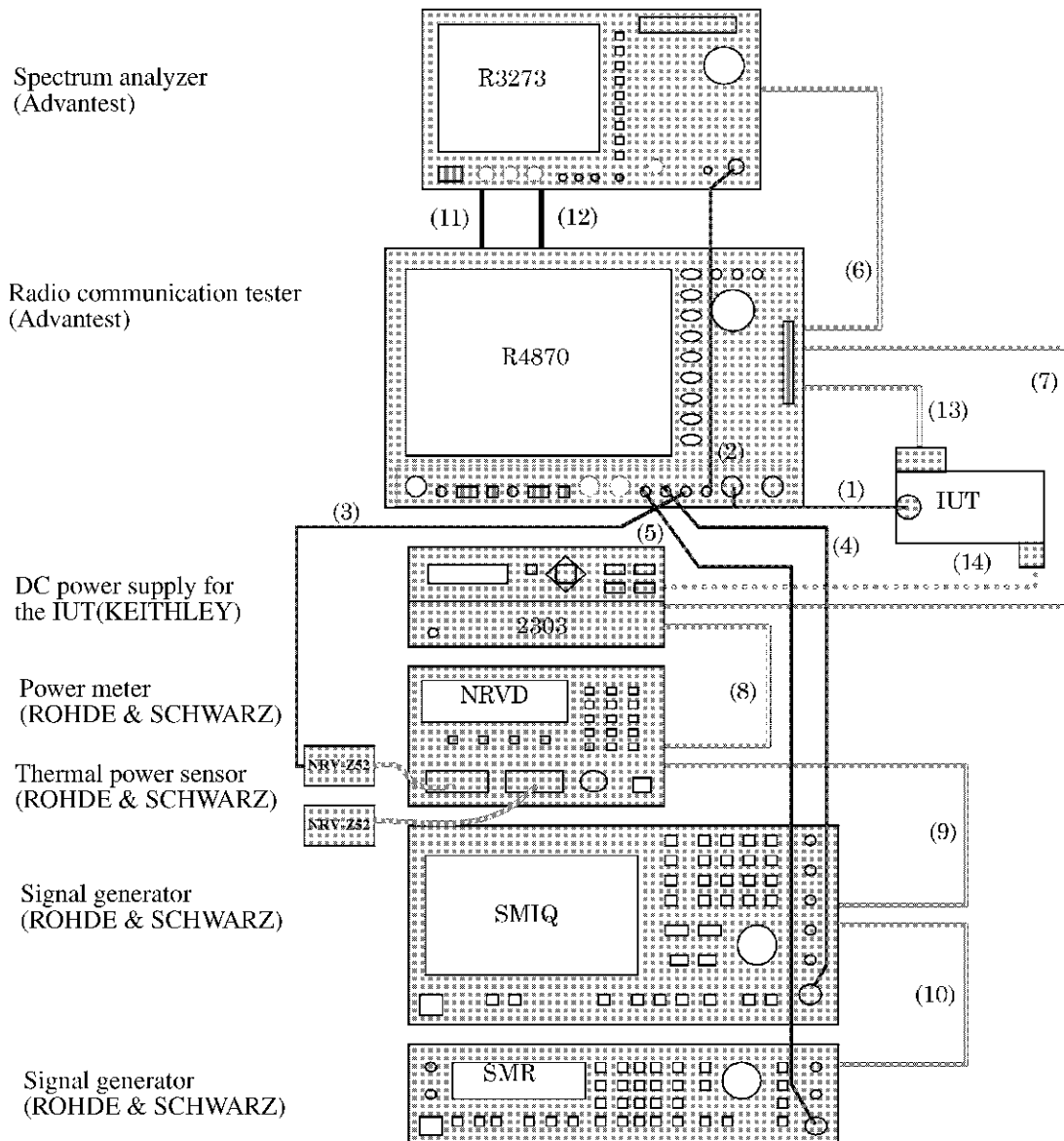

Figure 1-1 Test System Connection Diagram

1.3.2 List of Connections between Devices

1.3.2 List of Connections between Devices

No.				
(1)	R4870 (F) RF IN/OUT 1	↔	IUT	RF PORT
(2)	R4870 (F) MONITOR 2	↔	R3273 (F)	INPUT 50 Ω
(3)	R4870 (F) MONITOR 1	↔	NRV-Z52	
(4)	R4870 (F) INTERFERE 2	↔	SMIQ (F)	RF 50 Ω
(5)	R4870 (F) INTERFERE 1	↔	SMR (F)	RF 50 Ω
(6)	R4870 (R) CONTROLLER	↔	R3273 (R)	GPIB
(7)	R4870 (R) CONTROLLER	↔	2303 (R)	IEEE-488
(8)	2303 (R) IEEE-488	↔	NRVD (R)	IEEE-488
(9)	NRVD (R) IEEE-488	↔	SMIQ (R)	IEEE-488
(10)	SMIQ (R) IEEE-488	↔	SMR (R)	IEEE-488
(11)	R4870 (R) TRIG OUT	↔	R3273 (R)	EXT TRIG
(12)	R4870 (R) 10MHz REF	↔	R3273 (R)	10MHz REF IN
(13)	R4870 (R) RS-232	↔	IUT	HCI PORT
(14)	2303 (R) OUTPUT	↔	IUT	DC POWER PORT

*1: Numbers correspond to those in Figure 1-1.

*2: (F) means the front side of the device and (R) means the rear side of the device.

1.3.2.1 Connection of 2303 Power Supply Output Cable

The diagram below shows the connection of output terminals of DC power supply (2303) for the IUT.
(For more information, refer to 2303 Operation Manual.)

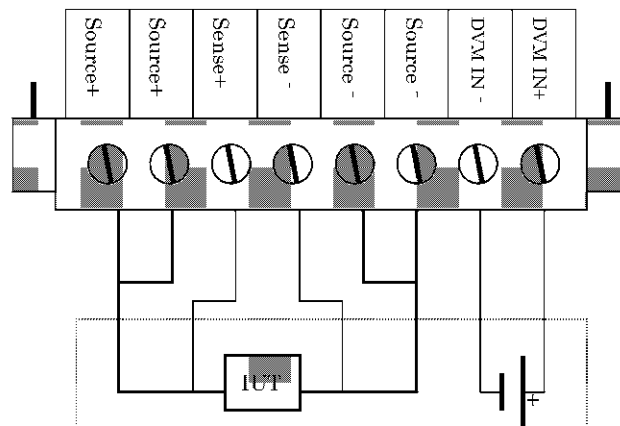

Figure 1-2 Connection Diagram of DC Output of the 2303 (Rear Side)

1.3.3 Connection Cable Options

<u>No.</u>	<u>Type of Cable</u>	<u>Required bandwidth</u>
(1)	SMA-SMA cable	30 MHz to 25 GHz
(2)	SMA-SMA cable	30 MHz to 25 GHz
(3)	SMA-SMA cable	2.4 GHz to 2.5 GHz
(4)	SMA-SMA cable	2.4 GHz to 2.5 GHz
(5)	SMA-SMA cable	30 MHz to 13 GHz
(6)	GPIB cable	
(7)	GPIB cable	
(8)	GPIB cable	
(9)	GPIB cable	
(10)	GPIB cable	
(11)	BNC-BNC cable	DC to 10 MHz
(12)	BNC-BNC cable	10 MHz
(13)	RS-232 cable	DSUB 9 pin
(14)	Power cable for the IUT	

*1: Numbers correspond to those in Figure 1-1.

1.3.4 Procedures for Turning on Power

1. Turn on the power to the R3273, 2303, NRVD, SMIQ and SMR. (Refer to STEP 1 in Figure 1-3.)
Set values to the GPIB address for each device are as follows:

<u>Instrument</u>	<u>GPIB address</u>
R3273	8
2303	16
NRVD	20
SMIQ	28
SMR	29

2. Turn on the power to the R4870 after the operation of the device in Step 1 is complete. (Refer to STEP 2 in Figure 1-3.)

NOTE: Because the R3273 and the SMIQ also have a switch on the rear side, turn on the switch in advance.

1.3.4 Procedures for Turning on Power

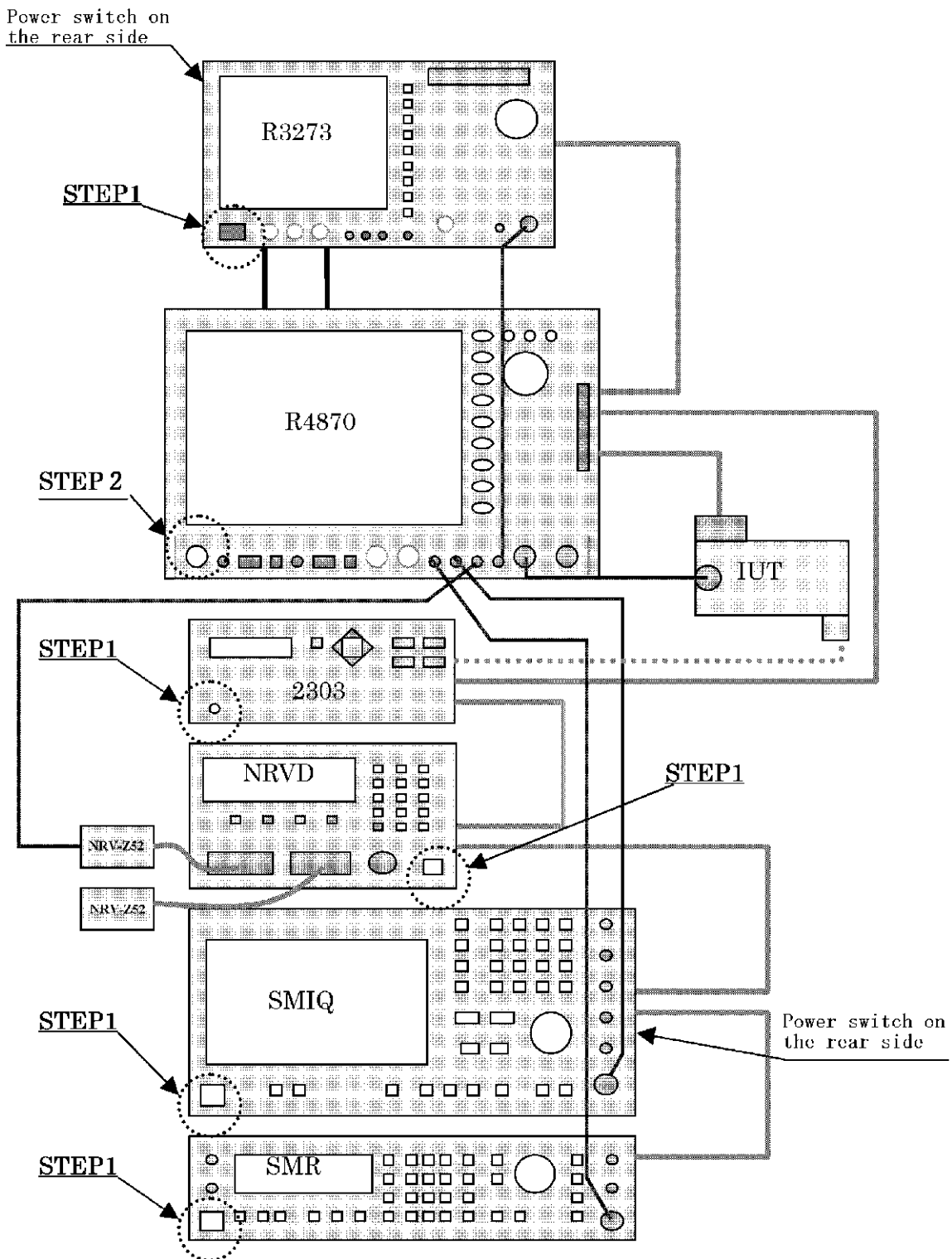

Figure 1-3 Sequence of Turning On the Power to Each Device in the System

2. OPERATIONS

This chapter provides the following information:

- Basic Operation
- Standards Compliance Test Items and Settings
- Setting Procedures before Measurement
- Measurement Execution Method
- Method to Identify Malfunctioning

NOTE: For more information on the operations of the R4870 and each device in the system, refer to the *Operation Manual for each device*.

2.1 Basic Operation

The basic operations of the R4870 OPT01 GPIB-Master measuring system are described below.

2.1.1 Turning on Power

1. Make sure that the power switch of each device is OFF.
2. Connect the provided power cable to the AC power supply connector on the rear panel.
3. Plug the power cable into the electrical outlet.
4. Check the connection between the R4870 and each device in accordance with Figure 1-1.
5. First turn ON the power to each peripheral devices.
6. After making sure that the peripheral devices have started, turn ON the R4870 power.
If the initial test is completed normally, the startup screen shown in Figure 2-1 is displayed.

2.2 Standards Compliance Test Items and Settings

RF measurement tests (excluding the Communication Test) are described here.

2.2.1 RF Test Items

This system performs RF tests in accordance with the SIG and the TELEC.

SIG RF test item	Output Power
	Power Density
	Power Control
	Frequency Range
	20dB Bandwidth
	Adjacent Channel Power
	Modulation Characteristics
	Frequency Tolerance
	Frequency Drift
	Out of Band Spurious Emissions
	Sensitivity Single Slot Packets
	Sensitivity Multi Slot Packets
	C/I performance
	Blocking performance
	Intermodulation performance
	Maximum Input Level
	TELEC RF test item:
	OBW/Spread BW
	Antenna Power
	Spurious Emission (TX)
	Staying Time
	Spurious Emission (RX)

2.2.2 Items for Measurement Settings

2.2.2 Items for Measurement Settings

2.2.2.1 SIG Measurement Setting

Click **Mode** on the main menu of the SIG RF measurement screen and select **Setup** from the drop down menu.

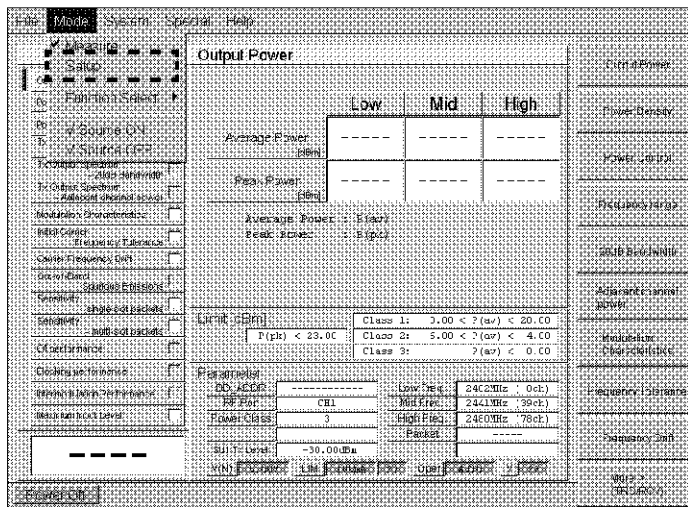

Figure 2-2 Switching from the Measure Screen to the Setup Screen

By using the operation described above, the screen switches to the SIG Item Select screen.

If the checkbox for the item to be tested is selected, a checkmark appears.

The following are possible for selected test items: the selection of a Low, Mid or High measurement channel, the selection of SIG-compliant measurements or high-speed measurements.

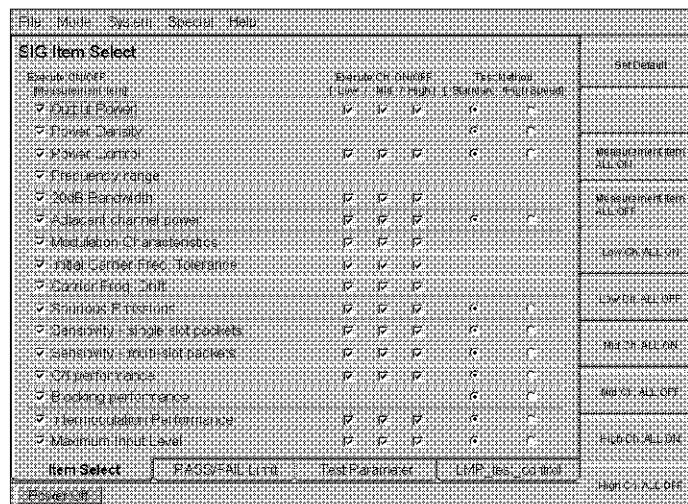

Figure 2-3 SIG RF Item Select Screen

2.2.2 Items for Measurement Settings

File Mode System Special Help		
Telec Item Select		Default
PRECISION	PRECISION	
INDICATOR	LEVEL	
<input checked="" type="checkbox"/> Frequency Tolerance	<input checked="" type="checkbox"/> <input checked="" type="checkbox"/> <input checked="" type="checkbox"/>	Measurement ALL ON
<input checked="" type="checkbox"/> ODW Spread EMI		Measurement ALL OFF
<input checked="" type="checkbox"/> Antenna Power		Measurement ALL OFF
<input checked="" type="checkbox"/> Spurious Emission Tol.	<input checked="" type="checkbox"/> <input checked="" type="checkbox"/> <input checked="" type="checkbox"/>	Measurement ALL OFF
<input checked="" type="checkbox"/> Steady State	<input checked="" type="checkbox"/> <input checked="" type="checkbox"/> <input checked="" type="checkbox"/>	Measurement ALL OFF
<input checked="" type="checkbox"/> Spurious Emission Pwr		Measurement ALL ON
Item Select	PASS FAIL Limit	Measurement ALL OFF
Power Off		

Figure 2-6 Telec Item Select Screen

2.2.3 Setting Pass and Fail Limits

2.2.3.1 SIG RF Settings

If the **PASS/FAIL Limit** tab on the SIG RF measurement screen is clicked, the SIG Limit Parameter screen is displayed.

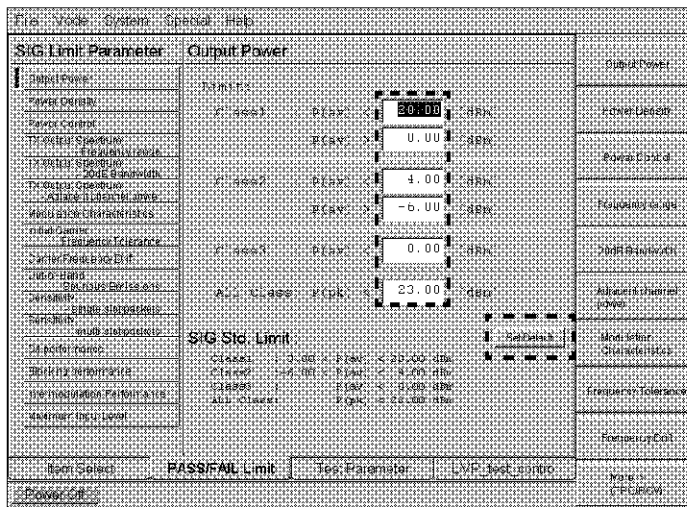

Figure 2-7 SIG Limit Setting (Output Power)

The SIG default value is displayed in the text box on the screen shown in Figure 2-7. The default value can be changed.

In addition, if **Set Default** is clicked, the values in text boxes return to default values.

2.2.3 Setting Pass and Fail Limits

2.2.3.2 TELEC RF Settings

If the **PASS/FAIL Limit** tab is clicked on the Telec measurement screen, the Telec Limit Parameter screen is displayed.

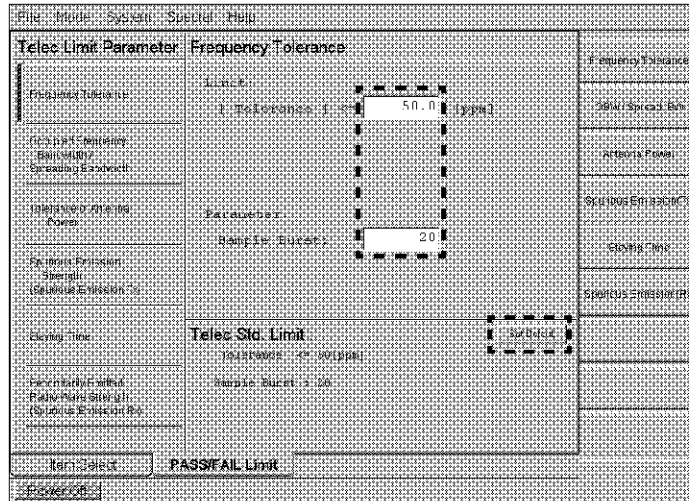

Figure 2-8 Telec Limit Setting (Frequency Tolerance)

The Telec default value is displayed in the text box on the screen shown in Figure 2-8. The default value can be changed.

In addition, if **Set Default** is clicked, the values in text boxes return to default values.

2.3 Setting Procedures before Measurement

Various settings of the Test System and the RF testing methods for SIG and TELECOM are described here.

2.3.1 IUT Connection

The IUT is connected as shown in Figure 1-3.

Connect the RS-232 cable, the RF cable from the R4870, and the power cable from the 2303 (DC power supply for IUT) to the IUT.

The RF cable, for which the transmission loss is calibrated, must be used to avoid including any errors in the measurement results.

Calibrate the cable to reduce cable loss in accordance with the system calibration procedure.

To connect RF cables to the IUT and R3273, use cables that allow measurement in the range of 30 MHz to 25 GHz.

2.3.2 Procedures for Turning on Power

When starting the system, turn ON the power to all peripheral devices. After all peripheral devices have started, turn on the R4870 power.

2.3.3 Recognition of Peripheral Devices

- R4870 recognizes peripheral devices when the system starts up.
If no peripheral devices respond, the R4870 assumes that no peripheral devices are connected, and an error is returned if a measurement is performed.
- If there is any error in the order of startup of power, the R4870 recognizes the peripheral devices by using the R4870 PRESET operation.
- The PRESET operation can be performed by using the **PRESET** button in the entry key block on the R4870 front panel. If the right mouse button is pressed and held down and, then the left button is pressed, the PRESET icon, which is shown in Figure 2-9, is displayed.

Then, if **Hard Reset** is clicked, any devices connected to the R4870 are recognized.

2.3.4 Measurement-Related Settings

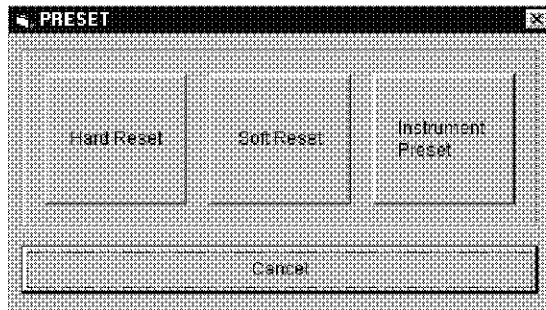

Figure 2-9 PRESET Menu

The buttons in the PRESET window are as follows:

- | | |
|----------------------|---|
| 1. Hard Reset | Recognizes peripheral devices. |
| 2. Soft Reset | Recognizes peripheral devices. |
| 3. Instrument Preset | Recognizes and resets peripheral devices. |

2.3.4 Measurement-Related Settings

Set each measurement item before starting measurement.

(This item may be omitted if changing the settings is unnecessary.)

Settings are described in the following order:

1. SIG Item Select
2. PASS/FAIL Limit
3. Test Parameter
4. LMP_test_control
5. System Setup

2.3.4.1 SIG Item Select

The following three types of items: each measurement item, measurement channel and measurement speed, can be selected here.

For example, the checkbox settings for selecting the Mid channel and the SIG standards method in Adjacent channel power are as shown in the dotted line frame in Figure 2-10.

2.3.4 Measurement-Related Settings

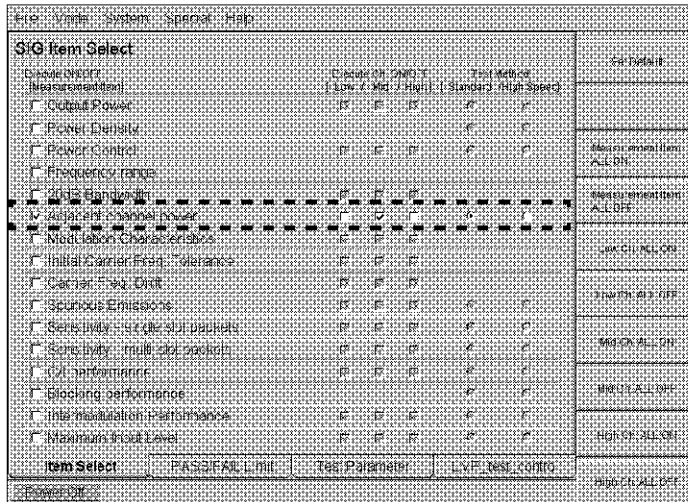

Figure 2-10 Item Selection Screen

Low, mid and high settings for the measurement channel can be changed in box 2 after **System Setup**, shown in 1 in Figure 2-11, is selected.

For more information on settings, refer to Section 2.4.3, "Setting System Configuration" in R4870 Operation Manual.

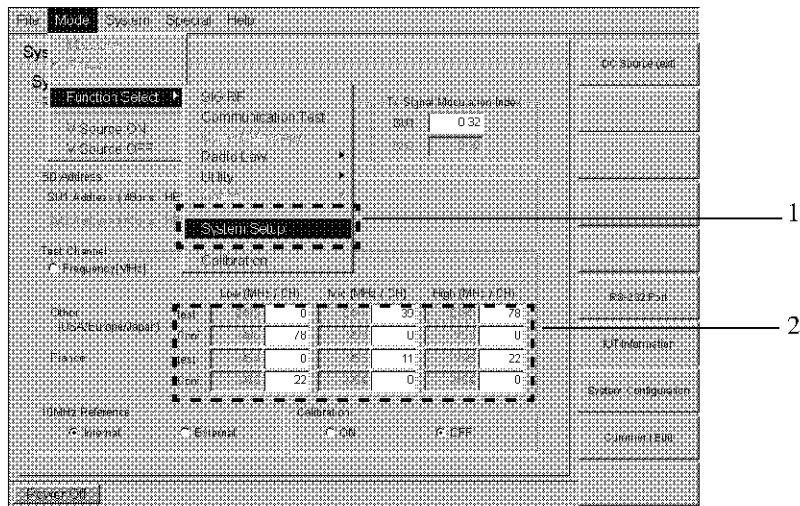

Figure 2-11 Channel Setting

2.3.4 Measurement-Related Settings

2.3.4.2 PASS/FAIL Limit

The values for the PASS/FAIL Limit for each measurement item can be changed, if necessary.

The Limit Value setting screen is shown in Figure 2-12, by using “TX Output Spectrum-Adjacent channel power” as an example.

Area 1, which is surrounded by a dotted line, is the box used for entering the limit value, which can be changed as desired. With respect to other measurement items also, the limit value can be changed by switching the screen by selecting the test item to be changed from the side menu 2.

(Although the display format maybe slightly different depending on the measurement item, the limit values of all test items can be changed.)

For more information on the setting input range, refer to Section 3.4, “Bluetooth SIG RF Test Items and Passing Ranges” in this manual.

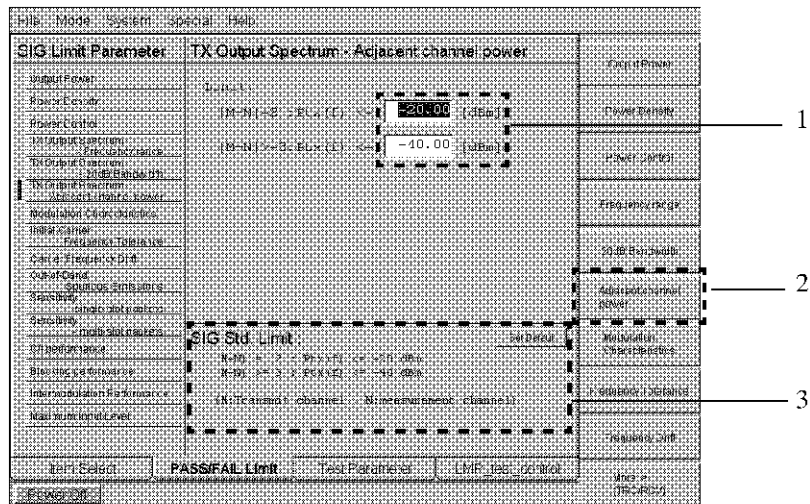

Figure 2-12 PASS/FAIL Limit Setting

To return the limit value to the SIG default value, click **Set Default** in area 3, which is surrounded by a dotted line.

2.3.4.3 Test Parameter

The set parameter can be changed in the SIG RF measurement test.

2.3.4.3.1 Output Power (Power Control): Power Range

- Start point The start point of the average power measurement for burst waves
Setting range: 0 to [Stop Point - 1]% (Default value: 20%)
- Stop point The stop point of the average power measurement for burst waves
Setting range: [Start Point + 1] to 100% (Default value: 80%)
- Leading and trading point
If PO cannot be detected, a level, which is x dB lower than the peak level of the burst wave, is used as the reference point.
Setting range: 0 to 40 dB (Default value: 10 dB)

NOTE: If the leading and trading point is set to 0 dB, a point the same as the peak level may be judged as the reference point. Set a value greater than 0 dB.

- Average Count Average counts
Setting range: 1 to 999 times (Default value: 20 times)

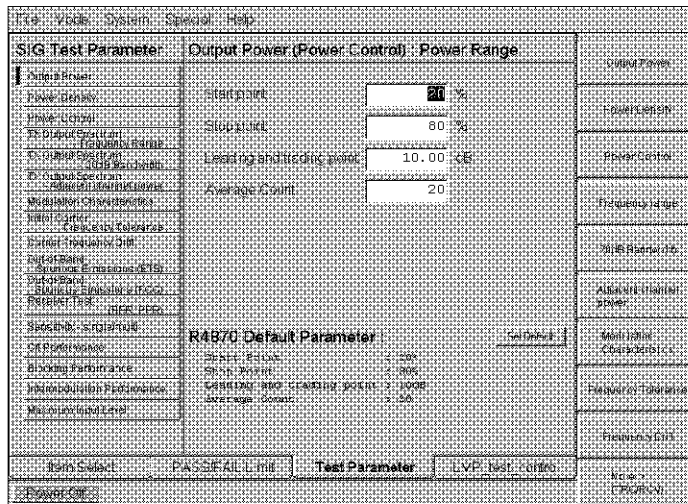

Figure 2-13 Output Power (Power Control) Conditions Setting

2.3.4 Measurement-Related Settings

2.3.4.3.2 Power Density: Sweep Time

- Standard
 - Peak Frequency Sets the sweep speed in kHz/sec over a SPAN of 240 MHz.
Setting range: 100 to 10000 kHz (Default value: 100 kHz)
 - Peak Power Sets the sweep time of the peak power measurement (SPAN ZERO).
Setting range: 1 to 1000 seconds (Default value: 60 sec)
- High Speed
 - Peak Frequency Sets the sweep speed in kHz/sec over a SPAN of 100 MHz.
Setting range: 100 to 10000 kHz (Default value: 100 kHz)
 - Peak Power Sets the sweep time of the peak power measurement (SPAN ZERO).
Setting range: 1 to 1000 seconds (Default value: 2 sec)

NOTE: For certain High Speed settings, the measurement speed is either the same as, or slower than, the standard value. In setting High Speed, it is recommended to set the measurement parameter to default.

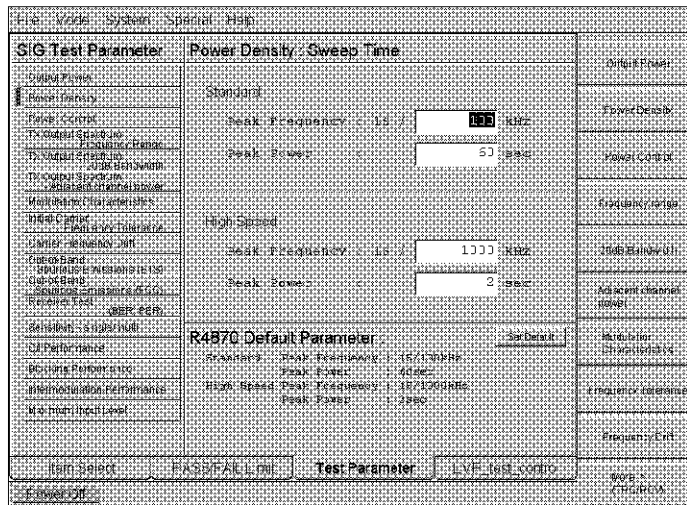

Figure 2-14 Power Density Conditions Setting

2.3.4.3.3 Power Control: Minimum Power

- **Step number** Specifies the number of times the measurement is performed, if the IUT output power does not reach the minimum level.
Setting range: 1 to 15 times (Default value: 15 times)
- **Minimum Level** Specifies the minimum power of the IUT output power switching width measurement.
Standard Measurements performed by the external spectrum analyzer
Setting range: -50 to +25 dBm (Default value: -30 dBm)
High Speed Measurements performed by the R4870 built-in power sensor
Setting range: -15 to +25 dBm (Default value: -10 dBm)
- **Wait time out** Specifies the delay time, which is set for the measurement start timing of the spectrum analyzer, if there is any delay in the IUT output level switching in the Standard measurement. (Default value: 0 msec).
- **Judgement** Selects the power control method.
Step number Performs the number of measurements specified in Step number and judges the result.
(Stops the test when the number reaches the specified Step number.)
Minimum Level Makes judgment when the set minimum level is reached.
(The judgment is independent of the specified Step number.)

NOTE: There are two types of Power Control measurements, standard measurement, which is performed by an external spectrum analyzer, and high-speed measurement, which is performed by the R4870 built-in power sensor. The Class 3 IUT measurement is difficult to be performed at high-speed because the measuring sensitivity of the built-in power sensor is low. When measurements over a range of -15 dBm or lower are required, select Standard measurement.

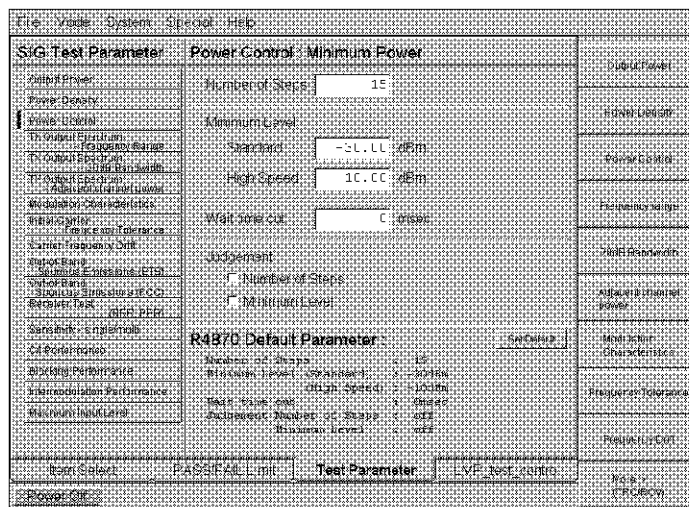

Figure 2-15 Power Control Conditions Setting

2.3.4.3.5 20 dB Bandwidth: Bandwidth Level

- **Bandwidth Level** Sets the bandwidth measuring point by specifying how many dB lower than the peak power, the power of the measuring point should be.
Setting range: 0 to 60 dB (Default value: 20 dB)

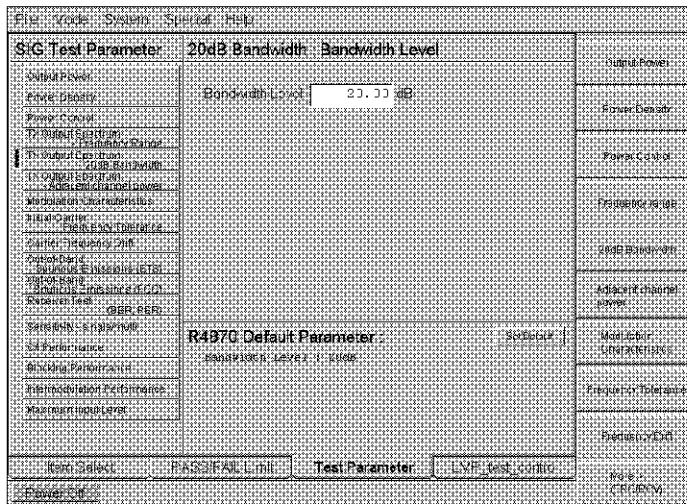

Figure 2-17 20 dB Bandwidth Conditions Setting

2.3.4.3.6 ACP: Number of Adjacent Channel

- **Number of Adjacent Channel**
Sets the measurement channel range.
Setting range: 2 to 75 (Default value: 75)

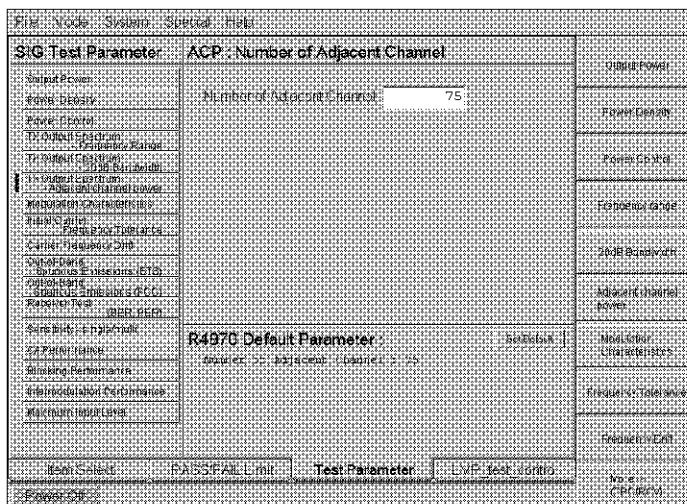

Figure 2-18 ACP Conditions Setting

2.3.4 Measurement-Related Settings

2.3.4.3.7 Modulation Characteristics: Sample Packet

Modulation Characteristics test parameters can be set.

For more information on these settings, refer to Section 2.4.5.1, “Modulation Characteristics” of R4870 Operation Manual.

2.3.4.3.8 Frequency Tolerance: Sample Packet,etc.../ Frequency Drift: Sample Packet,etc...

Initial Carrier Frequency Tolerance and Carrier Frequency Drift test parameters can be set.

For more information on these settings, refer to Section 2.4.5.2, “Initial Carrier Frequency Tolerance and Carrier Frequency Drift” of R4870 Operation Manual.

2.3.4 Measurement-Related Settings

2.3.4.3.10 Receiver Test: (BER,PER)

Parameters, which are used for the receiver performance test for an IUT, can be set.

For more information on this setting, refer to Section 2.4.5.3, “Receiver Test (BER, PER)” of R4870 Operation Manual.

2.3.4.3.11 Sensitivity - single/multi: Dirty ON/OFF, TX Level

Sensitivity-single slot packets and Sensitivity-multi-slot packets test parameters can be set.

For more information on these settings, refer to Section 2.4.5.4, “Sensitivity - single/multi” of R4870 Operation Manual.

2.3.4.3.12 C/I Performance: Image Frequency

When communicating the status of the IUT, the BER/PER characteristics of the IUT are evaluated by giving an interfering signal to the communication channel or an adjacent channel.

- **Image Frequency** Sets the image frequency that the IUT has in the band.
Setting range: 2402 MHz to 2480 MHz (Image frequencies of 1 to 3 types)
- **Interfering Level** Sets the interfering signal level to the IUT.
Normal Basic interference wave level
Relaxed Executed if the BER does not meet the required value of 2 MHz or more in Normal.
- **Wanted Level** Sets the communication signal level to be sent from this unit to the IUT.
Each setting range can be set within the range of the standard value ± 10 dB.

The setting ranges for Interfering and Wanted signal levels are shown below.

Interfering Freq.	Interfering [dBm]		Wanted [dBm]
	Normal	Relaxed	
Co-channel	-81 ~ -71 ~ -61	-----	-70 ~ -60 ~ -50
1 MHz	-70 ~ -60 ~ -50	-----	-70 ~ -60 ~ -50
2 MHz	-40 ~ -30 ~ -20	-53 ~ -43 ~ -33	-70 ~ -60 ~ -50
≥ 3 MHz	-37 ~ -27 ~ -17	-60 ~ -50 ~ -40	-77 ~ -67 ~ -57
Image	-68 ~ -58 ~ -48	-60 ~ -50 ~ -40	-77 ~ -67 ~ -57
Image ± 1 MHz	-57 ~ -47 ~ -37	-60 ~ -50 ~ -40	-77 ~ -67 ~ -57

Note: Descriptions in the table show the minimum output ~ default output ~ maximum output.

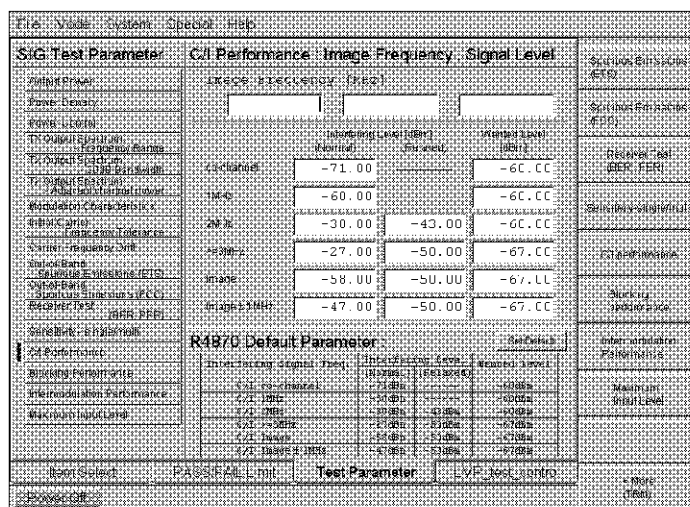

Figure 2-20 C/I Performance

2.3.4 Measurement-Related Settings

2.3.4.3.13 Blocking performance: Signal Level

When communicating the status of the IUT, the BER/PER characteristics of the IUT are evaluated by giving an interfering signal in and out of the receiving range (30 MHz to 12.75 GHz).

- Wanted Signal Level
Communication signal level which is sent from this unit to the IUT
Setting range: -93 to -13 dBm (Default value: -67 dBm)
- Interfering Signal Freq.
Interfering signal by the CW signal to the band of 30 MHz to 12.75 GHz excluding the communication band (2.4 GHz to 2.5 GHz)

Each setting range is as shown below.

Interfering Freq.	Level1 [dBm]	Level2 [dBm]	Level3 [dBm]
30 MHz ~ 2000 MHz	-60 ~ -8 ~ -5	-60 ~ -10 ~ -5	-60 ~ -50 ~ -5
2000 MHz ~ 2400 MHz	-60 ~ -25 ~ -5	-60 ~ -27 ~ -5	-60 ~ -50 ~ -5
2500 MHz ~ 3000 MHz	-60 ~ -25 ~ -5	-60 ~ -27 ~ -5	-60 ~ -50 ~ -5
3000 MHz ~ 12.75 GHz	-60 ~ -8 ~ -5	-60 ~ -10 ~ -5	-60 ~ -50 ~ -5

Note: Descriptions in the table show the minimum output ~ default output ~ maximum output.

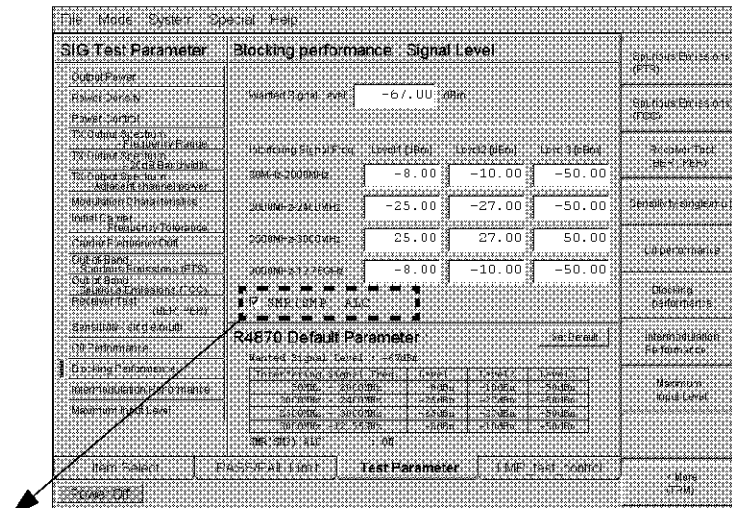

Figure 2-21 Blocking performance Conditions Setting

NOTE: The noise of the interference signal source may affect the Blocking characteristics depending on the performance of the device. If the characteristics are affected, set the ALC of SMR(SMP) interference signal source to OFF.

2.3.4 Measurement-Related Settings

2.3.4.5 System Setup

2.3.4.5.1 DC Power Source

The output voltage setting, limited current setting, etc. for 2303 are performed here.

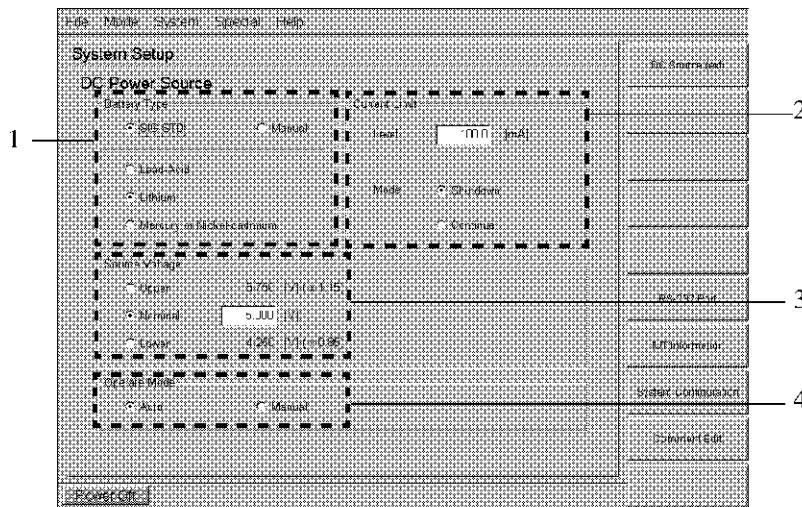

Figure 2-23 DC Power Source Setting

The meaning of each setting is as follows:

1. Battery Type

- **SIG STD** Multiplying values for the upper and lower limits of the SIG Standards are set automatically according to the battery type.

Battery type	Upper	Lower
Lead-Acid	× 1.3	× 0.9
Lithium	× 1.15	× 0.85
Mercury or Nickel-cadmium	× 1.15	× 0.9

- **Manual** Settings of the upper and lower limit values can be set as desired.
Output range : 0 to 15 V
Setting resolution : 1 mV

2. Current Limit

- **Level** Limits the maximum current to the IUT.
10 mA to 1500 mA (0.1 mA resolution)
- **Mode** Sets the method to control output when the current exceeds the limit.
 - Shutdown** Turns OFF the output.
(Even if the IUT current is lower than the limit, the output does not automatically return to ON. To clear the Shutdown mode, select **V Source OFF** in **Mode**.)
 - Continue** Continues to output at the limited current value.

3. Source Voltage

Inputs the set value for the output voltage.

The range of possible output is 0 to 15 V for all.

- Upper
- Nominal
- Lower

However, the voltage that can be output is specified according to the battery type in Item (1). (Performs the test by using the set voltage specified by the option button.)

When SIG STD is set in (1): Only the nominal voltage can be input.

When Manual is set in (1): Each Nominal, Lower and Upper setting can be set.

4. Operate Mode

Determines the method to supply DC power to the IUT.

- Auto Turns the DC output ON and OFF automatically according to the start or end of measurement.
- Manual Turns the output ON and OFF arbitrarily (Refer to 1 in Figure 2-24.)
Select **V Source ON** or **V Source OFF** by using **Mode**.

NOTE: Ensure to set ON or OFF correctly when testing.

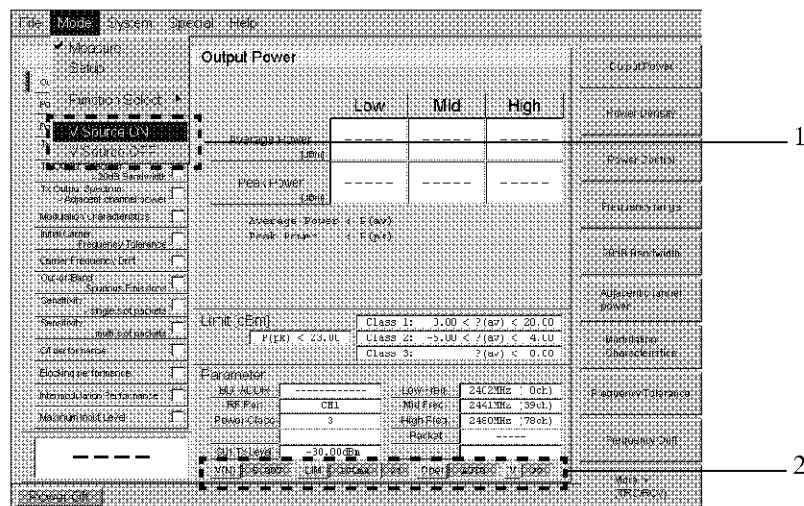

Figure 2-24 Display of Information on the Operation Menu and DC Power Supply on the Measurement Screen

Information on the DC power supply and output, etc. settings are displayed in frame 2 shown in Figure 2-24. If 2303 cannot be detected, the display in the box changes to gray and the DC power supply setting function is unavailable (Refer to Figure 2-25).

2.3.4 Measurement-Related Settings

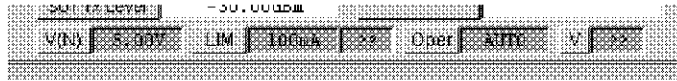

Figure 2-25 Display of Information on DC Power Supply (2303 not detected)

Information to be displayed is as follows:

- V(N): Outputs the Normal setting voltage.
- V(U): Outputs the Upper setting voltage.
- V(L): Outputs the Lower setting voltage.
- LIM: Displays Limit to current + status.
- ACT: Current restriction is active.
- : Current restriction is not active.

NOTE: *If no measurement or operation from the touch screen is performed, the latest information on the status is not displayed.
However, 2303 restricts (shuts off) the output automatically if any irregularity exists when loading the IUT.*

- Oper: Power supply controlling method
 - AUTO: Turned ON when measurement starts/ Turned OFF when measurement ends.
 - MANUAL:
 - Only in manual operation ON or OFF
- V: Displays the status of the DC power output.
 - ON: Outputting DC voltage
 - OFF: Not outputting DC voltage

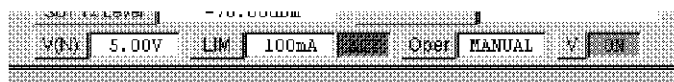

Figure 2-26 Display of Information on DC Power Supply (2303 detected)

The status when 2303 is in operation is shown in Figure 2-26.

The displayed status indicates that the Normal set voltage of 5.00 V is output by manual operation and that the current restriction of 100 mA is applied.

2.3.4.5.2 Setting RS-232 (HCI)

The Baud Rate, Parity Bit, and Stop Bits can be set for the RS-232.

For more information on these settings, refer to Section 2.4.1, “Setting the RS-232 (for the HCI Control)” of R4870 Operation Manual.

2.3.4.5.3 Setting IUT Information

Perform setting that matches the IUT by using **IUT Information** on the side menu.

For more information on these settings, refer to Section 2.4.2, “Setting IUT Information” of R4870 Operation Manual.

2.3.4.5.4 Setting System Configuration

The settings for tests in the R4870 can be specified.

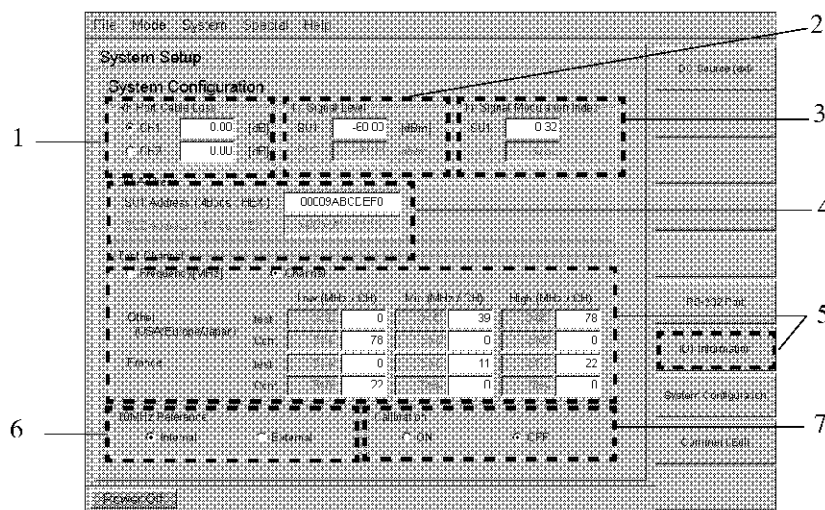

Figure 2-27 System Configuration Setting

For more information on settings 1 to 6, refer to Section 2.4.3, “Setting System Configuration” of R4870 Operation Manual.

7. Calibration

Sets the calibration data of the test system shown in Figure 1-1 to ON or OFF.

ON: Applies the calibration data of all paths in the test system.

OFF: Applies only the data adjusted at the time of shipment.

NOTE: The Calibration data is not included when the test system is shipped. To use the Calibration data, perform the Calibration described in Section 5.1, “Calibration Setting Procedure.”

2.3.4.5.5 Setting Comment Edit

The IUT information can be saved with the test results in the floppy disk and the hard disk.

For more information, refer to Section 2.4.4, “Setting Comment Edit” of R4870 Operation Manual.

2.4 Measurement Execution Method

2.4 Measurement Execution Method

Measurement procedures are described here by showing an actual example of measurement.

2.4.1 SIG RF Test

In the example shown in Figure 2-28, only the following items are measured:

- Output Power (Mid Channel)
- Power Density
- Power Control (Mid Channel)

SIG Item Select				SP Default	
Execution Item	Execution Method		Test Method		
	Low	Mid	High	Standard	
<input type="checkbox"/> Output Power	<input checked="" type="checkbox"/>	<input checked="" type="checkbox"/>	<input type="checkbox"/>	<input type="checkbox"/>	
<input type="checkbox"/> Power Density	<input type="checkbox"/>	<input checked="" type="checkbox"/>	<input type="checkbox"/>	<input type="checkbox"/>	
<input type="checkbox"/> Power Control	<input type="checkbox"/>	<input checked="" type="checkbox"/>	<input type="checkbox"/>	<input type="checkbox"/>	Measurement Item ALL OFF
<input type="checkbox"/> Frequency range	<input type="checkbox"/>	<input type="checkbox"/>	<input type="checkbox"/>	<input type="checkbox"/>	Measurement Item ALL OFF
<input type="checkbox"/> 30dB Bandwidth	<input type="checkbox"/>	<input type="checkbox"/>	<input type="checkbox"/>	<input type="checkbox"/>	Measurement Item ALL OFF
<input type="checkbox"/> Adjacent Channel Power	<input type="checkbox"/>	<input type="checkbox"/>	<input type="checkbox"/>	<input type="checkbox"/>	Measurement Item ALL OFF
<input type="checkbox"/> Modulation Characteristics	<input type="checkbox"/>	<input type="checkbox"/>	<input type="checkbox"/>	<input type="checkbox"/>	Measurement Item ALL OFF
<input type="checkbox"/> Initial Carrier Frequency Tolerance	<input type="checkbox"/>	<input type="checkbox"/>	<input type="checkbox"/>	<input type="checkbox"/>	Measurement Item ALL OFF
<input type="checkbox"/> Carrier Frequency Offset	<input type="checkbox"/>	<input type="checkbox"/>	<input type="checkbox"/>	<input type="checkbox"/>	Measurement Item ALL OFF
<input type="checkbox"/> Spurious Emissions	<input type="checkbox"/>	<input type="checkbox"/>	<input type="checkbox"/>	<input type="checkbox"/>	Measurement Item ALL OFF
<input type="checkbox"/> Sensitivity - single slot packets	<input type="checkbox"/>	<input type="checkbox"/>	<input type="checkbox"/>	<input type="checkbox"/>	Measurement Item ALL OFF
<input type="checkbox"/> Sensitivity - multi-slot packets	<input type="checkbox"/>	<input type="checkbox"/>	<input type="checkbox"/>	<input type="checkbox"/>	Measurement Item ALL OFF
<input type="checkbox"/> Call performance	<input type="checkbox"/>	<input type="checkbox"/>	<input type="checkbox"/>	<input type="checkbox"/>	Measurement Item ALL OFF
<input type="checkbox"/> Blocking performance	<input type="checkbox"/>	<input type="checkbox"/>	<input type="checkbox"/>	<input type="checkbox"/>	Measurement Item ALL OFF
<input type="checkbox"/> Inter-Modulation Performance	<input type="checkbox"/>	<input type="checkbox"/>	<input type="checkbox"/>	<input type="checkbox"/>	Measurement Item ALL OFF
<input type="checkbox"/> Maximum Input Level	<input type="checkbox"/>	<input type="checkbox"/>	<input type="checkbox"/>	<input type="checkbox"/>	Measurement Item ALL OFF
Item Select	PASS/FAIL Limit	Test Parameter	LYP test method		Measurement Item ALL OFF

Figure 2-28 SIG Item Select Screen

The RF test items are displayed on the SIG RF measurement screen after the settings of items and other parameters are complete (Refer to Figure 2-29).

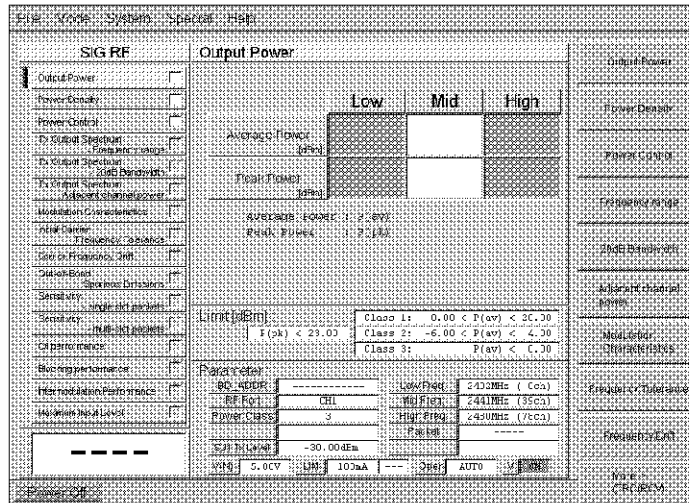

Figure 2-29 Measurement Start Screen

Before starting measurement, check the IUT power supply, RF cable connection and the connection of the RS-232 cable to the HCI, and then press either **SINGLE** or **START** to start R4870 measurement.

In this case, there are two types of measurement execution.

SINGLE: Measures only one selected item.

START: Executes all items selected as measurement items.

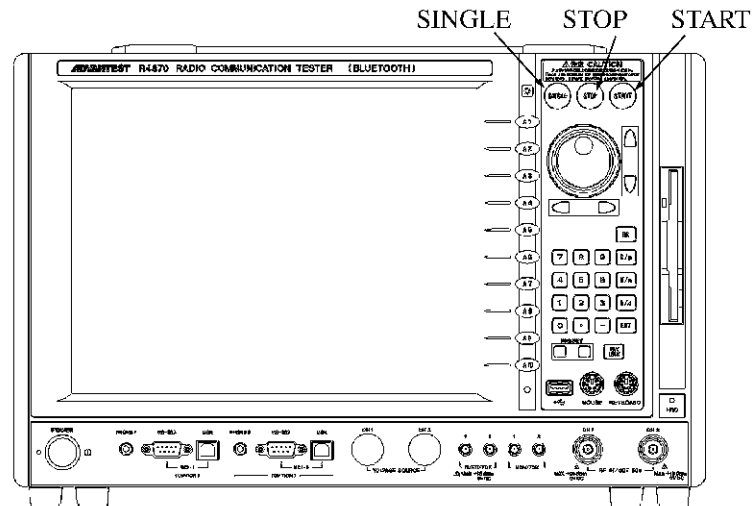

Figure 2-30 Positions of START and SINGLE Keys

To interrupt measurement, press **STOP**.

While the measurement progresses, the measurement results are displayed in the center and the results are indicated on the test item indicator on the left-hand side.

2.4.1 SIG RF Test

The colors displayed on the indicator are defined as follows:

Green: PASS

Red: FAIL

Figure 2-31 shows the status in which the Output Power measurement is complete and the measurement result was pass. In a SINGLE measurement, measurement is complete at this point, but if **START** is pressed, measurement continues in the order of Power Density and then Power Control.

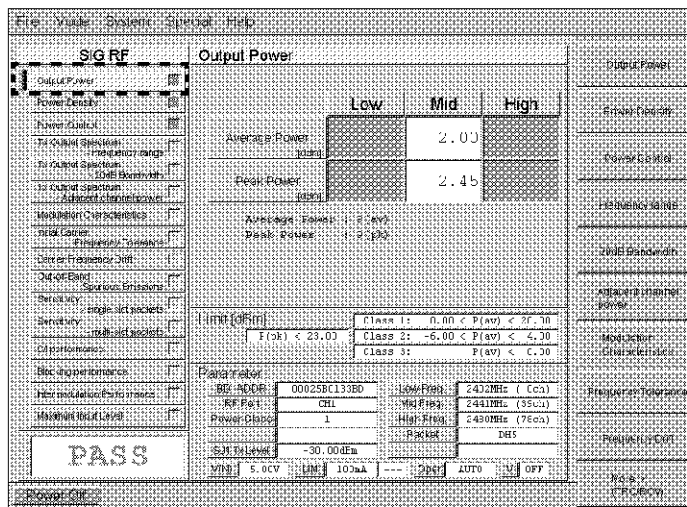

Figure 2-31 Output Power Measuring PASS

If all measurements are complete and all measurement results satisfy the required values, the screen shown in Figure 2-32 is displayed. All results which indicate boxes turn green and the final result is shown in the box as PASS in green.

If there are any failed test items, the result is shown as FAIL in red.

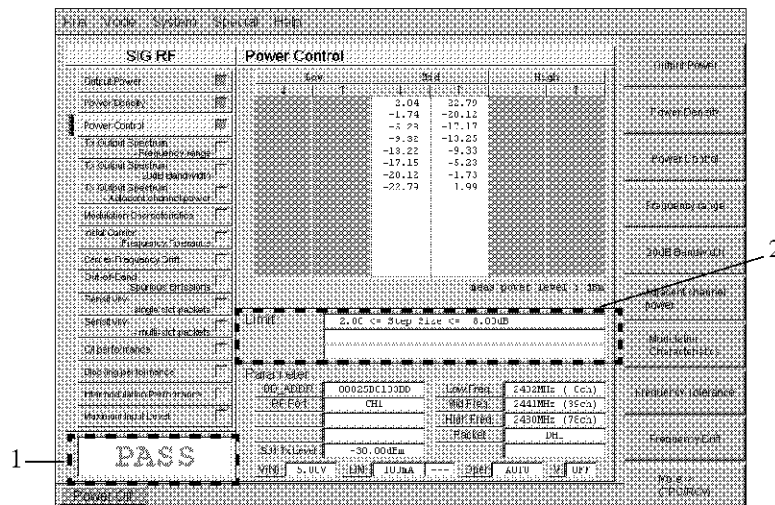

Figure 2-32 All Test Items PASS

2.4.2 TELEC Test

The method which executes a test based on the TELEC test (2.4 GHz band high-speed wireless LAN) method is described here.

2.4.2.1 Preparation for Measurement

1. Turn ON the power to each device.

NOTE: When only the TELEC test is performed, it can be executed only by turning on the power to the R4870, R3273, 2303 and NRVD. Even if the SMIQ and SMR power are turned off, the TELEC test is not affected.

2. Click **Mode** on the main menu and select **Function Select** → **Radio Low** → **Telec**. The Telec measurement screen is displayed (Refer to Figure 2-33).

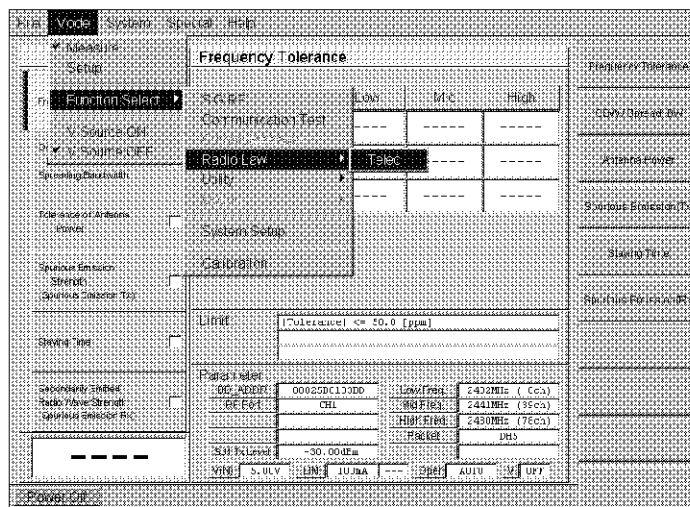

Figure 2-33 Telec Test Setting

3. Click **Mode** on the main menu and select **Setup** from the drop down menu.
4. Press **Measurement Item All ON** on the screen shown in Figure 2-34 so that all measurement items are executed. If the check boxes indicated by arrows in Figure 2-34 are checked to set all measurement items, only the Mid. Ch. is executed in the Spurious Emission (Tx) measurement, the checkmark is cleared and no measurements for Low Ch. and High Ch. is performed.

2.4.2 TELEC Test

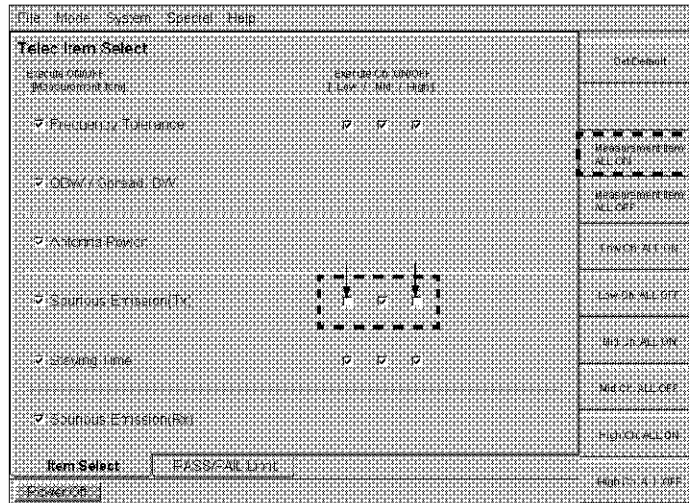

Figure 2-34 Telec Item Select Screen

5. Setting the Frequency Tolerance limit

Click the **PASS/FAIL Limit** tab.

The Telec Limit Parameter screen is displayed.

If **Frequency Tolerance** is clicked, the screen shown in Figure 2-35 is displayed.

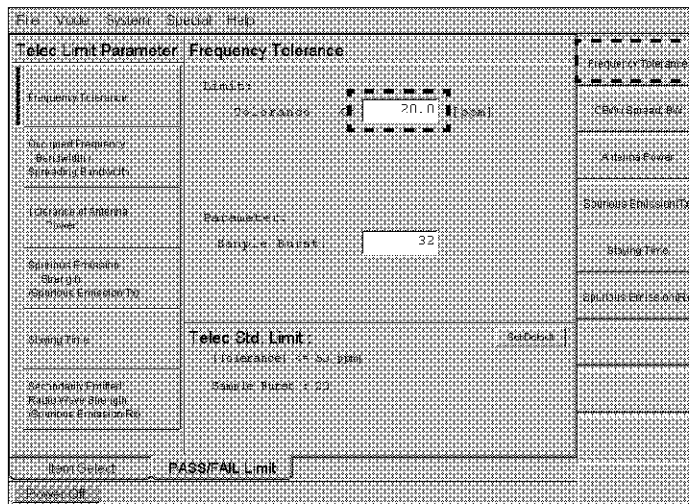

Figure 2-35 Frequency Tolerance Limit Setting

To change the tolerance to 20 ppm, place the cursor in the Tolerance textbox and enter **2**, **0**, and **ENT**.

The tolerance changes from 50 ppm to 20 ppm.

To change the Sample Burst to 32 times, place the cursor in the Sample Burst textbox and enter **3**, **2**, and **ENT**. The Sample Burst changes from 20 times to 32 times.

6. Setting the Limits for OBW and Spread. Bandwidth

If **OBW/Spread. BW** is clicked, the screen shown in Figure 2-36 is displayed.

Telec Limit Parameter: Occupied Frequency BW / Spreading BW		Frequency Tolerance
Frequency Tolerance	OBW: 80.00 MHz	Occupied Bandwidth
Occupied Frequency Bandwidth / Spreading Bandwidth	Spread. BW: 0.40 MHz / Spreading BW	Antenna Power
Tolerance of Antenna Power	Telec Std. Limit: [Set Default]	Square Emission (C)
Spurious Emission (Spectrum)	Unit: dBm / 100 Hz	Rising Time
Spurious Emission (Spectrum)	Spread. BW: 0.40 MHz / Spreading BW	Spectrum Emission (C)
Spurious Emission (Spectrum)		
IBM Select	PASS/FAIL Limit	

Figure 2-36 OBW Limit Setting

To change the OBW Limit to 80 MHz, place the cursor in the OBW textbox and enter **8**, **0** and **ENT**. The limit value changes from 83.5 MHz to 80 MHz.

To change Spread. BW to 0.4 MHz, place the cursor in the textbox and enter **0**, **.**, **4** and **ENT**. Spread. BW changes from 0.5 MHz to 0.4 MHz.

7. Setting the Antenna Power Limit

If Antenna Power is clicked, the screen shown in Figure 2-37 is displayed.

Telec Limit Parameter: Tolerance of Antenna Power		Frequency Tolerance
Frequency Tolerance	OBW: -6C.C	Occupied Bandwidth
Occupied Frequency Bandwidth / Spreading Bandwidth	Spread. BW: 0.50 MHz	Antenna Power
Tolerance of Antenna Power	Antenna Power: 0.0300 [dBm/MHz]	Square Emission (C)
Spurious Emission (Spectrum)	Spread. BW: 0.50 MHz	Rising Time
Spurious Emission (Spectrum)	Telec Std. Limit: [Set Default]	Spectrum Emission (C)
Spurious Emission (Spectrum)	Unit: dBm / 100 Hz	
Spurious Emission (Spectrum)	Antenna Power: 0.0300 dBm/MHz	
Spurious Emission (Spectrum)	Spread. BW: 0.50 MHz	
IBM Select	PASS/FAIL Limit	

Figure 2-37 Antenna Power Setting

2.4.2 TELEC Test

To change the Limit value from -80% to -60%, place the cursor in the (-) side textbox and enter **-**, **6**, **0** and **ENT**. The Limit value on the (-) side changes to -60%.

NOTE:

1. *Manufacturers must apply to TELEC to register the Antenna Power and Burst ON/OFF Ratio values.*
2. *In accordance with the SIG Standards, depending on the packet type, the Burst ON/OFF Ratio is DH1 ≙ 0.30, DH3 ≙ 0.64 and DH5 ≙ 0.75. However, the Burst ON/OFF Ratios for all IUTs are not necessarily the same.*

8. Setting the Spurious Emission Strength Limit

If Spurious Emission (Tx) is clicked, the screen shown in Figure 2-38 is displayed.

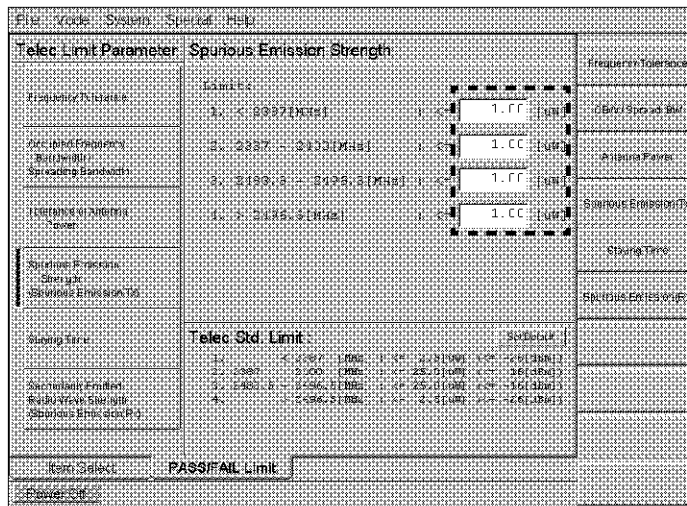

Figure 2-38 Spurious Emission Limit Setting

To set all Limit values to 1 mW, place the cursor in the textbox and enter **1** and **ENT**. The set value changes to 1 mW.

9. Setting the Staying Time Limit

If Staying Time is clicked, the screen shown in Figure 2-39 is displayed.

Telec Limit Parameter		Staying Time	
Frequency Tolerance	1.000%	Staying Time: 0.1000 [sec]	Frequency Tolerance
Occupied Frequency Bandwidth Spreading Bandwidth			ANW Spread SW
Tolerance Modulation Power			Area Power
Spurious Emission Strength			Spurious Emission Rx
Spurious Emission Rx			Staying Time
Starting Time	Telec Std. Limit	Set Pass	Spurious Emission Rx
Secondary Emission Power Wave Strength			
Spurious Emission Rx			
Item Select	PASS/FAIL Limit		

Figure 2-39 Staying Time Limit Setting

To set the Staying Time to 0.1 sec, place the cursor in the textbox and enter **0**, **.**, **1** and **ENT**. The set value changes to 0.1 sec.

10. Setting the Secondary Emitted Radio Wave Strength Limit

If Spurious Emission (Rx) is clicked, the screen shown in Figure 2-40 is displayed.

Telec Limit Parameter		Secondarily Emitted Radio Wave Strength	
Frequency Tolerance	1.000%	Spurious Level: 1.00 [nW]	Frequency Tolerance
Occupied Frequency Bandwidth Spreading Bandwidth			ANW Spread SW
Tolerance Modulation Power			Area Power
Spurious Emission Strength			Spurious Emission Rx
Spurious Emission Rx			Staying Time
Starting Time	Telec Std. Limit	Set Pass	Spurious Emission Rx
Secondary Emission Power Wave Strength			
Spurious Emission Rx			
Item Select	PASS/FAIL Limit		

Figure 2-40 Spurious Emission (Rx) Limit Setting

To set the Spurious level to 1 nW, place the cursor in the textbox and enter **1** and **ENT**. The set value changes to 1 nW.

The Limit settings are complete.

2.4.2 TELEC Test

- Click **Mode** on the main menu and select **Measure** from the drop down menu. The screen switches to the measurement screen (Refer to Figure 2-41).

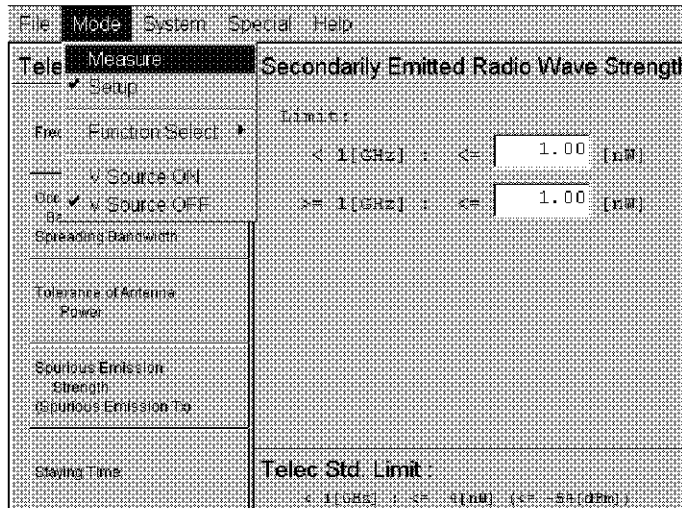

Figure 2-41 Switching from the Setup Mode to the Measure Mode

- Test Execution - Frequency Tolerance

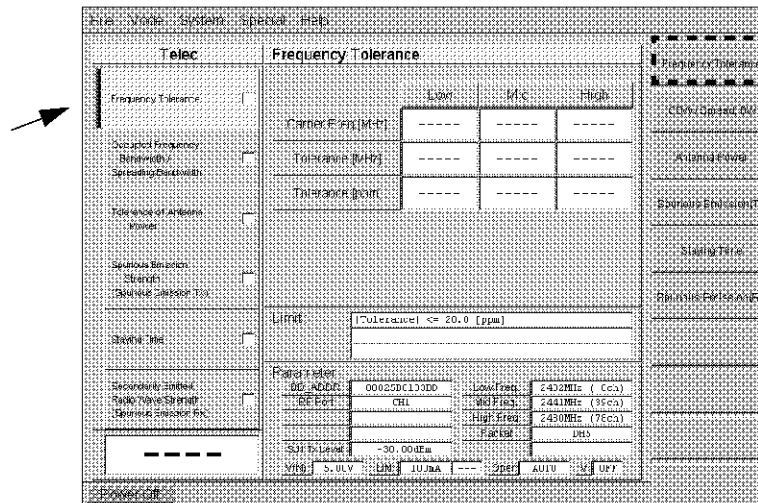

Figure 2-42 Telec Measurement Screen

If **Frequency Tolerance** is clicked on the side menu, a blue bar is displayed in the test item indicator (Refer to the arrow in Figure 2-42.)

If **SINGLE** is pressed, only the Frequency Tolerance measurement is executed. If **START** is pressed, all TELEC measurement items are executed. (If any error occurs during measurement, the measurement stops and an error message is displayed.)

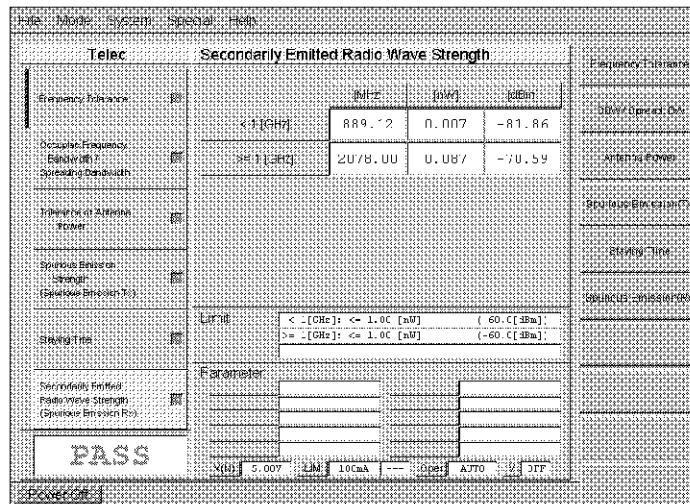

Figure 2-43 Screen at the Time of Completion of All TELEC Test Items

Figure 2-43 shows the screen in which all TELEC tests have been passed.

All result-displaying boxes turn green and the display for the final result is PASS.

- Special operation in the SINGLE test

The measurement results of the tests shown below are necessary when performing measurement tests for the Antenna Power Tolerance and Spurious Emission Strength.

- Before performing the Tolerance of Antenna Power test, the Spreading Bandwidth test must be performed.
- Before performing the Spurious Emission Strength test, the Antenna Power and Spreading Bandwidth tests must be performed.

2.5 Method to Identify Malfunctioning

2.5 Method to Identify Malfunctioning

FAILs which occur in the measurement results (excluding faults in the IUT characteristics), may be caused by the following:

1. Settings outside measurement parameters ranges
2. Faults in the connection cable
3. Faults in the measuring instruments

2.5.1 Setting Measurement Parameters

Sometimes test results are FAIL because the set measurement parameters are different.

For example, if the limit values for the PASS/FAIL judgment are incorrect, check the settings by comparing them with the limit value shown in Figure 2-32.

2.5.2 Faults in the Connection Cable

Cables that are continuously connected to and disconnected from the IUT:

- RF cable
- IUT power cable
- RS-232 cable for HCI

NOTE: Because a wire maybe broken or contact faulty in the above-mentioned cables, regularly check for faults.

2.5.3 Faults in Measuring Instruments

If the R3273 malfunctions, measurement results are negatively affected.

In addition to system calibration, regularly calibrate the R3273 as an individual unit.

For more information on how to calibrate, refer to the R3267 series Operation Manual.

If any peripheral equipment malfunctions, measurement results are negatively affected.

For more information on malfunctioning and how to calibrate, refer to the relevant Operation Manuals.

3. REFERENCE

This chapter describes the menu configurations and functions.

- Menu Index: This section can be referred to as the index for Chapter 3.
- Menu Map: The menu configurations.
- Functional Descriptions: The menu item functions.

3.1 Menu Index

Operation Key	Pages	Operation Key	Pages
< Connection Item	3-8, 3-26	Calibration	3-5, 3-9, 3-13, 3-23, 3-27, 3-32
< More	3-7, 3-25	Carrier Freq. Drift	3-15, 3-19
< More (TRM)	3-6, 3-16, 3-17, 3-24	Carrier Frequency Drift	3-18
20dB Bandwidth	3-6, 3-15, 3-16, 3-17, 3-18, 3-19, 3-24, 3-28, 3-29	CH1-Input	3-9, 3-13, 3-27
About...	3-5, 3-24	CH1-Output	3-9, 3-13, 3-27
ACL data	3-7, 3-25	Comment Edit	3-9, 3-13, 3-27, 3-32
ACL Packet Types	3-11	Communication Test	3-5, 3-7, 3-11, 3-23, 3-24, 3-30
Adjacent Channel Power	3-29	Connection	3-8, 3-26
Adjacent channel power	3-6, 3-15, 3-16, 3-17, 3-18, 3-19, 3-24, 3-28	Current Measure	3-5, 3-23
Air Cording Format	3-12	DC Source (ext)	3-9, 3-13, 3-26, 3-31
Antenna Power	3-7, 3-21, 3-22, 3-25	Delete...	3-5, 3-23
Authentication-IUT as Master	3-7, 3-11, 3-25	Disconnection	3-8, 3-26
Authentication-IUT as Slave	3-7, 3-11, 3-25	Explorer	3-5, 3-23
BER	3-8, 3-13, 3-20, 3-26, 3-31	File	3-5, 3-23
Blocking Performance	3-29	FM Deviation	3-8, 3-13, 3-20, 3-26, 3-31
Blocking performance	3-6, 3-15, 3-16, 3-17, 3-18, 3-19, 3-24	Frequency Drift	3-6, 3-16, 3-17, 3-24, 3-28, 3-29
C/I Performance	3-29	Frequency Range	3-28, 3-29
C/I performance	3-6, 3-15, 3-16, 3-17, 3-18, 3-19, 3-24	Frequency range	3-6, 3-15, 3-16, 3-17, 3-18, 3-19, 3-24
		Frequency Tolerance	3-6, 3-7, 3-16, 3-17, 3-18, 3-21, 3-22, 3-24,

3.1 Menu Index

	3-25, 3-28, 3-29	Low Ch. ALL OFF	3-10, 3-12, 3-15, 3-21, 3-28, 3-30
Function Select	3-5, 3-6, 3-7, 3-8, 3-9, 3-10, 3-11, 3-12, 3-13, 3-14, 3-15, 3-16, 3-17, 3-19, 3-20, 3-21, 3-22, 3-23	Low Ch. ALL ON	3-10, 3-12, 3-15, 3-21, 3-28, 3-30
Help	3-5, 3-24	Maximum Input Level	3-6, 3-15, 3-16, 3-17, 3-18, 3-19, 3-24, 3-29
High Ch. ALL OFF	3-10, 3-12, 3-15, 3-21, 3-28, 3-30	Measure	3-5, 3-23
High Ch. ALL ON	3-10, 3-12, 3-15, 3-21, 3-28, 3-30	Measure Item >	3-8, 3-26
Initial Carrier Freq. Tolerance	3-15, 3-19	Measurement Item ALL OFF	3-10, 3-12, 3-15, 3-21, 3-28, 3-30
Input Cording	3-12	Measurement Item ALL ON	3-10, 3-12, 3-15, 3-21, 3-28, 3-30
Input Data Format	3-12	Mid Ch. ALL OFF	3-10, 3-12, 3-15, 3-21, 3-28, 3-30
Input Sample Size	3-12	Mid Ch. ALL ON	3-10, 3-12, 3-15, 3-21, 3-28, 3-30
Inquiry	3-7, 3-11, 3-24	Mode	3-5, 3-6, 3-7, 3-8, 3-9, 3-10, 3-11, 3-12, 3-13, 3-14, 3-15, 3-16, 3-17, 3-19, 3-20, 3-21, 3-22, 3-23
Inquiry Scan	3-7, 3-11, 3-24	Modulation Characteristics	3-6, 3-15, 3-16, 3-17, 3-18, 3-19, 3-24, 3-29
Interfere1 port	3-9, 3-13, 3-27	Item ALL OFF	3-11, 3-13, 3-30
Interfere2 port	3-9, 3-13, 3-27	Item ALL ON	3-11, 3-13, 3-30, 3-32
Intermodulation Performance	3-6, 3-15, 3-16, 3-17, 3-18, 3-19, 3-24, 3-29	Item Select	3-14, 3-15, 3-21, 3-28
Item ALL OFF	3-11, 3-13, 3-30	IUT Information	3-9, 3-13, 3-26, 3-31
Item ALL ON	3-11, 3-13, 3-30, 3-32	IUT Voice Setting	3-12
Item Select	3-14, 3-15, 3-21, 3-28	Liner_PCM_Bit_Pos	3-12
IUT Information	3-9, 3-13, 3-26, 3-31	Link Supervision Timeout-IUT as Master	3-7, 3-11, 3-25
IUT Voice Setting	3-12	Link Supervision Timeout-IUT as Slave	3-7, 3-11, 3-25
Liner_PCM_Bit_Pos	3-12	LMP_test_control	3-14, 3-19, 3-29
Link Supervision Timeout-IUT as Master	3-7, 3-11, 3-25	Load...	3-5, 3-23
Link Supervision Timeout-IUT as Slave	3-7, 3-11, 3-25		
LMP_test_control	3-14, 3-19, 3-29		
Load...	3-5, 3-23		
		Monitor1 port	3-9, 3-13, 3-27
		Monitor2 port	3-9, 3-13, 3-27
		More >	3-7, 3-25
		More >(TRC/RCV)	3-6, 3-16, 3-17, 3-24
		Network Config...	3-5, 3-23
		OBW/Spread. BW	3-7, 3-21, 3-22, 3-25
		Occupied Frequency Bandwidth/ Spreading Bandwidth	3-22
		Option	3-5, 3-23
		Out-of-Band Spurious Emissions	3-6, 3-16,

Output Power	3-24, 3-28 3-6, 3-15, 3-16, 3-17, 3-18, 3-19, 3-24, 3-28, 3-29	SCO Loopback-IUT as Master	3-25 3-8, 3-12, 3-26
Paging-IUT as Master	3-7, 3-11, 3-24	SCO Loopback-IUT as Slave	3-8, 3-12, 3-25
Paging-IUT as Slave	3-7, 3-11, 3-25	SCO Packet Type	3-12
Pairing	3-7, 3-11, 3-25	Secondarily Emitted Radio Wave Strength (Spurious Emission Rx)	3-22
Panel Lock OFF	3-5, 3-24	Sensitivity-multi-slot packets	3-6, 3-15, 3-16, 3-19, 3-24, 3-29
Panel Lock ON	3-5, 3-24	Sensitivity-single slot packets	3-6, 3-15, 3-16, 3-19, 3-24, 3-29
PASS/FAIL Limit	3-14, 3-16, 3-20, 3-21, 3-22, 3-28, 3-31	Sensitivity-single/multi	3-17, 3-18, 3-29
PIN Code	3-12	Set Default	3-10, 3-11, 3-12, 3-13, 3-15, 3-21, 3-28, 3-30, 3-32
Power Control	3-6, 3-15, 3-16, 3-17, 3-18, 3-19, 3-24, 3-28, 3-29	Set Default All	3-19, 3-29
Power Density	3-6, 3-15, 3-16, 3-17, 3-18, 3-19, 3-24, 3-28, 3-29	Set Default Packets	3-19, 3-29
Power Off	3-5, 3-23	Set Default Poll Period	3-19, 3-30
Power Splitter	3-9, 3-13, 3-27	Set Default Test scenario	3-19, 3-29
Radio Law	3-5, 3-7, 3-21, 3-22, 3-23, 3-25, 3-30	Setup	3-5, 3-23
Receiver Test (BER,PER)	3-17, 3-18, 3-29	SIG RF	3-5, 3-6, 3-10, 3-14, 3-15, 3-16, 3-17, 3-19, 3-23, 3-24, 3-28
Remote Loopback	3-5, 3-8, 3-12, 3-23, 3-25, 3-30	Special	3-5, 3-23
RF Measurement	3-5, 3-8, 3-13, 3-20, 3-23, 3-26, 3-31	Spurious Emission (Rx)	3-7, 3-21, 3-22
RS-232 Port	3-9, 3-13, 3-26, 3-31	Spurious Emission (Tx)	3-7, 3-21, 3-22, 3-25
Save... ..	3-5, 3-23	Spurious Emission Strength (Spurious Emission Tx)	3-22
SCO data-IUT as Master	3-7, 3-11, 3-25	Spurious Emissions	3-15, 3-19
SCO data-IUT as Slave	3-7, 3-11,	Spurious Emissions (ETS)	3-17, 3-18, 3-29
		Spurious Emissions (FCC)	3-17, 3-18, 3-29
		Spurious Emission (Rx)	3-25
		Staying Time	3-7, 3-21, 3-22, 3-25
		System	3-5, 3-23
		System Configuration	3-9, 3-13, 3-26, 3-32
		System Setup	3-5, 3-9,

3.1 Menu Index

	3-13, 3-23, 3-26, 3-31
Telec	3-5, 3-7, 3-21, 3-22, 3-23, 3-25, 3-30
Test Parameter	3-14, 3-17, 3-20, 3-29, 3-31
Time Adjust... ..	3-5, 3-23
Tolerance of Antenna Power	3-22
Utility	3-5, 3-8, 3-12, 3-13, 3-20, 3-23, 3-25, 3-30
V Source OFF	3-5, 3-23
V Source ON	3-5, 3-23

3.2 Menu Map

This section describes the configurations of the main menu, drop down menus, side menus, and tab menu.

NOTE:

 Describes the main menu.

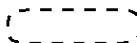
 Describes drop down menus.

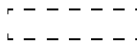
 Describes dialog boxes.

Functions marked with "" are not currently supported.*

3.2.1 Main Menu and Drop Down Menu

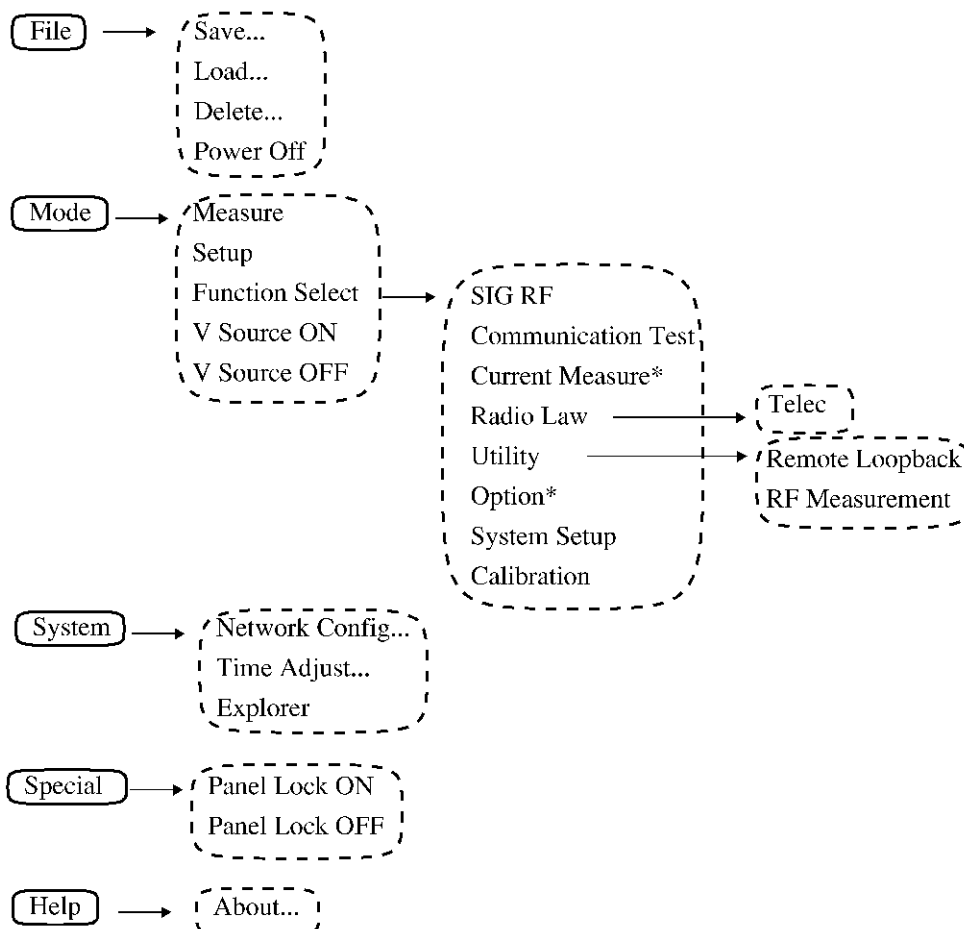

3.2.2 Side Menu

3.2.2 Side Menu

1. Measurement mode menu

a. SIG RF

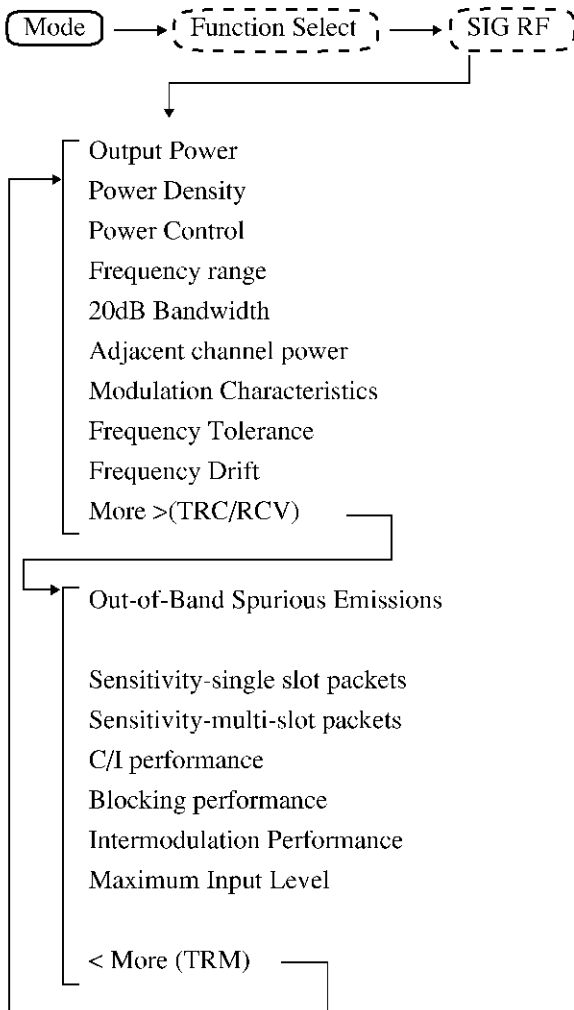

b. Communication Test

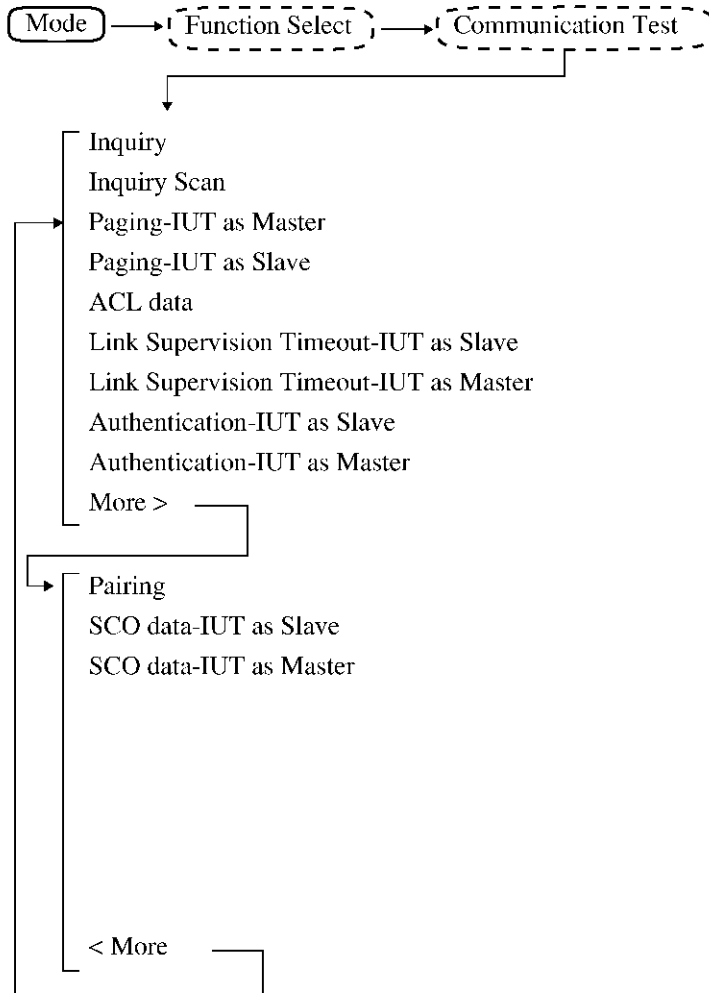

c. Telec

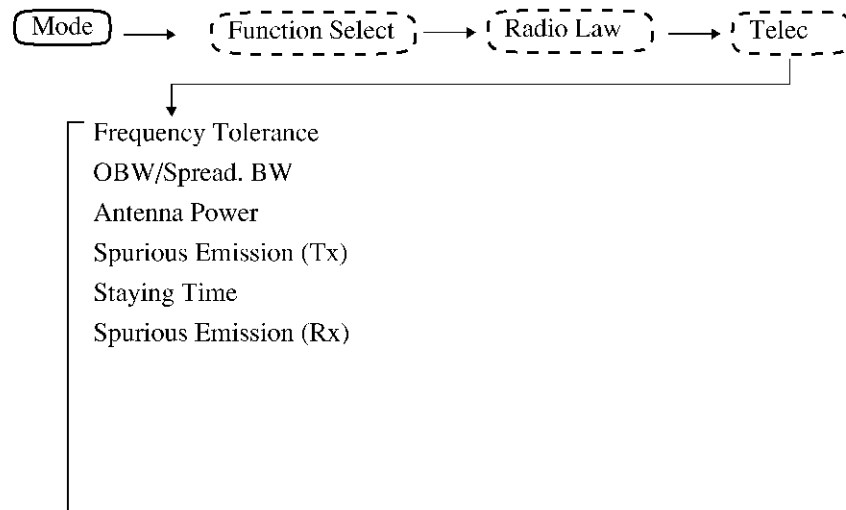

3.2.2 Side Menu

d. Remote Loopback

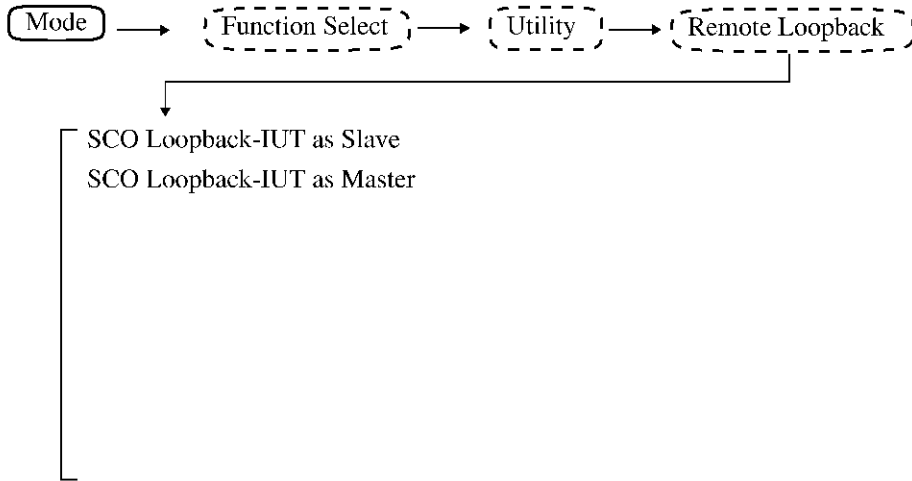

e. RF Measurement

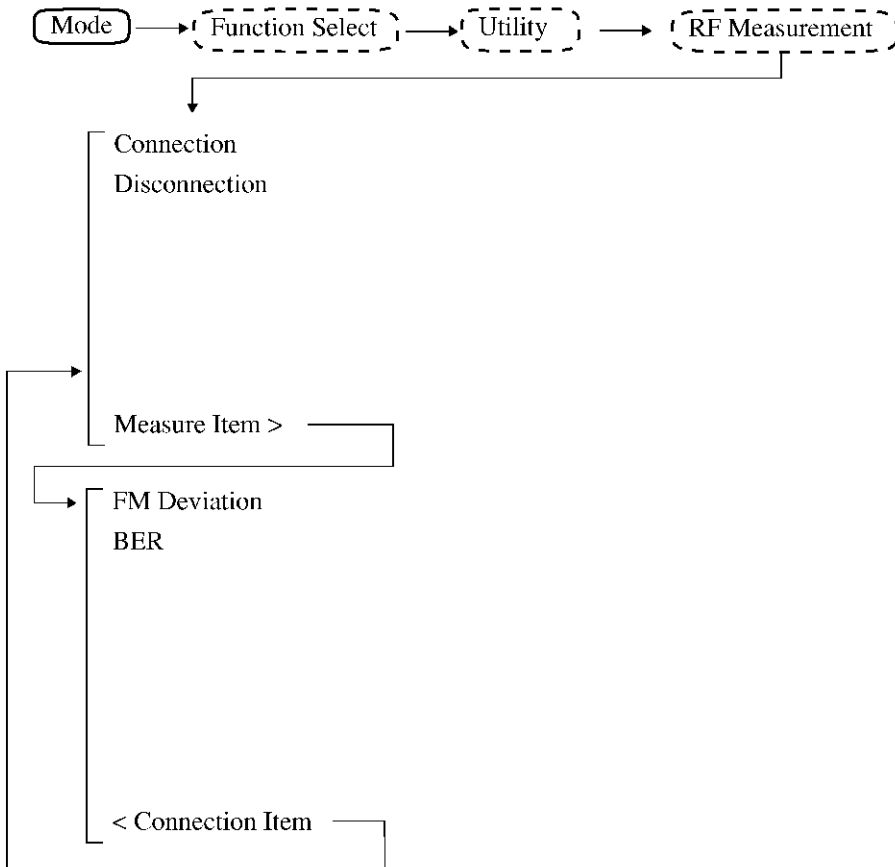

f. System Setup

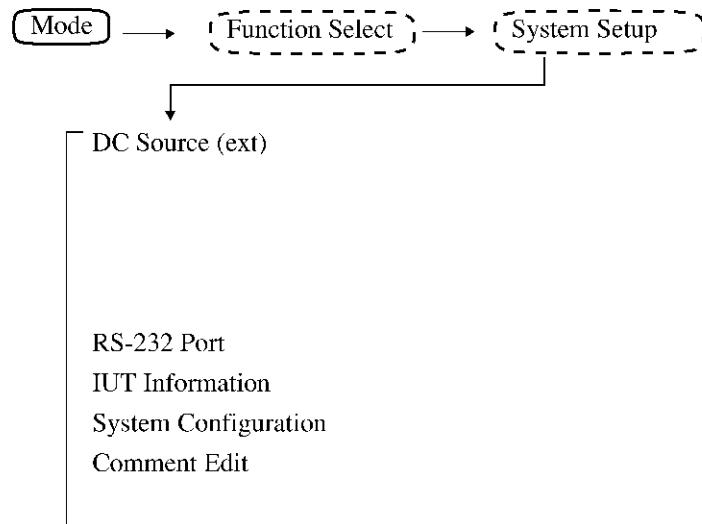

g. Calibration

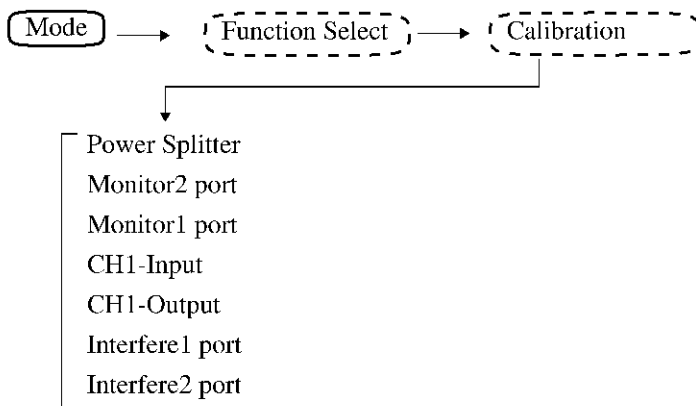

3.2.2 Side Menu

2. Setup mode menu

a. SIG RF

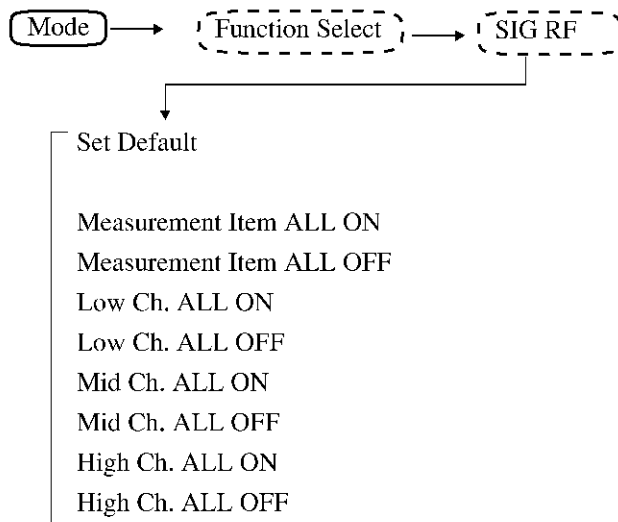

b. Communication Test

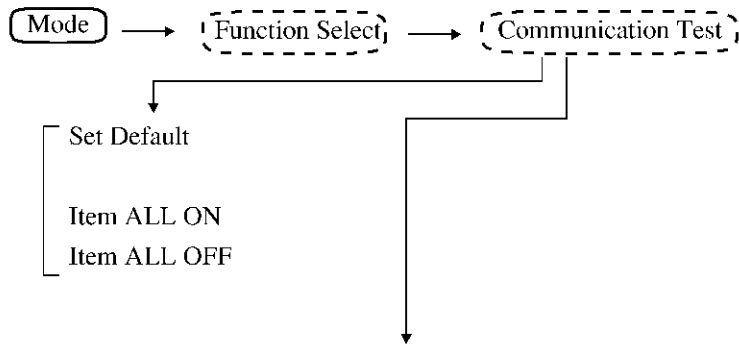

Communication Test – Setup

Inquiry	Inquiry_Length
Inquiry Scan	Inquiry_Length
Paging- IUT as Master	Page_Scan_Repetition_Mode
Paging- IUT as Slave	Page_Scan_Repetition_Mode
ACL Packet Types	Packet_Type, Payload_Body
Link Supervision Timeout-IUT as Slave	Link_Supervision_Timeout
Link Supervision Timeout-IUT as Master	Link_Supervision_Timeout
Authentication-IUT as Slave	Page_Scan_Repetition_Mode
Authentication-IUT as Master	Page_Scan_Repetition_Mode
Pairing	Page_Scan_Repetition_Mode
	PIN_Code(MAX HEX 32characters)
SCO data-IUT as Slave	Packet_Type
SCO data-IUT as Master	Packet_Type

3.2.2 Side Menu

c. Telec

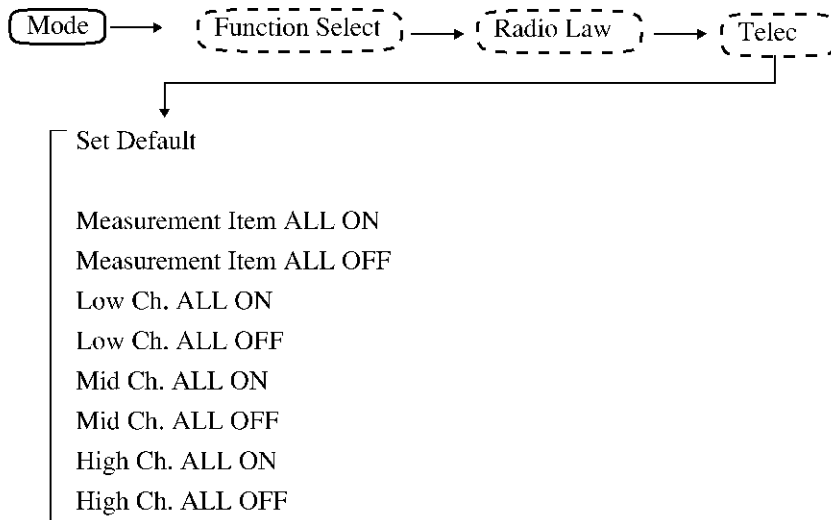

d. Remote Loopback

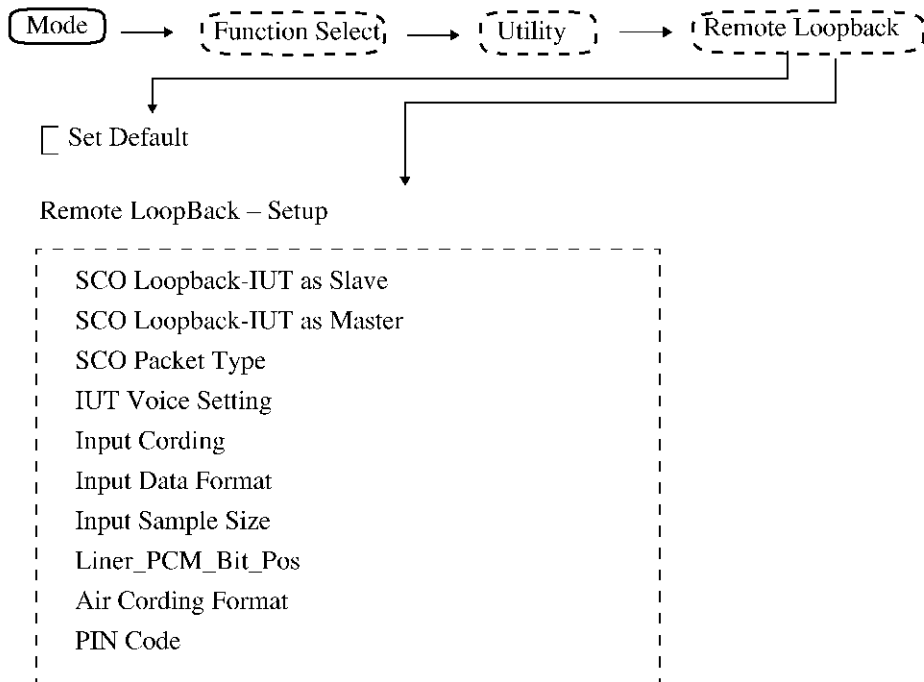

e. RF Measurement

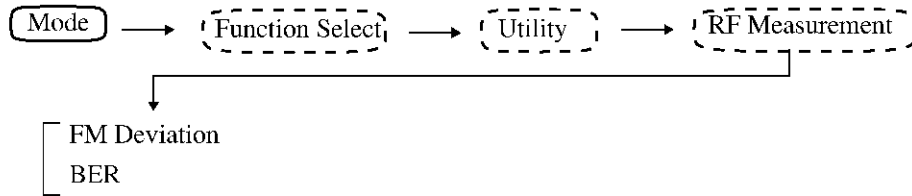

f. System Setup

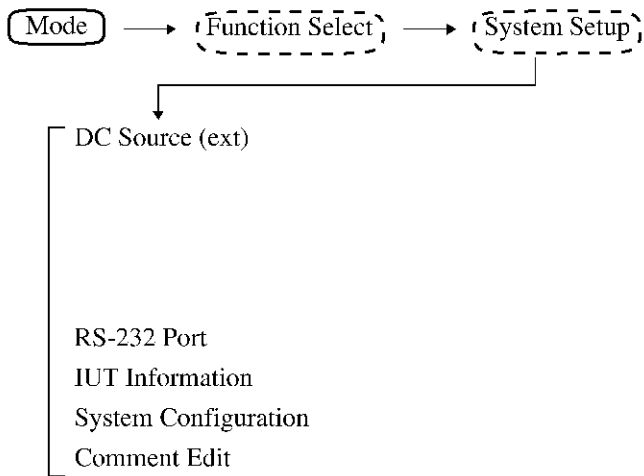

g. Calibration

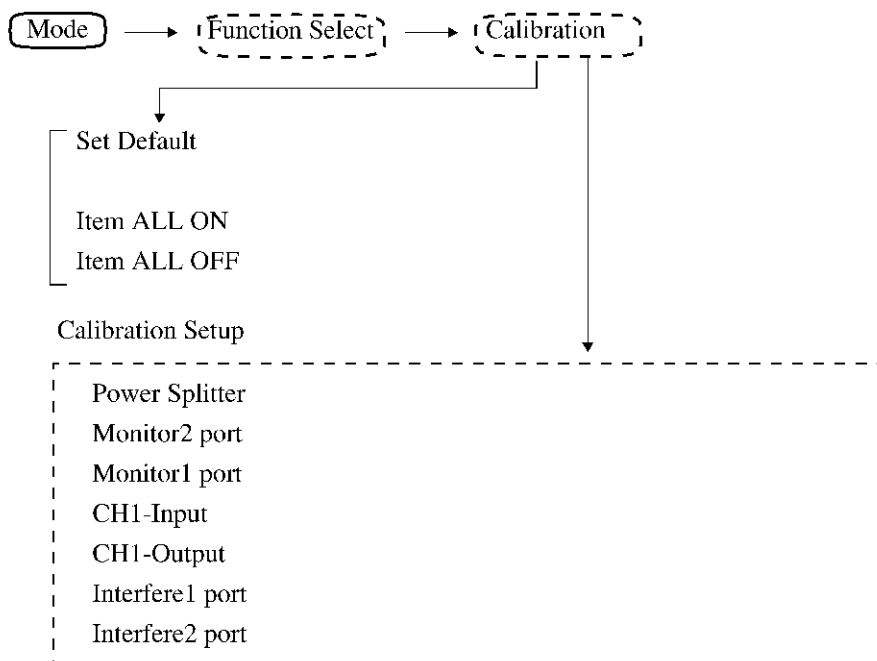

3.2.3 Tab

3.2.3 Tab

3.2.3.1 SIG RF tab

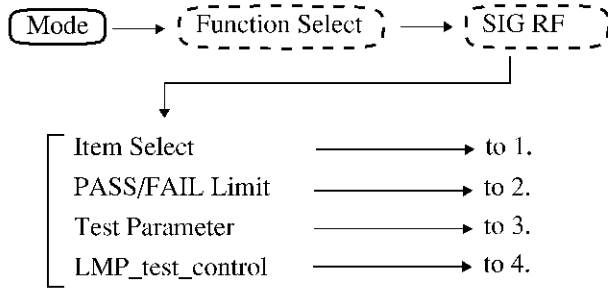

1. Item Select tab

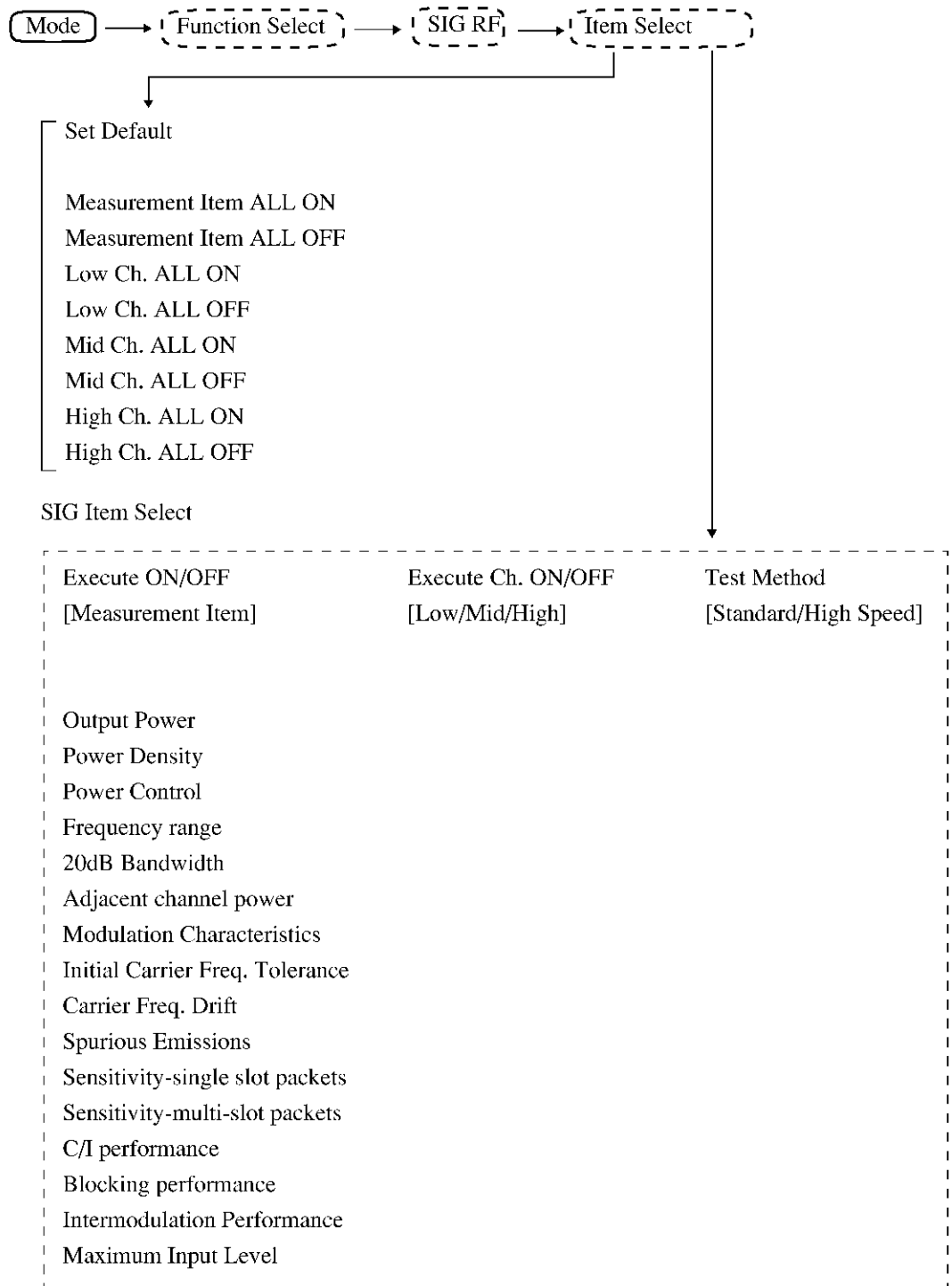

3.2.3 Tab

2. PASS / FAIL Limit tab

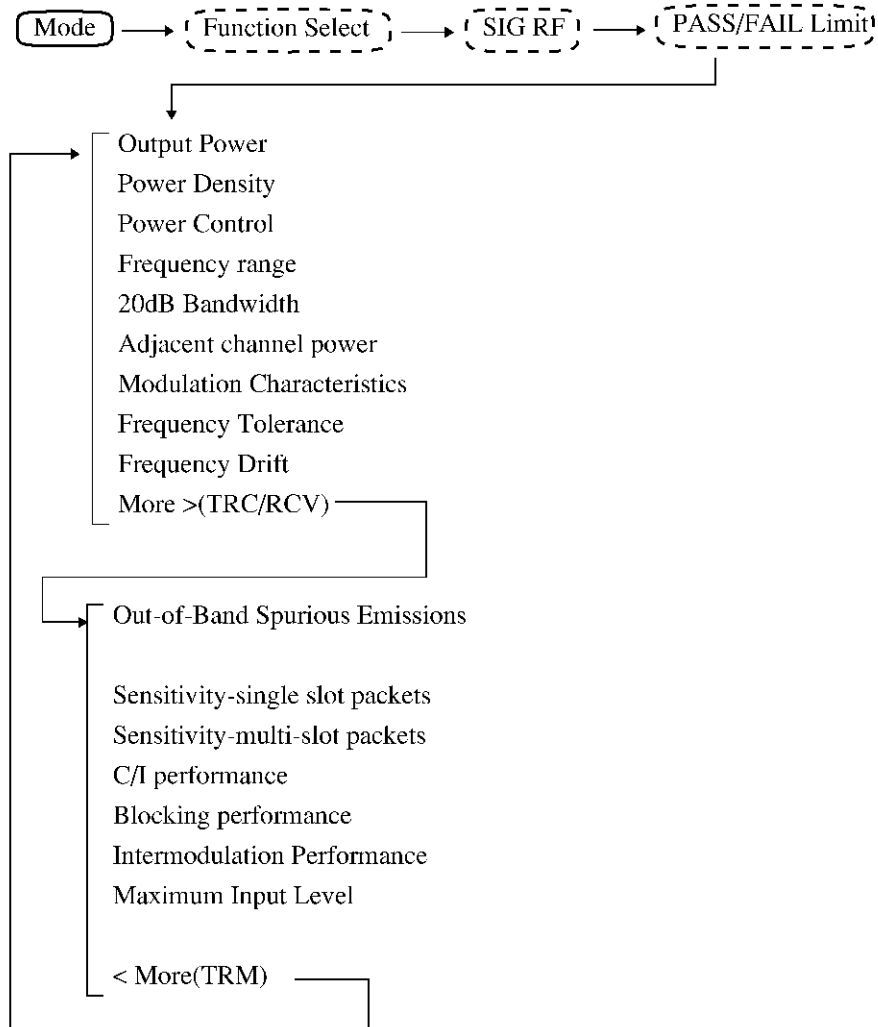

3. Test Parameter tab

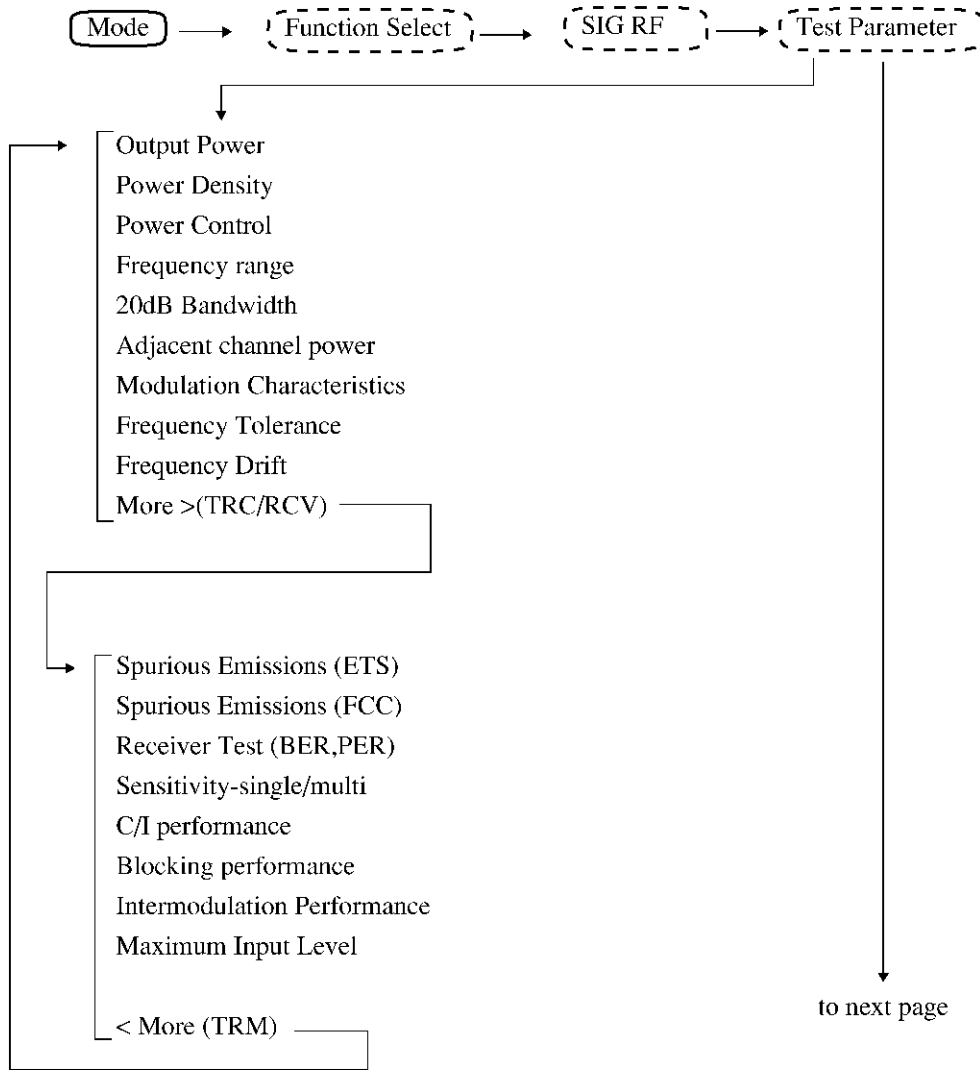

3.2.3 Tab

SIG Test Parameter (Continued)

Output Power	Start Point, Stop Point, Leading and trading point, Average Count
Power Density	Standard: Peak Frequency, Peak Power High Speed: Peak Frequency, Peak Power
Power Control	Step Number, Minimum Level: Standard, High Speed, Wait time out, Judgement: Step number, Minimum Level
Frequency Range	Frequency Range Level, Sweep Count
20dB Bandwidth	Bandwidth Level
Adjacent channel power	Number of Adjacent Channel
Modulation Characteristics	Sample Packets, Gain of frequency deviation, Average frequency calculation
Frequency Tolerance	Sample Packets Select Hopping Mode: Hopping ON/OFF
Carrier Frequency Drift	Sample Packets Select Hopping Mode: Hopping ON/OFF
Spurious Emissions (ETS)	Meas Range (Standard), Meas Point (HighSpeed), Standby Mode
Spurious Emissions (FCC)	Meas Range (Standard), Meas Point (HighSpeed)
Receiver Test (BER,PER)	Standard, High Speed, PER Calculation: HEC and Access Code HEC, Access Code and include Data payload error packets
Sensitivity-single/multi	Dirty ON/OFF, TX Level
C/I Performance	Image Frequency, Interfering Level, Wanted Level
Blocking Performance	Wanted Signal Level, Interfering Signal Level 1/2/3
Intermodulation Performance	Wanted Signal Level,f1 Signal level,f2 Signal Level
Maximum Input Level	TX Level

4. LMP_test_control tab

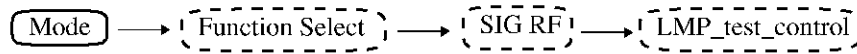

- Set Default All
- Set Default Packets
- Set Default Test scenario
- Set Default Poll Period

SIG LMP_test_control Parameter

Test Item	Packets	Test scenario	Poll Period
	DH1/DH3/DH5	TX Mode Loopback	
Output Power			
Power Density			
Power Control			
Frequency range			
20dB Bandwidth			
Adjacent channel power			
Modulation Characteristics			
Initial Carrier Freq. Tolerance			
Carrier Freq. Drift			
Spurious Emissions			
Sensitivity-single slot packets			
Sensitivity-multi-slot packets			
C/I performance			
Blocking performance			
Intermodulation Performance			
Maximum Input Level			

3.2.3 Tab

3.2.3.2 RF Measurement

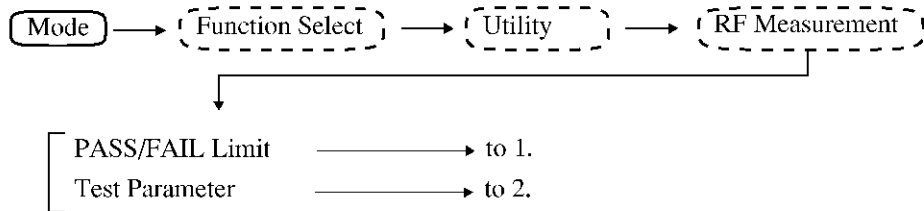

1. PASS/FAIL Limit tab

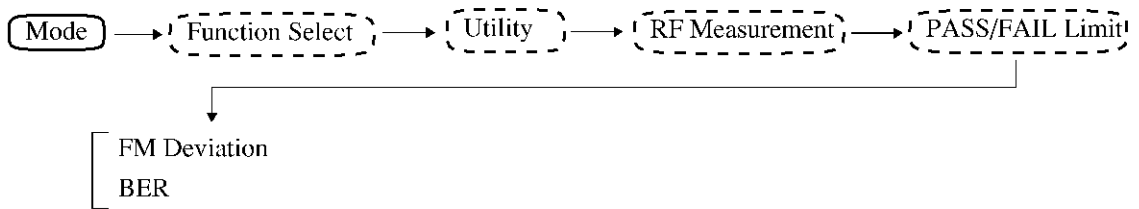

2. Test Parameter tab

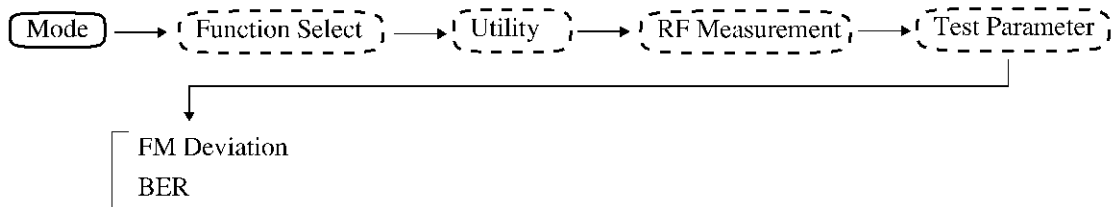

3.2.3.3 TELEC tab

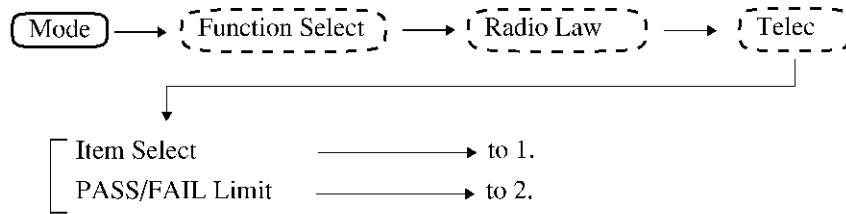

1. Item Select tab

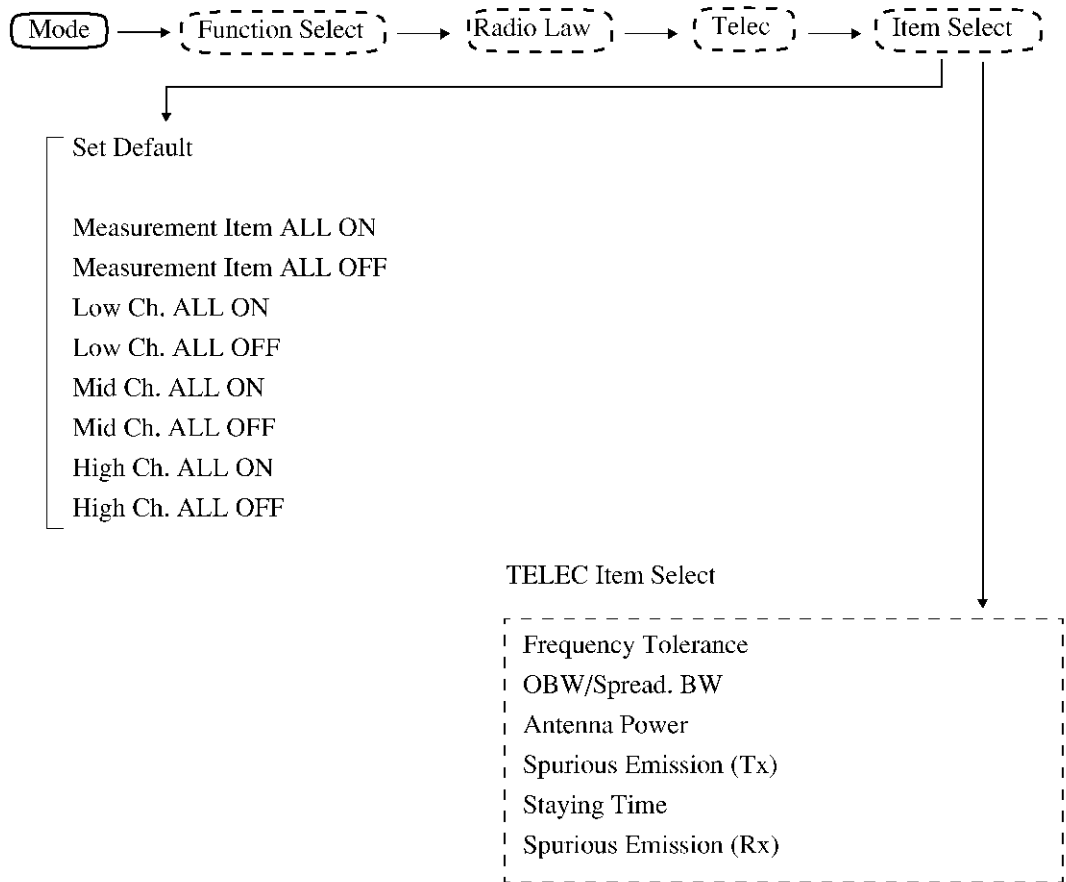

3.2.3 Tab

2. PASS/FAIL Limit tab

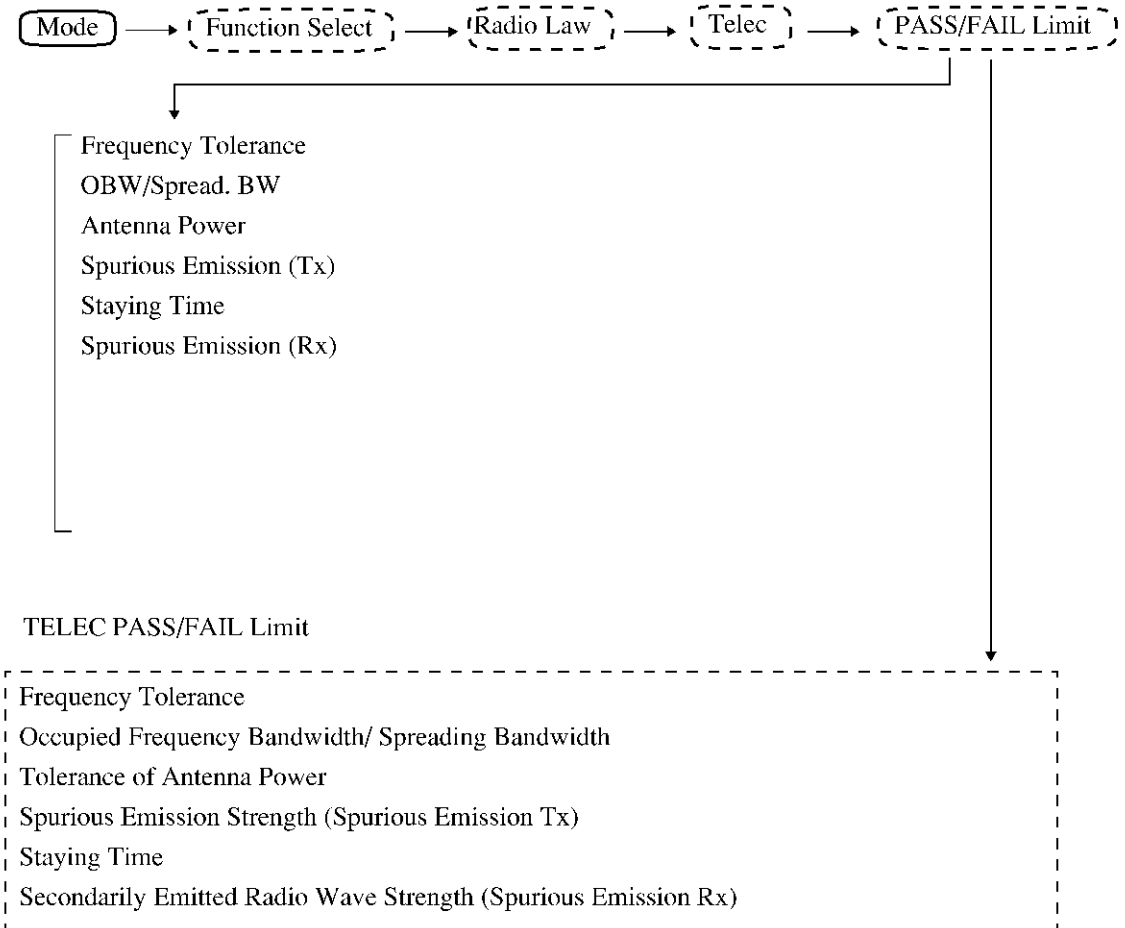

3.3 Functional Descriptions

This section describes the each menu function.

3.3.1 Main Menu

File	Displays the following file related selections and system shutdown menu in a drop down menu.
<i>Save...</i>	Displays the file save window.
<i>Load...</i>	Displays the file load window.
<i>Delete...</i>	Displays the file delete window.
<i>Power Off</i>	Displays the system shutdown dialog box.
Mode	Displays the following mode related selections in a drop down menu.
<i>Measure</i>	Displays the test execution screen.
<i>Setup</i>	Displays the test condition set up screen.
<i>Function Select</i>	Displays the test and system setting selection menu.
<i>SIG RF</i>	Displays the Bluetooth™ SIG RF Test Specification test menu.
<i>Communication Test</i>	Displays Bluetooth™ SIG Blue Unit Test Cases dialog box menus.
<i>Current Measure*</i>	Currently not supported.
<i>Radio Law</i>	
<i>Telec</i>	Displays the test menu of the TELEC.
<i>Utility</i>	
<i>Remote Loopback</i>	Displays the Remote Loopback evaluation menu.
<i>RF Measurement</i>	Displays the RF Measurement test menu.
<i>Option*</i>	Currently not supported.
<i>System Setup</i>	Displays the test set up menu for the main system and IUT.
<i>Calibration</i>	Displays the system calibration menu.
<i>V Source ON</i>	Turns ON the output of the DC power supply.
<i>V Source OFF</i>	Turns OFF the output of the DC power supply.
System	Displays the following system set up selections in a drop down menu.
<i>Network Config...</i>	Displays the Network Config dialog box.
<i>Time Adjust...</i>	Displays the Time Adjust dialog box.
<i>Explorer</i>	Displays the file operation environment (Explorer).
Special	

3.3.2 Side Menu

<i>Panel Lock ON</i>	Locks the panel.
<i>Panel Lock OFF</i>	Unlocks the panel.
Help	
<i>About...</i>	Displays the system information menu.

3.3.2 Side Menu

1. Measurement mode
 - a. SIG RF

SIG RF	Displays the Bluetooth™ SIG RF Test Specification test menu.
<i>Output Power</i>	Performs an output power test.
<i>Power Density</i>	Performs a power density test.
<i>Power Control</i>	Performs a power control test.
<i>Frequency range</i>	Performs a frequency range test.
<i>20dB Bandwidth</i>	Performs a 20dB bandwidth test.
<i>Adjacent channel power</i>	Performs an Adjacent channel power test.
<i>Modulation Characteristics</i>	Performs a modulation characteristics test.
<i>Frequency Tolerance</i>	Performs an initial carrier frequency tolerance test.
<i>Frequency Drift</i>	Performs a carrier frequency drift test.
<i>More >(TRC/RCV)</i>	Displays the transmission/reception and reception test menu sequel.
Out-of-Band Spurious Emissions	
	Performs an out-of-band spurious emissions test.
<i>Sensitivity-single slot packets</i>	Performs a sensitivity-single slot packets test.
<i>Sensitivity-multi-slot packets</i>	Performs a sensitivity-multi-slot packets test.
<i>C/I Performance</i>	Performs a C/I performance test.
<i>Blocking performance</i>	Performs a blocking performance test.
<i>Intermodulation Performance</i>	Performs an intermodulation performance test.
<i>Maximum Input Level</i>	Performs a maximum input level test.
<i>< More (TRM)</i>	Returns to the transmission test menu.

- b. Communication Test

Communication Test	Displays the Bluetooth™ SIG Blue Unit Test Cases test menu.
<i>Inquiry</i>	Performs an inquiry test on the Bluetooth™ SIG Blue Unit Test Cases.
<i>Inquiry Scan</i>	Performs an inquiry scan test on the Bluetooth™ SIG Blue Unit Test Cases.
<i>Paging-IUT as Master</i>	Performs a paging-IUT as master test on the Bluetooth™ SIG

	Blue Unit Test Cases.
Paging-IUT as Slave	Performs a paging-IUT as slave test on the Bluetooth™ SIG Blue Unit Test Cases.
ACL data	Performs an ACL packet types test on the Bluetooth™ SIG Blue Unit Test Cases.
Link Supervision Timeout-IUT as Slave	Performs a link supervision timeout-IUT as slave test on the Bluetooth™ SIG Blue Unit Test Cases.
Link Supervision Timeout-IUT as Master	Performs a link supervision timeout-IUT as master test on the Bluetooth™ SIG Blue Unit Test Cases.
Authentication-IUT as Slave	Performs an authentication-IUT as slave test on the Bluetooth™ SIG Blue Unit Test Cases.
Authentication-IUT as Master	Performs an authentication-IUT as master test on the Bluetooth™ SIG Blue Unit Test Cases.
More >	Displays the rest of the Bluetooth™ SIG Blue Unit Test Cases menu.
Pairing	Performs a pairing test on the Bluetooth™ SIG Blue Unit Test Cases.
SCO data-IUT as Slave	Performs an SCO data-IUT as slave test on the Bluetooth™ SIG Blue Unit Test Cases.
SCO data-IUT as Master	Performs an SCO data-IUT as master test on the Bluetooth™ SIG Blue Unit Test Cases.
<More	Returns to the Bluetooth™ SIG Blue Unit Test Cases initial menu.

c. Telec

Radio Law

Telec	Displays the test menu of the TELEC.
Frequency Tolerance	Performs a frequency tolerance test.
OBW/Spread. BW	Performs an OBW/Spread.BW test.
Antenna Power	Performs an antenna power test.
Spurious Emission (Tx)	Performs a spurious emission (Tx) test.
Staying Time	Performs a staying time test.
Spurious Emission (Rx)	Performs a spurious emission (Rx) test.

d. Remote Loopback

Utility

Remote Loopback	Displays the menu related Remote Loopback.
SCO Loopback-IUT as Slave	Performs an SCO Loopback-IUT as Slave test.

3.3.2 Side Menu

SCO Loopback-IUT as Master

Performs an SCO Loopback-IUT as Master test.

RF Measurement

Displays the RF Measurement test menu.

Connection

Connects the R4870 to the IUT.

Disconnection

Disconnects the R4870 from the IUT.

Measure Item >

Displays the Measure Item menu.

FM Deviation

Measures the FM Deviation.

BER

Measures the BER.

< Connection Item

Displays the Connection Item menu.

e. System Setup

System Setup

Displays the test set up menu for the main system and IUT.

DC Source (ext)

Displays the setting menu of the DC power supply device.

RS-232 Port

Displays the HCI (Host Control Interface) settings menu.

IUT Information

Displays IUT Information dialog box menus.

Channel Number Assignment:

Selects either channel 79 or 23.

Power Class:

Selects the maximum RF transmission-power output class.

IUT Control:

Sets the control method of the IUT.
When the control is set to ON, use the RS-232 line on the R4870 rear panel as an HCI for the IUT.
When the control is set to OFF, the RS-232 is not used to control the IUT.

Select IUT Information Method:

Sets the Bluetooth Address acquisition method for the IUT.

IUT BD Address:

When the Select IUT Information Method is set to User Setting, input is enabled.

Support Packet:

When the Select IUT Information Method is set to User Setting, input is enabled.

System Configuration

Displays System Setup dialog box menus.

Setting item

RFCH1 External Cable Loss

RFCH2 External Cable Loss

Tx Signal Level

Tx Signal Modulation Index

Internal Signaling Unit 1 BD Address

Test Channel (Frequency or Channel)

Test Channel Low/Mid/High

10 MHz Reference

Comment Edit

The following comments can be added to the test data.

Unit Name

Lot Number

Device Number

Device Number Auto Increment

User Comment

f. Calibration

Calibration

Displays the signal transmission channel calibration menu.

Power Splitter

Calibrates the Power Splitter port.

Monitor2 port

Calibrates the IUT connection cable and the Monitor 2 port connection cable.

Monitor1 port

Calibrates the IUT connection cable and the Monitor 1 port connection cable.

CH1-Input

Calibrates the input communication channels to this equipment, including the IUT connection cable.

CH1-Output

Calibrates the output communication channels from this equipment, including the IUT connection cable.

Interfere1 port

Calibrates the IUT connection cable and the Interfere 1 port connection cable.

Interfere2 port

Calibrates the IUT connection cable and the Interfere 2 port connection cable.

3.3.2 Side Menu

- 2. Setup mode
 - a. SIG RF

SIG RF

Displays Bluetooth™ SIG RF Test Specification measurement set up menus. Select one of the following menus to set the configuration.

Item Select

Displays the test item selection menu.
This tab is used to switch the test condition screen.

NOTE: *The test conditions are displayed only when testing Bluetooth™ SIG RF Test Specifications.*

Set Default

The 18 item settings for the Bluetooth™ SIG RF Test Specification are set as the Default values.

Measurement Item ALL ON

Sets all Bluetooth™ SIG RF Test Specification test items to ON.

Measurement Item ALL OFF

Sets all Bluetooth™ SIG RF Test Specification test items to OFF.

Low Ch. ALL ON

Sets all the Bluetooth™ SIG RF Test Execute Ch. to Low.

Low Ch. ALL OFF

Removes all the Bluetooth™ SIG RF Test Execute Ch. Low settings.

Mid Ch. ALL ON

Sets all the Bluetooth™ SIG RF Test Execute Ch. to Mid.

Mid Ch. ALL OFF

Removes all the Bluetooth™ SIG RF Test Execute Ch. Mid settings.

High Ch. ALL ON

Sets all the Bluetooth™ SIG RF Test Execute Ch. to High.

High Ch. ALL OFF

Removes all the Bluetooth™ SIG RF Test Execute Ch. High settings.

PASS/FAIL Limit

Displays the PASS/FAIL limit settings menu.
This tab is used to switch the test condition screen.

NOTE: *The test conditions are displayed only when testing Bluetooth™ SIG RF Test Specifications.*

Output Power

Sets the Pass/Fail limit of the Output Power.

Power Density

Sets the Pass/Fail limit of the Power Density.

Power Control

Sets the Pass/Fail limit of the Power Control.

Frequency Range

Sets the Pass/Fail limit of the Frequency Range.

20dB Bandwidth

Sets the Pass/Fail limit of the 20dB Bandwidth.

Adjacent Channel Power

Sets the Pass/Fail limit of the Adjacent Channel Power.

Modulation Characteristics

Sets the Pass/Fail limit of the Modulation Characteristics.

Frequency Tolerance

Sets the Pass/Fail limit of the Frequency Tolerance.

Frequency Drift

Sets the Pass/Fail limit of the Frequency Drift.

Out-of-band Spurious Emissions

	Sets the Pass/Fail limit of the Out-of-band Spurious Emissions.
<i>Sensitivity-single slot packets</i>	Sets the Pass/Fail limit of the Sensitivity-single slot packets.
<i>Sensitivity-multi-slot packets</i>	Sets the Pass/Fail limit of the Sensitivity-multi-slot packets.
<i>C/I performance</i>	Sets the Pass/Fail limit of the C/I performance.
<i>Blocking performance</i>	Sets the Pass/Fail limit of the Blocking performance.
<i>Intermodulation performance</i>	Sets the Pass/Fail limit of the Intermodulation performance.
<i>Maximum Input Level</i>	Sets the Pass/Fail limit of the Maximum Input Level.

Test Parameter

Displays the test parameter settings menu.
This tab is used to switch the test condition screen.

NOTE: *The test conditions are displayed only when testing Bluetooth™ SIG RF Test Specifications.*

<i>Output Power</i>	Sets the test parameter of the Output Power.
<i>Power Density</i>	Sets the test parameter of the Power Density.
<i>Power Control</i>	Sets the test parameter of the Power Control.
<i>Frequency Range</i>	Sets the test parameter of the Frequency Range.
<i>20dB Bandwidth</i>	Sets the test parameter of the 20dB Bandwidth.
<i>Adjacent Channel Power</i>	Sets the test parameter of the Adjacent Channel Power.
<i>Modulation Characteristics</i>	Sets the test parameter of the Modulation Characteristics.
<i>Frequency Tolerance</i>	Sets the test parameter of the Frequency Tolerance.
<i>Frequency Drift</i>	Sets the test parameter of the Frequency Drift.
<i>Spurious Emissions (ETS)</i>	Sets the test parameter of the Spurious Emissions (ETS).
<i>Spurious Emissions (FCC)</i>	Sets the test parameter of the Spurious Emissions (FCC).
<i>Receiver Test (BER,PER)</i>	Sets the test parameter of the Receiver Test.
<i>Sensitivity-single/multi</i>	Sets the test parameter of the Sensitivity-single/multi.
<i>C/I performance</i>	Sets the test parameter of the C/I performance.
<i>Blocking performance</i>	Sets the test parameter of the Blocking performance.
<i>Intermodulation performance</i>	Sets the test parameter of the Intermodulation performance.
<i>Maximum Input Level</i>	Sets the test parameter of the Maximum Input Level.

LMP test control

	Sets the transmission condition of Bluetooth™ SIG RF measurement.
<i>Set Default All</i>	Reset all the Packet Type, Test scenario, and Poll Period to the Default value.
<i>Set Default Packets</i>	Resets the Packet Type to the Default value.
<i>Set Default Test scenario</i>	Rests the Test scenario to the Default value.

3.3.2 Side Menu

Set Default Poll Period Rests the Poll Period to the Default value.

b. Communication Test

Communication Test Displays Bluetooth™ SIG Blue Unit Test Cases dialog box menus.

Setting item

- Item Select
- Inquiry_Length
- Page_Scan_Repetition_Mode
- Packet_Type
- Payload_Body
- Link_Supervision_Timeout
- PIN_Code

Set Default The 7 item settings for the Bluetooth™ SIG Blue Unit Test Cases are set as the Default values.

Item ALL ON Sets all Bluetooth™ SIG Blue Unit Test Cases test items to ON.

Item ALL OFF Sets all Bluetooth™ SIG Blue Unit Test Cases test items to OFF.

c. Telec

Radio Law

Telec Displays the Setup menus related to the TELEC test. Select one of the following menus to set the configuration.

Set Default The 6 item settings for the TELEC are set as the Default values.

Measurement Item ALL ON
Sets all Telec test items to ON.

Measurement Item ALL OFF
Sets all Telec test items to OFF.

Low Ch. ALL ON Sets all the Telec test execute channels to Low.

Low Ch. ALL OFF Releases all of the Low settings of the Telec test execute channels.

Mid Ch. ALL ON Sets all the Telec test execute channels to Mid.

Mid Ch. ALL OFF Releases all of the Mid settings of the Telec test execute channels.

High Ch. ALL ON Sets all the Telec test execute channels to High.

High Ch. ALL OFF Releases all of the High settings of the Telec test execute channels.

d. Utility

Utility

Remote Loopback Displays the SCO Loopback Setup menu.

Set Default The 4 item settings for the SCO Loopback are set as the Default

	values.
	Setting item SCO Loopback-IUT as Slave SCO Loopback-IUT as Master SCO Packet Type IUT Voice Setting
RF Measurement	Displays the RF Measurement menu.
PASS/FAIL Limit	Displays the PASS/FAIL limit settings menu. This tab is used to switch the test condition screen.
<hr/>	
	NOTE: <i>The test conditions are displayed only when testing RF Measurement for Utility.</i>
<hr/>	
FM Deviation	Sets the Pass/Fail limit of the FM Deviation.
BER	Sets the Pass/Fail limit of the BER.
Test Parameter	Displays the test parameter settings menu. This tab is used to switch the test condition screen.
<hr/>	
	NOTE: <i>The test conditions are displayed only when testing RF Measurement for Utility.</i>
<hr/>	
FM Deviation	Sets the test parameter of the FM Deviation.
BER	Sets the test parameter of the BER.
e. System Setup	
System Setup	Displays the test set up menu for the main system and IUT.
DC Source (ext)	Displays the setting menu for the DC power supply equipment.
RS-232 Port	Displays the HCI (Host Control Interface) settings menu.
IUT Information	Displays IUT Information dialog box menus.
	Channel Number Assignment: Selects either channel 79 or 23.
	Power Class: Selects the maximum RF transmission-power output class.
	IUT Control: Sets the control method of the IUT. When the control is set to ON, use the RS-232 line on the R4870 rear panel as an HCI for the IUT. When the control is set to OFF, the RS-232 is not used to control the IUT.
	Select IUT Information Method: Sets the Bluetooth Address acquisition method for the IUT.
	IUT BD Address: When the Select IUT Information Method is set to User Setting, input is enabled.

3.3.2 Side Menu

	Support Packet:	When the Select IUT Information Method is set to User Setting, input is enabled.
<i>System Configuration</i>	Displays System Setup dialog box menus.	
	Setting item	
		RFCH1 External Cable Loss
		RFCH2 External Cable Loss
		Tx Signal Level
		Tx Signal modulation Index
		Internal Signaling Unit 1 BD Address
		Test Channel (Frequency or Channel)
		Test Channel Low/Mid/High
		10 MHz Reference
<i>Comment Edit</i>	The following comments can be added to the test data.	
	Unit Name	
	Lot Number	
	Device Number	
	Device Number Auto Increment	
	User Comment	
f. Calibration		
<i>Calibration</i>	Displays the test set up menu for the main system and IUT.	
<i>Set Default</i>	Sets the seven system calibration items to their Default values.	
<i>Item ALL ON</i>	Sets the seven system calibration items to ON.	
<i>Item ALL OFF</i>	Sets the seven system calibration items to OFF.	

3.4 Bluetooth SIG RF Test Items and Passing Ranges

1. RF port - CH 1

Table 3-1 Bluetooth SIG RF Test Items and Passing Ranges - CH 1 (1 of 2)

Specification	Test item	Setting range		Note-1	Note-2
TRM/CA/01/C	Output power	Average Power	+25 dBm to -33 dBm	Same for class 1 - 3	
		Peak Power	+25 dBm to -30 dBm		
TRM/CA/02/C	Power Density	Power Density	+25 dBm to -30 dBm		
TRM/CA/03/C	Power Control	Power Control	1 dB to 10 dB		
		Power Minimum	+25 dBm to -30 dBm		
TRM/CA/04/C	Frequency Range	FL:US/Europe/Japan	2400 MHz to 2402 MHz		
		FH:US/Europe/Japan	2480 MHz to 2483.5 MHz		
		FL:France	2446.5 MHz to 2454 MHz		
		FH:France	2476 MHz to 2483.5 MHz		
TRM/CA/05/C	20dB Bandwidth	20dB Bandwidth	0.1 MHz to 2.0 MHz		
TRM/CA/06/C	Adjacent Channel Power	$ M-N = 2$	-20 dBm to -55 dBm		
		$ M-N \geq 3$	-40 dBm to -60 dBm		
TRM/CA/07/C	Modulation Characteristics	Δf_{1_avg}	0 kHz to 300 kHz		
		Δf_{2_max}	0 kHz to 300 kHz		
		Δf_{2_avg}		Only display	
		PASS/All Δf_{2_max}	0% to 100%		
		Ratio ($\Delta f_{2_avg}/\Delta f_{1_avg}$)	0 to 1.0		
TRM/CA/08/C	Initial Carrier Frequency Tolerance	Initial Carrier Frequency Tolerance	0 kHz to 300 kHz		
TRM/CA/09/C	Carrier Frequency Drift	DH1 Drift	0 kHz to 300 kHz		
		DH3 Drift	0 kHz to 300 kHz		
		DH5 Drift	0 kHz to 300 kHz		
TRC/CA/01/C	Out of Band Spurious Emission				
		ETS	30 MHz to 1 GHz	0 dBm to -65 dBm	Operation Standby (Narrow)
		ETS	1 GHz to 12.75 GHz	0 dBm to -65 dBm	
		ETS	1.8 GHz to 1.9 GHz	0 dBm to -65 dBm	
		ETS	5.15 GHz to 5.3 GHz	0 dBm to -65 dBm	
		ETS	30 MHz to 1 GHz	0 dBm/Hz to -115 dBm/Hz	Operation Standby (Wide)
		ETS	1 GHz to 12.75 GHz	0 dBm/Hz to -115 dBm/Hz	
		ETS	1.8 GHz to 1.9 GHz	0 dBm/Hz to -115 dBm/Hz	
ETS	5.15 GHz to 5.3 GHz	0 dBm/Hz to -115 dBm/Hz			
FCC	30 MHz to 25 GHz	0 dB to 45 dB			

3.4 Bluetooth SIG RF Test Items and Passing Ranges

Table 3-1 Bluetooth SIG RF Test Items and Passing Ranges - CH 1 (2 of 2)

Specification	Test item	Setting range		Note-1	Note-2
RCV/CA/01/C	Sensitivity-single slot packets	BER	0% to 100%	Resolution 0.0001%	
RCV/CA/02/C	Sensitivity-multi-slot packets	BER	0% to 100%	Resolution 0.0001%	
RCV/CA/03/C	C/I Performance	BER	0% to 100%	Resolution 0.0001%	
RCV/CA/04/C	Blocking Performance	BER	0% to 100%	Resolution 0.0001%	
RCV/CA/05/C	Intermodulation Performance	BER	0% to 100%	Resolution 0.0001%	
RCV/CA/06/C	Maximum Input Level	BER	0% to 100%	Resolution 0.0001%	

2. RF port - CH 2

Table 3-2 Bluetooth SIG RF Test Items and Passing Ranges - CH 2

Specification	Test item	Setting range		Note-1	Note-2
TRM/CA/01/C	Output power	Average Power	+8 dBm to -50 dBm	Same for class 1 - 3	
		Peak Power	+8 dBm to -50 dBm		
TRM/CA/07/C	Modulation Characteristics	$\Delta f_{1\text{avg}}$	0 kHz to 300 kHz		
		$\Delta f_{2\text{max}}$	0 kHz to 300 kHz		
		$\Delta f_{2\text{avg}}$		Only display	
		PASS/All $\Delta f_{2\text{max}}$	0% to 100%		
		Ratio ($\Delta f_{2\text{avg}}/\Delta f_{1\text{avg}}$)	0 to 1.0		
TRM/CA/08/C	Initial Carrier Frequency Tolerance	Initial Carrier Frequency Tolerance	0 kHz to 300 kHz		
TRM/CA/09/C	Carrier Frequency Drift	DH1 Drift	0 kHz to 300 kHz		
		DH3 Drift	0 kHz to 300 kHz		
		DH5 Drift	0 kHz to 300 kHz		

3.5 Pass/Fail Evaluation of the Bluetooth SIG RF Test

This section describes the pass/fail evaluation of the Bluetooth SIG RF test.

Table 3-3 Pass/Fail Evaluation of the Bluetooth SIG RF Test (1 of 2)

Specification	Test item	Target item	Pass/ Fail evaluation
TRM/CA/01/C	Output Power	Average Power	The measurement result is determined by the Average Power passing range of the Power Class set in IUT Information and the Power Class set in Pass/Fail Limit.
		Peak Power	The measurement result is determined by the Peak Power passing range set in Pass/Fail Limit.
TRM/CA/02/C	Power Density	Power Density	The measurement result is determined by the Power Density passing range set in Pass/Fail Limit.
TRM/CA/03/C	Power Control	Step Size	The measurement result is determined by the Step Size passing range set in Pass/Fail Limit.
		Minimum Power	When the Power Class set in IUT Information is set to 1, the measurement result is determined by the Minimum Power passing range set in Pass/Fail Limit.
TRM/CA/04/C	Frequency Range	FL	The measurement result is determined by the Channel Number Assignment setting, which is set in IUT Information, and the Lowest Frequency passing range, which is set in Pass/Fail Limit.
		FH	The measurement result is determined by the Channel Number Assignment setting, which is set in IUT Information, and the Highest Frequency passing range, which is set in Pass/Fail Limit.
TRM/CA/05/C	20dB Bandwidth	20dB Bandwidth	The measurement result is determined by the 20 dB bandwidth passing range set in Pass/Fail Limit.
TRM/CA/06/C	Adjacent Channel Power	$ M-N = 2$	The measurement result is determined by the power passing range of $ M-N = 2$ set in Pass/Fail Limit.
		$ M-N \geq 3$	The measurement result is determined by the power passing range of $ M-N \geq 3$ set in Pass/Fail Limit. However, if the measurement result is between the set value and -20 dBm, up to three Fails are allowed in the final evaluation before the IUT fails. (Note 1)
TRM/CA/07/C	Modulation Characteristics	$\Delta f_{1_{avg}}$	The measurement result is determined by the $\Delta f_{1_{avg}}$ passing range set in Pass/Fail Limit.
		$\Delta f_{2_{max}}$	The measurement result is determined by the $\Delta f_{2_{max}}$ passing range set in Pass/Fail Limit. However, the final result depends on the Pass/All $\Delta f_{2_{max}}$ result.
		Pass/All $\Delta f_{2_{max}}$	The measurement result is determined by the Pass/All $\Delta f_{2_{max}}$ passing range set in Pass/Fail Limit.
		$\Delta f_{2_{avg}}/\Delta f_{1_{avg}}$	The measurement result is determined by the $\Delta f_{2_{avg}}/\Delta f_{1_{avg}}$ passing range set in Pass/Fail Limit.
TRM/CA/08/C	Initial Carrier Frequency Tolerance	Initial Carrier Frequency Tolerance	The measurement result is determined by the Initial Carrier Frequency Tolerance passing range set in Pass/Fail Limit.

3.5 Pass/Fail Evaluation of the Bluetooth SIG RF Test

Table 3-3 Pass/Fail Evaluation of the Bluetooth SIG RF Test (2 of 2)

Specification	Test item	Target item	Pass/ Fail evaluation
TRM/CA/09/C	Carrier Frequency Drift	DH1 Drift	The measurement result is determined by the DH1 Drift passing range set in Pass/Fail Limit.
		DH3 Drift	The measurement result is determined by the DH3 Drift passing range set in Pass/Fail Limit.
		DH5 Drift	The measurement result is determined by the DH5 Drift passing range set in Pass/Fail Limit.
		Drift Rate	The measurement result is determined by the Drift Rate passing range set in Pass/Fail Limit.
TRC/CA/01/C	Out of Band spurious Emissions (ETS)	Spurious	The measurement result is determined by the Spurious Level passing range set in Pass/Fail Limit. (Note 2)
	Out of Band spurious Emissions (FCC)	$P_{ref} - P_{pk}$	The measurement result is determined by the $P_{ref} - P_{pk}$ passing range set in Pass/Fail Limit.
RCV/CA/01/C	Sensitivity-single slot packets	BER	The measurement result is determined by the BER passing range set in Pass/Fail Limit.
RCV/CA/02/C	Sensitivity-multi-slot packets	BER	The measurement result is determined by the BER passing range set in Pass/Fail Limit.
RCV/CA/03/C	C/I Performance	BER	The measurement result is determined by the BER passing range set in Pass/Fail Limit. (Note 3)
RCV/CA/04/C	Blocking Performance	BER	The measurement result is determined by the BER passing range set in Pass/Fail Limit. (Note 4)
RCV/CA/05/C	Intermodulation Performance	BER	The measurement result is determined by the BER passing range set in Pass/Fail Limit.
RCV/CA/06/C	Maximum Input Level	BER	The measurement result is determined by the BER passing range set in Pass/Fail Limit.

NOTE:

1. *Applies only when the Test Method is set to Standard. If the Test Method is set to High Speed, the result is determined by only the value set in Pass/Fail Limit. Note that if the measurement is performed in Standard by setting 3 or fewer measurement channels, the measurement result may be incorrect.*
2. *If the searched spurious level is [Pass/Fail limit value - 6 dB or greater], perform the measurement by setting the SPA to the Wideband mode. If the spurious level does not change by 2 dB or more, the result is the Narrowband Spurious. If the spurious level changes by 2 dB or more, the result is the Wideband Spurious.*
3. *If a Fail result occurs at a point, which is 2 MHz or greater away from the measurement frequency, set the SG output level to the value set in Relaxed in Pass/Fail Limit and then perform the measurement. Even if a Pass result occurs at this point, if 6 or more Fail results occur in Normal, the final result is Fail. In addition, if Fail results occur at the Co-Channel point and the point, which is 1 MHz away from the Co-Channel, the final result is Fail regardless of the number of Fails at the point which is 2 MHz away from the Co-Channel.*
4. *A maximum of 24 Fails is allowed in the level 1 measurement. If 25 or more Fail result occur, the final result is Fail. Only the frequencies that failed at level 1 are measured at level 2 and a maximum of 5 Fails is allowed here. Therefore, if 6 or more Fail results occur here, the final result is Fail. Only the frequencies that failed at level 2 are measured at level 3. If a Fail result occurs here, the final result is Fail.*

4. TEST METHODS

This chapter describes internal system operations which perform the Bluetooth SIG RF tests and TELEC RF tests.

Each section in this chapter explains one of the 22 tests that the system performs.

1. SIG RF

- Output Power
- Power Density
- Power Control
- TX Output Spectrum - Frequency Range
- TX Output Spectrum - 20dB Bandwidth
- TX Output Spectrum - Adjacent Channel Power
- Modulation Characteristics
- Initial Carrier Frequency Tolerance
- Carrier Frequency Drift
- Out-of-band Spurious Emissions
- Sensitivity - Single slot packets
- Sensitivity - Multi-slot packets
- C/I performance
- Blocking performance
- Intermodulation performance
- Maximum Input Level

2. Telec test

- Frequency Tolerance
- Occupied Frequency Bandwidth / Spread Bandwidth
- Tolerance of Antenna Power
- Spurious Emission Strength
- Staying Time
- Secondarily Emitted Radio Wave Strength

4.1 SIG RF

4.1 SIG RF

4.1.1 Output Power

The Bluetooth IUT transmission output is measured under the following conditions.

1. Transmission conditions

Standard mode (measured by using the R3273)

- Hopping: ON
- Test mode: ON
- Loopback Mode
- Payload: PRBS 9
- Packet type: DH1, DH3, or DH5 is selected and measured.

High speed mode (measured by using the R4870)

- Hopping: OFF
- Test mode: ON
- TX Mode or Loopback Mode
- Payload: PRBS 9
- Packet type: DH1, DH3, or DH5 is selected and measured.
- Received frequency: For more information on this setting, refer to Test Channel in Section 2.4.3, "Setting System Configuration" of R4870 Operation Manual.

2. Measurement items

- Average Power
- Peak Power

NOTE: Average powers and peak powers of DH1, DH3, and DH5 packet types transmission burst waveforms that are 20% or less and 80% or higher*1 are measured.

*1:

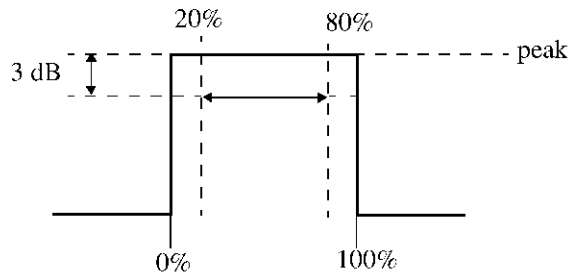

4.1.2 Power Density

The Bluetooth IUT power density is measured under the following conditions.

1. Transmission conditions
 - Hopping: ON
 - Test mode: ON
 - Loopback Mode
 - Payload: PRBS 9
 - Packet type: DH1, DH3, or DH5 is selected and measured.
2. Measurement items
 - Power Density

4.1.3 Power Control

The Bluetooth IUT output control is measured under the following conditions.

1. Transmission conditions
 - Hopping: OFF
 - Test mode: ON
 - TX Mode or Loopback Mode
 - Payload: PRBS 9
 - Packet type: DH1, DH3, or DH5 is selected and measured.
 - Power Control mode
 - Received frequency: For more information on this setting, refer to Test Channel in Section 2.4.3, “Setting System Configuration” of R4870 Operation Manual.
2. Measurement items
 - Step size of power control
 - Minimum power (Class 1)

NOTE: *To measure in the Standard mode, use the R3273. To measure in the High Speed mode, use the R4870.*

4.1.4 TX Output Spectrum - Frequency Range

4.1.4 TX Output Spectrum - Frequency Range

The Bluetooth IUT output spectrum frequency range is measured under the following conditions.

1. Transmission conditions
 - Hopping: OFF
 - Test mode: ON
 - Loopback Mode
 - Payload: PRBS 9
 - Packet type: DH1, DH3, or DH5 is selected and measured.
 - Received frequency: When measuring the lowest frequency, the received frequency is the highest frequency. When measuring the highest frequency, the received frequency is the lowest frequency.
2. Measurement items
 - Frequency Range

4.1.5 TX Output Spectrum - 20dB Bandwidth

The Bluetooth IUT output spectrum 20 dB bandwidth is measured under the following conditions.

1. Transmission conditions
 - Hopping: OFF
 - Test mode: ON
 - Loopback Mode
 - Payload: PRBS 9
 - Packet type: DH1, DH3, or DH5 is selected and measured.
 - Received frequency: For more information on this setting, refer to Test Channel in Section 2.4.3, "Setting System Configuration" of R4870 Operation Manual.

NOTE: *If the received frequency and the transmission frequency are the same, or if the received frequency is set to the adjacent frequency (1 MHz or 2 MHz), this may cause incorrect test results.*

2. Measurement items
 - 20dB Bandwidth

4.1.6 TX Output Spectrum - Adjacent Channel Power

The Bluetooth IUT output spectrum adjacent channel power is measured under the following conditions.

1. Transmission conditions

- Hopping: OFF
- Test mode: ON
- Loopback Mode
- Payload: PRBS 9
- Packet type: DH1, DH3, or DH5 is selected and measured.
- Received frequency: The received frequency, which avoids the measurement point, is set.

NOTE: The test frequency setting range is from 2405 MHz to 2477 MHz.

2. Measurement items

- Adjacent Channel Power

4.1.7 Modulation Characteristics

The Bluetooth IUT modulation characteristics are measured under the following conditions.

For more information on the communication conditions and measurement items, refer to Section 4.2, Modulation Characteristics of R4870 Operation Manual.

4.1.8 Initial Carrier Frequency Tolerance

The Bluetooth IUT initial carrier frequency tolerance is measured under the following conditions.

For more information on the communication conditions and measurement items, refer to Section 4.3, Initial Carrier Frequency Tolerance of R4870 Operation Manual.

4.1.9 Carrier Frequency Drift

The Bluetooth IUT carrier frequency drift is measured under the following conditions.

For more information on the communication conditions and measurement items, refer to Section 4.4, Carrier Frequency Drift of R4870 Operation Manual.

4.1.10 Out-of-Band Spurious Emissions

4.1.10 Out-of-Band Spurious Emissions

The Bluetooth IUT out -of -band spurious emissions are measured under the following conditions.

1. Transmission conditions

- Hopping: OFF
- Test mode: ON
- Loopback Mode
- Payload: PRBS 9
- Packet type: DH1, DH3, or DH5 is selected and measured.
- Received frequency: The received frequency, which will not affect the measurement results, is set.

Standby Mode

- Inquiry Scan Mode

2. Measurement items

- Spurious Emissions (operation mode narrow; ETS)
- Spurious Emissions (standby mode narrow; ETS)
- Spurious Emissions (operation mode wide; ETS)
- Spurious Emissions (standby mode wide; ETS)
- Spurious Emissions (operation mode; FCC)

4.1.11 Sensitivity (single slot packets)

The Bluetooth IUT sensitivity (single slot packets) is measured under the following conditions.

For more information on the communication conditions and measurement items, refer to Section 4.5, Sensitivity (single slot packets) of R4870 Operation Manual.

4.1.12 Sensitivity (multi-slot packets)

The Bluetooth IUT sensitivity (multi-slot packets) is measured under the following conditions.

For more information on the communication conditions and measurement items, refer to Section 4.6, Sensitivity (multi-slot packets) of R4870 Operation Manual.

4.1.13 C/I performance

The Bluetooth IUT C/I performance is measured under the following conditions.

1. Transmission conditions

- Hopping: OFF
- Test mode: ON
- Loopback Mode
- Payload: PRBS 9
- Packet type: DH1, DH3, or DH5 is selected and measured.
- Verification bit number: 1600000 bits (NOTE 1)
- Wanted signal level: -60 dBm Interference wave: Co-channel, 1 MHz, 2 MHz (NOTE 2)
-67 dBm Interference wave: ≥ 3 MHz, Image (NOTE 2)
- Transmission frequency: The transmission frequency is the same as the received (test) frequency. For more information on this setting, refer to Test Channel in Section 2.4.3, "Setting System Configuration" of R4870 Operation Manual.

NOTE:

1. *The verification bit number for the High Speed mode or Standard mode internal test method can be set to any number within the following ranges.
High Speed mode: 1 to 1600000 bits
Standard mode: 1600000 to 9999999 bits*
 2. *Wanted signal level information can be changed using the following.
The C/I Wanted Signal Level (IUT Input Level) in the SIG Test Parameter setting.*
 3. *The wanted signal frequency setting range is 2405 MHz to 2477 MHz.*
-

2. Interference wave

- Modulation: Bluetooth Modulated Signal
- Frequency: Co-channel, Adjacent (1 MHz, 2 MHz, ≥ 3 MHz)
Image (2402 MHz to 2480 MHz)

NOTE: *The interference wave supply level to the IUT can be set in the C/I Interfere Signal Level in the SIG Test Parameter.*

3. Measurement items

- BER (Bit Error Rate)
- PER (Packet Error Rate)

4.1.14 Blocking performance

4.1.14 Blocking performance

The Bluetooth IUT blocking performance is measured under the following conditions.

1. Transmission conditions

- Hopping: OFF
- Test mode: ON
- Loopback Mode
- Payload: PRBS 9
- Packet type: DH1, DH3, or DH5 is selected and measured.
- Verification bit number: 1600000 bits (NOTE 1)
- Wanted signal level: -67 dBm (NOTE 2)
- Transmission frequency: Fixed at 2460 MHz. (identical to the received frequency)

NOTE:

1. *The verification bit number for the High Speed mode or Standard mode internal test method can be set to any number within the following ranges.
High Speed mode: 1 to 1600000 bits
Standard mode: 1600000 to 9999999 bits*
 2. *Wanted signal level information can be changed using the following.
The Blocking Wanted Signal Level (IUT Input Level) in the SIG Test Parameter setting.*
-

2. Interference wave

- Modulation: Continuous Wave Signal (No modulated)
- Frequency: 30 MHz to 2 GHz, 2 GHz to 2.4 GHz, 2.5 GHz to 3 GHz)
3 GHz to 12.75 GHz

NOTE: *The interference wave supply level to the IUT can be set in the Blocking Interfere Signal Level in the SIG Test Parameter.*

3. Measurement items

- BER (Bit Error Rate)
- PER (Packet Error Rate)

4.1.15 Intermodulation performance

The Bluetooth IUT intermodulation performance is measured under the following conditions.

1. Transmission conditions

- Hopping: OFF
- Test mode: ON
- Loopback Mode
- Payload: PRBS 9
- Packet type: DH1, DH3, or DH5 is selected and measured.
- Verification bit number: 1600000 bits (NOTE 1)
- Wanted signal level: -64 dBm (NOTE 2)
- Transmission frequency: The transmission frequency is the same as the received (test) frequency. For more information on this setting, refer to Test Channel in Section 2.4.3, “Setting System Configuration” of R4870 Operation Manual.

NOTE:

1. *The verification bit number for the High Speed mode or Standard mode internal test method can be set to any number within the following ranges.
High Speed mode: 1 to 1600000 bits
Standard mode: 1600000 to 9999999 bits*
 2. *Wanted signal level information can be changed using the following.
The Intermodulation Wanted Signal Level (IUT Input Level) in the SIG Test Parameter setting.*
-

2. Interference wave

- Modulation: Continuous Wave Signal (Interference wave 1: f1)
Bluetooth Modulated Signal (Interference wave 2: f2)
- Frequency: f1 = ftx ±n MHz
f2 = ftx ±2n MHz
(ftx: Wanted Signal Frequency [MHz], n: 3, 4, 5)

NOTE: *The interference wave supply level to the IUT can be set in the Intermodulation Interfere Signal Level in the SIG Test Parameter.*

3. Measurement items

- BER (Bit Error Rate)
- PER (Packet Error Rate)

4.1.16 Maximum Input Level

The Bluetooth IUT maximum input level is measured under the following conditions.

For more information on the communication conditions and measurement items, refer to Section , “Maximum Input Level” of R4870 Operation Manual.

4.2 Telec Test

4.2 Telec Test

4.2.1 Frequency Tolerance

The Bluetooth IUT frequency tolerance is measured under the following conditions.

1. Transmission conditions

- Hopping: OFF
- Test mode: ON
- Loopback Mode
- Payload: PRBS 9
- Packet type: DH1, DH3, or DH5 with the longest support.
- Received frequency: For more information on this setting, refer to Test Channel in Section 2.4.3, “Setting System Configuration” of R4870 Operation Manual.

NOTE: If the received frequency and the transmission frequency are the same, or if the received frequency is set to the adjacent frequency (1 MHz or 2 MHz), this may cause incorrect test results.

2. Measurement items

- Frequency Tolerance

4.2.2 Occupied Frequency Bandwidth / Spread Bandwidth

The Bluetooth IUT OBW/spread bandwidth is measured under the following conditions.

1. Transmission conditions

- Hopping: ON and OFF
- Test mode: ON
- TX Mode
- Payload: PRBS 9
- Packet type: DH1, DH3, or DH5 with the longest support.

2. Measurement items

- Occupied Frequency Bandwidth
- Spread Bandwidth (Hopping On)
- Spread Bandwidth (Hopping Off)

4.2.3 Tolerance of Antenna Power

The Bluetooth IUT tolerance of antenna power is measured under the following conditions.

1. Transmission conditions
 - Hopping: OFF
 - Test mode: ON
 - TX Mode
 - Payload: PRBS 9
 - Packet type: DH1, DH3, or DH5 with the longest support.
2. Measurement items
 - Output Power (Average)
 - Antenna Power
 - Tolerance of Antenna Power

4.2.4 Spurious Emission Strength

The Bluetooth IUT spurious emission strength is measured under the following conditions.

1. Transmission conditions
 - Hopping: OFF
 - Test mode: ON
 - TX Mode
 - Payload: PRBS 9
 - Packet type: DH1, DH3, or DH5 with the longest support.
2. Measurement items
 - Spurious Emission Strength

4.2.5 Staying Time

The Bluetooth IUT staying time is measured under the following conditions.

1. Transmission conditions
 - Hopping: ON
 - Test mode: ON
 - Loopback Mode
 - Payload: PRBS 9
 - Packet type: DH1, DH3, or DH5 with the longest support.
2. Measurement items
 - Staying Time

4.2.6 Secondarily Emitted Radio Wave Strength

4.2.6 Secondarily Emitted Radio Wave Strength

The strength of the Bluetooth IUT secondarily emitted radio wave is measured under the following conditions.

1. Transmission conditions
 - Inquiry Scan Mode
2. Measurement items
 - Secondarily Emitted Radio Wave Strength

5. CALIBRATION

This section describes how to calibrate the following (seven) items of the R4870 OPT01 GPIB-Master.

1. Power Splitter
2. Monitor2 port
3. Monitor1 port
4. CH1-Input
5. CH1-Output
6. Interfere1 port
7. Interfere2 port

5.1 Calibration Setting Procedure

Click **Mode** on the main menu and select **Function Select** → **Calibration**.

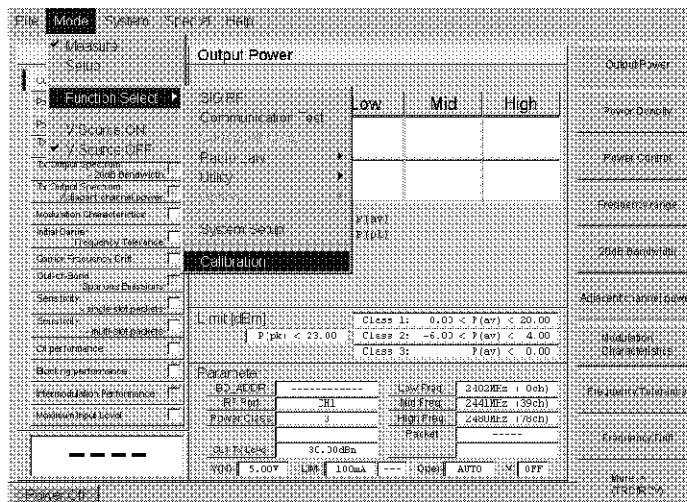

Figure 5-1 Shifting to Calibration Setting

Click **Mode** on the main menu on the Calibration screen and select **Setup** from the drop down menu (See Figure 5-2).

5.1 Calibration Setting Procedure

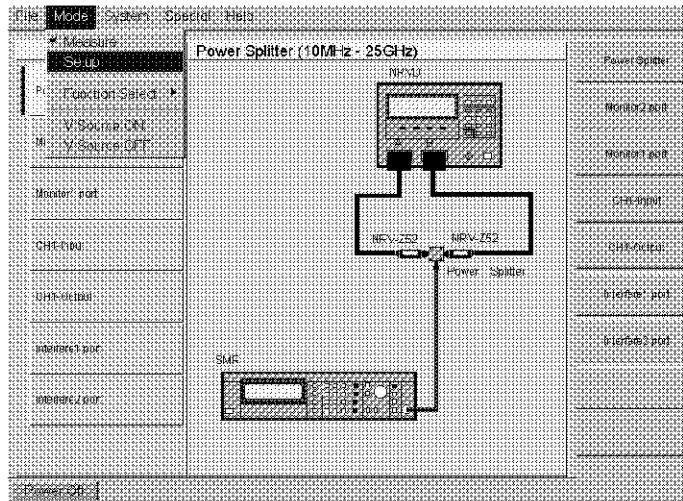

Figure 5-2 Shifting to the Calibration Setup Screen

The Calibration Setup screen is displayed. Select items for calibration.

(A check appears in the checkbox to the left of each selected item.)

To calibrate all items, click **Item ALL ON**. All checkboxes are marked with a check.

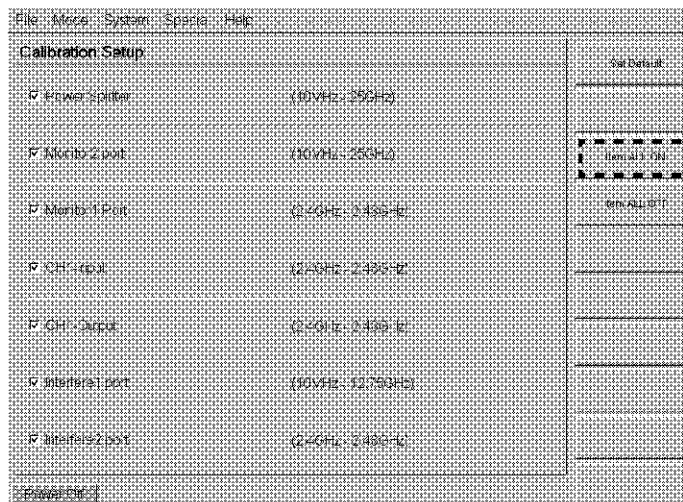

Figure 5-3 Calibration Setup

If **Measure** is selected from the drop down menu after setup is complete, the screen switches to the calibration execution screen.

5.2 Power Splitter Calibration

If the screen is switched to the Power Splitter calibration screen, connection diagram is displayed on the screen. Connect cables according to the diagram.

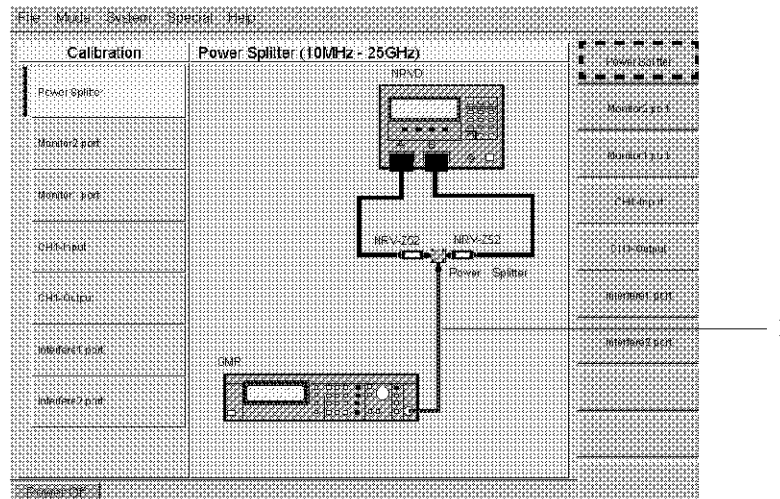

Figure 5-4 Power Splitter Calibration

The signal cable between the SMR and the Power Splitter is shown below.

1. SMR: RF Port → R4870: Interfere1 port connection cable

The Power Splitter is necessary to calibrate the system.

Calibrate the power splitter before calibrating any other item.

(If not executed, each item is calibrated by the default Power Splitter calibration data.)

NOTE: The supplied Power Splitter is a female 3.5 mm connector. Although it fits to SMA or the 2.92 mm connectors, forced connection as shown below may cause damage.

1. Mis-aligning the connectors and connecting.
 2. Abrasion of the center contact caused by turning the cable instead of the fixing nut when connecting.
-

If **SINGLE** is pressed after connection is complete, the message box, which confirms the cable connection is complete, is displayed. Pressing **OK** starts calibration.

NOTE: If **OK** is pressed while a connection is incorrect, calibration cannot be complete. Check the connection and perform the calibration.

5.2 Power Splitter Calibration

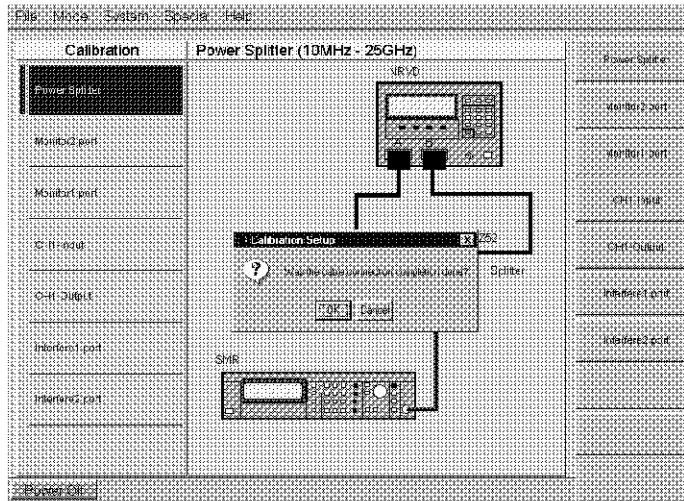

Figure 5-5 Message Confirming the Completion of Connection

NOTE: *If an error occurs, refer to Section A.2, “Error Messages.”*

When calibration is complete, the Calibration Completed message box is displayed. This confirms whether or not the previously acquired calibration data should be replaced by the newly acquired calibration data. Press **OK** to replace the previously acquired calibration data.

If **Cancel** is pressed, the program is terminated without replacing the previously acquired calibration data.

5.3 Monitor2 Port Calibration

The path, which includes signal cables between RF IN/OUT CH1 and Monitor2 port, is calibrated here. (Terminate all RF ports (excluding the RF ports mentioned above) by using 50 Ω terminators.)

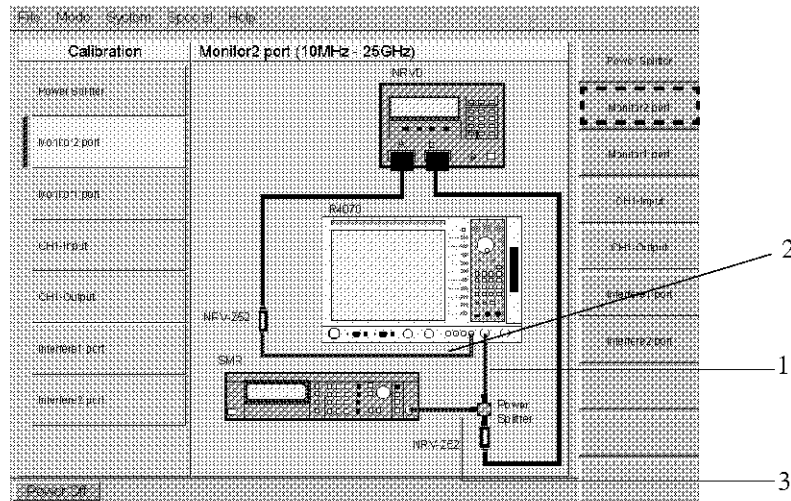

Figure 5-6 Monitor2 Port Calibration

RF cables, which are used in calibration, are shown below (See Figure 5-6).

1. R4870: RF IN/OUT CH1 → IUT connection cable
2. R4870: Monitor2 port → R3273: Input 50 Ω connection cable
3. SMR: RF Port → R4870: Interfere1 port connection cable

If **SINGLE** is pressed after connection is complete, the Calibration Setup message box is displayed. After confirming connection is complete, click **OK** to perform calibration.

NOTE:

1. If **OK** is pressed while a connection is incorrect, calibration cannot be complete. Check the connection and perform the calibration.
 2. If an error occurs, refer to Section A.2, "Error Messages."
-

When calibration is complete, the Calibration Completed message box is displayed. This confirms whether or not the previously acquired calibration data should be replaced by the newly acquired calibration data. Press **OK** to replace the previously acquired data.

If **Cancel** is pressed, the program is terminated without replacing the previously acquired calibration data.

5.4 Monitor1 Port Calibration

5.4 Monitor1 Port Calibration

The path, which includes signal cables between RF IN/OUT CH1 and Monitor1 port, is calibrated here. (Terminate all RF ports (excluding the RF ports mentioned above) by using 50 Ω terminators.)

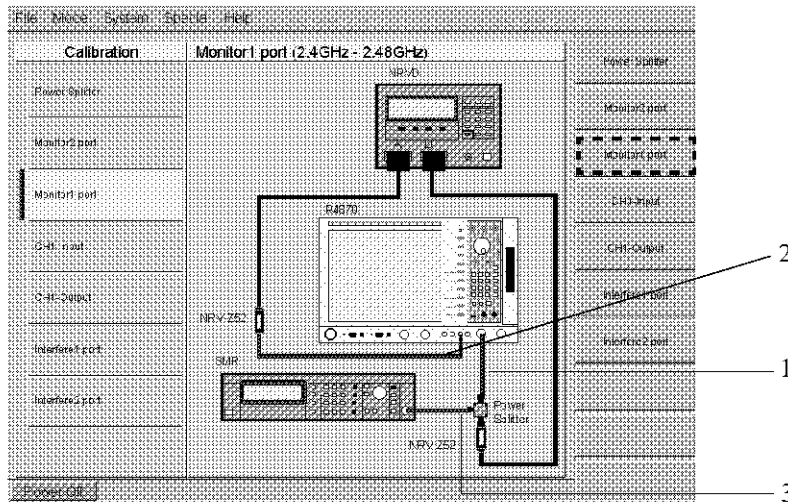

Figure 5-7 Monitor1 Port Calibration

RF cables, which are used in calibration, are shown below (See Figure 5-7).

1. R4870: RF IN/OUT CH1 → IUT connection cable
2. R4870: Monitor1 port → NRV-Z52 connection cable
3. SMR: RF Port → R4870: Interfere1 port connection cable

If **SINGLE** is pressed after connection is complete, the Calibration Setup message box is displayed. After confirming connection is complete, click **OK** to perform calibration.

NOTE:

1. If **OK** is pressed while a connection is incorrect, calibration cannot be complete. Check the connection and perform the calibration.
2. If an error occurs, refer to Section A.2, "Error Messages."

When calibration is complete, the Calibration Completed message box is displayed. This confirms whether or not the previously acquired calibration data should be replaced by the newly acquired calibration data. Press **OK** to replace the previously acquired data.

If **Cancel** is pressed, the program is terminated without replacing the previously acquired calibration data.

5.5 CH1-Input Calibration

The path, which includes the RF IN/OUT CH1 signal cable, is calibrated here.

(Terminate all RF ports (excluding the RF port mentioned above) by using 50 Ω terminators.)

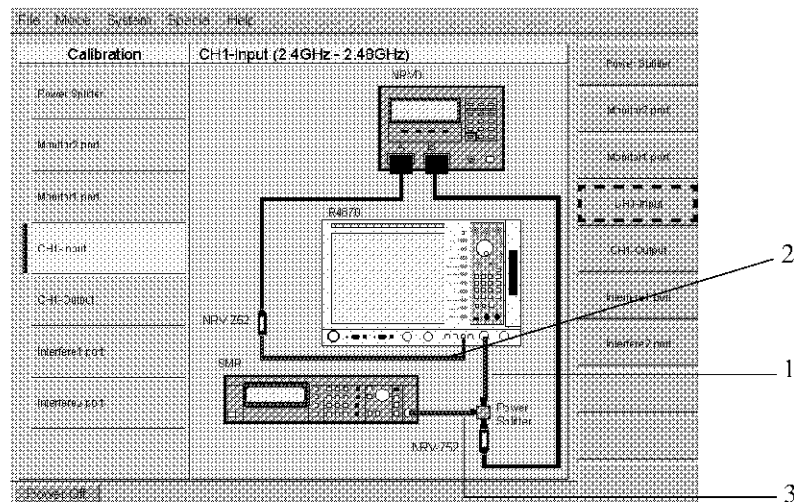

Figure 5-8 CH1-Input Calibration

RF cables, which are used in calibration, are shown below (See Figure 5-8).

1. R4870: RF IN/OUT CH1 → IUT connection cable
2. R4870: Monitor1 port → NRV-Z52 connection cable
3. SMR: RF Port → R4870: Interfere1 port connection cable

If **SINGLE** is pressed after connection is complete, the Calibration Setup message box is displayed. After confirming connection is complete, click **OK** to perform calibration.

NOTE:

1. If **OK** is pressed while a connection is incorrect, calibration cannot be complete. Check the connection and perform the calibration.
 2. If an error occurs, refer to Section A.2, "Error Messages."
-

When calibration is complete, the Calibration Completed message box is displayed. This confirms whether or not the previously acquired calibration data should be replaced by the newly acquired calibration data. Press **OK** to replace the previously acquired data.

If **Cancel** is pressed, the program is terminated without replacing the previously acquired calibration data.

5.6 CH1-Output Calibration

5.6 CH1-Output Calibration

The path, which includes the RF IN/OUT CH1 signal cable, is calibrated here.

(Terminate all RF ports (excluding the RF port mentioned above) by using 50 Ω terminators.)

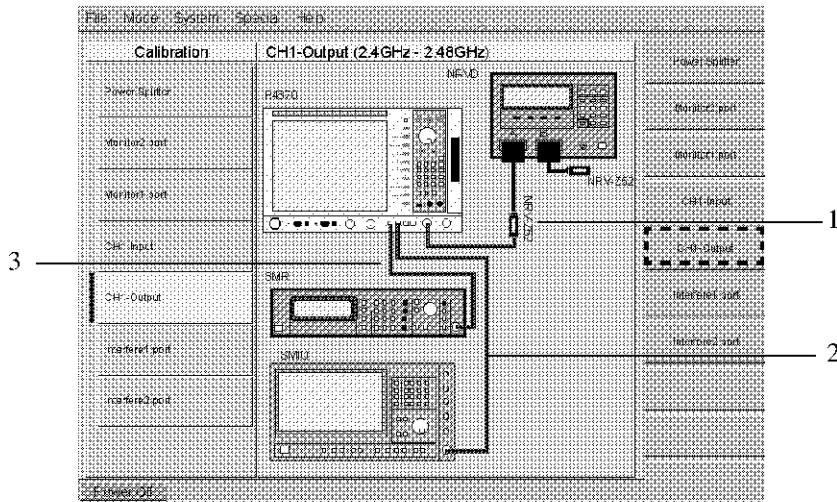

Figure 5-9 CH1-Output Calibration

RF cables, which are used in calibration, are shown below (See Figure 5-9).

1. R4870: RF IN/OUT CH1 → IUT connection cable
2. SMIQ: RF Port → R4870: Interfere2 port connection cable
3. SMR: RF Port → R4870: Interfere1 port connection cable

If **SINGLE** is pressed after connection is complete, the Calibration Setup message box is displayed. After confirming connection is complete, click **OK** to perform calibration.

NOTE:

1. If **OK** is pressed while a connection is incorrect, calibration cannot be complete. Check the connection and perform the calibration.
2. If an error occurs, refer to Section A.2, "Error Messages."

When calibration is complete, the Calibration Completed message box is displayed. This confirms whether or not the previously acquired calibration data should be replaced by the newly acquired calibration data. Press **OK** to replace the previously acquired data.

If **Cancel** is pressed, the program is terminated without replacing the previously acquired calibration data.

5.7 Interfere1 Port Calibration

The path, which includes the signal cable between RF IN/OUT CH1 and Interfere1 port, is calibrated here.
(Terminate all RF ports (excluding the RF ports mentioned above) by using 50 Ω terminators.)

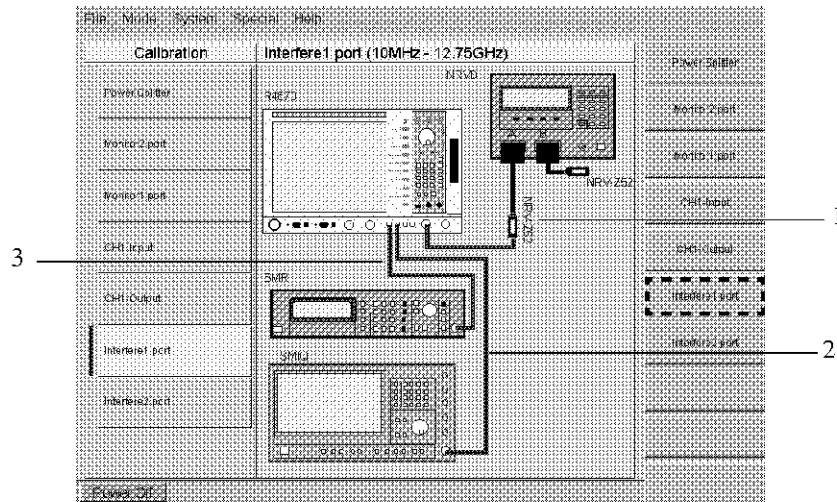

Figure 5-10 Interfere1 Port Calibration

RF cables, which are used in calibration, are shown below (See Figure 5-10).

1. R4870: RF IN/OUT CH1 → IUT connection cable
2. SMIQ: RF Port → R4870: Interfere2 port connection cable
3. SMR: RF Port → R4870: Interfere1 port connection cable

If **SINGLE** is pressed after connection is complete, the Calibration Setup message box is displayed. After confirming connection is complete, click **OK** to perform calibration.

NOTE:

1. If **OK** is pressed while a connection is incorrect, calibration cannot be complete. Check the connection and perform the calibration.
 2. If an error occurs, refer to Section A.2, "Error Messages."
-

When calibration is complete, the Calibration Completed message box is displayed. This confirms whether or not the previously acquired calibration data should be replaced by the newly acquired calibration data. Press **OK** to replace the previously acquired data.

If **Cancel** is pressed, the program is terminated without replacing the previously acquired calibration data.

5.8 Interfere2 Port Calibration

5.8 Interfere2 Port Calibration

The path, which includes the signal cable between RF IN/OUT CH1 and Interfere2 port, is calibrated here. (Terminate all RF ports (excluding the RF ports mentioned above) by using 50 Ω terminators.)

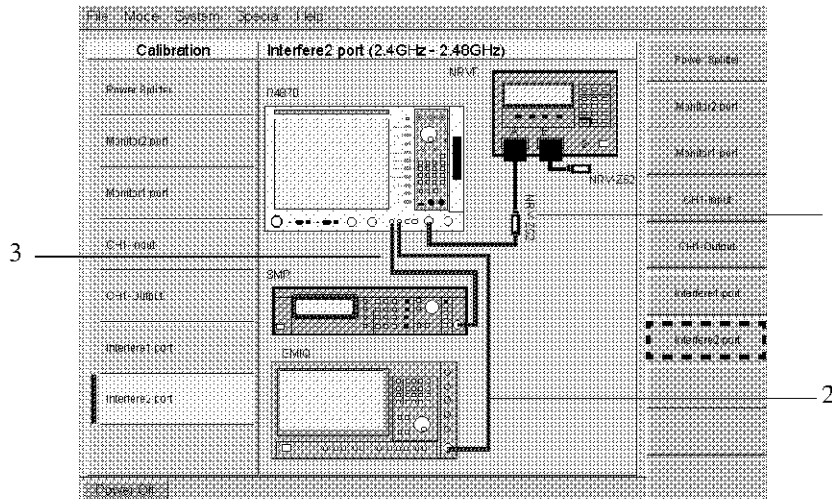

Figure 5-11 Interfere2 Port Calibration

RF cables, which are used in calibration, are shown below (See Figure 5-11).

1. R4870: RF IN/OUT CH1 → IUT connection cable
2. SMIQ: RF Port → R4870: Interfere2 port connection cable
3. SMR: RF Port → R4870: Interfere1 port connection cable

If **SINGLE** is pressed after connection is complete, the Calibration Setup message box is displayed. After confirming connection is complete, click **OK** to perform calibration.

NOTE:

1. If **OK** is pressed while a connection is incorrect, calibration cannot be complete. Check the connection and perform the calibration.
2. If an error occurs, refer to Section A.2, "Error Messages."

When calibration is complete, the Calibration Completed message box is displayed. This confirms whether or not the previously acquired calibration data should be replaced by the newly acquired calibration data. Press **OK** to replace the previously acquired data.

If **Cancel** is pressed, the program is terminated without replacing the previously acquired calibration data.

5.9 Continuous Calibration

This section describes how to perform continuous calibration by using **START**.

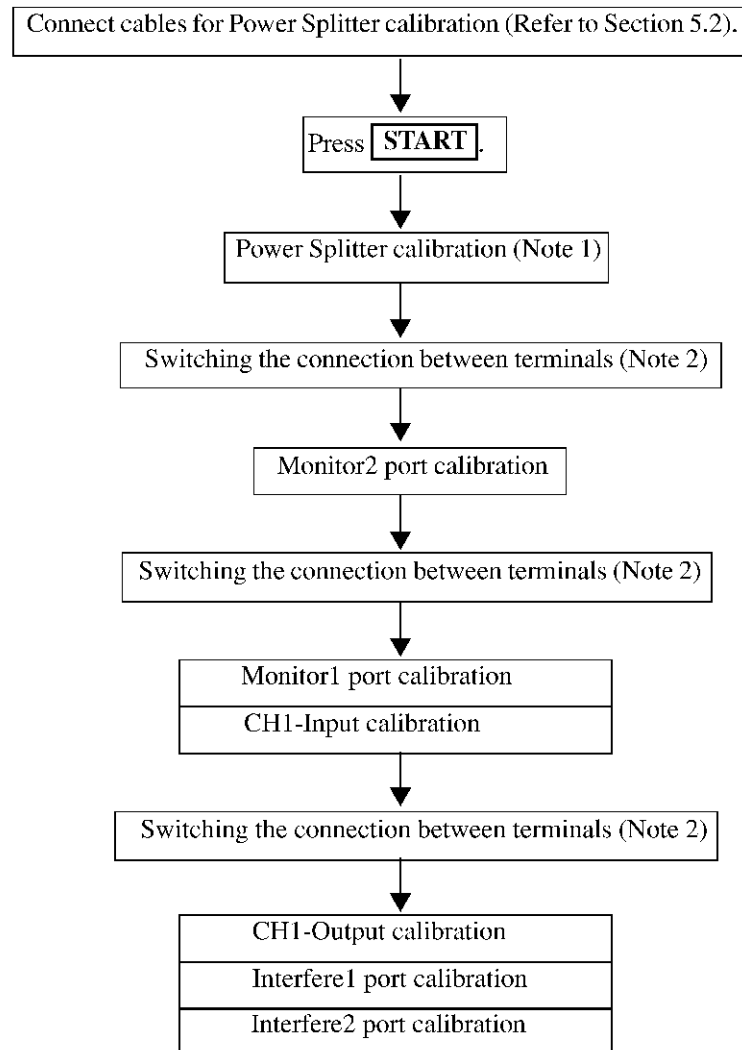

Figure 5-12 Procedures for Performing Continuous Calibration

NOTE:

1. After each calibration is executed, the calibration data must be saved.
 2. Every time single-item calibration or multiple-item calibration is executed, the connection must be switched between terminals.
-

6. REMOTE CONTROL

This chapter describes the function which control the R4870 OPT01 function from the external PC through the Ethernet.

For more information on how to control or program, refer to “R4870 Radio Communication Tester Operation Manual.”

6.1 Function Specifications

Index

Function name	Page
CONFigure Subsystem - SIG RF	
QryConfSig20dBBwid	6-10
QryConfSig20dBBwidLev	6-46
QryConfSig20dBBwidTestPack	6-62
QryConfSig20dBBwidTestType	6-18
QryConfSig20dBBwidUp	6-27
QryConfSigACP	6-11
QryConfSigACPMN2Up	6-28
QryConfSigACPMN3Up	6-29
QryConfSigACPNumAdCh	6-47
QryConfSigACPTestPack	6-63
QryConfSigACPTestType	6-19
QryConfSigBlocPerf	6-14
QryConfSigBlocPerfBerUp	6-33
QryConfSigBlocPerfInteLev	6-57
QryConfSigBlocPerfSmpAlc	6-60
QryConfSigBlocPerfTestPack	6-65
QryConfSigBlocPerfTestType	6-21
QryConfSigBlocPerfWantLev	6-56
QryConfSigCIPerf	6-13
QryConfSigCIPerfBerUp	6-33
QryConfSigCIPerfImagFreq	6-52
QryConfSigCIPerfInteLev	6-54
QryConfSigCIPerfInteRelaLev	6-55
QryConfSigCIPerfTestPack	6-64
QryConfSigCIPerfTestType	6-20
QryConfSigCIPerfWantLev	6-53
QryConfSigFreqRang	6-9
QryConfSigFreqRangFranLo	6-27
QryConfSigFreqRangFranUp	6-26
QryConfSigFreqRangLev	6-45
QryConfSigFreqRangLo	6-25
QryConfSigFreqRangSweeCnt	6-45

6.1 Function Specifications

QryConfSigFreqRangTestPack	6-62
QryConfSigFreqRangTestType	6-17
QryConfSigFreqRangUp	6-25
QryConfSigImodPerf	6-15
QryConfSigImodPerfBerUp	6-34
QryConfSigImodPerfF1Lev	6-58
QryConfSigImodPerfF2Lev	6-59
QryConfSigImodPerfTestPack	6-66
QryConfSigImodPerfTestType	6-21
QryConfSigImodPerfWantLev	6-58
QryConfSigOutpPowAvgCnt	6-37
QryConfSigOutpPowBursLo	6-35
QryConfSigOutpPowBursUp	6-35
QryConfSigOutpPowLeadTrad	6-36
QryConfSigOutpPowTestType	6-15
QryConfSigPowCont	6-9
QryConfSigPowContClas1Lo	6-23
QryConfSigPowContHspdMinPowUp	6-42
QryConfSigPowContJudgMinPow	6-44
QryConfSigPowContJudgStepNum	6-43
QryConfSigPowContStdMinPowUp	6-41
QryConfSigPowContStepLo	6-24
QryConfSigPowContStepNum	6-40
QryConfSigPowContStepUp	6-23
QryConfSigPowContTestPack	6-61
QryConfSigPowContTestType	6-17
QryConfSigPowContWaitTout	6-42
QryConfSigPowDens	6-8
QryConfSigPowDensHspdPkFreqSweeTime	6-40
QryConfSigPowDensHspdPkPowSweeTime	6-39
QryConfSigPowDensStdPkFreqSweeTime	6-38
QryConfSigPowDensStdPkPowSweeTime	6-37
QryConfSigPowDensTestPack	6-60
QryConfSigPowDensTestType	6-16
QryConfSigPowDensUp	6-22
QryConfSigSpurEmis	6-12
QryConfSigSpurEmisEtsHspdFreq	6-47
QryConfSigSpurEmisEtsStdFreqLo	6-48
QryConfSigSpurEmisEtsStdFreqUp	6-49
QryConfSigSpurEmisEtsUp	6-31
QryConfSigSpurEmisFccHspdFreq	6-50
QryConfSigSpurEmisFccStdFreqLo	6-50
QryConfSigSpurEmisFccStdFreqUp	6-51
QryConfSigSpurEmisFccUp	6-31
QryConfSigSpurEmisSele	6-32
QryConfSigSpurEmisTestPack	6-64
QryConfSigSpurEmisTestType	6-19
WmtConfSig20dBBwid	6-10
WmtConfSig20dBBwidLev	6-46
WmtConfSig20dBBwidTestPack	6-62
WmtConfSig20dBBwidTestType	6-18

WmtConfSig20dBBwidUp	6-27
WmtConfSigACP	6-11
WmtConfSigACPMN2Up	6-28
WmtConfSigACPMN3Up	6-28
WmtConfSigACPNumAdCh	6-46
WmtConfSigACPTestPack	6-63
WmtConfSigACPTestType	6-18
WmtConfSigBlocPerf	6-14
WmtConfSigBlocPerfBerUp	6-33
WmtConfSigBlocPerfInteLev	6-56
WmtConfSigBlocPerfSmpAvc	6-59
WmtConfSigBlocPerfTestPack	6-65
WmtConfSigBlocPerfTestType	6-20
WmtConfSigBlocPerfWantLev	6-55
WmtConfSigCIPerf	6-13
WmtConfSigCIPerfBerUp	6-32
WmtConfSigCIPerfImagFreq	6-51
WmtConfSigCIPerfInteLev	6-53
WmtConfSigCIPerfInteRelaLev	6-54
WmtConfSigCIPerfTestPack	6-64
WmtConfSigCIPerfTestType	6-20
WmtConfSigCIPerfWantLev	6-52
WmtConfSigFreqRang	6-9
WmtConfSigFreqRangFranLo	6-26
WmtConfSigFreqRangFranUp	6-26
WmtConfSigFreqRangLev	6-44
WmtConfSigFreqRangLo	6-25
WmtConfSigFreqRangSweeCnt	6-45
WmtConfSigFreqRangTestPack	6-61
WmtConfSigFreqRangTestType	6-17
WmtConfSigFreqRangUp	6-24
WmtConfSigIModPerf	6-14
WmtConfSigIModPerfBerUp	6-34
WmtConfSigIModPerfF1Lev	6-58
WmtConfSigIModPerfF2Lev	6-59
WmtConfSigIModPerfTestPack	6-65
WmtConfSigIModPerfTestType	6-21
WmtConfSigIModPerfWantLev	6-57
WmtConfSigOutpPowAvgCnt	6-36
WmtConfSigOutpPowBursLo	6-34
WmtConfSigOutpPowBursUp	6-35
WmtConfSigOutpPowLeadTrad	6-36
WmtConfSigOutpPowTestType	6-15
WmtConfSigPowCont	6-8
WmtConfSigPowContClas1Lo	6-22
WmtConfSigPowContHspdMinPowUp	6-41
WmtConfSigPowContJudgMinPow	6-44
WmtConfSigPowContJudgStepNum	6-43
WmtConfSigPowContStdMinPowUp	6-41
WmtConfSigPowContStepLo	6-24
WmtConfSigPowContStepNum	6-40

6.1 Function Specifications

WmtConfSigPowContStepUp	6-23
WmtConfSigPowContTestPack	6-61
WmtConfSigPowContTestType	6-16
WmtConfSigPowContWaitTout	6-42
WmtConfSigPowDens	6-8
WmtConfSigPowDensHspdPkFreqSweeTime	6-39
WmtConfSigPowDensHspdPkPowSweeTime	6-39
WmtConfSigPowDensStdPkFreqSweeTime	6-38
WmtConfSigPowDensStdPkPowSweeTime	6-37
WmtConfSigPowDensTestPack	6-60
WmtConfSigPowDensTestType	6-16
WmtConfSigPowDensUp	6-22
WmtConfSigSpurEmis	6-12
WmtConfSigSpurEmisEtsHspdFreq	6-47
WmtConfSigSpurEmisEtsStdFreqLo	6-48
WmtConfSigSpurEmisEtsStdFreqUp	6-49
WmtConfSigSpurEmisEtsUp	6-30
WmtConfSigSpurEmisFccHspdFreq	6-49
WmtConfSigSpurEmisFccStdFreqLo	6-50
WmtConfSigSpurEmisFccStdFreqUp	6-51
WmtConfSigSpurEmisFccUp	6-31
WmtConfSigSpurEmisSele	6-32
WmtConfSigSpurEmisTestPack	6-63
WmtConfSigSpurEmisTestType	6-19
CONFigure Subsystem - Telec	
QryConfTeleAntPow	6-95
QryConfTeleAntPowBursRati	6-103
QryConfTeleAntPowRefPow	6-102
QryConfTeleAntPowToleLo	6-101
QryConfTeleAntPowToleUp	6-101
QryConfTeleFreqTole	6-93
QryConfTeleFreqToleSampNum	6-99
QryConfTeleOBW	6-94
QryConfTeleOBWBwidUp	6-99
QryConfTeleOBWSpreBwidLo	6-100
QryConfTeleSecoEmit	6-96
QryConfTeleSecoEmitLevLowUp	6-104
QryConfTeleSecoEmitLevUppUp	6-105
QryConfTeleSpurEmis	6-96
QryConfTeleSpurEmisLevUp	6-104
QryConfTeleStayTime	6-97
QryConfTeleStayTimeTimeUp	6-106
QryConfTeleToleToleUp	6-98
WmtConfTeleAntPow	6-94
WmtConfTeleAntPowBursRati	6-102
WmtConfTeleAntPowRefPow	6-102
WmtConfTeleAntPowToleLo	6-101
WmtConfTeleAntPowToleUp	6-100
WmtConfTeleFreqTole	6-93
WmtConfTeleFreqToleSampNum	6-98
WmtConfTeleOBW	6-94

WmtConfTeleOBWBwidUp	6-99
WmtConfTeleOBWSpreBwidLo	6-100
WmtConfTeleSecoEmit	6-96
WmtConfTeleSecoEmitLevLowUp	6-104
WmtConfTeleSecoEmitLevUppUp	6-105
WmtConfTeleSpurEmis	6-95
WmtConfTeleSpurEmisLevUp	6-103
WmtConfTeleStayTime	6-97
WmtConfTeleStayTimeTimeUp	6-105
WmtConfTeleToleToleUp	6-98
FETCh Subsystem - SIG RF	
QryFetcSig20dBBwid	6-74
QryFetcSigACPACP	6-77
QryFetcSigACPCH	6-78
QryFetcSigACPMN2Hi	6-75
QryFetcSigACPMN2Lo	6-75
QryFetcSigACPMN3Hi	6-76
QryFetcSigACPMN3Lo	6-76
QryFetcSigACPNum	6-77
QryFetcSigBlocPerfBer	6-86
QryFetcSigBlocPerfFreq	6-85
QryFetcSigBlocPerfPer	6-86
QryFetcSigBlocPerfSumErr	6-85
QryFetcSigCIPerfBer	6-82
QryFetcSigCIPerfBerRela	6-84
QryFetcSigCIPerfPer	6-83
QryFetcSigCIPerfPerRela	6-84
QryFetcSigCIPerfSumErr	6-81
QryFetcSigCIPerfSumErrRela	6-83
QryFetcSigCIPerfCh	6-82
QryFetcSigFreqRangHiFreq	6-74
QryFetcSigFreqRangLowFreq	6-74
QryFetcSigIModPerfN3HiBer	6-87
QryFetcSigIModPerfN3HiPer	6-88
QryFetcSigIModPerfN3LoBer	6-87
QryFetcSigIModPerfN3LoPer	6-88
QryFetcSigIModPerfN4HiBer	6-89
QryFetcSigIModPerfN4HiPer	6-90
QryFetcSigIModPerfN4LoBer	6-89
QryFetcSigIModPerfN4LoPer	6-90
QryFetcSigIModPerfN5HiBer	6-91
QryFetcSigIModPerfN5HiPer	6-92
QryFetcSigIModPerfN5LoBer	6-91
QryFetcSigIModPerfN5LoPer	6-92
QryFetcSigPowContNumDown	6-71
QryFetcSigPowContNumUp	6-72
QryFetcSigPowContPavDown	6-72
QryFetcSigPowContPavMin	6-73
QryFetcSigPowContPavUp	6-73
QryFetcSigPowDens	6-71
QryFetcSigSpurEmisFccRefPow	6-81

6.1 Function Specifications

QryFetcSigSpurEmisFreq	6-79
QryFetcSigSpurEmisPow	6-80
QryFetcSigSpurEmisSele	6-78
FETCh Subsystem - Telec	
QryFetcTeleAntPowAntPow	6-113
QryFetcTeleAntPowOutpPow	6-113
QryFetcTeleAntPowTole	6-112
QryFetcTeleFreqToleFreq	6-110
QryFetcTeleFreqToleTole	6-110
QryFetcTeleOBWBwid	6-111
QryFetcTeleOBWFreqHi	6-111
QryFetcTeleOBWFreqLow	6-111
QryFetcTeleOBWSpreBwid	6-112
QryFetcTeleOBWSpreBwidHopOff	6-112
QryFetcTeleSecoEmitFreqLow	6-116
QryFetcTeleSecoEmitFreqUpp	6-116
QryFetcTeleSecoEmitLevLow	6-115
QryFetcTeleSecoEmitLevUpp	6-115
QryFetcTeleSpurEmisFreq	6-114
QryFetcTeleSpurEmisLev	6-114
QryFetcTeleStayTimeTime	6-117
PROCedure Subsystem - SIG RF	
WmtProcSig20dBBwid	6-68
WmtProcSigACP	6-68
WmtProcSigBlocPerf	6-70
WmtProcSigCIPerf	6-69
WmtProcSigFreqRang	6-67
WmtProcSigIModPerf	6-70
WmtProcSigPowCont	6-67
WmtProcSigPowDens	6-67
WmtProcSigSpurEmis	6-69
PROCedure Subsystem - Telec	
WmtProcTeleAll	6-109
WmtProcTeleAntPow	6-108
WmtProcTeleAntPowPow	6-107
WmtProcTeleFreqTole	6-107
WmtProcTeleOBW	6-107
WmtProcTeleSecoEmit	6-108
WmtProcTeleSpurEmis	6-108
WmtProcTeleStayTime	6-109
SOURce Subsystem - DC Power Source	
QryOutpVsimStat	6-125
QryOutpVsimStatType	6-124
QrySourVsimBattType	6-118
QrySourVsimBattTypeStd	6-119
QrySourVsimCurrLim	6-122
QrySourVsimCurrLimType	6-123
QrySourVsimCurrStat	6-123
QrySourVsimVoltLo	6-122
QrySourVsimVoltNomi	6-120
QrySourVsimVoltType	6-119

QrySourVsimVoltUp	6-121
WmtOutpVsimStat	6-124
WmtOutpVsimStatType	6-124
WmtSourVsimBattType	6-118
WmtSourVsimBattTypeStd	6-118
WmtSourVsimCurrLim	6-122
WmtSourVsimCurrLimType	6-123
WmtSourVsimVoltLo	6-121
WmtSourVsimVoltNomi	6-120
WmtSourVsimVoltType	6-119
WmtSourVsimVoltUp	6-121

6.1.1 CONFigure Subsystem - SIG RF

6.1.1 CONFigure Subsystem - SIG RF

6.1.1.1 WmtConfSigPowDens

Function name	long WmtConfSigPowDens
Function	Setting the Power Density test to ON or OFF.
Argument	[IN] long lngID // The identifier for the relevant instrument // (the ID obtained when the connection was secured). long lngOnOff // WMT_OFF(0): OFF / WMT_ON(1): ON
Return value	Normal (0:WMT_TRUE) / Error (-1)
Description	The function sets the Power Density test to ON or OFF. The initial value is ON.

6.1.1.2 QryConfSigPowDens

Function name	long QryConfSigPowDens
Function	Reading out the ON or OFF setting of the Power Density test.
Argument	[IN] long lngID // The identifier for the relevant instrument // (the ID obtained when the connection was secured). [OUT] long * lngOnOff
Return value	Normal (0:WMT_TRUE) / Error (-1)
Description	The function reads out the current ON or OFF setting of the Power Density and stores the value in the variable specified by <i>lngOnOff</i> .

6.1.1.3 WmtConfSigPowCont

Function name	long WmtConfSigPowCont
Function	Setting the Power Control test to ON or OFF.
Argument	[IN] long lngID // The identifier for the relevant instrument // (the ID obtained when the connection was secured). long lngPoint // Test item setting // 0x00: Setting the testing item to ON or OFF. // Operation frequency setting // 0x01: LOW (Lowest operating frequency) // 0x02: MID (Mid operating frequency) // 0x03: HIGH (Highest operating frequency) long lngOnOff // WMT_OFF(0): OFF / WMT_ON(1): ON
Return value	Normal (0:WMT_TRUE) / Error (-1)
Description	The function sets the Power Control test to ON or OFF. Initial values are ON for all test items and all operating frequencies.

6.1.1.4 QryConfSigPowCont

Function name	long QryConfSigPowCont
Function	Reading out the ON or OFF setting of the Power Control test.
Argument	[IN] long lngID // The identifier for the relevant instrument // (the ID obtained when the connection was secured). long lngPoint // Test item setting // 0x00: Setting the testing item to ON or OFF. // Operation frequency setting // 0x01: LOW (Lowest operating frequency) // 0x02: MID (Mid operating frequency) // 0x03: HIGH (Highest operating frequency) [OUT] long * lngOnOff
Return value	Normal (0:WMT_TRUE) / Error (-1)
Description	The function reads out the current ON or OFF setting of the Power Control test and stores the value in the variable specified <i>lngOnOff</i> .

6.1.1.5 WmtConfSigFreqRang

Function name	long WmtConfSigFreqRang
Function	Setting the TX Output Spectrum - Frequency Range test to ON or OFF.
Argument	[IN] long lngID // The identifier for the relevant instrument // (the ID obtained when the connection was secured). long lngOnOff // WMT_OFF(0): OFF / WMT_ON(1): ON
Return value	Normal (0:WMT_TRUE) / Error (-1)
Description	He function sets the TX Output Spectrum - Frequency Range test to ON or OFF. The initial value is ON.

6.1.1.6 QryConfSigFreqRang

Function name	long QryConfSigFreqRang
Function	Reading out the ON or OFF setting of the TX Output Spectrum - Frequency Range test.
Argument	[IN] long lngID // The identifier for the relevant instrument // (the ID obtained when the connection was secured). [OUT] long * lngOnOff
Return value	Normal (0:WMT_TRUE) / Error (-1)
Description	The function reads out the current ON or OFF setting of the TX Output Spectrum - Frequency Range test and stores the value in the variable specified by <i>lngOnOff</i> .

6.1.1 CONFigure Subsystem - SIG RF

6.1.1.7 WmtConfSig20dBBwid

Function name	long WmtConfSig20dBBwid
Function	Setting the TX Output Spectrum - 20 dB Bandwidth test to ON or OFF.
Argument	[IN] long lngID // The identifier for the relevant instrument // (the ID obtained when the connection was secured). long lngPoint // Test item setting // 0x00: Setting the testing item to ON or OFF. // Operation frequency setting // 0x01: LOW (Lowest operating frequency) // 0x02: MID (Mid operating frequency) // 0x03: HIGH (Highest operating frequency) long lngOnOff // WMT_OFF(0): OFF / WMT_ON(1): ON
Return value	Normal (0:WMT_TRUE) / Error (-1)
Description	The function sets the TX Output Spectrum 20 dB Bandwidth test to ON or OFF. The initial value is ON for all test items and all operating frequencies.

6.1.1.8 QryConfSig20dBBwid

Function name	long QryConfSig20dBBwid
Function	Reading out the ON or OFF setting of the TX Output Spectrum - 20 dB Bandwidth test.
Argument	[IN] long lngID // The identifier for the relevant instrument // (the ID obtained when the connection was secured). long lngPoint // Test item setting // 0x00: Setting the testing item to ON or OFF. // Operation frequency setting // 0x01: LOW (Lowest operating frequency) // 0x02: MID (Mid operating frequency) // 0x03: HIGH (Highest operating frequency) [OUT] long * lngOnOff
Return value	Normal (0:WMT_TRUE) / Error (-1)
Description	The function reads out the current ON or OFF setting of the TX Output Spectrum 20 dB Bandwidth test and stores the value in the variable specified by <i>lngOnOff</i> .

6.1.1.9 WmtConfSigACP

Function name	long WmtConfSigACP
Function	Setting the TX Output Spectrum - Adjacent Channel Power test to ON or OFF.
Argument	<p>[IN] long lngID // The identifier for the relevant instrument // (the ID obtained when the connection was secured).</p> <p>long lngPoint // Test item setting // 0x00: Setting the testing item to ON or OFF. // Operation frequency setting // 0x01: LOW (Lowest operating frequency) // 0x02: MID (Mid operating frequency) // 0x03: HIGH (Highest operating frequency)</p> <p>long lngOnOff // WMT_OFF(0): OFF / WMT_ON(1): ON</p>
Return value	Normal (0:WMT_TRUE) / Error (-1)
Description	The function sets the TX Output Spectrum Adjacent Channel Power test to ON or OFF. The initial value is ON for all test items and all operating frequencies.

6.1.1.10 QryConfSigACP

Function name	long QryConfSigACP
Function	Reading out the ON or OFF setting of the TX Output Spectrum - Adjacent Channel Power test.
Argument	<p>[IN] long lngID // The identifier for the relevant instrument // (the ID obtained when the connection was secured).</p> <p>long lngPoint // Test item setting // 0x00: Setting the testing item to ON or OFF. // Operation frequency setting // 0x01: LOW (Lowest operating frequency) // 0x02: MID (Mid operating frequency) // 0x03: HIGH (Highest operating frequency)</p> <p>[OUT] long * lngOnOff</p>
Return value	Normal (0:WMT_TRUE) / Error (-1)
Description	The function reads out the current ON or OFF setting of the TX Output Spectrum Adjacent Channel Power test and stores the value in the variable specified by <i>lngOnOff</i> .

6.1.1 CONFigure Subsystem - SIG RF

6.1.1.11 WmtConfSigSpurEmis

Function name	long WmtConfSigSpurEmis
Function	Setting the Out-of-Band Spurious Emissions test to ON or OFF.
Argument	[IN] long lngID // The identifier for the relevant instrument // (the ID obtained when the connection was secured). long lngPoint // Test item setting // 0x00: Setting the testing item to ON or OFF. // Operation frequency setting // 0x01: LOW (Lowest operating frequency) // 0x02: MID (Mid operating frequency) // 0x03: HIGH (Highest operating frequency) // 0xFF: Standby (the ETS Standby mode) long lngOnOff // WMT_OFF(0): OFF / WMT_ON(1): ON
Return value	Normal (0:WMT_TRUE) / Error (-1)
Description	The function sets the Out-of-Band Spurious Emissions test to ON or OFF. The initial value is ON for all test items and all operating frequencies.

6.1.1.12 QryConfSigSpurEmis

Function name	long QryConfSigSpurEmis
Function	Reading out the ON or OFF setting of the Out-of-Band Spurious Emissions test.
Argument	[IN] long lngID // The identifier for the relevant instrument // (the ID obtained when the connection was secured). long lngPoint // Test item setting // 0x00: Setting the testing item to ON or OFF. // Operation frequency setting // 0x01: LOW (Lowest operating frequency) // 0x02: MID (Mid operating frequency) // 0x03: HIGH (Highest operating frequency) // 0xFF: Standby (the ETS Standby mode) [OUT] long * lngOnOff
Return value	Normal (0:WMT_TRUE) / Error (-1)
Description	The function reads out the current ON or OFF setting of the Out-of-Band Spurious Emissions test and stores the value in the variable specified by <i>lngOnOff</i> .

6.1.1.13 WmtConfSigCIPerf

Function name	long WmtConfSigCIPerf
Function	Setting the C/I Performance test to ON or OFF.
Argument	[IN] long lngID // The identifier for the relevant instrument // (the ID obtained when the connection was secured). long lngPoint // Test item setting // 0x00: Setting the testing item to ON or OFF. // Operation frequency setting // 0x01: LOW (Lowest operating frequency) // 0x02: MID (Mid operating frequency) // 0x03: HIGH (Highest operating frequency) long lngOnOff // WMT_OFF(0): OFF / WMT_ON(1): ON
Return value	Normal (0:WMT_TRUE) / Error (-1)
Description	The function sets the C/I Performance test to ON or OFF. The initial value is ON for all test items and all operating frequencies.

6.1.1.14 QryConfSigCIPerf

Function name	long QryConfSigCIPerf
Function	Reading out the ON or OFF setting of the C/I Performance test.
Argument	[IN] long lngID // The identifier for the relevant instrument // (the ID obtained when the connection was secured). long lngPoint // Test item setting // 0x00: Setting the testing item to ON or OFF. // Operation frequency setting // 0x01: LOW (Lowest operating frequency) // 0x02: MID (Mid operating frequency) // 0x03: HIGH (Highest operating frequency) [OUT] long * lngOnOff
Return value	Normal (0:WMT_TRUE) / Error (-1)
Description	The function reads out the current ON or OFF setting of the C/I Performance test and stores the value in the variable specified by <i>lngOnOff</i> .

6.1.1 CONFigure Subsystem - SIG RF

6.1.1.15 WmtConfSigBlocPerf

Function name	long WmtConfSigBlocPerf
Function	Setting the Blocking Performance test to ON or OFF.
Argument	[IN] long IngID // The identifier for the relevant instrument // (the ID obtained when the connection was secured). long IngOnOff // WMT_OFF(0): OFF / WMT_ON(1): ON
Return value	Normal (0:WMT_TRUE) / Error (-1)
Description	The function sets the Blocking Performance test to ON or OFF. The initial value is ON.

6.1.1.16 QryConfSigBlocPerf

Function name	long QryConfSigBlocPerf
Function	Reading out the ON or OFF setting of the Blocking Performance test.
Argument	[IN] long IngID // The identifier for the relevant instrument // (the ID obtained when the connection was secured). [OUT] long * IngOnOff
Return value	Normal (0:WMT_TRUE) / Error (-1)
Description	The function reads out the current ON or OFF setting of the Blocking Performance test and stores the value in the variable specified by <i>IngOnOff</i> .

6.1.1.17 WmtConfSigIModPerf

Function name	long WmtConfSigIModPerf
Function	Setting the Intermodulation Performance test to ON or OFF.
Argument	[IN] long IngID // The identifier for the relevant instrument // (the ID obtained when the connection was secured). long IngPoint // Test item setting // 0x00: Setting the testing item to ON or OFF. // Operation frequency setting // 0x01: LOW (Lowest operating frequency) // 0x02: MID (Mid operating frequency) // 0x03: HIGH (Highest operating frequency) long IngOnOff // WMT_OFF(0): OFF / WMT_ON(1): ON
Return value	Normal (0:WMT_TRUE) / Error (-1)
Description	Setting the Intermodulation Performance test to ON or OFF. The initial value is ON for all test items and all operating frequencies.

6.1.1.18 QryConfSigIModPerf

Function name	long QryConfSigIModPerf
Function	Reading out the ON or OFF setting of the Intermodulation Performance test.
Argument	<pre>[IN] long lngID // The identifier for the relevant instrument // (the ID obtained when the connection was secured). long lngPoint // Test item setting // 0x00: Setting the testing item to ON or OFF. // Operation frequency setting // 0x01: LOW (Lowest operating frequency) // 0x02: MID (Mid operating frequency) // 0x03: HIGH (Highest operating frequency) [OUT] long * lngOnOff</pre>
Return value	Normal (0:WMT_TRUE) / Error (-1)
Description	The function reads out the current ON or OFF setting of the Intermodulation Performance test and stores the value in the variable specified by <i>lngOnOff</i> .

6.1.1.19 WmtConfSigOutpPowTestType

Function name	long WmtConfSigOutpPowTestType
Function	Selecting the test method of the Output Power test.
Argument	<pre>[IN] long lngID // The identifier for the relevant instrument // (the ID obtained when the connection was secured). long lngType // Measurement type // 0x00: STANDARD (complies to the SIG standard) // 0x01: HIGH SPEED (high speed/simple version)</pre>
Return value	Normal (0:WMT_TRUE) / Error (-1)
Description	The function sets the selected test method of the Output Power test. The initial value is 0 (complies with the SIG standard).

6.1.1.20 QryConfSigOutpPowTestType

Function name	long QryConfSigOutpPowTestType
Function	Reading out the test method of the Output Power test.
Argument	<pre>[IN] long lngID // The identifier for the relevant instrument // (the ID obtained when the connection was secured). [OUT] long * lngType</pre>
Return value	Normal (0:WMT_TRUE) / Error (-1)
Description	The function reads out the current test method of the Output Power test and stores the value in the variable specified by <i>lngType</i> .

6.1.1 CONFigure Subsystem - SIG RF

6.1.1.21 WmtConfSigPowDensTestType

Function name	long WmtConfSigPowDensTestType
Function	Selecting the test method of the Power Density test.
Argument	[IN] long lngID // The identifier for the relevant instrument // (the ID obtained when the connection was secured). long lngType // Measurement type // 0x00: STANDARD (complies to the SIG standard) // 0x01: HIGH SPEED (high speed/simple version)
Return value	Normal (0:WMT_TRUE) / Error (-1)
Description	The function sets the selected test method of the Power Density test. The initial value is 0 (complies with the SIG standard).

6.1.1.22 QryConfSigPowDensTestType

Function name	long QryConfSigPowDensTestType
Function	Reading out the test method of the Power Density test.
Argument	[IN] long lngID // The identifier for the relevant instrument // (the ID obtained when the connection was secured). [OUT] long * lngType
Return value	Normal (0:WMT_TRUE) / Error (-1)
Description	The function reads out the current test method of the Power Density test and stores the value in the variable specified by <i>lngType</i> .

6.1.1.23 WmtConfSigPowContTestType

Function name	long WmtConfSigPowContTestType
Function	Selecting the test method of the Power Control test.
Argument	[IN] long lngID // The identifier for the relevant instrument // (the ID obtained when the connection was secured). long lngType //Measurement type // 0x00: STANDARD (complies to the SIG standard) // 0x01: HIGH SPEED (high speed/simple version)
Return value	Normal (0:WMT_TRUE) / Error (-1)
Description	The function sets the selected test method of the Power Control test. The initial value is 0 (complies with the SIG standard).

6.1.1.24 QryConfSigPowContTestType

Function name	long QryConfSigPowContTestType
Function	Reading out the test method of the Power Control test.
Argument	[IN] long lngID // The identifier for the relevant instrument // (the ID obtained when the connection was secured). [OUT] long * lngType
Return value	Normal (0:WMT_TRUE) / Error (-1)
Description	The function reads out the current test method of the Power Control test and stores the value in the variable specified by <i>lngType</i> .

6.1.1.25 WmtConfSigFreqRangTestType

Function name	long WmtConfSigFreqRangTestType
Function	Selecting the test method of the TX Output Spectrum - Frequency Range test.
Argument	[IN] long lngID // The identifier for the relevant instrument // (the ID obtained when the connection was secured). long lngType // Measurement type // 0x00: STANDARD (complies to the SIG standard) // 0x01: HIGH SPEED (high speed/simple version)
Return value	Normal (0:WMT_TRUE) / Error (-1)
Description	The function sets the selected test method of the TX Output Spectrum - Frequency Range test. The initial value is 0 (complies with the SIG standard).

6.1.1.26 QryConfSigFreqRangTestType

Function name	long QryConfSigFreqRangTestType
Function	Reading out the test method of the TX Output Spectrum - Frequency Range test.
Argument	[IN] long lngID // The identifier for the relevant instrument // (the ID obtained when the connection was secured). [OUT] long * lngType
Return value	Normal (0:WMT_TRUE) / Error (-1)
Description	The function reads out the current test method of the TX Output Spectrum - Frequency Range test and stores the value in the variable specified by <i>lngType</i> .

6.1.1 CONFigure Subsystem - SIG RF

6.1.1.27 WmtConfSig20dBBwidTestType

Function name	long WmtConfSig20dBBwidTestType
Function	Selecting the test method of the TX Output Spectrum - 20 dB Bandwidth test.
Argument	[IN] long lngID // The identifier for the relevant instrument // (the ID obtained when the connection was secured). long lngType // Measurement type // 0x00: STANDARD (complies to the SIG standard) // 0x01: HIGH SPEED (high speed/simple version)
Return value	Normal (0:WMT_TRUE) / Error (-1)
Description	The function sets the selected test method of the TX Output Spectrum - 20 dB Bandwidth test. The initial value is 0 (complies with the SIG standard).

6.1.1.28 QryConfSig20dBBwidTestType

Function name	long QryConfSig20dBBwidTestType
Function	Reading out the test method of the TX Output Spectrum - 20 dB Bandwidth test.
Argument	[IN] long lngID // The identifier for the relevant instrument // (the ID obtained when the connection was secured). [OUT] long * lngType
Return value	Normal (0:WMT_TRUE) / Error (-1)
Description	The function reads out the current test method of the TX Output Spectrum - 20 dB Bandwidth test and stores the value in the variable specified by <i>lngType</i> .

6.1.1.29 WmtConfSigACPTestType

Function name	long WmtConfSigACPTestType
Function	Selecting the test method of the TX Output Spectrum - Adjacent Channel Power test.
Argument	[IN] long lngID // The identifier for the relevant instrument // (the ID obtained when the connection was secured). long lngType // Measurement type // 0x00: STANDARD (complies to the SIG standard) // 0x01: HIGH SPEED (high speed/simple version)
Return value	Normal (0:WMT_TRUE) / Error (-1)
Description	The function sets the selected test method of the TX Output Spectrum - Adjacent Channel Power test. The initial value is 0 (complies with the SIG standard).

6.1.1.30 QryConfSigACPTestType

Function name	long QryConfSigACPTestType
Function	Reading out the test method of the TX Output Spectrum - Adjacent Channel Power test.
Argument	[IN] long lngID // The identifier for the relevant instrument // (the ID obtained when the connection was secured). [OUT] long * lngType
Return value	Normal (0:WMT_TRUE) / Error (-1)
Description	The function reads out the current test method of the TX Output Spectrum - Adjacent Channel Power test and stores the value in the variable specified by <i>lngType</i> .

6.1.1.31 WmtConfSigSpurEmisTestType

Function name	long WmtConfSigSpurEmisTestType
Function	Selecting the test method of the Out-of-Band Spurious Emissions test.
Argument	[IN] long lngID // The identifier for the relevant instrument // (the ID obtained when the connection was secured). long lngType // Measurement type // 0x00: STANDARD (complies to the SIG standard) // 0x01: HIGH SPEED (high speed/simple version)
Return value	Normal (0:WMT_TRUE) / Error (-1)
Description	The function sets the selected test method of the Out-of-Band Spurious Emissions test. The initial value is 0 (complies with the SIG standard).

6.1.1.32 QryConfSigSpurEmisTestType

Function name	long QryConfSigSpurEmisTestType
Function	Reading out the test method of the Out-of-Band Spurious Emissions test.
Argument	[IN] long lngID // The identifier for the relevant instrument // (the ID obtained when the connection was secured). [OUT] long * lngType
Return value	Normal (0:WMT_TRUE) / Error (-1)
Description	The function reads out the current test method of the Out-of-Band Spurious Emissions test and stores the value in the variable specified by <i>lngType</i> .

6.1.1 CONFigure Subsystem - SIG RF

6.1.1.33 WmtConfSigCIPerfTestType

Function name	long WmtConfSigCIPerfTestType
Function	Selecting the test method of the C/I Performance test.
Argument	[IN] long lngID // The identifier for the relevant instrument // (the ID obtained when the connection was secured). long lngType // Measurement type // 0x00: STANDARD (complies to the SIG standard) // 0x01: HIGH SPEED (high speed/simple version)
Return value	Normal (0:WMT_TRUE) / Error (-1)
Description	The function sets the selected test method of the C/I Performance test. The initial value is 0 (complies with the SIG standard).

6.1.1.34 QryConfSigCIPerfTestType

Function name	long QryConfSigCIPerfTestType
Function	Reading out the test method of the C/I Performance test.
Argument	[IN] long lngID // The identifier for the relevant instrument // (the ID obtained when the connection was secured). [OUT] long * lngType
Return value	Normal (0:WMT_TRUE) / Error (-1)
Description	The function reads out the current test method of the C/I Performance test and stores the value in the variable specified by <i>lngType</i> .

6.1.1.35 WmtConfSigBlocPerfTestType

Function name	long WmtConfSigBlocPerfTestType
Function	Selecting the test method of the Blocking Performance test.
Argument	[IN] long lngID // The identifier for the relevant instrument // (the ID obtained when the connection was secured). long lngType // Measurement type // 0x00: STANDARD (complies to the SIG standard) // 0x01: HIGH SPEED (high speed/simple version)
Return value	Normal (0:WMT_TRUE) / Error (-1)
Description	The function sets the test method of the Blocking Performance test. The initial value is 0 (complies with the SIG standard).

6.1.1.36 QryConfSigBlocPerfTestType

Function name	long QryConfSigBlocPerfTestType
Function	Reading out the test method of the Blocking Performance test.
Argument	[IN] long lngID // The identifier for the relevant instrument // (the ID obtained when the connection was secured). [OUT] long * lngType
Return value	Normal (0:WMT_TRUE) / Error (-1)
Description	The function reads out the current test method of the Blocking Performance test and stores the value in the variable specified by <i>lngType</i> .

6.1.1.37 WmtConfSigIModPerfTestType

Function name	long WmtConfSigIModPerfTestType
Function	Selecting the test method of the Intermodulation Performance test.
Argument	[IN] long lngID // The identifier for the relevant instrument // (the ID obtained when the connection was secured). long lngType //Measurement type // 0x00: STANDARD (complies to the SIG standard) // 0x01: HIGH SPEED (high speed/simple version)
Return value	Normal (0:WMT_TRUE) / Error (-1)
Description	The function sets the test method of the Intermodulation Performance test. The initial value is 0 (complies with the SIG standard).

6.1.1.38 QryConfSigIModPerfTestType

Function name	long QryConfSigIModPerfTestType
Function	Reading out the test method of the Intermodulation Performance test.
Argument	[IN] long lngID // The identifier for the relevant instrument // (the ID obtained when the connection was secured). [OUT] long * lngType
Return value	Normal (0:WMT_TRUE) / Error (-1)
Description	The function reads out the current test method of the Intermodulation Performance test and stores the value in the variable specified by <i>lngType</i> .

6.1.1 CONFigure Subsystem - SIG RF

6.1.1.39 WmtConfSigPowDensUp

Function name	long WmtConfSigPowDensUp
Function	Setting an upper limit value which is used to make judgments in the Output Power test.
Argument	[IN] long lngID // The identifier for the relevant instrument // (the ID obtained when the connection was secured). double dblLimit // 0.00 to 25.00 [dBm/100 kHz]
Return value	Normal (0:WMT_TRUE) / Error (-1)
Description	The function sets an upper limit value which is used to make judgments in the Output Power test. The initial value is 20.00 [dBm/100 kHz].

6.1.1.40 QryConfSigPowDensUp

Function name	long QryConfSigPowDensUp
Function	Reading out the upper limit value which is used to make judgments in the Output Power test.
Argument	[IN] long lngID // The identifier for the relevant instrument // (the ID obtained when the connection was secured). [OUT] double * dblLimit
Return value	Normal (0:WMT_TRUE) / Error (-1)
Description	The function reads out the current upper limit value which is used to make judgments in the Output Power test and stores the value in the variable specified by <i>dblLimit</i> .

6.1.1.41 WmtConfSigPowContClas1Lo

Function name	long WmtConfSigPowContClas1Lo
Function	Setting a value which is used to determine the minimum output power in Class1 of the Power Control test.
Argument	[IN] long lngID // The identifier for the relevant instrument // (the ID obtained when the connection was secured). double dblLimit // -33.00 to 25.00 [dBm]
Return value	Normal (0:WMT_TRUE) / Error (-1)
Description	The function sets a value which is used to determine the minimum output power in Class1 of the Power Control test. The initial value is 4.00 [dBm].

6.1.1.42 QryConfSigPowContClas1Lo

Function name	long QryConfSigPowContClas1Lo
Function	Reading out the value which is used to determine the minimum output power in Class1 of the Power Control test.
Argument	[IN] long lngID // The identifier for the relevant instrument // (the ID obtained when the connection was secured). [OUT] double * dblLimit
Return value	Normal (0:WMT_TRUE) / Error (-1)
Description	The function reads out the current value which is used to determine the minimum output power in Class1 of the Power Control test and stores the value in the variable specified by <i>dblLimit</i> .

6.1.1.43 WmtConfSigPowContStepUp

Function name	long WmtConfSigPowContStepUp
Function	Setting an upper limit value which is used to determine the volume change in one step of the Power Control test.
Argument	[IN] long lngID // The identifier for the relevant instrument // (the ID obtained when the connection was secured). double dblLimit // 1.00 to 10.00 [dB]
Return value	Normal (0:WMT_TRUE) / Error (-1)
Description	The function sets an upper limit value which is used to determine the volume change in one step of the Power Control test. The initial value is 8.00 [dB]. If the specified upper limit value is less than the existing lower limit value, the upper limit value is automatically set to a value which is equal to the lower limit.

6.1.1.44 QryConfSigPowContStepUp

Function name	long QryConfSigPowContStepUp
Function	Reading out the upper limit value which is used to determine the volume change in one step of the Power Control test.
Argument	[IN] long lngID // The identifier for the relevant instrument // (the ID obtained when the connection was secured). [OUT] double * dblLimit
Return value	Normal (0:WMT_TRUE) / Error (-1)
Description	The function reads out the current upper limit value which is used to determine the volume change in one step of the Power Control test and stores the value in the variable specified by <i>dblLimit</i> .

6.1.1 CONFigure Subsystem - SIG RF

6.1.1.45 WmtConfSigPowContStepLo

Function name	long WmtConfSigPowContStepLo
Function	Setting a lower limit value which is used to determine the volume change in one step of the Power Control test.
Argument	[IN] long lngID // The identifier for the relevant instrument // (the ID obtained when the connection was secured). double dblLimit // 1.00 to 10.00 [dB]
Return value	Normal (0:WMT_TRUE) / Error (-1)
Description	The function sets a lower limit value which is used to determine the volume change in one step of the Power Control test. The initial value is 2.00 [dB]. If the specified lower limit value is greater than the existing upper limit value, the lower limit value is automatically set to the value which is equal to the upper limit.

6.1.1.46 QryConfSigPowContStepLo

Function name	long QryConfSigPowContStepLo
Function	Reading out the lower limit value which is used to determine the volume change in one step of the Power Control test.
Argument	[IN] long lngID // The identifier for the relevant instrument // (the ID obtained when the connection was secured). [OUT] double * dblLimit
Return value	Normal (0:WMT_TRUE) / Error (-1)
Description	The function reads out the current lower limit value which is used to determine the volume change in one step of the Power Control test and stores the value in the variable specified by <i>dblLimit</i> .

6.1.1.47 WmtConfSigFreqRangUp

Function name	long WmtConfSigFreqRangUp
Function	Setting an upper limit value which is used to determine the frequency range of the TX Output Spectrum - Frequency Range test with the setting for USA, Europe, or Japan.
Argument	[IN] long lngID // The identifier for the relevant instrument // (the ID obtained when the connection was secured). double dblLimit // 2480.000E+6 to 2483.500E+6 [Hz]
Return value	Normal (0:WMT_TRUE) / Error (-1)
Description	The function sets an upper limit value which is used to determine the frequency range of the TX Output Spectrum - Frequency Range test with the setting for USA, Europe, or Japan. The initial value is 2483.500E+6 [Hz]

6.1.1.48 QryConfSigFreqRangUp

Function name	long QryConfSigFreqRangUp
Function	Reading out the upper limit value used to determine the frequency range of the TX Output Spectrum - Frequency Range test with the setting for USA, Europe, or Japan.
Argument	[IN] long lngID // The identifier for the relevant instrument // (the ID obtained when the connection was secured). [OUT] double * dblLimit
Return value	Normal (0:WMT_TRUE) / Error (-1)
Description	The function reads out the current upper limit value which is used to determine the frequency range of the TX Output Spectrum - Frequency Range test with the setting for USA, Europe, or Japan and stores the value in the variable specified by <i>dblLimit</i> .

6.1.1.49 WmtConfSigFreqRangLo

Function name	long WmtConfSigFreqRangLo
Function	Setting a lower limit value which is used to determine the frequency range of the TX Output Spectrum - Frequency Range test with the setting for USA, Europe, or Japan.
Argument	[IN] long lngID // The identifier for the relevant instrument // (the ID obtained when the connection was secured). double dblLimit // 2400.000E+6 to 2402.000E+6 [Hz]
Return value	Normal (0:WMT_TRUE) / Error (-1)
Description	The function sets a lower limit value which is used to determine the frequency range of the TX Output Spectrum - Frequency Range test with the setting for USA, Europe, or Japan. The initial value is 2400.000E+6 [Hz].

6.1.1.50 QryConfSigFreqRangLo

Function name	long QryConfSigFreqRangLo
Function	Reading out the lower limit value which is used to determine the frequency range of the TX Output Spectrum - Frequency Range test with the setting for USA, Europe, or Japan.
Argument	[IN] long lngID // The identifier for the relevant instrument // (the ID obtained when the connection was secured). [OUT] double * dblLimit
Return value	Normal (0:WMT_TRUE) / Error (-1)
Description	The function reads out the current lower limit value which is used to determine the frequency range of the TX Output Spectrum - Frequency Range test with the setting for USA, Europe, or Japan and stores the value in the variable specified by <i>dblLimit</i> .

6.1.1 CONFigure Subsystem - SIG RF

6.1.1.51 WmtConfSigFreqRangFranUp

Function name	long WmtConfSigFreqRangFranUp
Function	Setting an upper limit value which is used to determine the frequency range of the TX Output Spectrum - Frequency Range test with the setting for France.
Argument	[IN] long lngID // The identifier for the relevant instrument // (the ID obtained when the connection was secured). double dblLimit // 2476.000E+6 to 2483.500E+6 [Hz]
Return value	Normal (0:WMT_TRUE) / Error (-1)
Description	The function sets an upper limit value which is used to determine the frequency range of the TX Output Spectrum - Frequency Range test with the setting for France. The initial value is 2483.500E+6 [Hz].

6.1.1.52 QryConfSigFreqRangFranUp

Function name	long QryConfSigFreqRangFranUp
Function	Reading out the upper limit value which is used to determine the frequency range of the TX Output Spectrum - Frequency Range test with the setting for France.
Argument	[IN] long lngID // The identifier for the relevant instrument // (the ID obtained when the connection was secured). [OUT] double * dblLimit
Return value	Normal (0:WMT_TRUE) / Error (-1)
Description	The function reads out the current upper limit value which is used to determine the frequency range of the TX Output Spectrum - Frequency Range test with the setting for France and stores the value in the variable specified by <i>dblLimit</i> .

6.1.1.53 WmtConfSigFreqRangFranLo

Function name	long WmtConfSigFreqRangFranLo
Function	Setting a lower limit value which is used to determine the frequency range of the TX Output Spectrum - Frequency Range test with the setting for France.
Argument	[IN] long lngID // The identifier for the relevant instrument // (the ID obtained when the connection was secured). double dblLimit // 2446.500E+6 to 2454.000E+6 [Hz]
Return value	Normal (0:WMT_TRUE) / Error (-1)
Description	The function sets a lower limit value which is used to determine the frequency range of the TX Output Spectrum - Frequency Range test with the setting for France. The initial value is 2446.500E+6 [Hz].

6.1.1.54 QryConfSigFreqRangFranLo

Function name	long QryConfSigFreqRangFranLo
Function	Reading out the lower limit value which is used to determine the frequency range of the TX Output Spectrum - Frequency Range test with the setting for France.
Argument	[IN] long lngID // The identifier for the relevant instrument // (the ID obtained when the connection was secured). [OUT] double * dblLimit
Return value	Normal (0:WMT_TRUE) / Error (-1)
Description	The function reads out the current lower limit value which is used to determine the frequency range of the TX Output Spectrum - Frequency Range test with the setting for France and stores the value in the variable specified by <i>dblLimit</i> .

6.1.1.55 WmtConfSig20dBBwidUp

Function name	long WmtConfSig20dBBwidUp
Function	Setting an upper limit value which is used to make judgments in the TX Output Spectrum - 20 dB Bandwidth test.
Argument	[IN] long lngID // The identifier for the relevant instrument // (the ID obtained when the connection was secured). double dblLimit // 0.100E+6 to 2.000E+6 [Hz]
Return value	Normal (0:WMT_TRUE) / Error (-1)
Description	The function sets an upper limit value which is used to make judgments in the TX Output Spectrum - 20 dB Bandwidth test. The initial value is 1.000E+6 [Hz].

6.1.1.56 QryConfSig20dBBwidUp

Function name	long QryConfSig20dBBwidUp
Function	Reading out the upper limit value used to make judgments in the TX Output Spectrum - 20 dB Bandwidth test.
Argument	[IN] long lngID // The identifier for the relevant instrument // (the ID obtained when the connection was secured). [OUT] double * dblLimit
Return value	Normal (0:WMT_TRUE) / Error (-1)
Description	The function reads out the current upper limit value which is used to make judgments in the TX Output Spectrum - 20 dB Bandwidth test and stores the value in the variable specified by <i>dblLimit</i> .

6.1.1 CONFigure Subsystem - SIG RF

6.1.1.57 **WmtConfSigACPMN2Up**

Function name	long WmtConfSigACPMN2Up
Function	Setting an upper limit value which is used to make judgments in the TX Output Spectrum - Adjacent Channel Power test, when $ M-N =2$.
Argument	[IN] long lngID // The identifier for the relevant instrument // (the ID obtained when the connection was secured). double dblLimit // -55.00 to -20.00 [dBm]
Return value	Normal (0:WMT_TRUE) / Error (-1)
Description	The function sets an upper limit value which is used to make judgments in the TX Output Spectrum - Adjacent Channel Power test, when $ M-N =2$. The initial value is -20.00 [dBm].

6.1.1.58 **QryConfSigACPMN2Up**

Function name	long QryConfSigACPMN2Up
Function	Reading out the upper limit value which is used to make judgments in the TX Output Spectrum - Adjacent Channel Power test, when $ M-N =2$.
Argument	[IN] long lngID // The identifier for the relevant instrument // (the ID obtained when the connection was secured). [OUT] double * dblLimit
Return value	Normal (0:WMT_TRUE) / Error (-1)
Description	The function reads out the current upper limit value which is used to make judgments in the TX Output Spectrum - Adjacent Channel Power test, when $ M-N =2$ and stores the value in the variable specified by <i>dblLimit</i> .

6.1.1.59 **WmtConfSigACPMN3Up**

Function name	long WmtConfSigACPMN3Up
Function	Setting an upper limit value which is used to make judgments in the TX Output Spectrum - Adjacent Channel Power test, when $ M-N \geq 3$.
Argument	[IN] long lngID // The identifier for the relevant instrument // (the ID obtained when the connection was secured). double dblLimit // -60.00 to -40.00 [dBm]
Return value	Normal (0:WMT_TRUE) / Error (-1)
Description	Setting an upper limit value which is used to make judgments in the TX Output Spectrum - Adjacent Channel Power test, when $ M-N \geq 3$. The initial value is -40.00 [dBm].

6.1.1.60 QryConfSigACPMN3Up

Function name	long QryConfSigACPMN3Up
Function	Reading out the upper limit value which is used to make judgments in the TX Output Spectrum - Adjacent Channel Power test, when $ M-N \geq 3$.
Argument	[IN] long lngID // The identifier for the relevant instrument // (the ID obtained when the connection was secured). [OUT] double * dbILimit
Return value	Normal (0:WMT_TRUE) / Error (-1)
Description	The function reads out the current upper limit value which is used to make judgments in the TX Output Spectrum - Adjacent Channel Power test, when $ M-N \geq 3$ and stores the value in the variable specified by <i>dbILimit</i> .

6.1.1 CONFigure Subsystem - SIG RF

6.1.1.61 WmtConfSigSpurEmisEtsUp

Function name	long WmtConfSigSpurEmisEtsUp
Function	Setting an upper limit value which is used to make judgments in the Out-of-Band Spurious Emissions test when using the ETS setting.
Argument	<pre>[IN] long lngID // The identifier for the relevant instrument // (the ID obtained when the connection was secured). long lngItem // Target range specifications // 0 : Narrow band - 0.03 GHz to 1.00 GHz(OP) // 1 : Narrow band - 1.00 GHz to 12.75 GHz(OP) // 2 : Narrow band - 1.80 GHz to 1.90 GHz(OP) // 3 : Narrow band - 5.15 GHz to 5.30 GHz(OP) // 4 : Wide band - 0.03 GHz to 1.00 GHz(OP) // 5 : Wide band - 1.00 GHz to 12.75 GHz(OP) // 6 : Wide band - 1.80 GHz to 1.90 GHz(OP) // 7 : Wide band - 5.15 GHz to 5.30 GHz(OP) // 8 : Narrow band - 0.03 GHz to 1.00 GHz(SB) // 9 : Narrow band - 1.00 GHz to 12.75 GHz(SB) // 10: Narrow band - 1.80 GHz to 1.90 GHz(SB) // 11: Narrow band - 5.15 GHz to 5.30 GHz(SB) // 12: Wide band - 0.03 GHz to 1.00 GHz(SB) // 13: Wide band - 1.00 GHz to 12.75GHz(SB) // 14: Wide band - 1.80G Hz to 1.90 GHz(SB) // 15: Wide band - 5.15 GHz to 5.30 GHz(SB) // * OP: Operate (operation mode), // SB: Standby (stand by mode) double dblLimit // Narrow band: -65.00 to 0.00 [dBm] // Wide band: -115.00 to 0.00 [dBm/Hz]</pre>
Return value	Normal (0:WMT_TRUE) / Error (-1)
Description	Setting an upper limit value which is used to make judgments in the Out-of-Band Spurious Emissions test when using the ETS method. Different values can be set for different measurement target bands. (Measurement bands are specified by using <i>lngItem</i> .) The initial value is the ETS standard value.

6.1.1.62 QryConfSigSpurEmisEtsUp

Function name	long QryConfSigSpurEmisEtsUp
Function	Reading out the upper limit value which is used to make judgments in the Out-of-Band Spurious Emissions when using the ETS method.
Argument	[IN] long lngID // The identifier for the relevant instrument // (the ID obtained when the connection was secured). long lngItem // Target range specifications: For more information, // refer to WmtConfSigSpurEmisEtsUp. [OUT] double * dblLimit
Return value	Normal (0:WMT_TRUE) / Error (-1)
Description	The function reads out the current upper limit value which is used in the Out-of-Band Spurious Emissions test when using the ETS method and stores the value in the variable specified by <i>dblLimit</i> .

6.1.1.63 WmtConfSigSpurEmisFccUp

Function name	long WmtConfSigSpurEmisFccUp
Function	Setting a judgment value for the Out-of-Band Spurious Emissions test when using the FCC method.
Argument	[IN] long lngID // The identifier for the relevant instrument // (the ID obtained when the connection was secured). double dblLimit // 0.00 to 45.00 [dB]
Return value	Normal (0:WMT_TRUE) / Error (-1)
Description	The function sets a judgment value for the Out-of-Band Spurious Emissions test when using the FCC method. The initial value is 20.00 [dB].

6.1.1.64 QryConfSigSpurEmisFccUp

Function name	long QryConfSigSpurEmisFccUp
Function	Reading out the judgment value of the Out-of-Band Spurious Emissions test when using the FCC method.
Argument	[IN] long lngID // The identifier for the relevant instrument // (the ID obtained when the connection was secured). [OUT] double * dblLimit
Return value	Normal (0:WMT_TRUE) / Error (-1)
Description	The function reads out the current judgment value of the Out-of-Band Spurious Emissions test when using the FCC method and stores the value in the variable specified by <i>dblLimit</i> .

6.1.1 CONFigure Subsystem - SIG RF

6.1.1.65 WmtConfSigSpurEmisSele

Function name	long WmtConfSigSpurEmisSele
Function	Selecting one test method between the ETC and FCC for the Out-of-Band Spurious Emissions test.
Argument	[IN] long lngID // The identifier for the relevant instrument // (the ID obtained when the connection was secured). long lngSpec // 0: ETS // 1: FCC
Return value	Normal (0:WMT_TRUE) / Error (-1)
Description	The function sets a selected test method for the Out-of-Band Spurious Emissions test. The initial value is 0 (ETS).

6.1.1.66 QryConfSigSpurEmisSele

Function name	long QryConfSigSpurEmisSele
Function	Reading out the test method which is used for the Out-of-Band Spurious Emissions test.
Argument	[IN] long lngID // The identifier for the relevant instrument // (the ID obtained when the connection was secured). [OUT] long * lngSpec
Return value	Normal (0:WMT_TRUE) / Error (-1)
Description	The function reads out the current test method which is used for the Out-of-Band Spurious Emissions test and stores the value in the variable specified by <i>lngSpec</i> .

6.1.1.67 WmtConfSigCIPerfBerUp

Function name	long WmtConfSigCIPerfBerUp
Function	Setting an upper limit for the tolerance of the BER (Bit Error Rate) in the C/I Performance test.
Argument	[IN] long lngID // The identifier for the relevant instrument // (the ID obtained when the connection was secured). double dblLimit // 0.0000 to 100.0000 [%]
Return value	Normal (0:WMT_TRUE) / Error (-1)
Description	The function sets an upper limit for the tolerance of the BER (Bit Error Rate) in the C/I Performance test. The initial value is 0.1000 [%].

6.1.1.68 QryConfSigCIPerfBerUp

Function name	long QryConfSigCIPerfBerUp
Function	Reading out the upper limit for the tolerance of the BER (Bit Error Rate) in the C/I Performance test.
Argument	[IN] long lngID // The identifier for the relevant instrument // (the ID obtained when the connection was secured). [OUT] double * dblLimit
Return value	Normal (0:WMT_TRUE) / Error (-1)
Description	The function reads out the current upper limit for the tolerance of the BER (Bit Error Rate) in the C/I Performance test and stores the value in the variable specified by <i>dblLimit</i> .

6.1.1.69 WmtConfSigBlocPerfBerUp

Function name	long WmtConfSigBlocPerfBerUp
Function	Setting an upper limit for the tolerance of the BER (Bit Error Rate) in the Blocking Performance test.
Argument	[IN] long lngID // The identifier for the relevant instrument // (the ID obtained when the connection was secured). double dblLimit // 0.0000 to 100.0000 [%]
Return value	Normal (0:WMT_TRUE) / Error (-1)
Description	The function sets an upper limit for the tolerance of the BER (Bit Error Rate) in the Blocking Performance test. The initial value is 0.1000 [%].

6.1.1.70 QryConfSigBlocPerfBerUp

Function name	long QryConfSigBlocPerfBerUp
Function	Reading out the upper limit for the tolerance of the BER (Bit Error Rate) in the Blocking Performance test.
Argument	[IN] long lngID // The identifier for the relevant instrument // (the ID obtained when the connection was secured). [OUT] double * dblLimit
Return value	Normal (0:WMT_TRUE) / Error (-1)
Description	The function reads out the current upper limit for the tolerance of the BER (Bit Error Rate) in the Blocking Performance test and stores the value in the variable specified by <i>dblLimit</i> .

6.1.1 CONFigure Subsystem - SIG RF

6.1.1.71 WmtConfSigIModPerfBerUp

Function name	long WmtConfSigIModPerfBerUp
Function	Setting the upper limit of the BER (Bit Error Rate) tolerance in the Intermodulation Performance test.
Argument	[IN] long lngID // The identifier for the relevant instrument // (the ID obtained when the connection was secured). double dblLimit // 0.0000 to 100.0000 [%]
Return value	Normal (0:WMT_TRUE) / Error (-1)
Description	The function sets the upper limit of the BER (Bit Error Rate) tolerance in the Intermodulation Performance test. The initial value is 0.1000 [%].

6.1.1.72 QryConfSigIModPerfBerUp

Function name	long QryConfSigIModPerfBerUp
Function	Reading out the upper limit of the BER (Bit Error Rate) tolerance in the Intermodulation Performance test.
Argument	[IN] long lngID // The identifier for the relevant instrument // (the ID obtained when the connection was secured). [OUT] double * dblLimit
Return value	Normal (0:WMT_TRUE) / Error (-1)
Description	The function reads out the current upper limit of the BER (Bit Error Rate) tolerance in the Intermodulation Performance test and stores the value in the variable specified by <i>dblLimit</i> .

6.1.1.73 WmtConfSigOutPowBursLo

Function name	long WmtConfSigOutPowBursLo
Function	Setting a start point for the burst interval where the average power of the Output Power test and the Power Control test is to be acquired.
Argument	[IN] long lngID // The identifier for the relevant instrument // (the ID obtained when the connection was secured). double dblLimit // 0 to 100 [%]
Return value	Normal (0:WMT_TRUE) / Error (-1)
Description	The function sets a start point for the burst interval where the average power of the Output Power test and the Power Control test is to be acquired. The initial value is 20 [%]. If the specified start point is greater than the existing stop point of the burst interval, a start point is automatically set at a value which is less than the stop point.

6.1.1.74 QryConfSigOutpPowBursLo

Function name	long QryConfSigOutpPowBursLo
Function	Reading out the start point of the burst interval where the average power of the Output Power test and the Power Control test is acquired.
Argument	[IN] long lngID // The identifier for the relevant instrument // (the ID obtained when the connection was secured). [OUT] double * dblLimit
Return value	Normal (0:WMT_TRUE) / Error (-1)
Description	The function reads out the current start point of the burst interval where the average power of the Output Power test is acquired and stores the value in the variable specified by <i>dblLimit</i> .

6.1.1.75 WmtConfSigOutpPowBursUp

Function name	long WmtConfSigOutpPowBursUp
Function	Setting a stop point for the burst interval where the average power of the Output Power test and the Power Control test is to be acquired.
Argument	[IN] long lngID // The identifier for the relevant instrument // (the ID obtained when the connection was secured). double dblLimit // 0 to 100 [%]
Return value	Normal (0:WMT_TRUE) / Error (-1)
Description	The function sets a stop point for the burst interval where the average power of the Output Power test and the Power Control test is to be acquired. The initial value is 80 [%]. If the specified stop point is less than the existing start point of the burst interval, a stop point is automatically set at a value which is greater than the start point.

6.1.1.76 QryConfSigOutpPowBursUp

Function name	long QryConfSigOutpPowBursUp
Function	Reading out the stop point of the burst interval where the average power of the Output Power test and the Power Control test is acquired.
Argument	[IN] long lngID // The identifier for the relevant instrument // (the ID obtained when the connection was secured). [OUT] double * dblLimit
Return value	Normal (0:WMT_TRUE) / Error (-1)
Description	The function reads out the current stop point of the burst interval where the average power of the Output Power test is acquired and stores the value in the variable specified by <i>dblLimit</i> .

6.1.1 CONFigure Subsystem - SIG RF

6.1.1.77 WmtConfSigOutpowLeadTrad

Function name	long WmtConfSigOutpowLeadTrad
Function	Setting detection condition for the burst continuation time (burst width) of the Output Power test and the Power Control test.
Argument	[IN] long lngID // The identifier for the relevant instrument // (the ID obtained when the connection was secured). double dblLeadTrad // 0.00 to 40.00 [dB]: Detection condition
Return value	Normal (0:WMT_TRUE) / Error (-1)
Description	The function sets detection condition for the burst continuation time (burst width) of the Output Power test and the Power Control test. The value, <i>dblLeadTrad</i> specifies the relative value for the power and the value which is above the value obtained by subtracting the relative value from the peak power of the burst power is the burst. The initial value is 10.00 [dB].

6.1.1.78 QryConfSigOutpowLeadTrad

Function name	long QryConfSigOutpowLeadTrad
Function	Reading out the detection condition for the burst continuation time (burst width) of the Output Power test and the Power Control test.
Argument	[IN] long lngID // The identifier for the relevant instrument // (the ID obtained when the connection was secured). [OUT] double * dblLeadTrad
Return value	Normal (0:WMT_TRUE) / Error (-1)
Description	The function reads out the current detection condition for the burst continuation time (burst width) of the Output Power test and the Power Control test and stores the value in the variable specified by <i>dblLeadTrad</i> .

6.1.1.79 WmtConfSigOutpowAvgCnt

Function name	long WmtConfSigOutpowAvgCnt
Function	Setting an average count for the spectrum analyzer which is used in the Output Power test and the Power Control test.
Argument	[IN] long lngID // The identifier for the relevant instrument // (the ID obtained when the connection was secured). long lngAvgCnt // 1 to 999
Return value	Normal (0:WMT_TRUE) / Error (-1)
Description	The function sets an average count for the spectrum analyzer which is used in the Output Power test and the Power Control test. The initial value is 20.

6.1.1.80 QryConfSigOutPowAvgCnt

Function name	long QryConfSigOutPowAvgCnt
Function	Reading out the average count for the spectrum analyzer which is used in the Output Power test and the Power Control test.
Argument	[IN] long lngID // The identifier for the relevant instrument // (the ID obtained when the connection was secured). [OUT] long * lngAvgCnt
Return value	Normal (0:WMT_TRUE) / Error (-1)
Description	The function reads out the current average count for the spectrum analyzer which is used in the Output Power test and the Power Control test and stores the value in the variable specified by <i>lngAvgCnt</i> .

6.1.1.81 WmtConfSigPowDensStdPkPowSweeTime

Function name	long WmtConfSigPowDensStdPkPowSweeTime
Function	Setting a sweep continuation time for the spectrum analyzer which is used to acquire the peak power of the Output Power test by using the searched frequency when using the STANDARD mode.
Argument	[IN] long lngID // The identifier for the relevant instrument // (the ID obtained when the connection was secured). double dblSweeTime // 1 to 1000 [sec] : Sweep continuation time
Return value	Normal (0:WMT_TRUE) / Error (-1)
Description	The function sets a sweep continuation time for the spectrum analyzer which is used to acquire the peak power of the Output Power test by using the searched frequency when using the STANDARD mode. The initial value is 60 [sec].

6.1.1.82 QryConfSigPowDensStdPkPowSweeTime

Function name	long QryConfSigPowDensStdPkPowSweeTime
Function	Reading out the sweep continuation time for the spectrum analyzer which is used to acquire the peak power of the Output Power test by using the searched frequency when using the STANDARD mode.
Argument	[IN] long lngID // The identifier for the relevant instrument // (the ID obtained when the connection was secured). [OUT] double * dblSweeTime
Return value	Normal (0:WMT_TRUE) / Error (-1)
Description	The function reads out the sweep continuation time for the spectrum analyzer which is used to acquire the peak power of the Output Power test by using the searched frequency when using the STANDARD mode and stores the value in the variable specified by <i>dblSweeTime</i> .

6.1.1 CONFigure Subsystem - SIG RF

6.1.1.83 **WmtConfSigPowDensStdPkFreqSweeTime**

Function name	long WmtConfSigPowDensStdPkFreqSweeTime
Function	Setting a sweep continuation time for the spectrum analyzer which is used to acquire the frequency of the maximum IUT output in the Output Power test when using the STANDARD mode.
Argument	[IN] long lngID // The identifier for the relevant instrument // (the ID obtained when the connection was secured). double dblSweeTime // 100e+3 to 10000e+3[Hz/S] : Sweep continuation time
Return value	Normal (0:WMT_TRUE) / Error (-1)
Description	The function sets a frequency per second of the sweep time which determines the sweep continuation time of the spectrum analyzer that is used to acquire the frequency of the maximum IUT output in the Output Power test when using the STANDARD mode. The initial value is 100e+3 and the unit is [Hz/S]. The result obtained by dividing SPAN with this value is the sweep time. Ex: When SPAN = 240 MHz and the value to be set is 100 kHz/S (1S/100 kHz) The sweep time of the spectrum analyzer is 240e+6/100e+3 which is 2400S.

6.1.1.84 **QryConfSigPowDensStdPkFreqSweeTime**

Function name	long QryConfSigPowDensStdPkFreqSweeTime
Function	Reading out the sweep continuation time of the spectrum analyzer which is used to acquire the frequency of the maximum IUT output in the Output Power test when using the STANDARD mode.
Argument	[IN] long lngID // The identifier for the relevant instrument // (the ID obtained when the connection was secured). [OUT] double * dblSweeTime
Return value	Normal (0:WMT_TRUE) / Error (-1)
Description	The function reads out the current sweep continuation time (the frequency per second of the sweep time with the unit of [Hz/S]) of the spectrum analyzer which is used to acquire the frequency of the maximum IUT output in the Output Power test when using the STANDARD mode and stores the value in the variable specified by <i>dblSweeTime</i> .

6.1.1.85 WmtConfSigPowDensHspdPkPowSweeTime

Function name	long WmtConfSigPowDensHspdPkPowSweeTime
Function	Setting sweep continuation time of the spectrum analyzer which is used to acquire the peak power in the Output Power test by using the searched frequency when using the HIGH SPEED mode.
Argument	[IN] long lngID // The identifier for the relevant instrument // (the ID obtained when the connection was secured). double dblSweeTime // 1 to 1000 [sec] : Sweep continuation time
Return value	Normal (0:WMT_TRUE) / Error (-1)
Description	The function sets sweep continuation time of the spectrum analyzer which is used to acquire the peak power in the Output Power test by using the searched frequency when using the HIGH SPEED mode. The initial value is 2 [sec].

6.1.1.86 QryConfSigPowDensHspdPkPowSweeTime

Function name	long QryConfSigPowDensHspdPkPowSweeTime
Function	Reading out the sweep continuation time of the spectrum analyzer which is used to acquire the peak power in the Output Power test by using the searched frequency when using the HIGH SPEED mode.
Argument	[IN] long lngID // The identifier for the relevant instrument // (the ID obtained when the connection was secured). [OUT] double * dblSweeTime
Return value	Normal (0:WMT_TRUE) / Error (-1)
Description	The function reads out the current sweep continuation time of the spectrum analyzer which is used to acquire the peak power in the Output Power test by using the searched frequency when using the HIGH SPEED mode and stores the value in the variable specified by <i>dblSweeTime</i> .

6.1.1.87 WmtConfSigPowDensHspdPkFreqSweeTime

Function name	long WmtConfSigPowDensHspdPkFreqSweeTime
Function	Setting sweep continuation time of the spectrum analyzer which is used to acquire the frequency of the maximum IUT output in the Output Power test when using the HIGH SPEED.
Argument	[IN] long lngID // The identifier for the relevant instrument // (the ID obtained when the connection was secured). double dblSweeTime // 100e+3 to 10000e+3[Hz/S] : Sweep continuation time
Return value	Normal (0:WMT_TRUE) / Error (-1)
Description	The function sets a frequency per second of the sweep time which determines the sweep continuation time of the spectrum analyzer to acquire the frequency of the maximum IUT output in the Output Power test when using the HIGH SPEED mode. The initial value is 1000e+3 and the unit is [Hz/S]. The result which is obtained by dividing SPAN with this value is the sweep time.

6.1.1 CONFigure Subsystem - SIG RF

6.1.1.88 QryConfSigPowDensHspdPkFreqSweeTime

Function name	long QryConfSigPowDensHspdPkFreqSweeTime
Function	Reading out the sweep continuation time of the spectrum analyzer which is used to acquire the frequency of the maximum IUT output in the Output Power test by using the HIGH SPEED mode.
Argument	[IN] long lngID // The identifier for the relevant instrument // (the ID obtained when the connection was secured). [OUT] double * dblSweeTime
Return value	Normal (0:WMT_TRUE) / Error (-1)
Description	The function reads out the current sweep continuation time (the frequency per second of the sweep time with the unit of [Hz/S]) of the spectrum analyzer which is used to acquire the frequency of the maximum IUT output in the Output Power test when using the HIGH SPEED mode and stores the value in the variable specified by <i>dblSweeTime</i> .

6.1.1.89 WmtConfSigPowContStepNum

Function name	long WmtConfSigPowContStepNum
Function	Setting a maximum number of steps in the Power Control test.
Argument	[IN] long lngID // The identifier for the relevant instrument // (the ID obtained when the connection was secured). long lngStepNum // 1 to 20 [Step] : Maximum number of steps
Return value	Normal (0:WMT_TRUE) / Error (-1)
Description	The function sets a maximum number of steps in the Power Control test. The initial value is 15 [Step]. The value is not in the SIG standard, but is used to check whether or not all steps have been completed during Decrease Control.

6.1.1.90 QryConfSigPowContStepNum

Function name	long QryConfSigPowContStepNum
Function	Reading out the maximum number of steps in the Power Control test.
Argument	[IN] long lngID // The identifier for the relevant instrument // (the ID obtained when the connection was secured). [OUT] long * lngStepNum
Return value	Normal (0:WMT_TRUE) / Error (-1)
Description	The function reads out the current maximum number of steps for the Power Control test and stores the value in the variable specified by <i>lngStepNum</i> .

6.1.1.91 WmtConfSigPowContStdMinPowUp

Function name	long WmtConfSigPowContStdMinPowUp
Function	Setting a minimum output power of the device for the Power Control test when using the STANDARD mode.
Argument	[IN] long lngID // The identifier for the relevant instrument // (the ID obtained when the connection was secured). double dblLimit // -50.00 to 25.00 [dBm]
Return value	Normal (0:WMT_TRUE) / Error (-1)
Description	The function sets a minimum output power of the device for the Power Control test when using the STANDARD mode. The initial value is -30.00 [dBm]. The value is not in the SIG standard, but is used to check that the minimum power is reached when the device outputs power which is below this level during Decrease Control.

6.1.1.92 QryConfSigPowContStdMinPowUp

Function name	long QryConfSigPowContStdMinPowUp
Function	Reading out the minimum output power of the device in the Power Control test when using the STANDARD mode.
Argument	[IN] long lngID // The identifier for the relevant instrument // (the ID obtained when the connection was secured). [OUT] double * dblLimit
Return value	Normal (0:WMT_TRUE) / Error (-1)
Description	The function reads out the current minimum output power of the device for the Power Control test when using the STANDARD mode and stores the value in the variable specified by <i>dblLimit</i> .

6.1.1.93 WmtConfSigPowContHspdMinPowUp

Function name	long WmtConfSigPowContHspdMinPowUp
Function	Setting a minimum output power of the device for the Power Control test when using the HIGH SPEED mode.
Argument	[IN] long lngID // The identifier for the relevant instrument // (the ID obtained when the connection was secured). double dblLimit // -15.00 to 25.00 [dBm]
Return value	Normal (0:WMT_TRUE) / Error (-1)
Description	The function sets a minimum output power of the device for the Power Control test when using the HIGH SPEED mode. The initial value is -10.00 [dBm]. The value is not in the SIG standard, but is used to check that the minimum power is reached when the device outputs power which is below this level during Decrease Control.

6.1.1 CONFigure Subsystem - SIG RF

6.1.1.94 QryConfSigPowContHspdMinPowUp

Function name	long QryConfSigPowContHspdMinPowUp
Function	Reading out the minimum output power of the device in the Power Control test when using the HIGH SPEED mode.
Argument	[IN] long lngID // The identifier for the relevant instrument // (the ID obtained when the connection was secured). [OUT] double * dblLimit
Return value	Normal (0:WMT_TRUE) / Error (-1)
Description	The function reads out the current minimum output power of the device for the Power Control test when using the HIGH SPEED mode and stores the value in the variable specified by <i>dblLimit</i> .

6.1.1.95 WmtConfSigPowContWaitTout

Function name	long WmtConfSigPowContWaitTout
Function	Setting a time out limit for the power fluctuation wait time after the LMP command transmission in the Power Control test.
Argument	[IN] long lngID // The identifier for the relevant instrument // (the ID obtained when the connection was secured). double dblWaitTout // 0.000 to 0.999 [sec] : Timeout limit setting
Return value	Normal (0:WMT_TRUE) / Error (-1)
Description	The function sets a timeout limit for the power fluctuation wait time after the LMP command transmission in the Power Control test. The initial value is 0.000 [sec] and the resolution is 1 [msec]. The value is not in the SIG standard, but is used as the power fluctuation wait time limit.

6.1.1.96 QryConfSigPowContWaitTout

Function name	long QryConfSigPowContWaitTout
Function	Reading out the time out limit for the power fluctuation wait time after the LMP command transmission in the Power Control test.
Argument	[IN] long lngID // The identifier for the relevant instrument // (the ID obtained when the connection was secured). [OUT] double * dblWaitTout
Return value	Normal (0:WMT_TRUE) / Error (-1)
Description	The function reads out the current time out limit for the power fluctuation wait time after the LMP command transmission in the Power Control test and stores the value in the variable specified by <i>dblWaitTout</i> .

6.1.1.97 WmtConfSigPowContJudgStepNum

Function name	long WmtConfSigPowContJudgStepNum
Function	Setting a switch flag which is used to indicate whether or not to set the Power Control test result to FAIL if the number of steps does not reach the maximum number of steps.
Argument	[IN] long lngID // The identifier for the relevant instrument // (the ID obtained when the connection was secured). long lngJudgStepNum // WMT_OFF(0): OFF / WMT_ON(1): ON
Return value	Normal (0:WMT_TRUE) / Error (-1)
Description	The function sets a switch flag which is used to indicate whether or not to set the Power Control test result to FAIL if the number of steps does not reach the maximum number of steps. The initial value is OFF. The value is not in the SIG standard, but is used to indicate whether or not to set the Power Control test result to FAIL if the test is completed without the number of steps reaching the maximum number of steps.

6.1.1.98 QryConfSigPowContJudgStepNum

Function name	long QryConfSigPowContJudgStepNum
Function	Reading out the switch flag that is used to indicate whether or not to set the Power Control test result to FAIL if the number of steps does not reach the maximum number of steps.
Argument	[IN] long lngID // The identifier for the relevant instrument // (the ID obtained when the connection was secured). [OUT] long * lngJudgStepNum
Return value	Normal (0:WMT_TRUE) / Error (-1)
Description	The function reads out the current setting of the switch flag which is used to indicate whether or not to set the Power Control test result to FAIL if the number of steps does not reach the maximum number of steps and stores the value in the variable specified by <i>lngJudgStepNum</i> .

6.1.1 CONFigure Subsystem - SIG RF

6.1.1.99 WmtConfSigPowContJudgMinPow

Function name	long WmtConfSigPowContJudgMinPow
Function	Setting a switch flag which is used to indicate whether or not to set the Power Control test result to FAIL if the power does not reach below the minimum output power.
Argument	[IN] long lngID // The identifier for the relevant instrument // (the ID obtained when the connection was secured). long lngJudgMinPow // WMT_OFF(0): OFF / WMT_ON(1): ON
Return value	Normal (0:WMT_TRUE) / Error (-1)
Description	The function sets a switch flag which is used to indicate whether or not to set the Power Control test result to FAIL if the power does not reach below the minimum output power. The initial value is OFF. The value is not in the SIG standard, but is used to indicate whether or not to result the Power Control test as FAIL if the test is completed without the power reaching the level that is below the minimum output power.

6.1.1.100 QryConfSigPowContJudgMinPow

Function name	long QryConfSigPowContJudgMinPow
Function	Reading out the switch flag that is used to indicate whether or not to set the Power Control test result to FAIL if the power does not reach below the minimum output power.
Argument	[IN] long lngID // The identifier for the relevant instrument // (the ID obtained when the connection was secured). [OUT] long * lngJudgMinPow
Return value	Normal (0:WMT_TRUE) / Error (-1)
Description	The function reads out the current setting of the switch flag which is used to indicate whether or not to set the Power Control test result to FAIL if the power does not reach below the minimum output power and stores the value in the variable specified by <i>lngJudgMinPow</i> .

6.1.1.101 WmtConfSigFreqRangLev

Function name	long WmtConfSigFreqRangLev
Function	Setting a power level which is recognized as the minimum or maximum frequency in the TX Output Spectrum - Frequency Range test.
Argument	[IN] long lngID // The identifier for the relevant instrument // (the ID obtained when the connection was secured). double dblLev // -60.00 to 0.00 [dBm/100kHz] : Power level
Return value	Normal (0:WMT_TRUE) / Error (-1)
Description	The function sets a power level which is recognized as the minimum or maximum frequency in the TX Output Spectrum - Frequency Range test. The initial value is -30.00 [dBm/100kHz] and the resolution is 0.01 [dBm/100kHz].

6.1.1.102 QryConfSigFreqRangLev

Function name	long QryConfSigFreqRangLev
Function	Reading out the power level which is recognized as the minimum or maximum frequency in the TX Output Spectrum - Frequency Range test.
Argument	[IN] long lngID // The identifier for the relevant instrument // (the ID obtained when the connection was secured). [OUT] double * dbILev
Return value	Normal (0:WMT_TRUE) / Error (-1)
Description	The function reads out the power level which is recognized as the minimum or maximum frequency in the TX Output Spectrum - Frequency Range test and stores the value in the variable specified by <i>dbILev</i> .

6.1.1.103 WmtConfSigFreqRangSweeCnt

Function name	long WmtConfSigFreqRangSweeCnt
Function	Setting a number of the sweep count for the spectrum analyzer in the TX Output Spectrum - Frequency Range test.
Argument	[IN] long lngID // The identifier for the relevant instrument // (the ID obtained when the connection was secured). long lngSweeCnt // 1 to 999 Resolution: 1
Return value	Normal (0:WMT_TRUE) / Error (-1)
Description	The function sets a number of the sweep count for the spectrum analyzer in the TX Output Spectrum - Frequency Range test. The initial value is 50.

6.1.1.104 QryConfSigFreqRangSweeCnt

Function name	long QryConfSigFreqRangSweeCnt
Function	Reading out the number of the sweep count for the spectrum analyzer in the TX Output Spectrum - Frequency Range test.
Argument	[IN] long lngID // The identifier for the relevant instrument // (the ID obtained when the connection was secured). [OUT] long * lngSweeCnt
Return value	Normal (0:WMT_TRUE) / Error (-1)
Description	The function reads out the number of the sweep count for the spectrum analyzer in the TX Output Spectrum - Frequency Range test and stores the value in the variable specified by <i>lngSweeCnt</i> .

6.1.1 CONFigure Subsystem - SIG RF

6.1.1.105 WmtConfSig20dBBwidLev

Function name	long WmtConfSig20dBBwidLev
Function	Setting a power level which is used to measure the bandwidth of the TX Output Spectrum - 20 dB Bandwidth test.
Argument	[IN] long lngID // The identifier for the relevant instrument // (the ID obtained when the connection was secured). double dblLev // 0.00 to 60.00 [dB] : Power level
Return value	Normal (0:WMT_TRUE) / Error (-1)
Description	The function sets a power level which is used to measure the bandwidth of the TX Output Spectrum - 20 dB Bandwidth test. The initial value is 20.00 [dB] and the resolution is 0.01 [dB].

6.1.1.106 QryConfSig20dBBwidLev

Function name	long QryConfSig20dBBwidLev
Function	Reading out the power level which is used to measure the bandwidth of the TX Output Spectrum - 20 dB Bandwidth test.
Argument	[IN] long lngID // The identifier for the relevant instrument // (the ID obtained when the connection was secured). [OUT] double * dblLev
Return value	Normal (0:WMT_TRUE) / Error (-1)
Description	The function reads out the current power level which is used to measure the bandwidth of the TX Output Spectrum - 20 dB Bandwidth test and stores the value in the variable specified by <i>dblLev</i> .

6.1.1.107 WmtConfSigACPNumAdCh

Function name	long WmtConfSigACPNumAdCh
Function	Setting the channel range, which is used to measure (adjacent channels) in the TX Output Spectrum - Adjacent Channel Power test when using the STANDARD mode.
Argument	[IN] long lngID // The identifier for the relevant instrument // (the ID obtained when the connection was secured). long lngNumAdCh // 2 to 75 : Channel range
Return value	Normal (0:WMT_TRUE) / Error (-1)
Description	The function sets the channel range, which is used to measure (adjacent channels) in the TX Output Spectrum - Adjacent Channel Power test when using the STANDARD mode. The initial value is 75.

6.1.1.108 QryConfSigACPNumAdCh

Function name	long QryConfSigACPNumAdCh
Function	Reading out the channel range which is used to measure (adjacent channels) in the TX Output Spectrum - Adjacent Channel Power test when using the STANDARD mode.
Argument	[IN] long lngID // The identifier for the relevant instrument // (the ID obtained when the connection was secured). [OUT] long * lngNumAdCh
Return value	Normal (0:WMT_TRUE) / Error (-1)
Description	The function reads out the channel range which is used to measure (adjacent channels) in the TX Output Spectrum - Adjacent Channel Power test when using the STANDARD mode and stores the value in the variable specified by <i>lngNumAdCh</i> .

6.1.1.109 WmtConfSigSpurEmisEtsHspdFreq

Function name	long WmtConfSigSpurEmisEtsHspdFreq
Function	Setting a frequency which is used to measure in the Out-of-Band Spurious Emissions test (ETS) when using the HIGH SPEED mode.
Argument	[IN] long lngID // The identifier for the relevant instrument // (the ID obtained when the connection was secured). long lngNum // 1 to 20: Array element number double dblFreq // 30.000e+6 to 2446.500e+6, 2483.500e+6 to 12750.000e+6 [Hz]
Return value	Normal (0:WMT_TRUE) / Error (-1)
Description	The function sets a frequency which is used to measure in the Out-of-Band Spurious Emissions test (ETS) when using the HIGH SPEED mode. Resolution: 0.001e+6 [Hz]

6.1.1.110 QryConfSigSpurEmisEtsHspdFreq

Function name	long QryConfSigSpurEmisEtsHspdFreq
Function	Reading out the frequency which is the subject for measurement in the Out-of-Band Spurious Emissions test (ETS) when using the HIGH SPEED mode.
Argument	[IN] long lngID // The identifier for the relevant instrument // (the ID obtained when the connection was secured). long lngNum // 1 to 20 : Array element number [OUT] double * dblFreq
Return value	Normal (0:WMT_TRUE) / Error (-1)
Description	The function reads out the frequency which is the current subject for measurement in the Out-of-Band Spurious Emissions test (ETS) when using the HIGH SPEED mode and stores the value in the variable specified by <i>dblFreq</i> .

6.1.1 CONFigure Subsystem - SIG RF

6.1.1.111 WmtConfSigSpurEmisEtsStdFreqLo

Function name	long WmtConfSigSpurEmisEtsStdFreqLo
Function	Setting the frequency range (Low side), which is used to measure in the Out-of-Band Spurious Emissions test (ETS) when using the STANDARD mode.
Argument	[IN] long lngID // The identifier for the relevant instrument // (the ID obtained when the connection was secured). double dblFreq // 30.000e+6 to 12750.000e+6[Hz] : Frequency (Low side)
Return value	Normal (0:WMT_TRUE) / Error (-1)
Description	The function sets the frequency range (Low side), which is used to measure in the Out-of-Band Spurious Emissions test (ETS) when using the STANDARD mode. The initial value is 30.000e+6[Hz] and the resolution is 0.001e+6 [Hz]. If the specified value is greater than the value which already exists on the Upper side, a value that is less than the existing value is automatically set.

6.1.1.112 QryConfSigSpurEmisEtsStdFreqLo

Function name	long QryConfSigSpurEmisEtsStdFreqLo
Function	Reading out the frequency range (Low side) which is measured in the Out-of-Band Spurious Emissions test (ETS) when using the STANDARD mode.
Argument	[IN] long lngID // The identifier for the relevant instrument // (the ID obtained when the connection was secured). [OUT] double * dblFreq
Return value	Normal (0:WMT_TRUE) / Error (-1)
Description	The function reads out the current frequency range (Low side) to be measured in the Out-of-Band Spurious Emissions test (ETS) when using the STANDARD mode and stores the value in the variable specified by <i>dblFreq</i> .

6.1.1.113 WmtConfSigSpurEmisEtsStdFreqUp

Function name	long WmtConfSigSpurEmisEtsStdFreqUp
Function	Setting the frequency range (Upper side), which is used to measure in the Out-of-Band Spurious Emissions test (ETS) when using the STANDARD mode.
Argument	[IN] long lngID // The identifier for the relevant instrument // (the ID obtained when the connection was secured). double dblFreq // 30.000e+6 to 12750.000e+6[Hz]: Frequency (Upper side)
Return value	Normal (0:WMT_TRUE) / Error (-1)
Description	The function sets the frequency range (Upper side), which is used to measure in the Out-of-Band Spurious Emissions test (ETS) when using the STANDARD mode. The initial value is 12750.000e+6 [Hz] and the resolution is 0.001e+6 [Hz]. If the specified value is less than the value which already exists on the Low side, a value that is greater than the existing value is automatically set.

6.1.1.114 QryConfSigSpurEmisEtsStdFreqUp

Function name	long QryConfSigSpurEmisEtsStdFreqUp
Function	Reading out the frequency range (Upper side) which is used to measure in the Out-of-Band Spurious Emissions test (ETS) when using the STANDARD mode.
Argument	[IN] long lngID // The identifier for the relevant instrument // (the ID obtained when the connection was secured). [OUT] double * dblFreq
Return value	Normal (0:WMT_TRUE) / Error (-1)
Description	The function reads out the current frequency range (Upper side) to be measured in the Out-of-Band Spurious Emissions test (ETS) when using the STANDARD mode and stores the value in the variable specified by <i>dblFreq</i> .

6.1.1.115 WmtConfSigSpurEmisFccHspdFreq

Function name	long WmtConfSigSpurEmisFccHspdFreq
Function	Setting a frequency range which is measured in the Out-of-Band Spurious Emissions test (FCC) when using the HIGH SPEED mode.
Argument	[IN] long lngID // The identifier for the relevant instrument // (the ID obtained when the connection was secured). long lngNum // 1 to 20 : Array element number double dblFreq // 30.000e+6 to 2400.000e+6, 2483.500e+6 to 25000.000e+6 [Hz]
Return value	Normal (0:WMT_TRUE) / Error (-1)
Description	The function sets a frequency range which is measured in the Out-of-Band Spurious Emissions test (FCC) when using the HIGH SPEED mode. Resolution: 0.001e+6 [Hz]

6.1.1 CONFigure Subsystem - SIG RF

6.1.1.116 QryConfSigSpurEmisFccHspdFreq

Function name	long QryConfSigSpurEmisFccHspdFreq
Function	Reading out the frequency range which is measured in the Out-of-Band Spurious Emissions test (FCC) when using the HIGH SPEED mode.
Argument	[IN] long lngID // The identifier for the relevant instrument // (the ID obtained when the connection was secured). long lngNum // 1 to 20 : Array element number [OUT] double * dblFreq
Return value	Normal (0:WMT_TRUE) / Error (-1)
Description	The function reads out the current setting of the frequency range which is measured in the Out-of-Band Spurious Emissions test (FCC) when using the HIGH SPEED mode and stores the value in the variable specified by <i>dblFreq</i> .

6.1.1.117 WmtConfSigSpurEmisFccStdFreqLo

Function name	long WmtConfSigSpurEmisFccStdFreqLo
Function	Setting the frequency range (Low side), which is measured in the Out-of-Band Spurious Emissions test (FCC) when using the STANDARD mode.
Argument	[IN] long lngID // The identifier for the relevant instrument // (the ID obtained when the connection was secured). double dblFreq // 30.000e+6 to 25000.000e+6[Hz]: Frequency (Low side)
Return value	Normal (0:WMT_TRUE) / Error (-1)
Description	The function sets the frequency range (Low side), which is measured in the Out-of-Band Spurious Emissions test (FCC) when using the STANDARD mode. The initial value is 30.000e+6 [Hz] and the resolution is 0.001e+6 [Hz]. If the specified value is greater than the value which already exists on the Upper side, a value that is less than the existing value is automatically set.

6.1.1.118 QryConfSigSpurEmisFccStdFreqLo

Function name	long QryConfSigSpurEmisFccStdFreqLo
Function	Reading out the frequency range (Low side) which is measured in the Out-of-Band Spurious Emissions test (FCC) when using the STANDARD mode.
Argument	[IN] long lngID // The identifier for the relevant instrument // (the ID obtained when the connection was secured). [OUT] double * dblFreq
Return value	Normal (0:WMT_TRUE) / Error (-1)
Description	The function reads out the current frequency range (Low side) to be measured in the Out-of-Band Spurious Emissions test (FCC) when using the STANDARD mode and stores the value in the variable specified by <i>dblFreq</i> .

6.1.1.119 WmtConfSigSpurEmisFccStdFreqUp

Function name	long WmtConfSigSpurEmisFccStdFreqUp
Function	Setting a frequency range (Upper side) which is measured in the Out-of-Band Spurious Emissions test (FCC) when using the STANDARD mode.
Argument	[IN] long lngID // The identifier for the relevant instrument // (the ID obtained when the connection was secured). double dblFreq // 30.000e+6 to 25000.000e+6[Hz]: Frequency (Upper side)
Return value	Normal (0:WMT_TRUE) / Error (-1)
Description	The function sets a frequency range (Upper side) which is measured in the Out-of-Band Spurious Emissions test (FCC) when using the STANDARD mode. The initial value is 25000.000e+6 [Hz] and the resolution is 0.001e+6 [Hz]. If the specified value is less than the value which already exists on the Low side, a value that is greater than the existing value is automatically set.

6.1.1.120 QryConfSigSpurEmisFccStdFreqUp

Function name	long QryConfSigSpurEmisFccStdFreqUp
Function	Reading out the frequency range (Upper side) which is measured in the Out-of-Band Spurious Emissions test (FCC) when using the STANDARD mode.
Argument	[IN] long lngID // The identifier for the relevant instrument // (the ID obtained when the connection was secured). [OUT] double * dblFreq
Return value	Normal (0:WMT_TRUE) / Error (-1)
Description	The function reads out the current setting of the frequency range (Upper side) which is measured in the Out-of-Band Spurious Emissions test (FCC) when using the STANDARD mode and stores the value in the variable specified by <i>dblFreq</i> .

6.1.1.121 WmtConfSigCIPerfImagFreq

Function name	long WmtConfSigCIPerfImagFreq
Function	Setting an imaginary frequency which is used in the C/I Performance test.
Argument	[IN] long lngID // The identifier for the relevant instrument // (the ID obtained when the connection was secured). long lngNum // 1 to 3 : Array element number double dblFreq // 2402e+6 to 2480e+6 [Hz] : Imaginary frequency
Return value	Normal (0:WMT_TRUE) / Error (-1)
Description	The function sets an imaginary frequency which is used in the C/I Performance test. The resolution 1e+6 [Hz].

6.1.1 CONFigure Subsystem - SIG RF

6.1.1.122 QryConfSigCIPerfImagFreq

Function name	long QryConfSigCIPerfImagFreq
Function	Reading out the imaginary frequency which is used in the C/I Performance test.
Argument	[IN] long IngID // The identifier for the relevant instrument // (the ID obtained when the connection was secured). long IngNum // 1 to 3 : Array element number [OUT] double * dblFreq
Return value	Normal (0:WMT_TRUE) / Error (-1)
Description	The function reads out the imaginary frequency which is used in the C/I Performance test and stores the value in the variable specified by <i>dblFreq</i> .

6.1.1.123 WmtConfSigCIPerfWantLev

Function name	long WmtConfSigCIPerfWantLev
Function	Setting Wanted Signal Level (a targeting signal level) in the C/I Performance test.
Argument	[IN] long IngID // The identifier for the relevant instrument // (the ID obtained when the connection was secured). long IngItem // Setting items // 0: C/I co-channel // 1: C/I 1 MHz // 2: C/I 2 MHz // 3: C/I ≥ 3 MHz // 4: C/I Image // 5: C/I Image ±1 MHz double dblWantLev // SIG standard value ±10.00 [dB]: Targeting signal level
Return value	Normal (0:WMT_TRUE) / Error (-1)
Description	The function sets Wanted Signal Level (a targeting signal level) in the C/I Performance test. The resolution 0.01 [dB] and the initial value is the SIG standard value. For information on SIG standard values, refer to “Test Specification” in SIG Document.

6.1.1.124 QryConfSigCIPerfWantLev

Function name	long QryConfSigCIPerfWantLev
Function	Reading out Wanted Signal Level (the targeting signal level) in the C/I Performance test.
Argument	[IN] long lngID // The identifier for the relevant instrument // (the ID obtained when the connection was secured). long lngItem // For specification items, refer to WmtConfSigCIPerfWantLev. [OUT] double * dblWantLev
Return value	Normal (0:WMT_TRUE) / Error (-1)
Description	The function reads out the current setting of Wanted Signal Level (the targeting signal level) in the C/I Performance test and stores the value in the variable specified by <i>dblWantLev</i> .

6.1.1.125 WmtConfSigCIPerfInteLev

Function name	long WmtConfSigCIPerfInteLev
Function	Setting Interfere Level (an interference wave level: normal) in the C/I Performance test.
Argument	[IN] long lngID // The identifier for the relevant instrument // (the ID obtained when the connection was secured). long lngItem // Setting items // 0: C/I co-channel // 1: C/I 1 MHz // 2: C/I 2 MHz // 3: C/I ≥ 3 MHz // 4: C/I Image // 5: C/I Image ± 1 MHz double dblInteLev // SIG standard value ±10.00 [dB]: Interference wave level
Return value	Normal (0:WMT_TRUE) / Error (-1)
Description	The function sets Interfere Level (an interference wave level: normal) in the C/I Performance test. The resolution 0.01 [dB] and the initial value is the SIG standard value. For information on SIG standard values, refer to “Test Specification” in SIG Document.

6.1.1 CONFigure Subsystem - SIG RF

6.1.1.126 QryConfSigCIPerfInteLev

Function name	long QryConfSigCIPerfInteLev
Function	Reading out Interfere Level (the interference wave level: normal) in the C/I Performance test.
Argument	[IN] long lngID // The identifier for the relevant instrument // (the ID obtained when the connection was secured). long lngItem // For specification items, refer to WmtConfSigCIPerfInteLev. [OUT] double * dblInteLev
Return value	Normal (0:WMT_TRUE) / Error (-1)
Description	The function reads out the current setting of Interfere Level (the interference wave level: normal) in the C/I Performance test and stores the value in the variable specified by <i>dblInteLev</i> .

6.1.1.127 WmtConfSigCIPerfInteRelaLev

Function name	long WmtConfSigCIPerfInteRelaLev
Function	Setting Interference Level (interference wave level: Relaxed) in the C/I Performance test.
Argument	[IN] long lngID // The identifier for the relevant instrument // (the ID obtained when the connection was secured). long lngItem // Setting items // 2: C/I 2 MHz // 3: C/I ≥ 3 MHz // 4: C/I Image // 5: C/I Image ± 1 MHz double dblInteLev // SIG standard value ± 10.00 [dB]; Interference wave // level (Relaxed)
Return value	Normal (0:WMT_TRUE) / Error (-1)
Description	The function sets Interference Level (interference wave level: Relaxed) in the C/I Performance test. The resolution is 0.01 [dB] and the initial value is the SIG standard value. For information on SIG standard values, refer to "Test Specification" in SIG Document.

6.1.1.128 QryConfSigCIPerfInteRelaLev

Function name	long QryConfSigCIPerfInteRelaLev
Function	Reading out Interference Level (interference wave level: Relaxed) in the C/I Performance test.
Argument	[IN] long lngID // The identifier for the relevant instrument // (the ID obtained when the connection was secured). long lngItem // For specification items, refer to // WmtConfSigCIPerfInteRelaLev. [OUT] double * dblInteLev
Return value	Normal (0:WMT_TRUE) / Error (-1)
Description	The function reads out the current Interference Level (interference wave level: Relaxed) in the C/I Performance test and stores the value in the variable specified by <i>dblInteLev</i> .

6.1.1.129 WmtConfSigBlocPerfWantLev

Function name	long WmtConfSigBlocPerfWantLev
Function	Setting Wanted Signal Level (a targeting signal level) in the Blocking Performance test.
Argument	[IN] long lngID // The identifier for the relevant instrument // (the ID obtained when the connection was secured). double dblWantLev // Signal level // <CH1> // (-93.00 -(Cable Loss)) to (-13.00 -(Cable Loss)) [dBm] // <CH2> // (-76.00 -(Cable Loss)) to (+4.00 -(Cable Loss)) [dBm]
Return value	Normal (0:WMT_TRUE) / Error (-1)
Description	The function sets Wanted Signal Level (a targeting signal level) in the Blocking Performance test. the resolution is 0.01 [dB] and the initial value is -67.00 [dBm]. The range is determined by subtracting the cable loss value from the base range which is -93.00 to -13.00 [dBm], and 17 [dB] added if CH2 is specified for the RF Port setting. Ex.) If the cable loss = 5 dB and CH2 is selected, the input range is -81.00 to -1.00 dBm.

6.1.1 CONFigure Subsystem - SIG RF

6.1.1.130 QryConfSigBlocPerfWantLev

Function name	long QryConfSigBlocPerfWantLev
Function	Reading out Wanted Signal Level (the targeting signal level) in the Blocking Performance test.
Argument	[IN] long lngID // The identifier for the relevant instrument // (the ID obtained when the connection was secured). [OUT] double * dblWantLev
Return value	Normal (0:WMT_TRUE) / Error (-1)
Description	The function reads out the current setting of Wanted Signal Level (the targeting signal level) in the Blocking Performance test and stores the value in the variable specified by <i>dblWantLev</i> .

6.1.1.131 WmtConfSigBlocPerfInteLev

Function name	long WmtConfSigBlocPerfInteLev
Function	Setting Interference Level (interference wave level) in the Blocking Performance test.
Argument	[IN] long lngID // The identifier for the relevant instrument // (the ID obtained when the connection was secured). long lngFreqBand // Frequency band // 0: 30 MHz-2000 MHz // 1: 2000 MHz-2400 MHz // 2: 2500 MHz-3000 MHz // 3: 3000 MHz-12.75 GHz long lngLevNum // Level 1: Level1 // 2: Level2 // 3: Level3 double dblInteLev // -60.00 to -5.00 [dBm] : Interference signal level
Return value	Normal (0:WMT_TRUE) / Error (-1)
Description	The function sets Interference Level (interference wave level) in the Blocking Performance test. the resolution is 0.01 [dB] and the initial value is the SIG standard value. For information on SIG standard values, refer to “Test Specification” in SIG Document.

6.1.1.132 QryConfSigBlocPerfInteLev

Function name	long QryConfSigBlocPerfInteLev
Function	Reading out Interference Level (interference wave level) in the Blocking Performance test.
Argument	[IN] long lngID // The identifier for the relevant instrument // (the ID obtained when the connection was secured). long lngFreqBand // Frequency band: (Refer to WmtConfSigBlocPerfInteLev) long lngLevNum // Level (Level: Refer to WmtConfSigBlocPerfInteLev) [OUT] double * dblInteLev
Return value	Normal (0:WMT_TRUE) / Error (-1)
Description	The function reads out the current Interference Level (interference wave level) in the Blocking Performance test and stores the value in the variable specified by <i>dblInteLev</i> .

6.1.1.133 WmtConfSigIModPerfWantLev

Function name	long WmtConfSigIModPerfWantLev
Function	Setting Wanted Signal Level (a targeting signal level) in the Intermodulation Performance test.
Argument	[IN] long lngID // The identifier for the relevant instrument // (the ID obtained when the connection was secured). double dblWantLev // Signal level // <CH1> // (-93.00 -(Cable Loss)) to (-13.00 -(Cable Loss)) [dBm] // <CH2> // (-76.00 -(Cable Loss)) to (+4.00 -(Cable Loss)) [dBm]
Return value	Normal (0:WMT_TRUE) / Error (-1)
Description	The function sets Wanted Signal Level (a targeting signal level) in the Intermodulation Performance test. The resolution is 0.01 [dB] and the initial value is -64.00 [dBm]. The range is determined by subtracting the cable loss value from the base range which is -93.00 to -13.00 [dBm], and 17 [dB] added if CH2 is specified for the RF Port setting. Ex.) If the cable loss = 5 dB and CH2 is selected, the input range is -81.00 to -1.00 dBm.

6.1.1 CONFigure Subsystem - SIG RF

6.1.1.134 QryConfSigIModPerfWantLev

Function name	long QryConfSigIModPerfWantLev
Function	Reading out Wanted Signal Level (the targeting signal level) in the Intermodulation Performance test.
Argument	[IN] long lngID // The identifier for the relevant instrument // (the ID obtained when the connection was secured). double * dblWantLev
Return value	Normal (0:WMT_TRUE) / Error (-1)
Description	The function reads out the current setting of Wanted Signal Level (the targeting signal level) in the Intermodulation Performance test and stores the value in the variable specified by <i>dblWantLev</i> .

6.1.1.135 WmtConfSigIModPerfF1Lev

Function name	long WmtConfSigIModPerfF1Lev
Function	Setting a level for the sign wave signal (f1) in the Intermodulation Performance test.
Argument	[IN] long lngID // The identifier for the relevant instrument // (the ID obtained when the connection was secured). double dblF1Lev // -60.00 to -5.00 [dBm] : Level
Return value	Normal (0:WMT_TRUE) / Error (-1)
Description	The function sets a level for the sign wave signal (f1) in the Intermodulation Performance test. The initial value is -39.00 [dBm] and the resolution is 0.01 [dB].

6.1.1.136 QryConfSigIModPerfF1Lev

Function name	long QryConfSigIModPerfF1Lev
Function	Reading out the level of the sign wave signal (f1) in the Intermodulation Performance test.
Argument	[IN] long lngID // The identifier for the relevant instrument // (the ID obtained when the connection was secured). [OUT] double * dblF1Lev
Return value	Normal (0:WMT_TRUE) / Error (-1)
Description	The function reads out the current level of the sign wave signal (f1) in the Intermodulation Performance test and stores the value in the variable specified by <i>dblF1Lev</i> .

6.1.1.137 WmtConfSigIModPerfF2Lev

Function name	long WmtConfSigIModPerfF2Lev
Function	Setting a level for the Bluetooth modulation signal (f2) in the Intermodulation Performance test.
Argument	[IN] long lngID // The identifier for the relevant instrument // (the ID obtained when the connection was secured). double dblF2Lev // -60.00 to -5.00 [dBm] : Level
Return value	Normal (0:WMT_TRUE) / Error (-1)
Description	The function sets a level for the Bluetooth modulation signal (f2) in the Intermodulation Performance test. The initial value is -39.00 [dBm] and the resolution is 0.01 [dB].

6.1.1.138 QryConfSigIModPerfF2Lev

Function name	long QryConfSigIModPerfF2Lev
Function	Reading out the level of the Bluetooth modulation signal (f2) in the Intermodulation Performance test.
Argument	[IN] long lngID // The identifier for the relevant instrument // (the ID obtained when the connection was secured). [OUT] double * dblF2Lev
Return value	Normal (0:WMT_TRUE) / Error (-1)
Description	The function reads out the current level of the Bluetooth modulation signal (f2) in the Intermodulation Performance test and stores the value in the variable specified by <i>dblF2Lev</i> .

6.1.1.139 WmtConfSigBlocPerfSmpAlc

Function name	long WmtConfSigBlocPerfSmpAlc
Function	Setting the SMR (SMP) ALC to ON or OFF in the Blocking Performance test.
Argument	[IN] long lngID // The identifier for the relevant instrument // (the ID obtained when the connection was secured). long lngOnOff
Return value	Normal (0:WMT_TRUE) / Error (-1)
Description	The function sets the SMR (SMP) ALC to ON or OFF in the Blocking Performance test. The value is either 1(WMT_ON) or 0(WMT_OFF). The initial value is 1.

6.1.1 CONFigure Subsystem - SIG RF

6.1.1.140 QryConfSigBlocPerfSmpAlc

Function name	long QryConfSigBlocPerfSmpAlc
Function	Reading out the ON or OFF setting of SMR (SMP) ALC in the Blocking Performance test.
Argument	[IN] long lngID // The identifier for the relevant instrument // (the ID obtained when the connection was secured). [OUT] long * lngOnOff
Return value	Normal (0:WMT_TRUE) / Error (-1)
Description	The function reads out the current ON or OFF setting of SMR (SMP) ALC in the Blocking Performance test and stores the value in the variable specified by <i>lngOnOff</i> .

6.1.1.141 WmtConfSigPowDensTestPack

Function name	long WmtConfSigPowDensTestPack
Function	Setting the measurement packet which is used in the Power Density test.
Argument	[IN] long lngID // The identifier for the relevant instrument // (the ID obtained when the connection was secured). long lngPack // 0x00000001: DH1 // 0x00000002: DH3 // 0x00000004: DH5
Return value	Normal (0:WMT_TRUE) / Error (-1)
Description	The function sets the measurement packet which is used in the Power Density test. The initial value is 0x00000004 (DH5).

6.1.1.142 QryConfSigPowDensTestPack

Function name	long QryConfSigPowDensTestPack
Function	Reading out the measurement packet which is used in the Power Density test.
Argument	[IN] long lngID // The identifier for the relevant instrument // (the ID obtained when the connection was secured). [OUT] long * lngPack
Return value	Normal (0:WMT_TRUE) / Error (-1)
Description	The function reads out the current measurement packet which is used in the Power Density test and stores the value in the variable specified by <i>lngPack</i> .

6.1.1.143 WmtConfSigPowContTestPack

Function name	long WmtConfSigPowContTestPack
Function	Setting the measurement packet which is used in the Power Control test.
Argument	[IN] long lngID // The identifier for the relevant instrument // (the ID obtained when the connection was secured). long lngPack // 0x00000001: DH1 // 0x00000002: DH3 // 0x00000004: DH5
Return value	Normal (0:WMT_TRUE) / Error (-1)
Description	The function sets the measurement packet which is used in the Power Control test. The initial value is 0x00000001 (DH1).

6.1.1.144 QryConfSigPowContTestPack

Function name	long QryConfSigPowContTestPack
Function	Reading out the measurement packet which is used in the Power Control test.
Argument	[IN] long lngID // The identifier for the relevant instrument // (the ID obtained when the connection was secured). [OUT] long * lngPack
Return value	Normal (0:WMT_TRUE) / Error (-1)
Description	The function reads out the current measurement packet which is used in the Power Control test and stores the value in the variable specified by <i>lngPack</i> .

6.1.1.145 WmtConfSigFreqRangTestPack

Function name	long WmtConfSigFreqRangTestPack
Function	Setting the measurement packet which is used in the TX Output Spectrum - Frequency Range test.
Argument	[IN] long lngID // The identifier for the relevant instrument // (the ID obtained when the connection was secured). long lngPack // 0x00000001: DH1 // 0x00000002: DH3 // 0x00000004: DH5
Return value	Normal (0:WMT_TRUE) / Error (-1)
Description	The function sets the measurement packet which is used in the TX Output Spectrum - Frequency Range test. The initial value is 0x00000004 (DH5).

6.1.1 CONFigure Subsystem - SIG RF

6.1.1.146 QryConfSigFreqRangTestPack

Function name	long QryConfSigFreqRangTestPack
Function	Reading out the measurement packet which is used in the TX Output Spectrum - Frequency Range test.
Argument	[IN] long lngID // The identifier for the relevant instrument // (the ID obtained when the connection was secured). [OUT] long * lngPack
Return value	Normal (0:WMT_TRUE) / Error (-1)
Description	The function reads out the current measurement packet which is used in the TX Output Spectrum - Frequency Range test and stores the value in the variable specified by <i>lngPack</i> .

6.1.1.147 WmtConfSig20dBBwidTestPack

Function name	long WmtConfSig20dBBwidTestPack
Function	Setting the measurement packet which is used in the TX Output Spectrum - 20dB Bandwidth test.
Argument	[IN] long lngID // The identifier for the relevant instrument // (the ID obtained when the connection was secured). long lngPack // 0x00000001: DH1 // 0x00000002: DH3 // 0x00000004: DH5
Return value	Normal (0:WMT_TRUE) / Error (-1)
Description	The function sets the measurement packet which is used in the TX Output Spectrum - 20dB Bandwidth test. The initial value is 0x00000004 (DH5).

6.1.1.148 QryConfSig20dBBwidTestPack

Function name	long QryConfSig20dBBwidTestPack
Function	Reading out the measurement packet which is used in the TX Output Spectrum - 20dB Bandwidth test.
Argument	[IN] long lngID // The identifier for the relevant instrument // (the ID obtained when the connection was secured). [OUT] long * lngPack
Return value	Normal (0:WMT_TRUE) / Error (-1)
Description	The function reads out the current measurement packet which is used in the TX Output Spectrum - 20dB Bandwidth test and stores the value in the variable specified by <i>lngPack</i> .

6.1.1.149 WmtConfSigACPTestPack

Function name	long WmtConfSigACPTestPack
Function	Setting the measurement packet which is used in the TX Output Spectrum - Adjacent Channel Power test.
Argument	[IN] long IngID // The identifier for the relevant instrument // (the ID obtained when the connection was secured). long IngPack // 0x00000001: DH1 // 0x00000002: DH3 // 0x00000004: DH5
Return value	Normal (0:WMT_TRUE) / Error (-1)
Description	The function sets the measurement packet which is used in the TX Output Spectrum - Adjacent Channel Power test. The initial value is 0x00000001 (DH1).

6.1.1.150 QryConfSigACPTestPack

Function name	long QryConfSigACPTestPack
Function	Reading out the measurement packet which is used in the TX Output Spectrum - Adjacent Channel Power test.
Argument	[IN] long IngID // The identifier for the relevant instrument // (the ID obtained when the connection was secured). [OUT] long * IngPack
Return value	Normal (0:WMT_TRUE) / Error (-1)
Description	The function reads out the current measurement packet which is used in the TX Output Spectrum - Adjacent Channel Power test and stores the value in the variable specified by <i>IngPack</i> .

6.1.1.151 WmtConfSigSpurEmisTestPack

Function name	long WmtConfSigSpurEmisTestPack
Function	Setting the measurement packet which is used in the Out-of-band Spurious Emissions test.
Argument	[IN] long IngID // The identifier for the relevant instrument // (the ID obtained when the connection was secured). long IngPack // 0x00000001: DH1 // 0x00000002: DH3 // 0x00000004: DH5
Return value	Normal (0:WMT_TRUE) / Error (-1)
Description	The function sets the measurement packet which is used in the Out-of-band Spurious Emissions test. The initial value is 0x00000001 (DH1).

6.1.1 CONFigure Subsystem - SIG RF

6.1.1.152 QryConfSigSpurEmisTestPack

Function name	long QryConfSigSpurEmisTestPack
Function	Reading out the measurement packet which is used in the Out-of-band Spurious Emissions test.
Argument	[IN] long lngID // The identifier for the relevant instrument // (the ID obtained when the connection was secured). [OUT] long * lngPack
Return value	Normal (0:WMT_TRUE) / Error (-1)
Description	The function reads out the current measurement packet which is used in the Out-of-band Spurious Emissions test and stores the value in the variable specified by <i>lngPack</i> .

6.1.1.153 WmtConfSigCIPerfTestPack

Function name	long WmtConfSigCIPerfTestPack
Function	Setting the measurement packet which is used in the C/I performance test.
Argument	[IN] long lngID // The identifier for the relevant instrument // (the ID obtained when the connection was secured). long lngPack // 0x00000001: DH1 // 0x00000002: DH3 // 0x00000004: DH5
Return value	Normal (0:WMT_TRUE) / Error (-1)
Description	The function sets the measurement packet which is used in the C/I performance test. The initial value is 0x00000001 (DH1).

6.1.1.154 QryConfSigCIPerfTestPack

Function name	long QryConfSigCIPerfTestPack
Function	Reading out the measurement packet which is used in the C/I performance test.
Argument	[IN] long lngID // The identifier for the relevant instrument // (the ID obtained when the connection was secured). [OUT] long * lngPack
Return value	Normal (0:WMT_TRUE) / Error (-1)
Description	The function reads out the current measurement packet which is used in the C/I performance test and stores the value in the variable specified by <i>lngPack</i> .

6.1.1.155 WmtConfSigBlocPerfTestPack

Function name	long WmtConfSigBlocPerfTestPack
Function	Setting the measurement packet which is used in the Blocking performance test.
Argument	[IN] long lngID // The identifier for the relevant instrument // (the ID obtained when the connection was secured). long lngPack // 0x00000001: DH1 // 0x00000002: DH3 // 0x00000004: DH5
Return value	Normal (0:WMT_TRUE) / Error (-1)
Description	The function sets the measurement packet which is used in the Blocking performance test. The initial value is 0x00000001 (DH1).

6.1.1.156 QryConfSigBlocPerfTestPack

Function name	long QryConfSigBlocPerfTestPack
Function	Reading out the measurement packet which is used in the Blocking performance test.
Argument	[IN] long lngID // The identifier for the relevant instrument // (the ID obtained when the connection was secured). [OUT] long * lngPack
Return value	Normal (0:WMT_TRUE) / Error (-1)
Description	The function reads out the current measurement packet which is used in the Blocking performance test and stores the value in the variable specified by <i>lngPack</i> .

6.1.1.157 WmtConfSigIModPerfTestPack

Function name	long WmtConfSigIModPerfTestPack
Function	Setting the measurement packet which is used in the Intermodulation performance test.
Argument	[IN] long lngID // The identifier for the relevant instrument // (the ID obtained when the connection was secured). long lngPack // 0x00000001: DH1 // 0x00000002: DH3 // 0x00000004: DH5
Return value	Normal (0:WMT_TRUE) / Error (-1)
Description	The function sets the measurement packet which is used in the Intermodulation performance test. The initial value is 0x00000001 (DH1).

6.1.1 CONFigure Subsystem - SIG RF

6.1.1.158 QryConfSigIModPerfTestPack

Function name	long QryConfSigIModPerfTestPack
Function	Reading out the measurement packet which is used in the Intermodulation performance test.
Argument	[IN] long lngID // The identifier for the relevant instrument // (the ID obtained when the connection was secured). [OUT] long * lngPack
Return value	Normal (0:WMT_TRUE) / Error (-1)
Description	The function reads out the current measurement packet which is used in the Intermodulation performance test and stores the value in the variable specified by <i>lngPack</i> .

6.1.2 PROCedure Subsystem - SIG RF

6.1.2.1 WmtProcSigPowDens

Function name	long WmtProcSigPowDens
Function	Executing the Output Power test.
Argument	[IN] long lngID // The identifier for the relevant instrument // (the ID obtained when the connection was secured).
Return value	Normal (0:WMT_TRUE) / Error (-1)
Description	The function executes the Output Power test.

6.1.2.2 WmtProcSigPowCont

Function name	long WmtProcSigPowCont
Function	Executing the Power Control test.
Argument	[IN] long lngID // The identifier for the relevant instrument // (the ID obtained when the connection was secured). long lngPoint // Operation frequency setting // 0x00: ALL (All 3 points of Low, Mid, and High.) // 0x01: LOW (Lowest operating frequency) // 0x02: MID (Mid operating frequency) // 0x03: HIGH (Highest operating frequency)
Return value	Normal (0:WMT_TRUE) / Error (-1)
Description	The function executes the Power Control test which excludes operation frequencies whose test executions are set to OFF by the user.

6.1.2.3 WmtProcSigFreqRang

Function name	long WmtProcSigFreqRang
Function	Executing the TX Output Spectrum - Frequency Range test.
Argument	[IN] long lngID // The identifier for the relevant instrument // (the ID obtained when the connection was secured).
Return value	Normal (0:WMT_TRUE) / Error (-1)
Description	The function executes the TX Output Spectrum - Frequency Range test.

6.1.2 PROCedure Subsystem - SIG RF

6.1.2.4 WmtProcSig20dBBwid

Function name	long WmtProcSig20dBBwid
Function	Executing the TX Output Spectrum - 20 dB Bandwidth test.
Argument	[IN] long IngID // The identifier for the relevant instrument // (the ID obtained when the connection was secured). long IngPoint // Operation frequency setting // 0x00: ALL (All 3 points of Low, Mid, and High.) // 0x01: LOW (Lowest operating frequency) // 0x02: MID (Mid operating frequency) // 0x03: HIGH (Highest operating frequency)
Return value	Normal (0:WMT_TRUE) / Error (-1)
Description	The function executes the TX Output Spectrum - 20 dB Bandwidth test which excludes operation frequencies whose test executions are set to OFF by the user.

6.1.2.5 WmtProcSigACP

Function name	long WmtProcSigACP
Function	Executing the TX Output Spectrum - Adjacent Channel Power test.
Argument	[IN] long IngID // The identifier for the relevant instrument // (the ID obtained when the connection was secured). long IngPoint // Operation frequency setting // 0x00: ALL (All 3 points of Low, Mid, and High.) // 0x01: LOW (Lowest operating frequency) // 0x02: MID (Mid operating frequency) // 0x03: HIGH (Highest operating frequency)
Return value	Normal (0:WMT_TRUE) / Error (-1)
Description	The function executes the Adjacent Channel Power test which excludes operation frequencies whose test executions are set to OFF by the user.

6.1.2.6 WmtProcSigSpurEmis

Function name	long WmtProcSigSpurEmis
Function	Executing the Out-of-Band Spurious Emissions test.
Argument	[IN] long lngID // The identifier for the relevant instrument // (the ID obtained when the connection was secured). long lngPoint // Operation frequency setting // 0x00: ALL 0x00: (All 3 points of Low, Mid, and // High and Standby) // 0x01: LOW (Lowest operating frequency) // 0x02: MID (Mid operating frequency) // 0x03: HIGH (Highest operating frequency) // 0xFF: Standby (the ETS Stand-by mode)
Return value	Normal (0:WMT_TRUE) / Error (-1)
Description	The function executes the Out-of-Band Spurious Emissions test unless the operation frequency is set to OFF by the user or is in the stand-by mode.

6.1.2.7 WmtProcSigCIPerf

Function name	long WmtProcSigCIPerf
Function	Executing the C/I Performance test.
Argument	[IN] long lngID // The identifier for the relevant instrument // (the ID obtained when the connection was secured). long lngPoint // Operation frequency setting // 0x00: ALL (All 3 points of Low, Mid, and High.) // 0x01: LOW (Lowest operating frequency) // 0x02: MID (Mid operating frequency) // 0x03: HIGH (Highest operating frequency)
Return value	Normal (0:WMT_TRUE) / Error (-1)
Description	The function executes the C/I Performance test which excludes operation frequencies whose test executions are set to OFF by the user.

6.1.2 PROCedure Subsystem - SIG RF

6.1.2.8 WmtProcSigBlocPerf

Function name	long WmtProcSigBlocPerf
Function	Executing the Blocking Performance test.
Argument	[IN] long lngID // The identifier for the relevant instrument // (the ID obtained when the connection was secured).
Return value	Normal (0:WMT_TRUE) / Error (-1)
Description	The function executes the Blocking Performance test which excludes operation frequencies whose test executions are set to OFF by the user.

6.1.2.9 WmtProcSigIModPerf

Function name	long WmtProcSigIModPerf
Function	Executing the Intermodulation Performance test.
Argument	[IN] long lngID // The identifier for the relevant instrument // (the ID obtained when the connection was secured). long lngPoint // Operation frequency setting // 0x00: ALL (All 3 points of Low, Mid, and High.) // 0x01: LOW (Lowest operating frequency) // 0x02: MID (Mid operating frequency) // 0x03: HIGH (Highest operating frequency)
Return value	Normal (0:WMT_TRUE) / Error (-1)
Description	The function executes the Intermodulation Performance test which excludes operation frequencies whose test executions are set to OFF by the user.

6.1.3 FETCh Subsystem - SIG RF

6.1.3.1 QryFetcSigPowDens

Function name	long QryFetcSigPowDens
Function	Reading out the result (power density) of the Output Power test.
Argument	[IN] long lngID // The identifier for the relevant instrument // (the ID obtained when the connection was secured). [OUT] double * dbIPow
Return value	Normal (0:WMT_TRUE) / Error (-1)
Description	The function reads out the result (power density) of the Output Power test and stores the value in the variable specified by <i>dbIPow</i> .

6.1.3.2 QryFetcSigPowContNumDown

Function name	long QryFetcSigPowContNumDown
Function	Reading out the result (number of steps in Decrease Control) of the Power Control test.
Argument	[IN] long lngID // The identifier for the relevant instrument // (the ID obtained when the connection was secured). long lngPoint // Operation frequency setting // 0x01: LOW (Lowest operating frequency) // 0x02: MID (Mid operating frequency) // 0x03: HIGH (Highest operating frequency) // ALL cannot be set. [OUT] long * lngStep
Return value	Normal (0:WMT_TRUE) / Error (-1)
Description	The function reads out the result (number of steps in Decrease Control) of the Power Control test and stores the value in the variable specified by <i>lngStep</i> .

6.1.3 FETCh Subsystem - SIG RF

6.1.3.3 QryFetcSigPowContPavDown

Function name	long QryFetcSigPowContPavDown
Function	Reading out the result (power output for each step in Decrease Control) of the Power Control test.
Argument	<pre>[IN] long lngID // The identifier for the relevant instrument // (the ID obtained when the connection was secured). long lngPoint // Operation frequency setting // 0x01: LOW (Lowest operating frequency) // 0x02: MID (Mid operating frequency) // 0x03: HIGH (Highest operating frequency) // ALL cannot be set. long lngNum // The number of steps which indicate the target to read. [OUT] double * dblPow</pre>
Return value	Normal (0:WMT_TRUE) / Error (-1)
Description	The function reads out the result (power output for each step in Decrease Control) of the Power Control test and stores the value in the variable specified by <i>dblPow</i> .

6.1.3.4 QryFetcSigPowContNumUp

Function name	long QryFetcSigPowContNumUp
Function	Reading out the result (number of steps in Increase Control) of the Power Control test.
Argument	<pre>[IN] long lngID // The identifier for the relevant instrument // (the ID obtained when the connection was secured). long lngPoint // Operation frequency setting // 0x01: LOW (Lowest operating frequency) // 0x02: MID (Mid operating frequency) // 0x03: HIGH (Highest operating frequency) // ALL cannot be set. [OUT] long * lngStep</pre>
Return value	Normal (0:WMT_TRUE) / Error (-1)
Description	The function reads out the result (number of steps in Increase Control) of the Power Control test and stores the value in the variable specified by <i>lngStep</i> .

6.1.3.5 QryFetcSigPowContPavUp

Function name	long QryFetcSigPowContPavUp
Function	Reading out the result (power output for each step in Increase Control) of the Power Control test.
Argument	<p>[IN] long lngID // The identifier for the relevant instrument // (the ID obtained when the connection was secured).</p> <p>long lngPoint // Operation frequency setting // 0x01: LOW (Lowest operating frequency) // 0x02: MID (Mid operating frequency) // 0x03: HIGH (Highest operating frequency) // ALL cannot be set.</p> <p>long lngNum // The number of steps which indicates the target to read.</p> <p>[OUT] double * dblPow</p>
Return value	Normal (0:WMT_TRUE) / Error (-1)
Description	The function reads out the result (power output for each step in Increase Control) of the Power Control test and stores the value in the variable specified by <i>dblPow</i> .

6.1.3.6 QryFetcSigPowContPavMin

Function name	long QryFetcSigPowContPavMin
Function	Reading out the result (minimum power output after Decrease Control) of the Power Control test.
Argument	<p>[IN] long lngID // The identifier for the relevant instrument // (the ID obtained when the connection was secured).</p> <p>long lngPoint // Operation frequency setting // 0x01: LOW (Lowest operating frequency) // 0x02: MID (Mid operating frequency) // 0x03: HIGH (Highest operating frequency) // ALL cannot be set.</p> <p>[OUT] double * dblPow</p>
Return value	Normal (0:WMT_TRUE) / Error (-1)
Description	The function reads out the result (minimum power output after Decrease Control) of the Power Control test and stores the value in the variable specified by <i>dblPow</i> .

6.1.3 FETCh Subsystem - SIG RF

6.1.3.7 QryFetcSigFreqRangLowFreq

Function name	long QryFetcSigFreqRangLowFreq
Function	Reading out the result (minimum output frequency) of the TX Output Spectrum - Frequency Range test.
Argument	[IN] long lngID // The identifier for the relevant instrument // (the ID obtained when the connection was secured). [OUT] double * dblFreq
Return value	Normal (0:WMT_TRUE) / Error (-1)
Description	The function reads out the result (minimum output frequency) of the TX Output Spectrum - Frequency Range test and stores the value in the variable specified by <i>dblFreq</i> .

6.1.3.8 QryFetcSigFreqRangHiFreq

Function name	long QryFetcSigFreqRangHiFreq
Function	Reading out the result (maximum output frequency) of the TX Output Spectrum - Frequency Range test.
Argument	[IN] long lngID // The identifier for the relevant instrument // (the ID obtained when the connection was secured). [OUT] double * dblFreq
Return value	Normal (0:WMT_TRUE) / Error (-1)
Description	The function reads out the result (maximum output frequency) of the TX Output Spectrum - Frequency Range test and stores the value in the variable specified by <i>dblFreq</i> .

6.1.3.9 QryFetcSig20dBBwid

Function name	long QryFetcSig20dBBwid
Function	Reading out the result (bandwidth) of the TX Output Spectrum - 20 dB Bandwidth test.
Argument	[IN] long lngID // The identifier for the relevant instrument // (the ID obtained when the connection was secured). long lngPoint // Operation frequency setting // 0x01: LOW (Lowest operating frequency) // 0x02: MID (Mid operating frequency) // 0x03: HIGH (Highest operating frequency) // ALL cannot be set. [OUT] double * dblFreq
Return value	Normal (0:WMT_TRUE) / Error (-1)
Description	The function reads out the result (bandwidth) of the TX Output Spectrum - 20 dB Bandwidth test and stores the value in the variable specified by <i>dblFreq</i> .

6.1.3.10 QryFetcSigACPMN2Lo

Function name	long QryFetcSigACPMN2Lo
Function	Reading out the result (ACP for when M-N = -2) of the TX Output Spectrum - Adjacent Channel Power test.
Argument	<pre>[IN] long lngID // The identifier for the relevant instrument // (the ID obtained when the connection was secured). long lngPoint // Operation frequency setting // 0x01: LOW (Lowest operating frequency) // 0x02: MID (Mid operating frequency) // 0x03: HIGH (Highest operating frequency) // ALL cannot be set. [OUT] double * dblAcp</pre>
Return value	Normal (0:WMT_TRUE) / Error (-1)
Description	The function reads out the result (ACP for when M-N = -2) of the TX Output Spectrum - Adjacent Channel Power test and stores the value in the variable specified by <i>dblAcp</i> .

6.1.3.11 QryFetcSigACPMN2Hi

Function name	long QryFetcSigACPMN2Hi
Function	Reading out the result (ACP for when M-N = +2) of the TX Output Spectrum - Adjacent Channel Power test.
Argument	<pre>[IN] long lngID // The identifier for the relevant instrument // (the ID obtained when the connection was secured). long lngPoint // Operation frequency setting // 0x01: LOW (Lowest operating frequency) // 0x02: MID (Mid operating frequency) // 0x03: HIGH (Highest operating frequency) // ALL cannot be set. [OUT] double * dblAcp</pre>
Return value	Normal (0:WMT_TRUE) / Error (-1)
Description	The function reads out the result (ACP for when M-N = +2) of the TX Output Spectrum - Adjacent Channel Power test and stores the value in the variable specified by <i>dblAcp</i> .

6.1.3 FETCh Subsystem - SIG RF

6.1.3.12 QryFetcSigACPMN3Lo

Function name	long QryFetcSigACPMN3Lo
Function	Reading out the result (ACP for when M-N = -3) of the TX Output Spectrum - Adjacent Channel Power test.
Argument	[IN] long lngID // The identifier for the relevant instrument // (the ID obtained when the connection was secured). long lngPoint // Operation frequency setting // 0x01: LOW (Lowest operating frequency) // 0x02: MID (Mid operating frequency) // 0x03: HIGH (Highest operating frequency) // ALL cannot be set. [OUT] double * dblAcp
Return value	Normal (0:WMT_TRUE) / Error (-1)
Description	The function reads out the result (ACP for when M-N = -3) of the TX Output Spectrum - Adjacent Channel Power test and stores the value in the variable specified by <i>dblAcp</i> .

6.1.3.13 QryFetcSigACPMN3Hi

Function name	long QryFetcSigACPMN3Hi
Function	Reading out the result (ACP for when M-N = +3) of the TX Output Spectrum - Adjacent Channel Power test.
Argument	[IN] long lngID // The identifier for the relevant instrument // (the ID obtained when the connection was secured). long lngPoint // Operation frequency setting // 0x01: LOW (Lowest operating frequency) // 0x02: MID (Mid operating frequency) // 0x03: HIGH (Highest operating frequency) // ALL cannot be set. [OUT] double * dblAcp
Return value	Normal (0:WMT_TRUE) / Error (-1)
Description	The function reads out the result (ACP for when M-N = +3) of the TX Output Spectrum - Adjacent Channel Power test and stores the value in the variable specified by <i>dblAcp</i> .

6.1.3.14 QryFetcSigACPNum

Function name	long QryFetcSigACPNum
Function	Reading out the number of results which can be read in the TX Output Spectrum - Adjacent Channel Power test under the condition: $ M-N >3$.
Argument	<p>[IN] long lngID // The identifier for the relevant instrument // (the ID obtained when the connection was secured).</p> <p>long lngPoint // Operation frequency setting // 0x01: LOW (Lowest operating frequency) // 0x02: MID (Mid operating frequency) // 0x03: HIGH (Highest operating frequency) // ALL cannot be set.</p> <p>[OUT] long * lngNum</p>
Return value	Normal (0:WMT_TRUE) / Error (-1)
Description	The function reads out the number of results which can be read in the TX Output Spectrum - Adjacent Channel Power test under the condition: $ M-N >3$ and stores the value in the variable specified <i>lngNum</i> .

6.1.3.15 QryFetcSigACPACP

Function name	long QryFetcSigACPACP
Function	Reading out the result (ACP) of the TX Output Spectrum - Adjacent Channel Power test which can be read under the condition: $ M-N >3$.
Argument	<p>[IN] long lngID // The identifier for the relevant instrument // (the ID obtained when the connection was secured).</p> <p>long lngPoint // Operation frequency setting // 0x01: LOW (Lowest operating frequency) // 0x02: MID (Mid operating frequency) // 0x03: HIGH (Highest operating frequency) // ALL cannot be set.</p> <p>long lngNum // The element number of the array to read out.</p> <p>[OUT] double * dblAcp</p>
Return value	Normal (0:WMT_TRUE) / Error (-1)
Description	The function reads out the result (ACP) of the TX Output Spectrum - Adjacent Channel Power test which can be read under the condition: $ M-N >3$ and stores the value in the variable specified by <i>dblAcp</i> .

6.1.3 FETCh Subsystem - SIG RF

6.1.3.16 QryFetcSigACPCH

Function name	long QryFetcSigACPCH
Function	Reading out the result (CH) of the TX Output Spectrum - Adjacent Channel Power test which can be read under the condition: $ M-N >3$.
Argument	[IN] long lngID // The identifier for the relevant instrument // (the ID obtained when the connection was secured). long lngPoint // Operation frequency setting // 0x01: LOW (Lowest operating frequency) // 0x02: MID (Mid operating frequency) // 0x03: HIGH (Highest operating frequency) // ALL cannot be set. long lngNum // The element number of the array to read out. [OUT] long * lngCh
Return value	Normal (0:WMT_TRUE) / Error (-1)
Description	The function reads out the result (CH) of the TX Output Spectrum - Adjacent Channel Power test which can be read under the condition: $ M-N >3$ and stores the value in the variable specified by <i>lngCh</i> .

6.1.3.17 QryFetcSigSpurEmisSele

Function name	long QryFetcSigSpurEmisSele
Function	Reading out the test method (ETC or FCC) for after the Out-of-Band Spurious Emissions test.
Argument	[IN] long lngID // The identifier for the relevant instrument // (the ID obtained when the connection was secured). [OUT] long * lngMeas // 0: ETS // 1: FCC
Return value	Normal (0:WMT_TRUE) / Error (-1)
Description	The function reads out the test method (ETC or FCC) after the Out-of-Band Spurious Emissions test and stores the value in the variable specified by <i>lngMeas</i> .

6.1.3.18 QryFetcSigSpurEmisFreq

Function name	long QryFetcSigSpurEmisFreq
Function	Reading out the result (spurious frequency) of the Out-of-Band Spurious Emissions test.
Argument	<pre> [IN] long lngID // The identifier for the relevant instrument // (the ID obtained when the connection was secured). long lngPoint // Operation frequency setting // 0x01: LOW (Lowest operating frequency) // 0x02: MID (Mid operating frequency) // 0x03: HIGH (Highest operating frequency) // 0xFF: Standby (the ETS Stand-by mode) // ALL cannot be set. long lngNum // The element number of the array which is read out. // < ETS > // 0 : Narrow band - 0.03 GHz to 1.00 GHz // 1 : Narrow band - 1.00 GHz to 12.75 GHz // 2 : Narrow band - 1.80 GHz to 1.90 GHz // 3 : Narrow band - 5.15 GHz to 5.30 GHz // 4 : Wide band - 0.03 GHz to 1.00 GHz // 5 : Wide band - 1.00 GHz to 12.75 GHz // 6 : Wide band - 1.80 GHz to 1.90 GHz // 7 : Wide band - 5.15 GHz to 5.30 GHz // < FCC > // 1 to 15 [OUT] double * dblFreq </pre>
Return value	Normal (0:WMT_TRUE) / Error (-1)
Description	The function reads out the result (spurious frequency) of the Out-of-Band Spurious Emissions test and stores the value in the variable specified by <i>dblFreq</i> .

6.1.3 FETCh Subsystem - SIG RF

6.1.3.19 QryFetcSigSpurEmisPow

Function name	long QryFetcSigSpurEmisPow
Function	Reading out the result (spurious power) of the Out-of-Band Spurious Emissions test.
Argument	<pre> [IN] long IngID // The identifier for the relevant instrument // (the ID obtained when the connection was secured). long IngPoint // Operation frequency setting // 0x01: LOW (Lowest operating frequency) // 0x02: MID (Mid operating frequency) // 0x03: HIGH (Highest operating frequency) // 0xFF: Standby (the ETS Stand-by mode) // ALL cannot be set. long IngNum // The element number of the array which is read out. // < ETS > // 0 : Narrow band - 0.03 GHz to 1.00 GHz // 1 : Narrow band - 1.00 GHz to 12.75 GHz // 2 : Narrow band - 1.80 GHz to 1.90 GHz // 3 : Narrow band - 5.15 GHz to 5.30 GHz // 4 : Wide band - 0.03 GHz to 1.00 GHz // 5 : Wide band - 1.00 GHz to 12.75 GHz // 6 : Wide band - 1.80 GHz to 1.90 GHz // 7 : Wide band - 5.15 GHz to 5.30 GHz // < FCC > // 1 to 15 [OUT] double * dblPow </pre>
Return value	Normal (0:WMT_TRUE) / Error (-1)
Description	The function reads out the result (spurious power) of the Out-of-Band Spurious Emissions test and stores the value in the variable specified by <i>dblPow</i> .

6.1.3.20 QryFetcSigSpurEmisFccRefPow

Function name	long QryFetcSigSpurEmisFccRefPow
Function	Reading out the reference level at each point during the Out-of-Band Spurious Emissions test.
Argument	<p>[IN] long lngID // The identifier for the relevant instrument // (the ID obtained when the connection was secured).</p> <p>long lngPoint // Operation frequency setting // 0x01: LOW (Lowest operating frequency) // 0x02: MID (Mid operating frequency) // 0x03: HIGH (Highest operating frequency) // ALL cannot be set.</p> <p>[OUT] double * dblPow</p>
Return value	Normal (0:WMT_TRUE) / Error (-1)
Description	The function reads out the reference level at each point during the Out-of-Band Spurious Emissions test and stores the value in the variable specified by <i>dblPow</i> . This measurement value is set only when performing FCC measurements.

6.1.3.21 QryFetcSigCIPerfSumErr

Function name	long QryFetcSigCIPerfSumErr
Function	Reading out the number of error data items whose BER surpassed the limit value in the C/I Performance test.
Argument	<p>[IN] long lngID // The identifier for the relevant instrument // (the ID obtained when the connection was secured).</p> <p>long lngPoint // Operation frequency setting // 0x01: LOW (Lowest operating frequency) // 0x02: MID (Mid operating frequency) // 0x03: HIGH (Highest operating frequency) // ALL cannot be set.</p> <p>[OUT] long * lngSum</p>
Return value	Normal (0:WMT_TRUE) / Error (-1)
Description	The function reads out the number of error data items whose BER surpassed the limit value in the C/I Performance test and stores the value in the variable specified by <i>lngSum</i> .

6.1.3 FETCh Subsystem - SIG RF

6.1.3.22 QryFetcSigCIPerfCh

Function name	long QryFetcSigCIPerfCh
Function	Reading out measurement channels in the C/I Performance test.
Argument	<pre>[IN] long lngID // The identifier for the relevant instrument // (the ID obtained when the connection was secured). long lngPoint // Operation frequency setting // 0x01: LOW (Lowest operating frequency) // 0x02: MID (Mid operating frequency) // 0x03: HIGH (Highest operating frequency) // ALL cannot be set. long lngNum // 1 to 16 : The element number of the array which is read out. [OUT] long * lngCh</pre>
Return value	Normal (0:WMT_TRUE) / Error (-1)
Description	The function reads out measurement channels (0 to 78) in the C/I Performance test and stores the value in the variable specified by <i>lngCh</i> .

6.1.3.23 QryFetcSigCIPerfBer

Function name	long QryFetcSigCIPerfBer
Function	Reading out the result (BER) of the C/I Performance test.
Argument	<pre>[IN] long lngID // The identifier for the relevant instrument // (the ID obtained when the connection was secured). long lngPoint // Operation frequency setting // 0x01: LOW (Lowest operating frequency) // 0x02: MID (Mid operating frequency) // 0x03: HIGH (Highest operating frequency) // ALL cannot be set. long lngNum // 1 to 16 : The element number of the array which is read out. [OUT] double * dblBer // [%]</pre>
Return value	Normal (0:WMT_TRUE) / Error (-1)
Description	Reading out the result (BER) of the C/I Performance test and stores the value in the variable specified by <i>dblBer</i> .

6.1.3.24 QryFetcSigCIPerfPer

Function name	long QryFetcSigCIPerfPer
Function	Reading out the result (PER) of the C/I Performance test.
Argument	<p>[IN] long lngID // The identifier for the relevant instrument // (the ID obtained when the connection was secured).</p> <p>long lngPoint // Operation frequency setting // 0x01: LOW (Lowest operating frequency) // 0x02: MID (Mid operating frequency) // 0x03: HIGH (Highest operating frequency) // ALL cannot be set.</p> <p>long lngNum // 1 to 16 : The element number of the array which is read out.</p> <p>[OUT] double * dblPer // [%]</p>
Return value	Normal (0:WMT_TRUE) / Error (-1)
Description	Reading out the result (PER) of the C/I Performance test and stores the value in the variable specified by <i>dblPer</i> .

6.1.3.25 QryFetcSigCIPerfSumErrRela

Function name	long QryFetcSigCIPerfSumErrRela
Function	Reading out the number of error data items whose BER surpassed the limit in the C/I Performance test with the Relaxed measurement setting.
Argument	<p>[IN] long lngID // The identifier for the relevant instrument // (the ID obtained when the connection was secured).</p> <p>long lngPoint // Operation frequency setting // 0x01: LOW (Lowest operating frequency) // 0x02: MID (Mid operating frequency) // 0x03: HIGH (Highest operating frequency) // ALL cannot be set.</p> <p>[OUT] long * lngSum</p>
Return value	Normal (0:WMT_TRUE) / Error (-1)
Description	Reading out the number of error data items whose BER surpassed the limit in the C/I Performance test with the Relaxed measurement setting and stores the value in the variable specified by <i>lngSum</i> .

6.1.3 FETCh Subsystem - SIG RF

6.1.3.26 QryFetcSigCIPerfBerRela

Function name	long QryFetcSigCIPerfBerRela
Function	Reading out the result (BER at the Relaxed measurement setting) of the C/I Performance test.
Argument	[IN] long lngID // The identifier for the relevant instrument // (the ID obtained when the connection was secured). long lngPoint // Operation frequency setting // 0x01: LOW (Lowest operating frequency) // 0x02: MID (Mid operating frequency) // 0x03: HIGH (Highest operating frequency) // ALL cannot be set. long lngNum // 1 to 16 : The element number of the array which is read out. [OUT] double * dblBer // [%]
Return value	Normal (0:WMT_TRUE) / Error (-1)
Description	The function reads out the result (BER at the Relaxed measurement setting) of the C/I Performance test and stores the value in the variable specified by <i>dblBer</i> .

6.1.3.27 QryFetcSigCIPerfPerRela

Function name	long QryFetcSigCIPerfPerRela
Function	Reading out the result (PER at the Relaxed measurement setting) of the C/I Performance test.
Argument	[IN] long lngID // The identifier for the relevant instrument // (the ID obtained when the connection was secured). long lngPoint // Operation frequency setting // 0x01: LOW (Lowest operating frequency) // 0x02: MID (Mid operating frequency) // 0x03: HIGH (Highest operating frequency) // ALL cannot be set. long lngNum // 1 to 16 : The element number of the array which is read out. [OUT] double * dblPer
Return value	Normal (0:WMT_TRUE) / Error (-1)
Description	The function reads out the result (PER at the Relaxed measurement setting) of the C/I Performance test and stores the value in the variable specified by <i>dblPer</i> .

6.1.3.28 QryFetcSigBlocPerfSumErr

Function name	long QryFetcSigBlocPerfSumErr
Function	Reading out the number of error data items (maximum of 100) in the Blocking Performance test whose BER surpassed the limit value.
Argument	[IN] long lngID // The identifier for the relevant instrument // (the ID obtained when the connection was secured). long lngPoint // Interference signal level specification // 0x01: Level1 // 0x02: Level2 // 0x03: Level3 // ALL cannot be set. [OUT] long * lngSum
Return value	Normal (0:WMT_TRUE) / Error (-1)
Description	The function reads out the number of error data items (maximum of 100) in the Blocking Performance test whose BER surpassed the limit value and stores the value in the variable specified by <i>lngSum</i> .

6.1.3.29 QryFetcSigBlocPerfFreq

Function name	long QryFetcSigBlocPerfFreq
Function	Reading out the result (frequency) of the Blocking Performance test.
Argument	[IN] long lngID // The identifier for the relevant instrument // (the ID obtained when the connection was secured). long lngNum // 1 to 15 : The element number of the array to read out. [OUT] double * dblFreq
Return value	Normal (0:WMT_TRUE) / Error (-1)
Description	The function reads out the result (frequency) of the Blocking Performance test and stores the value in the variable specified by <i>dblFreq</i> .

6.1.3 FETCh Subsystem - SIG RF

6.1.3.30 QryFetcSigBlocPerfBer

Function name	long QryFetcSigBlocPerfBer
Function	Reading out the result (BER) of the Blocking Performance test.
Argument	<pre>[IN] long lngID // The identifier for the relevant instrument // (the ID obtained when the connection was secured). long lngPoint // Interference signal level specification // 0x01: Level1 // 0x02: Level2 // 0x03: Level3 // ALL cannot be set. long lngNum // 1 to 15 : The element number of the array which is read out. [OUT] double * dblBer</pre>
Return value	Normal (0:WMT_TRUE) / Error (-1)
Description	The function reads out the result (BER) of the Blocking Performance test and stores the value in the variable specified by <i>dblBer</i> .

6.1.3.31 QryFetcSigBlocPerfPer

Function name	long QryFetcSigBlocPerfPer
Function	Reading out the result (PER) of the Blocking Performance test.
Argument	<pre>[IN] long lngID // The identifier for the relevant instrument // (the ID obtained when the connection was secured). long lngPoint // Interference signal level specification // 0x01: Level1 // 0x02: Level2 // 0x03: Level3 // ALL cannot be set. long lngNum // 1 to 15 : The element number of the array which is read out. [OUT] double * dblPer // % </pre>
Return value	Normal (0:WMT_TRUE) / Error (-1)
Description	The function reads out the result (PER) of the Blocking Performance test and stores the value in the variable specified by <i>dblPer</i> .

6.1.3.32 QryFetcSigIModPerfN3LoBer

Function name	long QryFetcSigIModPerfN3LoBer
Function	Reading out the result (the BER of the negative side (the Low side of f(tx)) when n=3) of the Intermodulation Performance test.
Argument	<pre>[IN] long lngID // The identifier for the relevant instrument // (the ID obtained when the connection was secured). long lngPoint // Operation frequency setting // 0x01: LOW (Lowest operating frequency) // 0x02: MID (Mid operating frequency) // 0x03: HIGH (Highest operating frequency) // ALL cannot be set. [OUT] double * dblBer // [%]</pre>
Return value	Normal (0:WMT_TRUE) / Error (-1)
Description	The function reads out the result (the BER of the negative side (the Low side of f(tx)) when n=3) of the Intermodulation Performance test and stores the value in the variable specified by <i>dblBer</i> .

6.1.3.33 QryFetcSigIModPerfN3HiBer

Function name	long QryFetcSigIModPerfN3HiBer
Function	Reading out the result (the BER of the positive side (the High side of f(tx)) when n=3) of the Intermodulation Performance test.
Argument	<pre>[IN] long lngID // The identifier for the relevant instrument // (the ID obtained when the connection was secured). long lngPoint // Operation frequency setting // 0x01: LOW (Lowest operating frequency) // 0x02: MID (Mid operating frequency) // 0x03: HIGH (Highest operating frequency) // ALL cannot be set. [OUT] double * dblBer // [%]</pre>
Return value	Normal (0:WMT_TRUE) / Error (-1)
Description	The function reads out the result (the BER of the positive side (the High side of f(tx)) when n=3) of the Intermodulation Performance test and stores the value in the variable specified by <i>dblBer</i> .

6.1.3 FETCh Subsystem - SIG RF

6.1.3.34 QryFetcSigIModPerfN3LoPer

Function name	long QryFetcSigIModPerfN3LoPer
Function	Reading out the result (the PER of the negative side (the Low side of f(tx)) when n=3) of the Intermodulation Performance test.
Argument	[IN] long lngID // The identifier for the relevant instrument // (the ID obtained when the connection was secured). long lngPoint // Operation frequency setting // 0x01: LOW (Lowest operating frequency) // 0x02: MID (Mid operating frequency) // 0x03: HIGH (Highest operating frequency) // ALL cannot be set. [OUT] double * dblPer // [%]
Return value	Normal (0:WMT_TRUE) / Error (-1)
Description	The function reads out the result (the PER of the negative side (the Low side of f(tx)) when n=3) of the Intermodulation Performance test and stores the value in the variable specified by <i>dblPer</i> .

6.1.3.35 QryFetcSigIModPerfN3HiPer

Function name	long QryFetcSigIModPerfN3HiPer
Function	Reading out the result (the PER of the positive side (the High side of f(tx)) when n=3) of the Intermodulation Performance test.
Argument	[IN] long lngID // The identifier for the relevant instrument // (the ID obtained when the connection was secured). long lngPoint // Operation frequency setting // 0x01: LOW (Lowest operating frequency) // 0x02: MID (Mid operating frequency) // 0x03: HIGH (Highest operating frequency) // ALL cannot be set. [OUT] double * dblPer // [%]
Return value	Normal (0:WMT_TRUE) / Error (-1)
Description	The function reads out the result (the PER of the positive side (the High side of f(tx)) when n=3) of the Intermodulation Performance test and stores the value in the variable specified by <i>dblPer</i> .

6.1.3.36 QryFetcSigIModPerfN4LoBer

Function name	long QryFetcSigIModPerfN4LoBer
Function	Reading out the result (the BER of the negative side (the Low side of f(tx)) when n=4) of the Intermodulation Performance test.
Argument	<pre> [IN] long lngID // The identifier for the relevant instrument // (the ID obtained when the connection was secured). long lngPoint // Operation frequency setting // 0x01: LOW (Lowest operating frequency) // 0x02: MID (Mid operating frequency) // 0x03: HIGH (Highest operating frequency) // ALL cannot be set. [OUT] double * dblBer // [%] </pre>
Return value	Normal (0:WMT_TRUE) / Error (-1)
Description	The function reads out the result (the BER of the negative side (the Low side of f(tx)) when n=4) of the Intermodulation Performance test and stores the value in the variable specified by <i>dblBer</i> .

6.1.3.37 QryFetcSigIModPerfN4HiBer

Function name	long QryFetcSigIModPerfN4HiBer
Function	Reading out the result (the BER of the positive side (the High side of f(tx)) when n=4) of the Intermodulation Performance test.
Argument	<pre> [IN] long lngID // The identifier for the relevant instrument // (the ID obtained when the connection was secured). long lngPoint // Operation frequency setting // 0x01: LOW (Lowest operating frequency) // 0x02: MID (Mid operating frequency) // 0x03: HIGH (Highest operating frequency) // ALL cannot be set. [OUT] double * dblBer // [%] </pre>
Return value	Normal (0:WMT_TRUE) / Error (-1)
Description	The function reads out the result (the BER of the positive side (the High side of f(tx)) when n=4) of the Intermodulation Performance test and stores the value in the variable specified by <i>dblBer</i> .

6.1.3 FETCh Subsystem - SIG RF

6.1.3.38 QryFetcSigIModPerfN4LoPer

Function name	long QryFetcSigIModPerfN4LoPer
Function	Reading out the result (the PER of the negative side (the Low side of f(tx)) when n=4) of the Intermodulation Performance test.
Argument	[IN] long lngID // The identifier for the relevant instrument // (the ID obtained when the connection was secured). long lngPoint // Operation frequency setting // 0x01: LOW (Lowest operating frequency) // 0x02: MID (Mid operating frequency) // 0x03: HIGH (Highest operating frequency) // ALL cannot be set. [OUT] double * dblPer // [%]
Return value	Normal (0:WMT_TRUE) / Error (-1)
Description	The function reads out the result (the PER of the negative side (the Low side of f(tx)) when n=4) of the Intermodulation Performance test and stores the value in the variable specified by <i>dblPer</i> .

6.1.3.39 QryFetcSigIModPerfN4HiPer

Function name	long QryFetcSigIModPerfN4HiPer
Function	Reading out the result (the PER of the positive side (the High side of f(tx)) when n=4) of the Intermodulation Performance test.
Argument	[IN] long lngID // The identifier for the relevant instrument // (the ID obtained when the connection was secured). long lngPoint // Operation frequency setting // 0x01: LOW (Lowest operating frequency) // 0x02: MID (Mid operating frequency) // 0x03: HIGH (Highest operating frequency) // ALL cannot be set. [OUT] double * dblPer // [%]
Return value	Normal (0:WMT_TRUE) / Error (-1)
Description	The function reads out the result (the PER of the positive side (the High side of f(tx)) when n=4) of the Intermodulation Performance test and stores the value in the variable specified by <i>dblPer</i> .

6.1.3.40 QryFetcSigIModPerfN5LoBer

Function name	long QryFetcSigIModPerfN5LoBer
Function	Reading out the result (the BER of the negative side (the Low side of f(tx)) when n=5) of the Intermodulation Performance test.
Argument	<pre>[IN] long lngID // The identifier for the relevant instrument // (the ID obtained when the connection was secured). long lngPoint // Operation frequency setting // 0x01: LOW (Lowest operating frequency) // 0x02: MID (Mid operating frequency) // 0x03: HIGH (Highest operating frequency) // ALL cannot be set. [OUT] double * dblBer // [%]</pre>
Return value	Normal (0:WMT_TRUE) / Error (-1)
Description	The function reads out the result (the BER of the negative side (the Low side of f(tx)) when n=5) of the Intermodulation Performance test and stores the value in the variable specified by <i>dblBer</i> .

6.1.3.41 QryFetcSigIModPerfN5HiBer

Function name	long QryFetcSigIModPerfN5HiBer
Function	Reading out the result (the BER of the positive side (the High side of f(tx)) when n=5) of the Intermodulation Performance test.
Argument	<pre>[IN] long lngID // The identifier for the relevant instrument // (the ID obtained when the connection was secured). long lngPoint // Operation frequency setting // 0x01: LOW (Lowest operating frequency) // 0x02: MID (Mid operating frequency) // 0x03: HIGH (Highest operating frequency) // ALL cannot be set. [OUT] double * dblBer // [%]</pre>
Return value	Normal (0:WMT_TRUE) / Error (-1)
Description	The function reads out the result (the BER of the positive side (the High side of f(tx)) when n=5) of the Intermodulation Performance test and stores the value in the variable specified by <i>dblBer</i> .

6.1.3 FETCh Subsystem - SIG RF

6.1.3.42 QryFetcSigIModPerfN5LoPer

Function name	long QryFetcSigIModPerfN5LoPer
Function	Reading out the result (the PER of the negative side (the Low side of $f(tx)$) when $n=5$) of the Intermodulation Performance test.
Argument	[IN] long lngID // The identifier for the relevant instrument // (the ID obtained when the connection was secured). long lngPoint // Operation frequency setting // 0x01: LOW (Lowest operating frequency) // 0x02: MID (Mid operating frequency) // 0x03: HIGH (Highest operating frequency) // ALL cannot be set. [OUT] double * dblPer // [%]
Return value	Normal (0:WMT_TRUE) / Error (-1)
Description	The function reads out the result (the PER of the negative side (the Low side of $f(tx)$) when $n=5$) of the Intermodulation Performance test and stores the value in the variable specified by <i>dblPer</i> .

6.1.3.43 QryFetcSigIModPerfN5HiPer

Function name	long QryFetcSigIModPerfN5HiPer
Function	Reading out the result (the PER of the positive side (the High side of $f(tx)$) when $n=5$) of the Intermodulation Performance test.
Argument	[IN] long lngID // The identifier for the relevant instrument // (the ID obtained when the connection was secured). long lngPoint // Operation frequency setting // 0x01: LOW (Lowest operating frequency) // 0x02: MID (Mid operating frequency) // 0x03: HIGH (Highest operating frequency) // ALL cannot be set. [OUT] double * dblPer // [%]
Return value	Normal (0:WMT_TRUE) / Error (-1)
Description	The function reads out the result (the PER of the positive side (the High side of $f(tx)$) when $n=5$) of the Intermodulation Performance test and stores the value in the variable specified by <i>dblPer</i> .

6.1.4 CONFigure Subsystem - Telec

6.1.4.1 WmtConfTeleFreqTole

Function name	long WmtConfTeleFreqTole
Function	Setting the Frequency Tolerance test to ON or OFF.
Argument	[IN] long IngID // The identifier for the relevant instrument // (the ID obtained when the connection was secured). long IngPoint // Test item setting // 0x00: Setting the testing item to ON or OFF. // Operation frequency setting // 0x01: LOW (Lowest operating frequency) // 0x02: MID (Mid operating frequency) // 0x03: HIGH (Highest operating frequency) long IngOnoff // WMT_OFF(0): OFF / WMT_ON(1): ON
Return value	Normal (0:WMT_TRUE) / Error (-1)
Description	The function sets the Frequency Tolerance test to ON or OFF. The initial value is ON for each test item and all operation frequencies.

6.1.4.2 QryConfTeleFreqTole

Function name	long QryConfTeleFreqTole
Function	Reading out the ON or OFF setting of the Frequency Tolerance test.
Argument	[IN] long IngID // The identifier for the relevant instrument // (the ID obtained when the connection was secured). long IngPoint // Test item setting // 0x00: Setting the testing item to ON or OFF. // Operation frequency setting // 0x01: LOW (Lowest operating frequency) // 0x02: MID (Mid operating frequency) // 0x03: HIGH (Highest operating frequency) [OUT] long * IngOnoff
Return value	Normal (0:WMT_TRUE) / Error (-1)
Description	The function reads out the current ON or OFF setting of the Frequency Tolerance test and stores the value in the variable specified by <i>IngOnoff</i> .

6.1.4 CONFigure Subsystem - Telec

6.1.4.3 WmtConfTeleOBW

Function name	long WmtConfTeleOBW
Function	Setting the Occupied Frequency Bandwidth and Spreading Bandwidth tests to ON or OFF.
Argument	[IN] long lngID // The identifier for the relevant instrument // (the ID obtained when the connection was secured). long lngOnoff // WMT_OFF(0): OFF / WMT_ON(1): ON
Return value	Normal (0:WMT_TRUE) / Error (-1)
Description	The function sets the Occupied Frequency Bandwidth and Spreading Bandwidth tests to ON or OFF. The initial value is ON.

6.1.4.4 QryConfTeleOBW

Function name	long QryConfTeleOBW
Function	Reading out the ON or OFF setting of the Occupied Frequency Bandwidth and Spreading Bandwidth tests.
Argument	[IN] long lngID // The identifier for the relevant instrument // (the ID obtained when the connection was secured). [OUT] long * lngOnoff
Return value	Normal (0:WMT_TRUE) / Error (-1)
Description	The function reads out the current ON or OFF setting of the Occupied Frequency Bandwidth and Spreading Bandwidth tests and stores the value in the variable specified by <i>lngOnoff</i> .

6.1.4.5 WmtConfTeleAntPow

Function name	long WmtConfTeleAntPow
Function	Setting the Antenna Power test to ON or OFF.
Argument	[IN] long lngID // The identifier for the relevant instrument // (the ID obtained when the connection was secured). long lngOnoff // WMT_OFF(0): OFF / WMT_ON(1): ON
Return value	Normal (0:WMT_TRUE) / Error (-1)
Description	The function sets the Antenna Power test to ON or OFF. The initial value is ON.

6.1.4.6 QryConfTeleAntPow

Function name	long QryConfTeleAntPow
Function	Reading out the ON or OFF setting of the Antenna Power test.
Argument	[IN] long lngID // The identifier for the relevant instrument // (the ID obtained when the connection was secured). [OUT] long * lngOnoff
Return value	Normal (0:WMT_TRUE) / Error (-1)
Description	The function reads out the current ON or OFF setting of the Antenna Power test and stores the value in the variable specified by <i>lngOnoff</i> .

6.1.4.7 WmtConfTeleSpurEmis

Function name	long WmtConfTeleSpurEmis
Function	Setting the Spurious Emission Strength test to ON or OFF.
Argument	[IN] long lngID // The identifier for the relevant instrument // (the ID obtained when the connection was secured). long lngPoint // Test item setting // 0x00: Setting the testing item to ON or OFF. // Operation frequency setting // 0x01: LOW (Lowest operating frequency) // 0x02: MID (Mid operating frequency) // 0x03: HIGH (Highest operating frequency) long lngOnoff // WMT_OFF(0): OFF / WMT_ON(1): ON
Return value	Normal (0:WMT_TRUE) / Error (-1)
Description	The function sets the Spurious Emission Strength test to ON or OFF. The initial value is ON for each test item and all operation frequencies.

6.1.4 CONFigure Subsystem - Telec

6.1.4.8 QryConfTeleSpurEmis

Function name	long QryConfTeleSpurEmis
Function	Reading out the ON or OFF setting of the Spurious Emission Strength test.
Argument	[IN] long lngID // The identifier for the relevant instrument // (the ID obtained when the connection was secured). long lngPoint // Test item setting // 0x00: Setting the testing item to ON or OFF. // Operation frequency setting // 0x01: LOW (Lowest operating frequency) // 0x02: MID (Mid operating frequency) // 0x03: HIGH (Highest operating frequency) [OUT] long * lngOnoff
Return value	Normal (0:WMT_TRUE) / Error (-1)
Description	The function reads out the current ON or OFF setting of the Spurious Emission Strength test and stores the value in the variable specified by <i>lngOnoff</i> .

6.1.4.9 WmtConfTeleSecoEmit

Function name	long WmtConfTeleSecoEmit
Function	Setting the Secondary Emitted Radio Wave Strength test to ON or OFF.
Argument	[IN] long lngID // The identifier for the relevant instrument // (the ID obtained when the connection was secured). long lngOnoff // WMT_OFF(0): OFF / WMT_ON(1): ON
Return value	Normal (0:WMT_TRUE) / Error (-1)
Description	The function sets the Secondary Emitted Radio Wave Strength test to ON or OFF. The initial value is ON.

6.1.4.10 QryConfTeleSecoEmit

Function name	long QryConfTeleSecoEmit
Function	Reading out the ON or OFF setting of the Secondary Emitted Radio Wave Strength test.
Argument	[IN] long lngID // The identifier for the relevant instrument // (the ID obtained when the connection was secured). [OUT] long * lngOnoff
Return value	Normal (0:WMT_TRUE) / Error (-1)
Description	The function reads out the current ON or OFF setting of the Secondary Emitted Radio Wave Strength test and stores the value in the variable specified by <i>lngOnoff</i> .

6.1.4.11 WmtConfTeleStayTime

Function name	long WmtConfTeleStayTime
Function	Setting the Staying Time test to ON or OFF.
Argument	<p>[IN] long lngID // The identifier for the relevant instrument // (the ID obtained when the connection was secured).</p> <p>long lngPoint // Test item setting // 0x00: Setting the testing item to ON or OFF. // Operation frequency setting // 0x01: LOW (Lowest operating frequency) // 0x02: MID (Mid operating frequency) // 0x03: HIGH (Highest operating frequency)</p> <p>long lngOnoff // WMT_OFF(0): OFF / WMT_ON(1): ON</p>
Return value	Normal (0:WMT_TRUE) / Error (-1)
Description	The function sets the Staying Time test to ON or OFF. The initial value is ON for each test item and all operation frequencies.

6.1.4.12 QryConfTeleStayTime

Function name	long QryConfTeleStayTime
Function	Reading out the ON or OFF setting of the Staying Time test.
Argument	<p>[IN] long lngID // The identifier for the relevant instrument // (the ID obtained when the connection was secured).</p> <p>long lngPoint // Test item setting // 0x00: Setting the testing item to ON or OFF. // Operation frequency setting // 0x01: LOW (Lowest operating frequency) // 0x02: MID (Mid operating frequency) // 0x03: HIGH (Highest operating frequency)</p> <p>[OUT] long * lngOnoff</p>
Return value	Normal (0:WMT_TRUE) / Error (-1)
Description	The function reads out the current ON or OFF setting of the Staying Time test and stores the value in the variable specified by <i>lngOnoff</i> .

6.1.4 CONFigure Subsystem - Telec

6.1.4.13 WmtConfTeleToleToleUp

Function name	long WmtConfTeleToleToleUp
Function	Setting an upper limit which is used to make judgments in the Frequency Tolerance test.
Argument	[IN] long lngID // The identifier for the relevant instrument (the ID obtained when the connection was secured). double dblLimit // 1.0 to 100.0 [ppm]
Return value	Normal (0:WMT_TRUE) / Error (-1)
Description	The function sets an upper limit which is used to make judgments in the Frequency Tolerance test. The initial value is 50.0 [ppm].

6.1.4.14 QryConfTeleToleToleUp

Function name	long QryConfTeleToleToleUp
Function	Reading out the upper limit which is used to make judgments in the Frequency Tolerance test.
Argument	[IN] long lngID // The identifier for the relevant instrument // (the ID obtained when the connection was secured). [OUT] double * dblLimit
Return value	Normal (0:WMT_TRUE) / Error (-1)
Description	The function reads out the current upper limit which is used to make judgments in the Frequency Tolerance test and stores the value in the variable specified by <i>dblLimit</i> .

6.1.4.15 WmtConfTeleFreqToleSampNum

Function name	long WmtConfTeleFreqToleSampNum
Function	Setting a number of samples (average number) of the burst wave in the Frequency Tolerance test.
Argument	[IN] long lngID // The identifier for the relevant instrument // (the ID obtained when the connection was secured). long lngNum // 2 to 32
Return value	Normal (0:WMT_TRUE) / Error (-1)
Description	The function sets a number of samples (average number) of the burst wave in the Frequency Tolerance test. The initial value is 20.

6.1.4.16 QryConfTeleFreqTolSampNum

Function name	long QryConfTeleFreqTolSampNum
Function	Reading out the number of samples (average number) of the burst wave in the Frequency Tolerance test.
Argument	[IN] long lngID // The identifier for the relevant instrument // (the ID obtained when the connection was secured). [OUT] long * lngNum
Return value	Normal (0:WMT_TRUE) / Error (-1)
Description	The function reads out the current number of samples (average number) of the burst wave in the Frequency Tolerance test and stores the value in the variable specified by <i>lngNum</i> .

6.1.4.17 WmtConfTeleOBWBwidUp

Function name	long WmtConfTeleOBWBwidUp
Function	Setting an upper limit which is used to make judgments in the Occupied Frequency Bandwidth test.
Argument	[IN] long lngID // The identifier for the relevant instrument // (the ID obtained when the connection was secured). double dblLimit // 1.00e+6 to 1000.00e+6 [Hz]
Return value	Normal (0:WMT_TRUE) / Error (-1)
Description	The function sets an upper limit which is used to make judgments in the Occupied Frequency Bandwidth test. The initial value is 83.50e+6 [Hz] (83.5 MHz).

6.1.4.18 QryConfTeleOBWBwidUp

Function name	long QryConfTeleOBWBwidUp
Function	Reading out the upper limit which is used to make judgments in the Occupied Frequency Bandwidth test.
Argument	[IN] long lngID // The identifier for the relevant instrument // (the ID obtained when the connection was secured). [OUT] double * dblLimit
Return value	Normal (0:WMT_TRUE) / Error (-1)
Description	The function reads out the current upper limit which is used to make judgments in the Occupied Frequency Bandwidth test and stores the value in the variable specified by <i>dblLimit</i> .

6.1.4 CONFigure Subsystem - Telec

6.1.4.19 WmtConfTeleOBWSpreBwidLo

Function name	long WmtConfTeleOBWSpreBwidLo
Function	Setting a lower limit which is used to make judgments in the Spreading Bandwidth test.
Argument	[IN] long lngID // The identifier for the relevant instrument // (the ID obtained when the connection was secured). double dblLimit // 0.10e+6 to 100.00e+6 [Hz]
Return value	Normal (0:WMT_TRUE) / Error (-1)
Description	The function sets a lower limit which is used to make judgments in the Spreading Bandwidth test. The initial value is 0.5e+6 [Hz] (500 kHz).

6.1.4.20 QryConfTeleOBWSpreBwidLo

Function name	long QryConfTeleOBWSpreBwidLo
Function	Reading out the lower limit which is used to make judgments in the Spreading Bandwidth test.
Argument	[IN] long lngID // The identifier for the relevant instrument // (the ID obtained when the connection was secured). [OUT] double * dblLimit
Return value	Normal (0:WMT_TRUE) / Error (-1)
Description	The function reads out the current lower limit which is used to make judgments in the Spreading Bandwidth test and stores the value in the variable specified by <i>dblLimit</i> .

6.1.4.21 WmtConfTeleAntPowTolUp

Function name	long WmtConfTeleAntPowTolUp
Function	Setting an upper limit which is used to make judgments in the Antenna Power test.
Argument	[IN] long lngID // The identifier for the relevant instrument // (the ID obtained when the connection was secured). double dblLimit // -100.0 to 100.0 [%]
Return value	Normal (0:WMT_TRUE) / Error (-1)
Description	The function sets an upper limit which is used to make judgments in the Antenna Power test. The initial value is 20.0 [%]. If the specified value is below the existing lower limit, a which is equal to the lower limit is set.

6.1.4.22 QryConfTeleAntPowToleUp

Function name	long QryConfTeleAntPowToleUp
Function	Reading out the upper limit which is used to make judgments in the Antenna Power test.
Argument	[IN] long lngID // The identifier for the relevant instrument // (the ID obtained when the connection was secured). [OUT] double * dblLimit
Return value	Normal (0:WMT_TRUE) / Error (-1)
Description	Reading out the upper limit which is used to make judgments in the Antenna Power test and stores the value in the variable specified by <i>dblLimit</i> .

6.1.4.23 WmtConfTeleAntPowToleLo

Function name	long WmtConfTeleAntPowToleLo
Function	Setting a lower limit which is used to make judgments in the Antenna Power test.
Argument	[IN] long lngID // The identifier for the relevant instrument // (the ID obtained when the connection was secured). double dblLimit // -100.0 to 100.0 [%]
Return value	Normal (0:WMT_TRUE) / Error (-1)
Description	The function sets a lower limit which is used to make judgments in the Antenna Power test. The initial value is 80.0 [%]. If the specified value is above the existing upper limit, a which is equal to the lower limit is set.

6.1.4.24 QryConfTeleAntPowToleLo

Function name	long QryConfTeleAntPowToleLo
Function	Reading out the lower limit which is used to make judgments in the Antenna Power test.
Argument	[IN] long lngID // The identifier for the relevant instrument // (the ID obtained when the connection was secured). [OUT] double * dblLimit
Return value	Normal (0:WMT_TRUE) / Error (-1)
Description	The function reads out the current lower limit which is used to make judgments in the Antenna Power test and stores the value in the variable specified by <i>dblLimit</i> .

6.1.4 CONFigure Subsystem - Telec

6.1.4.25 WmtConfTeleAntPowRefPow

Function name	long WmtConfTeleAntPowRefPow
Function	Setting a reference antenna power (manufacturer specified value) in the Antenna Power test.
Argument	[IN] long lngID // The identifier for the relevant instrument // (the ID obtained when the connection was secured). double dblPow // 0.0001 to 10.0000 [mW/MHz]
Return value	Normal (0:WMT_TRUE) / Error (-1)
Description	The function sets a reference antenna power (manufacturer specified value) in the Antenna Power test. The initial value is 0.0300 [mW/MHz].

6.1.4.26 QryConfTeleAntPowRefPow

Function name	long QryConfTeleAntPowRefPow
Function	Reading out the reference antenna power (manufacturer specified value) set in the Antenna Power test.
Argument	[IN] long lngID // The identifier for the relevant instrument // (the ID obtained when the connection was secured). [OUT] double * dblPow
Return value	Normal (0:WMT_TRUE) / Error (-1)
Description	The function reads out the current reference antenna power (manufacturer specified value) in the Antenna Power test and stores the value in the variable specified by <i>dblPow</i> .

6.1.4.27 WmtConfTeleAntPowBursRati

Function name	long WmtConfTeleAntPowBursRati
Function	Setting a reference power burst ratio (manufacturer specified value) in the Antenna Power test.
Argument	[IN] long lngID // The identifier for the relevant instrument // (the ID obtained when the connection was secured). double dblRatio // 0.01 to 0.99
Return value	Normal (0:WMT_TRUE) / Error (-1)
Description	The function sets a reference power burst ratio (manufacturer specified value) in the Antenna Power test. The initial value is 0.50.

6.1.4.28 QryConfTeleAntPowBursRati

Function name	long QryConfTeleAntPowBursRati
Function	Reading out the reference power burst ratio (manufacturer specified value) set in the Antenna Power test.
Argument	[IN] long lngID // The identifier for the relevant instrument // (the ID obtained when the connection was secured). [OUT] double * dbIRatio
Return value	Normal (0:WMT_TRUE) / Error (-1)
Description	The function reads out the current reference power burst ratio (manufacturer specified value) in the Antenna Power test and stores the value in the variable specified by <i>dbIRatio</i> .

6.1.4.29 WmtConfTeleSpurEmisLevUp

Function name	long WmtConfTeleSpurEmisLevUp
Function	Setting an upper limit which is used to make judgments in the Spurious Emission Strength test.
Argument	[IN] long lngID // The identifier for the relevant instrument // (the ID obtained when the connection was secured). long lngNum // Frequency band // 0: Targeting below 2387 MHz. // 1: Targeting 2387 MHz to 2400 MHz. // 2: Targeting 2483.5 MHz to 2496.5 MHz. // 3: Targeting above 2496.5 MHz. double dbILimit // 0.01e-6 to 100.00e-6 [W]
Return value	Normal (0:WMT_TRUE) / Error (-1)
Description	The function sets an upper limit which is used to make judgments in the Spurious Emission Strength test. Initial values are as follows: lngNum = 0: 2.50e-6 [W] lngNum = 1: 25.00e-6 [W] lngNum = 2: 25.00e-6 [W] lngNum = 3: 2.50e-6 [W]

6.1.4 CONFigure Subsystem - Telec

6.1.4.30 QryConfTeleSpurEmisLevUp

Function name	long QryConfTeleSpurEmisLevUp
Function	Reading out the upper limit which is used to make judgments in the Spurious Emission Strength test.
Argument	[IN] long lngID // The identifier for the relevant instrument // (the ID obtained when the connection was secured). long lngNum // For the frequency bandwidth specification, refer to // WmtConfTeleSpurEmisLevUp. [OUT] double * dblLimit
Return value	Normal (0:WMT_TRUE) / Error (-1)
Description	The function reads out the current upper limit which is used to make judgments in the Spurious Emission Strength test and stores the value in the variable specified by <i>dblLimit</i> .

6.1.4.31 WmtConfTeleSecoEmitLevLowUp

Function name	long WmtConfTeleSecoEmitLevLowUp
Function	Setting an upper limit which is used to make judgments in the Secondary Emitted Radio Wave Strength test (for below 1 GHz)
Argument	[IN] long lngID // The identifier for the relevant instrument // (the ID obtained when the connection was secured). double dblLimit // 0.01e-9 to 100.00e-9 [W]
Return value	Normal (0:WMT_TRUE) / Error (-1)
Description	The function sets an upper limit which is used to make judgments in the Secondary Emitted Radio Wave Strength test (for below 1 GHz). The initial value is 4.00e-9 [W] (4.00 nW).

6.1.4.32 QryConfTeleSecoEmitLevLowUp

Function name	long QryConfTeleSecoEmitLevLowUp
Function	Reading out the upper limit which is used to make judgments in the Secondary Emitted Radio Wave Strength test (for below 1 GHz).
Argument	[IN] long lngID // The identifier for the relevant instrument // (the ID obtained when the connection was secured). [OUT] double * dblLimit
Return value	Normal (0:WMT_TRUE) / Error (-1)
Description	The function reads out the upper limit which is used to make judgments in the Secondary Emitted Radio Wave Strength test (for below 1 GHz) and stores the value in the variable specified by <i>dblLimit</i> .

6.1.4.33 WmtConfTeleSecoEmitLevUppUp

Function name	long WmtConfTeleSecoEmitLevUppUp
Function	Setting an upper limit which is used to make judgments in the Secondary Emitted Radio Wave Strength test (for 1 GHz or above) .
Argument	[IN] long lngID // The identifier for the relevant instrument // (the ID obtained when the connection was secured). double dblLimit // 0.01e-9 to 100.00e-9 [W]
Return value	Normal (0:WMT_TRUE) / Error (-1)
Description	The function sets an upper limit which is used to make judgments in the Secondary Emitted Radio Wave Strength test (for 1 GHz or above) . The initial value is 20.00e-9 [W] (20.00 nW).

6.1.4.34 QryConfTeleSecoEmitLevUppUp

Function name	long QryConfTeleSecoEmitLevUppUp
Function	Reading out the upper limit which is used to make judgments in the Secondary Emitted Radio Wave Strength test (for 1 GHz or above) .
Argument	[IN] long lngID // The identifier for the relevant instrument // (the ID obtained when the connection was secured). [OUT] double * dblLimit
Return value	Normal (0:WMT_TRUE) / Error (-1)
Description	The function reads out the upper limit which is used to make judgments in the Secondary Emitted Radio Wave Strength test (for 1 GHz or above) and stores the value in the variable specified by <i>dblLimit</i> .

6.1.4.35 WmtConfTeleStayTimeTimeUp

Function name	long WmtConfTeleStayTimeTimeUp
Function	Setting an upper limit which is used to make judgments in the Staying Time test.
Argument	[IN] long lngID // The identifier for the relevant instrument // (the ID obtained when the connection was secured). double dblLimit // 0.0001 to 1.0000 [sec]
Return value	Normal (0:WMT_TRUE) / Error (-1)
Description	The function sets an upper limit which is used to make judgments in the Staying Time test. The initial value is 0.4000 [sec].

6.1.4 CONFigure Subsystem - Telec

6.1.4.36 QryConfTeleStayTimeTimeUp

Function name	long QryConfTeleStayTimeTimeUp
Function	Reading out the current upper limit which is used to make judgments in the Staying Time test.
Argument	[IN] long lngID // The identifier for the relevant instrument // (the ID obtained when the connection was secured). [OUT] double * dblLimit
Return value	Normal (0:WMT_TRUE) / Error (-1)
Description	The function reads out the current upper limit which is used to make judgments in the Staying Time test and stores the value in the variable specified by <i>dblLimit</i> .

6.1.5 PROCedure Subsystem - Telec

6.1.5.1 WmtProcTeleFreqTole

Function name	long WmtProcTeleFreqTole
Function	Executing the Frequency Tolerance test.
Argument	[IN] long lngID // The identifier for the relevant instrument // (the ID obtained when the connection was secured). long lngPoint // Operation frequency setting // 0x00: ALL (All 3 points of Low, Mid, and High.) // 0x01: LOW (Lowest operating frequency) // 0x02: MID (Mid operating frequency) // 0x03: HIGH (Highest operating frequency)
Return value	Normal (0:WMT_TRUE) / Error (-1)
Description	The function executes the Frequency Tolerance test which excludes operation frequencies whose test executions are set to OFF by the user.

6.1.5.2 WmtProcTeleOBW

Function name	long WmtProcTeleOBW
Function	Executing the Occupied Frequency Bandwidth and Spreading Bandwidth test.
Argument	[IN] long lngID // The identifier for the relevant instrument // (the ID obtained when the connection was secured).
Return value	Normal (0:WMT_TRUE) / Error (-1)
Description	The function executes the Occupied Frequency Bandwidth and Spreading Bandwidth test.

6.1.5.3 WmtProcTeleAntPowPow

Function name	long WmtProcTeleAntPowPow
Function	Initializing the Power meter before executing the Antenna Power test.
Argument	[IN] long lngID // The identifier for the relevant instrument // (the ID obtained when the connection was secured).
Return value	Normal (0:WMT_TRUE) / Error (-1)
Description	The function initializes the Power meter before executing the Antenna Power test. Always execute this function before executing the Antenna Power test.

6.1.5 PROCEDURE Subsystem - Telec

6.1.5.4 WmtProcTeleAntPow

Function name	long WmtProcTeleAntPow
Function	Executing the Antenna Power test.
Argument	[IN] long lngID // The identifier for the relevant instrument // (the ID obtained when the connection was secured).
Return value	Normal (0:WMT_TRUE) / Error (-1)
Description	The function executes the Antenna Power test. Always execute the function WmtProcTeleAnt-PowPow to initialize the Power meter before executing this function.

6.1.5.5 WmtProcTeleSpurEmis

Function name	long WmtProcTeleSpurEmis
Function	Executing the Spurious Emission Strength test.
Argument	[IN] long lngID // The identifier for the relevant instrument // (the ID obtained when the connection was secured). long lngPoint // Operation frequency setting // 0x00: ALL (All 3 points of Low, Mid, and High.) // 0x01: LOW (Lowest operating frequency) // 0x02: MID (Mid operating frequency) // 0x03: HIGH (Highest operating frequency)
Return value	Normal (0:WMT_TRUE) / Error (-1)
Description	Executing the Spurious Emission Strength test which exclude operation frequencies whose test executions are set to OFF by the user.

6.1.5.6 WmtProcTeleSecoEmit

Function name	long WmtProcTeleSecoEmit
Function	Executing the Secondary Emitted Radio Wave Strength test.
Argument	[IN] long lngID // The identifier for the relevant instrument // (the ID obtained when the connection was secured).
Return value	Normal (0:WMT_TRUE) / Error (-1)
Description	The function executes the Secondary Emitted Radio Wave Strength test.

6.1.5.7 WmtProcTeleStayTime

Function name	long WmtProcTeleStayTime
Function	Executing the Staying Time test.
Argument	[IN] long lngID // The identifier for the relevant instrument // (the ID obtained when the connection was secured). long lngPoint // Operation frequency setting // 0x00: ALL (All 3 points of Low, Mid, and High.) // 0x01: LOW (Lowest operating frequency) // 0x02: MID (Mid operating frequency) // 0x03: HIGH (Highest operating frequency)
Return value	Normal (0:WMT_TRUE) / Error (-1)
Description	The function executes the Staying Time test which excludes operation frequencies whose test executions are set to OFF by the user.

6.1.5.8 WmtProcTeleAll

Function name	long WmtProcTeleAll
Function	Executing all items in the Telec test excluding items and operation frequencies whose test execution is set to OFF by the user.
Argument	[IN] long lngID // The identifier for the relevant instrument // (the ID obtained when the connection was secured).
Return value	Normal (0:WMT_TRUE) / Error (-1)
Description	The function executes all items in the Telec test. The test is not executed for items and operation frequencies whose test execution is set to OFF by the user.

6.1.6 FETCh Subsystem - Telec

6.1.6 FETCh Subsystem - Telec

6.1.6.1 QryFetcTeleFreqToleTole

Function name	long QryFetcTeleFreqToleTole
Function	Reading out the measurement result (tolerance) of the Frequency Tolerance test.
Argument	<pre>[IN] long lngID // The identifier for the relevant instrument // (the ID obtained when the connection was secured). long lngPoint // Operation frequency setting // 0x01: LOW (Lowest operating frequency) // 0x02: MID (Mid operating frequency) // 0x03: HIGH (Highest operating frequency) // ALL cannot be set. long lngUnit // Unit 0: ppm // 1: Hz [OUT] double * dblDevi</pre>
Return value	Normal (0:WMT_TRUE) / Error (-1)
Description	The function reads out the measurement result (tolerance) of the Frequency Tolerance test and stores the value in the variable specified by <i>dblDevi</i> .

6.1.6.2 QryFetcTeleFreqToleFreq

Function name	long QryFetcTeleFreqToleFreq
Function	Reading out the measurement result (frequency) of the Frequency Tolerance test.
Argument	<pre>[IN] long lngID // The identifier for the relevant instrument // (the ID obtained when the connection was secured). long lngPoint // Operation frequency setting // 0x01: LOW (Lowest operating frequency) // 0x02: MID (Mid operating frequency) // 0x03: HIGH (Highest operating frequency) // ALL cannot be set. [OUT] double * dblFreq // Store per 1 Hz unit.</pre>
Return value	Normal (0:WMT_TRUE) / Error (-1)
Description	The function reads out the measurement result (frequency) of the Frequency Tolerance test and stores the value in the variable specified by <i>dblFreq</i> .

6.1.6.3 QryFetcTeleOBWBwid

Function name	long QryFetcTeleOBWBwid
Function	Reading out the result (occupied frequency bandwidth) of the Occupied Frequency Bandwidth test.
Argument	[IN] long lngID // The identifier for the relevant instrument // (the ID obtained when the connection was secured). [OUT] double * dblFreq // Store per 1 Hz unit.
Return value	Normal (0:WMT_TRUE) / Error (-1)
Description	The function reads out the result (occupied frequency bandwidth) of the Occupied Frequency Bandwidth test and stores the value in the variable specified by <i>dblFreq</i> .

6.1.6.4 QryFetcTeleOBWFreqHi

Function name	long QryFetcTeleOBWFreqHi
Function	Reading out the result (frequency of the High side) of the Occupied Frequency Bandwidth test.
Argument	[IN] long lngID // The identifier for the relevant instrument // (the ID obtained when the connection was secured). [OUT] double * dblFreq // Store per 1 Hz unit.
Return value	Normal (0:WMT_TRUE) / Error (-1)
Description	The function reads out the result (frequency of the High side) of the Occupied Frequency Bandwidth test and stores the value in the variable specified by <i>dblFreq</i> .

6.1.6.5 QryFetcTeleOBWFreqLow

Function name	long QryFetcTeleOBWFreqLow
Function	Reading out the result (frequency of the Low side) of the Occupied Frequency Bandwidth test.
Argument	[IN] long lngID // The identifier for the relevant instrument // (the ID obtained when the connection was secured). [OUT] double * dblFreq // Store per 1 Hz unit.
Return value	Normal (0:WMT_TRUE) / Error (-1)
Description	The function reads out the result (frequency of the Low side) of the Occupied Frequency Bandwidth test and stores the value in the variable specified by <i>dblFreq</i> .

6.1.6 FETCh Subsystem - Telec

6.1.6.6 QryFetcTeleOBWSpreBwid

Function name	long QryFetcTeleOBWSpreBwid
Function	Reading out the result (spreading bandwidth) of the Spreading Bandwidth test.
Argument	[IN] long lngID // The identifier for the relevant instrument // (the ID obtained when the connection was secured). [OUT] double * dblFreq // Store per 1 Hz unit.
Return value	Normal (0:WMT_TRUE) / Error (-1)
Description	The function reads out the result (spreading bandwidth) of the Spreading Bandwidth test and stores the value in the variable specified by <i>dblFreq</i> .

6.1.6.7 QryFetcTeleOBWSpreBwidHopOff

Function name	long QryFetcTeleOBWSpreBwidHopOff
Function	Reading out the result (spreading bandwidth) of the Spreading Bandwidth test when Hopping is set to OFF.
Argument	[IN] long lngID // The identifier for the relevant instrument // (the ID obtained when the connection was secured). long lngPoint // Operation frequency setting // 0x01: LOW (Lowest operating frequency) // 0x02: MID (Mid operating frequency) // 0x03: HIGH (Highest operating frequency) // ALL cannot be set. [OUT] double * dblFreq // Store per 1 Hz unit.
Return value	Normal (0:WMT_TRUE) / Error (-1)
Description	The function reads out the result (spreading bandwidth) of the Spreading Bandwidth test when Hopping is set to OFF and stores the value in the variable specified by <i>dblFreq</i> .

6.1.6.8 QryFetcTeleAntPowTole

Function name	long QryFetcTeleAntPowTole
Function	Reading out the measurement result (tolerance) of the Antenna Power test.
Argument	[IN] long lngID // The identifier for the relevant instrument // (the ID obtained when the connection was secured). long lngUnit // Unit 0: % // 1: dB [OUT] double * dblTole
Return value	Normal (0:WMT_TRUE) / Error (-1)
Description	The function reads out the measurement result (tolerance) of the Antenna Power test and stores the value in the variable specified by <i>dblTole</i> .

6.1.6.9 QryFetcTeleAntPowOutPow

Function name	long QryFetcTeleAntPowOutPow
Function	Reading out the measurement result (output power) of the Antenna Power test.
Argument	[IN] long lngID // The identifier for the relevant instrument // (the ID obtained when the connection was secured). long lngUnit // Unit 0: W // 1: dBm [OUT] double * dblPow
Return value	Normal (0:WMT_TRUE) / Error (-1)
Description	The function reads out the measurement result (output power) of the Antenna Power test and stores the value in the variable specified by <i>dblPow</i> .

6.1.6.10 QryFetcTeleAntPowAntPow

Function name	long QryFetcTeleAntPowAntPow
Function	Reading out the measurement result (antenna power) of the Antenna Power test.
Argument	[IN] long lngID // The identifier for the relevant instrument // (the ID obtained when the connection was secured). long lngUnit // Unit 0: mW/MHz // 1: dBm/MHz [OUT] double * dblPow
Return value	Normal (0:WMT_TRUE) / Error (-1)
Description	The function reads out the measurement result (antenna power) of the Antenna Power test and stores the value in the variable specified by <i>dblPow</i> .

6.1.6 FETCh Subsystem - Telec

6.1.6.11 QryFetcTeleSpurEmisLev

Function name	long QryFetcTeleSpurEmisLev		
Function	Reading out the measurement result (Spurious signal level) of the Spurious Emission Strength test.		
Argument	[IN]	long lngID // The identifier for the relevant instrument // (the ID obtained when the connection was secured). long lngPoint // Operation frequency setting // 0x01: LOW (Lowest operating frequency) // 0x02: MID (Mid operating frequency) // 0x03: HIGH (Highest operating frequency) // ALL cannot be set. long lngNum // Frequency band 0: For frequencies below 2387 MHz // 1: For frequencies 2387 MHz to 2400 MHz // 2: For frequencies 2483.5 MHz to 2496.5 MHz // 3: For frequencies above 2496.5 MHz long lngUnit // Unit 0: W // 1: dBm	
	[OUT]	double * dblLev	
Return value	Normal (0:WMT_TRUE) / Error (-1)		
Description	The function reads out the measurement result (Spurious signal level) of the Spurious Emission Strength test and stores the value in the variable specified by <i>dblLev</i> .		

6.1.6.12 QryFetcTeleSpurEmisFreq

Function name	long QryFetcTeleSpurEmisFreq		
Function	Reading out the measurement result (Spurious signal frequency) of the Spurious Emission Strength test.		
Argument	[IN]	long lngID // The identifier for the relevant instrument // (the ID obtained when the connection was secured). long lngPoint // Operation frequency setting // 0x01: LOW (Lowest operating frequency) // 0x02: MID (Mid operating frequency) // 0x03: HIGH (Highest operating frequency) // ALL cannot be set. long lngNum // Frequency band 0: For frequencies below 2387 MHz // 1: For frequencies 2387 MHz to 2400 MHz // 2: For frequencies 2483.5 MHz to 2496.5 MHz // 3: For frequencies above 2496.5 MHz	
	[OUT]	double * dblFreq // Store per 1 Hz unit.	
Return value	Normal (0:WMT_TRUE) / Error (-1)		
Description	The function reads out the measurement result (Spurious signal frequency) of the Spurious Emission Strength test and stores the value in the variable specified by <i>dblFreq</i> .		

6.1.6.13 QryFetcTeleSecoEmitLevLow

Function name	long QryFetcTeleSecoEmitLevLow
Function	Reading out the measurement result (for a Spurious signal level below 1 GHz) of the Secondarily Emitted Radio Wave Strength test.
Argument	[IN] long lngID // The identifier for the relevant instrument // (the ID obtained when the connection was secured). long lngUnit // Unit 0: W // 1: dBm [OUT] double * dblLev
Return value	Normal (0:WMT_TRUE) / Error (-1)
Description	The function reads out the measurement result (for Spurious signal levels below 1 GHz) of the Secondarily Emitted Radio Wave Strength test and stores the value in the variable specified by <i>dblLev</i> .

6.1.6.14 QryFetcTeleSecoEmitLevUpp

Function name	long QryFetcTeleSecoEmitLevUpp
Function	Reading out the measurement result (for Spurious signal level of 1 GHz or above) of the Secondarily Emitted Radio Wave Strength test.
Argument	[IN] long lngID // The identifier for the relevant instrument // (the ID obtained when the connection was secured). long lngUnit // Unit 0: W // 1: dBm [OUT] double * dblLev
Return value	Normal (0:WMT_TRUE) / Error (-1)
Description	The function reads out the measurement result (for Spurious signal level of 1 GHz or above) of the Secondarily Emitted Radio Wave Strength test and stores the value in the variable specified by <i>dblLev</i> .

6.1.6 FETCh Subsystem - Telec

6.1.6.15 QryFetcTeleSecoEmitFreqLow

Function name	long QryFetcTeleSecoEmitFreqLow
Function	Reading out the measurement result (for Spurious signal frequency below 1 GHz) of the Secondary Emitted Radio Wave Strength test.
Argument	[IN] long lngID // The identifier for the relevant instrument // (the ID obtained when the connection was secured). [OUT] double * dblFreq // Store per 1 Hz unit.
Return value	Normal (0:WMT_TRUE) / Error (-1)
Description	The function reads out the measurement result (for Spurious signal frequency below 1 GHz) of the Secondary Emitted Radio Wave Strength test and stores the value in the variable specified by <i>dblFreq</i> .

6.1.6.16 QryFetcTeleSecoEmitFreqUpp

Function name	long QryFetcTeleSecoEmitFreqUpp
Function	Reading out the measurement result (for Spurious signal frequency of 1 GHz or above) of the Secondary Emitted Radio Wave Strength test.
Argument	[IN] long lngID // The identifier for the relevant instrument // (the ID obtained when the connection was secured). [OUT] double * dblFreq // Store per 1 Hz unit.
Return value	Normal (0:WMT_TRUE) / Error (-1)
Description	The function reads out the measurement result (for Spurious signal frequency of 1 GHz or above) of the Secondary Emitted Radio Wave Strength test and stores the value in the variable specified by <i>dblFreq</i> .

6.1.6.17 QryFetcTeleStayTimeTime

Function name	long QryFetcTeleStayTimeTime
Function	Reading out the measurement result (staying time) of the Staying Time test.
Argument	<pre> [IN] long lngID // The identifier for the relevant instrument // (the ID obtained when the connection was secured). long lngPoint // Operation frequency setting // 0x01: LOW (Lowest operating frequency) // 0x02: MID (Mid operating frequency) // 0x03: HIGH (Highest operating frequency) // ALL cannot be set. [OUT] double * dblTime // Store per 1 sec unit. </pre>
Return value	Normal (0:WMT_TRUE) / Error (-1)
Description	The function reads out the measurement result (staying time) of the Staying Time test and stores the value in the variable specified by <i>dblTime</i> .

6.1.7 SOURce Subsystem - DC Power Source

6.1.7 SOURce Subsystem - DC Power Source

6.1.7.1 WmtSourVsimBattType

Function name	long WmtSourVsimBattType
Function	Selecting a battery type.
Argument	[IN] long IngID // The identifier for the relevant instrument // (the ID obtained when the connection was secured). long IngType // 0: SIG STD // 1: Manual
Return value	Normal (0:WMT_TRUE) / Error (-1)
Description	The function selects a battery type. The initial value is 0: SIG STD.

6.1.7.2 QrySourVsimBattType

Function name	long QrySourVsimBattType
Function	Reading out the battery type.
Argument	[IN] long IngID // The identifier for the relevant instrument // (the ID obtained when the connection was secured). [OUT] long * IngType
Return value	Normal (0:WMT_TRUE) / Error (-1)
Description	The function reads out the current battery type and stores the value in the variable specified by <i>IngType</i> .

6.1.7.3 WmtSourVsimBattTypeStd

Function name	long WmtSourVsimBattTypeStd
Function	Selecting a battery (for when the SIG STD type is selected).
Argument	[IN] long IngID // The identifier for the relevant instrument // (the ID obtained when the connection was secured). long IngType // 0: Lead-Acid // 1: Lithium // 2: Mercury or Nickel-cadmium
Return value	Normal (0:WMT_TRUE) / Error (-1)
Description	The function selects a battery (for when the SIG STD type is selected). The initial value is 1: Lithium.

6.1.7.4 QrySourVsimBattTypeStd

Function name	long QrySourVsimBattTypeStd
Function	Reading out the battery (for when the SIG STD type is selected).
Argument	[IN] long lngID // The identifier for the relevant instrument // (the ID obtained when the connection was secured). [OUT] long * lngType
Return value	Normal (0:WMT_TRUE) / Error (-1)
Description	The function reads out the current battery (when the SIG STD is selected) and stores the value in the variable specified by <i>lngType</i> .

6.1.7.5 WmtSourVsimVoltType

Function name	long WmtSourVsimVoltType
Function	Selecting a source voltage.
Argument	[IN] long lngID // The identifier for the relevant instrument // (the ID obtained when the connection was secured). long lngType // 0: Upper // 1: Nominal // 2: Lower
Return value	Normal (0:WMT_TRUE) / Error (-1)
Description	The function selects a source voltage. The initial value is 1: Nominal.

6.1.7.6 QrySourVsimVoltType

Function name	long QrySourVsimVoltType
Function	Reading out the source voltage.
Argument	[IN] long lngID // The identifier for the relevant instrument // (the ID obtained when the connection was secured). [OUT] long * lngType
Return value	Normal (0:WMT_TRUE) / Error (-1)
Description	The function reads out the current source voltage and stores the value in the variable specified by <i>lngType</i> .

6.1.7 SOURce Subsystem - DC Power Source

6.1.7.7 WmtSourVsimVoltNomi

Function name	long WmtSourVsimVoltNomi
Function	Setting a nominal voltage.
Argument	<pre>[IN] long lngID // The identifier for the relevant instrument // (the ID obtained when the connection was secured). long lngType // 0: Lead-Acid // 1: Lithium // 2: Mercury or Nickel-cadmium // 10: Manual double dblVolt // Voltage value [V] // Lead-Acid : 0.000 to 15.000 // Lithium : 0.000 to 7.500 // Mercury or Nickel-cadmium : 0.000 to 7.500 // Manual : 0.000 to 15.000</pre>
Return value	Normal (0:WMT_TRUE) / Error (-1)
Description	The function sets a nominal voltage. The initial value for each lngtype is as follows: LngType = 0:11.500 [V], 1: 5.000[V], 2: 5.000[V], and 10: 3.000[V]. The resolution for the setting is 0.001 [V].

6.1.7.8 QrySourVsimVoltNomi

Function name	long QrySourVsimVoltNomi
Function	Reading out the nominal voltage.
Argument	<pre>[IN] long lngID // The identifier for the relevant instrument // (the ID obtained when the connection was secured). long lngType // 0: Lead-Acid // 1: Lithium // 2: Mercury or Nickel-cadmium // 10: Manual [OUT] double * dblVolt // [V]</pre>
Return value	Normal (0:WMT_TRUE) / Error (-1)
Description	The function reads out the current nominal voltage and stores the value in the variable specified by <i>dblVolt</i> .

6.1.7.9 WmtSourVsimVoltUp

Function name	long WmtSourVsimVoltUp
Function	Setting an upper voltage.
Argument	[IN] long lngID // The identifier for the relevant instrument // (the ID obtained when the connection was secured). long lngType // 10: Manual // * Cannot be set for other battery types. double dbIVolt // 0.000 to 15.000 [V]
Return value	Normal (0:WMT_TRUE) / Error (-1)
Description	The function sets an upper voltage. The initial value is 3.000 [V] (Manual), and the resolution for the setting is 0.001 [V]. * Cannot be set for other battery types (only a query appears).

6.1.7.10 QrySourVsimVoltUp

Function name	long QrySourVsimVoltUp
Function	Reading out the upper voltage.
Argument	[IN] long lngID // The identifier for the relevant instrument // (the ID obtained when the connection was secured). long lngType // 0: Lead-Acid // 1: Lithium // 2: Mercury or Nickel-cadmium // 10: Manual [OUT] double * dbIVolt // [V]
Return value	Normal (0:WMT_TRUE) / Error (-1)
Description	The function reads out the current upper voltage and stores the value in the variable specified by <i>dbIVolt</i> .

6.1.7.11 WmtSourVsimVoltLo

Function name	long WmtSourVsimVoltLo
Function	Setting a lower voltage.
Argument	[IN] long lngID // The identifier for the relevant instrument // (the ID obtained when the connection was secured). long lngType // 10: Manual // * Cannot be set for other battery types. double dbIVolt // 0.000 to 15.000 [V]
Return value	Normal (0:WMT_TRUE) / Error (-1)
Description	The function sets a lower voltage. The initial value is 3.000 [V] (Manual), and the resolution for the setting is 0.001 [V]. * Cannot be set for other battery types (only a query appears).

6.1.7 SOURce Subsystem - DC Power Source

6.1.7.12 QrySourVsimVoltLo

Function name	long QrySourVsimVoltLo
Function	Reading out the lower voltage.
Argument	[IN] long lngID // The identifier for the relevant instrument // (the ID obtained when the connection was secured). long lngType // 0: Lead-Acid // 1: Lithium // 2: Mercury or Nickel-cadmium // 10: Manual [OUT] double * dblVolt // [V]
Return value	Normal (0:WMT_TRUE) / Error (-1)
Description	The function reads out the current lower voltage and stores the value in the variable specified by <i>dblVolt</i> .

6.1.7.13 WmtSourVsimCurrLim

Function name	long WmtSourVsimCurrLim
Function	Setting a current limit.
Argument	[IN] long lngID // The identifier for the relevant instrument // (the ID obtained when the connection was secured). double dblAmp // Current value: 0.0100 to 1.5000 [A]
Return value	Normal (0:WMT_TRUE) / Error (-1)
Description	The function sets a current limit. The initial value is 0.1000 [A], and the resolution for the setting is 0.0001 [A].

6.1.7.14 QrySourVsimCurrLim

Function name	long QrySourVsimCurrLim
Function	Reading out the current limit.
Argument	[IN] long lngID // The identifier for the relevant instrument // (the ID obtained when the connection was secured). [OUT] double * dblAmp // [A]
Return value	Normal (0:WMT_TRUE) / Error (-1)
Description	The function reads out the current setting of the current limit and stores the value in the variable specified by <i>dblAmp</i> .

6.1.7.15 WmtSourVsimCurrLimType

Function name	long WmtSourVsimCurrLimType
Function	Selecting a limit mode for the current.
Argument	[IN] long lngID // The identifier for the relevant instrument // (the ID obtained when the connection was secured). long lngType // 0: Shutdown (output is OFF) // 1: Continue (continue the output with the current limit value)
Return value	Normal (0:WMT_TRUE) / Error (-1)
Description	The function selects a limit mode for the current. The initial value is 0: Shutdown.

6.1.7.16 QrySourVsimCurrLimType

Function name	long QrySourVsimCurrLimType
Function	Reading out the limit mode for the current.
Argument	[IN] long lngID // The identifier for the relevant instrument // (the ID obtained when the connection was secured). [OUT] long * lngType
Return value	Normal (0:WMT_TRUE) / Error (-1)
Description	The function reads out the current selection of the current limit mode and stores the value in the variable specified by <i>lngType</i> .

6.1.7.17 QrySourVsimCurrStat

Function name	long QrySourVsimCurrStat
Function	Reading out the operating condition of the current limit.
Argument	[IN] long lngID // The identifier for the relevant instrument // (the ID obtained when the connection was secured). [OUT] long * lngStat
Return value	Normal (0:WMT_TRUE) / Error (-1)
Description	The function reads out the current operating condition of the current limit and stores the value in the variable specified by <i>lngStat</i> . 0: Steady state 1: Has reached the limit value (current limit occurs)

6.1.7 SOURce Subsystem - DC Power Source

6.1.7.18 WmtOutpVsimStatType

Function name	long WmtOutpVsimStatType
Function	Selecting an operating mode for the voltage output ON/OFF setting.
Argument	[IN] long lngID // The identifier for the relevant instrument // (the ID obtained when the connection was secured). long lngType // 0: Auto // 1: Manual
Return value	Normal (0:WMT_TRUE) / Error (-1)
Description	The function selects an operating mode for the voltage output ON/OFF setting. The initial value is 0: Auto.

6.1.7.19 QryOutpVsimStatType

Function name	long QryOutpVsimStatType
Function	Reading out the operating mode for the voltage output ON/OFF setting.
Argument	[IN] long lngID // The identifier for the relevant instrument // (the ID obtained when the connection was secured). [OUT] long * lngType
Return value	Normal (0:WMT_TRUE) / Error (-1)
Description	The function reads out the current operating mode for the voltage output ON/OFF setting and stores the value in the variable specified by <i>lngType</i> .

6.1.7.20 WmtOutpVsimStat

Function name	long WmtOutpVsimStat
Function	Setting the voltage output to ON or OFF.
Argument	[IN] long lngID // The identifier for the relevant instrument // (the ID obtained when the connection was secured). long lngType // 0: OFF // 1: ON
Return value	Normal (0:WMT_TRUE) / Error (-1)
Description	The function sets the voltage output to ON or OFF. The initial value is 0: OFF.

6.1.7.21 QryOutpVsimStat

Function name	long QryOutpVsimStat
Function	Reading out the ON or OFF state of the voltage output.
Argument	[IN] long lngID // The identifier for the relevant instrument // (the ID obtained when the connection was secured). [OUT] long * lngType
Return value	Normal (0:WMT_TRUE) / Error (-1)
Description	The function reads out the current ON or OFF state of the voltage output and stores the value in the variable specified by <i>lngType</i> .

7. SPECIFICATIONS

This chapter provides the following information:

- Transmitter Measurement
- Receiver Measurement
- Peripheral Devices
- Connection with External Unit
- General Specification

7.1 Transmitter Measurement

- CH1 port

Characteristics	Specification
Frequency and modulation analysis measurement	
Input frequency range	2402 MHz to 2480 MHz
Input level range	+23 dBm to -15 dBm/0 V DC
Resolution	1 kHz
Accuracy	5 kHz: Range of analysis ^{*1} ± 200 kHz 7 kHz: Range of analysis ^{*1} ± 300 kHz
Output power measurement	
Input frequency range	2402 MHz to 2480 MHz
Input level range	+23 dBm to -15 dBm/0 V DC
Accuracy	± 1.2 dB (+23 dBm to -10 dBm)
Resolution	0.01 dB

^{*1}: The sum of the frequency error and frequency shift is within ± 300 kHz.

7.1 Transmitter Measurement

- CH2 port

Characteristics	Specification
Frequency and modulation analysis measurement	
Input frequency range	2402 MHz to 2480 MHz
Input level range	+5 dBm to -30 dBm/0 V DC
Resolution	1 kHz
Accuracy	5 kHz: Range of analysis ^{*2} ±200 kHz 7 kHz: Range of analysis ^{*2} ±300 kHz
Output power measurement	
Input frequency range	2402 MHz to 2480 MHz
Input level range	+5 dBm to -30 dBm/0 V DC
Accuracy	± 2.2 dB (+5 dBm to -20 dBm)
Resolution	0.01 dB

^{*2}: The sum of the frequency error and frequency shift is within ± 300 kHz.

7.2 Receiver Measurement

- SG unit - CH1 port

Characteristics	Specification
Frequency	
Output frequency range	2402 MHz to 2480 MHz
Resolution	1 MHz ^{*1}
Carrier frequency	
Accuracy	Within 5 kHz (of the specified channel frequency)
Level	
Output level range	-15 dBm to -85 dBm
Resolution	1 dB
Accuracy	± 1.8 dB (-15 dBm to -75 dBm)
Modulation	
Modulation exponent range	0.20 to 0.40 ^{*1}
Resolution	0.01
Accuracy	4 kHz: 0.28 to 0.34
Product of BT	0.5 (20 dB bandwidth within 1 MHz)
Transmission rate	1 Mbps ^{*1}
Signal purity	
±2 MHz power leak	-30 dB maximum
±3 MHz power leak	-35 dB maximum
BER test	
Measurement bit length	
Standard	1600000 bits to 9999999 bits ^{*2}
High speed	1 bit to 1600000 bits ^{*2}
Error rate	0% to 100%
Resolution	0.0001%

^{*1}: For dirty transmitter testing, refer to Table 7-1.

^{*2}: An integer packet number which satisfies the bit size.

7.2 Receiver Measurement

- SG unit - CH2 port

Characteristics	Specification
Frequency	
Output frequency range	2402 MHz to 2480 MHz
Resolution	1 MHz ^{*1}
Carrier frequency	
Accuracy	Within 5 kHz (of the specified channel frequency)
Level	
Output level range	0 dBm to -65 dBm
Resolution	1 dB
Accuracy	±3.3 dB (0 dBm to -55 dBm)
Modulation	
Modulation exponent range	0.20 to 0.40 ^{*1}
Resolution	0.01
Accuracy	4 kHz: 0.28 to 0.34
Product of BT	0.5 (20 dB bandwidth within 1 MHz)
Transmission rate	1 Mbps ^{*1}
Signal purity	
±2 MHz power leak	-30 dB maximum
±3 MHz power leak	-35 dB maximum
BER test	
Measurement bit length	
Standard	1600000 bits to 9999999 bits ^{*2}
High speed	1 bit to 1600000 bits ^{*2}
Error rate	0% to 100%
Resolution	0.0001%

^{*1}: For dirty transmitter testing, refer to Table 7-1.

^{*2}: An integer packet number which satisfies the bit size.

- Dirty transmitter testing

The signal outputs correspond to the SIG standard as shown in Table 7-1.

Table 7-1 Dirty Transmitter Slot Packets

Circulation order	Carrier frequency drift	Modulation exponent	Symbol timing error
1	+75 kHz	0.28	-20 ppm
2	+14 kHz	0.30	-20 ppm
3	-2 kHz	0.29	+20 ppm
4	1 kHz	0.32	+20 ppm
5	39 kHz	0.33	+20 ppm
6	0 kHz	0.34	-20 ppm
7	-42 kHz	0.29	-20 ppm
8	+74 kHz	0.31	-20 ppm
9	-19 kHz	0.28	-20 ppm
10	-75 kHz	0.35	+20 ppm

In addition to the above signals, the following conditions are specified for the test packet.

- For DH1 packet
Modulate the carrier frequency drift that has the 1.6 kHz sinusoidal wave modulation frequency (0 degree packet start) and ± 25 kHz frequency shift.
- For DH3 packet
Modulate the carrier frequency drift that has the 500 Hz sinusoidal wave modulation frequency (0 degree packet start) and ± 40 kHz frequency shift.
- For DH5 packet
Modulate the carrier frequency drift that has the 300 Hz sinusoidal wave modulation frequency (0 degree packet start) and ± 40 kHz frequency shift.
- Each circulation is made every 20 msec in order from 1 to 10 and back.

7.3 Peripheral Devices

7.3 Peripheral Devices

Characteristics	Specification
Monitor Port 1	Power meter ROHDE & SCHWARZ; NRVD (Dual channel type) ROHDE & SCHWARZ; NRV-Z52 (Thermal power sensor) ×2 required
Monitor Port 2	Spectrum analyzer Advantest; R3273 (to 26.5 GHz) Option: OPT 01 (Digital modulation analysis option) OPT 66 (Bluetooth modulation analysis option) Advantest; R3267 (to 8 GHz) [For non-spurious test items] Option: OPT 01 (Digital modulation analysis option) OPT 66 (Bluetooth modulation analysis option) Advantest; R3264 (to 3 GHz) [For non-spurious test items] Option: OPT 01 (Digital modulation analysis option) OPT 66 (Bluetooth modulation analysis option)
Interfere Port 1	CW signal generator ROHDE & SCHWARZ; SMR 20 (to 20 GHz) Option: SMR-B11 (0.01 to 1 GHz extended frequency) ROHDE & SCHWARZ; SMR 27 (to 27 GHz) Option: SMR-B11 (0.01 to 1 GHz extended frequency) ROHDE & SCHWARZ; SMR 30 (to 30 GHz) Option: SMR-B11 (0.01 to 1 GHz extended frequency) ROHDE & SCHWARZ; SMR 40 (to 40 GHz) Option: SMR-B11 (0.01 to 1 GHz extended frequency) ROHDE & SCHWARZ; SMP 02 (to 20 GHz) ROHDE & SCHWARZ; SMP 03 (to 30 GHz) ROHDE & SCHWARZ; SMP 04 (to 40 GHz)

Characteristics	Specification
Interfere Port 2	Digital modulation signal generator ROHDE & SCHWARZ; SMIQ03B (to 3.3 GHz) Option: SMIQ-B20 (Digital modulation coder) SMIQ-B11 (Data generator) ROHDE & SCHWARZ; SMIQ04B (to 4.4 GHz) Option: SMIQ-B20 (Digital modulation coder) SMIQ-B11 (Data generator) ROHDE & SCHWARZ; SMIQ06B (to 6.4 GHz) Option: SMIQ-B20 (Digital modulation coder) SMIQ-B11 (Data generator)
DC Source	Power source KEITHLEY; 2303

7.4 Connection with External Unit

Characteristics	Specification
Controller interface	IEEE-488 GPIB bus connector

7.5 General Specification

Characteristics	Specification
Operation environment	Ambient temperature: +20°C to +30°C Relative humidity: 80% or below (without condensation)

APPENDIX

This chapter provides the following information:

- Troubleshooting
- Error Messages

A.1 Troubleshooting

If a problem occurs with the system, check the items in the table below for possible causes and solutions before requesting assistance. If the problem is not resolved, contact the Advantest Sales Office or our service representative. The locations and telephone numbers are listed in the back of this manual. Fees also apply to the services and repairs for the problems listed in the table.

Table A-1 Troubleshooting

Problem	Probable Cause	Solution
Power indicator does not light.	The power cable is not connected correctly.	Turn off the system. Connect the power cable to the system AC power connector first and then, plug the cable into the power outlet.
	The fuse has blown.	Remove the power cable. Following the procedure described in Section 1.3.3 of the R4870 operation manual and replace the fuse. If the fuse blows again, contact the Advantest sales office.
Test screen is not displayed.	The R4870 may be damaged.	Turn off the system immediately. Contact the Advantest sales office.
Buttons do not respond.	The key lock function is on.	Set the KEY LOCK button to off.
The test has started and data cannot be taken.	The IUT is not on.	Check if the IUT power is on or not.
	The RF cable is not connected correctly to the IUT.	Correctly connect the RF cable to the IUT.

A.2 Error Messages

A.2 Error Messages

This section describes error messages which may occur when the OPT01 is installed. For more information on messages which are not described below, refer to Section A.2, “Error Messages” of R4870 Operation Manual.

Table A-2 R4870 OPT01 Error Messages

Error message	Description
Communication Error To the Spectrum Analyzer	A communication error occurred with the spectrum analyzer (R3273). Solution: Check the connection and power, and retry.
Communication Error To the Power Meter	A communication error occurred with the power meter (NRVD). Solution: Check the connection and power, and retry.
Communication Error To the Continuous Interference Signal	A communication error occurred with the signal generator (SMR). Solution: Check the connection and power, and retry.
Communication Error To the Modulated Interference Signal	A communication error occurred with the signal generator (SMIQ). Solution: Check the connection and power, and retry.
Communication Error To the DC Power Supply	A communication error occurred with the DC power supply (2303). Solution: Check the connection and power, and retry.
Burst signal is not detected. In the Spectrum Analyzer.	The burst signal from the IUT cannot be detected by the spectrum analyzer (R3273). Solution: Check the connection and retry.
The signal level is too low. In the Spectrum Analyzer.	The signal level from the IUT is too low in the spectrum analyzer (R3273). Solution: Check the connection and retry.
Cannot detect sensor. In the Power Meter.	The thermal power sensor (NRV-Z52) cannot be detected in the power meter (NRVD). Solution: Check the connection of the sensor head to NRVD and retry.
Zero Calibration Error. In the Power Meter.	Zero calibration of the thermal power sensor (NRV-Z52) failed in the power meter (NRVD). Solution: Check whether the output of the signal generator (SMIQ, SMR) is controlled to OFF and retry.
The calibration data is abnormal.	The calibration data level is extremely low. Solution: Check if the cable is slack, if an RF signal wire is damaged or if the output from the signal generator (SMIQ, SMR) has failed and retry.

ALPHABETICAL INDEX

[Symbol]		
<ul style="list-style-type: none"> < Connection Item 3-8, 3-26 < More 3-7, 3-25 < More (TRM) 3-6, 3-16, 3-17, 3-24 	<ul style="list-style-type: none"> C/I performance 3-6, 3-15, 3-16, 3-17, 3-18, 3-19, 3-24, 4-7 C/I Performance: Image Frequency 2-21 CALIBRATION 5-1 Calibration 1-7, 3-5, 3-9, 3-13, 3-23, 3-27, 3-32 Calibration Setting Procedure 5-1 Carrier Freq. Drift 3-15, 3-19 Carrier Frequency Drift 3-18, 4-5 CH1-Input 3-9, 3-13, 3-27 CH1-Input Calibration 5-7 CH1-Output 3-9, 3-13, 3-27 CH1-Output Calibration 5-8 Comment Edit 2-27, 3-9, 3-13, 3-27, 3-32 Communication Test 3-5, 3-7, 3-11, 3-23, 3-24, 3-30 CONFigure Subsystem - SIG RF 6-8 CONFigure Subsystem - Telec 6-93 Connection 3-8, 3-26 Connection of 2303 Power Supply Output Cable 1-4 Connection with External Unit 7-7 Continuous Calibration 5-11 Current Measure 3-5, 3-23 	
[Numerics]		
<ul style="list-style-type: none"> 20 dB Bandwidth: Bandwidth Level 2-17 20dB Bandwidth 3-6, 3-15, 3-16, 3-17, 3-18, 3-19, 3-24, 3-28, 3-29 		
[A]		
<ul style="list-style-type: none"> About... 3-5, 3-24 Accessories 1-2 ACL data 3-7, 3-25 ACL Packet Types 3-11 ACP: Number of Adjacent Channel 2-17 Adjacent Channel Power 3-29 Adjacent channel power 3-6, 3-15, 3-16, 3-17, 3-18, 3-19, 3-24, 3-28 Air Cording Format 3-12 Antenna Power 3-7, 3-21, 3-22, 3-25 Authentication-IUT as Master 3-7, 3-11, 3-25 Authentication-IUT as Slave 3-7, 3-11, 3-25 		
[B]		
<ul style="list-style-type: none"> Basic Operation 2-1 BER 3-8, 3-13, 3-20, 3-26, 3-31 Blocking Performance 3-29 Blocking performance 3-6, 3-15, 3-16, 3-17, 3-18, 3-19, 3-24, 4-8 Blocking performance: Signal Level 2-22 Bluetooth SIG RF Test Items and Passing Ranges 3-33 		
[C]		
<ul style="list-style-type: none"> C/I Performance 3-29 		
[D]		
<ul style="list-style-type: none"> DC Power Source 2-24 DC Source (ext) 3-9, 3-13, 3-26, 3-31 Delete... 3-5, 3-23 Disconnection 3-8, 3-26 		
[E]		
<ul style="list-style-type: none"> Error Messages A-2 Explorer 3-5, 3-23 		
[F]		
<ul style="list-style-type: none"> Faults in Measuring Instruments 2-38 Faults in the Connection Cable 2-38 FETCh Subsystem - SIG RF 6-71 FETCh Subsystem - Telec 6-110 		

Alphabetical Index

File	3-5, 3-23	Inquiry	3-7, 3-11, 3-24
FM Deviation	3-8, 3-13, 3-20, 3-26, 3-31	Inquiry Scan	3-7, 3-11, 3-24
Frequency Drift	3-6, 3-16, 3-17, 3-24, 3-28, 3-29	Interfere1 port	3-9, 3-13, 3-27
Frequency Range	3-28, 3-29	Interfere1 Port Calibration	5-9
Frequency range	3-6, 3-15, 3-16, 3-17, 3-18, 3-19, 3-24	Interfere2 port	3-9, 3-13, 3-27
Frequency Range: Power Level	2-16	Interfere2 Port Calibration	5-10
Frequency Tolerance	3-6, 3-7, 3-16, 3-17, 3-18, 3-21, 3-22, 3-24, 3-25, 3-28, 3-29, 4-10	Intermodulation Performance	3-6, 3-15, 3-16, 3-17, 3-18, 3-19, 3-24, 3-29
Frequency Tolerance: Sample Packet,etc.../		Intermodulation performance	4-9
Frequency Drift: Sample Packet,etc... ..	2-18	Intermodulation Performance: Signal Level	2-23
Function Select	3-5, 3-6, 3-7, 3-8, 3-9, 3-10, 3-11, 3-12, 3-13, 3-14, 3-15, 3-16, 3-17, 3-19, 3-20, 3-21, 3-22, 3-23	INTRODUCTION	1-1
Function Specifications	6-1	Item ALL OFF	3-11, 3-13, 3-30
Functional Descriptions	3-23	Item ALL ON	3-11, 3-13, 3-30, 3-32
		Item Select	3-14, 3-15, 3-21, 3-28
		IUT Connection	2-9
		IUT Information	2-27, 3-9, 3-13, 3-26, 3-31
		IUT Voice Setting	3-12
		[L]	
		Liner_PCM_Bit_Pos	3-12
		Link Supervision Timeout-IUT as Master	3-7, 3-11, 3-25
		Link Supervision Timeout-IUT as Slave	3-7, 3-11, 3-25
		List of Connections between Devices	1-4
		LMP_test_control	2-23, 3-14, 3-19, 3-29
		Load... ..	3-5, 3-23
		Low Ch. ALL OFF	3-10, 3-12, 3-15, 3-21, 3-28, 3-30
		Low Ch. ALL ON	3-10, 3-12, 3-15, 3-21, 3-28, 3-30
		[I]	
Index	6-1		
Initial Carrier Freq. Tolerance	3-15, 3-19		
Initial Carrier Frequency Tolerance	4-5		
Input Cording	3-12		
Input Data Format	3-12		
Input Sample Size	3-12		
		[M]	
		Main Menu	3-23
		Main Menu and Drop Down Menu	3-5
		Malfunctioning	2-38
		Maximum Input Level	3-6, 3-15,

- 3-16, 3-17,
3-18, 3-19,
3-24, 3-29,
4-9
Maximum Input Level: Tx Level 2-23
Measure 3-5, 3-23
Measure Item > 3-8, 3-26
Measurement Item ALL OFF 3-10, 3-12,
3-15, 3-21,
3-28, 3-30
Measurement Item ALL ON 3-10, 3-12,
3-15, 3-21,
3-28, 3-30
Measurement Parameters 2-38
Measurement-Related Settings 2-10
Menu Index 3-1
Menu Map 3-5
Mid Ch. ALL OFF 3-10, 3-12,
3-15, 3-21,
3-28, 3-30
Mid Ch. ALL ON 3-10, 3-12,
3-15, 3-21,
3-28, 3-30
Mode 3-5, 3-6,
3-7, 3-8,
3-9, 3-10,
3-11, 3-12,
3-13, 3-14,
3-15, 3-16,
3-17, 3-19,
3-20, 3-21,
3-22, 3-23
Modulation Characteristics 3-6, 3-15,
3-16, 3-17,
3-18, 3-19,
3-24, 3-28,
3-29, 4-5
Modulation Characteristics:
Sample Packet 2-18
Monitor1 port 3-9, 3-13,
3-27
Monitor1 Port Calibration 5-6
Monitor2 port 3-9, 3-13,
3-27
Monitor2 Port Calibration 5-5
More > 3-7, 3-25
More >(TRC/RCV) 3-6, 3-16,
3-17, 3-24
- [N]**
Network Config... 3-5, 3-23
- [O]**
OBW/Spread. BW 3-7, 3-21,
3-22, 3-25
Occupied Frequency Bandwidth /
Spread Bandwidth 4-10
Occupied Frequency Bandwidth/
Spreading Bandwidth 3-22
OPERATIONS 2-1
Option 3-5, 3-23
Out-of-Band Spurious Emissions 3-6, 3-16,
3-24, 3-28,
4-6
Output Power 3-6, 3-15,
3-16, 3-17,
3-18, 3-19,
3-24, 3-28,
3-29, 4-2
Output Power (Power Control):
Power Range 2-13
- [P]**
Paging-IUT as Master 3-7, 3-11,
3-24
Paging-IUT as Slave 3-7, 3-11,
3-25
Pairing 3-7, 3-11,
3-25
Panel Lock OFF 3-5, 3-24
Panel Lock ON 3-5, 3-24
Pass/Fail Evaluation of the Bluetooth
SIG RF Test 3-35
PASS/FAIL Limit 2-12, 3-14,
3-16, 3-20,
3-21, 3-22,
3-28, 3-31
Peripheral Device Option 1-8
Peripheral Devices 7-6
PIN Code 3-12
Power Control 3-6, 3-15,
3-16, 3-17,
3-18, 3-19,
3-24, 3-28,
3-29, 4-3
Power Control: Minimum Power 2-15
Power Density 3-6, 3-15,
3-16, 3-17,
3-18, 3-19,
3-24, 3-28,
3-29, 4-3
Power Density: Sweep Time 2-14
Power Off 3-5, 3-23
Power Splitter 3-9, 3-13,

Alphabetical Index

Power Splitter Calibration 3-27
 PROCedure Subsystem - SIG RF 5-3
 PROCedure Subsystem - Telec 6-67
 Procedures for Turning on Power 6-107
 Procedures for Turning on Power 2-9

[R]

Radio Law 3-5, 3-7,
 3-21, 3-22,
 3-23, 3-25,
 3-30
 RCV/CA/01/C 3-34, 3-36
 RCV/CA/02/C 3-34, 3-36
 RCV/CA/03/C 3-34, 3-36
 RCV/CA/04/C 3-34, 3-36
 RCV/CA/05/C 3-34, 3-36
 RCV/CA/06/C 3-34, 3-36
 Receiver Measurement 7-3
 Receiver Test (BER,PER) 3-17, 3-18,
 3-29
 Receiver Test: (BER,PER) 2-20
 Recognition of Peripheral Devices 2-9
 REFERENCE 3-1
 REMOTE CONTROL 6-1
 Remote Loopback 3-5, 3-8,
 3-12, 3-23,
 3-25, 3-30
 RF Measurement 3-5, 3-8,
 3-13, 3-20,
 3-23, 3-26,
 3-31
 RS-232 (HCI) 2-26
 RS-232 Port 3-9, 3-13,
 3-26, 3-31

[S]

Save... 3-5, 3-23
 SCO data-IUT as Master 3-7, 3-11,
 3-25
 SCO data-IUT as Slave 3-7, 3-11,
 3-25
 SCO Loopback-IUT as Master 3-8, 3-12,
 3-26
 SCO Loopback-IUT as Slave 3-8, 3-12,
 3-25
 SCO Packet Type 3-12
 Secondly Emitted Radio Wave
 Strength 4-12
 Secondly Emitted Radio Wave
 Strength (Spurious Emission Rx) 3-22
 Sensitivity (multi-slot packets) 4-6
 Sensitivity (single slot packets) 4-6

Sensitivity-multi-slot packets 3-6, 3-15,
 3-16, 3-19,
 3-24, 3-29
 Sensitivity-single / multi: Dirty ON/OFF,
 TX Level 2-20
 Sensitivity-single slot packets 3-6, 3-15,
 3-16, 3-19,
 3-24, 3-29
 Sensitivity-single/multi 3-17, 3-18,
 3-29
 Set Default 3-10, 3-11,
 3-12, 3-13,
 3-15, 3-21,
 3-28, 3-30,
 3-32
 Set Default All 3-19, 3-29
 Set Default Packets 3-19, 3-29
 Set Default Poll Period 3-19, 3-30
 Set Default Test scenario 3-19, 3-29
 Setup 3-5, 3-23
 Side Menu 3-6, 3-24
 SIG RF 3-5, 3-6,
 3-10, 3-14,
 3-15, 3-16,
 3-17, 3-19,
 3-23, 3-24,
 3-28, 4-2
 SIG RF Test 2-28
 SOURce Subsystem - DC Power Source 6-118
 Special 3-5, 3-23
 SPECIFICATIONS 7-1
 Spurious Emission (Rx) 3-7, 3-21,
 3-22
 Spurious Emission (Tx) 3-7, 3-21,
 3-22, 3-25
 Spurious Emission Strength 4-11
 Spurious Emission Strength
 (Spurious Emission Tx) 3-22
 Spurious Emissions 3-15, 3-19
 Spurious Emissions (ETS) 3-17, 3-18,
 3-29
 Spurious Emissions (ETS)/(FCC):
 Test Frequency 2-19
 Spurious Emissions (FCC) 3-17, 3-18,
 3-29
 Spuriouse Emission (Rx) 3-25
 Staying Time 3-7, 3-21,
 3-22, 3-25,
 4-11
 System 3-5, 3-23
 System Configuration 2-27, 3-9,
 3-13, 3-26,
 3-32

System Overview 1-1
 System Setup 2-24, 3-5,
 3-9, 3-13,
 3-23, 3-26,
 3-31

V Source ON 3-5, 3-23

[W]

Warm up 1-7

[T]

Tab 3-14
 Telec 3-5, 3-7,
 3-21, 3-22,
 3-23, 3-25,
 3-30
 TELEC RF Settings 2-8
 TELEC Test 2-31
 Telec Test 4-10
 TELEC Test Setting 2-5
 TEST METHODS 4-1
 Test Parameter 2-13, 3-14,
 3-17, 3-20,
 3-29, 3-31
 Time Adjust... 3-5, 3-23
 Tolerance of Antenna Power 3-22, 4-11
 Transmitter Measurement 7-1
 TRC/CA/01/C 3-33, 3-36
 TRM/CA/01/C 3-33, 3-34,
 3-35
 TRM/CA/02/C 3-33, 3-35
 TRM/CA/03/C 3-33, 3-35
 TRM/CA/04/C 3-33, 3-35
 TRM/CA/05/C 3-33, 3-35
 TRM/CA/06/C 3-33, 3-35
 TRM/CA/07/C 3-33, 3-34,
 3-35
 TRM/CA/08/C 3-33, 3-34,
 3-35
 TRM/CA/09/C 3-33, 3-34,
 3-36
 Troubleshooting A-1
 Turning on Power 2-1
 TX Output Spectrum - 20dB Bandwidth 4-4
 TX Output Spectrum - Adjacent Channel
 Power 4-5
 TX Output Spectrum - Frequency Range 4-4

[U]

Utility 3-5, 3-8,
 3-12, 3-13,
 3-20, 3-23,
 3-25, 3-30

[V]

V Source OFF 3-5, 3-23

IMPORTANT INFORMATION FOR ADVANTEST SOFTWARE

PLEASE READ CAREFULLY: This is an important notice for the software defined herein. Computer programs including any additions, modifications and updates thereof, operation manuals, and related materials provided by Advantest (hereafter referred to as "SOFTWARE"), included in or used with hardware produced by Advantest (hereafter referred to as "PRODUCTS").

SOFTWARE License

All rights in and to the SOFTWARE (including, but not limited to, copyright) shall be and remain vested in Advantest. Advantest hereby grants you a license to use the SOFTWARE only on or with Advantest PRODUCTS.

Restrictions

- (1) You may not use the SOFTWARE for any purpose other than for the use of the PRODUCTS.
- (2) You may not copy, modify, or change, all or any part of, the SOFTWARE without permission from Advantest.
- (3) You may not reverse engineer, de-compile, or disassemble, all or any part of, the SOFTWARE.

Liability

Advantest shall have no liability (1) for any PRODUCT failures, which may arise out of any misuse (misuse is deemed to be use of the SOFTWARE for purposes other than its intended use) of the SOFTWARE. (2) For any dispute between you and any third party for any reason whatsoever including, but not limited to, infringement of intellectual property rights.

LIMITED WARRANTY

1. Unless otherwise specifically agreed by Seller and Purchaser in writing, Advantest will warrant to the Purchaser that during the Warranty Period this Product (other than consumables included in the Product) will be free from defects in material and workmanship and shall conform to the specifications set forth in this Operation Manual.
2. The warranty period for the Product (the "Warranty Period") will be a period of one year commencing on the delivery date of the Product.
3. If the Product is found to be defective during the Warranty Period, Advantest will, at its option and in its sole and absolute discretion, either (a) repair the defective Product or part or component thereof or (b) replace the defective Product or part or component thereof, in either case at Advantest's sole cost and expense.
4. This limited warranty will not apply to defects or damage to the Product or any part or component thereof resulting from any of the following:
 - (a) any modifications, maintenance or repairs other than modifications, maintenance or repairs (i) performed by Advantest or (ii) specifically recommended or authorized by Advantest and performed in accordance with Advantest's instructions;
 - (b) any improper or inadequate handling, carriage or storage of the Product by the Purchaser or any third party (other than Advantest or its agents);
 - (c) use of the Product under operating conditions or environments different than those specified in the Operation Manual or recommended by Advantest, including, without limitation, (i) instances where the Product has been subjected to physical stress or electrical voltage exceeding the permissible range and (ii) instances where the corrosion of electrical circuits or other deterioration was accelerated by exposure to corrosive gases or dusty environments;
 - (d) use of the Product in connection with software, interfaces, products or parts other than software, interfaces, products or parts supplied or recommended by Advantest;
 - (e) incorporation in the Product of any parts or components (i) provided by Purchaser or (ii) provided by a third party at the request or direction of Purchaser or due to specifications or designs supplied by Purchaser (including, without limitation, any degradation in performance of such parts or components);
 - (f) Advantest's incorporation or use of any specifications or designs supplied by Purchaser;
 - (g) the occurrence of an event of force majeure, including, without limitation, fire, explosion, geological change, storm, flood, earthquake, tidal wave, lightning or act of war; or
 - (h) any negligent act or omission of the Purchaser or any third party other than Advantest.
5. **EXCEPT TO THE EXTENT EXPRESSLY PROVIDED HEREIN, ADVANTEST HEREBY EXPRESSLY DISCLAIMS, AND THE PURCHASER HEREBY WAIVES, ALL WARRANTIES, WHETHER EXPRESS OR IMPLIED, STATUTORY OR OTHERWISE, INCLUDING, WITHOUT LIMITATION, (A) ANY WARRANTY OF MERCHANTABILITY OR FITNESS FOR A PARTICULAR PURPOSE AND (B) ANY WARRANTY OR REPRESENTATION AS TO THE VALIDITY, SCOPE, EFFECTIVENESS OR USEFULNESS OF ANY TECHNOLOGY OR ANY INVENTION.**
6. **THE REMEDY SET FORTH HEREIN SHALL BE THE SOLE AND EXCLUSIVE REMEDY OF THE PURCHASER FOR BREACH OF WARRANTY WITH RESPECT TO THE PRODUCT.**
7. **ADVANTEST WILL NOT HAVE ANY LIABILITY TO THE PURCHASER FOR ANY INDIRECT, INCIDENTAL, SPECIAL, CONSEQUENTIAL OR PUNITIVE DAMAGES, INCLUDING, WITHOUT LIMITATION, LOSS OF ANTICIPATED PROFITS OR REVENUES, IN ANY AND ALL CIRCUMSTANCES, EVEN IF ADVANTEST HAS BEEN ADVISED OF THE POSSIBILITY OF SUCH DAMAGES AND WHETHER ARISING OUT OF BREACH OF CONTRACT, WARRANTY, TORT (INCLUDING, WITHOUT LIMITATION, NEGLIGENCE), STRICT LIABILITY, INDEMNITY, CONTRIBUTION OR OTHERWISE. TORT (INCLUDING, WITHOUT LIMITATION, NEGLIGENCE), STRICT LIABILITY, INDEMNITY, CONTRIBUTION OR OTHERWISE.**
8. **OTHER THAN THE REMEDY FOR THE BREACH OF WARRANTY SET FORTH HEREIN, ADVANTEST SHALL NOT BE LIABLE FOR, AND HEREBY DISCLAIMS TO THE FULLEST EXTENT PERMITTED BY LAW ANY LIABILITY FOR, DAMAGES FOR PRODUCT FAILURE OR DEFECT, WHETHER ARISING OUT OF BREACH OF CONTRACT, TORT (INCLUDING, WITHOUT LIMITATION, NEGLIGENCE), STRICT LIABILITY, INDEMNITY, CONTRIBUTION OR OTHERWISE.**

CUSTOMER SERVICE DESCRIPTION

In order to maintain safe and trouble-free operation of the Product and to prevent the incurrence of unnecessary costs and expenses, Advantest recommends a regular preventive maintenance program under its maintenance agreement.

Advantest's maintenance agreement provides the Purchaser on-site and off-site maintenance, parts, maintenance machinery, regular inspections, and telephone support and will last a maximum of ten years from the date the delivery of the Product. For specific details of the services provided under the maintenance agreement, please contact the nearest Advantest office listed at the end of this Operation Manual or Advantest's sales representatives.

Some of the components and parts of this Product have a limited operating life (such as, electrical and mechanical parts, fan motors, unit power supply, etc.). Accordingly, these components and parts will have to be replaced on a periodic basis. If the operating life of a component or part has expired and such component or part has not been replaced, there is a possibility that the Product will not perform properly. Additionally, if the operating life of a component or part has expired and continued use of such component or part damages the Product, the Product may not be repairable. Please contact the nearest Advantest office listed at the end of this Operation Manual or Advantest's sales representatives to determine the operating life of a specific component or part, as the operating life may vary depending on various factors such as operating condition and usage environment.

SALES & SUPPORT OFFICES

Advantest Korea Co., Ltd.

22BF, Kyobo KangNam Tower,
1303-22, Seocho-Dong, Seocho-Ku, Seoul #137-070, Korea
Phone: +82-2-532-7071
Fax: +82-2-532-7132

Advantest (Suzhou) Co., Ltd.

Shanghai Branch Office:
Bldg. 6D, NO.1188 Gumei Road, Shanghai, China 201102 P.R.C.
Phone: +86-21-6485-2725
Fax: +86-21-6485-2726

Shanghai Branch Office:
406/F, Ying Building, Quantum Plaza, No. 23 Zhi Chun Road,
Hai Dian District, Beijing,
China 100083
Phone: +86-10-8235-3377
Fax: +86-10-8235-6717

Advantest (Singapore) Pte. Ltd.

438A Alexandra Road, #08-03/06
Alexandra Technopark Singapore 119967
Phone: +65-6274-3100
Fax: +65-6274-4055

Advantest America, Inc.

3201 Scott Boulevard, Suite, Santa Clara, CA 95054, U.S.A
Phone: +1-408-988-7700
Fax: +1-408-987-0691

ROHDE & SCHWARZ Europe GmbH

Mühldorfstraße 15 D-81671 München, Germany
(P.O.B. 80 14 60 D-81614 München, Germany)
Phone: +49-89-4129-13711
Fax: +49-89-4129-13723

ADVANTEST®

<http://www.advantest.co.jp>