ADVANTEST®

ADVANTEST CORPORATION

**INSTRUCTION
MANUAL**

TR47241

Personality Kit

MANUAL NUMBER 47241 OEA 606

Before reselling to other corporations or re-exporting to other countries, you are required to obtain permission from both the Japanese Government under its Export Control Act and the U.S. Government under its Export Control Law.

TR47241
PERSONALITY KIT
INSTRUCTION MANUAL

PREFACE

PREFACE

This manual applies to the system disk P47241-001FJ V2.0.

TR47241
PERSONALITY KIT
INSTRUCTION MANUAL

LIST OF EFFECTIVE PAGES

LIST OF EFFECTIVE PAGES

Preface	Preface	Jun 16/86	3 - 8	Jun 16/86
Record of Revisions	R - 1	Jun 16/86	3 - 9	Jun 16/86
List of Effective Pages	P - 1	Jun 16/86	3 - 10	Jun 16/86
List of Related Manuals	M - 1	Jun 16/86	3 - 11	Jun 16/86
Table of Contents	C - 1	Jun 16/86	3 - 12	Jun 16/86
1 - 1		Jun 16/86	3 - 13	Jun 16/86
1 - 2		Jun 16/86	3 - 14	Jun 16/86
1 - 3		Jun 16/86	3 - 15	Jun 16/86
2 - 1		Jun 16/86	4 - 1	Jun 16/86
2 - 2		Jun 16/86	4 - 2	Jun 16/86
2 - 3		Jun 16/86	4 - 3	Jun 16/86
2 - 4		Jun 16/86	4 - 4	Jun 16/86
2 - 5		Jun 16/86	4 - 5	Jun 16/86
2 - 6		Jun 16/86	4 - 6	Jun 16/86
2 - 7		Jun 16/86	4 - 7	Jun 16/86
2 - 8		Jun 16/86	5 - 1	Jun 16/86
2 - 9		Jun 16/86	5 - 2	Jun 16/86
2 - 10		Jun 16/86	5 - 3	Jun 16/86
2 - 11		Jun 16/86	5 - 4	Jun 16/86
2 - 12		Jun 16/86	6 - 1	Jun 16/86
2 - 13		Jun 16/86	6 - 2	Jun 16/86
2 - 14		Jun 16/86	7 - 1	Jun 16/86
2 - 15		Jun 16/86	7 - 2	Jun 16/86
2 - 16		Jun 16/86	List of Figures	F - 1 Jun 16/86
2 - 17		Jun 16/86		F - 2 Jun 16/86
2 - 18		Jun 16/86	List of Tables	T - 1 Jun 16/86
2 - 19		Jun 16/86	List of Examples	E - 1 Jun 16/86
2 - 20		Jun 16/86	Alphabetical Index	I - 1 Jun 16/86
2 - 21		Jun 16/86		
2 - 22		Jun 16/86		
2 - 23		Jun 16/86		
2 - 24		Jun 16/86		
2 - 25		Jun 16/86		
3 - 1		Jun 16/86		
3 - 2		Jun 16/86		
3 - 3		Jun 16/86		
3 - 4		Jun 16/86		
3 - 5		Jun 16/86		
3 - 6		Jun 16/86		
3 - 7		Jun 16/86		

Note: Pages with # are revised.
Pages with ## are added.
Pages with () are deleted.

TR47241
PERSONALITY KIT
INSTRUCTION MANUAL

LIST OF RELATED MANUALS

LIST OF RELATED MANUALS

<u>Manual No.</u>	<u>Manual Name</u>	<u>Remarks</u>
TR4725	Logic Analyzer	
TR47250	Personality Kit	
TR47251	Personality Kit	
TR47252	Personality Kit	
TR47241	Personality Kit	
TR47242	Personality Kit	
TR47243	Personality Kit	

TR47241
PERSONALITY KIT
INSTRUCTION MANUAL

TABLE OF CONTENTS

TABLE OF CONTENTS

1. GENERAL INFORMATION	1 - 1
1.1 HOW TO USE THIS INSTRUCTION MANUAL	1 - 1
1.2 TR47241 GENERAL DESCRIPTIONS	1 - 2
1.3 UNPACKING AND INSPECTION	1 - 3
1.3.1 Appearance Check and Component Confirmation	1 - 3
2. MEASUREMENT PREPARATION AND PREPARATORY INFORMATION	2 - 1
2.1 INTRODUCTION	2 - 1
2.2 PERSONALITY BOARD INSTALLATION METHOD	2 - 2
2.3 CONNECTING PROBE AND THE SYSTEM UNDER TEST	2 - 3
2.3.1 Connecting Microprocessor Probe	2 - 3
2.3.2 Connecting Data Acquisition Probe E/F	2 - 6
2.4 USE OF THE MICROPROCESSOR PROBE	2 - 10
2.5 LOADING THE SYSTEM SOFTWARE	2 - 11
2.6 CRT DISPLAY FORMATS AND THEIR MEANINGS	2 - 14
2.7 INPUTTING DATA TO MENU ITEMS	2 - 18
2.8 USE OF HELP KEY	2 - 20
2.9 USER DISK PREPARATION	2 - 24
3. OPERATION EXAMPLES	3 - 1
3.1 INTRODUCTION	3 - 1
3.2 SIMPLE EXAMPLES OF TIMING ANALYSIS	3 - 2
3.3 SIMPLE EXAMPLES OF STATE ANALYSIS	3 - 7
3.4 SIMPLE EXAMPLES OF S & T ANALYSIS	3 - 9
3.5 FLOPPY DISK APPLICATIONS	3 - 10
3.6 USE OF QuickVIEW	3 - 11
3.7 EXAMPLES OF USING THE PROGRAMS	3 - 12
4. PERSONALITY KIT PERFORMANCE CHARACTERISTICS	4 - 1
4.1 INTRODUCTION	4 - 1
4.2 INPUT CHANNEL CONFIGURATION (CONFIG)	4 - 2
4.2.1 CONFIG Menu Screen for Z80 Microprocessor	4 - 2
4.3 SYMBOL AND CODE DEFINITIONS (SYMDEF)	4 - 4
4.3.1 CODE Table for Z80	4 - 4
4.4 DISPLAY OF CAPTURED DATA IN STATE ANALYZER (DISPLAY)	4 - 5
4.4.1 Measured Data Display	4 - 5
4.4.2 Z80 Disassembling Format	4 - 7
5. OPERATION CHECK	5 - 1
5.1 MICROPROCESSOR PROBE TEST	5 - 1
5.2 DATA ACQUISITION PROBE E/F TEST	5 - 4
6. EQUIPMENT STORAGE AND TRANSPORTATION PRECAUTIONS	6 - 1
6.1 STORAGE	6 - 1
6.2 TRANSPORTATION	6 - 2
7. SPECIFICATIONS	7 - 1
7.1 TR47241 SPECIFICATIONS	7 - 1

TR47241
PERSONALITY KIT
INSTRUCTION MANUAL

1.1 HOW TO USE THIS INSTRUCTION MANUAL

1. GENERAL INFORMATION

1.1 HOW TO USE THIS INSTRUCTION MANUAL

The ADVANTEST TR4725 Logic Analyzer instruction manual consists of the TR4725 instruction manual (hereafter called the main unit instruction manual) and all of the personality kit instruction manuals (the PK instruction manual).

For beginners of logic analyzer, ADVANTEST recommends reading in the order of Chapter 1 and Chapter 2, Section 2.8 "Panel Descriptions" of the main unit instruction manual and then Chapters 1, 2 and 3 of the PK instruction manual for familiarization of the operating procedures (Chapters 2 and 3 of the main unit instruction manual are not necessary to read.)

TR47241
PERSONALITY KIT
INSTRUCTION MANUAL

1.2 TR47241 GENERAL DESCRIPTIONS

1.2 TR47241 GENERAL DESCRIPTIONS

The TR47241 Z80 Personality Kit is the plug-in probe for state analysis used by installing in the TR4725 Logic Analyzer main unit. The major features of this personality kit are as follows:

- (1) State analysis has been expedited since Z80 mnemonic is also available, along with numeric values, for analysis of the captured data.
- (2) Data capturing is assigned to special hardware, thus high accuracy analysis can be performed with a smaller probe.
- (3) State analysis efficiency has been upgraded since symbols and codes are defined and provided for setting measuring conditions or analyzing measured data.
- (4) Complicated applications are enabled by more than one trace window condition and memory fragmentation for setting trace conditions.
- (5) Measurement labor-saving, standardization, and automation have been achieved by the application of high performance user interface, such as the use of the interactive menu procedure and the simple-to-use disk operation.
- (6) The major system software provided with the system disk attached to the personality kit ensures the upgrading of the performance functions along with the system disk updated revision.

TR47241
PERSONALITY KIT
INSTRUCTION MANUAL

1.3 UNPACKING AND INSPECTION

1.3 UNPACKING AND INSPECTION

1.3.1 Appearance Check and Component Confirmation

Upon receiving the TR47241 Personality Kit, inspect the product appearance to check for any damage caused by transportation.

Next, check the component quantity and ratings according to the following list. If any inadequacy or defect or damage is found, contact your nearest ADVANTEST representative. The addresses and telephone numbers are listed at the end of this manual.

Item name	Model name	Q'ty
Personality board		1
Microprocessor probe	TR14724-10	1
40-pin DIP clip cable	A04724-11	1
40-pin DIP plug cable	A04724-12	1
Probe test adapter		1
40-pin DIP IC package		1
System software package	P47241-001FJ	2
Blank disk	MF-2DD	2
Disk storage case		1
Miscellaneous container		1
Personality kit storage case		1
Instruction manual	E47241	1

* The blank disk can be purchased separately.
Model name: A09502 (one set contains ten disks.)

MEMO



A large, empty rectangular area with rounded corners, enclosed by a dashed border, intended for writing a memo.

TR47241
PERSONALITY KIT
INSTRUCTION MANUAL

2.1 INTRODUCTION

2. MEASUREMENT PREPARATION AND PREPARATORY INFORMATION

2.1 INTRODUCTION

Be sure to read this chapter if using this probe for the first time. This chapter describes the operations preparatory to measurement and the necessary preparatory information. The description is constructed so that the reader can understand the contents of it while actually operating the probe. Therefore, place the probe within reach when reading this manual for operation.

TR47241
PERSONALITY KIT
INSTRUCTION MANUAL

2.2 PERSONALITY BOARD INSTALLATION METHOD

2.2 PERSONALITY BOARD INSTALLATION METHOD

Follow the following procedures for installing the personality board.
(The personality board is not installed in the TR4725 main unit when shipped.)

- (1) Check that the power is turned OFF.
- (2) Remove the four machine screws (3mm;+) from the main unit cover and remove the upper cover.
- (3) When an other personality board is already installed, remove it. Markers "1" and "2" are affixed on the personality board slot (refer to Figure 2-1).
- (4) Install the personality board with marker "1" on the board ejector into the slot "1". Then, connect the 50-pin flat cable to the connector in the center of the board.
- (5) Mount the four machine screws to re-set the upper cover.

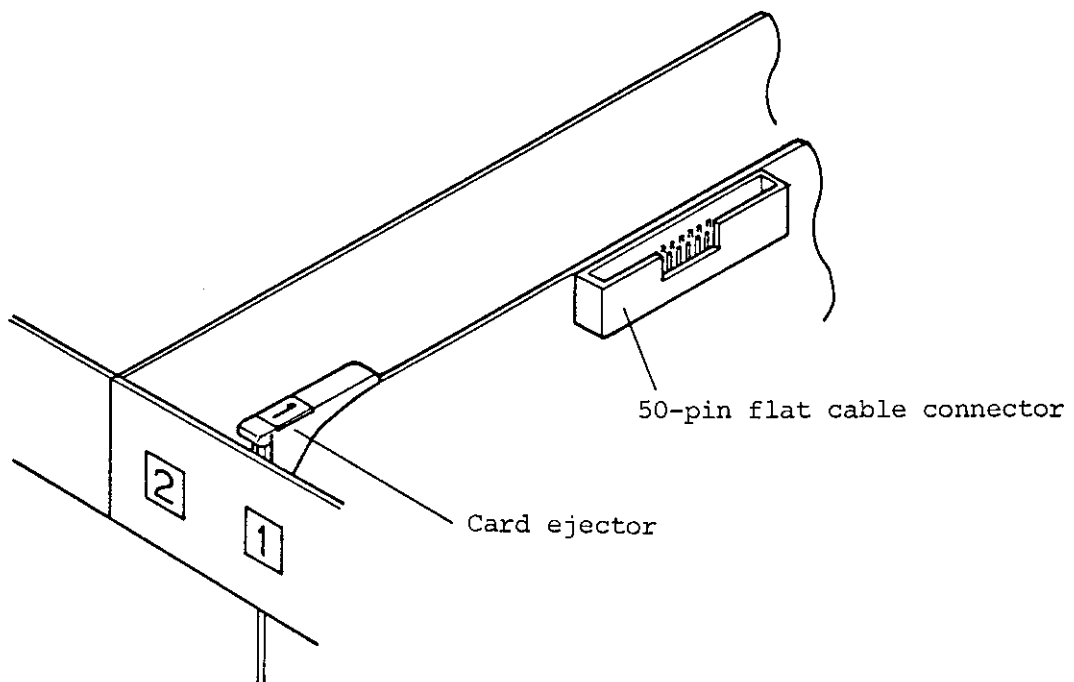

Figure 2-1 Personality Board Installation Method

TR47241
PERSONALITY KIT
INSTRUCTION MANUAL

2.3 CONNECTING PROBE AND THE SYSTEM UNDER TEST

2.3 CONNECTING PROBE AND THE SYSTEM UNDER TEST

Perform the following procedures to connect probe to the system to be measured using Z80:

2.3.1 Connecting Microprocessor Probe

This personality kit contains a microprocessor probe (TR14724-10) for connecting a system under test (termed SUT hereafter) in which a microprocessor Z80 is used. This section describes the actual connecting method of the probe. For how to handle the data captured by the probe, see Section 4.2.1.

Figure 2-2 shows the shape and parts names of the microprocessor probe.

(1) Connecting the microprocessor probe to the main unit

Two connectors with the name plates "C" and "D" are provided at the cable end of the microprocessor probe (TR14724-10). Insert respectively the two connectors to the probe slots in the main unit rear panel. The connectors can be locked by screws.

Caution

Before connecting microprocessor probe, make sure to turn OFF the power of the main unit.

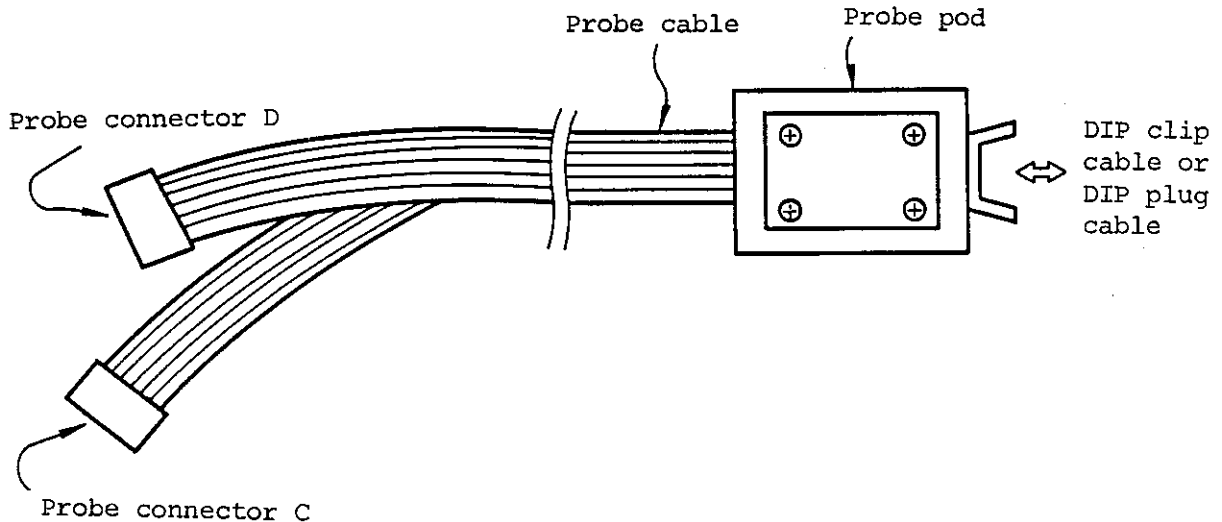

Figure 2-2 Microprocessor Probe Shape and Parts Names

TR47241
PERSONALITY KIT
INSTRUCTION MANUAL

2.3 CONNECTING PROBE AND THE SYSTEM UNDER TEST

(2) Connecting the microprocessor probe and SUT

There are two procedures to connect the microprocessor probe to the SUT (System Under Test): by using DIP clip cable or DIP plug cable. These are illustrated respectively in Figures 2-3 and 2-4.

Either procedure is applicable when the target microprocessor uses a socket. Only DIP clip cable is applicable when soldering is used for the target microprocessor. The connecting must be performed without mistaking pin 1 position no matter which procedure is adopted.

TR47241
PERSONALITY KIT
INSTRUCTION MANUAL

2.3 CONNECTING PROBE AND THE SYSTEM UNDER TEST

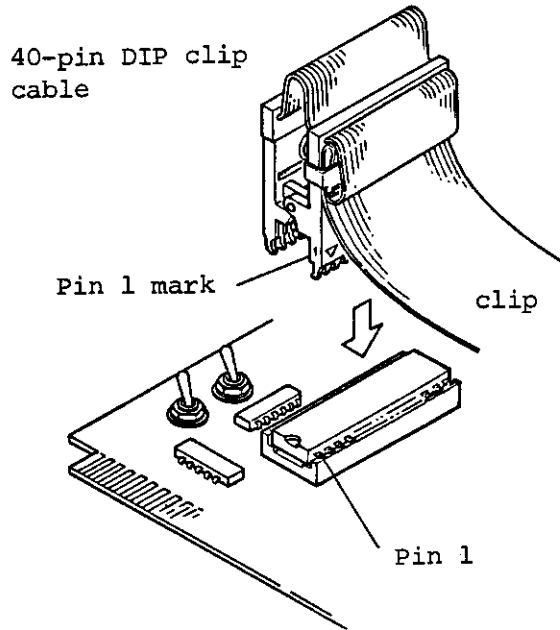

Figure 2-3 The Use of DIP Clip Cable

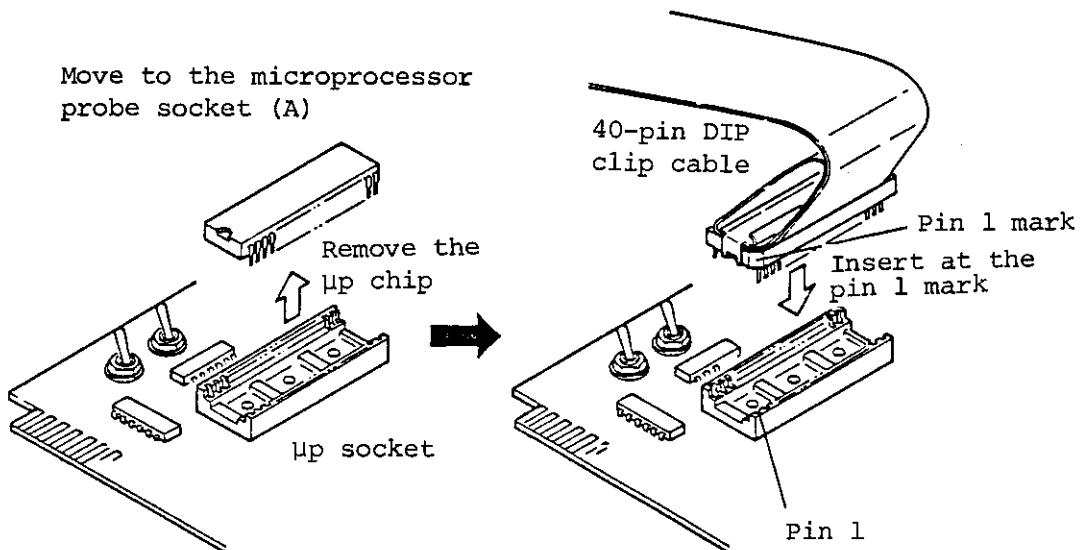

Figure 2-4 The Use of DIP Plug Cable

TR47241
PERSONALITY KIT
INSTRUCTION MANUAL

2.3 CONNECTING PROBE AND THE SYSTEM UNDER TEST

2.3.2 Connecting Data Acquisition Probe E/F

Two probes, data acquisition probe E (TR14702-01; hereafter called probe E) and data acquisition probe F (TR14702-02; hereafter called probe F), are used to capture data from the system under test (hereafter called SUT). Each probe can capture signals of eight channels. The shapes and parts names of probe E/F are shown in Figure 2-5.

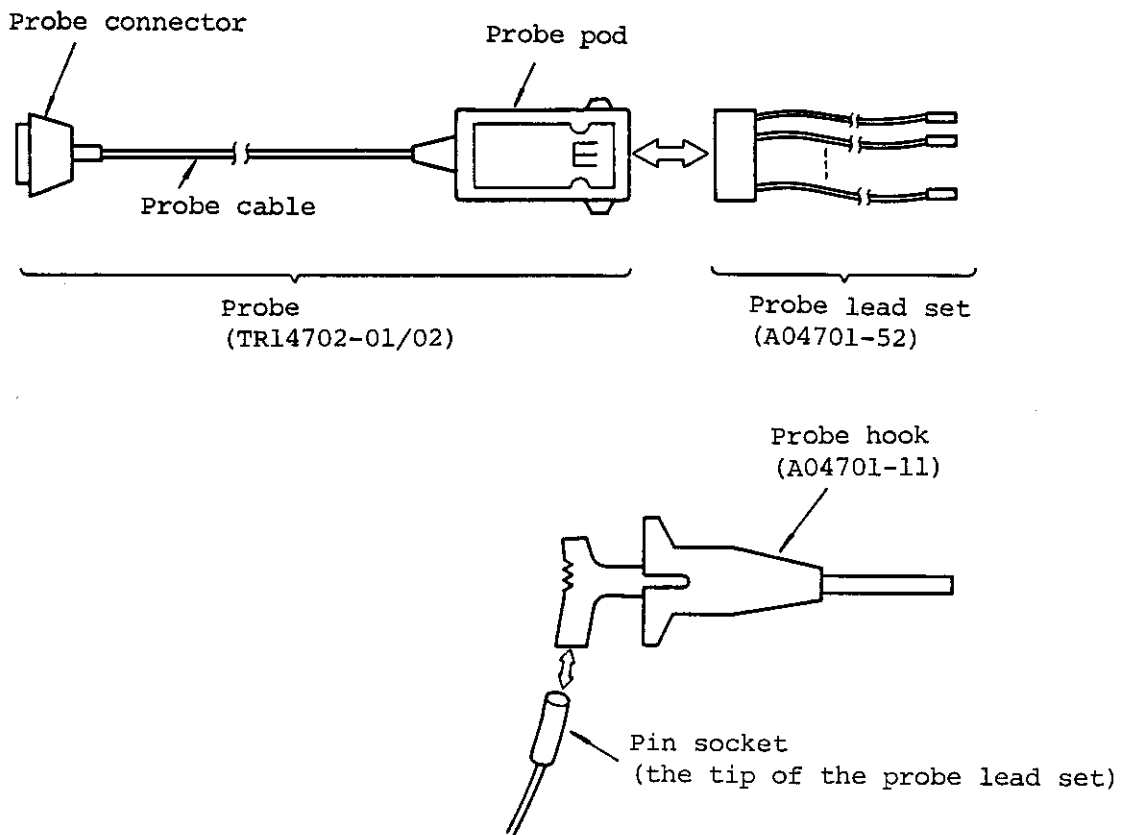

↔ indicates that the part can be freely attached and removed

Figure 2-5 Probe E/F Shape and Parts Names (standard configuration)

TR47241
PERSONALITY KIT
INSTRUCTION MANUAL

2.3 CONNECTING PROBE AND THE SYSTEM UNDER TEST

First, connect the probe to the TR4725 main unit. Connect the probe E cable connector to the probe slot E ("E" is marked at the rear panel) and the probe F cable connector to the probe slot F after each probe connector is put through the cable holder at the left of the rear panel as shown in Figure 2-6.

Caution

Before connecting probe E/F, make sure to turn OFF the power of the main unit.

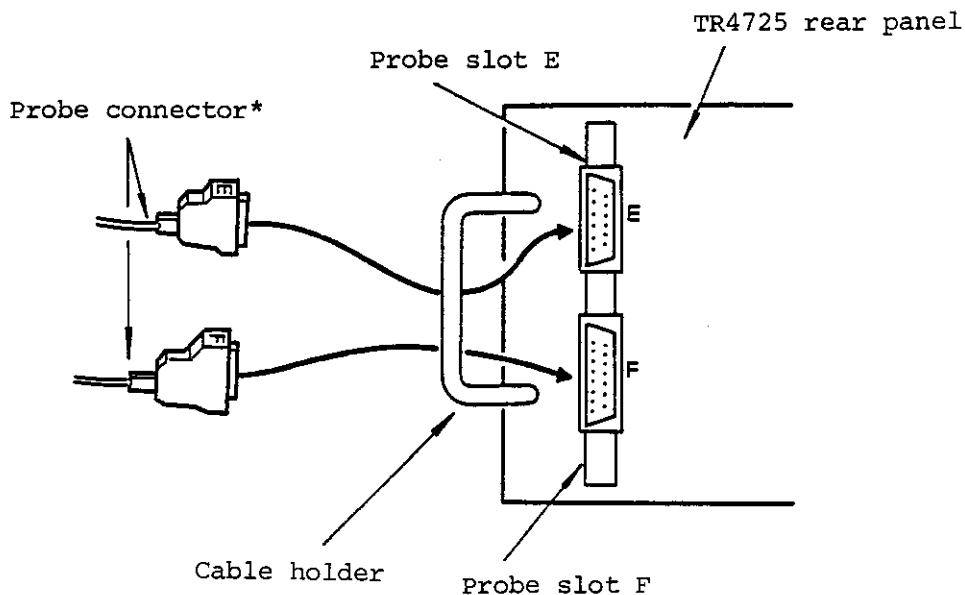

*: Insert the connector name plate E/F upward

Figure 2-6 Connecting Probe E/F to the TR4725 Main Unit

Next, connect probe to SUT. As a standard procedure, use the probe lead set (A04701-52) with pin socket to connect probe to SUT via probe hook (A04701-11; single hook). When the pin which is suitable for pin socket is found in SUT, direct connection with the pin socket is possible. The stock No. and size of the pin socket is as follows:

TR47241
PERSONALITY KIT
INSTRUCTION MANUAL

2.3 CONNECTING PROBE AND THE SYSTEM UNDER TEST

Manufacturer	Stock No.	Suitable size
AUGAT KK-JAPAN	LSG-2BG2-1	0.51mm ϕ ~ 0.76mm ϕ

If necessary, probe can be connected to the SUT by using other optional accessories. Instead of the standard probe hook, the probe hook with a double hook tip-pin (A04701-16; double hook) can be used. (Refer to Figure 2-7 (a).)

Use the probe lead set (A04701-51) when soldering is used instead of probe hook or pin socket for connection. In this case, the connection of eight channels can be performed in one procedure. (Refer to Figure 2-7 (b).)

The use of the DIP IC clip (A04702-30/40/48/64) makes the connecting with DIP IC easier. In this case, connect the pin socket to the pin of the clip. (Refer to Figure 2-7 (c).)

TR47241
 PERSONALITY KIT
 INSTRUCTION MANUAL

2.3 CONNECTING PROBE AND THE SYSTEM UNDER TEST

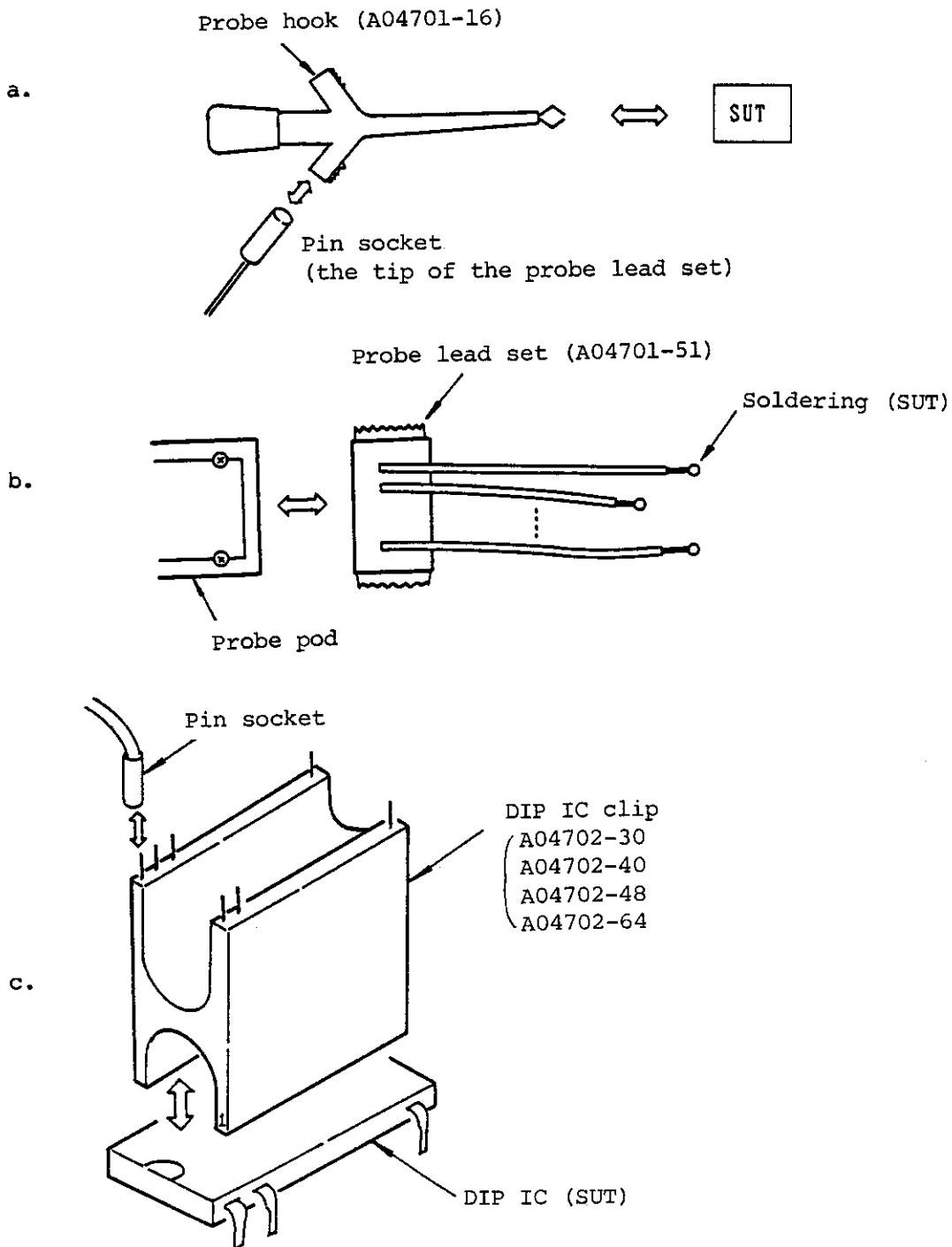

*: Match at pin 1 and then clip.

Figure 2-7 Connecting SUT with Optional Accessories

TR47241
PERSONALITY KIT
INSTRUCTION MANUAL

2.4 USE OF THE MICROPROCESSOR PROBE

2.4 USE OF THE MICROPROCESSOR PROBE

(1) Use of the microprocessor probe socket

Insert the removed target microprocessor into socket on the probe and lower the lever when connecting probe and the SUT with the DIP plug cable.

(2) Use of the status LEDs on the microprocessor probe

The following six status LEDs can be found on the microprocessor probe monitoring the state of the SUT microprocessor:

(Refer to the TR14724-10 External View at the end of this manual.)

- CLK : Lights when clock signal is applied.
- RESET : Lights when reset signal is applied.
- INTR : Lights when interrupt signal is applied.
- NMI : Lights when interrupt signal (NMI) is applied.
- WAIT : Lights when WAIT signal is applied.
- BUSRQ/HALT: Lights when BUSRQ or HALT signal is applied.

TR47241
PERSONALITY KIT
INSTRUCTION MANUAL

2.5 LOADING THE SYSTEM SOFTWARE

2.5 LOADING THE SYSTEM SOFTWARE

The software (system software) which controls the operation of the personality kit is loaded from the system disk (P47241-001FJ) to the internal memory and executed. The built-in floppy disk drive is used for the system software loading.

Insert the system disk into the floppy disk drive, turn ON the POWER switch, and then loading starts automatically.

As shown in Figure 2-8, the following messages are displayed for loading:

```
TR47241
```

Z80 PK

System software loading in progress

Self-test ended

054725 V2.1 Copyright 1985 ADVANTEST CORPORATION

Figure 2-8 Screen Display for Loading

Loading requires approximately one minute. At the end of loading, CONFIGURATION (corresponds to CONFIG key) menu is displayed and the system enters into operation-enabled state as shown in Figure 2-9.

TR47241
PERSONALITY KIT
INSTRUCTION MANUAL

2.5 LOADING THE SYSTEM SOFTWARE

```

** CONFIGURATION **                               Z80           <TRACE STATE>

PROCESSOR : Z80
  
```

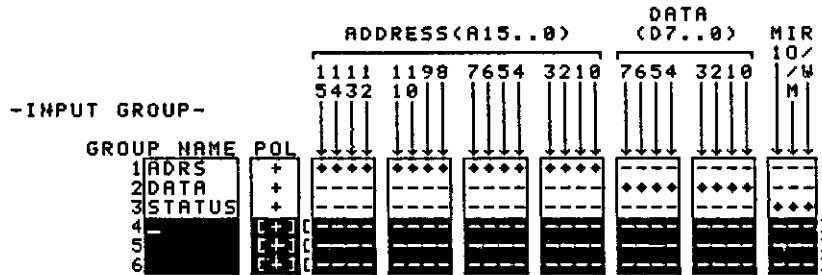

01-APR-86 16:19

Figure 2-9 Screen Display at the End of Loading (CONFIG menu screen)

When the screen as shown in Figure 2-10 is displayed, it indicates that the internal clock is not functioning properly. Set the precise time by referring to Section 8.1 of the main unit instruction manual.

```

** CONFIGURATION **                               Z80           <TRACE STATE>

PROCESSOR : Z80
  
```

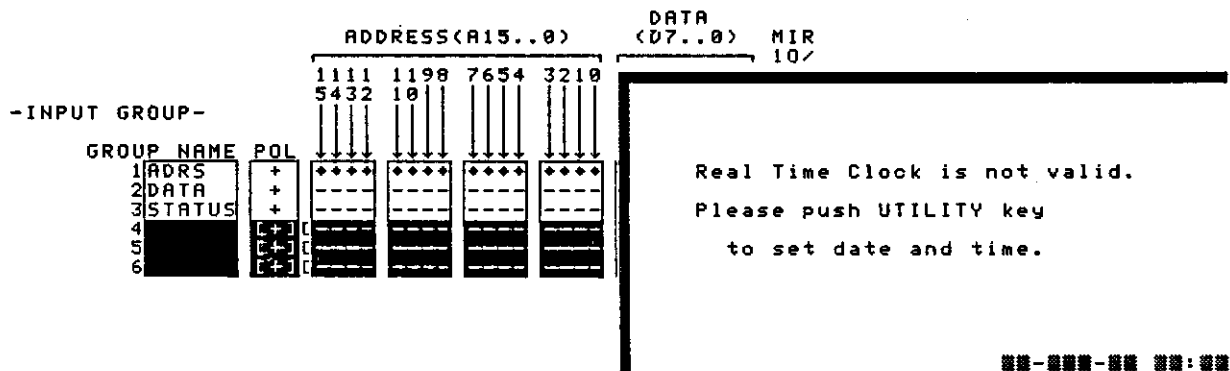

--*** **:

Figure 2-10 Screen Display Requesting Built-in Clock Setting

TR47241
PERSONALITY KIT
INSTRUCTION MANUAL

2.5 LOADING THE SYSTEM SOFTWARE

The display as shown in Figure 2-11 appears, requiring insertion of the system disk when the system disk is not inserted in the floppy disk drive when the POWER switch is turned ON. When the system disk is inserted, even when this display is shown, loading will start automatically. After the display of Figure 2-8, the display of either Figure 2-9 or Figure 2-10 appears and the system enters into operation-enabled state.

```
TR47241
```

Z80 PK

Please enter TR47241 Z80 PK System Software Package !



Self-test ended

054725 U2.1 Copyright 1985 ADVANTEST CORPORATION

Figure 2-11 Screen Display Requesting System Disk Insertion

TR47241
PERSONALITY KIT
INSTRUCTION MANUAL

2.6 CRT DISPLAY FORMATS AND MEANINGS

2.6 CRT DISPLAY FORMATS AND THEIR MEANINGS

One sample data file is stored in the system disk for the explanation from Sections 2.6 to 2.9. To better understand the operation, read the following descriptions while actually operating the personality kit.

Press ^{CONFIG} on the upper right of the front panel. Then, the menu display as shown in Figure 2-9 will appear (the same display as shown after the loading of the system software). The setting of the input channel configuration is enabled on the CONFIG menu screen.

Press ^{TRACE} and the display as shown in Figure 2-12 will appear. The setting of the trace condition is enabled on the TRACE menu screen.

```

** TRACE SPECIFICATION **                               280           <TRACE STATE>
[TRACE STATE]-----
[ STORE1 = [1024] states   DELAY = +0000
|
| GROUP      [ADRS] [DATA] [STATUS] [HEX] [HEX] [HEX]
| RADIX     [HEX] [HEX] [CODE] [HEX] [HEX] [HEX]
|
| ENBL1     [ ] [XXXX] [XX] [(<abs> X)]
| TRIG1     [ ] [XXXX] [XX] [(<abs> X)]
| [DR0]
| DSBL1     [XXXX] [XX] [(<abs> X)]
|
| TRIG PASS = 001           TRIG OUT(SYNC) [OFF]
|
| [STOP ]

```

01-APR-86 16:22

Figure 2-12 TRACE Menu Screen (TRACE SPECIFICATION)

TR47241
PERSONALITY KIT
INSTRUCTION MANUAL

2.6 CRT DISPLAY FORMATS AND MEANINGS

Press and the display as shown in Figure 2-13 will appear. Analysis of the captured data is enabled on the DISPLAY menu screen.

```

** DISPLAY **                               280                               <TRACE STATE>
GROUP [ADRS ] [DATA ] [STATUS] [HEX ] [HEX ] [HEX ] [HEX ] [HEX ]
RADIX [HEX ] [HEX ] [HEX ] [HEX ] [HEX ] [HEX ] [HEX ] [HEX ]
[LN] +-----+-----+-----+-----+-----+-----+-----+-----+

```

01-APR-86 16:23

Figure 2-13 DISPLAY Menu Screen

Basic measurement is executed in the State Only and S & T analyzers by interacting with the above three menu screens (configuration, trace specification, and display) and the menu screen by SYMDEF key (symbol definition).

Press on the lower center of the front panel twice. The file is read out and the data is displayed on the screen (refer to Figure 2-14).

```

** DISPLAY **   from F0:DISP.REG           280           <TRACE STATE>
GROUP [ADRS ] [DATA ] [STATUS] [HEX ] [HEX ] [HEX ] [HEX ] [HEX ]
RADIX [HEX ] [HEX ] [HEX ] [HEX ] [HEX ] [HEX ] [HEX ] [HEX ]
[LN] +-----+-----+-----+-----+-----+-----+-----+-----+
0000  0000      F3      5
0001  0001      31      5
0002  0002      00      1
0003  0003      11      1
0004  0004      FB      5
0005  0005      C3      5
0006  0006      40      1
0007  0007      00      1
0008  0040      D7      7
0009  10FF      00      0
0010  10FE      40      0
0011  0010      3E      5
0012  0011      10      1
0013  0012      FB      5
0014  0013      C9      5
0015  10FE      40      1
0016  10FF      00      1

F0:DISP.REG, gotten                               ↑scroll   01-APR-86 16:24

```

Figure 2-14 Sample Data for Explanation

TR47241
PERSONALITY KIT
INSTRUCTION MANUAL

2.6 CRT DISPLAY FORMATS AND MEANINGS

Each CRT display format contains a specific definition. The operation has been made easier by sustaining definition consistency through the whole displays.

- (1) "Normal display": Usually displayed by characters or diagrams in green; used for displaying fixed information such as header word or measured data.

This indication is equivalent to headers such as DISPLAY on the upper left of the screen or measured data (list) in the above sample data.

- (2) "Inverse display": Indicates inversed luminance of the character or diagram. This is called "menu item". The user can use this to set or revise data. [HEX] is equivalent to this display in the above sample data.
- (3) "Normal blink display": Blinks to display "normal display"; used to display the status of the error message, measurement or I/O execution. By pressing any numeric key (for instance, 0) when the display as shown in Figure 2-14, the message called "normal blink display" is displayed on the bottom line of the CRT display.
- (4) "Inverse blink display": Blinks to display "Inverse display", indicates the "menu item" that can be currently entered. The blinking portion, in particular, is called "input prompt". The display format of [ADRS] immediately after GET is equivalent to this.
- (5) "Half-tone display": Indicates the half luminance which is used for measurement execution or I/O operation. The "input prompt" cannot be moved to the "menu item" which is turned to half-tone display (the setting of data to the menu item becomes disabled).

Press on the lower center of the front panel twice, and the display as shown in Figure 2-15 will appear. The menu display (e.g. main menu) other than the smaller menu display newly appearing on the CRT display (e.g. sub-menu) is called "half-tone display". Pay attention when referencing the display of figures since the "half-tone display" cannot be printed on the screen which is output by a video plotter (as shown in Figure 2-15).

TR47241
PERSONALITY KIT
INSTRUCTION MANUAL

2.6 CRT DISPLAY FORMATS AND MEANINGS

```

** DISPLAY **      from F0:DISP.REG                Z80      <TRACE STATE>
GROUP [ADRS] [DATA] [STATUS] [HEX] [HEX] [HEX] [HEX] [HEX]
RADIX [HEX] [HEX] [HEX] [HEX] [HEX] [HEX] [HEX] [HEX]
[LN]-----+-----+-----+-----+-----+-----+-----+-----
0000 0000 F3 5
0001 0001 31 5
0002 0002 00 1
0003 0003 11 1
0004 0004 FB 5
0005 0005 C3 5
0006 0006 40 1
0007 0007 00 1
0008 0040 D7 7
0009 10FF 00 0
0010 10FE 40 0
0011 0010 3E 5
0012 0011 10 1
0013 0012 FB 5
0014 0013 C9 5
0015 10FE 40 1
0016 10FF 00 1

```

```

** FD OPERATION **
OPERATION [DIRECTORY] of [MENU]
DRIVE     [F0:]
F0: __name---blks--attri--date-----
DISP.REG   42 DSP_5 01-FEB-86 13:32

```

01-APR-86 16:25

Figure 2-15 FD Menu Screen

TR47241
PERSONALITY KIT
INSTRUCTION MANUAL





2.7 INPUTTING DATA TO MENU ITEMS

2.7 INPUTTING DATA TO MENU ITEMS



The menu display corresponding to keys of MENU and I/O key groups can be displayed by pressing the key accordingly.



More than one menu items are presented on the menu display. The menu display corresponding to the MENU key group is called main menu display. The menu display corresponding to the I/O key group is called sub-menu display. The sub-menu display can be called or deleted at any time to the main menu display (when deleting, press any key of the MENU key group or

). The main menu display becomes half-tone display when the sub-menu display is called. Try to enter keys to actually understand their functions. The four basic rules for inputting data to the menu items are as follows:

- The menu item for data inputting is displayed inversely.
- The menu item (input prompt) for inputting data (currently permitted) by pressing the ENTRY key is displayed by inverse blink display.
- Input prompt can be moved by     or .
- The menu item enclosed in brackets can be selected by the SELECT key.

(1) The menu item enclosed in brackets:

For the menu item enclosed in brackets, data is input by pressing SELECT (, ) key to select from the chain data group.

The data group is selected in due order with  key; in inverse order with  key. Pay attention that the same menu item of the selectable data group can be different according to the ambient conditions. The

selection range of the data group can be referenced beforehand with  (refer to item (1) of Section 2.6). No syntax error will occur with the data input by SELECT key, thus this method is adopted by the TR4725 as much as possible. The normal display enclosed in brackets are also menu items. However, data input is not allowed because of only one menu item selection. This inputting method is adopted for most of menu items is DISPLAY menu screen. Try to observe how the display can be changed for

the data group in the GROUP or RADIX menu item by pressing .

TR47241
PERSONALITY KIT
INSTRUCTION MANUAL



2.7 INPUTTING DATA TO MENU ITEMS

(2) The menu items not enclosed in brackets:

For menu items that are not enclosed in brackets, data can be input by pressing any ENTRY keys other than the SELECT key. These menu items are designed for defining GROUP, SYMBOL, and CODE names (these are for the state analysis section only) or calling/storing file name and require numeric values of binary, octal, decimal, and hexadecimal. The initial character (or digit) of each menu item becomes the input prompt when the

input prompt item is moved by     . Next, the system is set

to NIBBLE mode by entering either  or input data of one character

(or one digit). When  or  is pressed, input prompt can shift one character (or one digit) at a time (LED of NIBBLE key is lit), NIBBLE mode is released and the input prompt is moved to the next menu item (menu item of the right on the same line or the left end on the next line). For the menu item such as the one selected by GET/SAVE key (requesting file name) which can only enter one character at a time, NIBBLE mode is automatically set and the LED of the key is lit.

No explanation of the menu display of SYMDEF (not used for timing only analyzer) or PROGRAM key that execute a line of the menu items is given in this section.

TR47241
PERSONALITY KIT
INSTRUCTION MANUAL

2.8 USE OF HELP KEY

2.8 USE OF HELP KEY

assists the user by providing useful information for operating this personality kit. It has two functions: HELP (menu item) and HELP (key).

HELP (menu item) displays the data input related information (an active-type of information which changes with the measuring conditions) to each menu item. For the menu item which uses the SELECT key, the selectable data group when / is pressed is displayed.

HELP (key) displays the key-related information (a static-type of information which does not change with the measuring conditions) which includes basically the key function summary, the summary of the related key functions, and the index to the instruction manual. The operating method for each function differs.

(1) HELP (menu item) function

This function is available whenever the data input to the menu item is possible (system disk is not necessarily required). When is pressed and then released, the HELP screen is displayed on the lower right or lower left of the CRT display avoiding the input prompt menu items. The examples are shown in Figures 2-16 and 2-17. The HELP screen can be deleted by pressing any key including the scroll knob. However, whichever key is pressed, its function remains valid (for instance: when the ENTRY key is pressed, data input is executed. Turning the scroll knob can delete HELP screen without affecting the main menu screen). Test the HELP function in DISPLAY menu screen.

TR47241
PERSONALITY KIT
INSTRUCTION MANUAL

2.8 USE OF HELP KEY

```

** DISPLAY **      from F0:DISP.REG      280      <TRACE STATE>
GROUP [ADRS ] [DATA ] [STATUS] [HEX ] [HEX ] [HEX ] [HEX ] [HEX ]
RADIX [HEX ] [HEX ] [HEX ] [HEX ] [HEX ] [HEX ] [HEX ] [HEX ]
-----
[CLN] +-----+-----+-----+-----+-----+-----+-----+-----+
0000  0000      F3      5
0001  0001      31      5
0002  0002      00      1
0003  0003      11      1
0004  0004      FB      5
0005  0005      C3      5
0006  0006      40      1
0007  0007      00      1
0008  0040      D7      7
0009  10FF      00      0
0010  10FE      40      0
0011  0010      3E      5
0012  0011      10      1
0013  0012      FB      5
0014  0013      C9      5
0015  10FE      40      1
0016  10FF      00      1

```

NEXT: +[DATA]+[STATUS]→
PREV: +[]+[STATUS]→

↑scroll 01-APR-86 16:26

Figure 2-16 HELP (menu item) Function Display Example (1)

```

** TRACE SPECIFICATION **      280      <TRACE S&T(S+T)>
[TRACE S&T(S+T)]-----[TRIG!] disarms TRIG_T-----QuickVIEW [OFF]
[ STORE1 = [1024].states DELAY = +0000
1
GROUP [ADRS ] [DATA ] [STATUS] [HEX ] [ADRS ] [HEX ]
RADIX [HEX ] [HEX ] [CODE ] [HEX ] [HEX ] [HEX ]
ENBL1 [ ] [XXXX] [XX] [[(abs) X] [XXXX]
TRIG1 [ ] [XXXX] [XX] [[(abs) X] [XXXX]
[OR0]
DSBL1 [ ] [XXXX] [XX] [[(abs) X] [XXXX]
L TRIG PASS = 001 TRIG OUT(SYNC) [OFF]

```

NEXT: +[DATA]+[STATUS]→
PREV: +[]+[STATUS]→

CLOCK RATE [10ns]
↑scroll 01-APR-86 16:28

Figure 2-17 HELP (menu item) Function Display Example (2)

TR47241
PERSONALITY KIT
INSTRUCTION MANUAL

2.8 USE OF HELP KEY

(2) HELP (key) function

This function is available only when the system disk is installed in the floppy disk drive and the system is under the key entry enabled state. The HELP screen is displayed on the right or the left side of the CRT

avoiding the menu item of the input prompt when HELP is pressed along with other desired function key. The display examples are shown in Figures 2-18 and 2-19.

```

** DISPLAY **      from F0:DISP.REG              Z80      <TRACE S&T(S+T)>
GROUP [ADRS ] [DATA ] [STATUS] [HEX ] [HEX ] [HEX ] [HEX ] [HEX ]
RADIX [HEX ] [HEX ] [HEX ] [HEX ] [HEX ] [HEX ] [HEX ] [HEX ]
[LN]-----+-----+-----+-----+-----+-----+-----+-----+
0000  0000    F3     5
0001  0001    31     5
0002  0002    00     1
0003  0003    11     1
0004  0004    FB     5
0005  0005    C3     5
0006  0006    40     1
0007  0007    00     1
0008  0040    D7     7
0009  10FF    00     0
0010  10FE    40     0
0011  0010    3E     5
0012  0011    10     1
0013  0012    FB     5
0014  0013    C9     5
0015  10FE    40     1
0016  10FF    00     1

```

```

** HELP ** UTILITY
VERSION UP NEWS AVAILABLE IN NEXT PAGES

HELP information
not available until V2.0

↑scroll  01-APR-86 16:30

```

Figure 2-18 HELP (key) Function Display Example (1)

```

** TRACE SPECIFICATION **              Z80      <TRACE S&T(S+T)>
[TRACE S&T(S+T)]-----[TRIG1] disarms TRIG_T-----QuickVIEW [OFF]
[ STORE1 = [1024] states DELAY = +0000
  |
  | GROUP [ADRS ] [DATA ] [STATUS] [HEX ] [ADRS ] [HEX ]
  | RADIX [HEX ] [HEX ] [CODE ] [HEX ] [HEX ]

```

```

** HELP ** DISPLAY
1)
2)
3) [OFF]

HELP information
not available until V2.0

CLOCK RATE [ 10ns]

01-APR-86 16:31

```

Figure 2-19 HELP (key) Function Display Example (2)

TR47241
PERSONALITY KIT
INSTRUCTION MANUAL

2.8 USE OF HELP KEY

When the scroll mark is displayed on the bottom line of the CRT, it indicates that the further data exist. The latest data can be displayed

by turning the scroll knob or pressing PAGE keys.

Pressing any key, other than the scroll knob, can delete the HELP (key) screen. However, the EDIT and ENTRY keys can only be used to delete the screen, and the original key function becomes invalid.

The information displayed by the HELP (key) function and the currently displayed menu screen are not directly relates. Data is read and displayed from the system disk onto the HELP (key) screen, so the system disk must be installed in the floppy disk drive. When the system disk is not installed and this function is attempted to activate, the message as shown in Figure 2-20 is displayed. Test this function.

```

** DISPLAY **      from F0:DISP.REG                Z80      <TRACE S&T(S+T)>
GROUP [ADRS ] [DATA ] [STATUS] [HEX ] [HEX ] [HEX ] [HEX ] [HEX ]
RADIX [HEX ] [HEX ] [HEX ] [HEX ] [HEX ] [HEX ] [HEX ] [HEX ]
[LN]  +-----+-----+-----+-----+-----+-----+-----+-----+
0000  0000    F3      5
0001  0001    31      5
0002  0002    00      1
0003  0003    11      1
0004  0004    FB      5
0005  0005    C3      5
0006  0006    40      1
0007  0007    00      1
0008  0040    07      7
0009  10FF    00      0
0010  10FE    40      0
0011  0010    3E      5
0012  0011    10      1
0013  0012    FB      5
0014  0013    C9      5
0015  10FE    40      1
0016  10FF    00      1

```

```

** HELP ** DISPLAY

Please enter TR47241 Z80 PK
      system software package!
Push HELP key again.

01-APR-86 16:32

```

Figure 2-20 Screen Requesting System Disk Insertion by the HELP (key) Function

Screens are configured from combination of main menu, sub-menu, HELP (menu item), and HELP (key) screens and the attached screen other than the main

menu screen can be deleted completely by pressing STOP .

TR47241
PERSONALITY KIT
INSTRUCTION MANUAL

2.9 USER DISK PREPARATION

2.9 USER DISK PREPARATION

The explanations of the previous sections are for actually operating the Personality Kit by its system disk, while this section deals with storing the measuring conditions, measured data, and programs on the user disk. The user disk is prepared by using the operation examples in Chapter 3. Disk formatting is required for preparing a user disk from a blank one. Remove the used system disk from the floppy disk drive and replace it with a blank disk.

Press and then four times, and the screen as shown in Figure 2-21 will appear.

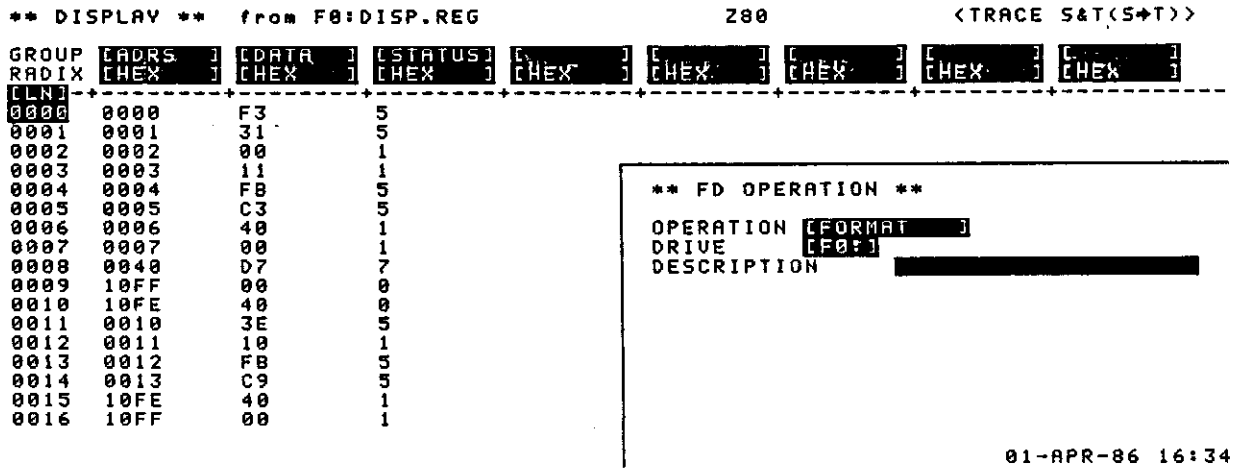

Figure 2-21 Disk Format

Next, press twice to move the input prompt to the menu item "DESCRIPTION" and input characters of less than 20 character long (For instance: "MY DISK"). Then, press . The screen will ask "FORMAT?". Press the green key on the bottom right corner of the front panel and then to start formatting. When the screen as shown in Figure 2-22 appears, it indicates the end of formatting. (The green key is the shift key, and "Y" is entered by the operations described above.)

TR47241
PERSONALITY KIT
INSTRUCTION MANUAL

2.9 USER DISK PREPARATION

```

** DISPLAY **      from F0:DISP.REG                Z80      <TRACE S&T(S+T)>
GROUP [ADRS ] [DATA ] [STATUS] [HEX ] [HEX ] [HEX ] [HEX ] [HEX ]
RADIX [HEX ] [HEX ] [HEX ] [HEX ] [HEX ] [HEX ] [HEX ] [HEX ]
[LN]-----+-----+-----+-----+-----+-----+-----+-----+
0000  0000    F3      5
0001  0001    31      5
0002  0002    00      1
0003  0003    11      1
0004  0004    FB      5
0005  0005    C3      5
0006  0006    40      1
0007  0007    00      1
0008  0040    D7      7
0009  10FF    00      0
0010  10FE    40      0
0011  0010    3E      5
0012  0011    10      1
0013  0012    FB      5
0014  0013    C9      5
0015  10FE    40      1
0016  10FF    00      1

```

```

** FD OPERATION **
OPERATION [FORMAT ]
DRIVE     [F0:]
DESCRIPTION
F0:-----
DISK ID : TR47241 USER DISK
DESCRIPTION : MY DISK
AVAILABLE AREA : 2530 blocks
USED AREA      :    2 blocks*
BAD AREA       :    0 block
01-APR-86 16:35

```

Figure 2-22 Display at the End of Disk Formatting

Press and then press twice, and the data that is currently displayed on the screen is written into the disk. When is pressed twice consecutively, the file names stored in the user disk is read. The file that was written just now should bear the file name DISP.S1 (the name is automatically named by the TR4725). Perform the following procedures to call the file. Press and turn the scroll knob clockwise, and the file bearing the DISP.S1 will appear in the file name menu item. Next, again press and the file read from the user disk is displayed on the CRT. The fact that the displayed data belongs to the file named DISP.S1 is displayed on the first line of the CRT.

To delete the file press and then press twice, and the command "PURGE" will appear. Move the input prompt to the menu item "NUMBER OF DELETED FILE" and set the numeric data of "01" with the SELECT key. Then press to start the execution of PURGE to delete the file. Any blank disk which is 3.5 inches, 80 tracks and dual-sided double density is applicable, no matter what brand. (For instance: the OM-D4440 model of SONY, or the ADVANTEST A09502 model with a set of ten disks).

MEMO



A large, empty rectangular area with rounded corners, enclosed by a dashed border, intended for writing the memo content.

TR47241
PERSONALITY KIT
INSTRUCTION MANUAL

3.1 INTRODUCTION

3. OPERATION EXAMPLES

3.1 INTRODUCTION

This chapter is to help beginners when learning how to operate the Personality Kit to gain a better understanding of the probe by providing some measuring examples.

The detailed operating procedures are described in the main unit instruction manual from Chapters 4 to 6, and Chapter 4 of the PK instruction manual. It is not necessary to read through all these manuals from the beginning. However, it is recommended to reference the important portions of them after learning the use of the probe from the following examples.

The operating procedures of the TR4725 are based on the operating rule of consistency, and thus can be operated by analogy. The following examples contain, along with the contents of Chapters 4 to 6 of the main unit instruction manual, the contents of the relations of the individual functions described in the PK instruction manual Chapter 4. Again, emphasis is on actual operation while reading the examples.

TR47241
PERSONALITY KIT
INSTRUCTION MANUAL

3.2 SIMPLE EXAMPLES OF TIMING ANALYSIS

3.2 SIMPLE EXAMPLES OF TIMING ANALYSIS

Connect probe E/F to the main unit (refer to Section 2.3.2) and load the system software (refer to Section 2.5).

The screen should display **** CONFIGURATION ****. Then, press to set the measuring mode to TRACE TIMING. Next, apply the suitable signal (TTL level is recommended) to the channel No. 7 of the probe F. Signal is displayed on the channel (label name: PRB_F7) on the upper most position as shown in Figure 3-1. The sampling clock at this moment is 10 ns (100 MHz).

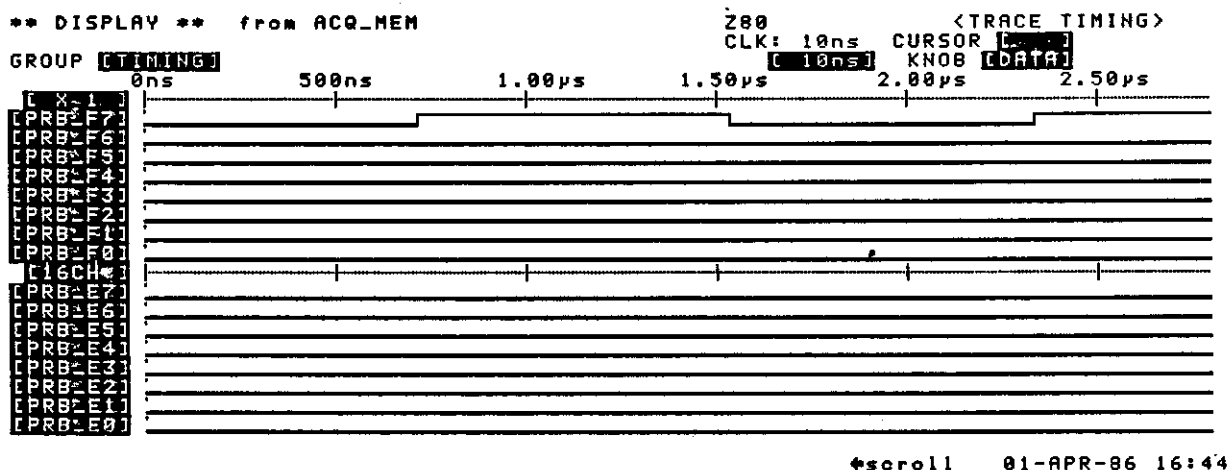

Figure 3-1 Timing Analysis Measurement Example (sampling clock: 10 ns)

Input signal changes will appear on the screen display. The sampling clock is changed by pressing after the input prompt is moved to the menu item of the sampling clock by pressing (try to set the sampling timing to 100 ns by pressing three times).

Next, press and the data will be displayed (as shown in Figure 3-2) in ten times the detail than what is shown in Figure 3-1.

TR47241
PERSONALITY KIT
INSTRUCTION MANUAL

3.2 SIMPLE EXAMPLES OF TIMING ANALYSIS

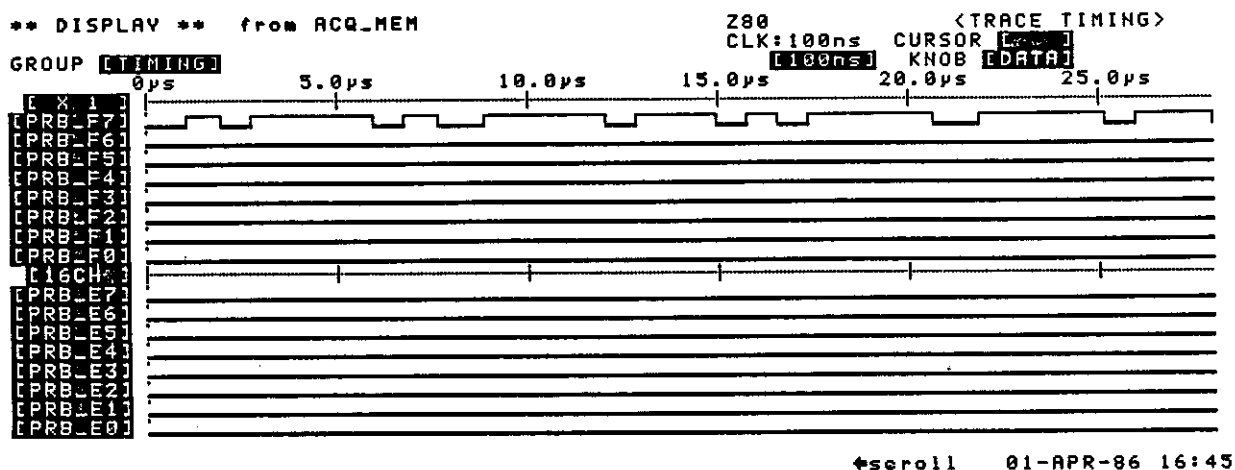

Figure 3-2 Timing Analysis Measurement Example (sampling clock: 100 ns)

What portion of the input signal starts to display is unpredictable no matter how many times is pressed.

Turn the scroll knob clockwise to move the data on the screen to the left; and vice versa. Turn the scroll knob fast and the data moves fast; slow

turning will also slow down the data changes. Next, press to move the input prompt to the menu item of [x 1] (time axis multiplier). The

time axis multiplier can be changed by pressing either or . x n expands the time axis; x 1/n contracts the time axis. All of the data contained in the memory (16 ch. x 2048 samples) attained at x 1/10 ratio is specified.

Next, press to move the input prompt to the menu item of [PRB_F7]. Enter "DATA" by using the character key of the ENTRY key group (refer to Figure 3-3).

Pay attention to the use of the shift key (the green key). When is pressed following the previous procedures, the label name [PRB_F7] is changed and displayed as [DATA] as shown in Figure. This function ensures that the data analysis can be performed with great ease.

TR47241
PERSONALITY KIT
INSTRUCTION MANUAL

3.2 SIMPLE EXAMPLES OF TIMING ANALYSIS

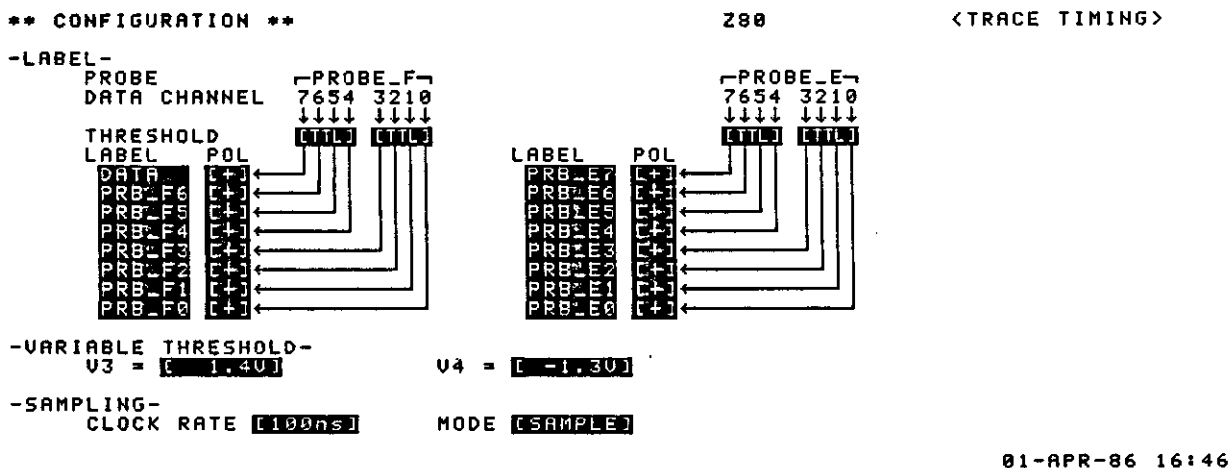

Figure 3-3 Label Name Definition Example

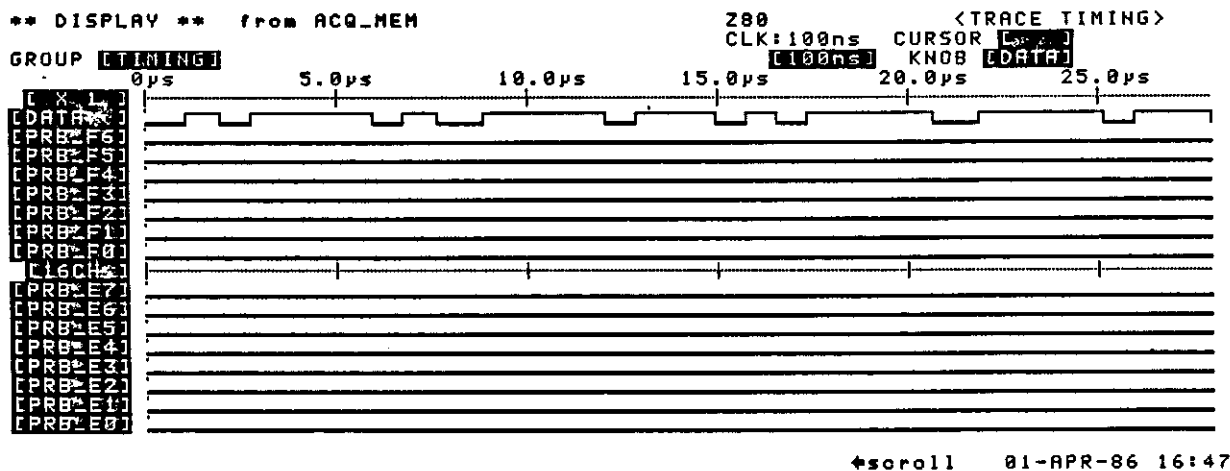







Figure 3-4 Label Name Usage Example

It is important to familiarize oneself with the operations and results on the DISPLAY screen by trying out all function keys related to the screen.

All of the operations on the DISPLAY screen are controlled by   
,  and . Refer to the related portion of the main unit instruction manual, Section 4.7.1 for the display formats and their meanings and the meaning of the menu item, Section 4.7.2 for the data scroll, Section 4.7.3 for cursor operation (two cursors of A and B can be used together), Section 4.7.4 for the time axis multiply and contraction, and Section 4.7.5 for the relations between the displayed data and the acquisition memory.

TR47241
PERSONALITY KIT
INSTRUCTION MANUAL

3.2 SIMPLE EXAMPLES OF TIMING ANALYSIS

Refer to Section 4.2.3 for the screen that will appear next when ^{CONF} is pressed. Then, press ^{TRACE} and to move the input prompt to TRIG_T. Next, press to set "1" to the equivalent position of "DATA" as shown in Figure 3-5. When is pressed, the screen as shown in Figure 3-6 will appear. After this, no matter how many times is pressed, the initial display remains at H level. This means that action is triggered (the trigger point indicates the initial data). (On the time axis, 0 ns is displayed).

Press ^{TRACE} again, and then press after setting 0 to "ENBL_T" and -0001 to "DELAY" as shown in Figure 3-7. At this point, the trigger point becomes clearer than before.

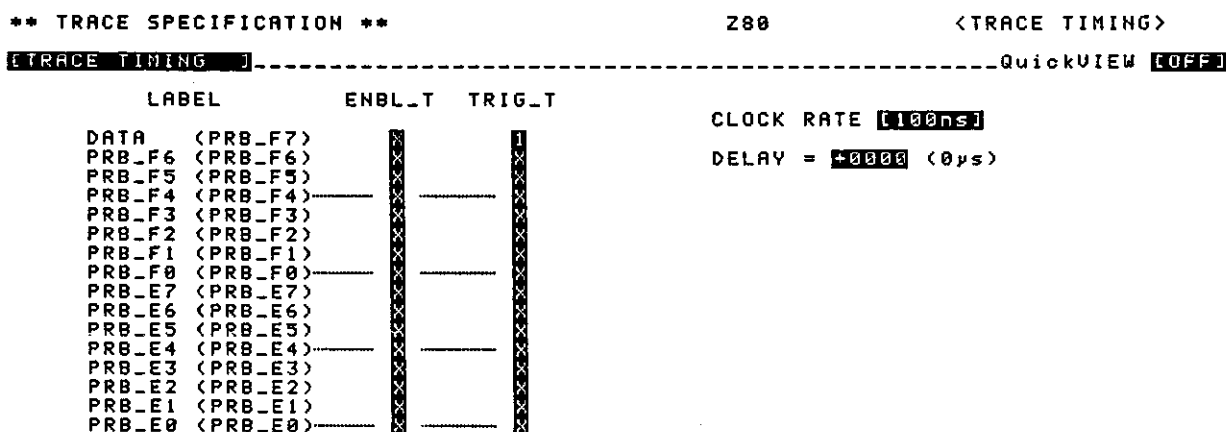

01-APR-86 16:48

Figure 3-5 Trigger Pattern (TRIG_T) Setting Example

TR47241
PERSONALITY KIT
INSTRUCTION MANUAL

3.2 SIMPLE EXAMPLES OF TIMING ANALYSIS

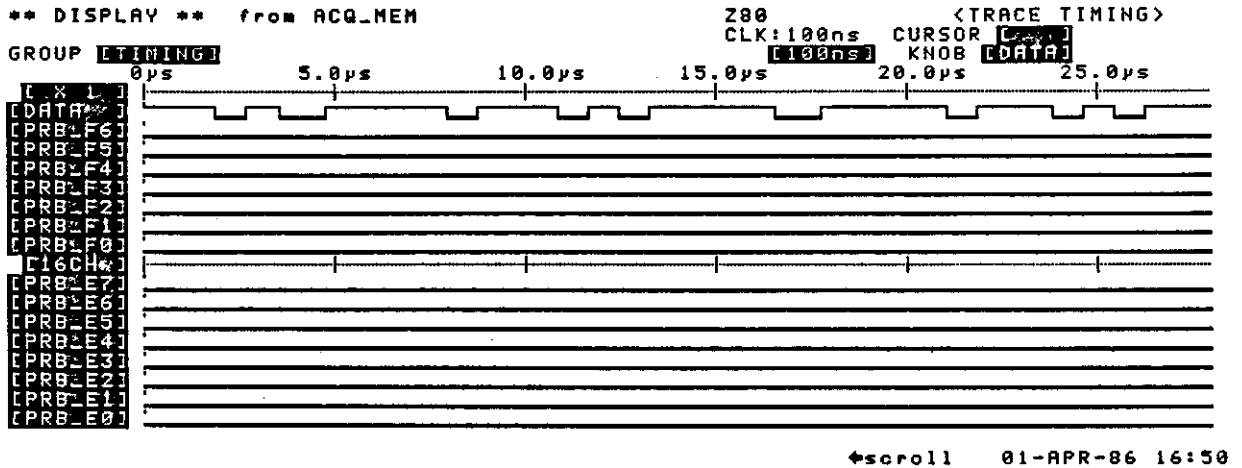

Figure 3-6 Measuring Example with Trigger Pattern Setting

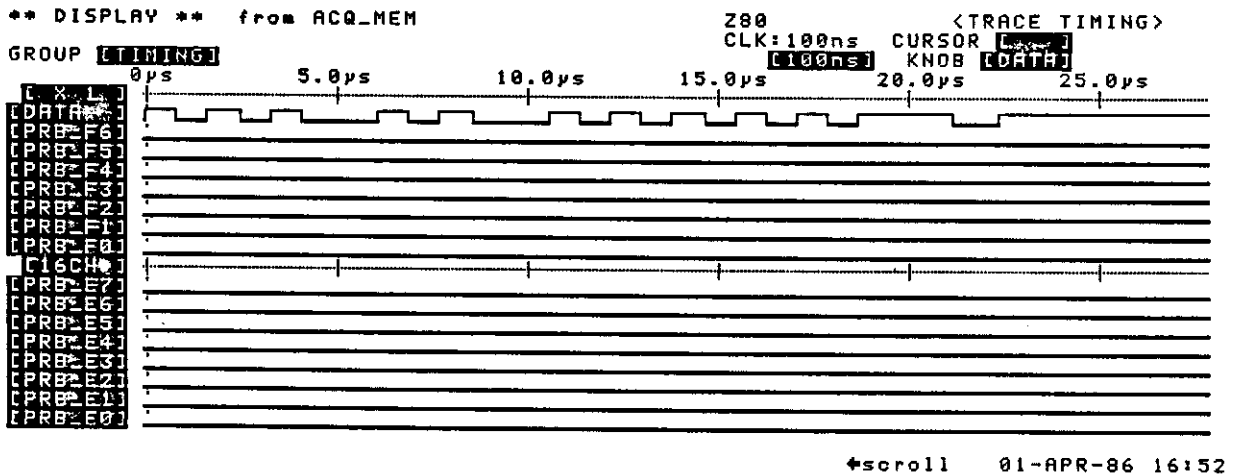

Figure 3-7 Delay Usage Example

Refer to Section 4.4.3 for the screen which appears when is pressed. When the above procedures are executed, the basic operation of the timing analysis outline can be grasped.

TR47241
PERSONALITY KIT
INSTRUCTION MANUAL

3.3 SIMPLE EXAMPLES OF STATE ANALYSIS

3.3 SIMPLE EXAMPLES OF STATE ANALYSIS

Connect the microprocessor probe to the main unit (refer to Section 2.3.1) and load the system software (refer to Section 2.5). Choose the desired processor when ** CONFIGURATION ** is displayed on the CRT. Next, press

(immediately after POWER ON, the measuring mode turns into the TRACE STATE).

Then press and the measured data as shown in Figure 3-8 appears (the data differs according to the system measured).

```

** DISPLAY **      from ACQ_MEM                Z80                <TRACE STATE>
GROUP [ADRS ] [DATA ] [STATUS ] [HEX ] [HEX ] [HEX ] [HEX ] [HEX ]
RADIX [HEX ] [HEX ] [HEX ] [HEX ] [HEX ] [HEX ] [HEX ] [HEX ]
[LN] +-----+-----+-----+-----+-----+-----+-----+-----+
0000  0000    F3      5
0001  0001    31      5
0002  0002    00      1
0003  0003    11      1
0004  0004    F8      5
0005  0005    C3      5
0006  0006    40      1
0007  0007    00      1
0008  0040    D7      7
0009  10FF    00      0
0010  10FE    40      0
0011  0010    3E      5
0012  0011    10      1
0013  0012    FB      5
0014  0013    C9      5
0015  10FE    40      1
0016  10FF    00      1
    
```

↑scroll 01-APR-86 16:58

Figure 3-8 State Analysis Measuring Example

The input prompt is moved to the menu item of [ADRS] on the first line on the left. Check if the contents of GROUP is changed when is pressed. ([ADRS] → [DATA] → [STATUS] → [] → [ADRS])

Then, press to move the input prompt to the menu item [HEX] and check if the contents of RADIX is changed by pressing . Next, press to move the input prompt to the RADIX selection menu item of [DATA] (currently in [HEX]). [DATA] is displayed in Z80 mnemonic and

[MNEM] with [S-by-S] is displayed on the when is pressed. Then press to display the program.

Then, try to turn the scroll knob. Turn the scroll knob clockwise to scroll the data upwards, and turn the knob counterclockwise to scroll the

data downwards. Next, press the PAGE keys. What the scroll knob can move by a line can be moved by these keys ten lines, vertically.

TR47241
PERSONALITY KIT
INSTRUCTION MANUAL

3.3 SIMPLE EXAMPLES OF STATE ANALYSIS

Familiarize yourself with these operations and their effects on the DISPLAY screen by trying out all the key functions. Refer to Section 4.6.2 of the main unit instruction manual for the display formats and their meanings and the meaning of the menu items, and Section 4.6.3 for the use of the reference memory.

Next, press ^{TRACE} and press five times to move the input prompt to the menu item [ADRS] which is one element of TRIG1.

Input here the pattern of one data in [ADRS] as shown in Figure 3-8.

Then, press and the data with the pattern (called trigger) is moved to the upper most line of the measured data (refer to Figure 3-9). The same pattern remains unchanged on the upper most line no matter how many

times is pressed. Refer to Section 4.4.2 of the main unit

instruction manual for the screen which appears when ^{TRACE} is pressed.

```

** DISPLAY **   from ACQ_MEM                               Z80           <TRACE STATE>
GROUP [ADRS ] [DATA ]
RADIX [HEX ] [MNM ] with [S-BY-S] [STATUS] [HEX ] [HEX ] [HEX ] [HEX ]
-----+-----+-----+-----+-----+-----+-----+-----+-----+-----+
[LN] 0000 0040  NOP                               5
0001 0041  LD   BC,1000                             5
0002 0042  ..                                       1
0003 0043  ..                                       1
0004 0044  LD   (BC),A                               5
0005 1000  08/mem_wr                                0
0006 0045  INC  BC                                 5
0007 0046  INC  B                                  5
0008 0047  DEC  B                                  5
0009 0048  LD   B,12                               5
0010 0049  ..                                       1
0011 004A  RLCA ..                                 5
0012 004B  ADD  HL,BC                               5
0013 004C  LD   A,(BC)                             5
0014 1231  19/mem_rd                                1
0015 004D  DEC  BC                                 5
0016 004E  INC  C                                  5

```

↑scroll 01-APR-86 16:59

Figure 3-9 Measuring Example by Trigger Pattern Setting (State Analysis)

The measured data can be displayed not just by numeric values but also names. (For instance: the function name used for program creation). Therefore, it is necessary to define names (SYMBOL and CODE names). The

display which appears by pressing ^{SYM DEF} is used for definition. For details, refer to Sections 4.3.2 and 4.3.3 of the main unit instruction manual.

When all of the above operations are executed, the outline of the basic operation of the state analysis can be understood.

TR47241
PERSONALITY KIT
INSTRUCTION MANUAL

3.4 SIMPLE EXAMPLES OF S & T ANALYSIS

3.4 SIMPLE EXAMPLES OF S & T ANALYSIS

Connect the microprocessor probe and probe E/F to the main unit and execute loading of the system software.

Next, press ^{TRACE} to set the measuring mode to TRACE S&T (S → T) in which the state analysis and timing analysis sections operate simultaneously.

Execution starts when ^{RUN} is pressed. For the relations with the measured data, refer to Section 4.4.4 of the main unit instruction manual.

TR47241
PERSONALITY KIT
INSTRUCTION MANUAL

3.5 FLOPPY DISK APPLICATIONS

3.5 FLOPPY DISK APPLICATIONS

When the main unit POWER switch is turned OFF, all of the measured data and data set in the menu item displayed on the screen described respectively in Sections 3.2 to 3.4 are deleted. For re-use of these data, it is very convenient to store them on the floppy disk. The operations of the disk file of the TR4725 differ from those of the general-purpose type computers such as personal computers, and are rather simple.

Refer to Section 4.2.4 of the main unit instruction manual for file processing on the screen with ^{CONF}, Section 4.3.4 for file processing on the screen with ^{STM DEF}, Section 4.4.5 for file processing on the screen with ^{TRACE}, and Sections 4.6.4 and 4.7.5 for file processing on the screen with ^{Display}.

TR47241
PERSONALITY KIT
INSTRUCTION MANUAL

3.6 USE OF QuickVIEW

3.6 USE OF QuickVIEW

The TR4725 has a new facility called QuickVIEW provided with the functions and ease of use of the oscilloscope for timing analysis.

The oscilloscope observes and measures the transitional condition of signals to be measured by setting the condition for attaining the desired screen and data by repeatedly operating the knobs of the trigger level or the key switches of time axis or input gain.

Though not exactly the same as the oscilloscope since the nature of the signals handled are different, QuickVIEW uses the scroll knob and provides the same ease of operation as the oscilloscope.

The operation procedures are simple. Press ^{TRACE} to move the input prompt to the menu item of QuickVIEW and set [ON] with ^{MM}. Next, press ^{RM} to enter into QuickVIEW mode. The sampling clock is changed by simply turning the scroll knob and then the real time data can be observed.

Refer to Section 4.8 of the main unit instruction manual for details of the QuickVIEW facility.



TR47241
PERSONALITY KIT
INSTRUCTION MANUAL



3.7 EXAMPLES OF USING THE PROGRAMS

3.7 EXAMPLES OF USING THE PROGRAMS



After the operations described in the previous sections are learned, it is easy to create the program of measurement procedures by simple programming.

Programming starts immediately when  is pressed.

Programs can be created by simply pressing , , or . The

command that can be selected by  or  has been made as similar as possible to the key operation. For instance, [TRACE] function is

equivalent to pressing . The created program is immediately

executable when  is consecutively pressed twice. Pressing 

interrupts execution. For the operating procedures of the editor, refer to Section 6.2.1 of the main unit instruction Manual, and Section 6.2.2 for the type of commands that can be selected and their functions.

The created program is stored as a file (named as command file) and can be applied. For the application method, refer to Section 6.4 of the main unit instruction manual. Refer to Section 6.3 for the execution procedures of the command file.

The followings are explanations of some program examples. Try to create the same program for practice.

Figure 3-10 shows the program which executes the measurement by repetition (repeat function). The repeat function is a fixed function of conventional models of the logic analyzer. With the TR4725, all kinds of varieties can be developed. Figure 3-11 shows one example. The program as shown can display the acquired data within at five seconds most.

Run command is not necessarily required in the program. Figure 3-12 shows the program that only sets measuring conditions, which is convenient for setting measuring conditions to be used as a routine. Figure 3-13 shows the program that saves all kinds of measuring results in the system saved file after three measurements, by changing only the TRACE data. Figure 3-14 shows the program that repeats the measurement ten times under the same measuring conditions.

TR47241
PERSONALITY KIT
INSTRUCTION MANUAL

3.7 EXAMPLES OF USING THE PROGRAMS

```
** PROGRAM **                                Z80          <TRACE STATE>
LN___COMMAND-----COMMENT-----
00 [RUN]
01 [GOTO] LN[00]                               ; ██████████
02  END
```

01-APR-86 17:01

Figure 3-10 Repeat Function Program 1

```
** PROGRAM **                                Z80          <TRACE STATE>
LN___COMMAND-----COMMENT-----
00 [RUN]
01 [WAIT] 005 sec                               ; ██████████
02 [GOTO] LN[00]
03  END
```

01-APR-86 17:02

Figure 3-11 Repeat Function Program 2

TR47241
PERSONALITY KIT
INSTRUCTION MANUAL

3.7 EXAMPLES OF USING THE PROGRAM

```
** PROGRAM **                                Z80          <TRACE STATE>
LN  _  COMMAND  -----  COMMENT  -----
00  [CONFIG]
01  [GET] [F0:] TEST1.CNF  GET
02  [TRACE]
03  [GET] [F0:] TEST1.TRC  GET
04  [SYNDEF]
05  [GET] [F0:] TEST1.SYM  GET
06  END
```

01-APR-86 17:04

Figure 3-12 Program That Only Sets Measuring Conditions

```
** PROGRAM **                                Z80          <TRACE STATE>
LN  _  COMMAND  -----  COMMENT  -----
00  [CONFIG]
01  [GET] [F0:] TEST1.CNF  GET
02  [TRACE]
03  [GET] [F0:] TEST1.TRC  GET
04  [RUN]
05  [SAVE] [QUICK] [F0:] SAVE
06  [TRACE]
07  [GET] [F0:] TEST2.TRC  GET
08  [RUN]
09  [SAVE] [QUICK] [F0:] SAVE
10  [TRACE]
11  [GET] [F0:] TEST3.TRC  GET
12  [RUN]
13  [SAVE] [QUICK] [F0:] SAVE
14  END
```

01-APR-86 17:07

Figure 3-13 Program Example -1

TR47241
PERSONALITY KIT
INSTRUCTION MANUAL

3.7 EXAMPLES OF USING THE PROGRAM

```
** PROGRAM **                                Z80          <TRACE STATE>
LN  COMMAND-----COMMENT-----
00 [DEFINE] [I=] 00
01 [CONFIG]
02 [GET] [F0:] TEST1.CNF GET
03 [TRACE]
04 [GET] [F0:] TEST1.TRC GET
05 [RUN]
06 [SAVE] [QUICK] [F0:] SAVE
07 [COUNT+1] [I]
08 [IF] [I+] 10 THEN GOTO LN[05]
09 END
```

01-APR-86 17:10

Figure 3-14 Program Example -2

MEMO



A large, empty rectangular area with rounded corners, enclosed by a dashed border, intended for writing the memo's content.

TR47241
PERSONALITY KIT
INSTRUCTION MANUAL

4.1 INTRODUCTION

4. PERSONALITY KIT PERFORMANCE CHARACTERISTICS

4.1 INTRODUCTION

The basic measurement operations are described in Chapter 4 of the main unit instruction manual. This chapter focuses on the performance characteristics of the Personality Kit. Refer to the related sections of the main unit instruction manual when reading this chapter. (For convenient reference, the section titles are identical.)

TR47241
PERSONALITY KIT
INSTRUCTION MANUAL

4.2 INPUT CHANNEL CONFIGURATION (CONFIG)

4.2 INPUT CHANNEL CONFIGURATION (CONFIG)

4.2.1 CONFIG Menu Screen for Z80 Microprocessor

The CONFIG function determines how to configure the TR4725 input block on which the personality kit is installed. Section 2.3.1 describes the physical connection between the probe and SUT. This section describes the CONFIG function that determines how the analyzer performs level conversion of the electric signal input from the probes for sampling operation, and how it converts that signal into easy-to-handle logical data.

The CONFIG menu screen is divided into three types by measurement mode. (The measurement mode is set at the TRACE menu screen. For details, see Section 4.2.1 of the main unit instruction manual.

The timing analysis menu screen is independent of the personality kit. For how to handle the timing analyzer, refer to Section 4.2.3 of the main unit instruction manual.

The state analysis menu screen is presented in Figure 4-1. The codes marked with the arrow sign stand for the name of the signal pins in Z80.

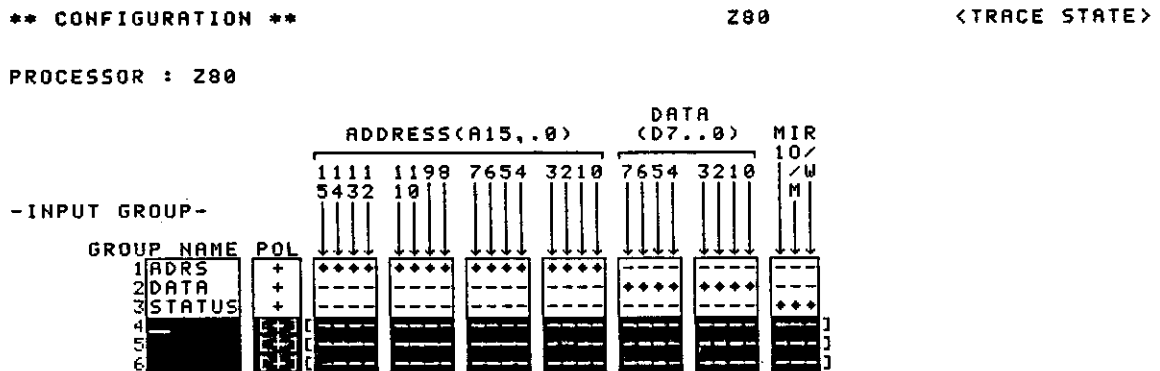

01-APR-86 17:11

Figure 4-1 CONFIG Menu Screen

TR47241
PERSONALITY KIT
INSTRUCTION MANUAL

4.2 INPUT CHANNEL CONFIGURATION (CONFIG)

The following item can be set at this menu screen:

- PROCESSOR: Indicates that this personality kit corresponds to the Z80 microprocessor. (fixed)

- POL : Specifies the polarization for signal capturing with + (positive) or - (negative).

- GROUP : Defines the unit in which several input channels are handled, as the input GROUP (termed GROUP hereafter). To define GROUP, specify the GROUP name having a maximum of six alphanumeric characters. Next, specify the input channel which belongs to the GROUP by entering the ◆ mark. Up to six GROUPS can generally be defined. However, three of them, [ADRS], [DATA] and [STATUS] have already been defined in the personality kit, and therefore, the user cannot change the names of those groups. The remaining three groups can be defined by the user. The input channel which has already been used may also be overlapped. The number (called a GROUP number, for instance, 1 for the GROUP number of GROUP [ADRS]) in the left side of the GROUP name is used to specify the GROUP name to be compared during program execution of the command [DEFINE] or [COMPARE_RANGE]. (See Section 4.1.2 in the main unit instruction manual.)

The PROCESSOR name is always displayed in the center of the 1st line on the other menu screens. The defined GROUP may be used in the TRACE and DISPLAY menu screens.

TR47241
PERSONALITY KIT
INSTRUCTION MANUAL

4.3 SYMBOL AND CODE DEFINITIONS (SYMDEF)

4.3 SYMBOL AND CODE DEFINITIONS (SYMDEF)

This personality kit uses not only numeric values but also SYMBOL and CODE to set the trace condition (TRACE function) and to display and analyze the measured data (DISPLAY function). These are defined by the SYMDEF function.

SYMBOL is applicable to a GROUP having any number of channels. SYMBOL gives one SYMBOL name to numeric strings in a certain range. When used in accordance with the label or function name for program development, this SYMBOL improves the debugging efficiency.

CODE is applicable to a GROUP having 8 or fewer channels. It gives one CODE name to one numeric value, and therefore, the user can easily create the code tables.

For details of the SYMBOL and CODE definitions, see Section 4.3 in the main unit instruction manual.

4.3.1 CODE Table for Z80

This personality kit has already been defined in the CODE tables for the GROUP [STATUS] (see Figure 4-2).

```
** SYMBOL DEFINITION **                Z80                <TRACE STATE>
GROUP [STATUS] TYPE [CODE ]
RADIX [HEX* ]
LN  NAME      VALUE USE
-----
000 MEM_WR    0  [+]
001 MEM_RD    1  [+]
002 IO_WR     2  [+]
003 IO_RD     3  [+]
004 OP        5  [+]
005 INTA      7  [+]
pre-defined for Z80 microprocessor
unchangeable
```

01-APR-86 17:12

Figure 4-2 Defined CODE Table (Z80 status)

TR47241
PERSONALITY KIT
INSTRUCTION MANUAL

4.4 DISPLAY OF CAPTURED DATA IN STATE ANALYZER (DISPLAY)

4.4 DISPLAY OF CAPTURED DATA IN STATE ANALYZER (DISPLAY)

Figure 4-3 shows the measured data captured by the TR47241. For display format and menu screen setting, refer to Section 4.6.2 of the main unit instruction manual.

```

** DISPLAY **      from ACQ_MEM                      Z80          <TRACE STATE>
GROUP [ADRS.] [DATA.] [STATUS.] [HEX.] [HEX.] [HEX.] [HEX.] [HEX.]
RADIX [HEX.] [HEX.] [HEX.] [HEX.] [HEX.] [HEX.] [HEX.] [HEX.]
[Ln] +-----+-----+-----+-----+-----+-----+-----+-----+
0000  0003      11      1
0001  0004      FB      5
0002  0005      C3      5
0003  0006      40      1
0004  0007      00      1
0005  0040      00      5
-----+-----+-----+-----+-----+-----+-----+-----+
0006  0041      01      5
0007  0042      80      1
0008  0043      10      1
0009  0044      02      5
0010  1080      08      0
0011  0045      03      5
0012  0046      04      5
0013  0047      05      5
0014  0048      06      5
0015  0049      12      1
0016  004A      07      5

```

↑scroll 01-APR-86 17:15

Figure 4-3 Measured Data Display Example

4.4.1 Measured Data Display

Figure 4-4 shows an example in which the data captured with the QUEUE sample mode is displayed in mnemonic. This data is the same data as given in Figure 4-3.

The part of ".." in the DATA displayed in mnemonic is defined as a part of the instruction code. In this case, the data for the ".." section is contained in the mnemonic (or operand) which is immediately above that ".." section. "." represents one hexadecimal digit data.

TR47241
PERSONALITY KIT
INSTRUCTION MANUAL

4.4 DISPLAY OF CAPTURED DATA IN STATE ANALYZER (DISPLAY)

```

** DISPLAY **   from ACQ_MEM                               Z80          <TRACE STATE>
GROUP [ADRS ] [DATA ] [STATUS] [HEX ] [HEX ] [HEX ]
RADIX [HEX ] [MNEV ] with [S-by-S] [CODE ] [HEX ] [HEX ] [HEX ]
-----+-----+-----+-----+-----+-----+-----
[LN] 0000 0003      11/mem_rd      MEM_RD
      0001 0004      EI              OP
      0002 0005      JP  0040       OP
      0003 0006      ..             MEM_RD
      0004 0007      ..             MEM_RD
      0005 0040      NOP            OP
-----+-----+-----+-----+-----+-----+-----
      0006 0041      LD  BC,1080    OP
      0007 0042      ..             MEM_RD
      0008 0043      ..             MEM_RD
      0009 0044      LD  (BC),A     OP
      0010 1080      08/mem_wr     MEM_WR
      0011 0045      INC  BC        OP
      0012 0046      INC  B          OP
      0013 0047      DEC  B          OP
      0014 0048      LD  B,12       OP
      0015 0049      ..             MEM_RD
      0016 004A      RLCA          OP

```

↑scroll 01-APR-86 17:16

Figure 4-4 S-by-S Display Example for Measured Data

The method for properly displaying the data which is captured by the analyzer is called the S-by-S (State-by-State) display mode. A mode excluding useless ".." sections in analysis operation from the above mode is called the PACKED display mode. Figure 4-4 shows the former display example, and Figure 4-5 shows the PACKED display by using the same data to be used in Figure 4-4.

```

** DISPLAY **   from ACQ_MEM                               Z80          <TRACE STATE>
GROUP [ADRS ] [DATA ] [STATUS] [HEX ] [HEX ] [HEX ]
RADIX [HEX ] [MNEV ] with [PACKED] [CODE ] [HEX ] [HEX ] [HEX ]
-----+-----+-----+-----+-----+-----+-----
[LN] 0000 0003      11/mem_rd      MEM_RD
      0001 0004      EI              OP
      0002 0005      JP  0040       OP
      0005 0040      NOP            OP
-----+-----+-----+-----+-----+-----+-----
      0006 0041      LD  BC,1080    OP
      0009 0044      LD  (BC),A     OP
      0010 1080      08/mem_wr     MEM_WR
      0011 0045      INC  BC        OP
      0012 0046      INC  B          OP
      0013 0047      DEC  B          OP
      0014 0048      LD  B,12       OP
      0016 004A      RLCA          OP
      0017 004B      ADD  HL,BC     OP
      0018 004C      LD  A,(BC)    OP
      0019 1281      19/mem_rd     MEM_RD
      0020 004D      DEC  BC        OP
      0021 004E      INC  C          OP

```

↑scroll 01-APR-86 17:17

Figure 4-5 PACKED Display Example for Measured Data

TR47241
PERSONALITY KIT
INSTRUCTION MANUAL

4.4 DISPLAY OF CAPTURED DATA IN STATE ANALYZER (DISPLAY)

4.4.2 Z80 Disassembling Format

- (1) The mnemonic for the opcodes using ZILOG's Z80 standard assembly formats.
- (2) All the numerics used in operands are displayed in hexadecimal numbers. Accordingly, no codes for indicating the numeric base are used.
- (3) The absolute address is produced and displayed in the relative addressing mode (JR, DJNZ).
- (4) When GROUP [ADRS] is displayed by SYMBOL, its address as an operand is displayed by SYMBOL as much as possible.
The display formats are:
SYMBOL name + hhhh (h stands for one hexadecimal digit)
SYMBOL name - hhhh
- (5) "/illegal" is displayed when any illegal or noninstallation instruction is detected.

MEMO



A large, empty rectangular area with rounded corners, enclosed by a dashed border, intended for writing the memo content.

TR47241
PERSONALITY KIT
INSTRUCTION MANUAL

5.1 MICROPROCESSOR PROBE TEST

5. OPERATION CHECK

5.1 MICROPROCESSOR PROBE TEST

Since the Personality Kit uses connectors with many pins and cables for measurement, trouble such as imperfect contact occurs due to incorrect operation. A simple test is therefore designed to check the signal system operation. Perform the following procedures to check operation:

- (1) Mount the supplemented Z80 probe test adapter on the PROBE TEST connector in the TR4725 rear panel.
- (2) When a DIP plug cable is used, directly connect the microprocessor probe to the probe test adapter via a 40-pin DIP IC package. (Refer to Figure 5-1.)

TR47241
PERSONALITY KIT
INSTRUCTION MANUAL

5.1 MICROPROCESSOR PROBE TEST

TR4725 rear panel connector

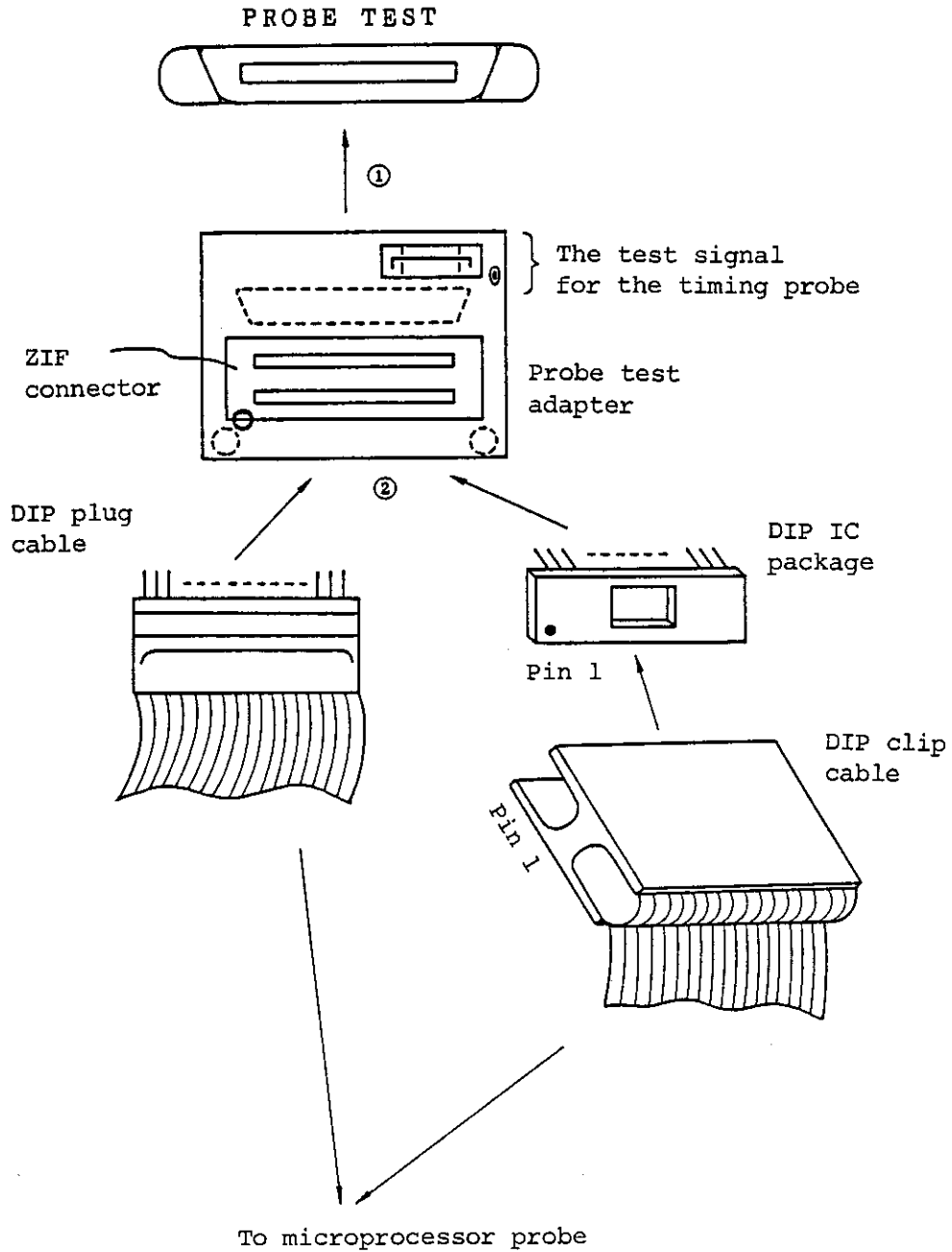

Figure 5-1 Probe Test Connection

TR47241
PERSONALITY KIT
INSTRUCTION MANUAL

5.1 MICROPROCESSOR PROBE TEST

- (3) Set to the TRACE menu screen. Next, press ^{DEFAULT} .
- (4) Press ^{RM} to start checking.
- (5) Check if the display is the same as Figure 5-2; if it is, the operation is normal.

```

** DISPLAY **      from ACQ_MEM                280                <TRACE STATE>
GROUP  [ADRS ] [DATA ] [STATUS] [HEX ] [HEX ] [HEX ] [HEX ] [HEX ]
RADIX  [HEX ] [HEX ] [HEX ] [HEX ] [HEX ] [HEX ] [HEX ] [HEX ]
-----+-----+-----+-----+-----+-----+-----+-----+-----
[LN]  +-----+-----+-----+-----+-----+-----+-----+-----
0000  0000    00      1
0001  1111    11      1
0002  2222    22      1
0003  3333    33      1
0004  4444    44      0
0005  5555    55      0
0006  6666    66      0
0007  7777    77      0
0008  0000    00      1
0009  1111    11      1
0010  2222    22      1
0011  3333    33      1
0012  4444    44      0
0013  5555    55      0
0014  6666    66      0
0015  7777    77      0
0016  0000    00      1

```

↑scroll 01-APR-86 09:00

Figure 5-2 Microprocessor Probe Test Result

TR47241
PERSONALITY KIT
INSTRUCTION MANUAL

5.2 DATA ACQUISITION PROBE E/F TEST

5.2 DATA ACQUISITION PROBE E/F TEST

The signal (500 kHz, TTL level pulse) testing the probe E/F outputs on the probe test adapter as shown in Figure 5-1. Perform the following procedures for testing:

- (1) Connect the probe test adapter to the PROBE TEST connector on the TR4725 rear panel.
- (2) Connect all the parts of the probe E/F input channel that needs to be tested to the test signal terminal via probe hooks.
- (3) Set the measuring mode to TRACE TIMING on the TRACE menu screen and then set the clock rate to 100 ns after pressing .
- (4) Press to start testing.
- (5) Check if the operation is normal by confirming that the display is the same as Figure 5-3. When error occurs with the measured data, contact your nearest ADVANTEST representative.

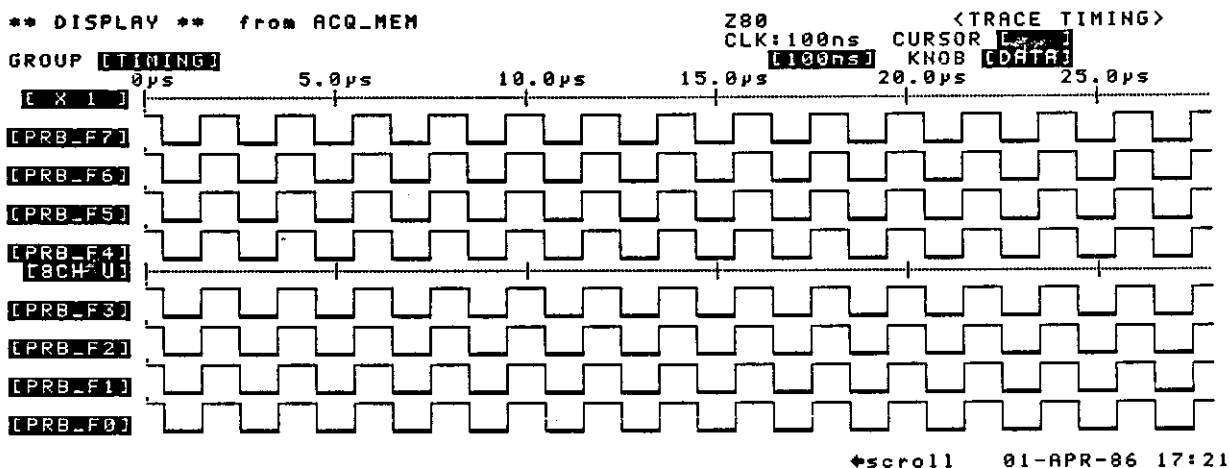

Figure 5-3 Probe E/F Test Result

TR47241
PERSONALITY KIT
INSTRUCTION MANUAL

6.1 STORAGE

6. EQUIPMENT STORAGE AND TRANSPORTATION PRECAUTIONS

6.1 STORAGE

The storage environment condition for the TR47241 Personality Kit is -10°C to $+60^{\circ}\text{C}$. When the probe is not used for a long time, place the kit in the Personality Kit storage case and keep in a dry place away from direct sunlight in particular, keep the board in the supplied conductive case). Be sure to store the floppy disk in an environment conditions of $+10^{\circ}\text{C}$ to $+60^{\circ}\text{C}$ (it is recommended to store the floppy disk separately from the Personality Kit storage case).

TR47241
PERSONALITY KIT
INSTRUCTION MANUAL

6.2 TRANSPORTATION

6.2 TRANSPORTATION

Use the packaging materials of first shipping when transporting the equipment. However, when the original packaging materials cannot be found, pack the equipment as follows:

- (1) Wrap the equipment with vinyl covers.
- (2) Wrap the equipment with 50 mm thick cushioning material and then place the wrapped equipment into a carton more than 5 mm thick.
- (3) After the equipment is wrapped with the cushioning material, put in the accessories, and then more cushioning material. Close the carton box and tie the box with packing ropes.

TR47241
PERSONALITY KIT
INSTRUCTION MANUAL

7.1 TR47241 SPECIFICATIONS

7. SPECIFICATIONS

7.1 TR47241 SPECIFICATIONS

Input Specifications

Applicable Microprocessor: Z80 (2.5 MHz), Z80A (4 MHz), Z80B (6 MHz),
Z80H (8 MHz) of ZILOG Co., or their equivalents.
Microprocessor clock frequency : Depends on the system to be measured.
Input current : -200 μ A max. (low level)
20 μ A max. (high level)
Microprocessor status display : The LED on the microprocessor probe displays
the status of CLK, RESET, WAIT, NMI, INTR, and
BUSRQ/HALT.
Logical polarity : + or -
Input group : Defined by the data input channel groups
Input group name : An alphanumeric no more than 6 characters long
Input group number : 6 max. among which 3 are already defined (ADRS,
DATA, and STATUS)

Display Specifications

Display data source : Acquisition memory, reference memory, and file
Display items : 8 items max.
Input group display order: Capable of display by selecting the input group
name in random order, repeated display of the
same input group, and deletion of the specific
input group display.
Display format : State can be displayed in binary, octal,
decimal, hexadecimal, symbol, code, ASCII code,
Z80 mnemonic (data only). S-by-S or PACKED
display in mnemonic notation.
Transmission between memories : The displayed data is transmitted to the
reference memory. Data in reference memory and
acquisition memory are displayed.
Data scroll : Vertical scrolling by scroll knob. Page scroll
key enables vertical scrolling in page units.
Specific display : Trigger display for triggers. A memory
boundary is displayed between trace windows.

TR47241
PERSONALITY KIT
INSTRUCTION MANUAL

7.1 TR47241 SPECIFICATIONS

Personality Kit configuration:

Item name	Model name	Q'ty	Remarks
Personality board		1	
Microprocessor probe	TR14724-10	1	
40-pin DIP clip cable	A04724-11	1	
40-pin DIP plug cable	A04724-12	1	
Probe test adapter		1	
40-pin DIP IC package		1	
System software package	P47241-001FJ	2	
Blank disk	MF-2DD	2	
Disk storage case		1	
Miscellaneous container		1	
Personality key storage case		1	
Instruction manual	E47241	1	

* The blank disk can be purchased separately.

Model name: A09502 (one set contains ten disks.)

TR47241
PERSONALITY KIT
INSTRUCTION MANUAL

LIST OF FIGURES

LIST OF FIGURES

Figure No.	Title	Page
Figure 2-1	Personality Board Installation Method	2 - 2
Figure 2-2	Microprocessor Probe Shape and Parts Names	2 - 3
Figure 2-3	The Use of DIP Clip Cable	2 - 5
Figure 2-4	The Use of DIP Plug Cable	2 - 5
Figure 2-5	Probe E/F Shape and Parts Names (standard configuration)	2 - 6
Figure 2-6	Connecting Probe E/F and the TR47241 Main Unit	2 - 7
Figure 2-7	Connecting SUT with Optional Accessories	2 - 9
Figure 2-8	Screen Display for Loading	2 - 11
Figure 2-9	Screen Display at the End of Loading (<u>CONFIG</u> menu screen)	2 - 12
Figure 2-10	Screen Display Requesting Built-in Clock Setting	2 - 12
Figure 2-11	Screen Display Requesting System Disk Insertion	2 - 13
Figure 2-12	<u>TRACE</u> Menu Screen (<u>TRACE SPECIFICATION</u>)	2 - 14
Figure 2-13	<u>DISPLAY</u> Menu Screen	2 - 15
Figure 2-14	Sample Data for Explanation	2 - 15
Figure 2-15	<u>FD</u> Menu Screen	2 - 17
Figure 2-16	HELP (menu item) Function Display Example (1)	2 - 21
Figure 2-17	HELP (menu item) Function Display Example (2)	2 - 21
Figure 2-18	HELP (key) Function Display Example (1)	2 - 22
Figure 2-19	HELP (key) Function Display Example (2)	2 - 22
Figure 2-20	Screen Requesting System Disk Insertion by the HELP (key) Function	2 - 23
Figure 2-21	Disk Format	2 - 24
Figure 2-22	Display at the End of Disk Formatting	2 - 25
Figure 3-1	Timing Analysis Measurement Example (sampling clock: 10 ns)	3 - 2
Figure 3-2	Timing Analysis Measurement Example (sampling clock: 100 ns)	3 - 3
Figure 3-3	Label Name Definition Example	3 - 4
Figure 3-4	Label Name Usage Example	3 - 4
Figure 3-5	Trigger Pattern (<u>TRIG_T</u>) Setting Example	3 - 5
Figure 3-6	Measuring Example with Trigger Pattern Setting	3 - 6
Figure 3-7	Delay Usage Example	3 - 6
Figure 3-8	State Analysis Measuring Example	3 - 7
Figure 3-9	Measuring Example by Trigger Pattern Setting (State Analysis)	3 - 8
Figure 3-10	Repeat Function Program 1	3 - 13
Figure 3-11	Repeat Function Program 2	3 - 13
Figure 3-12	Program That Only Sets Measuring Conditions	3 - 14
Figure 3-13	Program Example -1	3 - 14
Figure 3-14	Program Example -2	3 - 15

TR47241
PERSONALITY KIT
INSTRUCTION MANUAL

LIST OF FIGURES

LIST OF FIGURES

<u>Figure No.</u>	<u>Title</u>	<u>Page</u>
Figure 4-1	<u>CONFIG</u> Menu Screen	4 - 2
Figure 4-2	Defined <u>CODE</u> Table (Z80 status)	4 - 4
Figure 4-3	Measured Data Display Example	4 - 5
Figure 4-4	S-by-S Display Example for Measured Data	4 - 6
Figure 4-5	PACKED Display Example for Measured Data	4 - 6
Figure 5-1	Probe Test Connection	5 - 2
Figure 5-2	Microprocessor Probe Test Result	5 - 3
Figure 5-3	Probe E/F Test Result	5 - 4

TR47241
PERSONALITY KIT
INSTRUCTION MANUAL

LIST OF TABLES

LIST OF TABLES

<u>Table No.</u>	<u>Title</u>	<u>Page</u>
------------------	--------------	-------------

(No table numbers are assigned in this manual.)

TR47241
PERSONALITY KIT
INSTRUCTION MANUAL

LIST OF EXAMPLES

LIST OF EXAMPLES

<u>Example No.</u>	<u>Title</u>	<u>Page</u>
--------------------	--------------	-------------

(No example numbers are assigned in this manual.)

TR47241
PERSONALITY KIT
INSTRUCTION MANUAL

ALPHABETICAL INDEX

ALPHABETICAL INDEX

[C]		[S]	
CODE table	4 - 4	S-by-S (State-by-State)	
		display mode	4 - 6
[D]		SYMDEF function	4 - 4
data acquisition probe	2 - 6	system software loading	2 - 11
DIP clip cable	2 - 5	system under test (SUT)	2 - 3
DIP IC clip	2 - 8		
DIP plug cable	2 - 5		
disassembling format	4 - 7		
[G]			
GROUP	4 - 3		
[H]			
half-tone display	2 - 16		
HELP (key) function	2 - 22		
HELP (menu item) function	2 - 20		
[I]			
input prompt	2 - 18		
inverse blink display	2 - 16		
inverse display	2 - 16		
[M]			
microprocessor probe	2 - 3		
microprocessor			
status indicator	2 - 10		
[N]			
NIBBLE mode	2 - 19		
normal blink display	2 - 16		
normal display	2 - 16		
[P]			
PACKED display mode	4 - 6		
personality board	2 - 2		
pin socket	2 - 7		
POL	4 - 3		
probe hook	2 - 8		
probe lead set	2 - 7		
probe slot	2 - 7		
PROCESSOR	4 - 3		
[R]			
reference processor socket ...	2 - 10		

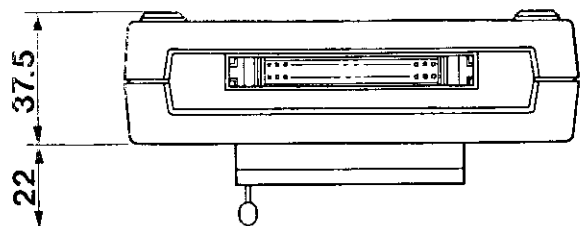

FRONT VIEW

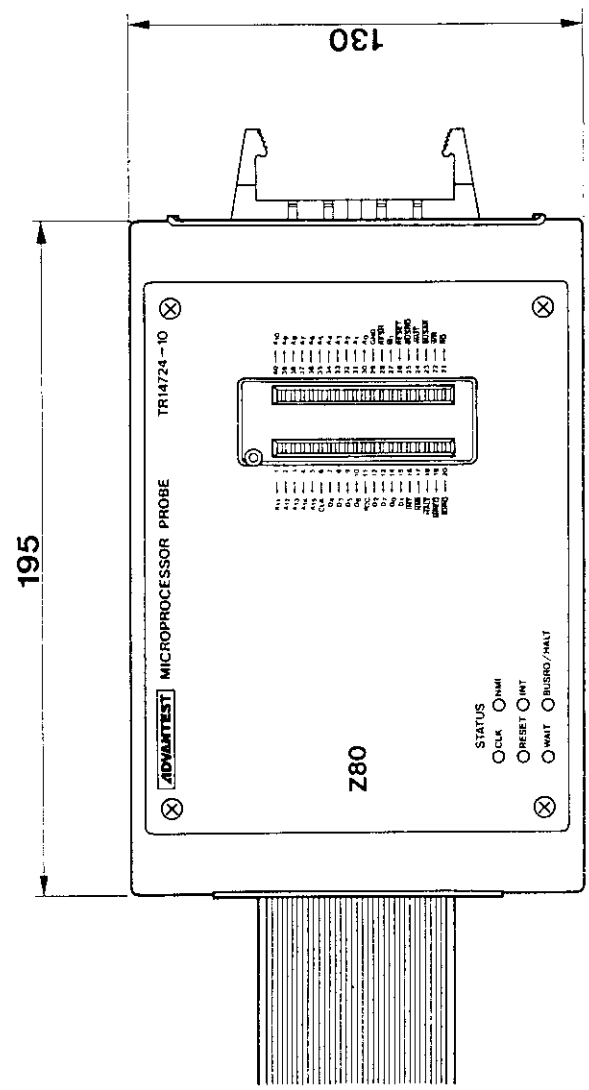

TOP VIEW

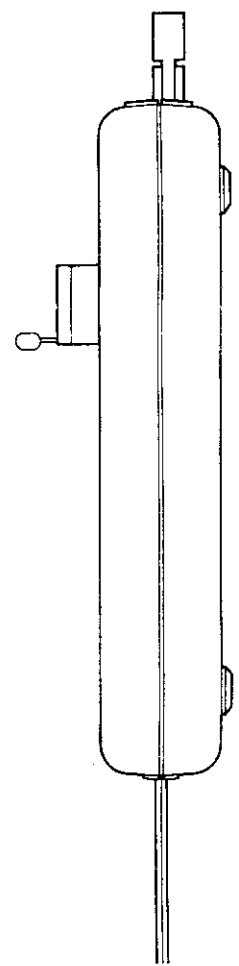

SIDE VIEW

TR14724-10
EXTERNAL VIEW

IMPORTANT INFORMATION FOR ADVANTEST SOFTWARE

PLEASE READ CAREFULLY: This is an important notice for the software defined herein. Computer programs including any additions, modifications and updates thereof, operation manuals, and related materials provided by Advantest (hereafter referred to as "SOFTWARE"), included in or used with hardware produced by Advantest (hereafter referred to as "PRODUCTS").

SOFTWARE License

All rights in and to the SOFTWARE (including, but not limited to, copyright) shall be and remain vested in Advantest. Advantest hereby grants you a license to use the SOFTWARE only on or with Advantest PRODUCTS.

Restrictions

- (1) You may not use the SOFTWARE for any purpose other than for the use of the PRODUCTS.
- (2) You may not copy, modify, or change, all or any part of, the SOFTWARE without permission from Advantest.
- (3) You may not reverse engineer, de-compile, or disassemble, all or any part of, the SOFTWARE.

Liability

Advantest shall have no liability (1) for any PRODUCT failures, which may arise out of any misuse (misuse is deemed to be use of the SOFTWARE for purposes other than its intended use) of the SOFTWARE. (2) For any dispute between you and any third party for any reason whatsoever including, but not limited to, infringement of intellectual property rights.

LIMITED WARRANTY

1. Unless otherwise specifically agreed by Seller and Purchaser in writing, Advantest will warrant to the Purchaser that during the Warranty Period this Product (other than consumables included in the Product) will be free from defects in material and workmanship and shall conform to the specifications set forth in this Operation Manual.
2. The warranty period for the Product (the "Warranty Period") will be a period of one year commencing on the delivery date of the Product.
3. If the Product is found to be defective during the Warranty Period, Advantest will, at its option and in its sole and absolute discretion, either (a) repair the defective Product or part or component thereof or (b) replace the defective Product or part or component thereof, in either case at Advantest's sole cost and expense.
4. This limited warranty will not apply to defects or damage to the Product or any part or component thereof resulting from any of the following:
 - (a) any modifications, maintenance or repairs other than modifications, maintenance or repairs (i) performed by Advantest or (ii) specifically recommended or authorized by Advantest and performed in accordance with Advantest's instructions;
 - (b) any improper or inadequate handling, carriage or storage of the Product by the Purchaser or any third party (other than Advantest or its agents);
 - (c) use of the Product under operating conditions or environments different than those specified in the Operation Manual or recommended by Advantest, including, without limitation, (i) instances where the Product has been subjected to physical stress or electrical voltage exceeding the permissible range and (ii) instances where the corrosion of electrical circuits or other deterioration was accelerated by exposure to corrosive gases or dusty environments;
 - (d) use of the Product in connection with software, interfaces, products or parts other than software, interfaces, products or parts supplied or recommended by Advantest;
 - (e) incorporation in the Product of any parts or components (i) provided by Purchaser or (ii) provided by a third party at the request or direction of Purchaser or due to specifications or designs supplied by Purchaser (including, without limitation, any degradation in performance of such parts or components);
 - (f) Advantest's incorporation or use of any specifications or designs supplied by Purchaser;
 - (g) the occurrence of an event of force majeure, including, without limitation, fire, explosion, geological change, storm, flood, earthquake, tidal wave, lightning or act of war; or
 - (h) any negligent act or omission of the Purchaser or any third party other than Advantest.
5. **EXCEPT TO THE EXTENT EXPRESSLY PROVIDED HEREIN, ADVANTEST HEREBY EXPRESSLY DISCLAIMS, AND THE PURCHASER HEREBY WAIVES, ALL WARRANTIES, WHETHER EXPRESS OR IMPLIED, STATUTORY OR OTHERWISE, INCLUDING, WITHOUT LIMITATION, (A) ANY WARRANTY OF MERCHANTABILITY OR FITNESS FOR A PARTICULAR PURPOSE AND (B) ANY WARRANTY OR REPRESENTATION AS TO THE VALIDITY, SCOPE, EFFECTIVENESS OR USEFULNESS OF ANY TECHNOLOGY OR ANY INVENTION.**
6. **THE REMEDY SET FORTH HEREIN SHALL BE THE SOLE AND EXCLUSIVE REMEDY OF THE PURCHASER FOR BREACH OF WARRANTY WITH RESPECT TO THE PRODUCT.**
7. **ADVANTEST WILL NOT HAVE ANY LIABILITY TO THE PURCHASER FOR ANY INDIRECT, INCIDENTAL, SPECIAL, CONSEQUENTIAL OR PUNITIVE DAMAGES, INCLUDING, WITHOUT LIMITATION, LOSS OF ANTICIPATED PROFITS OR REVENUES, IN ANY AND ALL CIRCUMSTANCES, EVEN IF ADVANTEST HAS BEEN ADVISED OF THE POSSIBILITY OF SUCH DAMAGES AND WHETHER ARISING OUT OF BREACH OF CONTRACT, WARRANTY, TORT (INCLUDING, WITHOUT LIMITATION, NEGLIGENCE), STRICT LIABILITY, INDEMNITY, CONTRIBUTION OR OTHERWISE. TORT (INCLUDING, WITHOUT LIMITATION, NEGLIGENCE), STRICT LIABILITY, INDEMNITY, CONTRIBUTION OR OTHERWISE.**
8. **OTHER THAN THE REMEDY FOR THE BREACH OF WARRANTY SET FORTH HEREIN, ADVANTEST SHALL NOT BE LIABLE FOR, AND HEREBY DISCLAIMS TO THE FULLEST EXTENT PERMITTED BY LAW ANY LIABILITY FOR, DAMAGES FOR PRODUCT FAILURE OR DEFECT, WHETHER ARISING OUT OF BREACH OF CONTRACT, TORT (INCLUDING, WITHOUT LIMITATION, NEGLIGENCE), STRICT LIABILITY, INDEMNITY, CONTRIBUTION OR OTHERWISE.**

CUSTOMER SERVICE DESCRIPTION

In order to maintain safe and trouble-free operation of the Product and to prevent the incurrence of unnecessary costs and expenses, Advantest recommends a regular preventive maintenance program under its maintenance agreement.

Advantest's maintenance agreement provides the Purchaser on-site and off-site maintenance, parts, maintenance machinery, regular inspections, and telephone support and will last a maximum of ten years from the date the delivery of the Product. For specific details of the services provided under the maintenance agreement, please contact the nearest Advantest office listed at the end of this Operation Manual or Advantest's sales representatives.

Some of the components and parts of this Product have a limited operating life (such as, electrical and mechanical parts, fan motors, unit power supply, etc.). Accordingly, these components and parts will have to be replaced on a periodic basis. If the operating life of a component or part has expired and such component or part has not been replaced, there is a possibility that the Product will not perform properly. Additionally, if the operating life of a component or part has expired and continued use of such component or part damages the Product, the Product may not be repairable. Please contact the nearest Advantest office listed at the end of this Operation Manual or Advantest's sales representatives to determine the operating life of a specific component or part, as the operating life may vary depending on various factors such as operating condition and usage environment.

SALES & SUPPORT OFFICES

Advantest Korea Co., Ltd.

22BF, Kyobo KangNam Tower,
1303-22, Seocho-Dong, Seocho-Ku, Seoul #137-070, Korea
Phone: +82-2-532-7071
Fax: +82-2-532-7132

Advantest (Suzhou) Co., Ltd.

Shanghai Branch Office:
Bldg. 6D, NO.1188 Gumei Road, Shanghai, China 201102 P.R.C.
Phone: +86-21-6485-2725
Fax: +86-21-6485-2726

Shanghai Branch Office:
406/F, Ying Building, Quantum Plaza, No. 23 Zhi Chun Road,
Hai Dian District, Beijing,
China 100083
Phone: +86-10-8235-3377
Fax: +86-10-8235-6717

Advantest (Singapore) Pte. Ltd.

438A Alexandra Road, #08-03/06
Alexandra Technopark Singapore 119967
Phone: +65-6274-3100
Fax: +65-6274-4055

Advantest America, Inc.

3201 Scott Boulevard, Suite, Santa Clara, CA 95054, U.S.A
Phone: +1-408-988-7700
Fax: +1-408-987-0691

ROHDE & SCHWARZ Europe GmbH

Mühldorfstraße 15 D-81671 München, Germany
(P.O.B. 80 14 60 D-81614 München, Germany)
Phone: +49-89-4129-13711
Fax: +49-89-4129-13723

ADVANTEST®

<http://www.advantest.co.jp>